

UC-NRLF

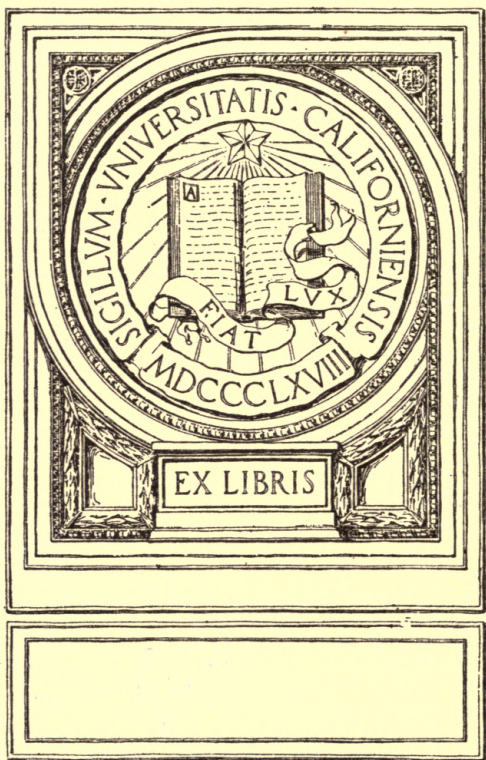

⌘B 272 355



inv 001
x
inv

AUTOGENOUS
WELDING AND CUTTING

McGraw-Hill Book Company

Publishers of Books for

Electrical World	The Engineering and Mining Journal
Engineering Record	Engineering News
Railway Age Gazette	American Machinist
Signal Engineer	American Engineer
Electric Railway Journal	Coal Age
Metallurgical and Chemical Engineering	Power

AUTOGENOUS WELDING AND CUTTING

BY
THEODORE KAUTNY, ING.
NÜRNBERG

TRANSLATED BY THE AUTHOR

AND

JAMES F. WHITEFORD
MEMBER AM. SOC. MECH. ENGRS.

FIRST EDITION

UNIVERSITY OF
CALIFORNIA

McGRAW-HILL BOOK COMPANY, INC.

239 WEST 39TH STREET, NEW YORK

6 BOUVERIE STREET, LONDON, E.C.

1915

TS 227
K3

COPYRIGHT, 1915, BY THE
MCGRAW-HILL BOOK COMPANY, INC.

THE MCGRAW-HILL
BOOK COMPANY

AUTHOR'S PREFACE

THE literature of autogenous welding technique has been enriched lately in many valuable ways, and there exist a large number of works which cover this field.

Autogenous welding is a process intended for general introduction both in small workshops and in large factories. The range of welding technique is so wide that a thorough study of the process requires extensive research which makes great demands on the time of the reader.

A pocket book of brief compass will be welcome to the works engineer, to the works foreman, and to the practical autogenous welder; in which the most important elements of the process are placed together in an easily available manner, and which shall be a faithful companion and a reliable adviser in connection with the various questions arising in practice.

The object of the present work is to meet these requirements and I pass it on to the general public in the hope that it will be favorably received and fulfil its task.

THEO. KAUTNY

NÜRNBERG, April, 1914.

331179

COLLABORATOR'S PREFACE

THE rapid extension of the application of autogenous welding by means of the oxyacetylene flame, which followed closely upon the perfecting of apparatus for the commercial production of oxygen and acetylene, has by no means exhausted the field for this process of metal working.

New developments are being continually recorded and it would be exceedingly difficult to establish any definite limits in the application of the process.

As the development of the art of autogenous welding is being advanced in other countries simultaneously with those of English speaking people it is important for provision to be made so that students and others interested in the subject may become familiar with the methods and practices in use elsewhere.

In Germany, the industrial applications of the process are of such importance and the value of detailed knowledge is so fully appreciated, that autogenous welding schools are now conducted in conjunction with the Technical High Schools in various centers.

As the author has been closely associated with the establishment of these schools the text in the following pages is of particular importance.

Effort has been made to avoid the use of such technical terms as may confuse the individual welder, and to give such information and instruction as will enable him to more thoroughly understand and appre-

ciate the art which engages his attention, since the success of the application of the process depends so largely upon the correct knowledge and skill of the individual.

JAMES F. WHITEFORD

LONDON, July, 1914.

CONTENTS

	PAGE
AUTHOR'S PREFACE.....	v
COLLABORATOR'S PREFACE.....	vii

CHAPTER I

AUTOGENOUS WELDING FLAMES

Welding applications.....	1
Combustible gases.....	2
Hydrogen.....	2
Blau gas.....	4
Illuminating gas.....	4
Benzol vapors.....	4
Acetylene.....	5

CHAPTER II

ACETYLENE MANUFACTURE AND APPARATUS

Calcium carbide.....	7
Properties of calcium carbide.....	7
Commercial sizes of grains.....	7
Method of storage.....	8
Classification of generators.....	8
Carbide to water generators.....	10
Overheated acetylene and its effect on welds.....	11
Gasifying dust carbide.....	14
Water to carbide generators.....	16
Automatic water displacement generators.....	17
Use of "Beagid".....	18
Dissolved acetylene.....	19
Purification of acetylene.....	19
Chemical purifiers.....	20
Mechanical purifiers.....	21

CHAPTER III

OXYGEN MANUFACTURE AND APPARATUS

	PAGE
Purchase of oxygen in steel bottles	23
Method and apparatus for testing oxygen	24
Liquid air process of manufacture of oxygen	24
Electrolytic process of manufacture of oxygen	25
Chemical process of manufacture of oxygen	26
Operation of oxygen bottles	26
Pressure reducing valves for oxygen bottles	28

CHAPTER IV

GAS MAINS AND FITTINGS

Piping of acetylene in a welding shop	31
Pressure of acetylene in the welding shop	31
Danger of back firing	31
Safety devices	32
Selection and operation of connection hose	33

CHAPTER V

AUTOGENOUS WELDING BURNERS

Equal pressure burners	35
Injector burners	36
Adjustable burners	36
Burners with interchangeable tips	37
Flame adjustment	37
Detail of burner construction	39
Gas consumption of burners	42

CHAPTER VI

AUTOGENOUS CUTTING BURNERS

Classification of cutting burners	44
Principle of cutting with oxygen	44
Guiding devices for cutting burners	45
Industrial applications of autogenous cutting	47
Data on cutting with oxygen and acetylene	48
Data on cutting with oxygen and hydrogen	48
Effect of variation in the purity of oxygen	49

CHAPTER VII

AUTOGENOUS WELDING OF IRON

	PAGE
Properties of iron	50
Carbon in molten iron	50
Influence of an excessive quantity of carbon	54
Pearlite or cementite	56
Welding of cast iron	58
Special filling material required for cast iron welds	59
Preparation and execution of the weld	60
Necessity for use of flux in welding cast iron	60
Welding of cast steel	61
Welding of hard steel	61
Welding of wrought iron	62
Conditions producing martinsite	62

CHAPTER VIII

REPAIRS OF GREY CAST IRON

Formation of white iron	63
Presence of tensions in castings	63
Benefits derived from preheating	64
Expansion of cast iron during welding operation	64
Method of repairing large or complex castings	66

CHAPTER IX

WELDING OF SHEET IRON

Welding methods vary for sheets of different thickness	68
Flanging of sheets for welding operation	69
Method of welding very thin sheets	70
Position of the welding burner	70
Failures of welds	71
Existence of oxides and their influence on welds	72
Magnetic properties of iron	74
Value of reheating the welded portion	75
Puddling process to supplement the use of the welding burner	76
Simultaneous use of two welding flames	77
Vertical and overhead welding	78

CHAPTER X

MANUFACTURE AND REPAIRS OF BOILERS

	PAGE
Properties of mild steel boiler sheets.....	80
Causes of failures of boiler sheets.....	80
Influence of autogénous welding on boiler construction.....	81
Method of welding up cracks.....	82
Application of patches.....	83
Employment of the puddling process.....	84
Repairs of corroded tubes.....	85

CHAPTER XI

MANUFACTURE OF CYLINDRICAL VESSELS

Devices for use in welding cylindrical sections.....	86
Welding of horizontal seams.....	87
Welding of circumferential seams.....	88
Method of executing welds on heavy sheets.....	89
Joining sheets of different cross section.....	91
Application of joint rings.....	91
Problems involved in manufacture of closed cylindrical vessels	93
Application of heads.....	94
Method employed for annular welding.....	95
Method for applying intermediate heads.....	98

CHAPTER XII

MANUFACTURE OF RECTANGULAR VESSELS AND
MISCELLANEOUS ARTICLES

Problems involved in manufacture of rectangular vessels.....	99
Position of welding burner.....	99
Location of the welding seams.....	99
Manufacture of safes.....	100
Superheaters and radiators.....	100
Automobile and aeronautical motors.....	101
Double shell vessels.....	103
Open sheet metal vessels.....	104
Cooking utensils.....	105
Structural iron work.....	105

CHAPTER XIII

MANUFACTURE AND INSTALLATION OF LARGE
PIPES AND CONDUITS

	PAGE
Application of tee connections	107
Manufacture of large elbows	108
Method of applying connection flanges	109
Use of welded pipe in ship building	110
Method of overcoming expansions difficulties	111

CHAPTER XIV

MANUFACTURE AND INSTALLATION OF GAS
AND WATER PIPE

History of development in pipe manufacture	112
Difficulties encountered in the earlier methods	113
Adoption of the autogenous welding process	113
Difficulties experienced in welding pipe	114
Description of autogenous pipe-welding machines	115
Benefit derived from preheating	116
Securing reliability of flame for welding	117
Installation of pipes by welding	118
Advantages offered by autogenous welding method	119
Education of the welders	119

CHAPTER XV

CONSTRUCTION OF PIPE-SHAPED APPARATUS

Heat exchange apparatus	121
Ammonia machines	121
Bicycle tubing	123
Aëroplane frames	124
Metal furniture	125
Tapered tubing	126

CHAPTER XVI

WELDING OF COPPER

Properties of copper and their influence on welding	127
Nature and use of welding powders	128
Adjustment and operation of the welding flame	129

	PAGE
Description of various methods of welding copper	13
Execution of the puddling process	13

CHAPTER XVII

WELDING OF ALUMINIUM

Properties of aluminium which influence autogenous welding	13
Existence and influence of the oxide in welding	13
Methods of destroying the oxide	13
Nature and use of welding powders	13
Schoop patent process of welding aluminium	13
Welding of sheet aluminium	13

CHAPTER XVIII

WELDING OF NICKEL AND OTHER METALS

Properties of nickel which influence autogenous welding	13
Use of a heated anvil	13
Hammering process	13
Autogenous repairs of nickel	13
General rules for welding nickel	13
Autogenous welding of silver	13
Autogenous welding of gold	13
Autogenous welding of lead	13
Welding together of different metals	13

CHAPTER XIX

CONCLUSION

Trend of development in autogenous welding	13
Influence of technical refinements	13
Importance and possibilities of the puddling process	13
INDEX	13

AUTOGENOUS WELDING AND CUTTING

CHAPTER I

AUTOGENOUS WELDING FLAMES

AUTOGENOUS welding is a process by which, through the use of a hot blow pipe flame, the edges of metal parts, placed against each other, are heated to their melting point so they will flow into one another. After the welding and cooling the parts form one body of almost the same physical properties.

The applications of the process in industry are both numerous and varied and its already wide field of practical uses is being rapidly extended. It is used to replace the seaming, rivetting and hard soldering of metal sheets and for the installation of permanent plumbing fixtures and gas and water pipe.

In the manufacture, from strips of sheet metal, of piping and tubing of various kinds and dimensions, which are used for gas, water and steam conduits and also for the construction of different parts of bicycles, automobiles and aeroplanes.

The process is also used in the building trades, for making numerous parts out of rolled metal, as metal door and window frames, for the reinforcing of concrete, and for decorative metal work.

In the construction of internal combustion motors, to make various fittings and connections as well as for manufacturing the jacket of water-cooled cylinders.

In the shipbuilding industry, for the construction and erection of pipes, as well as for boiler repairs.

In the machine shop and foundry, to repair worn and defective castings of all kinds.

It is also extensively used to replace hard soldering in the finer metals and to manufacture metal furniture and sundry household articles of copper, aluminium and nickel.

Combustible Gases. — For autogenous welding various combustible gases are used in conjunction with oxygen, to secure a flame of sufficient temperature to fuse metallic parts.

These gases are hydrogen, Blau or liquid gas, illuminating gas, benzine or benzol vapors, and acetylene.

Hydrogen. — Hydrogen gas is a chemical element which exists in nature, in great quantities, in various chemical combinations. Of these, the most common is water, its combination with oxygen (H_2O), and as a consequence water is used as a basis for the manufacture of hydrogen.

Inasmuch as the separation of water into its elements means the destruction of a chemical combination, considerable mechanical power is required.

Just as the separation of the chemical parts of water requires a considerable amount of power, so the combination of these elements — which takes place in the burning of such mixture known as oxy-hydrogen gas — develops a considerable amount of heat. Therefore the flame caused by the burning of oxy-hydrogen gas can be used for autogenous welding.

The burning of a molecular equivalent mixture of oxygen and hydrogen results in the forming of water. Water, however, when superheated at a high temperature, as under the influence of a blow pipe flame, dissociates again into its elements.

In using this flame for autogenous welding the danger exists that, during the formation of oxygen and hydro-

gen within the flame, the oxygen will unite with the metal, i.e. the metal will burn, or, what corresponds to a lower degree of burning, the metal will become overheated.

The temperature of a hydrogen-oxygen flame can never go higher than the dissociation temperature of water which is estimated at 2000°C . (3632°F).

To prevent the burning or overheating of metals in welding with hydrogen-oxygen, it becomes necessary to use a supercharge of hydrogen; in order that the oxygen liberated within the flame combines again with the free hydrogen, and thus making it harmless for the iron. This practice, however, increases the size and decreases the temperature, of the flame.

Hydrogen is handled commercially in steel cylinders under a pressure of 150 atmospheres.

A hydrogen-oxygen welding outfit consists of 2 steel cylinders; one containing compressed hydrogen and the other compressed oxygen. Each cylinder is supplied with a pressure reducing valve connected with the welding burner by means of flexible tubes.

In the operation of a hydrogen-oxygen welding apparatus, if the burner is brought too near to the metal, a black spot can be observed in the middle of the glowing metal. This is due to the metal being cooled by the unburnt gas mixture and such a condition must be avoided.

For the welding of thin metal sheets, the use of oxy-hydrogen is practical, although the quality of the welding seam decreases as the thickness of the metal increases.

Oxy-hydrogen welding was the first autogenous welding system employed and was used extensively until the more advantageous system of welding with acetylene was introduced, which latter system has now

almost entirely replaced the welding with the oxygen-hydrogen flame.

Blau or Liquid Gas. — Blau¹ or liquid gas is manufactured by vaporizing liquid hydrocarbons in closed retorts and superheating the vapors. This is not a chemical combination but a mechanical mixture of various gases and vapors.

When this gas is used for welding, the free hydrogen contained in the products of combustion is absorbed by the iron. In working heavier sheets, necessitating a prolonged use of the flame, an extensive absorption of the hydrogen by the metal occurs. As the metal solidifies, the absorbed hydrogen is expelled producing a porous welding seam.

For the welding of certain metals, as aluminium, and for welding thin metal sheets, the employment of Blau gas is practical, but such operation is very expensive on account of the high cost of compressing and transporting the gas.

Illuminating Gas. — Illuminating gas (coal gas and water gas) can only be used for welding very thin metal sheets, owing to the low temperature of the flame. On account of the great loss of heat caused by the absorbing and conductive qualities of the metal, it is impossible, with a flame of low temperature, to heat thick metal sheets locally to the melting point.

Benzine or Benzol Vapors. — In autogenous welding, the vapors of liquid hydrocarbons have the same properties as Blau or liquid gas. The temperature of a Benzol welding flame at about 2700° C. (5000° F.) is higher than the illuminating gas welding flame, but is considerably lower than that of the oxygen-acetylene flame.

¹ This gas derives its name from that of the inventor, a chemist, Blau of Augsburg, Germany.

Numerous tests have proved that Benzol welding is less advantageous from an economical and qualitative standpoint than the oxy-acetylene or the oxy-hydrogen welding, but the process may be used to advantage for many purposes, especially for the welding of light pieces. Further, the apparatus used for such welding is capable of being moved easily from place to place.

Acetylene. — The use of acetylene in autogenous welding has rapidly extended since its first introduction. This is due to the peculiar conditions resulting from the burning of acetylene in a stream of oxygen.

Acetylene is a chemical combination of carbon and hydrogen (C_2H_2) and the burning, i.e. its combination with oxygen, takes place in two phases, with a well defined zone formed of the first phase.

This zone consists of the products of combustion of the first phase, i.e. carbon monoxide and hydrogen, which products combine with the oxygen of the air, in an exterior envelope of the flame, to the final products of combustion, i.e. carbonic acid and water.

In autogenous welding this zone within the flame is active while the outer envelope serves to protect the metal against oxidation. The formula of the chemical changes is as follows:—

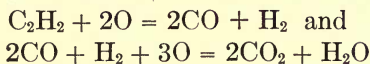

Acetylene consists of a chemical combination of 2 atoms of carbon and 2 atoms of hydrogen (C_2H_2). Inasmuch as the carbon is two-atomic, the acetylene forms a non-saturated compound and there exists therefore, in the acetylene molecule, a certain interior tension.

This causes the gas to form other combinations

belonging to the acetylene group at the comparatively low temperature of 480° C. (896° F.) which phenomena is called Polymerisation. Such higher combinations of the acetylene are Benzin, Benzol, Styrolin, Naphthalin, etc.

Benzol, like the balance of these combinations, has physical properties different from acetylene and this is the reason why Benzol vapors used in place of acetylene do not give the expected results in autogenous welding.

Furthermore, such polymeres of acetylene are liable to condense part of their carbon in the form of tar-products under circumstances existing in an acetylene generator.

CHAPTER II

ACETYLENE MANUFACTURE AND APPARATUS

THE basis for manufacturing acetylene is calcium carbide, which is produced by melting together lime and coke in an electric furnace.

Calcium Carbide.— Calcium carbide is a crystalline substance usually of grey color and is immune against

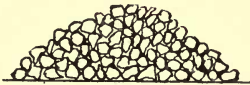

FIG. 1.—Granulated carbide grains Nos. 1 to 3. ($\frac{1}{2}$ size.)



FIG. 2.—Granulated carbide grains Nos. 4 to 7. ($\frac{1}{2}$ size.)

the action of most acids. It combines in all its forms with water forming hydrate of lime and acetylene gas and must therefore be protected against all dampness.

For commercial use it is packed in tin drums of 50 or 100 lbs. each and can be purchased in the following granulations:— $\frac{1}{8}$ " , $\frac{1}{4}$ " , $\frac{3}{8}$ " , $\frac{1}{2}$ " , 1" and 2" (Figs. 1, 2, 3).



FIG. 3.—Granulated carbide grains Nos. 8 to 15. ($\frac{1}{2}$ size.)

All sizes up to $\frac{1}{2}$ " are known as granulated carbide; larger sizes as lump carbide.

The various apparatus for the manufacture of acety-

lene are constructed for certain sizes of carbide grains and the correct size must be used, as otherwise the operation of the machine will be irregular and under certain conditions too much gas will be developed which may become dangerous.

Carbide packed in metal drums may be safely kept in the same room as the generator but the carbide must be kept absolutely dry (Fig. 4). These drums are often damaged in handling, and if water in any form reaches the carbide, acetylene is generated and great danger of explosion arises. It is therefore advisable to store carbide cans on wooden supports (Fig. 5).

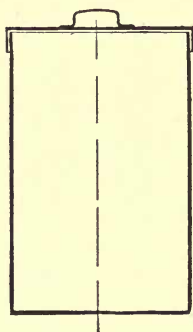

FIG. 4.— Cross section of carbide drum fitted with socket lid.

cause a spark by contact with the drum which would ignite any acetylene that might exist within.

Generators.— For regular welding work in factories, stationary acetylene generators should be given the preference and these should be made according to the existing local regulations.

Portable outfits may be used to advantage in the interior of the factories but stationary plants have been found to be more economical as the production of the gas is more easily regulated and overheating can be more easily avoided.

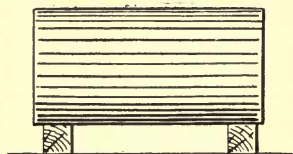

FIG. 5.— Carbide storage drum supported by wooden blocks for protection against water.

During the transformation of the water and carbide, a considerable amount of heat is liberated which has been calculated at 220 British Thermal units for each pound of carbide gasified.

With $4\frac{1}{2}$ pounds of water and 1 pound of carbide the temperature of the water will be raised to the boiling point and steam will be formed which will reduce the active amount of water in the generator. It follows therefore that the quantity of water in the generator must be greater than $4\frac{1}{2}$ pounds for each pound of carbide and this must be given consideration in designing generators.

Acetylene generators may be divided into two classes, viz: —

1. Generators in which small quantities of carbide are introduced, by hand or mechanical arrangement, into a surplus of water. (Figs. 6, 7, 8, 9, 10, 11, 12.)

2. Generators in which a quantity of water flows into a chamber partially filled with carbide, the quantity of water being regulated by mechanical action. (Figs. 13, 14, 15.)

Generators of both types are in use which give satisfactory results, but there are also generators of each type that not only result in poor welding but which are dangerous to operate.

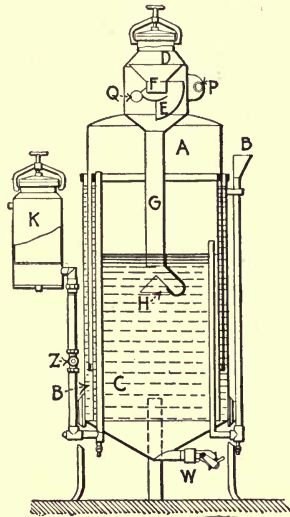

FIG. 6.—Cross section of portable automatic "carbide to water" acetylene generator.
 A. Gas chamber.
 B. Water Seal.
 C. Gas delivery pipe.
 D. Carbide holder.
 E-F. Delivery mechanism.
 G-H. Delivery chute.
 K. Purifier.
 P-Q. Delivery regulator.
 W. Cleaning pipe.
 Z. Gas valve.

Carbide to Water Generators.— The generators of the first group, carbide to water, should be so constructed that for each weight unit of carbide 10 weight units of water are available and that the latent heat in the carbide is distributed over the entire quantity of water so that a temperature of 45° C. (113° F.) is not exceeded.

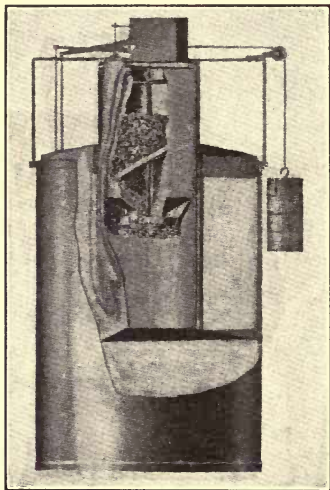

FIG. 7.— Delivery device of a high pressure "carbide to water" acetylene generator.

In order to distribute the heat over the entire quantity of water, it is necessary to provide a grate on which the carbide rests during the gasification process. In this manner the heat is absorbed by the surrounding water, which reduces its specific gravity and causes it to rise to the surface, while the cooler water along the walls of the generator flows downwards.

It is of advantage to use in cylindrical generators a grate fastened on a shaft which can be operated from without, in order to loosen the residue on the bottom of the generator. It is of the greatest importance for the welder that the apparatus is kept scrupulously clean and that a sufficient quantity of clean water is provided.

When a quantity of mud or sludge has accumulated in the generator, the fresh carbide introduced will become imbedded in the sludge and will not reach the grate. The circulation of the water will thus be impeded so that great heat will develop locally and

with the introduction of air into the generator—as happens when the apparatus is refilled—explosions are liable to occur.

In such cases the gas generated becomes overheated causing the phenomenon of polymerisation and for our purpose such gas will be designated as overheated acetylene.

Overheated Acetylene.—Overheated acetylene therefore is a gas which by means of the heat resulting from the decomposition of the carbide, is partially transformed into the vapors of liquid hydrocarbons. These vapors condense in this reacting mass, their carbon forming tar products. The overheating of the acetylene in the generator is indicated by a local yellow or brown discoloration of the lime sludge caused by the tar products.

The accumulation of sludge is a very important factor in the operation of all apparatus into which carbide is dropped. Even in such generators where the carbide is introduced within perforated drums, an accumulation of lime-sludge must be expected.

In many acetylene generators the carbide is introduced in perforated metal boxes, which are placed within other metal holders. In such apparatus the greater part of the lime-sludge will remain within these metal holders, in which case cleaning the generator at weekly, or even longer intervals, is satisfactory.

In charging, the boxes must be only half filled, as the residue of the acetylene production has a much larger volume than the original quantity of carbide. If these boxes are filled with too much carbide, the pressure produced by the increase in volume of the mass might cause them to burst.

Further, this pressure from within will compress the outer layer of the lime-sludge firmly against the walls

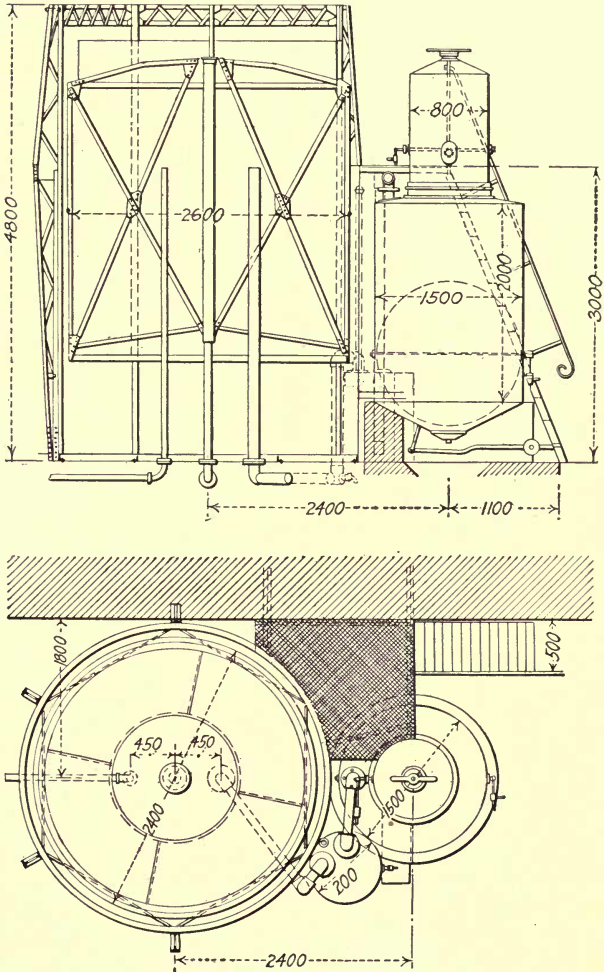

FIG. 8.— Vertical and horizontal cross sections of large stationary "carbide to water" acetylene generator. (Dimensions shown in millimetres.)

of the box preventing the access of water to the carbide, thereby causing overheating of the gas. The tar products then forming will penetrate the layer of lime-sludge and transform it into a water proof mass around the remaining carbide.

In such cases quantities of carbide will remain unused in the box and will be lost. As such unused portions of carbide are usually thrown away with the residue into drains and sewers, acetylene will form there and may cause severe explosions.

Effect of using overheated Acetylene.— The use of overheated acetylene easily causes burned welding seams. Part of the carbon of such acetylene being transformed into tar products, the remainder of the gas forms a mixture with free hydrogen and other hydrocarbon products.

In a molten state iron absorbs great quantities of hydrogen which is expelled again during the solidification of the metal, resulting in a foaming of the welding seam.

During this foaming of the welding seam the iron is divided into thin films, which fall back into the molten mass when the gas bubbles burst; and should free carbon be present in the flame it penetrates into these films and is absorbed by the iron. This results in the soft metal of the welding seam assuming the characteristics of steel and in some cases, the properties of grey

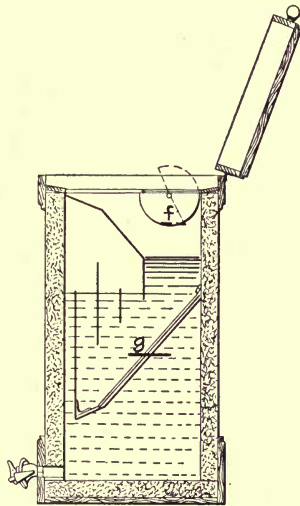

FIG. 9. — Cross section of "carbide to water" acetylene generator showing jacket for protection against frost.

cast iron. Under such circumstances the welding seam, upon cooling, becomes hard and brittle.

Another consequence of the use of overheated acetylene is the change in the relative proportions of the acetylene and the oxygen in the welding burner. As only the volume of the acetylene is dependent upon the injector pressure in the burner, while the density of the gas varies with the temperature, such a change produces an excess of oxygen in the flame; and this free oxygen enters into the molten iron and burns the welding seam.

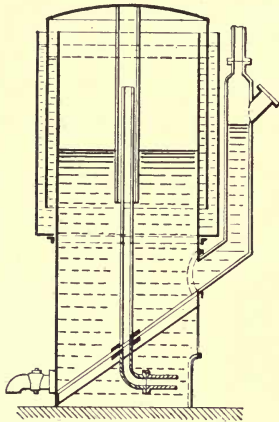

FIG. 10. — Cross section of "carbide to water" acetylene generator.

Gasifying Dust Carbide. — In acetylene generators in which so called granulated carbide is introduced, it may occur that when small granulations of carbide

are used, the heavier carbide sinks in the water while the gas bubbles adhering to the small particles carry them again to the surface. The bursting of these bubbles liberates the gas directly into the gas chamber and the remaining carbide particle sinks again and the process is repeated until the carbide is entirely decomposed.

The continued repetition of this operation produces gas which is unsuitable for welding purposes. This occurs particularly when using dust carbide and therefore this grade should not be used in carbide to water apparatus.

To gasify dust carbide specially constructed acetylene generators must be used in which the carbide is

introduced in closed boxes beneath the surface of the generator water so that it is only there that the transformation occurs.

In some acetylene generators the carbide is introduced in closed boxes, made from perforated sheet

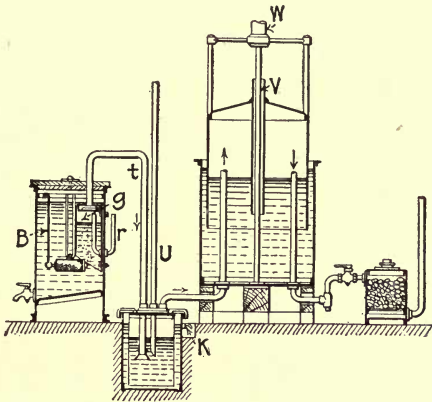

FIG. 11. — Stationary “carbide to water” acetylene generator where carbide is introduced in a closed drum —

- B. Carbide delivery.
- K. Water filter.
- T. Delivery pipe.
- G. Acetylene chamber.
- R. Pressure regulator.
- U. Escape vent.
- V-W. Gasometer.

iron, which boxes are passed through the water to allow the carbide to gasify beneath the gas collector. With such apparatus the gasometer bell must not be loaded as this might permit the pressure to increase so that the gas will break the water seal of the gasometer and escape into the generator room causing danger of explosion.

This may also occur if the resistance which the gas has to overcome in its passage from the generator to the gasholder appreciably increases. The con-

necting pipe should therefore be fitted with a waste pipe through which the accumulated water may be drained off and this should be considered in the construction of acetylene generators.

Water to Carbide Generators.— A widely used type of apparatus is one wherein the carbide is gasified in

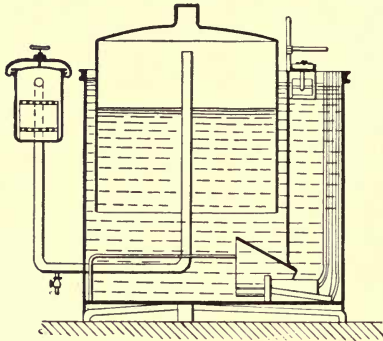

FIG. 12.— Cross section of portable "carbide to water" acetylene generator where carbide is introduced in a closed box.

special chambers, the water supply to which is regulated by the movement of the gasometer bell. A retort containing such chambers can either be arranged in the lower part of the gasometer or be provided in special generator vessels.

In the operation of apparatus of this kind, it is necessary to insure that the outlet of the carbide chambers is in proper working order before the refilling is effected and also that the chambers are thoroughly washed and dried before recharging.

If, in generators of this type, the carbide chamber is divided by a number of partitions, not more than 5 pounds of carbide should be placed in any individual section. Should a greater quantity of carbide in a single mass be periodically attacked by water, the influx of which water is stopped when the gasometer bell reaches a certain height, then the heat which will continue to be liberated may lead to spontaneous combustion upon the opening of the chamber; the atmospheric air entering and forming with the acetylene an explosive mixture.

With apparatus of this kind the gasometer bell must be sufficiently large to take up the entire quantity of gas produced by the decomposition of the carbide contained in each chamber. Should the capacity be insufficient then appreciable after-generation of acetylene would occur which surplus of gas would escape and be lost.

Another point to be observed is that the individual sections are not more than half filled as the residue occupies greater space than the original carbide and consequently stoppages can occur.

When refilling such apparatus, the carbide holders must be dry and it is advantageous to provide an extra set of containers so that while one set is in use, the other can be thoroughly cleaned and dried.

Automatic Water Displacement Generators. — Another group of generators is of the type where the carbide placed in a basket or similar holder is periodically dipped into the generator water and withdrawn. This can be effected by having the carbide container firmly built into the gasometer bell, so that the carbide, with the sinking of the bell, dips into the water. Or the carbide container can be firmly

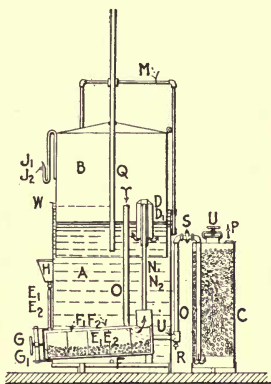

FIG. 13. — Cross section of "water to carbide" acetylene generator equipped with automatic water feed.

- A. Water chamber.
- B. Gas chamber.
- C. Purifier.
- D-D₁. Gas delivery.
- E₁-E₂. Carbide in multi-section container.
- F-F₁-F₂. Built-in container tube.
- G-G₁. Tube head and lock.
- H. Water supply.
- J₁-J₂. Water delivery regulator.
- M. Water delivery pipe.
- N₁-N₂. Gas delivery pipe.
- O. Gas outlet.
- P. Acetylene delivery pipe.
- Q. Gas vent.
- R. Drain cock.
- S. Gas valve.
- U. Purifier head.

fixed in a lower water vessel which is hermetically sealed and is simply connected with the upper water vessel by means of a vertical pipe.

When using such apparatus for the purpose of autogenous welding one must be careful that too great heating does not occur as otherwise this may be dangerous.

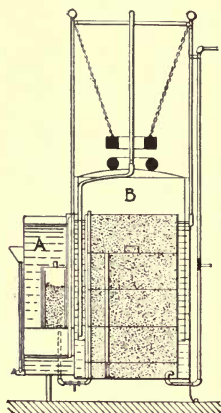

FIG. 14. — Cross section of "water to carbide" acetylene generator with automatic device for regulating the water feed.

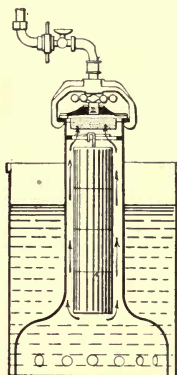

FIG. 15. — Acetylene generator for the use of compressed carbide.

Use of Beagid. — In the place of the carbide in general commercial use, one can also use in water displacement apparatus of this kind, compressed carbide known under the name "Beagid" and similar preparations, which is a mixture of carbide and a substance soluble in water. This mixture has the property, when periodically dipped in water, of loosening off single grains which fall to the bottom of the water supply, so that such apparatus is very similar to the carbide to water design.

With all acetylene apparatus careful cleanliness and attention to the prescribed details is of great importance.

If in an acetylene generator of the carbide-water type too great quantities of carbide are gasified without the residues being removed and the generator water being renewed, sufficient heating may ensue so that, with the opening of the apparatus and the entrance of atmospheric air, spontaneous combustion may be caused.

Dissolved Acetylene. — For the purpose of autogenous welding, acetylene dissolved, or dissolved acetylene, is also much used. In its preparation, special steel bottles, destined for this purpose, are filled up to the top with a porous substance and the bottles, so filled, are heated in furnaces sufficiently to expel every trace of moisture. The bottles are then filled with liquid acetone and by strict observance of definite precautionary methods, acetylene gas is pumped into them (Fig. 16).

Other systems of using dissolved acetylene have been introduced recently, where steel bottles are filled with a fibrous or other porous substance and then treated in a manner similar to the above process.

Dissolved acetylene can be used in ordinary workshops without any danger, yet a steel bottle filled with it must not be subjected to any heating. It is therefore necessary to take care that they are not placed near any furnace or other hot place and that they are protected from the rays of the sun.

Special welding burners and special pressure reducing valves must be used for acetylene dissolved.

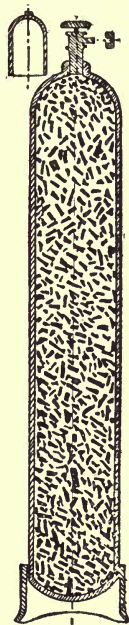

FIG. 16.— Cross section of acetylene dissolved bottle.

In using it for welding in powerful burners, the acetone will also be drawn out with the escaping acetylene. This makes it necessary with the heavier welding work to couple together several bottles by means of special fittings and to place the pressure reducing valve in the common outlet. When doing particularly heavy work from three to four bottles are sometimes in simultaneous use.

Chemical Purifying. — In the manufacture of acetylene, the raw material used for the production is not chemically pure, and as a result other gases and principally sulphuretted hydrogen and phosphuretted hydrogen are produced.

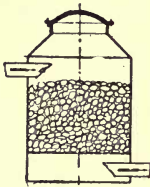

FIG. 17.— Chemical purifier using hygroscopic cleansing mass.

The quality of carbide now in general commercial use is such that the impurities from this cause do not exceed 0.05% sulphuretted hydrogen and 0.05% phosphuretted hydrogen.

Sulphuretted hydrogen is soluble in water and is therefore retained by the generator water in the apparatus in which periodically small amounts of carbide are thrown into a large excess of water. For this reason, with such apparatus, only the phosphuretted hydrogen need be given consideration.

Phosphuretted hydrogen has a pronounced affinity for oxygen and therefore if, for autogenous welding, acetylene with low phosphuretted-hydrogen content is used, this latter gas will act as a reduction medium for the metal of the welding seam. The phosphuretted hydrogen will combine with the oxide of the metal forming phosphoric acid.

For this reason, no harm can result when using correctly dimensioned carbide to water apparatus, not to fill the purifier with chemical purifying mass; such

mass however may be used to advantage for drying the acetylene.

It is a different matter with the water to carbide and water displacement generators, as in such apparatus a sufficient amount of water is not available for thoroughly absorbing the sulphuretted hydrogen formed.

It is therefore necessary to provide another absorbing or oxidizing medium and when using such apparatus care must be taken regarding the proper use and renewal of the chemical purifying mass. Such purifying masses are manufactured on the base of chlor or chromic-acid preparations.

When using hygroscopic masses in an acetylene purifying apparatus (Fig. 17) it is advantageous to let the acetylene flow from top to bottom in the purifier, while with the non-hygroscopic masses, the flow of the gas is from bottom to top (Fig. 18).

Mechanical Purifying.—In all acetylene generators, lime dust is carried away during the transformation of the carbide and it is important that this dust should be removed from the gas.

If this is not done, the countless molecules of lime taken away with the gas will be blown through the welding flame and become embodied in the material of the welding seam, which leads to a very appreciable weakening of the metal.

In order to avoid this, a dust filter should be arranged in front of each individual welding place. This dust filter can be constructed of two plate-shaped metal sheets fitted with couplings for the gas inlet and outlet pipe. The edges of these plates should be firmly fastened together having between them a dia-

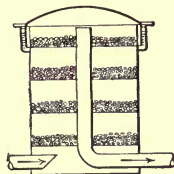

FIG. 18. — Chemical purifier using non-hygroscopic cleansing mass.

phragm of cloth or other permeable body for the filtration of the gas (Fig. 19).

As a filtering medium, a fine mesh linen may be used



FIG. 19. — Cross section of dust filter.

yet care must be taken when using this that the chemicals in the cloth have been previously removed by washing. Such filters must be periodically cleaned, which can be done by removing the lime dust from the diaphragm by means of a brush.

CHAPTER III

OXYGEN MANUFACTURE AND APPARATUS

OXYGEN used for autogenous welding purposes is commonly purchased in steel bottles. The initial pressure of the gas in these bottles is 150 atmos. (2200 lbs. per sq. in.) and when filled, they must not be thrown about or exposed to high temperatures.

At the crown of the bottle, the effective contents are usually stenciled in litres and if this capacity figure is multiplied by the pressure in atmospheres, shown by the gauge, the result will be the volume of free oxygen in the cylinder.

In order to calculate the quantity of oxygen used for any particular work, the contents of the cylinder are calculated in the beginning and after the work is finished, the difference being the quantity of oxygen used.

Up to the present time there does not exist a gas meter capable of satisfactorily measuring gas flowing under such high pressures.

Oxygen Manufacture.—The oxygen used for the purpose of autogenous welding is either produced by means of the rectification of liquid air, the electrolytic decomposition of water, or by one of the various chemical processes. The last named produce oxygen of different degrees of purity.

For autogenous welding and cutting it is advantageous to have oxygen of the highest purity and it is of advantage to be able to determine the purity of the gas used. The impurity consists in liquid air oxygen, of nitrogen and in electrolytic oxygen, of hydrogen.

Testing the Oxygen.— For testing the purity of the gas, a graduated glass burette is filled with oxygen

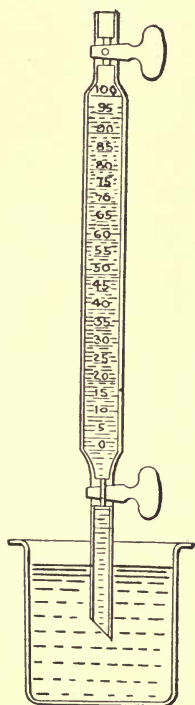

FIG. 20. — Cross section of apparatus for testing the purity of oxygen.

and with the upper end closed, the lower end of the burette is dipped into a vessel containing a substance which will absorb oxygen but not its impurities. This absorbing medium will then rise in the burette and in a few minutes the degree of purity of the oxygen can be read on the divisions of the tube (Fig. 20).

A satisfactory fluid for testing the purity of oxygen by absorption is prepared by dissolving 30 weight units of pyrogallol in 60 units of warm water and mixed with 160 units of a 1 to 2 solution of caustic potash.

Liquid Air Process.— The most common system for the production of oxygen is the air liquifying and distillation process.

Air is a mechanical mixture of about 21% of oxygen and 79% of nitrogen. If atmospheric air is compressed at high pressure by several stages of compression and the heat is removed between each stage of compression by suitable apparatus, the air gradually reaches a state of great density. With further decrease in temperature, as will occur when such air under high pressure is exhausted through a throttle valve into a space of lower pressure, a liquifying of the air will take place. The liquifying of atmospheric air occurs at a temperature of -316° F.

As such liquid air consists of a mechanical mixture

of nitrogen and oxygen and the boiling point of nitrogen is at -320° F. and that of oxygen at -297° F. there is a difference of 23 degrees between the critical points of the two gases.

In the usual oxygen production plants, the pipe for supplying the compressed air to the decompression valve of the air liquifying apparatus is led, in a coiled copper pipe, through the container in which the liquid air, collects. Thus the compressed air before its actual liquification, serves to heat the liquid air produced, while at the same time an equivalent amount of cold is given off from the liquid to the compressed air.

Consequently, the liquid air, as the result of this heating, must vaporise and as the boiling points of the two component parts are somewhat different in temperatures, the bulk of the vapor must be nitrogen.

If these gases rich in nitrogen are brought into contact with large surfaces of fresh incoming liquid air, in a manner similar to the distillation of alcohol, an enriching of the remaining liquid with the liquid oxygen occurs while at another point of the apparatus the technically pure nitrogen vapor escapes.

It is on this process that the design of the air liquifying apparatus for producing oxygen is constructed. In such process 1 to 3 H.P. hours are required for the production of one cubic metre (35 cubic feet) of oxygen, according to the size of the plant.

Electrolytic Process.— In the case of the electro-

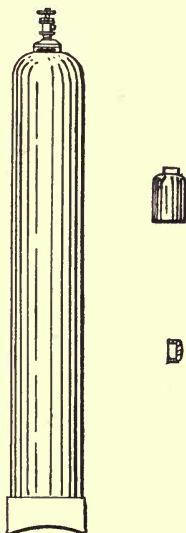

FIG. 21.— Oxygen bottle and protection caps.

lytic production of oxygen a separation of water into its component parts, i.e. hydrogen and oxygen, is effected. While atmospheric air is a mechanical mixture, the component parts of water are in chemical combination and therefore greater energy is required to effect the separation.

The production of 1 cubic metre of oxygen by the electrolytic method requires 12 to 13 H.P. hours and it is evident, from this large power requirement, that such process can only be advantageous and economical under particular conditions, when compared with the liquid air process.

Wherever there is use for the electrolytically produced hydrogen, as for example in the soap industry, the electrolytic process of the production of oxygen possesses great economic possibilities.

Chemical Processes.—There exists other different chemical processes for the manufacture of oxygen, which however are not of great practical importance on account of their great cost. For this reason it is impractical to devote sufficient space herein to deal with this subject in an exhaustive manner.

On account of the commonly used size of 40 litres capacity for steel bottles for the shipment of oxygen and owing to the general filling pressure of 150 atmospheres, every bottle of commercial oxygen necessitates a shipping weight of 12 kilos (26.5 lbs.) per cubic metre. The transportation charges therefore form a considerable item in the calculation of the price of oxygen.

Oxygen Valves.—The oxygen bottles in commercial use are provided with a screw cut-out valve having a side connection for the pressure reducing valve. In order to protect the cut-out valve during transport, it is covered with a steel screw cap and the side connec-

tion is protected by means of a brass cap (Figs. 21, 22 and 23).

If, in an autogenous welding plant, it should be noticed the cut-off valve on the bottle is leaking, the

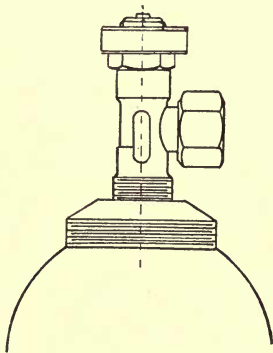

FIG. 22.— Outlet fittings of oxygen bottle.

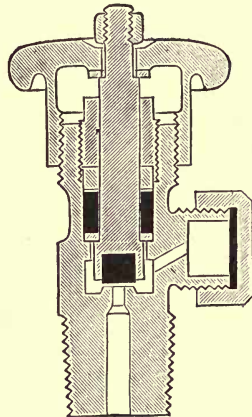

FIG. 23.— Cross section of high pressure valve for oxygen bottle.

oxygen company should be advised at once and such faulty bottle be returned to the factory.

Taking apart and repairing these fittings should be avoided, for if traces of oil or fat get into the bore, spontaneous combustion may occur, which under certain conditions may cause explosions and, even in the most favourable circumstances, will lead to the destruction of the valves.

For autogenous welding, oxygen is used under a pressure varying in accordance with the size of the burner, between 0.5 and 3.0 atmospheres (7 to 42 lbs. per sq. in.).



FIG. 24.— Gas pressure gauge.

The initial pressure of the oxygen in the bottles, of

150 atmospheres, gradually decreases with the use of gas and to secure a constant working pressure, the common pressure reducing valve is used.

Pressure Reducing Valves. — A valve of this kind for oxygen consists of a metal body with a bore for the escaping oxygen on which a pressure gauge is fixed which constantly shows the pressure in the cylinder (Figs. 24, 25 and 26).

The exit of the oxygen is regulated by a hard rubber body connected to a two part lever which rubber body is, by means of a spring, pressed against the oxygen outlet nozzle.

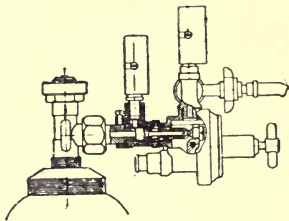

FIG. 25. — Cross section of pressure-reducing valve for oxygen bottle.

Set against the working of this spring is a second spring which is separated from the valve chamber by a diaphragm, so that the interior

is shut off from the atmosphere in a gas tight manner.

This second spring can, by means of an adjustable screw, be more or less compressed, so that against the pressure of the first spring a resistance can be regulated from the outside. Consequently the two springs form two forces, of which one can be regulated as desired.

At the interior between the oxygen valve and the diaphragm, a second pressure gauge is attached, while at the side of the valve chamber is placed the oxygen outlet connection. This second gauge shows the pressure under which the oxygen is fed to the burner.

In another design of valve, the regulating of the burner pressure is effected by means of a diaphragm controlled by a suspension spring so that a body is interposed through which a shaft is pushed more or less into the bore of oxygen outlet orifice.

If, in an autogenous welding plant, any trouble should occur with the pressure reducing valve, it is to be recommended that this be removed and returned to the manufacturer for repairs.

Before fitting the reducing valve to a bottle of oxygen, care must be taken to see that any dust or other matter in any of the connections is blown out. This

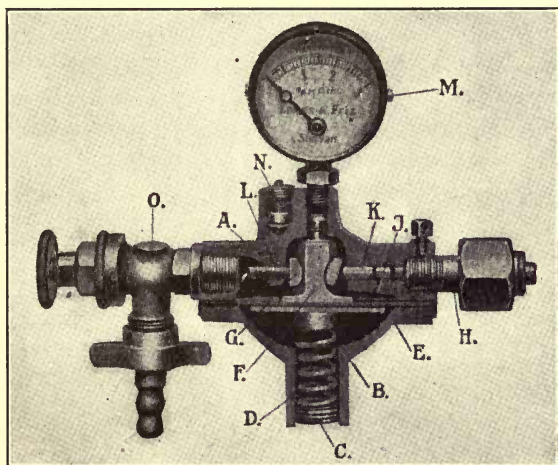

FIG. 26.— Cross section showing details of construction of pressure-reducing valve.

can be done by a quick opening and closing of the cut-out valve, as any foreign matter may cause trouble if it gets into the valve fittings. It should also be observed that all connection joints are in good condition.

In placing an oxygen bottle in service it is advantageous to have the cut-out valve opened slowly and not too suddenly, and the workman should avoid standing directly in front of the reducing valve during this operation. In several cases it has occurred that the high pressure of the oxygen bottle suddenly turned on has

burst the reducing valve owing to bad threads or faulty material, in which cases the front part of the valve was thrown out inflicting serious injury to the operator.

Repairs to pressure reducing valves should only be done in shops specially fitted up for such work, for these valves must stand the pressure of 150 atmos. and therefore the metal parts are subjected to severe strains.

CHAPTER IV

GAS MAINS AND FITTINGS

It is very important that the piping for conducting acetylene through an autogenous welding shop be of sufficient diameter, for when this is not the case, a burning of the welding seam may occur if an unusual number of welding burners, or burners with a larger acetylene consumption, are placed in operation.

Gas Mains. — In a properly arranged welding shop a large gas main is laid through the workshop, in which branch pipes are provided for each individual welding station.

With low pressure acetylene apparatus, the pressure of the acetylene is generally of 100 m/m water column or .01 atmos. (.147 lbs. per sq. in.) while the pressure of the oxygen may under certain circumstances be 2 atmos. (29.4 lbs. per sq. in.). The welding burners are, following these conditions, constructed on the injector principle.

Back Firing. — If, during operation, the bore in the burner tip becomes choked, as may happen through the molten iron spurting into the nozzle, then the oxygen, being under high pressure, will recede into the acetylene supply which is under low pressure.

Now should incandescent particles of soot be carried back by the oxygen stream, an explosion will occur, if, in the acetylene gas main, there should be a suitable place for the formation of an explosive oxy-acetylene mixture. Such explosion may have very serious re-

sults, especially if the incandescent matter penetrates as far as the acetylene generator.

Safety Devices. — For this reason it is necessary to provide against such possibilities by inserting a back-flash prevention device in the feed pipe of the combustible gases.

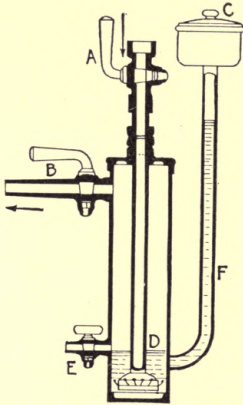

FIG. 27. — Cross section of water seal — Fouché system.

- A. Inlet valve.
- B. Outlet valve.
- C. Water entrance.
- D. Gas chamber.
- E. Drain cock.
- F. Pressure regulator.

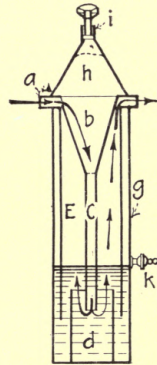

FIG. 28. — Cross section of water seal equipped with whistle signal.

- A. Gas inlet.
- B. Gas chamber.
- C. Gas delivery pipe.
- D. Water seal.
- E. Gas reservoir.
- G. Container.
- H. Container cap.
- I. Whistle signal.
- K. Drain cock.

The most reliable type of such a back-flash safety device is constructed in the form of a water seal, or trap, and arranged at each individual welding station so that the acetylene, en route to the burner, is conducted through this water supply (Figs. 27, 28, 29 and 30).

The welder must see before the commencement of each welding period that a sufficient supply of water is present in the trap, which can generally be done by opening a test cock provided for the purpose.

Connection Hose. — For supplying the acetylene and oxygen to the welding burner, either rubber or flexible metal hose is used. The diameter of such hose should not be less than 6 m/m ($\frac{1}{4}$ in.) for oxygen and 8 m/m ($\frac{5}{16}$ in.) for acetylene.

As the acetylene is under a low pressure, ordinary rubber hose of sufficient strength to prevent leaking may be employed. However, should too soft a rubber hose be used, it will easily flatten, in consequence of the suction influence of the oxygen, and cause sputtering in the burner.

Rubber Hose. — Bursting of the rubber generally occurs where the hose is drawn over the connecting nipples but this may be prevented by winding steel wire over that portion of the hose.

For oxygen, the ordinary hose with hemp lining is used as this has sufficient strength for the high pressure of the gas. Hose wrapped with flexible wire coil may also be used to advantage.

If the fittings for the hose connections are the common sleeve couplings, care must be taken that the joints are kept in good condition.

Defective rubber hose may be repaired by cutting

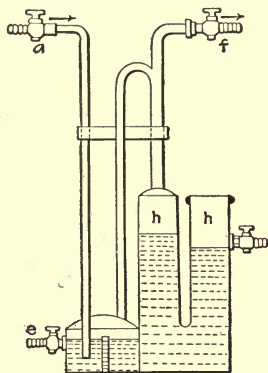

FIG. 29. — Cross section of water seal — Herzfeld system.

- A. Inlet valve.
- E. Drain cock.
- F. Outlet valve.
- H. Pressure chambers.

out the leaking part and connecting the two ends with a suitable piece of metal pipe (Fig. 31).

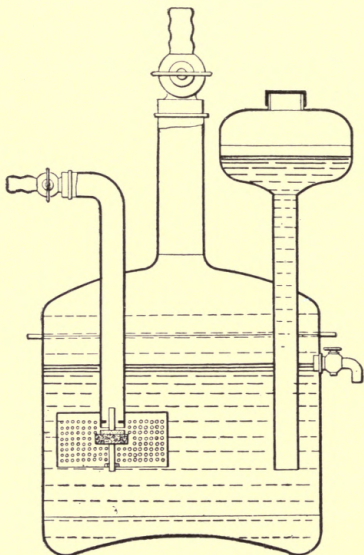

FIG. 30. — Cross section of water seal equipped with gas pressure chamber.

Metal Hose. — When metal hose is used, care must be taken that the packing of the hose spirals which is done with a rubber packing, is not touched with a

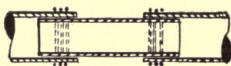

FIG. 31. — Cross section of repaired rubber hose.

welding flame. In this case the rubber packing will burn, causing a leak which cannot be repaired.

CHAPTER V

AUTOGENOUS WELDING BURNERS

AN autogenous welding burner is an extremely sensitive apparatus, whose good working is dependent upon the exactness of its construction. Consequently it is often found that those with cheaper first cost are the most expensive to operate.

Equal Pressure Burners.— In using a combustible gas supplied to the burner at a pressure equal to that of the oxygen, it is sufficient if the burner is fitted with a simple mixing chamber into which the two gases are conducted through converging bores (Fig. 32).

For using acetylene dissous the burners are so constructed that the acetylene is led through a filtering substance usually situated in a chamber in the handle of the burner. This serves to prevent the flame getting behind the burner and reaching the acetylene bottle.

Should the acetylene used for autogenous welding be drawn from the usual acetylene generator, then other conditions will exist, which must be considered in the construction of the burner.

Such apparatus give off the acetylene gas at the low pressure of about 100 m/m water column, or .01 atmospheres. This low pressure does not allow the speed of the explosive gases to be sufficiently high, to exceed the combustion speed of the oxy-acetylene mix-

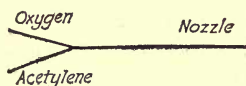

FIG. 32.— Diagram showing gas feed in an autogenous welding burner.

ture in the flame, and this condition would induce continual back fire and explosion in the burner.

Injector Burners. — In order to avoid this, the oxygen must be given sufficient pressure to produce a suction effect upon the acetylene supply by means of an injector arrangement in the welding burner.

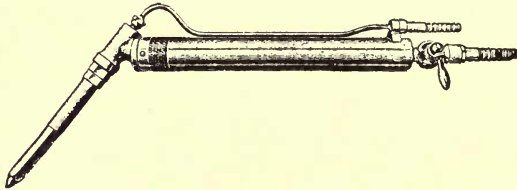

FIG. 33.— Oxy-acetylene welding burner.

An oxy-acetylene burner is a very sensitive apparatus and the greatest care must be exercised in its manufacture. Since the first satisfactory welding burners were constructed by the French engineer, Edward Fouché, burner manufacture has developed extensively and has led to the design of various styles of welding burners (Figs. 33, 34, 35, 36, 37).

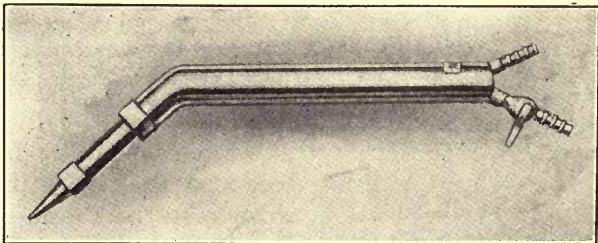

FIG. 34.— Oxy-acetylene welding burner.

Adjustable Burners. — For welding in large works, a different burner is used for each individual thickness of material. Burners in which the oxygen nozzle opening can be regulated by a needle valve, have been in-

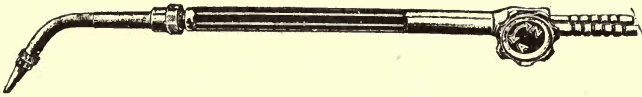

FIG. 35.— Oxy-acetylene welding burner.

produced by different makers, but have not proved satisfactory.

In small shops, as for example, a locksmith, burners are used on which interchangeable tips, fitted with a fixed oxygen injector device, can be attached.

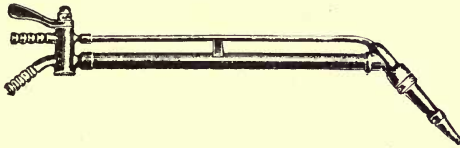

FIG. 36.— Oxy-acetylene welding burner.

Much trouble is caused by welding burners which have not carefully and precisely made bores. In many cases, after the burners have been in use for some time, changes in the flame will occur in consequence of unequal expansion of metal from the heat, and this makes it necessary to repeatedly cool such burners.



FIG. 37.— Oxy-acetylene welding burner.

Flame Adjustment. — In the use of autogenous welding burners it is necessary to watch that the welding flame is correctly adjusted. The correct adjustment is secured when the inner cone of the flame has the greatest possible length and its contour is sharply defined against the outer part of the flame (Fig. 38).

If an illuminating mantle is formed around the inner cone, there is a surplus of acetylene (Fig. 39). If the inner cone is shortened and transformed in color, from a dazzling white to a violet, then there is a surplus of oxygen (Fig. 40). In both cases the welder will be able to bring the flame to its correct proportions by suitable adjustment of the gas feed on the burner.

Oxidising Flame. — A surplus of oxygen in the flame causes a burning of the welding seam or leads to the metal being overheated; which is no more or less than a minor degree of burning.



FIG. 38. — Correctly adjusted or neutral oxy-acetylene welding flame.

When welding mild steel, if a very lively spray of sparks is in evidence it is a sign that a burning of the welding seam is occurring, especially if the sparks, so thrown out, burst at the end of their flight. When welding with a correctly adjusted flame the sparks will retain a distinct ball shape form.



FIG. 39. — Carbonizing welding flame, *i.e.* with excess of acetylene.

When the former appearance occurs in welding it is necessary either to decrease the oxygen supply, which can be effected by suitably adjusting the screw of the

pressure reducing valve, or to increase the acetylene supply by adjusting the acetylene valve on the welding burner.

Carbonizing Flame. — If the inner cone of the welding flame loses its distinct outline and is surrounded by a faint light mantle, it is a sign that there is a surplus of acetylene in the flame.

Then it is necessary to either reduce the flow of acetylene until a normal welding flame is secured, or to set the pressure reducing valve on the oxygen bottle to a higher pressure, resulting in a larger oxygen supply, so that the correct proportions of the mixture will be obtained.

An excess of acetylene in the welding flame may lead to hardening of the welding seam, in the case of mild steel, or wrought iron, as carbonization of the iron occurs, in consequence of the free carbon present in the flame.



FIG. 40.— Oxidizing welding flame, *i.e.* with excess of oxygen.

As already stated, the burning of the acetylene in a stream of oxygen, is a two phase process and this circumstance is the determining factor for the relative proportions of the gases fed into an autogenous welding burner.

Any welding burner, in the construction of which this factor has not been taken into account, will lead to faulty welding seams.

Burner Construction. — In an autogenous welding burner, a throttle point is provided for the oxygen

injector, where the diameter of the bore begins to increase. Beginning with the widest part of the bore, a conical reduction of the same commences, the burner tip ending in a narrow cylindrical boring, by means of which the issuing mixture of the gases is throttled so that the velocity of the escaping gas becomes greater than the velocity of the ignition of the explosive mixture. In this way back flashes of the flame into the bore of the burner may be prevented successfully.

The taper of the bore must be carefully calculated and, should the exit nozzle become stopped, the use of a reamer which would damage the bore must be avoided.

The tip of the burner is usually made of copper, while the other portions are made of brass or malleable iron. Brass is a compound of copper and zinc, two metals which have different melting points.

If when using a welding burner, a back firing occurs, it is possible that the flame may exist in the interior of the welding burner, where the mixing of the combustible gas and oxygen is effected. Even after the dipping of the nozzle in water such a flame may continue to burn.

With common oxy-hydrogen burners, such a flame melts off the inner nozzle of the burner which is usually made of iron. On this account, in oxy-hydrogen welding plants, a good supply of such iron nozzles should be available so that the welder may make the necessary renewal.

In oxy-acetylene burners, this interior burning of the flame would readily melt the zinc out of the alloy metal and thus cause an unevenness in the interior bore of the burner, which would produce eddies in the flow of the gases.

Mixing of Gases. — Some investigators have shown

that immediately behind the oxygen nozzle the mixture of the two gases is absolutely complete. Others assert that the mixture of the gases is more or less complete at the exit of the high pressure oxygen nozzle, the extent of the mixture being dependent upon the angle and the pressure under which the acetylene is fed; and that the oxygen current draws the acetylene with it, in eddies, into the burner nozzle where the acetylene becomes more or less separated by centrifugal force, so that it comes in contact with the inner bore of the heated burner tips. The degree of expansion of the acetylene thus becomes greater than that of the oxygen and this serves to explain the difference in the relative proportions of the mixture, which occur when the burner nozzle becomes heated.

It is certain that with various types of burners the relative proportions of the mixture are considerably altered after the heating of the burner. There are types of burners where these changes are a very frequent and unpleasant occurrence for the welder; and in this case the cooling must extend over the whole nozzle body. In other types the cooling is necessary only when the burner tip has become so hot that there is danger of melting off the copper point.

Cleaning of Burner. — During autogenous welding work, drops of molten metal frequently splash into the burner nozzle where they solidify and affect the operation of the burner. It is then necessary to clean the nozzle either with a sharpened piece of wood or by means of a spiral fluted reamer which exactly fits the bore.

Back Firing. — In the event of a back firing of the flame into the interior of the burner, the welder should close the acetylene valve so that further burning is averted. If this is not done then sparks from the

interior flame will be forced through the nozzle and a rapid and intensive heating of the burner will take place.

With burners having interchangeable nozzles, it is necessary to see that all joints and fittings are in good condition, as otherwise very serious trouble may be experienced.

In various types of burners the mixing chamber is located in the handle of the burner while a thin copper or a steel pipe, on the end of which the usual copper nozzle is provided, serves as a mixing chamber. This copper pipe has the advantage of being bent as desired, but such pipe must be carefully handled as repeated bendings cause much damage.

With these burners the mixing chamber is outside the limits of the heating zone of the burner and this has particular technical advantages.

With another type of burner the oxygen is fed into the injector by means of a small copper pipe arranged spirally around the burner nozzle. The object of such arrangement is to cool the burner nozzle by absorbing the heat radiating from the welding place and at the same time to preheat the oxygen led to the injector.

This preheating, however, causes an expansion and consequently increases the volume of oxygen according to the degree of heat, which produces changes in the relative proportion of the mixture and therefore in the effectiveness of the burner.

Gas Consumption.—Manufacturers of autogenous welding burners have taken as a standard, that for each millimetre of thickness of the sheet to be welded an hourly consumption of 80 litres of acetylene and 100 litres of oxygen is necessary. The requirement on this basis for the welding of a sheet $\frac{3}{8}$ inches in thick-

ness, would be an hourly consumption of 33.8 cubic feet of oxygen and 27 cubic feet of acetylene.

An experienced welder works to advantage by using larger burners than standard, as his output increases while the required amount of gases used for the same length unit of the seam diminishes. This is to be explained by the fact that when working quickly less heat is absorbed by the metal adjacent to the welding seam.

CHAPTER VI

AUTOGENOUS CUTTING BURNERS

THERE are three kinds of autogenous cutting burners, viz:

Cutting burners in which the oxygen is taken from a central nozzle placed concentric with the annular nozzle feeding the pure combustible gas (Fig. 41).

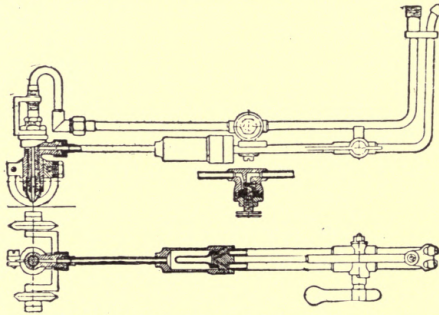

FIG. 41. — Vertical and horizontal cross sections of autogenous cutting burner having central oxygen nozzle and equipped with roller attachment.

Cutting burners constructed similar to the above, but in which a mixture of combustible gas and oxygen is fed through the annular nozzle in place of the pure combustible gas.

Cutting burners composed of the usual type of welding burner with an oxygen nozzle arranged at the side of it (Fig. 42).

Theory of cutting. — Autogenous cutting is based on the fact that iron has the property of burning in an

atmosphere of oxygen, if the iron is brought to a certain high temperature.

With the usual cutting burners, the regular combustion flame serves for the local heating of the material while the oxygen is blown in a compact stream upon the heated place.

As in the case of the burning of any other combustible body, heat is liberated by the burning of the iron which raises the temperature of the adjacent parts of the iron and prepares it for further combustion. This burning can only occur when oxygen of sufficient mechanical force is directed on to the hot iron and the combustion is effected in the direction of the oxygen stream through the total thickness of the body.

In this manner a smooth cut is obtained and with increasing thickness of the iron, there is improvement in cutting effect.

Volume of oxygen. — In this combustion process the oxygen combines with the molten particles, thrown off by the speed of the current, to form iron oxide. For this reason the quantity and current velocity of the oxygen must be greater according to the increasing thickness of the metal sheets.

The evenness of the surface of an autogenous cut is primarily dependent upon the compactness of the stream of oxygen. It is also dependent upon the direction of the current remaining constant.

Guiding Devices. — For the latter reason it is of advantage to fit the cutting burner with a mechanical guiding device. Guiding by hand cannot be as steady and even, as with a mechanical guide, for the effect of the pulsating of the blood in the hand is sufficient to produce unevenness in the surface of the cut. The more even the guide, the better the cut and the more economical the operation.

The usual guiding device for autogenous cutting burners comprises a pair of rollers mounted on the burner nozzle. These rollers should be so arranged that the oxygen nozzle, especially in the double nozzle burners, should reach about 5 m/m nearer to the material to be worked on, than the combustion flame which approaches the surface to be worked upon at a distance of 5 m/m (about $\frac{3}{16}$ inches).

For the execution of circular cuts, a guiding device is used, composed of a guide rod, to one end of which the cutting burner is fixed, while at the axis of the rod, a trammel point is arranged so that the burner can be moved around a given centre.

For executing irregular cuts, a suitable templet is provided along which the burner is guided.

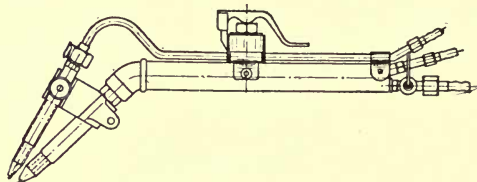

FIG. 42.— Cross section of autogenous cutting burner having an independent oxygen nozzle.

An interesting device for autogenous cutting consists of placing the drawing on a table at the side of the work bench and providing a suitable connection for the cutting burner. Such appliances are known in the United States as the Pantograph and Oxygraph cutters. By moving the stylus over the lines on the drawing, the material is cut to the same contour by the cutting burner. The burner can also be propelled by a small electric motor by having a suitable connection for mechanical drive for one of the rollers.

Industrial Applications. — In ship building the autogenous cutting process is employed for cutting armor plate and for cutting openings in the iron plates for bulkhead doors and port holes.

For such work as is continually repeated as, for example, the cutting of port holes, openings for doors, manholes for steam boilers, etc., a guide rail can be used to advantage. This guide rail is made of lead and bent to the form of the opening to be cut, on which rail is arranged a movable carriage having a suitable roller guide which carries the burner.

Such device is often used where the burner is arranged slanting to the vertical axis of the plate. By this means, slanting cuts are obtained which are so exact that, in the case of port holes or similar work, the parts cut out can afterwards be used as doors.

In autogenous cutting, the results are absolutely dependent upon the stream of oxygen, so that the kind of combustible gas used for the preheating flame is relatively unimportant and, in such choice, economy is the sole deciding factor. Of all the known gases acetylene gives the hottest flame which makes it particularly adapted for the purpose of autogenous cutting.

With correct usage of a properly constructed cutting burner no detrimental change of material at the cutting surface takes place.

As to the cost of the autogenous cutting process different tables are supplied herewith but these can be regarded as only approximately correct.

OXY-ACETYLENE CUTTING
GAS CONSUMPTION AND TIME REQUIRED

Thickness of Material. Mild Steel	Oxygen Consumption Per Metre Cut	Acetylene Consumption Per Metre Cut	Time Occupied Per Metre Cut
5 m/m	110 litre	90 litre	2 min. 50 sec.
10 "	140 "	120 "	4 " — —
15 "	230 "	180 "	4 " 30 sec.
20 "	300 "	250 "	5 " 45 "
30 "	400 "	320 "	6 " — —
50 "	550 "	400 "	6 " 25 sec.
75 "	900 "	650 "	7 " — —
100 "	1400 "	750 "	8 " — —
150 "	2000 "	900 "	10 " — —

OXYGEN-HYDROGEN CUTTING
GAS CONSUMPTION AND TIME REQUIRED

Thickness of Material. Mild Steel	Oxygen Consumption Per Metre Cut	Hydrogen Consumption Per Metre Cut	Time Occupied Per Metre Cut
5 m/m	108 litre	90 litre	5 min. 30 sec.
10 "	130 "	100 "	6 " — —
15 "	230 "	110 "	6 " 30 sec.
20 "	266 "	110 "	6 " 30 "
30 "	432 "	110 "	6 " 30 "
40 "	550 "	110 "	6 " 45 "
50 "	800 "	180 "	7 " 30 "
75 "	1033 "	210 "	8 " — —
100 "	2600 "	380 "	10 " — —
150 "	2800 "	450 "	10 " — —

RESULT OF EXPERIMENTS MADE BY TUCKER
AT BIRMINGHAM (ENGLAND) UNIVERSITY

Experiment No.	Purity of Oxygen	Length of Cut (Inches)	Requisite Time in Seconds	Oxygen Consumed (Cu. Ft.)	Requisite Time in Seconds per Cu. Ft. of Cut.	Oxygen Consumed	Increase of Requisite time in Percent	Increase in Quantity of Oxygen Used in Percent	Remarks
				%		%	% Taken as Standard		
1	99.5	69	309	6.0	54	1.0			Very clean
2	99.3	68	273	7.5	48	1.3	—	27.8	Good cut
3	98.0	68	286	9.1	51	1.6	—	53.8	Fairly good
4	97.6	68	295	9.8	53	1.7	—	67.3	Rough cut
5	96.8	66	363	11.8	64	2.1	18.5	101.9	Very rough
6	95.0	67	377	11.6	67	2.1	24.5	98.0	Not clean and ragged
7	92.2	69	552	15.0	96	2.6	77.7	150.0	Very ragged
8	88.2	69	615	16.2	107	2.8	98.1	170.1	Very ragged and rough
9	87.3	68	660	16.2	117	0.2	116.6	207.6	Very ragged and rough
10	83.3	68	855	18.9	152	3.4	181.4	222.6	Not cut through

CHAPTER VII

AUTOGENOUS WELDING OF IRON

AUTOGENOUS welding is a process for fusing together metallic parts and is applicable for all metals and their alloys, of which the most important are iron, copper and aluminium.

In dealing with the characteristics of autogenous welding, it appears advisable to discuss the more important metals, a knowledge of which is essential for such process.

Iron. — Technical iron is an alloy of pure iron with other elements, the most important of which is carbon; and the different properties of this important metal are dependent upon the carbon content.

Iron with less than .5% carbon is called malleable iron or mild steel, according to the method of production. With .5 to 1.5% carbon it is termed steel; and with greater carbon content it is known as cast iron or white iron (Figs. 43 to 51).

• **Carbon in Molten Iron.** — Carbon is always present in molten iron similar to salt dissolved in water, but when the iron becomes solid, the diffused carbon assumes other forms. It may either form iron carbide as, for instance, in pig iron or mild steel, or it may be transmuted into graphite as is the case in grey cast iron. It may continue in the diffused condition within the iron, in which case the latter forms steel or white iron according to its contents of carbon.

The exact transmutation process is dependent upon

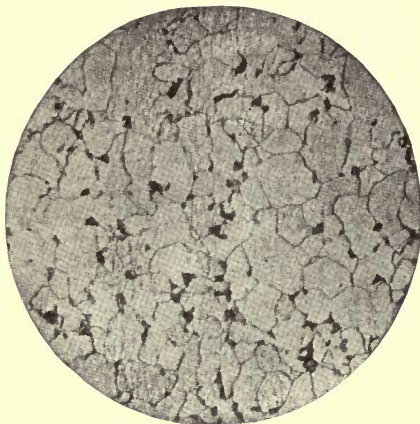

FIG. 43. — Micro-photograph of mild steel bar.
(Magnified 80 diameters)

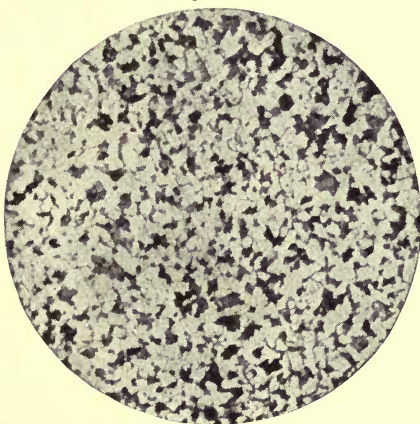

FIG. 44. — Micro-photograph of steel bar contain-
ing 0.4% carbon.
(Magnified 80 diameters)

the other materials mixed with the iron, especially the silicon and manganese. Silicon favors the formation of graphite in cast iron, while manganese favors the formation of steel or white iron according to its percentage, or the form of the carbon content.

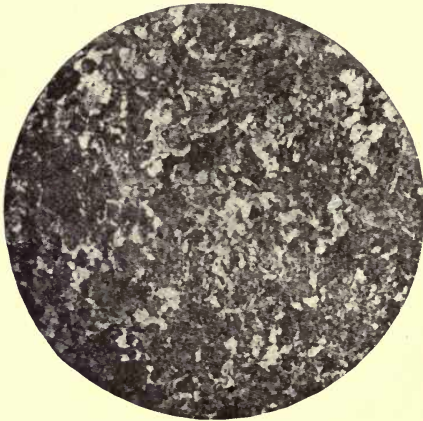

FIG. 45. — Micro-photograph of steel bar containing about 0.75% carbon.
(Magnified 80 diameters)

The fact that iron can assume entirely different physical qualities is of paramount importance in the autogenous welding of metals. When hydrogen is employed as a heating agent for the autogenous welding, a decarbonization of the iron must always occur.

With the employment of the gases for heating, whose products of combustion contain free carbon, the percentage of carbon in the iron must increase during the welding operation.

If a neutral flame, as for instance a properly adjusted oxygen-acetylene flame, is made to play upon the molten iron, the percentage of carbon in the metal remains unchanged.



FIG. 46. — Micro-photograph of steel bar containing about 0.75% carbon.
(Magnified 300 diameters)

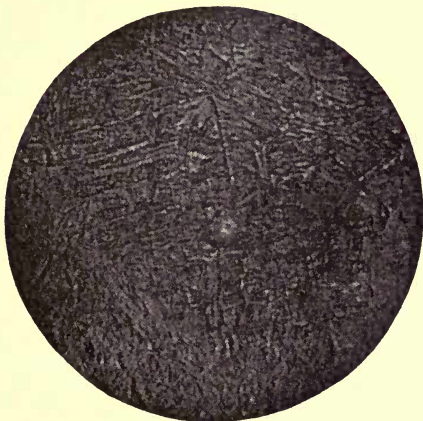

FIG. 47. — Micro-photograph of steel bar containing about 0.75% carbon — hardened.
(Magnified 80 diameters)

The molten iron however is still capable of absorbing free hydrogen, which gas is expelled as the metal becomes rigid. The phenomenon of foaming of the iron may thus occur in the welding seam: the iron being divided into thin films surrounding the cavities from which the gas has been expelled.

Effect of Excess Carbon. — If the welding flame contains free carbon, the latter is able to penetrate into these thin films and, when the metallic mass covering the gas bubbles sinks back into the molten material, the welding seam becomes enriched with carbon.

The seam then becomes hard and brittle and in this manner the welded portion of wrought iron may assume the character of steel or even that of cast iron.

The molten iron has also the quality to form a compound with oxygen, i.e. to be burned, and as the temperature of the iron is increased the disposition to combine with oxygen is also increased. At the same time, the chemical product of the combustion of the hydrogen, superheated steam, is set free with each increase in temperature and above a certain temperature, the oxygen liberated from this superheated steam passes into the molten iron.

Distinction between the superheating of the iron and the combustion of it, is made entirely according to the degree of the compound of iron and oxygen. A superheating of the iron is, in reality, a lesser degree of combustion.

This effect of free oxygen has to be considered mainly in such gases as contain free oxygen, free hydrogen, or free carbon, in their products of combustion.

Similar phenomenon may take place in the employment of acetylene, if this gas, in the course of its generation, has become overheated by the released reaction heat. The gas used in that case for the pur-

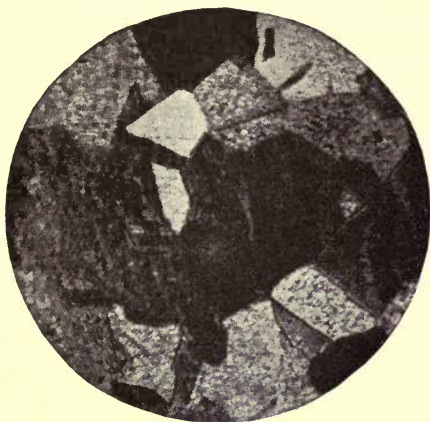

FIG. 48. — Micro-photograph of nickel steel bar
 — unmagnetic.
 (Magnified 300 diameters)

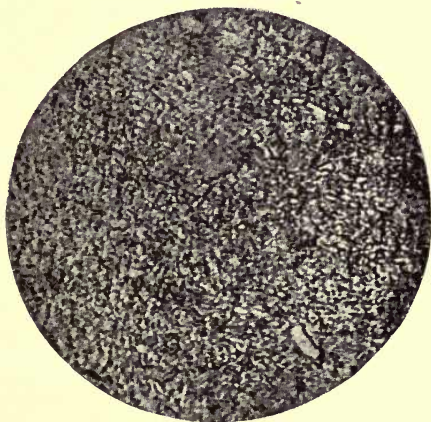

FIG. 49.— Micro-photograph of high-speed steel bar.
 (Magnified 80 diameters)

pose of welding has thus partly passed into the polymeric compounds of acetylene.

Contained in rolled or wrought iron are flaws, which were not eliminated previous to the ingot becoming rigid. In the process of rolling, these flaws are stretched out in the same direction as the rolling and fibrous layers of iron and residues are formed within the material.

When such material is passing into the molten state, under the influence of the welding flame, these flaws contract into knotty particles, affecting the quality of the material and it assumes a grainy, in place of a fibrous, character. However, by a suitable mechanical after-treatment, the welding place can be given the same character as of the original rolled material.

Pearlite. — It has been previously mentioned that the state of carbon within the iron determines the physical quality of the latter. In a compound of certain percentages of carbon and iron, the particles of carbon assume a "mother of pearl" appearance, which particles, sprinkled among the mass of the pure iron, are pearlite or cementite. Pearlite consists of an iron carbon alloy with from .8% to .9% of carbon, and is characteristic of mild steel.

A simple method of determining the carbon percentage of iron, and thereby its density, has been given by Baumann.

Place a glass plate ruled with 100 equal squares, upon the photo of the magnified polished surface of the iron under examination and the carbon percentage can be approximated from the number of these squares filled with pearlite.

If for example 23 of the 100 squares are filled with pearlite, the calculation is as follows:

$$\frac{23 \times .8}{100} = .184\%$$



FIG. 50.— Micro-photograph of cast iron.
(Magnified 300 diameters)

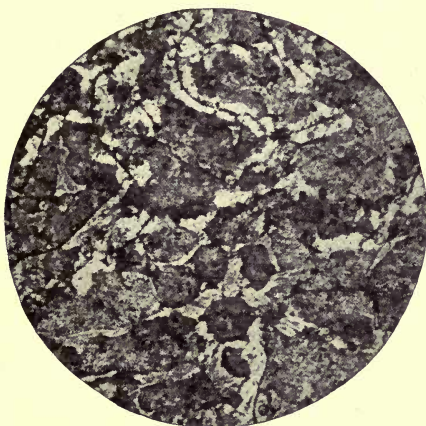

FIG. 51. — Micro-photograph of white iron.
(Magnified 300 diameters)

It has also been mentioned that the percentage of silicon and manganese is the determining factor of the state of carbon contained in the iron. Grey cast iron is an iron of high carbon percentage in which the carbon content is in the form of graphite.

Welding of Cast Iron. — If a mass of grey cast iron is to be treated by means of an autogenous welding flame, grey cast iron of a high carbon percentage and with a certain higher percentage of silicon must be employed as a filling material. During the autogenous welding process, a part of the silicon contained in the casting evaporates, and this quantity of silicon must therefore be replaced by the filling material.

As cast iron also contains manganese, as well as silicon, the formation of white iron will occur in the



FIG. 52. — Etching of a good welding seam.

welding place, if sufficient silicon evaporates so that the manganese predominates. This serves as an explanation for welding seams frequently becoming hard and brittle during the welding of grey cast iron.

For the autogenous welding of such iron, it is therefore necessary to employ as filling material small bars of grey cast iron of high percentage of carbon, and a still higher percentage of silicon.

The structure of the grey cast iron is a grainy one and in order to lessen the influx of atmospheric oxygen and to secure a better structure of the material, it is advisable also to employ one of the common fluxes, in the welding of such castings.

After the place to be welded has been cut away sufficiently to secure good results, the welding flame is applied until the lowest portion of the metal reaches a molten state. The heated part is then amply sprinkled with the flux and the welding bar is also heated and plunged into the molten metal.

Under a continuous influence of the welding flame, the molten material of the seam is stirred, so that the filling material flows off and fills up the place to be welded.

It is important that the workman should carefully observe the flow of the welding seam and if the molten iron is blown out of the groove by the flame, the workman should observe whether there is still an unfused portion inside the welding furrow, the characteristics of such imperfectness being the appearance of film-like layers imbedded within the molten mass. If so, he must see that the material is fused in this place also.

If the welding of the grey cast iron has been properly executed, the structure at the welding place will always be of better quality than the original material.

Welding of Cast Steel. —

In welding cast steel, it must be taken into consideration that this is a material in which the carbon percentage is between that of mild steel and that of grey cast iron. It is best

to employ small cast bars of the same metal, as filling material, but as these are not always obtainable Swedish soft iron may be used in conjunction with the cast bars.

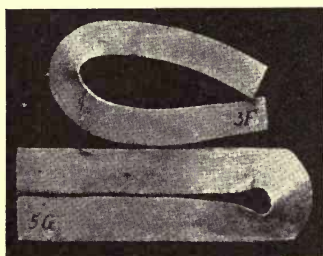

FIG. 53. — Good welds after having been subjected to severe bending test.

With ordinary care, the proper percentage of carbon can be obtained at the welding place. Weldings of cast steel can however be executed with good results by using Swedish soft iron alone, as filling material.



FIG. 54. — Decarbonization of iron in a welding seam.

Welding of Hard Steel. — For the autogenous welding of hard steel it is advantageous to employ filling bars with a high percentage of manganese. As the elasticity of spring steel has its origin in the process of hardening, if it is desired to impart physical properties to the welding place similar to those of the rest of the material, it is necessary to harden the material of the welding place in the usual manner.



FIG. 55.— Traces of carbon deposits in a welding seam.

Welding of Wrought Iron or Mild Steel. — In welding wrought iron or mild steel, Swedish soft iron of small carbon percentage is employed as filling material. The melting point of such a material is between 1500° and 1600° C. (2732° F. to 2912° F.). With increasing percentage of carbon the melting point becomes lower and it sinks as low as 1050° C. (1922° F.) with an iron of such high carbon content as grey cast iron. The melting point of iron oxide lies at 1350° C. (2462° F.).

In the autogenous welding of mild steel and wrought iron the melting of the oxides, if any exist, must be accomplished simultaneously with the melting of the metals. The melting point of the metal is sufficiently



FIG. 56.— Excessive carbonization in a welding seam.

high to destroy the oxides and as the metal flows together directly when these substances are worked upon, there is no need of a flux in the welding of these metals (Figs. 52, 53, 54, 55, 56).

In grades of iron, having melting points lower than that of the iron oxide, the fusing of this oxide can not possibly be effected as the temperature of the latter is always kept down by that of the molten metal. In the welding of such materials therefore, it is necessary to employ a welding powder, or flux, which is able to chemically destroy the existing oxides. The stirring with the welding bar during the welding operation is also advisable as this tends toward a mechanical destruction of the oxides. (Fig. 57.)

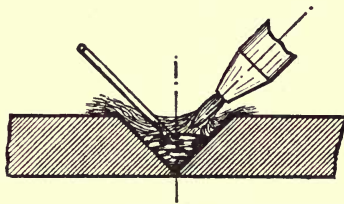

FIG. 57.— Method of stirring the molten metal with the filling bar during the welding operation to destroy the films of oxide.

In the autogenous welding of mild steel it is of great importance to consider the state in which the carbon exists. As previously mentioned the carbon always exists in a fluid condition in molten iron and it

is only when the metal becomes rigid that its condition changes. In the case of mild steel the carbon content consists of pearlite.

Martinsite. — It is well known from the hardening treatment that by a process of sudden cooling and quenching, certain states of the metal can be lastingly obtained which otherwise only exist at higher temperatures. In the autogenous welding of mild steel there is always the danger that, in consequence of a rapid cooling, a liquid form of the carbon is retained in the iron, so that the welding seam assumes the character of steel. It is then possible that Martinsite will exist in place of pearlite.

Martinsite is a substance which has the same percentage of carbon as pearlite, but differs from the latter in its great hardness. If martinsite is produced, the welding seam of mild steel becomes hard and brittle and, therefore such changes of the material should be avoided.

Welding of Cast Steel and Wrought Iron. — In the welding of cast steel and wrought iron or similar combination which is frequently done in the manufacture of certain articles, the peculiarities of each metal must be carefully considered. In the construction of motor valves, for example, the spindle is made of wrought iron and the disk of cast steel, owing to these parts being subjected to different stresses. The union is effected by means of the autogenous welding flame in the regular manner.

CHAPTER VIII

REPAIRS OF GREY CAST IRON

A VERY wide field for autogenous welding is the repair of broken cast iron pieces. As previously mentioned, grey cast iron is an alloy with a high percentage of carbon and a still higher percentage of silicon and the presence of the latter causes the carbon to exist in the form of graphite.

Formation of White Iron.—Silicon has so low a boiling point that under the influence of a welding flame it evaporates and without special precaution, the percentage of silicon contained would be considerably reduced during the welding of grey cast iron. This would result in the carbon content assuming another form and white iron would exist in that portion of the material influenced by the welding flame. Owing to the characteristics of white iron, the welding seam would become hard and brittle.

This phenomenon must be avoided and its prevention is of such importance that the author repeats its mention here again. The details of the correct treatment are given in the preceding chapter.

Presence of Tensions.—In grey iron castings, high tensions exist in the individual portions, due to the unequal cooling of the mass, during its manufacture and these tensions usually cause cracks if other forces later on influence the substance.

Such latent tensions exist in the spokes of wheels at the point where the relatively greater mass of the rim

joins the thinner mass of the spokes. Attempts to weld such spokes, without the necessary preparation, would result in new cracks when the cooling down takes place.

The proper method of execution is first to heat the rim so that it will expand and thus enlarge the fissure

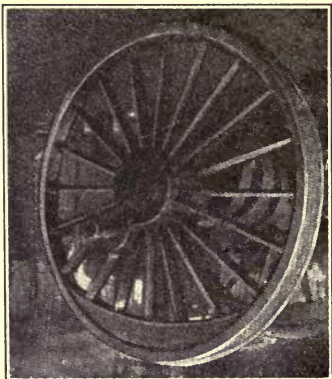

FIG. 58.— Locomotive drive wheel with cracks in spokes repaired by autogenous welding.

in the spoke. While the casting is in such heated state, the welding of the crack should be completed in the regular prescribed manner of welding such material (Fig. 58).

Value of Preheating.—

In this manner, the stresses, which occur when the piece under treatment gets cold and shrinks, may be avoided. The pre-heating of the material transforms such tensions into pressure strains which are

much more favourable to the cast material.

The co-efficient of tension for cast iron is 0.014%; i.e., for every increase of 100° C. in temperature, there is an increase in the mass of the object equal to 1.4 m/m for each metre length. As the melting point of cast iron is 1050° C. it is evident that the total expansion of the material from freezing point (0° C.) to the molten state is 1.4 x 10.5 or 14.7 m/m for each metre length.

Expansion.— The conductivity of cast iron is comparatively low and as the stretching is distributed over the material within reach of the heating, it may be assumed that this tension value of 14.7 has to be di-

vided by 2 in order to obtain an approximately correct figure. Therefore for each metre length (39.37 inches) of the mass heated, by a portion being raised to the melting point, a stretching of 7.35 m/m ($19/64$ inches) results, i.e. about $3/32$ inches for each foot in length, and in the portions outside but rigidly connected to the welding area a crushing of the material for about 5 m/m occurs during the welding operation.

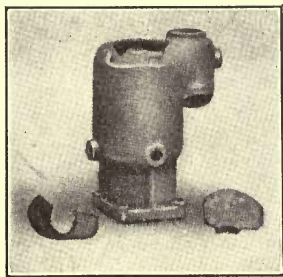

FIG. 59

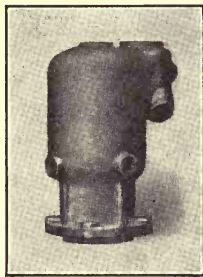

FIG. 60

Figs. 59-60.—Broken motor cylinder and same after having been repaired by autogenous welding.

The material which is thus compressed during the welding is also subjected to as equally great tension due to shrinkage of mass when cooling. This stretching in cast iron objects exists in two dimensions in a plane and in three dimensions in a solid.

Prevention of Cracks.—To prevent subsequent formation of fissures, it is absolutely necessary to previously heat all material affected by the expansion or, better still, to heat the whole casting equally to a dull red, except where a loose piece is to be welded on one end only.

The whole mass in this manner undergoes such a universal stretching that the local surplus of heat occasioned by the welding operation has no appreciable effect in expansion.

Repairing Complex Castings. — For the welding of a complex casting, as for example, a motor car cylinder, it is advisable to bring the material into a dull red state by a slow fire, in a suitable furnace, so that the heat penetrates the whole mass.

While the casting is in such heated state it should be removed from the furnace and the fissure welded

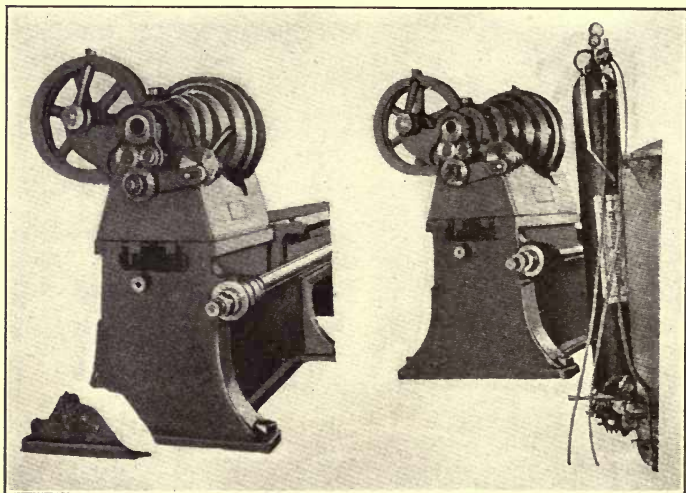

FIG. 61

FIG. 62

Figs. 61-62. — Broken machine support and same after having been repaired by autogenous welding.

as quickly as possible and then be immediately returned to the furnace so that it can be again heated as previously, before being finally allowed to cool. It may be safely expected in the welding operations so executed that no tensions or formation of new fissures will occur in the cooling down process (Figs. 59, 60).

Repairing Large Castings. — When repairing broken corners of engine bases and machinery beds or similar

work, the material in the welding area should be suitably prepared and the welding started in the middle part of the fracture and continued to either end. When one half of the welding has been completed the whole mass should be allowed to get cold before the remainder of the work is executed, for if this is not done the appearance of a new crack may be expected during the second part of the operation (Figs. 61, 62).

In this treatise only general points of view can be given, but a welder will always be able with the assistance of these data, to determine whether the autogenous method can be employed and how such repairs should be executed.

CHAPTER IX

WELDING OF SHEET IRON

THE method employed in the welding of sheets of mild steel varies according to the nature and thickness of the material worked upon.

In the welding of thin sheets the seam is exposed to different temperatures of the flame and, in consequence of this, a slow drop in temperature occurs immediately upon the metal becoming rigid, so there is no danger of the metal in the welding seam becoming brittle.

The welding of very thin sheets such as a thickness of $\frac{1}{2}$ m/m (.02 inches) can be facilitated by turning

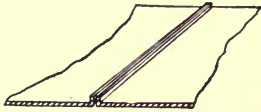

FIG. 63.— Thin sheets flanged preparatory for welding.

up the edges of the sheets so as to leave a small flange of perhaps 3 m/m (.12 inches) in height at the place of union (Fig. 63).

The application of the welding flame to both flanges simultaneously serves to fuse one with another effectively joining the two sheets and in this manner the flanges, being melted down, replace the bar of filling material used in heavier sheets.

This method of working is used in all cases where the manufacture of stamped work is accomplished by uniting sections of sheet metal, previously cut for the purpose. Also, in the manufacture of cylindrical sections, it is usual to leave a flange or rib, where the sheets are to be joined and then to melt down this rib on the cylindrical surface.

In such work it is advisable to tack the pieces together by welding the edges of the flange at intervals of about 100 m/m (4 inches) before melting down the whole flange. In the tacking process, the flanges are held together with clamps, in order to secure the correct relative position of the sheets.

Flanging of Sheets. — In the manufacture of stamped sheet-steel articles, the flange is formed during the stamping process.

This method of flanging sheets at the welding place is extensively employed in the manufacture of thin sheet metal articles (Fig. 64) and also in the construction of large vessels where thicker sheets are used.

The latter are usually vertical cylindrical tanks built up of sheets of varying thickness according to the different service conditions. As the pressure of the liquid contents of a vessel varies at different heights, sheets are employed according to requirements and become thinner upwards from the bottom.

If the edges of the sheets are turned at right angles for about 25 m/m (1 inch), the welding can be made upon the outer edges of the rib itself. In this case the double layer of sheet remains as a support which serves to give the whole vessel greater strength and power of resistance.

If the thickness of the sheet exceeds 3 m/m ($\frac{1}{8}$ inch), it becomes necessary to bevel the edges, so as to allow a perfect welding through the whole thickness of the material. In this case however, it is necessary to em-

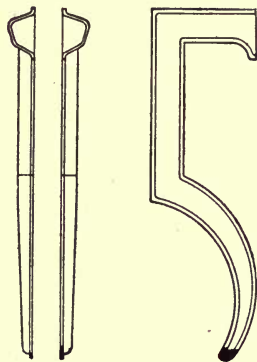

FIG. 64.— Sectional views of stampings of thin sheet metal with flanges for welding purposes.

ploy other metal for supplying the material lacking to fill up the welding groove. For such purposes, it is usual to employ a soft Swedish charcoal iron drawn into wire.

In welding thin sheets, it is advisable to keep the filling wire in the direction of the welding seam so that it is possible to melt it directly into the groove. For this process a certain experience is required but, if one is not too easily discouraged, he will soon acquire the proper way of doing this kind of work.

Welding of Very Thin Sheets.— If still thinner pieces of sheet are to be united, the edges are usually

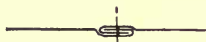

FIG. 65.— Double hook used in welding of very thin sheets.

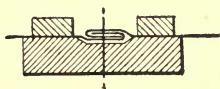

FIG. 66.— Diagram showing application of heat-absorbing blocks to prevent overheating in the welding of very thin sheets.

hooked together by a hemming operation (Fig. 65). Before applying the welding flame the hem is superimposed upon a block of material which possesses great heat conductivity and sufficiently large to be effective.

As will be seen in the accompanying illustration (Fig. 66), the parts to be joined lie in a groove in the block and, as the material is in several layers, the welding can be carried out without danger of burning the metal.

In performing this work the torch should be held at as sharp an angle as possible as, in that manner, a larger thickness of material is placed in the direction of the axis of the welding flame. In such operations, it is of advantage to make the heated areas of the material as small as possible as this prevents the material becoming warped and distorted.

Position of Welding Torch.— As the sheets become thicker the position of the burner must be more ver-

tical to the work. The correct adjustment of the flame is of great importance for these operations and great care should be taken to insure that the flame has neither an excess of oxygen nor of acetylene. It is also important that the material is struck by the flame in welding so that the inner cone of the flame is from 3 to 5 m/m ($\frac{1}{8}$ to $\frac{3}{16}$ inches) from the sheet.

In the welding of sheets of from 2 to 3 m/m in thickness, the burner has to be so placed that it meets the welding seam approximately under an angle of 45° .



FIG. 67.—Butting together the edges of sheets for welding purposes. This method is satisfactory for sheets up to $\frac{3}{32}$ inch in thickness.

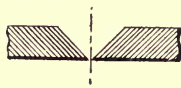

FIG. 68.—Bevelling the edges of thick sheets for welding purposes. This method should be used on sheets having a thickness of $\frac{1}{8}$ inch or over.

Often in industrial work, a thorough welding of the seam is obtained in sheets up to a thickness of 5 m/m ($\frac{3}{16}$ inches) without the previous bevelling of the edges of the sheets. This however is a matter of individual ability and those who are not experienced in the autogenous welding process should always bevel the edges of the sheets, if they are more than 3 m/m (Figs. 67, 68, 69).

Unless thick sheets are bevelled, the union, in the groove of the welding seam, is not reliable and the places which are not properly joined act as a fissure which permit the easy breaking of the weld.

Failures of Welds.—In different cases, such imperfect welding has been the cause of the rupture of ves-



FIG. 69.—Double bevelling of edges of very thick sheets ($\frac{1}{2}$ inch or over) for welding purposes.

sels subjected to pressure and thence deductions were drawn unfavourable to the fitness of autogenous welding in general. But this was of course perfectly erroneous, as in these cases, the conclusion can only be drawn as to the imperfect way the process was handled (Figs. 70, 71, 72, 73, 74, 75, 76, 77).

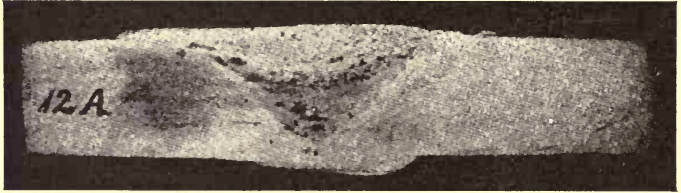

FIG. 70. — Evidence of superheating of a welding seam.

In the case of fire, or ordinary blacksmith welding, such imperfect welds will occur if the process is unskillfully handled, and this will frequently be the case where thick materials are welded in a fire.

In welding thick sheets of mild steel, the heat stored, in the adjoining parts of the sheet, is sufficient to prevent the welding seam from cooling down too rapidly and thus becoming hard or brittle.

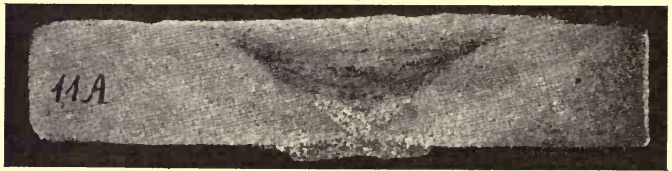

FIG. 71.— Excessive superheating in lower part of a welding seam.

Existence of Oxides. — In the slow cooling of the welding seam, where films of the oxide remain in the mass, there is a danger that the temperature of the material gets below the melting point of these oxides before the latter are destroyed. These oxides,

when included in the material, arrange themselves across the direction of the rolling of the metal and thus endanger considerably the strength of the metal in the weld.

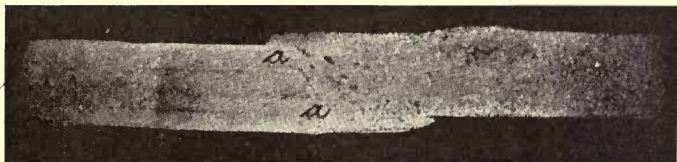

FIG. 72.— Evidence of superheating of a welding seam and unwelded spots (a. a.).

In order to avoid such a condition, the following method should be employed in the welding of sheets that are later on to be subjected to heavy pressure. Before the welding operation is commenced, the material adjoining the parts to be joined should be heated up to red heat, by the welding flame, thereby surrounding the place of union with a zone of heated metal.



FIG. 73.— Superheated and carbonized welding seam containing foreign matter (a. b. c.).

As this heat is therefore conducted to the parts to be welded during the operation, it is evident that there is an increase of heat at the weld rather than a loss of heat which would occur otherwise. The welding can then be effected with comparative rapidity

as the material welded remains under the influence of the welding flame a much shorter time and the danger of the temperature of the metal falling below the melting point of the oxides is avoided.

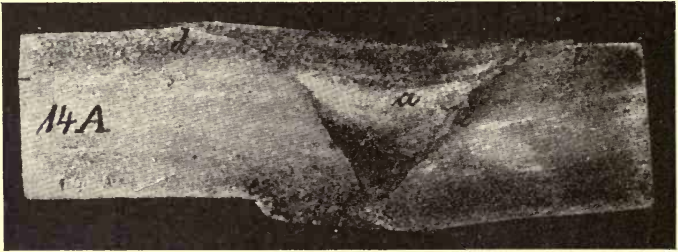

FIG. 74.— Imperfect, superheated, and carbonized welding seam.

Magnetic Properties of Iron.— Iron has the peculiarity to lose its magnetism at a temperature close to 700° C. or 1300° F.

In the welding of heavy sheets which are afterwards subject to exacting conditions, the welded parts should be heated by the flame after the welding operation is completed. Such subsequent heating has the effect that the structure of the material receives an important refinement.



FIG. 75.— Fracture in a welding seam as the result of improper welding.

In such a procedure it is necessary that between the heating immediately previous to the welding and the exposure to the flame subsequent to the operation a complete cooling down to a temperature not to exceed 20° C. (98° F.) occurs for effective results. The

second heating should raise the temperature of the welded part to not less than 700° C. or 1292° F.

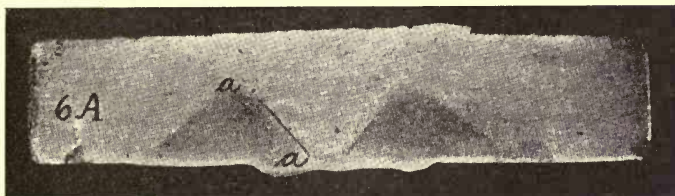

FIG. 76.— Unwelded place in seam (a-a) in consequence of improper holding of the burner.

Value of Reheating.— For example, in two welds made in the same sheet, with equal care and under similar conditions, the difference in results may be easily recognised if one is allowed to cool down completely and the other is reheated by the flame after the temperature lowers to approximately 20° C. or 98° F.

Upon breaking the two welding seams, it will be found that the fracture of material of the welding seam, which has not been heated the second time, is composed of coarse crystals, while the fracture of the



FIG. 77.— Example of bad welding.

reheated weld will consist of fine grains with fibres running through the metal. This change of material takes place at the temperature at which the iron loses its magnetism and it would mean a loss of energy and heat if the second heat exposure is continued to produce a higher temperature than is absolutely necessary.

A process has, however, been developed which makes it possible to prevent a superfluous heating of material during the second exposure and to prevent the loss of heat and time consequent upon it.

Test of Magnetism. — By taking a common horseshoe magnet (Fig. 78), the testing of the magnetic properties of the welding spot during the second exposure can be accomplished. As soon as the magnetism disappears, the heating of the welded area should cease.

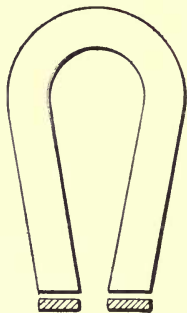

Fig. 78. — Horseshoe magnet for testing the magnetic properties of heated iron.

Such second heating of the welding seams should be carefully done in all sheets which are later on subjected to pressures, especially in the repairing and manufacturing of steam boilers.

Puddling Process. — In welding heavy material which is later on subjected to exacting conditions, it is necessary that the welding seam during its creation be subjected to a process of refining which corresponds to the process known in steel works as “puddling.”

After due preparatory heating, the workman starts welding in the bottom of the V shaped groove formed by the two bevelled edges, but he must be sure that the welding flow shows a smoothness in the bath. Contents of oxide betray their presence by a somewhat darker condition in the fused material which may be noticed by a trained eye. When the welder notices a darker spot in the molten material he should turn the effective part of the welding flame upon it so that the oxide may be reduced to metallic iron.

After the welder has built up the lowest part of the welding trough to a thickness of 5 m/m (3/16

inches), he starts gently hammering the molten metal by a small hammer with piens of such shape to enable the metal to be reached at the base of the groove (Fig. 79). The playing of the welding flame simultaneously with the hammering is continued during the building up of the welding seam to its full thickness and it corresponds to a kind of puddling. During this operation it is necessary to cool the head of the hammer from time to time, by immersion in water, and thus prevent its destruction by the flame.

Improvement in Material. — By these means, densification of the material and an increased strength is obtained. After the whole welding groove has been built up with filling material, it is common practice to effect a smoothening of the surface by using a small hammer, with a contact of not to exceed 8 m/m, which hammer may also be plunged in water for cooling.

It is essential to successful operation that this kind of hammering is done while the welding seam is at a bright red heat. If the welding seam is worked upon, while at a temperature below the red glow of the material, or with a larger hammer, internal fractures of the metal occur which damage the welding seam. Upon the right kind of hammering, the quality of the welding seam depends to a large extent (Figs. 80, 81).

Use of Two Welding Torches. — In the case of very thick sheets, the welding may be performed by welding flames on both sides of the sheet operated simultaneously, but great care and strict observance of the

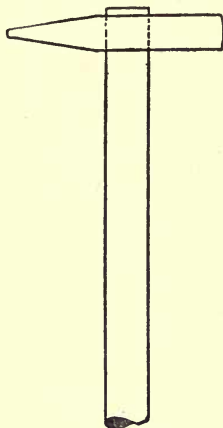

FIG. 79. — Puddling hammer.

above mentioned rules is necessary for satisfactory results. The edges of the sheets must be bevelled upon both sides and the welding will be performed to the best advantage with the sheets in a vertical or horizontal position (Fig. 82).



FIG. 80.— Photograph showing disappearance of burned particles which had been contained in the welding seam.

While there is always a mass of molten metal which would flow back into the groove formed, when the welding flame is played from above, a dropping away of the molten iron will occur in vertical welding and in consequence great difficulties arise in such work.



FIG. 81.— Photograph showing disappearance of burned particles which had been contained in a double-sided welding seam.

Vertical and Overhead Welding.— In executing vertical welding, or when a workman, lying on his back, has to weld the sheet from underneath, the dropping away of the molten iron can be prevented in the following manner:

The area adjoining the welding place is heated until the metal is white hot and, when this condition is secured, the flame is played upon the weld while simultaneously the filling wire is inserted in the welding groove. At such a high temperature, the adhesion of the material influences the molten portion of the filling wire so that the latter spreads itself out upon

the surface of the material, in homogeneous compound, and thereby the formation of drops is avoided.



FIG. 82.— Double weld in a very thick mild steel sheet.

It is in this manner that experienced welders are able to execute, with equal ease, the repairs of boilers in any and every position that is required.

CHAPTER X

MANUFACTURE AND REPAIRS OF BOILERS

THE autogenous welding process is variously applied to the repairs of boilers. In such work the strains imposed upon the places to be repaired have to be carefully considered, since, under service conditions, the material of a boiler is subjected to constant alterations resulting from changes of temperature and position.

Effect of Temperature Variations. — The structural appearance of mild steel sheets varies with the temperature of the metal. The same material, which is coarse grained in a cold state, will be finely grained and fibrous at the usual service temperature of modern boilers of 200° C. to 300° C. (392° F. to 572° F.). This is the reason why the power of resistance in the material of boilers is always greater at certain higher temperatures.

Failures of boilers often result from the usual manner of joining of overlapping sheets which consists of piercing the two sheets and inserting rivets. In the furnace, for example, the sheet exposed to the flame acts as a receiver of heat, and the second sheet as a conductor of heat, the double thickness of sheet somewhat retarding the passage of heat to the water.

Causes of Failures. — If the one sheet is much heated by the flame it must expand to a greater extent than the other sheet, which is kept nearly of the same temperature as the water around it. In a cold state, the connecting rivets will stand parallel

to each other, but, when the two sheets are heated to unequal temperatures, a straining of the rivets will occur, since they pass from a parallel to a converging position.

Further while the boiler is in service the inner surface of the fire tubes will remain of nearly equal temperature so long as the fire door is kept closed, but each time the door is opened a cold air current will enter the fire tube and cause the material to cool down and shrink. These fluctuations of temperature impose considerable strains upon the material, but particularly upon the rivets.

It is apparent therefore that the rivet holes must eventually become oval shaped and permit the water to enter the unoccupied space causing a corrosion of the material, which defects finally assume such proportions that the boiler has to be taken out of service.

Change of Methods.—As other methods of joining sheets were unknown, in the beginning of the boiler making industry, it was necessary to employ rivetting notwithstanding these defects. The process has been so developed and perfected that it will now be rather difficult, if at all possible, to replace the rivetting of boilers by autogenous welding.

When a method of examining an autogenous welding seam has been devised by which the quality of the seam can be reliably determined without injuring the metal, it is probable that the welding process will be more generally employed in the construction of boilers.

For the present, however, such welding method furnishes an economical and reliable means of repairing the corrosions and fractures which occur in boilers, during their use.

To repair worn rivet holes, the adjacent rivets must be removed for a distance of from 300 m/m to 500

m/m (12 to 20 inches) in order to permit the material to stretch freely during the local heating caused by the welding and also to permit a free shrinking during the cooling down of the metal.

Welding of Cracks.—The same applies to the welding of cracks. Cracks in boiler sheets are usually caused by bending strains on the material consequent upon alternate internal pressures, and they are quite common in the places where such strains exist.

When a crack is to be welded autogenously suitable preparation must be made to prevent the expansion of the adjoining portions of the sheet toward the welding seam. As the metal has to be transformed into a plastic and liquid state, it is evident that such expansion would result in the material of the welding seam being compressed and forced out during the operation.

Crack welding executed in this manner would cause, during the cooling period, a shrinkage of the material in direct relation to the fall of temperature. The welded place would be compelled to stand such an extraordinarily strong pull as to be torn open again.

Avoidance of Strains.—It is therefore very necessary that subsequent strains in the welding seam during the cooling down process be avoided. In welding a crack in a boiler sheet it is advisable, after the necessary cutting away of the material, to drive a chisel or other wedge into the fissure to further expand it, in which case tension will exist in the adjoining portions.

If, while such tension exists, the welding is completed to the place where the chisel is inserted, a pressure on the adjoining material must result, instead of a pull, when the chisel is removed. It is then possible to entirely weld up the place of the fissure in which the chisel was placed without fear of another fissure forming.

Benefit of Preheating. — Another very satisfactory method is for the welder to heat the edges of the fissure with the flame until they become plastic and then proceed to heat the adjoining portions of the sheet. The result is that the metal expands toward the edges of the fissure and in consequence, the plastic material is pressed out. The sheet is then allowed to cool down completely and the unfused material returns to its original position, leaving a wide slot-shaped opening in place of the crack.

When the cooling down is completed, the welder, by inserting the filling bar into the middle of the slot and welding a small central portion, is then able to proceed with the welding from either end of the fissure toward the centre. In this case, the filling bar, which is molten in, takes the place of the chisel in the previously mentioned process.

To prevent the crack from extending further a hole should be drilled at each end.

Welding in Patches. — Cracks in boilers usually occur where the material has to give way to a bending strain in a certain direction and if it can be avoided, the welding seam should not be placed in the line of such strain. It is more advisable, in many cases, to cut out a part of the boiler sheet and insert a new piece instead of welding up a fissure, which piece should be inserted so that the new material occupies a position in the line of strain.

In the welding in of a patch, it is also of advantage to avoid sharp corners in the piece applied, as such corners often serve as a starting place for other fissures. The corners should therefore be rounded off and those of the piece applied be fitted in a corresponding manner.

Method of Welding. — In welding in such a piece it is necessary to start the welding from a definite

point usually in the centre of one side, and to weld from this centre to either end of the straight line. The subsequent welding must be on the side adjoining the first part so that in a quadrangular piece the two sides forming an angle are welded first.

The whole piece should then be allowed to cool and into the middle of the angle which is not yet welded, a chisel should be driven and the material forced apart. Or, a filling bar should be welded in so that the stretching of the material, in the welded in piece, is prevented during the latter part of the operation. The welding of the last side is identical with the method of welding a fissure described above.

Advantage of Dishing. — In such repairs, the piece of sheet which is to be inserted may also be somewhat “dished” in the centre and if a piece so prepared is welded into a boiler shell it will be found that the “dished” part becomes straightened upon cooling, in which manner tensions are prevented.

Of course, such welding procedures of importance must only be entrusted to workmen with experience on similar work and if possible only to those who have been trained for repair work on boilers exclusively.

Puddling Process. — In executing this kind of work, the adjoining portions of the sheet should be heated to effect a transfer of heat to the welding place from the adjoining portions instead of allowing a loss of heat. In boiler repair work the welder can also, with advantage, employ the previously mentioned “puddling” process where the metal is worked by means of small hammers in conjunction with the application of the welding flame.

A very common operation is the repair of furnaces, as frequently the corrugations of the furnace tube, with the use of certain water, have corrosions formed of sufficient depth eventually to render the boiler useless.

Repairing Corroded Tubes.— These corrosions are often found in great numbers on the water side of fire tubes and furnaces. The welder during such work should keep the fire door and chimney of the boiler closed to prevent the cooling down of the material by an occasional air current, which would spoil the success of the welding.

This work puts great physical strains upon the welders and in many cases these operations must be executed by two alternating gangs of workmen, the working periods often not exceeding 20 minutes. It is of great importance that such work be completed without interruption as otherwise strains occur, and other consequences follow, which are injurious to the welding.

CHAPTER XI

MANUFACTURE OF CYLINDRICAL VESSELS

IN welding the horizontal seams in cylindrical sections of thin sheets, it is of advantage to employ a railway rail or similar device in the top of which a slot is cut lengthwise about 20 m/m wide by 5 m/m deep (about $\frac{3}{4}$ x 3/16 inches). The rolled sheet is placed upon the

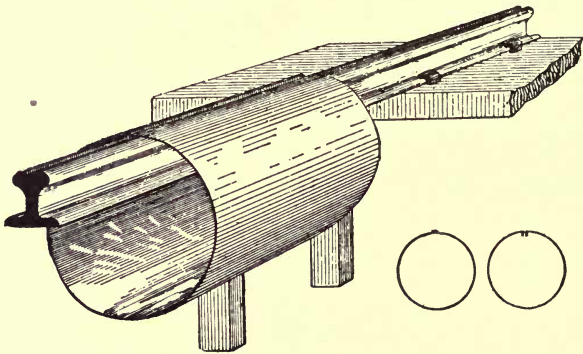

FIG. 83. — Method of using supporting rail in welding longitudinal seam in a cylindrical section of thin sheets. Also diagrams showing two methods of flanging the sheets for welding.

rail in such a manner that the flanges to be joined lie in the middle of this slot while the sheet itself is imposed upon the rail top at either side (Fig. 83).

During the welding process, the major part of the heat supplied to the sheet is thus conducted into the top of the rail so that undesirable stretchings or warpings of the sheet are prevented. In such welding rails

there is also special apparatus for carrying the sheet along during the operation.

Welding of Horizontal Seams.—In the welding of cylindrical sections of heavy sheets, it is necessary to take the expansion into careful consideration. If two sheets are to be welded lengthwise, local stretchings of the material adjacent to the welding seam will occur in consequence of the heat conducted from the welding flame. This expansion disappears again when the welded mass cools down.

If the sheets are convexly inclined to each other, there will be two components of force acting from either side towards the welding place as a result of the expansion of the sheets. The material at the welding place is thus compressed and is lacking when the mass cools down and shrinks.

At the same time a warping of the sheet edges occurs in front of the welding place, and so it may easily happen that the edges are pushed one above the other, in front of the welding seam.

In such a condition the article is useless and un-serviceable, for if attempt is made to bring the sheet back to its original position by inserting a pin in front of the welding seam the result will be that the entire section will become distorted.

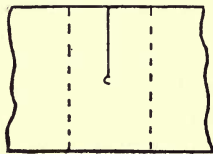

FIG. 84.—Diagram showing sheet prepared for demonstration of tensions produced during the welding operation.

This phenomenon can be easily reproduced if one punches a hole in the middle of a sheet and severs the sheet from the hole to one edge. By heating the area around the hole, the area of the cut will be converted from a rectangular to a triangular shape (Fig. 84).

If the welding proceeded from the edge to the hole,

the welding at the sheet edge however good, would always burst open as the welding approached the middle of the sheet (Fig. 85). For

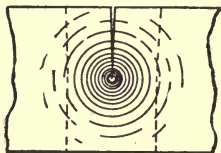

FIG. 85.— Diagram showing the effect of expansion in a sheet under the influence of the welding flame.

this reason it is necessary to keep open that portion of the sheet which is opposed to the place where the welding begins.

It is, therefore, best to insert a drift pin by means of which it is always possible to bring the sheets into the proper relative position.

This pin has to be moved on as the welding proceeds and is finally removed only when it is necessary so that the welding may be finished (Fig. 86).

Welding of Circumferential Seams.— Similar precautions must be taken in the welding of circumferential seams, as it is beneficial to place the edges of the

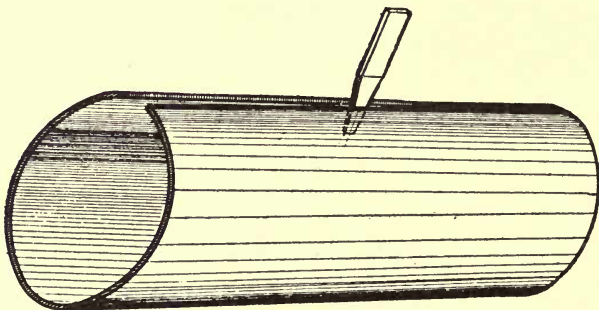

FIG. 86.— Method of preserving the correct alignment of the edges of sheets during the welding operation.

sheets at a distance of about 2 to 5 m/m (.08 to .2 inches) from one another according to the thickness of the material. This is best accomplished by securing the sheets with clamps so placed as to preserve the

correct alignment and also to keep them the proper distance apart (Figs. 87 and 88).

In this position, the sheet sections should be tacked together between the clamps by melting down filling material every few inches in order to give the mass a firm position. When this has been done, the seam can be safely welded without fear of cracking or warping, for the material of the sheets is then placed at a constant distance from each other and the movement of one cannot handicap the movement of the other.

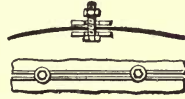

FIG. 87.— Use of clamps for holding edges of sheets in correct position for welding purposes.

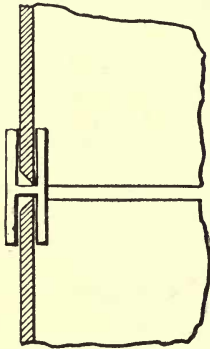

FIG. 88.— Diagram showing use of jig for maintaining correct alignment and distance during the welding of vertical cylindrical sections.

Device for Welding Heavy Sheets. — Where large and heavy sheet sections are to be made, it is of advantage to employ a stretching ring, of U shaped cross-section and a radius somewhat less than that of the inner area of the sheet section (Fig. 89). This ring must be open on one side and provided with an

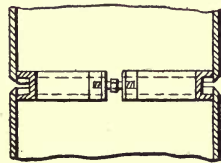

FIG. 89. — Mandrel for use in welding circumferential seams in cylindrical sections.

arrangement for adjusting it when properly placed, so as to secure the correct position of the edges to be welded. The recess in the block permits the seam to be welded without affecting the device.

The stretching appliance may consist of two screws with left and right threads and hexagonal nuts or

turnbuckles of suitable dimensions, which are adjusted after both sheet sections have been drawn up on the rings. The two sides of the U iron segments thus press against the inner side of the sheets and serve to place the edges in the right position toward each other. Such a stretching ring has a similar action as the welding rail fitted with a lengthwise groove.

Bevelling of the Sheets.—As mentioned above, it is necessary to bevel the edge of the sheets, if thorough welding of thick sheets is to be accomplished. In factories, where such operations are regularly performed, the sheets are bevelled previous to the rolling of the sheet, if the necessary appliances are at hand. This, however, cannot always be done, and it is then advisable to bevel the sheets with an electric grinder.

In the manufacture of large cylindrical vessels, the individual sections, which are to be welded together by circumferential seams, are commonly rested upon supports in which spools are inserted so that the whole body can be easily rolled.

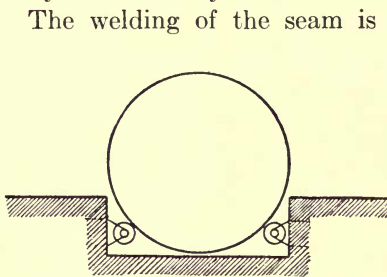

FIG. 90.—Diagram of pit equipped with rolls for welding circumferential seams.

The welding of the seam is executed either from a scaffold covering the vessel or a pit is provided in the floor of the workshop whereby the workman is enabled to be seated during the operation and to turn the body round upon the rolls as the welding proceeds (Fig. 90).

An efficient welder, when he observes the existence of oxide films in the welding place, should either destroy these mechanically by the filling bar or lift them to

the surface of the molten mass. This necessitates very strict watching of the molten mass by the welder.

If heavy sheets are to be welded the workman must also stir the molten mass, with the filling bar, after the edges of the sheets are well molten under the influence of the welding flame.

Joining Pieces of Different Cross Sections. — In industry, it is frequently necessary to weld together two sheets of different cross-section. In such cases the welder should first heat up the heavier piece to its melting temperature, allowing the other piece to be heated indirectly. Then he should sweep the thinner piece with the welding flame, until the melting point of it also has been reached, and thus thoroughly fuse together the material of both pieces (Fig. 91).

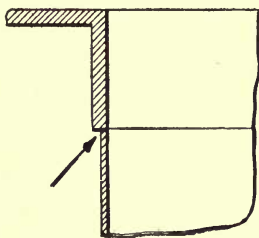

FIG. 91.— Method of welding together two sheets of different thickness.

In this manner a good weld can be secured, but proper care should be used, as the melting of the heavier part demands a greater amount of heat than the lighter part.

A very common operation is the welding of an angle iron ring for an upper joint or cover connection on sheet metal vessels. A difficulty encountered is that in the welding process, one side of the angle iron stretches more than the other, the consequent distortion making the iron arc-shaped so that it has to be forcibly pressed down upon the edge of the sheet (Fig. 92).

Application of Joint Rings. — It is apparent that under such circumstances great tensions remain in the welding seam. To prevent this, it is necessary to

heat the upper side of the ring also by the welding flame during the welding operation, so that an equal

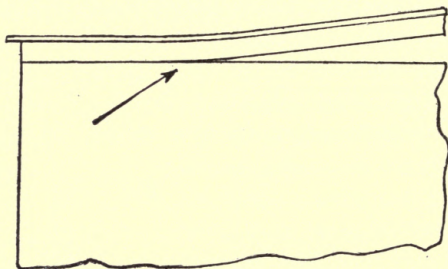

FIG. 92.—Warping of an angle-ring during the welding-on operation.

stretching of the material is obtained in both sections. The welding must be accomplished during this state of equal stretching (Fig. 93).

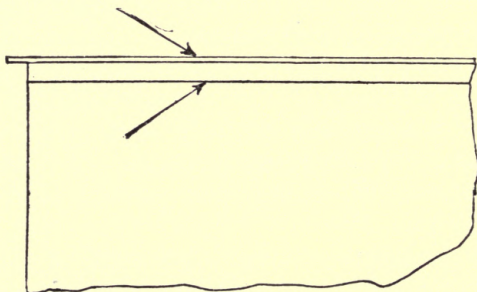

FIG. 93.—Diagram showing the relative positions of the welding burner to secure the simultaneous heating of both sections of an angle-ring to prevent warping.

In welding such rings upon sheet vessels, allowance has to be made for the thickness of the material of the ring being considerably greater than that of the sheet. For this reason it is necessary to direct the welding flame chiefly upon the part in which the ma-

terial is stronger, as it is only after the surface of the heavier material reaches a molten state that the fusing of it with the sheet material can be effected.

Manufacture of Closed Cylindrical Vessels. — In manufacturing cylindrical vessels with rounded ends it is common practice where this part is not exposed to special strains to weld an ordinary raised head on the end of the cylindrical shell. Such work is similar to the welding together of two cylindrical sections, although at times it is advantageous to flange both the cover and shell sheets previous to the welding operation.

Such method of executing the work however is permissible only if the vessel is not subjected to extensive internal strains.

All vessels under the influence of an internal pressure have the tendency to assume a shape approaching that of a sphere. The pressure tends to increase the diameter of the cylindrical part of the vessel in the centre and to press the cover outwards. Therefore, if in such a vessel the welding occurs immediately at the end of the cylindrical section the welding seam is subjected to unequal strains. Under the influence of the pressure exerted inside of the vessel the outer edge of the welding seam suffers an unusual compression strain, while the inner edge has to stand considerable pulling strain (Fig. 94).

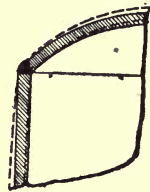

FIG. 94. — Convex head welded on cylinder with dotted lines to indicate the change of shape under the pressure strain.

Internal Strains. — It is well known in the design and construction of boilers that a bending strain must be neutralized by the radial turning up of the sheet. In the cover and in the cylindrical section of such vessels, the internal pressure pulls upon the

whole longitudinal section of the welding seam. For this reason the edge of this cover must be extended cylindrically so as to place the welding area in the cylindrical portion of the vessel (Fig. 95).

It is possible also to replace the bending strain in the welding seam with a pulling strain by forcing in the upper edge of the cylinder body and inserting a cover

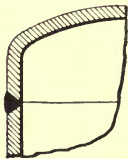

FIG. 95. — Method of applying cylinder head so that the welding seam will be exposed to tension.

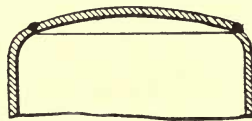

FIG. 96.— Cylinder end with diameter reduced to permit head to be applied so as to obtain a pulling strain in the welding seam.

somewhat smaller than the inner diameter of the cylinder. The end of the cylindrical section is slowly heated by the welding flame and drawn in so as to diminish the inner diameter at that point. When this has been accomplished the cover is inserted and welded to the cylindrical section in the usual manner (Fig. 96).

This practice is particularly common in the ship building industry.

Application of Bottom. — The usual method for applying the lower head in cylindrical vessels is to form an arched head, with the outside diameter slightly less than the inner diameter of the cylinder, and to rivet it to the cylindrical

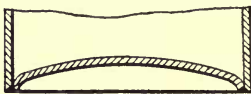

FIG. 97. — Raised inserted head applied to a cylinder by autogenous welding.

body so that the raised part of the head extends upwards (Fig. 97).

This method is so much in use that it is generally

considered to be the one technically correct, but, the fact is, that there is no other means of rivetting as the interior of the vessel is no longer accessible.

It will therefore want a certain reversal of practice before such method of construction is abandoned in favor of the autogenous welding. The welding method must therefore, for a time at least, subordinate itself to the existing conceptions of construction.

The application of a raised bottom by welding is accomplished by first welding, or tacking, two places of the circumferential seam which are diametrically opposite and then, diagonally to the axis of these places, to tack in a similar manner two others. This tacking is then continued at spaces of about 200 m/m (8 inches) until the entire circumference has been so treated and then the welding of the entire seam can be executed.

Annular Welding.—The necessity of this tacking is due to the fact that in autogenous welding the expansion stress of the material is greater in the cylindrical section than in the unpliant bottom sheet. If this annular welding were undertaken without previous tacking, the external sheet would expand as the welding proceeded until it would be forced away from the head in the shape of an arc which could by no means be readjusted.

The metal in the welding seam would have become useless, while, in the welding area, tensions would remain acting in the opposite direction; all of which is avoided by previous tacking of the seam.

The following method can also be employed: If a heavy ring of material, possessing great heat conductivity, is placed around the outer sheet immediately above the welding seam, much of the heat infused into the sheet by the welding flame will be absorbed by this extra material. The infused heat will therefore

be distributed over a larger volume of material and excessive stretching will be prevented (Fig. 98). The

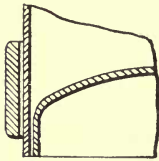

FIG. 98. — Method of using heat-absorbing plate to reduce tensions during the operation of welding on a head.

most effective material for such a ring is copper, although iron may, at times, be sufficient for the purpose.

In vessels of this type it is usual to provide the lower bottom sheet of greater thickness than that of the cylindrical portion and it is accepted as a standard that both lower and upper heads shall each be $1\frac{1}{2}$ times the thickness of the cylindrical sheet.

Liability of Corrosion. — If the vessel manufactured by this method stands upright during use, the welding seam will be situated at the extreme lower end of the vessel. As some allowance must always be made for the existence of surface moisture, it is possible that premature corrosion may occur in the seam, sufficient to damage the vessel. The following method has been evolved to prevent such a defect and at the same time secure increase in strength.

The method consists in heating the two lower edges of the sheet of the cylindrical vessel and its bottom by the welding flame after the bottom has been inserted. The application of heat permits the closing in of the edges of the sheets toward the centre, in the shape of an arc, and when the proper contour has been secured, the welding can be proceeded with in the usual manner. In this way the edge of the outer sheet is so drawn around that it absorbs a part of the strain caused by the internal pressure of the vessel (Fig. 99).

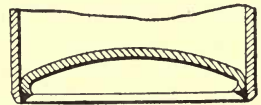

FIG. 99. — Drawing in the edges of a raised cylinder head for the purpose of increasing the strength of the weld.

The welding seam at the base of such vessels can be removed beyond the reach of corrosion, due to the collection of moisture around the exterior, by welding an angle iron ring on to the vessel below the welded area (Fig. 100). The proper way to manufacture such vessels consists, however, in inserting the top, as well as the bottom, in such a manner so that either welding seam is placed in the cylindrical part and this method has been

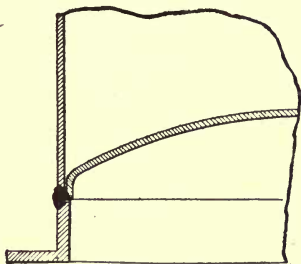

FIG. 100.— Angle-ring welded on the bottom of a cylindrical vessel.

generally accepted in such industry.

When a vessel thus manufactured is to be used in a vertical position, it is advisable to weld an angle iron ring to the external shell of the lower head to serve as a support to the vessel (Fig. 101).

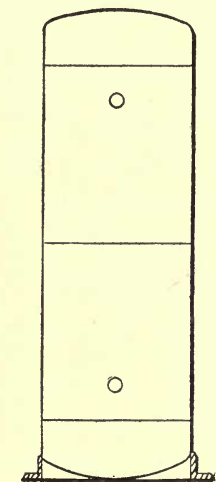

FIG. 101. — Support ring applied to a vertical cylindrical vessel.

If it is desired to apply either head of such vessels somewhat inside of the cylindrical portion, the diameter of the head, which has to be an exact fit, should be made slightly larger than the diameter of the shell. The outer sheet should then be heated externally so as to expand and permit the head to be easily inserted. The welding should be done while the external surface is still hot as, otherwise, there would be danger

of the welding seam bursting during the welding process.

Applying an Intermediate Head.— It sometimes becomes necessary to weld an intermediate head into a cylindrical vessel in a place that is otherwise inaccessible. Except in the case where particular strength and lightness are required, a flanged head can be placed within the cylinder into which a number of holes have

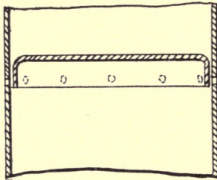

FIG. 102. — Inserting an intermediate head in a cylinder by means of hole-welding.

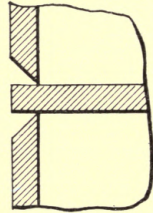

FIG. 103. — Inserting an intermediate head by cutting the cylinder into two sections.

been previously drilled. With ordinary care, the operator can, by inserting the torch through the holes, weld the inner intermediate head to the surface of the external cylinder shell, after which, the holes can be welded up (Fig. 102).

If the intermediate head has to be fitted absolutely tight and capable of resisting heavy pressure, it is advisable to cut the cylinder into two sections and to then place the head in position between them. By bevelling the edges of the sheets of both sections of the shell, the sections can be placed in the proper position and the welding executed in the usual manner (Fig. 103).

CHAPTER XII

MANUFACTURE OF RECTANGULAR VESSELS AND MISCELLANEOUS ARTICLES

IN the manufacture of cylindrical or dome shaped sheet vessels the expansion of the material can be absorbed without extensive deformation, but this is not the case where rectangular bodies are to be made.

Avoidance of Excessive Expansion. — The proper welding of flat sheets makes it imperative to avoid excessive heating of the material during the welding process, or to localize such heat upon those places which are not flat. The latter effect is obtained by providing the sheet body with a flange at the joining place, and then to weld upon the upper edge of this flange.

Position of Welding Torch. — If the welding is to be done in the corner of a rectangular vessel, it will be necessary to place the burner as much sideways as possible, in the direction in which the welding is to take place. It is thus possible to reduce to a minimum the amount of heat conducted into the adjoining flat parts of the vessel. If the burner were kept vertically upon the welding seam, the flame jet would be parted at the edge and thereby considerable areas would be heated and stretched so as to render warping of the sheet unavoidable after the cooling down.

Location of Seams. — If such a sheet is at an angle from the other sheet, it is advisable to place the union in the straight portion, at a distance of about 10 m/m

($\frac{3}{8}$ inches) from the edge. Also to keep the position of the burner, during the welding operation, so that the jet does not flatten itself upon the flat part, but plays against the corner.

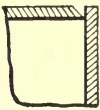

FIG. 104. — Method of welding on the cover of a rectangular sheet vessel.

The position of the burner is very essential for avoiding a warping of the sheet. In welding on a cover, or head, it is advisable to cut the cover larger by about 20 m/m ($\frac{3}{4}$ inches), and to bend a flange of about 10 m/m ($\frac{3}{8}$ inches) in width, as this permits the welding to be effected with the welding flame directed towards the flat part of the cover.

Manufacture of Safes. — In many industrial branches, as, for instance, the manufacture of safes, distortion of the sheets is not permitted. If, in such cases, the welding seam has to be placed in the corner, a heavy copper plate of sufficient dimensions should be laid upon the cover which is to be welded. The vertical sheet should also be covered with a heavy copper band placed below the welding seam (Fig. 104, 105).

By this arrangement, the excess heat during the welding operation passes from the seam to the copper plates, owing to the great heat conductivity of such metal, and the stretching or warping of the sheets is avoided.

Superheaters. — Autogenous welding is adapted for many purposes in the manufacture of heating appliances, as it provides an excellent means for joining the various parts, after they have been stamped, or cut, out of sheet metal, where

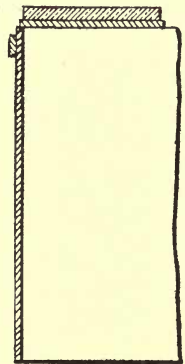

FIG. 105. — Application of heat-absorbing plates to prevent the warping of the sheets of a rectangular vessel during the welding operation.

rivetting would be unsatisfactory. This is true of superheating devices where the liquid or gas conducted through them is divided into the thinnest possible layers, in order that the higher heat otherwise given to the metal can be transmitted to the liquid or gas, so that the latter may become superheated accordingly (Fig. 106).

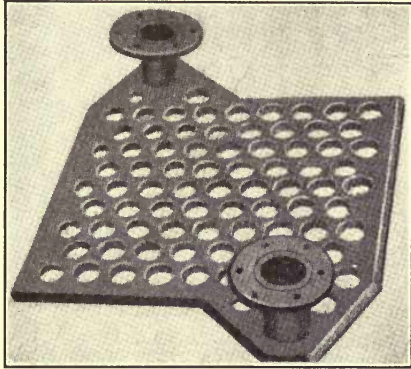

FIG. 106.— Tube sheet of superheater with autogenously welded pipe connections.

Radiators. — Radiators for house heating or similar apparatus of the most varied types, which are kept at a pre-determined temperature by circulating water or steam, are also manufactured from sheet metal by this method at considerable less cost than by methods formerly employed (Figs. 107 and 108).

In fact, the stamping out of pieces of sheet metal, the flanging of the edges of the plates to be welded and the welding of them, employs numerous designs of machinery and, not only now forms an important industry, but extensive developments may with reason be expected in the future.

Automobile and Aeronautical Motors. — A striking example of the scope of this work is the automobile motor shown in the accompanying illustration (Figs. 109 and 110). This is composed of two steel tubes, for the cylinders, and several stamped sheet metal pieces welded together to form the water jacket and fittings.

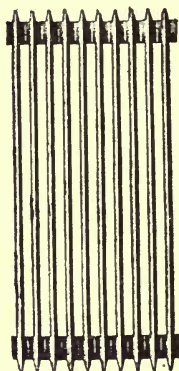

FIG. 107. — Portion of a radiator showing manner in which the individual sections are welded together.



FIG. 108. — Radiator constructed from sheets by means of autogenous welding.

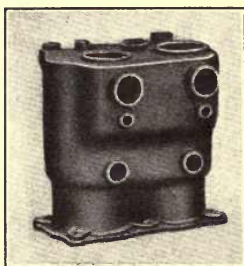

FIG. 109

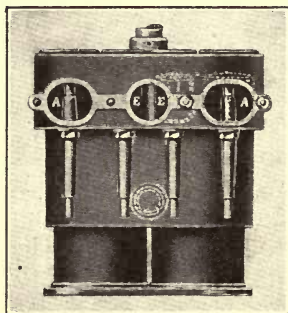

FIG. 110

FIGS. 109-110. — Two views of a motor cylinder made of stamped sheet sections autogenously welded together.

Such motor cylinders have a distinct advantage over those with cast iron bodies in that they possess greater strength with considerably less weight and the defects and service cracks experienced in cast iron cylinders are entirely avoided. Motors with any number of cylinders can be manufactured in this manner.

The stamping and welding method thus renders possible the production of articles of the most varied types and in each case it is a matter of determining the approximate cost, to decide upon the method to be employed.

When making sheet metal vessels it is often necessary to apply fittings for pipe or similar connections. Formerly this was accomplished by rivetting a suitable casting, or forging, on to the body, but such connections have many technical deficiencies.

Application of Pipe Fittings.— This form of connection has been replaced by the welding on of a boss of whatever metal is required for the purpose. In the production of this work, an experienced welder can build the boss of such shape and in such a manner that subse-



FIG. 111.— Boss welded on a sheet vessel for pipe connection.

quent surface finishing is unnecessary (Fig. 111). By boring a hole through the boss and the body sheet, which are then fused together, and cutting the necessary thread, a thoroughly satisfactory connection is secured into which the requisite pipes can be applied.

Manufacture of Double Shell Vessels.— For many industrial purposes vessels with double shells are employed as, for example, those which are heated by steam or hot water introduced into the interlying space between the two shells. The manufacture of such vessels has been much simplified by means of autogenous welding (Figs. 112–113).

The upper edge of the inside vessel should be bent toward the outside by means of a flanging machine, or by the hammering process, so that the outside diameter of the flange is equal to the outside diameter of the other vessel. The flanged portion of the inner vessel can then be welded to the edge of the outer

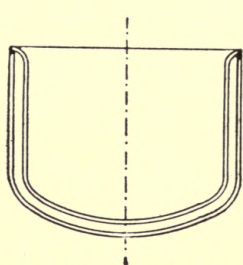

FIG. 112.— Double-shell vessel.

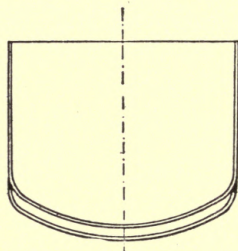

FIG. 113.— Vessel with double bottom.

vessel and undue tensions need not be feared in this operation.

Open Sheet Metal Vessels.— In the manufacture of open semi-circular sheet vessels, where the bottom and the sides are made out of one sheet, considerable economy can be effected by cutting out the corner in a similar manner to that shown herewith. The sheet, so cut out, can then be formed so that the edges of the end plate and the edges of the sides come directly against each other and can be welded in the usual manner (Figs. 114–115).

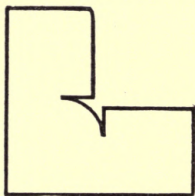

FIG. 114

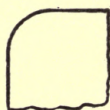

FIG. 115

FIGS. 114–115.— Diagram showing method of developing the corner of an open vessel made from a flat sheet by autogenous welding.

In actual practice, considerable difficulty is often experienced in the manufacture of cooking and similar utensils, resulting from the application of the spout.

When the spout, which has previously been made from two stamped pieces, is welded on, the sides of the vessel expand and thus cause blisters which spoil the general appearance.

Cooking Utensils. — If the hole cut in the vessel, at the place where the spout is to be fastened, is of smaller diameter than the spout to be applied, the material can be drawn out so that the outer edge fits exactly with the connecting edge of the spout. The welding on of the spout can then be not only more easily, but more neatly, done, as the place of welding is more accessible and the production of mis-shapen vessels is also avoided (Fig. 116).

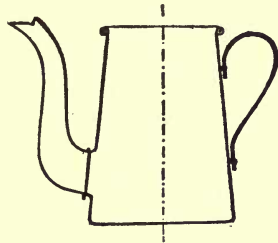

FIG. 116.— Method of applying a spout to a tea kettle by autogenous welding.

Ornamental Articles. — In addition to kitchen utensils, various special articles are manufactured as, for example, handles of ornamental vases of the most variegated kinds. Shells of pressed sheets are made for the handles of canes and umbrellas. These are later brought upon the market, after they have been enameled, engraved and inlaid with gold, silver and mother of pearl.

The welding method is also used for the manufacture of latch keys, door handles, window handles, gas stove appliances, apparatus for heating by the exchange of counter currents, connections for tube conduits, pistons, pedals for bicycles and articles of similar nature.

By means of autogenous welding the manufacture of many articles is made possible from standard shapes and sizes of commercial iron and one need only refer to one of the most important articles, as an illustration.

Window Frames.—Iron frames, for windows and doors, are used in very great quantities, in factory buildings. A simple frame of angle iron, such as is generally

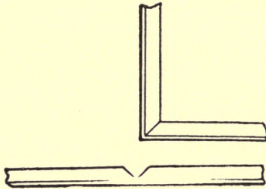

FIG. 117.— Method of cutting away an angle iron in the manufacture of a window frame by autogenous welding.

used for these windows can be made by taking the necessary length of iron and cutting out a portion of one side, at each corner to be made, as shown herewith (Fig. 117).

The frame is heated at each place and bent to a right angle so that the outer portion remains composed of undamaged material. The places of contact, formed by the bevel so cut at the corners, are then welded together autogenously and also any individual window braces that may be desired.

If there is sufficient length of iron for the entire frame, all of the cutting away for corners can be first accomplished and when the iron has been properly bent the welding can be conducted without interruption. Such work is also adaptable to armored concrete, and in other various ways, in the building trades.

CHAPTER XIII

MANUFACTURE AND INSTALLATION OF LARGE PIPES AND CONDUITS

FOR the manufacture of large and heavy pipes, by autogenous welding, the ruling items have been fully dealt with in the manufacture of cylindrical bodies. This field of application is very extensive, as large capacity pipes are often required for the most varied purposes.

A simple tee connection is made by cutting the necessary hole in the main pipe somewhat larger than the diameter of the pipe which is to be applied.

Application of Tee Connections.—The end of the branch pipe, which has been previously flanged, is closely fitted to the contour of the outer surface of the main pipe and then they are welded together (Fig. 118).

A better practice, however, is to make the hole in the main pipe somewhat smaller than the diameter of the branch and then turn the edges of the sheet outwards, so that the pipe welded on fits straight on to the edges thus turned up (Fig. 119).

A branch made in this manner is not only more neat in appearance, but is also of considerably greater

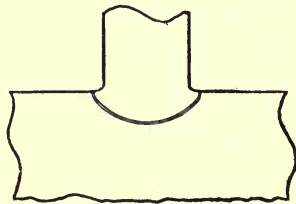

FIG. 118. — One method of applying a tee connection on a large pipe by welding.

strength, as the welding seam is not subjected to the internal strains as in the other method. Further for conducting gases and liquids, this latter practice is to be preferred, as it prevents the formation of eddies in the substances flowing through the pipes.

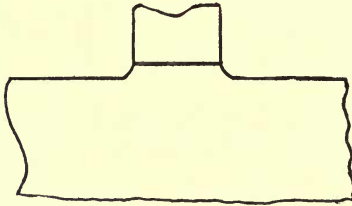

FIG. 119. — Another method of welding a tee connection on a large pipe. (This method is recommended in preference to that shown in the preceding illustration.)

Making of Large Elbows. — An elbow for a large capacity pipe is made by preparing a number of pieces, which are longer on one side

than the other, and uniting these segments by welding the circumferential seams so that shortest lengths lie in a horizontal line (Fig. 120).

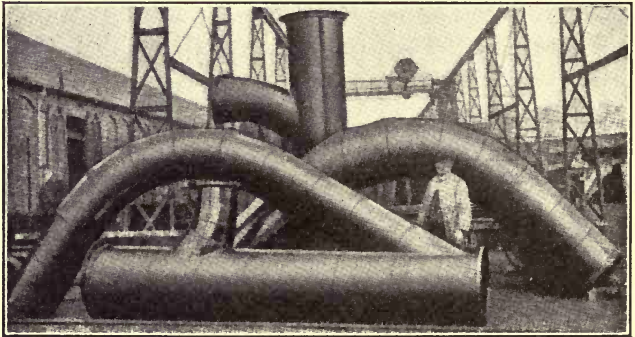

FIG. 120. — Large pipe elbows made from several sheet segments by autogenous welding.

Another way to make an elbow in such pipes is to take the piece of pipe of sufficient length for the bend and support it between two parallel blocks. Then heat the material on one side, by means of one or more

welding torches, until it is stretched on that side through greater expansion.

By continuing the heating the material continues to stretch on the heated side causing this side to bulge. At the proper time, the parallel support of the pipe is removed and a contraction of the pipe, on the inner side of the bend occurs, thus forming a regular pipe elbow. This method is much employed, with great success, in the pipe making industry.

When erecting pipe conduits it is necessary to take care that the connections are made in fairly large sections and this is attained by using flanged screw connections, at regular intervals.

Welding on of Flanges.—The fixing of such flanges on to the pipe wall is either, through threads cut into the piping and in the inner surface of the flange, or by the rolling in process, or by means of welding.

With the welding method, it is necessary, to recess the inner bore of the flange on a lathe so that the flange can be firmly welded on to the pipe end. Where it is practical, a collar can be turned in the walls of the pipe immediately behind the flange (Fig. 121).

In the regular manufacture of flanged pipe by means of the welding process, it is customary to use a flange with a collar of the same diameter and approximately the same thickness as the walls of the pipe. The edges of this collar are united with the pipe by means of autogenous welding.

Experiments have proved that the welding on of a flange, if properly executed, will resist greater pressure

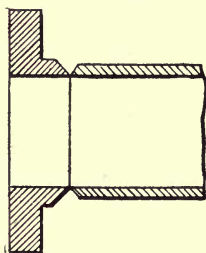

FIG. 121.— Pipe and flange bevelled preparatory to welding.

than if the pipe is threaded, or rolled in, and the joint made in this manner is absolutely gas and water tight.

When erecting pipe lines, one must also bear in mind, that expansion and contraction of the piping will occur according to the changes in temperature to which they are subjected.

Compensation Couplings. — These changes are overcome by inserting compensation sleeves in the conduit at desirable places. Such parts not only increase the cost of the piping, but necessitate also considerable space, which is not always available, particularly in the case of large capacity conduits.

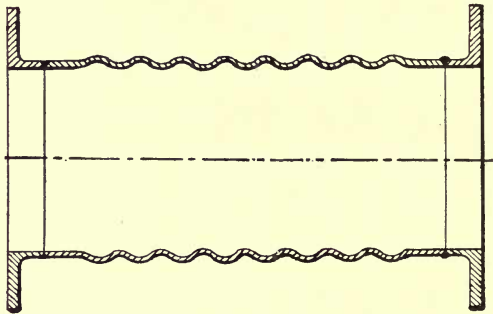

FIG. 122.— Expansion coupling welded between pipe flanges.

In ship building for instance, the space, which exists between the sheets of the double bottom, is used for accommodating such pipings. Having regard for the large number of conduits, which are required in this case, the question of accommodating the compensation sections causes the builder serious difficulties.

These connections are often made to advantage by means of autogenous welding by making the bends out of several segments, in a similar manner to the above mentioned pipe elbows.

Corrugated Sections.—There is a very simple means of avoiding these compensation couplings altogether, i.e., by inserting into the conduit at intervals short pieces of piping, which have been provided with circumferential corrugations on a rolling mill (Fig. 122).

Such sections are very similar to the Morrison or Fox furnaces used in steam boiler construction and these corrugations provide sufficient elasticity to accommodate the expansion and contraction of the piping, resulting from the changes in temperature.

Bends inserted at intervals also serve to nullify the effects of the changes in the material which, in conjunction with the corrugated sections, eliminate the difficulties resulting from temperature variations.

CHAPTER XIV

MANUFACTURE AND INSTALLATION OF GAS AND WATER PIPE

THE manufacture of gas and water pipe furnishes a field for autogenous welding, which has now assumed great proportions. This includes pipes of all diameters up to 4 inches.

The method previously employed, in such manufacture, consists of cutting the sheet metal of the required length and width and heating the strips, in a special furnace, usually a gas oven, uniformly to the welding temperature of the material. When this temperature has been reached the strips are drawn, direct from the oven, through suitable dies in a tube drawing machine, which form the strips into the shape of a tube.

Previous Method of Manufacture.—As the material is cooled down, during this operation, to a temperature below the welding point, it is necessary to return the partly formed pipe to the oven for reheating and then repeat the drawing process, with the exception that a smaller die is employed. During this operation, the edges of the strips are forced against each other, pressed firmly together and thus thoroughly welded.

This method of manufacture was adopted when "puddled" iron was in general use and, in order to obtain a good weld, two, and even three, drawings were necessary to secure satisfactory results; a smaller die being used at each successive operation. In this work, ordinary fire welding is used and the reliability of

such welding is dependent upon the overlapping edges reaching the proper welding temperature throughout.

Although the pipe drawing is an exceptionally quick operation, local coolings of the material often occur as the result of currents of air in the room, caused by the opening of a door or window, and as a consequence the welded section is not as perfectly homogenous as is desirable. The existence of poor welds is often in evidence when the material opens during the process of cutting threads.

Use of Mild Steel. — With the introduction of mild steel into modern manufacturing, a new material was available which was gradually adopted for the manufacture of gas and water pipe. The structure of mild steel is, however, quite different from that of pig iron and during the drawing operation considerable difficulty was experienced with the material breaking off at the drawing tongs, or fracturing at the die.

Adoption of Rolling Method. — For this reason, the tube mills gradually abandoned the drawing method, in pipe manufacture, and adopted pipe rolling machines, whereby the pipe was formed from a strip of sheet metal, by being passed through a series of profile rolls (Fig. 123). The rolls used in these machines varied in size owing to the expansion of the material in them due to the increase in temperature while in operation.

This constant expansion and contraction eventually produced breaks in the grips of the rolls, which had a bad influence on the product and made it necessary to adopt water cooling so that the rolls could be kept at an even temperature. Other difficulties, however, were introduced, for when the strips, at welding heat, were run through a series of water cooled rolls, the temperature of the metal was so reduced that the welding was not entirely satisfactory.

The foregoing serves to illustrate the reasons for the development and application of autogenous welding in the manufacture of mild steel pipes and the extensive adoption of such method by tube manufacturers.

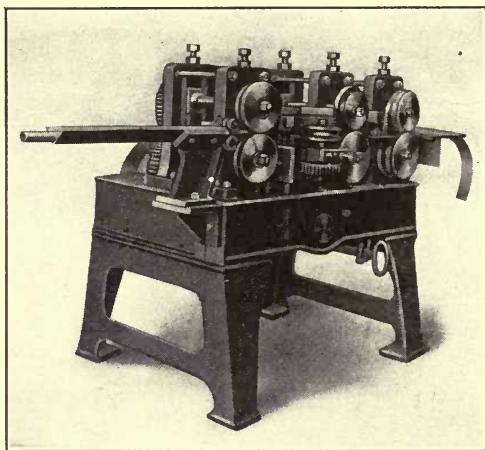

FIG. 123.— Pipe rolling machine.

Autogenous Welding Process. — In this method, the strips of sheet metal are first run through a rolling machine, to be formed as a tube, the two edges of the strip butting together in place of overlapping. They are then placed in a special welding machine equipped with several sets of rolls properly adjusted so that the edges of the strips are conducted under a fixed welding flame and thoroughly fused together. The union of the metal for the proper dimension of pipe is secured by means of a set of welding rolls situated immediately behind the flame (Fig. 124).

Defects to be Avoided. — In the rolling of such pipe, it is evident that a V shaped groove must be formed, where the edges of the strip butt together,

as a result of the varying stresses on the material and if the edges are fused into this groove, a flattening of the outer diameter will exist at the welding point. This lack of material will become evident when the pipe is threaded, especially in thick-walled pipes, and it is absolutely impossible to fuse in supplementary material in this process.

To avoid this difficulty, in the ordinary pipe rolling machines, the edges of the strips are pressed off at an angle according to the radius of the pipe to be made. In this manner, the upset material at the edges of the rolled strips is fused during the welding operation and contributes to improving the quality of the pipes.

In some of the tube-welding machines, a side pressure is exerted, during the welding process, by a pair of rollers forcing the tube together, causing a combination of the processes of autogenous and fire welding within the seam.

Welding Speed. — The usual pipe welding machines are arranged so that the formed pipe enters the machine in a cold state and the subsequent welding is executed at a speed of about 1 foot per minute, although many such welding machines operate at considerably higher

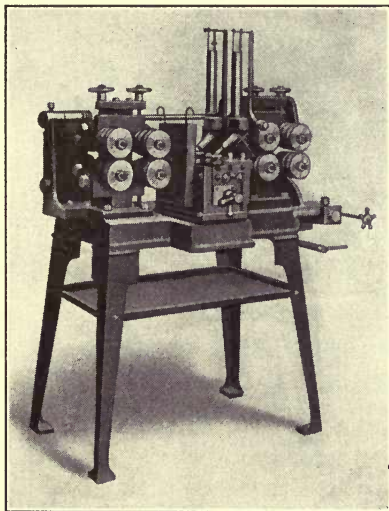

FIG. 124.— Pipe welding machine equipped with mechanically operated rolls.

speeds. Tubes for bicycle frames are rolled at a speed of 80 feet per minute and over, which is much higher than the working speed of the welding machines. The equipment of a tube mill as regards such machines must vary according to the nature of the work.

Preheating. — Pipe welding machines are now in use

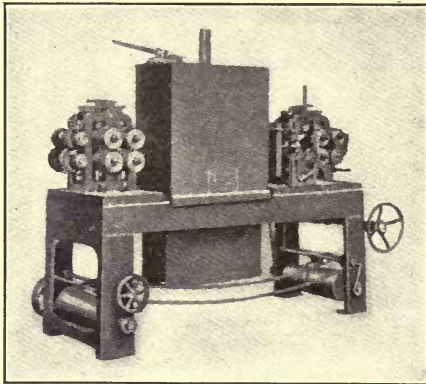

FIG. 125. — Pipe welding machine equipped with oil preheater.

with fittings which permit the pipe material to be heated to a temperature of 800°C . to 1000°C . (1472°F . to $1832^{\circ}\text{F}) immediately before it comes under the welding flame. By such preheating, the working speed of the machine is much increased and in some cases$

double the capacity has been secured when compared with the cold method.

At present there are two different methods of heating, one by means of an oil flame (Fig. 125) and the other by means of a coke fire (Fig. 126).

In the machines using the coke fire, there has been considerable difficulty experienced, due to the ashes from the fire lodging between the edges of the pipe and damaging the weld. This can be eliminated by providing a closed oven for the fire with a collar in the centre through which the pipe can be led, so there will be no direct heating of the material from the flame.

Devices for Preheating. — A French engineer, in an endeavour to utilize the waste heat of the welding

flame, arranged a block of heavy copper immediately in front of the flame. This block was provided with a hole for the passage of the pipe and so placed that the excess portion of the flame heated the interior of the copper block and this heat was then transmitted to the approaching pipe.

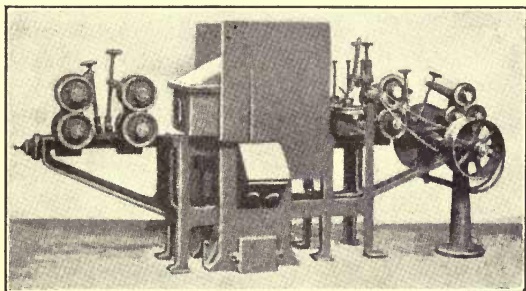

FIG. 126.— Pipe welding machine equipped with coke preheater.

Such a preheating device is practicable, but for satisfactory results it would be necessary to prevent the loss of heat by means of a jacket of non-conducting material on the exterior of the copper block. If the excess heat from the flame was insufficient, supplementary heat could be supplied by arranging a row of Bunsen burners underneath the copper block.

In welding machines, the method employed for preheating, whether an oil, a gas or a coke fire, is dependent entirely upon the cost of the fuel, since either method is entirely satisfactory with proper care.

Guiding Device. — In the existing pipe welding machines it is very important that a guiding device be fixed in the cleft of the pipe which is not yet welded, so that the place to be welded can be brought properly under the welding flame.

The welding flame in such machines also requires attention as it is necessary that an extraordinary constancy of pressure and uniformity in the mixture of the gases is secured. Care should be taken to obtain the maximum uniformity of pressure in the construction and operation of the acetylene apparatus adapted for this purpose.

Reliability of Flame.—An acetylene apparatus, which regulates the flow of gas under different pressures, or which might allow blockages in the outlet from the gasholder, is unsuitable for use in such welding.

It is well known that any heating of the material in the tip of the welding torch when in use will cause a change in the mixing proportion of the acetylene and the oxygen.

Cooling of Torch Tip.—As a change of the welding flame, so caused, would materially damage the pipe

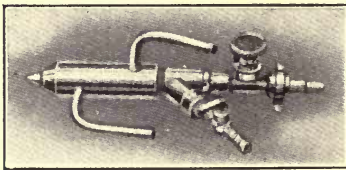

FIG. 127.—Welding burner equipped with water cooling device for pipe welding machine.

manufactured, it is essential that the temperature of the burner tip be kept at an even degree by means of a water cooling apparatus (Fig. 127). The rollers of the pipe welding machine may also be cooled advantageously

by similar water circulation.

Installation of Pipes by Welding.—In addition to the benefits resulting from the application of autogenous welding in the manufacture of pipe, there is also much economy possible by the introduction of this method in the laying of such pipes.

In the laying of pipe with screw couplings as was formerly the practice, the walls of the pipe are de-

creased by one half of their thickness through the cutting of threads for connections and consequently the resistance capacity is correspondingly decreased.

The strength of the walls of the pipe must therefore be sufficient for the pressure as well as for tensile stress and the depth of cut of the thread would necessitate a superfluous thickness of material.

By the methods formerly used in the manufacture of pipes a definite thickness of material had to be maintained throughout as the welding could not be satisfactorily accomplished with material of different thickness in the same section.

Reduction of Material. — If the use of screw pipe connections is abandoned and the welding of pipe ends is adopted, it is unnecessary to provide thicker pipe walls for such installations than those sufficient to meet the subsequent stresses.

Autogenous welding offers great advantages, therefore, in both the manufacture and installation of such pipe.

It is very essential, however, that a plumber engaged in such work, be perfectly familiar with the autogenous welding methods, as the pipe ends and the joining of side branches must be effected upon the spot. In such installations the dripping away of the material, on the lower part of the pipe shell, must be avoided as the welding must necessarily be executed at the end of the pipe.

Education of Welders. — This requires the use of acetylene apparatus in which superheating of the gases, during the generating process, is excluded, and also requires great experience and practice on the part of the workmen.

In the instruction workshop of the autogenous welding of metals at the Royal Technical High School of

Cologne, which was installed by and is now under the direction of the author, the autogenous installation of tubes has been made a special subject of instruction, and it is to be hoped that other training colleges will follow this example.

CHAPTER XV

CONSTRUCTION OF PIPE-SHAPED APPARATUS

THE employment of autogenous welding in the manufacture of pipes has developed an important branch of industry, in the construction of cooling apparatus, employing the system of heat exchange by means of counter currents.

Cooling Apparatus. — Such apparatus consists, usually, of an undulating shaped pipe capable of conducting either liquid or gas, around which a similar shaped pipe of larger diameter is concentrically placed. The ends of the outer pipe are closed upon and welded to the walls of the inner pipes (Fig. 128). Connections are then made and the direction of the liquid or gas, in the one pipe, is opposite to the direction of the second fluid in the other pipe.

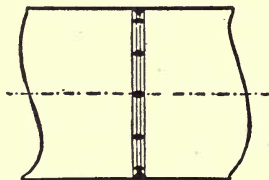

FIG. 128. — Method of tacking sheet sections before welding.

Ammonia Machines. — Ammonia cooling machines, and similar apparatus for the exchange of heat, consist of a series of straight tubes arranged parallel and joined at alternate ends so as to provide a continuous flow, but with an alternating upward and downward movement. The straight parts of such tubes are encased in larger tubes, the ends of which are closed in a special forming machine previous to their application so as to fit the outer diameter of the inner tube to

which they are then welded. The larger tubes are then joined, by short pipe sections, alternately above and below, and in this manner a very efficient counter current heat exchange apparatus is produced (Fig. 129).

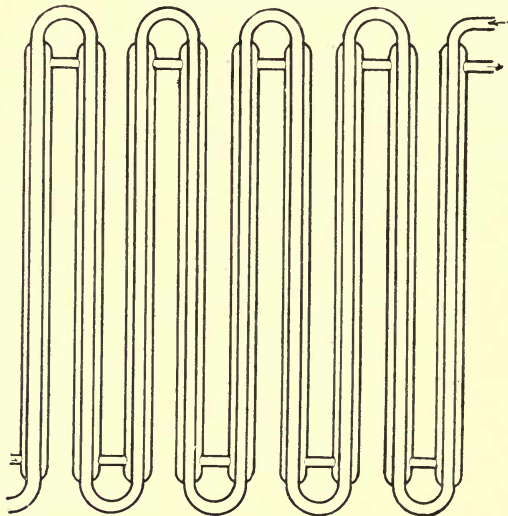

FIG. 129.—Counter-current cooling apparatus manufactured from sheet metal by autogenous welding.

The industrial possibilities for the employment of autogenous welding in the manufacture and assembling of tubes for the conduct of water and gas are very great. Similarly, extensive use is also made in the manufacture of thin shelled tubes of rather small diameter for isolation pipes in electrical installations and such purposes.

There is also a wide field in the manufacture of tubes for the construction of cycles, flying machines, motor cars, metal furniture and other purposes, with a thickness of material varying between .5 m/m and 1.5 m/m

(1/64 and 1/16 inches) and numerous large factories devote themselves entirely to this particular industry.

Bicycle Tubing.—Such tubes, smoothened out by a cold drawing process after having been completed, are variously employed for bicycle manufacture. In these tubes, the material is often required to stand very great strains in one direction and for this reason, tubes have been developed, for such service, which possess an oval cross section in place of a circular one. This is accomplished by drawing the circular tube through an oval form whereby the required cross section is secured.

In constructing tubes of this kind which are used in cycle manufacture, the strain upon the strength of the tube is usually placed in its lengthwise, rather than in its crosswise, axis.

A certain firm, for a number of years, produced an oval tube that was particularly superior to its rivals owing to its greater firmness, and during this time, the manner by which this greater power of resistance was obtained remained a secret. It was only on the occasion of a lawsuit that the process, used by this firm, became common property of the engineering world at large.

Oval Shaped Tubing.—In these tubes, the forming of the oval shape, from the circular tube was arranged so that the welding seam did not lie in the main axis of the tube, as is otherwise common, but immediately at the side of the axis (Fig. 130).

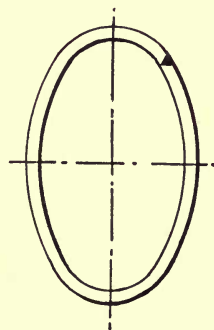

FIG. 130.—Oval-shaped bicycle tubing with welding seam outside the line of strain.

During the last few years, the construction of aerial craft has become one of great importance. For this

purpose, it is essential to employ a construction tube of as little weight, but as great a power of resistance, as possible.

In order to render relatively light, and thin shelled tubes, sufficiently strong for the great strains, in the operation of aerial machines, the author, on the occasion of the International Exhibition of Airships at Frankfort on Main in 1909, proposed several such construction tubes, which have since been accepted by industrial concerns (Fig. 131-132).

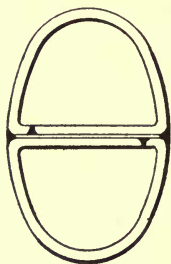

FIG. 131.— Two-section tubing for aerial machines.

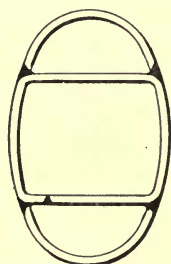

FIG. 132.— Three-section tubing for aerial machines.

Aeroplane Frames.— If, for example, two triangularly shaped tubes are placed against one another and the places where they touch are autogenously welded together, a tube is obtained of light weight and strong resistance. Many similar tubes can be made of the most various kinds, according to the purpose for which they are to be employed.

In welding such tubes into parts of machines, it is important that a superheating of the material near the welding place should be avoided.

Joining of Tubes.— This is done by the welder playing the flame upon the union, in a position as horizontal as possible, and by eliminating, at the same

time, the conduct of heat from the welding place to the adjoining portions of the material. To effect the latter purpose, the tubes, for a short distance from the welding seam, should be surrounded by substances which conduct heat readily, as for example copper, so that the heat is absorbed by these protecting substances and its injurious influence upon the adjoining material is avoided.

Where it is of advantage, in regard to the strain which it is later called upon to resist, the part may be hardened, in the usual manner, after it has been autogenously welded.

Miscellaneous Apparatus.—In making saddle supports, or rims of bicycles, from the prepared tube, a wedge shaped portion is cut out so as to leave a part of the original tube material intact. The material is then bent round and the touching edges are welded (Figs. 133–134).

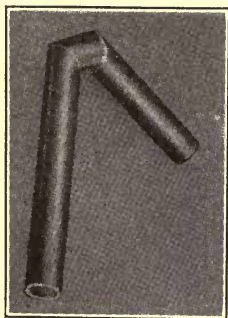

FIG. 134.—Section of a bicycle frame autogenously welded.



FIG. 133.—Bicycle frame tubing cut and bent into position ready for welding.

In the construction of aerial machines, much use is made of the autogenous welding, but for the want of space, it is impossible to go further into this most interesting matter, and those interested are referred to the respective special literature on this subject.

A process analogous to the manufacture of bicycles is the making of iron furniture, and products of the most various kinds, such as bedsteads, chairs, etc., which can be easily manufactured by means of autogenous welding. This is also true in the manufacture of motor cars.

Tapered Tubing. — In pipe manufacture, it is often necessary to construct a pipe of such shape that the ordinary pipe forming and pipe rolling machines are unsuited, particularly tapered pipes, and similar shapes, which are formed, by the inclined roller process, and welded.

Another important application is where welded pipe is drawn smaller in diameter, at regular intervals, by a process of great importance, in the manufacture of ship masts, flag poles, lamp posts, fishing rods, etc.

Ship Masts. — The extent to which such process can be utilized can be better appreciated when it is known that recently, a Westphalian factory successfully undertook the manufacture of fishing rods, whereby a pipe of 25 m/m (1 inch)* diameter was reduced, at regular intervals, so that the smallest section had a diameter of only 5 m/m ($\frac{1}{5}$ inch).

Autogenous welding, capable of withstanding such severe stresses, must be entirely satisfactory.

CHAPTER XVI

WELDING OF COPPER

COPPER is, next to iron, the most important of metals and owing to its dense structure, which permits it to be easily polished, together with greater ductility, it is extensively used for the most varied industrial purposes. It has a specific gravity of 8.8 and a melting point of 1084° C. (2084° F.), while the boiling point is 1500° C. (2730° F.).

In a heated condition, copper easily combines with atmospheric oxygen, forming oxide of copper, which compound first exists only on the surface, but later on, becomes absorbed in the solid material.

The normal color of copper is a light salmon red, but when oxidation occurs, the color changes to a dark copper and, near hard soldered places, one may observe the light salmon red fractures merging into the dark brick red fracture, if the material is broken across the joining seam. In such cases, the copper is said to be burned.

Molten Properties. — In a properly adjusted autogenous welding flame, the acetylene receives only a sufficient quantity of oxygen to convert it into free oxide of carbon and free hydrogen. If, on the other hand, there is a surplus of oxygen, in the welding flame, complete combustion of the gases takes place, forming carbonic acid and water. When this occurs, part of the flame, which contains these products of combustion, has no reducing qualities and by superheating the simultane-

ously formed steam, free oxygen is liberated, which combines itself with the copper.

Molten copper has a great capacity to absorb gas and particularly hydrogen, which gases are again eliminated, when the copper solidifies. They rise in bubbles to the surface and then burst, shedding delicate particles of copper around them. This phenomenon is familiar to copper founders.

If the welding place of the copper cools and the solidifying of the surface takes place, before such small gas bubbles have been liberated from the molten mass, these bubbles form porous places in the copper material.

Copper has great affinity for oxygen at temperatures considerably below the melting point, losing its physical qualities by combining with it, forming oxide of copper.

This characteristic of copper renders it necessary to observe strict precaution, in the autogenous welding of this metal. Also, in hard soldering of copper, this phenomenon occurs and it is necessary to protect the molten metal and the adjoining parts against absorbing oxygen out of the atmosphere. This protection is effected by the application of a welding powder, or flux, which has a melting point immediately below, and a point of evaporation somewhat higher, than the melting point of the copper.

Welding Powders.— In such industry, it is usual to apply mixtures of borates and silicates, as welding powders, but it is advisable, in welding copper, to add a substance which has a great affinity for oxygen. Many welding powders have been introduced which contain a certain percentage of compounds of phosphorus and compounds of borium. Phosphorus has the particular ability to reduce oxides of copper to metallic copper, while at the same time, the molten mass becomes as light a liquid as water.

In copper founding, ingredients of phosphorus are generally used in the melting, but a high phosphor percentage makes the copper brittle. The quantity of phosphorus added to the copper must not, therefore, be much larger than is absorbed in the process of dis-oxidation of the metal, so that the phosphorus does not remain in the copper substance except in infinitesimal quantities, which are harmless.

Aluminium, too, has valuable dis-oxidizing qualities, of which ample use is made in the manufacture of steel castings. In autogenous welding the phosphorus is usually rendered effective by the employment of copper filling bars, which have a small percentage of phosphorus, but not more than 0.05%. These filling bars usually contain other ingredients in small quantities, such as aluminium, or borium, and their manufacture requires great care.

Small ingredients of aluminium make the homogenous mixing of the molten mass very difficult, as this substance has only about one fourth of the gravity of copper and equal distribution, over the whole mass of the copper, is almost impossible.

Operation of Welding Flame.— In the autogenous welding of copper, it is important that the welding flame should be properly adjusted. Also, if the inner cone of the welding flame touches the molten mass of the copper, a burning of the copper occurs, as will also happen to the filling bars, if they are similarly exposed.

To obtain a good welding of copper, it is necessary to melt down the joint by careful operation of the torch and to introduce new material, from a suitable filling bar of copper, so as to stir the molten mass.

If the filling bar has a certain percentage of phosphorus, the latter will form a compound of phosphoric acid with the oxides of copper, which are being dis-

oxidized. This acid will flow along the surface as a thin tough film, protecting the copper from the oxygen of the atmosphere and consequently superheating, or oxidizing, of the copper cannot take place.

In this case, the phosphoric acid, which is formed, replaces the welding powder which would otherwise be required. In this manner, pure welding of copper may be obtained but it is advisable, and particularly so for the beginner, to employ a good welding flux in addition.

This welding powder is sprinkled upon the surface of the copper after it has been heated and melts down into a film shaped coating. It is advisable to cover the mass of copper to be welded, on either side, with welding powder in this manner, for in copper one has to deal with a metal which has a melting point higher than the melting point of its oxides. This is also the case in alloys of copper.

Avoiding Burning the Metal.—The experienced workman in autogenous welding or hard soldering is able to judge from the glow of the heated spot of the copper when the burning of the metal with the oxygen of the atmosphere can take place, as this state of heating is characterized by a dazzling white appearance. If it is possible to effect a union of the metal before this high temperature of the copper, or its alloys, is reached, that is, if a temperature is secured, which is immediately below the melting point of the metal, all combustion of the metal can be surely avoided.

There have been methods evolved, by numerous firms, for the welding of copper and of copper alloys, which are founded upon such process. The parts of the metal, which are to be joined together, should first be cleaned thoroughly, at the place of welding, and then be placed one upon the other and heated by

an autogenous welding flame to a temperature slightly below the melting point. A metallic anvil, or rail, which has been heated, should be used and, upon such support, the parts to be joined should be heated and worked, by small hammers, so that a kind of fire welding is effected.

Hammering Method.— In the working of copper alloys, such as brass, bronze, or various compositions, this method, particularly, is much in use. For this purpose, small hammers with heads of an area of 8 m/m (5/16 inch) square are used with advantage. It is necessary that these hammers strike that part of the material only, which has been heated to a suitable temperature, under the influence of the flame.

Usually, the workman takes the welding torch in one hand, with the small hammer in the other, and effects a kind of puddling, as was mentioned above in the welding of mild steel.

The employment of a welding powder is not required in this case but, if such is employed, it should be carefully eliminated from the joint by hammering. In welding brass, or brass alloys, the parts to be united may also be washed with the usual soldering water but in this case, the surfaces to be joined must, previously, be thoroughly cleansed.

CHAPTER XVII

WELDING OF ALUMINIUM

THE most important matter to consider, in the autogenous welding of aluminium, is the great difference between the melting points of the metal and of its oxide. Metallic aluminium melts at 650° C. (1200° F.) while the melting point of the oxide of aluminium is upwards of 3000° C. (5450° F.).

Another important item is the great affinity of aluminium for oxygen and, in the melting of the metal, it will be observed that, on the surface of the single small drops, a compound is formed with the atmospheric oxygen as a thin and tough film.

Influence of Oxide. — It is not possible to destroy this film of oxide by the application of external heat, although this heat has a considerably higher temperature than the melting point of the oxide. In the molten metal, its melting heat remains latent and, notwithstanding the temperature of the flame, the film of oxide is cooled down to the melting temperature of the aluminium metal from beneath.

For this reason, it is absolutely necessary, in welding aluminium that the film of oxide be destroyed, which may be done either chemically or mechanically. In the autogenous welding process, the oxide film is destroyed and a pure metallic combination is effected; in which respect, it differs from the soldering method. It is one of the characteristics of the soldering method that a union is effected, although imperfect, without the

destruction of the oxide, so that a film still exists between the parts that have been united.

Electrical Properties. — This is of great practical importance, for aluminium has different electrical properties from those of its oxide. Therefore, in each combination of masses of aluminium, where the films of oxide intervene, galvanic chains must exist, which eventually lead to the destruction of the union.

If acid is present, as, for example, sulphuric acid, which is found diluted in the atmosphere of industrial districts, any combination that has taken place cannot be satisfactory, if the film of oxide has not been destroyed.

Mechanical Destruction of Oxide. — The destruction of this film can be effected by mechanical means. In this case, the surfaces of two parts of metallic aluminium are put one upon the other after they have been cleaned of all foreign substance, as oil or grease. The surfaces are then heated with the welding flame to a temperature of about 400° C. (750° F.) and are then gently, but rapidly, hammered. In this manner, the intervening films of oxide are destroyed and the metal is welded together.

This elimination of oxide can also be effected by means of rolling. This process, which is identical with the puddling previously mentioned, is employed on a great scale, for the most various purposes, in Germany, particularly in the manufacture of sheet aluminium vessels.

Another mechanical method consists in the following process. The edges of the aluminium parts, to be united, are prepared and melted in the usual way, and the molten material is then stirred with the filling bar. In this manner, the films of oxide are destroyed and it is thereby possible to make the various parts

flow together into one mass, by means of the stirring, in a manner similar to the uniting of separated drops of mercury poured out on the hand. This method is impracticable, in the case of rather thin sheet metal, because the quantity of material is insufficient.

Such method is also somewhat unreliable; as there is always the danger that a small detached film of the oxide is molten in, causing local partitions in the welding seam.

Chemical Destruction of Oxide.—The most reliable method for the proper uniting of parts of aluminium is the one wherein the oxides are destroyed by a suitable flux. The established practices of autogenous welding of aluminium are founded chiefly on the use of such fluxes.

This flux or powder consists either of a mixture of alkali chlorides and compounds of fluor and kalium with chlorides of alkalies or the latter alone. The composition of such a powder is the following:—

Kalium Chloride	(KCl.)	45 %
Lithium Chloride	(LiCl.)	15 %
Natrium Chloride	(NaCl.)	30 %
Kalium Fluoride	(KFL.)	7 %
Double Sulphide of Sodium	(NaHSO ₄)	3 %

Welding Powder.—The melting points of the single constituents of such a mixture vary considerably from each other and, in some of them, the melting point is above that of the aluminium metal. This involves the danger that single parts of the mixture may not be melted during the operation and thus become fixed within the molten metal, in the form of black grains.

This imperfection can be remedied by first pulverizing the individual constituents of the flux and then proceeding with the mixing process in the required percentages. Such a powder is extraordinarily hygro-

scopic and absorbs the moistness, which is always present in the atmosphere, thus forming a pulpy mass.

For this reason, such powder for welding aluminium must never be left standing open in the air but must be kept in closed bottles and, if possible, in such bottles as are fitted with ground glass stoppers. It is also advisable to thoroughly seal the bottle with a thin coating of wax.

Patent Process. — In Germany, M. U. Schoop has taken out two patents for a method of autogenous welding of aluminium. The principal patent protects a process for the welding of metal with the use of a flux consisting of a mixture of alkali chlorides. The additional patent covers the addition of compounds of fluor to such mixtures. These two patents are in possession of the A. G. für Autogene Aluminium Schweissung, Zurich, Switzerland.

This Company manufactures the flux in the form of a kind of paste, which is put upon the parts of the aluminium which are to be united by means of a brush. The welding bar, which must consist of pure aluminium, is also plunged into this paste.

It is of advantage, in the employment of dry powders, to heat the filling bar so that the welding powder will melt and flow upon the bar as a thin film, which heating can be advantageously done by the welding flame. In the welding operation, the bar must be kept in a vertical position, so as to allow the film of the flux to flow down the surface of the bar.

Care must be taken that there is no unnecessary heating of the powder by the welding flame, or touching of it by the inner cone of the flame, because some of the constituents of the mixture would be liable to evaporate and the composition of the rest be unfavourably influenced.

Sheet Metal. — In the welding of sheet metal, the filling bar should be carried in the direction of the welding, so the filling material can be virtually inserted in the trough.

The autogenous welding of aluminium requires great skill and training but, properly handled, the aluminium which has been welded is nearly equal in strength to the original metal.

CHAPTER XVIII

NICKEL AND OTHER METALS

NICKEL is extensively employed in industry both in the pure state and in alloys with other metals. On the whole, its properties are very similar to those of iron.

It has a melting point of 1600° C. (2912° F.) and, in a molten state, has the property of absorbing large quantities of gases, particularly oxygen, which gases remain intact after the mass cools down, forming cavities.

Another property of great importance, in the autogenous welding of nickel, is its great affinity for sulphur, with which it forms many compounds.

It is frequently stated that nickel is incapable of being welded by an autogenous welding flame but this is incorrect, although such process involves considerable difficulties.

Welding Temperature. — Nickel, like iron and most other metals and alloys, is entirely weldable. That is, at a certain heat below the melting temperature it may be plastically kneaded by means of mechanical force. Further, by executing the union at a temperature below the melting point, the injurious absorption of gases by the metal does not generally occur.

During the autogenous welding of an alloy composed of nickel and iron, it often happens that the nickel separates from its alloying component and a fracture of the welding seam will reveal small globules of pure nickel.

Use of Heated Anvil. — Due to its great capacity for conducting heat, all welding of nickel must be done with the parts resting upon an anvil, which has previously been heated to a dark red. This anvil can be heated in a coal fire or by a gas flame.

In welding two plates, in the manufacture or repair of nickel utensils, it is necessary that the faces of the two parts which are to be united, must be thoroughly cleaned. They are then placed upon each other, heated to a temperature just below the melting point, with the welding flame, and hammered together with small hammers. With proper care, the two parts can be thus welded to a homogenous body.

Hammering Process. — When two slightly heated nickel pieces are thus hammered together on a heated support or are pressed together by heated rolls, the direct welding which takes place effects a pure metallic combination which in no wise differs from the original metal in respect to structure or physical properties.

As in the case of ordinary iron, the existence of porous places often causes much trouble in rolling mills and frequently rolled nickel plates contain porosities, which are not discovered until they are further machined. Formerly, these damaged pieces had to be cut out and as they then had only the value of scrap, extensive losses in labor costs were often occasioned.

Repairing Nickel. — In repairing such places by means of autogenous welding, the porous places are so worked with a drill as to clean the inner walls of all foreign matter. After sufficient heating of the piece in the vicinity of the place to be repaired, a pointed pure nickel wire is inserted in the opening and at the same time kept constantly heated with the welding flame. Such work, however, must be done with the plate resting on an anvil heated to a dark red.

In the manufacture of nickel tubes or similar apparatus, the same general principles must be employed and appropriate methods can be developed for the most varied kinds of work.

Rules for Welding Nickel. — It is necessary that the following rules be carefully observed:—

1. The surfaces to be heated must be absolutely free from grease and oil and made mechanically clean by scraping or similar method.

2. The work must be done while the material rests on an iron support heated to from 700° C. to 800° C. (1300° to 1475° F.).

3. The hammering must be performed with long handled hammers of about 1 lb. weight and only when the nickel plate has been brought to a bright white heat and the support is at a temperature between the figures just quoted.

The successful welding of nickel is a development of great importance and the process will be widely applied in the future as soon as the art is more generally understood.

Welding of Silver. — Similar phenomena appear in the autogenous welding of silver as in the welding of nickel, and here also it is advisable to employ the hammering process which has repeatedly been mentioned for the effective joining of the metal.

Welding of Gold. — Matters are, however, quite different in the autogenous welding of gold and ample use is made of this autogenous welding process in the goldsmith industry. In the working of gold the pure melting process is all that is necessary to be employed for the metal to join smoothly.

Welding of Lead. — The soldering of lead, which has been introduced into industry nearly 100 years ago, is, on the whole, nothing else than autogenous welding,

which soldering can also be executed to advantage with a welding flame.

As the melting point of the lead is very low and its capacity for conducting heat is relatively small, the work with the oxy-acetylene flame, therefore, must be very quickly done.

The welding of thin lead sheets especially, by the oxy-acetylene flame, requires extraordinary skill and practice, but with the proper handling of the burner such welding, as well as that of lead bodies, is economical and technically very advantageous.

Welding Together of Different Metals. — It is often required in industry to weld together things which consist of different metals as, for instance, iron and copper or alloys of copper. On the whole, the principles given on the subject of copper welding must be observed.

The combustion of the copper must be avoided and as its capacity to conduct heat is much greater than that of iron, the iron part must be melted down first in such work and then the copper must be made to flow into the iron, employing a copper bar as filling material.

CHAPTER XIX

CONCLUSION

IN the foregoing pages, the working of the most important metals and metal alloys has been discussed and an attentive autogenous welder will be able, from the text, to form for himself a clear idea in regard to such metals as have not been dealt with here, as to how he must act in each particular case, in operations of these kinds.

The whole of the technique of autogenous welding is at the present time in a course of technical refinement. New working methods are constantly appearing and the field of application for the process is being rapidly extended.

In the most various industrial establishments definite working methods have been formed but which are now treated as manufacturing secrets, and it is in the nature of technical development that such processes should gradually become the common property of all students of the art of welding.

The process which is considered to be the most important one and which apparently is destined to produce a revolution in many industries, is the puddling process, which has been repeatedly mentioned in the foregoing pages. The physical characteristics of metals frequently alter very considerably when the metal is converted into a molten state, and it is apparent that where, by the melting of the metal, such alteration occurs, there are valuable technical advantages in

effecting a homogenous combination below the melting temperature, as can be secured by the puddling of the heated metal parts.

This puddling process is the basis of the fire welding which has been in use from time immemorial and, with the introduction of aluminium, it returned for technical purposes in the Heärus process. With the constant increase in the number of metal alloys, which are becoming available for technical purposes, it will also play an important part in the autogenous welding of such alloys.

In the opinion of the writer, the general introduction of the puddling process opens further industrial prospects, as, by this means, many metals and metal alloys can be satisfactorily combined, which were formerly considered as thoroughly incapable of being welded. This opinion was held because such metals, in their molten condition, have great capacity for absorbing the gases which are the products of combustion of an autogenous welding flame, which would render autogenous welding seams porous and brittle.

Therefore the attention of the students of autogenous metal-working is specially directed to this process and its future development is earnestly recommended to them.

I N D E X

- Absorption of gases by molten metal, 3, 4, 13, 14, 54, 127, 137.
- Acetylene, basis of manufacture of, 7.
chemical properties of, 5.
combination of oxygen and, 5.
dissolved, 19.
overheated, 11, 13, 14, 54.
piping of, 31.
polymeres of, 6, 11.
purification of, 20, 21.
welding pressure of, 31, 35.
- Acetylene dissous, bottles for, 19.
burners for using, 19, 35.
general properties of, 19.
preparation of, 19.
shipment of, 19.
use of, 19, 20.
- Acetylene generators, automatic, 17.
carbide to water, 9, 10, 20.
charging and cleaning of, 10, 11, 13, 16, 17, 19.
compressed carbide, 12.
dipping, 17.
dust carbide, 14.
polymerisation in, 11, 13.
portable, 8.
size of carbide for, 8.
stationary, 8, 12.
temperature limits for, 10.
water requirements of, 10, 20.
water to carbide, 9, 16, 21.
- Acetylene purifiers, chemical, 20, 21.
direction of gas flow in, 21.
material for, 21, 22.
mechanical, 21.
- Advantage of using welding burners larger than standard, 43.
- Aeronautical motors, manufacture of, 101.
- Alloys, welding, of copper, 131.
of nickel, 137.
separation of components of, 137.

- Aluminium, autogenous welding of, 132.
chemical properties of, 132.
electrical properties of, 133.
melting point of, 132.
methods of destroying oxide of, 132.
oxides of, 132.
patented processes for welding, 135.
physical properties of, 132.
soldering of, 138.
strength of welds in, 133, 136.
welding powders for, 134, 135.
welding of sheet, 136.
- Annealing metals after welding, 74.
- Annular welding, 95.
- Autogenous cutting of metals, cost of, 47.
gas consumption of, 48.
industrial applications of, 47.
speed of, 48, 49.
theory of, 44.
- Autogenous welding, different processes of, 2, 3, 4, 5.
future developments of, 141.
gas consumption in, 42.
general description of, 1, 2, 50.
industrial applications of, 1, 2.
machines, 115.
of aluminium, 132.
cast iron, 58, 63.
cast steel, 59, 62.
copper, 127.
gold, 139.
hard steel, 60.
iron, 61.
lead, 139.
mild steel, 60, 62.
nickel, 137.
pieces of different thickness, 91.
pipe, 112, 114.
sheet iron, 68.
silver, 139.
two different metals, 140.
wrought iron, 60.
puddling process of, 76, 131, 138, 139.
- Automobile motor manufactured from sheet metal, 101.
- Back firing of welding burners, 31, 36, 39, 41.
- Beagid, 18.

- Bending tests of autogenous welds, 59.
- Benzine, general properties of, 4, 5.
- Benzol vapors, general properties of, 4, 6.
 - welding uses of, 5.
- Bevelling of metal before welding, 69, 90.
- Blaus gas, 4.
- Blowholes in metal after welding, 54, 128, 137.
- Boilers, steam, causes of failures in, 80.
 - construction of, 81.
 - effect of temperature variations in, 80.
 - manufacture of, 81.
 - repairs to sheets in, 83, 84.
 - repairs to tubes in, 85.
- Boss welded on vessel for pipe connection, 103.
- Bottles, capacity of, 23.
 - for dissolved acetylene, 19.
 - hydrogen, 3.
 - oxygen, 23.
 - handling of, 19, 29.
 - repairs to, 27, 28, 29.
 - valves and fittings for, 27, 28.
 - weight of, 26.
- Brass, composition of, 39.
 - welding of, 131.
- Burners, adjustable, 36.
 - back firing of, 31, 36, 39, 41.
 - cleaning of, 41.
 - construction of, 35, 39, 40, 44.
 - cutting, 44.
 - equal pressure, 35.
 - flame adjustment of, 37, 38.
 - gas consumption of, 42, 48.
 - injector, 31, 36.
 - operation of, 37, 38, 39, 42.
 - selection of, 36.
 - use of large, 43.
 - welding, 35, 39.
- Burning of metal during welding, 3, 13, 54, 72, 127, 130, 137.
- Bunsen burners for preheating, 117.
- Calcium carbide, commercial sizes of, 7.
 - compressed, 18.
 - drums, 7, 8.
 - dust, 14.
 - general properties of, 7.
 - heat generated by gasification of, 9.

- Calcium carbide, quality of, 20.
 - storage of, 8.
- Carbide to water generators, 9, 10, 20.
- Capacity of oxygen bottles, 23.
- Carbon in molten iron, 13, 50, 54, 62.
- Carbonising flame, 38.
- Carbonization of metals, 38, 54.
- Care of burners, 41.
- Cast iron, expansion of, 64, 65.
 - filling material for welds in, 58.
 - general properties of, 50, 57, 58, 64.
 - melting point of, 64.
 - repairs of, 63, 65, 66.
 - structure of, 50, 57, 58.
 - welding of, 58, 59, 63.
- Cast steel, filling material for welds in, 59, 60.
 - welding of, 59, 62.
- Causes of burning in the welding seam, 54.
- Charging acetylene generators, 10, 11, 13, 16, 17, 19
- Chemical process for producing oxygen, 26.
- Chemical properties of acetylene, 5.
 - aluminium, 132.
 - copper, 127.
 - hydrogen, 2, 3.
 - iron, 50.
 - oxygen, 3, 5.
 - nickel, 137.
- Chemical purifiers, design of, 20.
 - materials used in, 21.
- Circumferential seams, welding of, 88.
- Cleaning dust filters, 22.
 - generators, 10, 11, 13, 16, 17, 19.
 - tips of burners, 41.
- Co-efficient of tension in cast iron, 64.
- Combustible gases, 2.
- Complex castings, repairs to, 66.
- Composition of welding fluxes, 58, 128, 134.
- Compressed carbide generators, 18.
- Conduits, large, compensation couplings for, 110.
 - corrugated sections for, 111.
 - elbows for, 108.
 - flanged connections applied to, 109.
 - installation by welding, 110.
 - manufacture of, 107.
 - strength of welded, 109.
 - tee connections welded on, 107.

- Cooking utensils, manufacture of, 105.
- Cooling of heated welding burners, 37, 40.
- Copper, alloys of, 131.
 - autogenous welding of, 127.
 - filling material for welding of, 129.
 - hammering method in welding of, 131.
 - influence of phosphorus in, 129.
 - melting point of, 127.
 - oxides of, 128.
 - position of burner in welding, 129.
 - properties of, 127.
 - soldering of, 128.
 - welding powders for, 128.
- Critical temperature of air, 24.
 - oxygen, 25.
 - nitrogen, 25.
- Cutting burners, construction of, 45.
 - designs of, 44.
 - gas consumption of, 48.
 - guiding devices for, 46.
 - industrial uses of, 47.
 - motor driven, 46.
 - operation of, 45.
- Cylindrical vessels, circumferential seams welded in, 88.
 - closed, 93.
 - construction of, 86.
 - corrosion in, 96.
 - heads of, 94.
 - horizontal seams welded in, 27.
 - intermediate heads applied in, 98.
 - internal strains in, 93.
 - joint rings for, 92.
 - large, 90.
 - open, 91.
 - supports for, 97.
- Defective welds, 54, 63, 71, 72, 128, 132, 137.
- Demonstrating expansion of sheets under influence of welding flame, 87.
- Devices for use in autogenous cutting, 46, 47.
 - welding, 86, 88, 89, 90, 96, 100, 131, 139.
- Diameter of hose for gas welding, 31.
- Dipping acetylene generators, 17.
- Dissolved acetylene, bottles for, 19.
 - general properties of, 19.

- Dissolved acetylene, preparation of, 19.
 use of, 19, 20.
 welding and cutting burners for, 19, 35.
- Distinction between superheating and combustion of iron in welding, 54.
- Double shell vessels, manufacture of, 103.
- Dust carbide generators, 14.
- Dust filter for acetylene, 22.
- Education of welders, 119.
- Effect of excess carbon in molten iron, 54.
- Effect of temperature variations on boiler sheets, 81.
- Elbows manufactured from sheet segments, 108.
 by unequal heating of the sheets, 109.
- Electrolytic process for producing oxygen, 25.
 general description of, 25.
 power requirements for, 26.
- Expansion of cast iron during welding, 64, 65.
- Expansion of sheets during welding, 87.
- Experiments in autogenous cutting at Birmingham, England, 49.
- Explosions in acetylene generators, causes of, 11.
- Failures of welds in aluminium, 132.
 cast iron, 63.
 copper, 128.
 iron and steel, 54, 72.
- Filling material for welds in aluminium, 135.
 cast iron, 58.
 cast steel, 59.
 copper, 129.
 hard steel, 60.
 mild steel, 60.
 nickel, 138.
 wrought iron, 60, 70.
- Filter for acetylene, 22.
- Fittings for oxygen bottles, 26, 27.
- Flame, adjustment of burner, 37.
 carbonizing, 38.
 neutral or correct, 37.
 oxidizing, 37.
- Flanging of sheets for welding, 68, 69.
- Flexible metal hose for burners, 34.
- Fluid for testing the purity of oxygen, 24.
- Flux for welding aluminium, 134, 135.
 cast iron, 58.
 copper, 128.

- Flux for welding steel, 61.
 wrought iron, 61.
- Foaming of the welding seam, 13.
- Frames, window, made by welding, 106.
- Future developments in autogenous welding, 141, 142.
- Gases, absorption of, by molten metals, 3, 4, 13, 14, 54, 127, 137.
- Gases, combustible, acetylene, 5.
 benzol, 4.
 blau, 4.
 hydrogen, 2.
 illuminating, 4.
 liquid, 4.
- Gas consumption of burners, 42, 48.
- Gasifying dust carbide, 14.
- Gas mains in welding shop, 31.
- Generators, acetylene, automatic, 17.
 carbide to water, 9, 10, 20.
 charging and cleaning, 10, 11, 13, 16, 17, 19.
 compressed carbide, 18.
 dipping, 17.
 dust carbide, 14.
 polymerisation in, 11, 13.
 portable, 8.
 size of carbide for, 8.
 stationary, 8, 12.
 temperature limits for, 10:
 water requirements of, 10, 20.
 water to carbide, 9, 16, 21.
- Gold, autogenous welding of, 139.
- Granulated carbide, 7.
- Hammering method in welding of aluminium, 133.
 copper, 131.
 nickel, 138.
 silver, 139.
 wrought iron, 76, 84.
- Hard steel, filling material for welds in, 60.
 welding of, 60.
- Heads welded in cylindrical vessels, 93, 94, 98.
- Heat absorbing plates, 70, 96, 100.
- Heat generated by gasification of carbide, 9.
- Hole welding, 98.
- Horse power required for producing oxygen with electrolytic process, 26.
- Horse power required for producing oxygen with liquid air process, 25.

- Hose, diameter of, 31.
fittings, 33.
metal, 34.
repairs, 34.
rubber, 33.
- Hydrogen, basis of manufacture, 2.
bottles for, 3.
chemical properties of, 2, 3.
commercial uses of, 3.
difficulties in welding with, 3, 52.
shipment of, 3.
- Hygroscopic purifying material, 21.
- Illuminating gas, difficulties in welding with, 4.
- Impurities in acetylene, 20, 21.
carbide, 20.
iron, 52.
oxygen, 23.
- Influence of phosphorus in copper, 128.
- Injector burners, 31, 36.
- Installation of pipes by welding, advantages of, 118.
in ships, 110.
methods of, 109, 119.
- Instruction schools for welders, 119.
- Intermediate heads applied to cylindrical vessels, 98.
- Iron, absorption of oxygen by, 54.
autogenous welding of, 52.
carbon percentages in, 50.
cast, 50, 57, 58, 63, 64.
chemical properties of, 50.
decarbonization of, 52.
impurities in, 52.
magnetic properties of, 74.
malleable, 50.
physical properties of, 52.
Swedish, 59.
white, 50, 52, 57, 63.
wrought, 56, 60.
- Iron oxide, influence of, on welds, 61.
melting point of, 60.
methods for destroying, 61.
- Joining of pieces of different thickness, 91.
- Joint rings, application of, 91.
expansion during welding, 92.
position of burner during welding, 92.

- Lead, autogenous welding of, 139.
 soldering of, 139.
 welding of thin sheets of, 140.
- Leaking valves on oxygen bottles, 27.
- Linen cloth for dust filter, 22.
- Liquid air process for producing oxygen, general description of, 24.
 power requirements for, 25.
- Low pressure acetylene, 35.
- Machines for cutting, 46.
 welding, 115.
 repaired by welding, 66.
- Magnetic properties of iron, 74.
- Manufacture of acetylene, 7.
 automobile motors, 101.
 bicycle tubing, 123.
 boilers, 81.
 cooking utensils, 105.
 cooling apparatus, 121.
 conduits, 107.
 cylindrical vessels, 86.
 double shell vessels, 103.
 elbows from sheet segments, 108.
 by unequal heating of sheets, 109.
 fishing rods, 125.
 hydrogen, 2.
 liquid gas, 4.
 metal furniture, 125.
 open sheet metal vessels, 104.
 ornamental articles, 105.
 oxygen, 24, 25.
 pipe, 112.
 radiators, 101.
 rectangular vessels, 99.
 safes, 100.
 ship masts, 126.
 stamped sheet metal articles, 101.
 superheaters, 100.
 window frames, 106.
- Martinsite, characteristics of, 62.
 conditions producing, 62.
 influence on the welding seam, 62.
- Mechanical purifiers for acetylene, 21.
- Melting point of aluminium, 132.
 aluminium oxide, 132.
 copper, 127.

- Melting point of iron, 60.
 iron oxide, 60.
 nickel, 137.
 steel, 60.
- Method of developing a corner in the manufacture of open sheet metal vessels, 104.
- Mild steel, autogenous welding of, 60.
- Miscellaneous articles manufactured by autogenous welding, 105.
- Mixture of gases in burners, 40.
- Naphthaline, 6.
- Nickel, autogenous welding of, 137.
 chemical properties of, 137.
 hammering process in welding, 138.
 melting point of, 137.
 physical properties of, 137.
 repairing of, 138.
 rules for welding of, 139.
 use of heated anvil in welding of, 138.
 welding alloys of, 137.
 welding temperature of, 137.
- Non-hygroscopic purifying material, 21.
- Nozzles of cutting burners, 44.
 welding burners, 37.
- Open sheet metal vessels, manufacture of, 104.
- Ornamental articles, manufacture of, 105.
- Overhead welding, 78.
- Overheated acetylene, effects of using, 14, 54.
 evidence of generation, 11.
- Overlapping of sheets during welding, 87.
- Oxides of aluminium, chemical destruction of, 134.
 general properties of, 132.
 mechanical destruction of, 133.
 melting point of, 132.
 of copper, general properties of, 127.
 methods of destroying, 128.
 iron: general properties of, 61.
 melting point of, 60.
- Oxidizing flame, 37.
- Oxygen, bottles, for shipment, 26.
 handling of, 29.
 impurities in, 23.
 measuring consumption of, 23.
 methods of production, 24, 25, 26.
 pressure for welding, 27.
 testing, 24.

- Oxy-acetylene cutting, data on, 48.
 - speed of, 48.
- Oxy-acetylene flame, chemical properties of, 5.
- Oxy-benzol flame, practical uses of, 4.
 - temperature of, 4.
- Oxy-blau gas flame, difficulties in welding with, 4.
 - practical uses of, 4.
- Oxygraph, 46.
- Oxy-hydrogen cutting, data on, 48.
 - speed of, 48.
- Oxy-hydrogen flame, chemical properties of, 2.
 - difficulties with in welding with, 3.
 - influence of excess of oxygen in, 3.
 - practical uses of, 3.
 - temperature of, 3.
- Oxy-hydrogen welding outfit, 3.

- Pantograph, 46.
- Pearlite, characteristics of, 56.
 - method of determining percentage of, 56.
- Phosphorus in acetylene, 20.
 - copper, 128.
- Phosphuretted hydrogen, 20.
- Pipe flanges, methods of welding, 109.
 - preparation for welding, 109.
 - strength of welded, 109.
- Pipe installation by autogenous welding, 118, 119.
- Pipe manufacture, autogenous, 112, 114.
 - defects to be avoided in, 114.
 - earlier methods of, 112.
 - materials used in, 112.
 - welding machines for, 115.
- Pipe-shaped apparatus, ammonia machines, 121.
 - fishing rods, 126.
 - heat exchange, 121.
 - metal furniture, 125.
 - ship masts, 126.
 - tubing for bicycles, etc., 123.
- Pipe welding machines, burners for, 118.
 - designs of, 115.
 - flame adjustment for, 118.
 - guiding devices for, 117.
 - preheating apparatus for, 116.
 - speed of, 115.
- Piping in the welding shop, 31.
- Pit equipped for welding large cylindrical vessels, 90.

- Polymerisation, phenomenon of, 5, 11, 54.
products of, 6, 11.
- Portable generators, 8, 16.
- Position of burner during welding, 70, 92.
- Powders, welding, for aluminium, 134, 135.
cast iron, 64.
copper, 128.
iron and steel, 61.
- Preheating of boiler sheets, 83.
cast iron, 64.
methods of, 64.
of pipe, 116.
value of, 64.
- Preparation of metal for welding, 59, 70.
- Pressure reducing valves, 26.
- Prevention of cracks in welding of cast iron, 65.
- Puddling process, advantages of, 77.
for aluminium, 133.
boiler repairs, 84.
copper, 131.
iron, 76.
nickel, 138.
silver, 139.
future of, 141.
operation of, 76.
tools for, 77, 139.
- Purification of acetylene, 20, 21.
- Purifiers for acetylene, chemical, 20.
materials for, 21, 22.
mechanical, 21, 22.
- Purifying material, hygroscopic, 21.
non-hygroscopic, 21.
- Purity of oxygen, 23.
- Radiators, manufacture of, 101.
- Rail, welding, use of, 86.
- Rectangular vessels, construction of, 99.
expansion during welding, 99.
location of seams, 99.
position of burner for welding, 99, 100.
use of heat absorbing plates, 100.
welding cover on, 100.
- Reducing valves, cleaning of, 29.
construction of, 28.
operation of, 29.
repairing of, 30.

- Regulation of burners, 39.
 - flame, 37.
- Reheating of metal after welding, 74.
- Repairs by autogenous welding, 63, 138.
- Safes, manufacture of, 100.
- Schoop process of welding aluminium, 135.
- Sheet iron, autogenous welding of, 68.
- Silicon in cast iron, 52, 58.
- Silver, autogenous welding of, 139.
 - hammering process in welding of, 139.
- Stampings of sheet metal, 69, 101.
- Stationary acetylene generators, 8, 12.
- Steel, cutting with autogenous flame, 44.
 - general properties of, 50, 60.
 - percentage of carbon in, 50.
 - cast, composition of, 59.
 - filling material for, 59.
 - welding of, 60.
 - hard, filling material for, 60.
 - welding of, 60.
 - mild, composition of, 50.
 - filling material for, 60.
 - melting point of, 60.
 - welding of, 60.
- Strength of welds in aluminium, 136.
 - cast iron, 59.
 - pipe, 109.
- Styrolin, 6.
- Sulphuretted hydrogen, 20.
- Sulphur in acetylene, 20.
- Superheaters, manufacture of, 100.
- Tacking of pieces before welding, 69, 121.
- Technique of autogenous welding, 1, 141.
- Tee connections welded on large conduits, 107.
- Temperature limits for acetylene generators, 10.
- Temperature of oxy-acetylene flame, 4.
 - benzol flame, 4.
 - hydrogen flame, 3.
 - required for welding pipe, 116.
- Tensions in grey iron castings and their influence on welding operations, 63.
- Testing magnetism during welding, 76.
 - oxygen, apparatus for, 24.
- Thick sheets, bevelling of, 69.

- Thick sheets, failures of welds in, 71.
 filling material for, 70.
 influence of oxides in welding of, 72.
 position of the burner in welding, 71.
 preheating of, 73.
 preparation for welds in, 71, 73.
 reheating of, 74.
- Thin sheets, filling material for welds in, 71.
 flanging for welds in, 68.
 position of the burner in welding, 71.
 preparation for welds in, 69.
- Tools for puddling process, 77.
- Tubing, welded, for aeroplanes, 124.
 automobiles, 122.
 bicycles, 123.
 furniture, 125.
 various designs of, 124.
- Union by welding of cast and wrought iron, 62.
 iron and copper, 140.
- Use of two welding burners simultaneously, 77.
- Value of re-heating of thick sheets, 75.
- Valves for oxygen bottles, 26.
- Vertical welding, 78.
- Water displacement generators, 17.
- Water requirements of acetylene generators, 10, 20.
- Water seal, Fouché, 32.
 Herzfeld, 33.
 inspection of, 33.
 with pressure chambers, 34.
 with signal whistle, 32.
- Water superheated to high temperature, 2.
- Water to carbide generators, 9, 16, 21.
- Welding, autogenous, 1.
 burners, 35.
 industrial applications of, 1, 2.
 machines, 115.
 of aluminium, 132.
 cast iron, 58, 63.
 cast steel, 59.
 copper, 127.
 gold, 139.
 hard steel, 60.
 iron, 61.

- Welding, of lead, 139.
 mild steel, 60, 62.
 nickel, 137.
 pipe, 112, 114.
 sheet iron, 68.
 silver, 139.
 wrought iron, 60.
 pressure of acetylene, 31.
 oxygen, 27.
 puddling process of, 76, 84, 131, 138, 139.
 together cast steel and wrought iron, 62.
 cast iron and copper, 140.
- Welding burners, adjustable, 36.
 back firing of, 41.
 cleaning of, 41.
 construction of, 39.
 equal pressure, 35.
 flame adjustment of, 37.
 gas consumption of, 42.
 injector, 36.
 operation of, 71.
 selection of, 43.
 use of large, 43.
- Welding flame, adjustment of, 37.
 carbonizing, 38.
 chemical properties of, 5, 39.
 neutral, 37.
 oxidizing, 37.
- Welding powder for aluminium, 134, 135.
 cast iron, 58.
 copper, 128.
 iron and steel, 61.
- White iron, characteristics of, 50.
 formation of, 50, 63.
- Window frames, manufacture of, 106.
- Working pressure of acetylene, 31, 35.
 oxygen, 27.
- Wrought iron, autogenous welding of, 60.
 influence of oxides in welding, 61.
 melting point of, 60.
 use of flux in welding of, 61.

THIS BOOK IS DUE ON THE LAST DATE
STAMPED BELOW

AN INITIAL FINE OF 25 CENTS
WILL BE ASSESSED FOR FAILURE TO RETURN
THIS BOOK ON THE DATE DUE. THE PENALTY
WILL INCREASE TO 50 CENTS ON THE FOURTH
DAY AND TO \$1.00 ON THE SEVENTH DAY
OVERDUE.

SEP 18 1938

OCT 13 1938

OCT 14 1938

NOV 4 1938

DEC 5 1938

DEC 12 1938

MAR 17 1939

NOV 15 1939

MAR 13 1940

FEB 17 1941 M

MAR 17 1941 M

MAY 12 1941 M

NOV 9 1941

331179

15227

Kautny

13

UNIVERSITY OF CALIFORNIA LIBRARY

