

arV
16472

ELEMENTARY WOODWORKING



EDWIN W. FOSTER.

Cornell University Library

BOUGHT WITH THE INCOME
FROM THE
SAGE ENDOWMENT FUND
THE GIFT OF

Henry W. Sage
1891

F. 219.373.

9/1/05.

Cornell University Library
arV16472

Elementary woodworking.



3 1924 031 717 121
olin,anx



Cornell University Library

The original of this book is in
the Cornell University Library.

There are no known copyright restrictions in
the United States on the use of the text.

<http://www.archive.org/details/cu31924031717121>

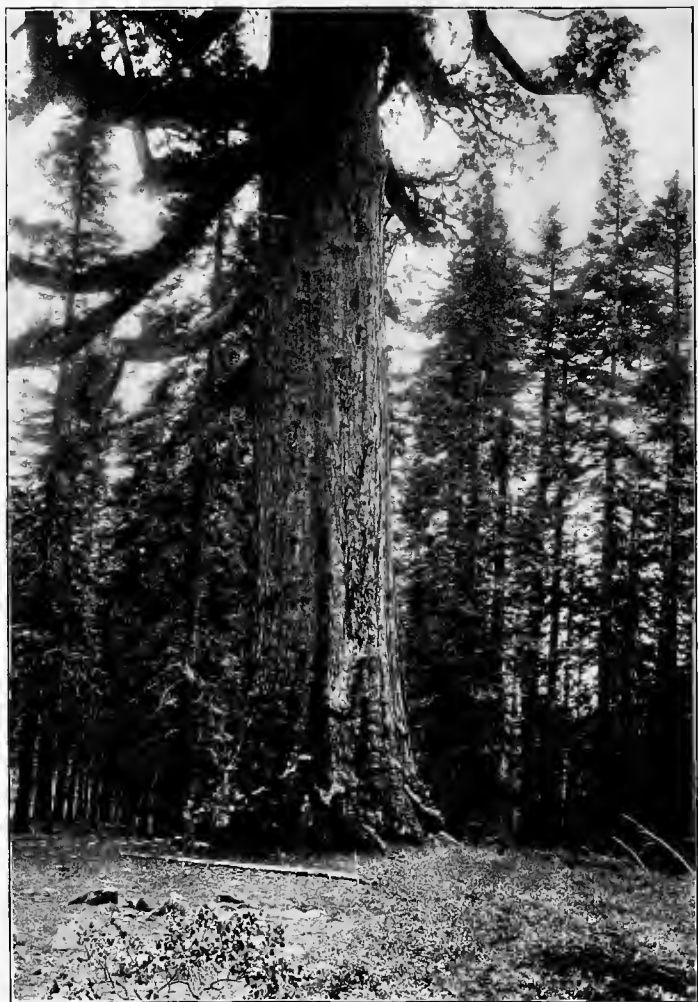

“Grizzly Giant,” a Big Tree in Mariposa Grove, California

ELEMENTARY WOODWORKING

BY

EDWIN W. FOSTER



GINN & COMPANY

BOSTON · NEW YORK · CHICAGO · LONDON

COPYRIGHT, 1903
BY EDWIN W. FOSTER

ALL RIGHTS RESERVED

25.1

The Athenæum Press
GINN & COMPANY • CAM-
BRIDGE • MASSACHUSETT

PREFACE

This text has been prepared for the purpose of furnishing the pupil with the essential facts about tools and their uses. However efficient the instruction may be and however attentive the pupil, it is impossible for him to fully grasp and comprehend during a demonstration the names of tools and technical terms, most of which are new to him. This applies with equal force to the manner of using the tools and to the methods of working.

The function of the text is to supplement the instruction of the teacher. It is intended to gather up and arrange in a logical order the facts which the pupil has already been told. By this means these facts will become fixed in the mind of the pupil and he will work with a better understanding and make greater progress.

It is believed that the text can be used to the greatest advantage by requiring the pupil to read up the subjects presented in class immediately *after* the close of the lesson. Frequent rapid reviews and occasional written tests are very effective.

No course of study in the form of a series of models is presented. It is hardly possible for any two schools to follow the same series of models. Local conditions necessarily affect the choice of a course, while new and better designs are being brought out continuously.

The order in which the tools are described in the following pages is the one that has seemed most natural. They may be taken up, however, in any convenient and logical order.

It is with the earnest hope that nature study and manual work may be closely correlated, that Part II is added. No better period can be selected in which to study trees, their leaves, bark, wood, etc., than when the student is working with wood, learning by experience its grain, hardness, color, and value in the arts.

Occasional talks on the broader topics of forestry, its economic aspects, climatic effects, influence on rainfall, the flow of rivers, floods, droughts, etc., will be found interesting as well as instructive, and such interest should be instilled into every American boy and girl.

The writer is indebted to the Fish, Forest, and Game Commission of New York state for the series of Adirondack lumbering scenes, and to the United States Bureau of Forestry for the views of California Big Trees.

EDWIN W. FOSTER.

CONTENTS

PART I. TOOLS

	PAGE
Chapter I. Introduction	3
General directions regarding care of tools and bench. Plan of work and division of tools into groups.	
Chapter II. Measuring and Marking Tools	5
The rule: divisions; method of using. The try-square: method of handling. The framing square. The marking gange. The bevel.	
Chapter III. Cutting Tools	11
Saws: necessity for two classes; shape of teeth; set; tapers; method of holding. Backsaw; use of bench hook. The turning saw. The plane: use of cap iron; names of parts. Adjustment of plane. Use of lever and adjusting screw; positions for planing. The jack plane. The smooth plane. Jointers; action of short and long planes. The block plane. The wooden plane. The chisel: size of cutting angle; effect of careless sharpening. The framing and firmer chisels; proper positions for horizontal and vertical cutting. Sharpening on oilstone. Brace and bit. Center and auger bits; gimlet and countersink bits. The spokeshave.	
Chapter IV. Miscellaneous Tools and Methods of Work . . .	31
The hammer; use of nail punch. The mallet. The screw-driver. Sandpaper, use of. Squaring up stock; method explained in detail. Laying out work; method of laying out a typical joint. Securing parts; use of glue and hand screws. Nails; method of using cut nails. Screws; method of using round-head and flat-head screws. Mechanical drawing. The drawing instruments explained, and method of making complete working drawings described. Scale drawings.	

PART II. WOOD

PAGE

Chapter V. Lumbering and Milling	51
The forest ; felling trees and floating logs to the mill. The forming and breaking up of log jams. The log boom and modern saw-mills. Timber and lumber defined. Annual rings ; medullary rays ; formation of grain. Characteristics and defects in wood. Warping and shrinkage.	
Chapter VI. Broad-Leaved Trees: the Oaks	65
White oak. Post oak. Mossy-cup oak. Black and black-jack oak. Red oak. Scarlet and pin oaks. Chestnut oak. Live oak.	
Chapter VII. Broad-Leaved Trees: the Maples	76
Sugar and Norway maples. Silver and red maples. Sycamore maple. Moosewood. Maple keys. Ash-leaved maple. Japan maples.	
Chapter VIII. Broad-Leaved Trees having Compound Leaves .	85
Horse-chestnut. Buckeye. The hickories. Black walnut and butternut. Locust. Honey locust. Ash.	
Chapter IX. Broad-Leaved Trees having Simple Leaves . . .	94
Elm. The birches. Beech. Ironwood. Buttonball. Sweet gum. Tulip. Basswood. Willow. The poplars. Sassafras. Mulberry.	
Chapter X. The Evergreens	111
White pine. Georgia pine. Yellow pine. Hemlock. Spruce. Cypress. Balsam fir. The cedars.	
Chapter XI. The Big Trees of California	123

ELEMENTARY WOODWORKING

PART I

CHAPTER I

INTRODUCTION

In order to obtain good results in the using of tools it is necessary to know their construction, how to properly sharpen and adjust them, and the correct method of handling them. It is also essential to know how to lay out and work the material or stock. Carelessness or a lack of knowledge is invariably followed by a failure. It is more important at first to work carefully and accurately than rapidly.

“Tools are made to be used, not abused.” They must be kept *clean* and *sharp* and should be used only for the purpose intended. Wipe them off occasionally with an oily rag or waste to prevent them from rusting. Put away all tools not in use and keep the top of the bench clean. Do not mark it with a pencil or scratch it with a knife. Do not cut into it with the chisel or allow other tools to mark or deface it. When using glue, shellac, or similar materials, cover the top of the bench ; or, better still, do the work on a table provided for that purpose.

The plan of work in making all models is in general the same and is as follows :

First. "Squaring up" the stock.

Second. "Laying out" the work.

Third. Cutting to the lines.

When the article is composed of two or more pieces a fourth step may be added, namely, fitting and securing the parts.

The tools used may be divided into three groups, as follows :

First. Laying-out tools. These include the rule, try-square, marking gauge, bevel, and knife.

Second. Cutting tools. In this group are the saw, plane, chisel, spokeshave, bit, and knife.

Third. Miscellaneous tools, such as the hammer, mallet, screw-driver, brace (or bitstock), and others not so common.

CHAPTER II

MEASURING AND MARKING TOOLS

1. **The Rule.** The standard unit of length is the yard, but the foot is commonly used for all measurements in woodwork. If the rule be twelve inches long it is known as a foot rule, and if twenty-four inches long it is called a two-foot rule. The inches are subdivided into halves, quarters, eighths, and in some cases sixteenths. Rules are usually of boxwood or maple, with



FIG. 1. The Rule

brass joints, and are commonly made to fold once or twice.

The rule is quite thick, and if laid flat upon the work to be measured errors will usually follow. It should be stood on edge so that the pencil or knife point may touch the divisions on it and the wood at the same time. The proper position when laying out measurements is

shown in the sketch (Fig. 2). Consecutive measurements should be laid off without moving the rule.

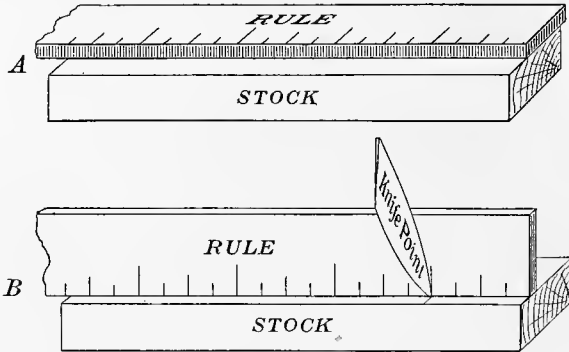

FIG. 2. Methods of using the Rule: *A*, incorrect; *B*, correct

2. The Try-Square. The try-square has two distinct uses: first, to act as a guide for the pencil or knife

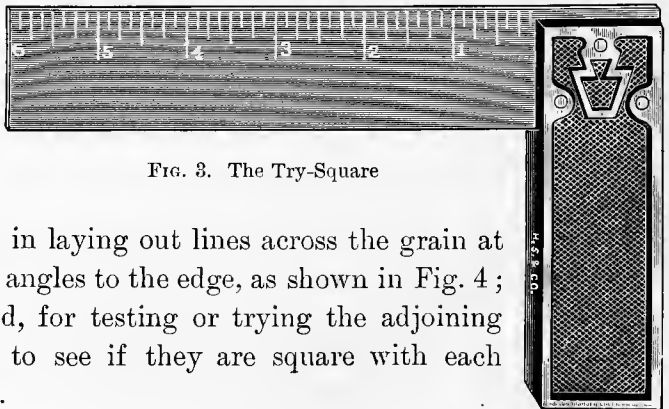

FIG. 3. The Try-Square

point in laying out lines across the grain at right angles to the edge, as shown in Fig. 4; second, for testing or trying the adjoining sides to see if they are square with each other.

The try-square may be made entirely of iron or steel, but sometimes the beam *A* is of wood with a brass strip *C* to protect it and to take the wear. The

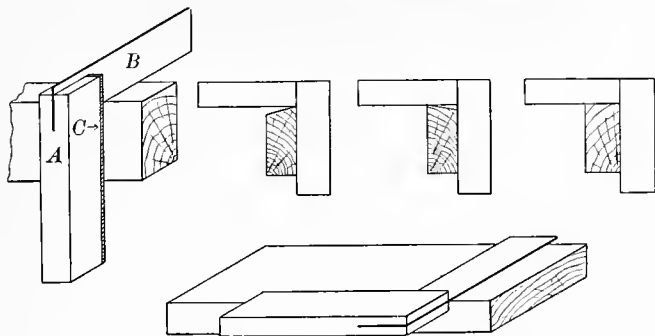

FIG. 4. Methods of using the Try-Square

blade *B* is of steel and is divided, like a rule, into inches and fractions of an inch. Try-squares are made in several sizes, the most convenient for general use being six inches.

In using the try-square the beam should be held firmly against the face or edge of the stock. When working near the end of the piece, if the beam projects, reverse its position. For nice, accurate work the knife point instead of the pencil should be used for lining.

When it is desired to saw off the end of the stock it is first necessary to mark or square clear around it with the knife and try-square. In doing this the beam of

the try-square must be used against the work face and joint edge only. Large squares made of steel in one



FIG. 5. The Framing Square

piece are called *framing squares*, and are used by carpenters and others for rough or large work.

3. The Marking Gauge. The marking gauge is shown in Figs. 6 and 7. *A* is the gauge stick, *B* the gauge block, *S* the set screw, and *P* the marking point, or *spur*. The gauge stick

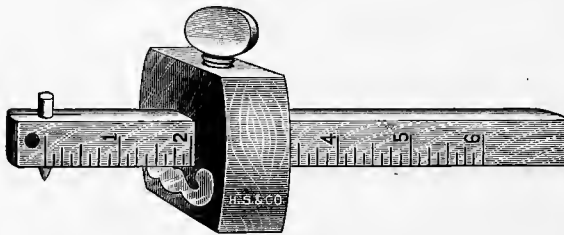

FIG. 6. The Marking Gauge

is graduated like a rule into inches and fractions, beginning at the steel marking point; but as the latter is not always exactly in the right place the graduations are not entirely reliable. It is safer then to set the gauge with the rule in the manner shown in Fig. 7.

Hold gauge bottom side up in left hand and rule in right. Place end of rule against gauge block and

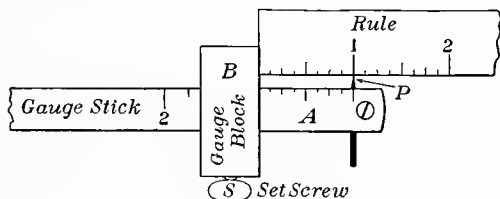

FIG. 7. Setting the Marking Gauge

the measurement desired at spur. Turn set screw. The gauge is then accurately set. In the cut the gauge is set at one inch and is ready for use.

To gauge a line parallel to the edge of a block hold the tool firmly, with thumb and forefinger encircling gauge block. Tip the tool away from you until the marking point (spur) barely touches the wood and push the tool away from (never toward) you. The line made should be as fine as a knife line. A little prac-

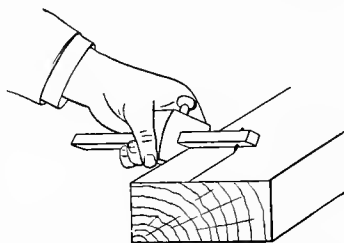

FIG. 8. Holding the Marking Gauge

tice is needed to give the proper control, as the marking point tends to follow the grain of the wood, which is usually not straight.

A good plan is to use a small piece of prepared stock as a practice block, laying out lines a quarter of an inch apart, then an eighth, and finally a sixteenth.

4. The Bevel. The bevel differs from the try-square in having a movable blade.

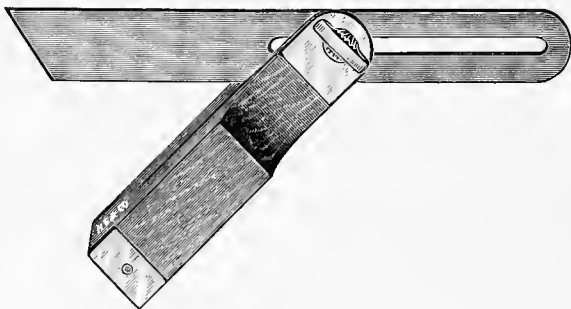

FIG. 9. The Bevel

This tool may be used to lay out lines at any angle from zero to 180 degrees. The blade may be fixed firmly at any desired angle by simply turning the set screw. The method of using it is similar to that of the try-square.

CHAPTER III

CUTTING TOOLS

5. **Saws.** The saw might be described as a succession of chisels, one back of the other. We can readily understand the action of the saw by making cuts with a narrow chisel along the grain of a piece of wood, as shown in Fig. 10 at *a*.

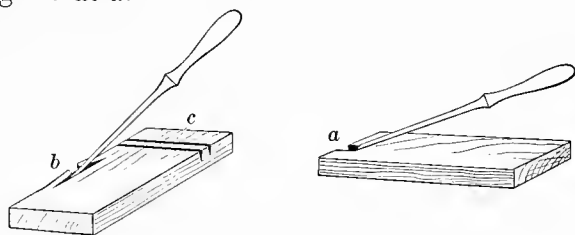

FIG. 10. Cutting with and across the Grain with a Narrow Chisel

The little pieces of wood removed in this way are similar to the sawdust made by the saw, the only difference being that in the saw the teeth are narrower and the little pieces consequently smaller, and instead of one chisel dozens are being pushed forward at one time.

A saw with these chisel-shaped teeth, and used for cutting along the grain, is called a *ripsaw*.

That this tool will not cut so readily across the grain may easily be proved by again resorting to the narrow chisel and attempting to repeat the first experiment. The wood will act as shown in Fig. 10 at *b*, splitting along the grain in both directions. It is quite evident, then, that a tool for cutting across the grain must be constructed in some other way.

Continuing this experiment, let us cut the fibers with a knife point in two parallel lines across the grain,



FIG. 11. The Saw

close together, as at *c*. It will be found that the wood between these lines may now be easily removed with the narrow chisel. This fact is made the basis on which we construct the crosscut saw. Every tooth is sharpened to a point, one on the right side, the next on the left, giving two parallel lines of sharp points designed to cut the fibers, as was done in our experiment with the knife. Fig. 12 shows the end view of the crosscut teeth enlarged. Observe that not only are the alternate teeth sharpened on opposite sides, but

each tooth is bent outward from the body of the saw. This bending is called *set*, and is designed to make the saw cut, or *kerf*, wider than the thickness of the saw, that the latter may pass easily through the wood after the teeth have done their work. If it were not for this set, the fibers would spring back against the body of the saw after the teeth had passed and make the work very laborious. When a saw is properly set it should pass through the wood easily.

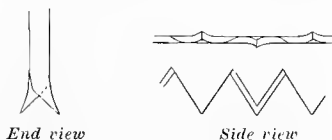

FIG. 12. Teeth of Crosscut Saw

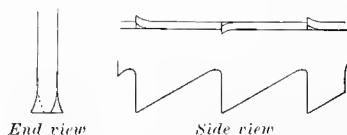

FIG. 13. Teeth of Ripsaw

The teeth of the ripsaw are also set, but, as will be seen in the sketch, the bottoms are flat like a chisel instead of pointed like those of the crosscut teeth.

Beside the end views of the two kinds of teeth, the side views, which are also different, are shown in Figs. 12 and 13.

We are inclined to think of the saw as a very commonplace article, yet a careful examination will prove that the greatest care and skill are needed in its manufacture. Observe that the body, which must be of the best steel, tapers, being considerably wider at the

handle than at the opposite end. This is to give strength, and to prevent *buckling*, or bending, as the tool is pushed forward.

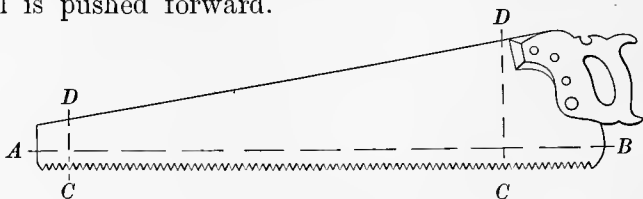

FIG. 14. Body of Saw, showing Tapers

Most delicate measurements must be made, however, to discover that not only the width but the thickness increases from *A* to *B*, and decreases from *C* to *D*. How carefully this tapering must be done can be realized when we know that the difference in thickness from *A* to *B* is only three one-thousandths of an inch, and from *C* to *D* twelve one-thousandths at end *A*

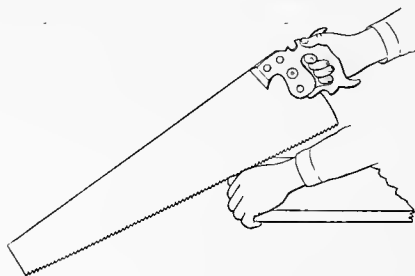

FIG. 15. Method of holding the Saw

and five one-thousandths at end *B*.

The saw should be held in the right hand, with the left grasping the board. The thumb of the left hand acts as guide, the saw is tilted, as shown in Fig. 15, and drawn toward the worker at the first stroke. This tool should

be used without exerting much pressure, in accordance with the general rule that we do our best work with tools when we work easily and deliberately.

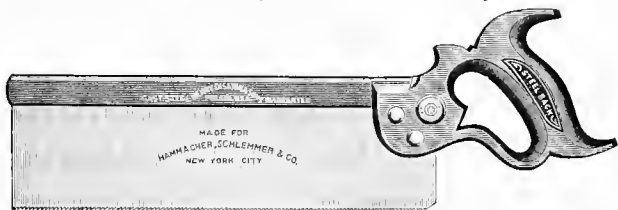

FIG. 16. The Backsaw

Many varieties of saws are designed for special purposes, including those which cut stone and metal.

6. Backsaw.

The backsaw is a crosscut saw with small teeth, and has a heavy steel backpiece, Fig. 17, to prevent bending. In this respect it differs from the ordinary crosscut varieties, which bend

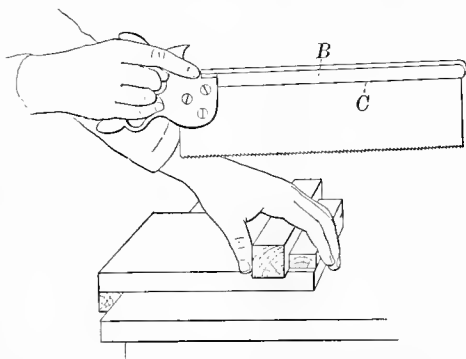

FIG. 17. Method of using the Backsaw and Bench Hook

readily. The purpose of the backsaw is to make fine, straight cuts in delicate, accurate work. The steel

back *B* is necessary on account of the thin blade, but on account of the thickness of *B* no cut can be made

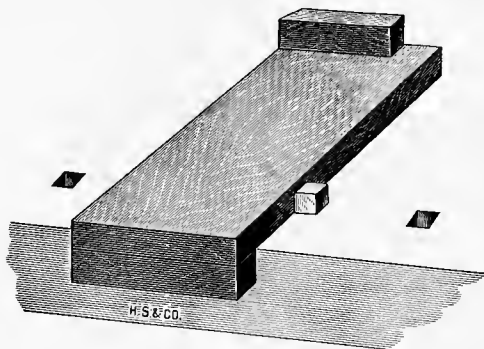

FIG. 18. The Bench Hook

deeper than the line *C*. This tool will cut in any direction with reference to the grain, but is primarily a crosscut saw.

7. The Turning Saw.

In ordinary work the saw is supposed to cut to a straight line, but there are certain classes of work where it is desirable

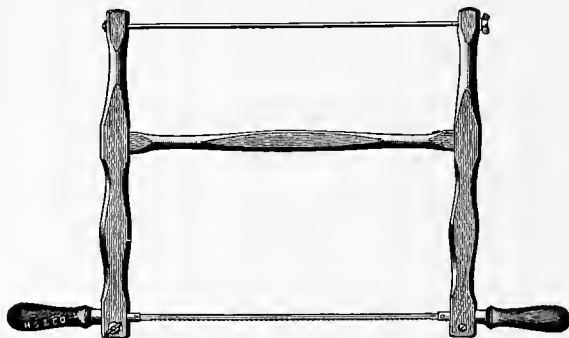

FIG. 19. The Turning Saw

to follow a curved line, and consequently a special tool is necessary. The turning saw shown in the cut is used for

this purpose. The handles holding the saw blade may be turned in any direction with reference to the frame.

8. The Plane. The plane reduces our rough lumber to planed, or *dressed*, stock. The cutting part is a thin, wide chisel called the *plane iron*.

Fig. 20 shows the position of the plane iron in operation. Assume the iron to be moving in the direction of the arrow on a piece of wood. The sharp point would enter the board and, should the grain be unfavorable, start a splitting action, as shown at *a*.

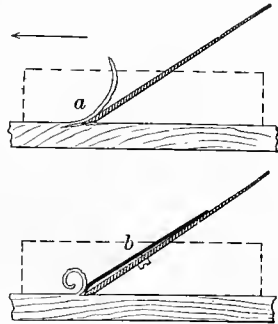

FIG. 20. The Plane Iron in Action

We wish to smooth the wood instead of roughing it, and must in some way stop the splitting.

This is accomplished by placing a cap iron on the plane iron, as shown at *b*. The cap bends and breaks the shaving before the splitting action has a chance to begin, and gives the spiral form so familiar in wood shavings.

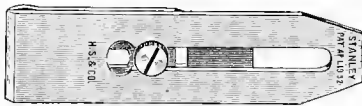

FIG. 21. Plane Iron, Cap, and Set Screw

The cap is firmly fastened to the plane iron by a stout screw, and this whole combination is fastened in

the throat of the plane by a clamp (Fig. 22). The opening on the bottom of the plane through which the cutting edge protrudes is called the *mouth* of the plane.

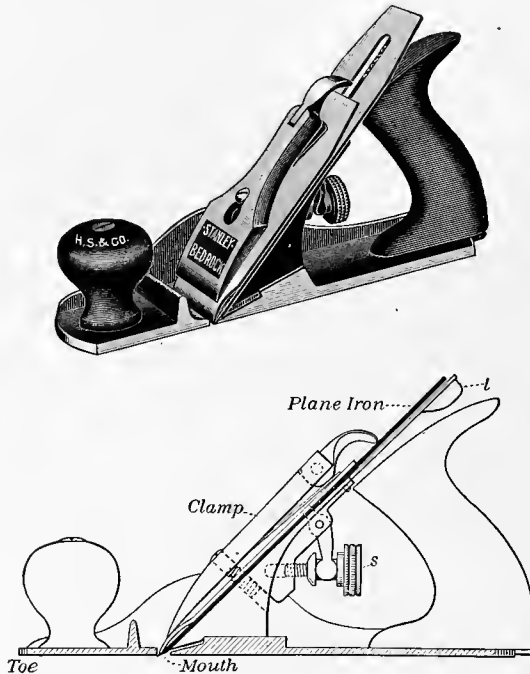

FIG. 22. Sectional Views of Iron Plane

9. Adjustment of Plane. There are two ways of adjusting a modern iron plane,—by means of the set screw *s*, and of the lever *l*.

Screw *s* lowers or raises the plane iron so that we may take a thin or thick shaving, and lever *l* straightens the iron, which is liable to project more on one side than on the other, and will then take a shaving thicker on one side than on the other.

Before using the plane always examine it carefully. Invert the tool, holding it toward the light with the toe toward you, and glance along the bottom. If the iron projects, observe whether it is even, and if not, move the lever until it is. For a thin shaving the cutting edge should appear as a black line of uniform thickness. For a heavy shaving turn the brass screw until the iron projects slightly.

In using the plane avoid a stooping position. Stand with the right side to the bench and with the shoulders thrown back. Let the pressure of the left hand be greater at the beginning and that of the right hand at the end of the stroke. The tool should rest perfectly flat on the wood from start to finish.

10. The Jack Plane. The ordinary plane iron has a straight edge, as shown at *a*, Fig. 23, but when a large quantity of wood is to be removed the iron is sharpened in the shape shown at *b*. This curved iron will cut out the wood in hollows, leaving ridges between, and it

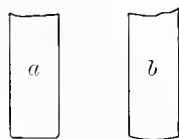

FIG. 23. Irons of Smooth and Jack Planes

is necessary to follow this jack plane with a finer one having a straight edge in order to smooth the surface. The jack plane might be called a *roughing* plane.



FIG. 24. Relative Sizes of Smooth and Jack Planes

The lower figure is a jack plane

11. The Smooth Plane. The smoothing plane is shorter than the jack plane, its object being to smooth the surface without regard to straightening it, as it is supposed that the straightening has previously been done. The

cap iron in the smooth plane should be set from a sixteenth to a thirty-second of an inch from the cutting edge of the plane iron.

12. Jointers. For straightening very rough and uneven stock a long plane is necessary (Fig. 25). In the illustration let line *ab* represent the edge of a very uneven board. A short plane *c* would simply follow the hills and hollows, smoothing but not straightening it, while a long plane,

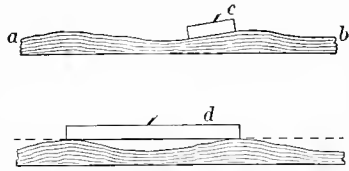

FIG. 25. Action of Short and Long Planes

as shown at *d*, would merely cut off the top of the high places, as shown by the dotted line, and would not touch the bottoms of the hollows until all the elevations were leveled; in other words, until the surface was straightened. Such planes, which are often three feet long or more, are called *jointers*.

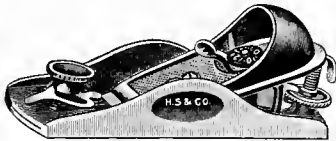

FIG. 26. The Block Plane

13. The Block Plane. To square the end of a piece of stock the conditions are quite different from those just described where we were planing with the grain. In end planing no cap iron is necessary, the plane iron in the block plane being reversed with bevel side up.

This tool requires more care than the others, as the stroke is usually quite short, and if the cutting edge is allowed to reach the farther corner, the latter will be broken off.

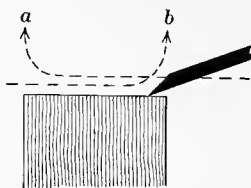

FIG. 27. Method of using
Block Plane

To avoid this error the plane must be lifted up before the end of the stroke, as shown by the dotted line *a*. The piece is then reversed, and planed as shown by

arrow *b*. In this way the whole end is smoothed, without ruining the corners.

Besides these standard planes there are many patent and special ones for cutting tongues, grooves, beads, etc.

14. The Wooden Plane. Although the iron-bodied planes just described are now in common use, the old-fashioned wooden plane is still the favorite of many woodworkers.



FIG. 28. The Wooden Plane

This tool, while lacking some of the adjustments of the iron plane, was much simpler and contained a smaller number of parts.

The iron and cap were held in position by a wooden wedge, which was driven in by a light blow of the hammer. The workman removed the iron and wedge by turning the plane upside down and striking the forward part a light downward blow on the bench, while the thickness of the shaving was increased by a light tap on the plane iron.

One of the chief objections to the wooden plane was its liability to wear and warp, so that it became necessary to straighten, or *joint*, the face. No such difficulty is encountered in the iron-bodied plane.

15. **The Chisel.** The chisel is one of the simplest forms of cutting tools. The size of the angle a depends on the kind of material to be cut.

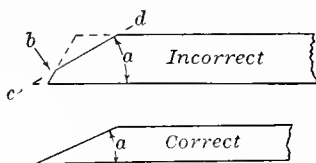

FIG. 29. Cutting Angle of Chisel

A chisel for cutting wood must be sharpened to an angle of from 30 to 35 degrees.

By careless sharpening an extra bevel is sometimes formed, as shown at b .

The cutting angle is then no sharper than if the chisel were shaped like that shown by dotted lines, and care must always be taken when sharpening to keep the line cd straight, so that angle a will be the real cutting angle.

Two classes of chisels are in common use: the *framing chisel* used for heavy work, such as the frames of buildings; and the *firmer chisel*. The framing chisel



FIG. 30. The Framing Chisel



FIG. 31. The Firmer Chisel

is strong and heavy, and has a handle capable of withstanding the blows of a mallet. The firmer chisel is designed for finer and lighter work without the mallet.

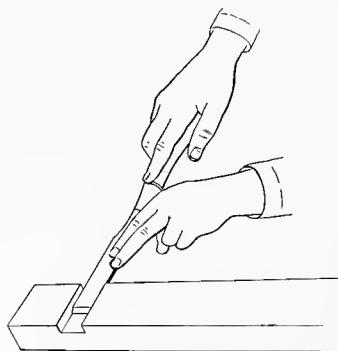

FIG. 32. Proper Position for Horizontal Chiseling

The chisel must be sharp if we wish to do good and accurate work, and a cut on the hand made by such a sharp tool is liable to be a deep one. Special care must be used in handling it, keeping both hands away from the cutting edge, as shown in the sketch, and placing it when not in use where it cannot be pushed off the bench on to the floor or the student's feet.

Fig. 32 shows the method of using the tool on horizontal work, and Fig. 33 for vertical cutting. For this

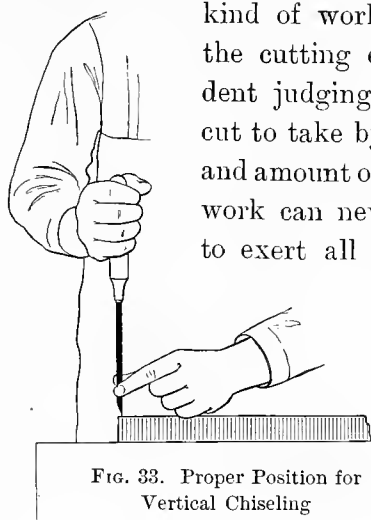

FIG. 33. Proper Position for Vertical Chiseling

kind of work only a small portion of the cutting edge can be used, the student judging for himself how heavy a cut to take by the hardness of the wood and amount of strength required. Good work can never be done when one has to exert all his strength on the tool.

The best results are obtained when we work easily.

Better work can usually be done with the chisel if, instead of pushing it straight ahead or straight downward, we incline it somewhat so as to secure a slight *paring* action.



FIG. 34. Sharpening Chisel on Oilstone

When the chisel becomes dull, unless its edge has been nicked or ruined by some accident, it is only necessary to sharpen it on the oilstone. Hold the tool

with the bevel flat on the stone. A drop or two of oil may be used to lubricate the stone, the tool being worked back and forth on the face of it. Especial care must be taken to avoid a rocking motion, which will produce a curved edge instead of a flat one.

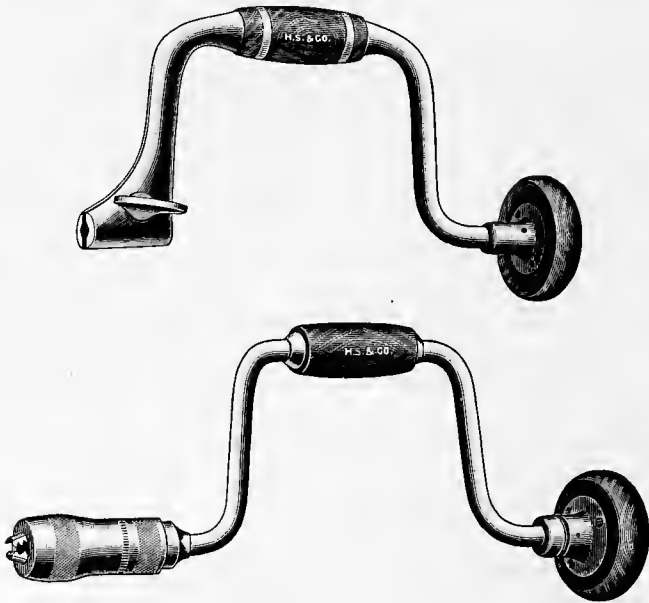

FIG. 35. Common Forms of the Brace

After the rubbing, reverse the chisel, lay the flat side firmly on the stone, and draw toward you. This is to straighten the wire edge which has been turned over by the rubbing. The wire edge may then be removed

by drawing the cutting edge across the end of a block of wood. When the chisel is nicked or very dull it must be ground on the grindstone.

16. Brace and Bit. The old-fashioned augers and gimlets have given way to the modern brace and bit.



FIG. 36. The Center Bit

The brace, which is sometimes called the bitstock, allows both hands to be used continuously, which was not true of the old-fashioned auger. Several varieties of the brace are in use, the ones shown in the cuts being common.

Bits are designed for a variety of purposes, the name being applied to a tool which is to be turned by the



FIG. 37. The Auger Bit

brace. The old-fashioned center bit shown in the cut possessed most of the essentials of a good boring tool.

The sharp spur in the center allowed the hole to be accurately placed. The lip on the outer edge cut the fibers in a circle before the chisel edge began to remove

the wood, and so a smooth hole could be bored; but considerable pressure was necessary to force the tool through the wood.

The progress that has been made in the manufacture of tools can be easily appreciated by comparing this center bit with the modern auger bit.

Referring to the sketch (Fig. 38), *BB* are two knife points, or *nibs*, which cut the wood fibers before the

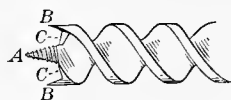

FIG. 38. Details of
Auger Bit

chisel edges, or *lips*, *CC*, can touch the wood. The point *A* allows us to accurately place the center of the hole where we wish it, and the screw back of *A* draws the tool into

the wood as it revolves. This part is known as the spur, or *worm*. On this class of bits no pressure is necessary.

The opposite end of the bit, called the *shank*, fits into the brace. Any tool with such a shank, and designed for use with the brace, is a bit. We have screw-driver bits, gimlet bits, auger bits, etc.

On the shank of an auger bit will be found a number. This is the numerator of a fraction whose denominator is 16. If we find this number to be 4, it is a $\frac{4}{16}$, or a $\frac{1}{4}$ -inch bit. If the number is 16, we have a $\frac{16}{16}$, or a one-inch bit, etc., always referring to the diameter of the hole which the tool will bore.

In using the brace and bit care must be taken to see that the bit shank is far enough in the brace to be fastened securely, and that the tool is held at right angles to the wood. It may appear from the front to be perfectly vertical, yet by stepping to one side and looking at it from another position it will frequently be found far from vertical. When starting a hole it is well to do this several times until assured that the tool is working in a true upright position.



FIG. 39. The Gimlet Bit



FIG. 40. The Countersink Bit

The gimlet bit is used for small holes, such as we make for screws. In this case the hole must be *countersunk* to receive the screw head, when flat-headed screws are used. The countersink bit is shown in the cut, and its purpose is more fully explained in the chapter on screws.

17. The Spokeshave. The spokeshave is practically a short plane with handles at the side so that the tool may be drawn or pushed. It may be adjusted by means of screws to take light or heavy shavings, and

is used principally to smooth curved surfaces. The forming of a hammer handle is a good illustration of



FIG. 41. The Iron Spokeshave

the kind of work it will do. It may be worked toward or away from the worker, and is an exceedingly handy tool.

CHAPTER IV

MISCELLANEOUS TOOLS AND METHODS OF WORK

18. Hammer. The carpenter's hammer is used principally to drive or withdraw nails.

The various trades have hammers made specially for their needs; thus we have machinists', roofers', upholsterers', stonecutters', and other hammers, but the claw hammer shown in the

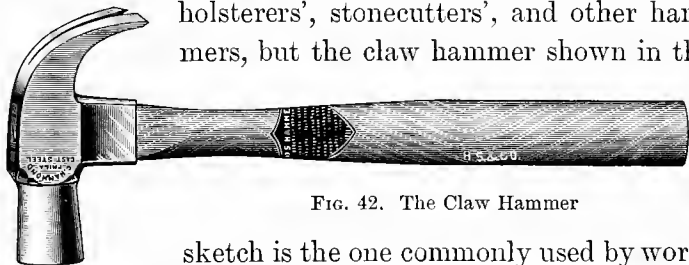

FIG. 42. The Claw Hammer

sketch is the one commonly used by workers in wood.

The head *a* (Fig. 43) is of steel, with the face *b* specially hardened so that it may not be dented by the nails. Notice the length of the handle *h*. This length did not simply happen. Had it been intended to hold the tool in the position shown at *A*, the handle would not have been made so long. The proper position is that shown at *B*. Position *A* is frequently taken by beginners, and should be studiously avoided.

A nail may be withdrawn with the claw, and be kept straight for further use by a little care. Having

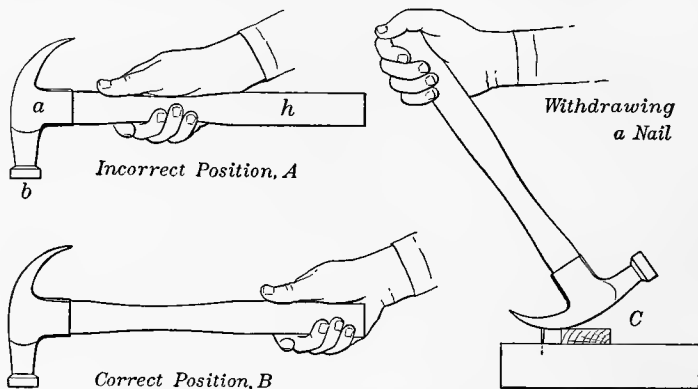

FIG. 43. Using the Hammer

started the nail slightly, place a small block of wood under the hammer head, as shown at *C*. Should the nail be an unusually long one, the size of the block may be increased as the nail comes out.

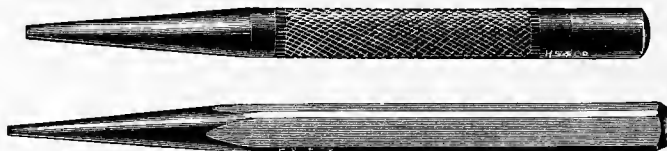

FIG. 44. Common Forms of Nail Punch, or "Set"

In driving nails care must always be taken not to mar the surface of the wood by striking the nail head after

it has become even with the surface, as this produces a depression and ruins any fine surface.

If it is desirable to sink the nail head below the surface, a nail punch, or *set*, is used. This is always necessary when the surface is to be planed after the nailing.

19. The Mallet. The mallet might be described as a hammer with a wooden head, and is used whenever we wish to deliver a blow which shall be less concentrated than that of the

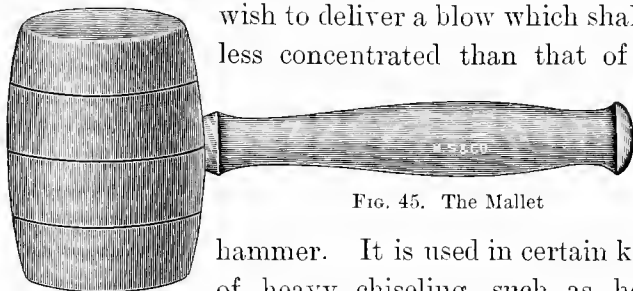

FIG. 45. The Mallet

hammer. It is used in certain kinds of heavy chiseling, such as house framing, and gives a blow which does not shatter the tool handle as a hammer would.

The use of the mallet is well illustrated by the making of a mortise-and-tenon joint, the chisel and mallet being used to cut the opening known as the mortise, as shown in Fig. 46.

20. Screw-Driver. The screw-driver is perhaps the most common of household tools, and is probably abused more than any other. The handle is usually flattened so that the hand may grip it more tightly, but occasionally a round or fluted handle is seen.

Patent spiral screw-drivers have come into use in recent years, but where considerable force is required the brace and screw-driver bit are more effective.

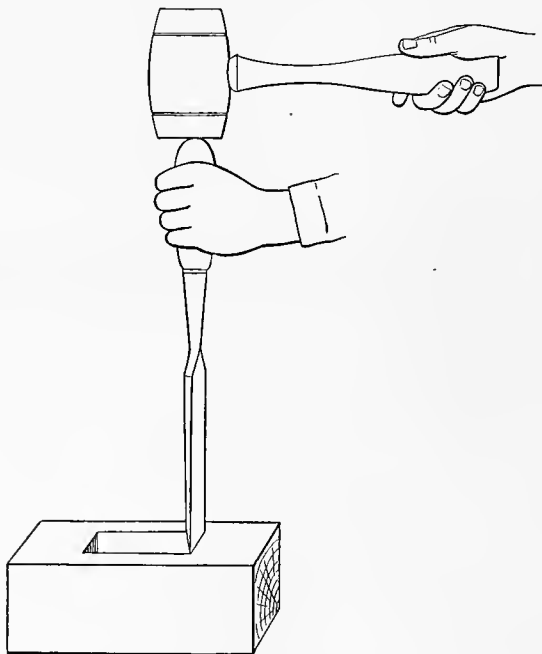

FIG. 46. Cutting a Mortise

21. Sandpaper. "Sandpaper is the last resort of a poor workman." This statement has been made by many teachers to many thousands of students, and is

true in many cases; but there are certain kinds of work where sandpaper, if properly used, is allowable.

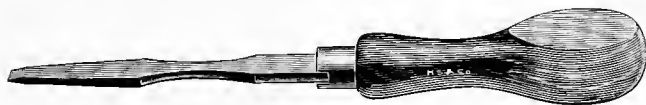

FIG. 47. The Screw-Driver

It must always be kept in mind that a surface which has been sandpapered has become "gritty," i.e. the fine sand has come off and is more or less imbedded in the wood. Consequently sandpapering must not be done until all tool work has been finished, as the grit will take the edge off the best tool, and the finer the edge the more quickly will it be ruined.

Again, a sandpapered surface is always a scratched surface, and the finest of scratched surfaces cannot compare with the perfectly smooth, satiny surface produced by a sharp plane. However, there are many places where neither the plane nor spokeshave can be used, and here it is allowable to use sandpaper after the tool work has been carried as far as practicable.

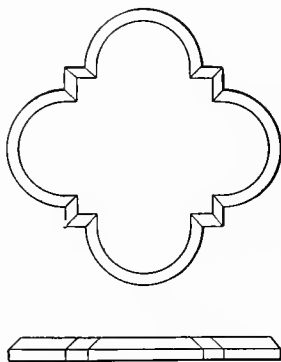

FIG. 48. An Exercise involving the Use of Sandpaper

been carried as far as

Fig. 48 is a case where sandpaper may be used with propriety. The bevels in this lesson are to be chiseled and then sandpapered with a sandpaper block, — the block in this case being simply a small piece of wood with square edges, about which the sandpaper is fastened closely.

Curved articles, such as the hammer handle, must dispense with the block, the sandpaper being held in the hand.

22. Squaring up Stock. This term simply means to reduce a piece of sawed or rough lumber to one having smooth, flat sides at right angles to each other, and of definite length, breadth, and thickness (see Fig. 49).

First. Straighten one face with fore plane, jack plane, or jointer, and smooth with smoothing plane. This face, called the working face, becomes the basis from which all the other sides are squared.

Second. Plane one of the adjoining edges and make square with the working face. This edge, known as the joint edge, must be thoroughly tested throughout its entire length with the try-square, and must be square with the working face at every point.

Third. Set marking gauge at required width and with gauge block against the joint edge, gauge a fine line on working face.

Fourth. Plane down second edge to gauge line, just drawn, squaring the edge with working face.

Fifth. Set gauge to required thickness and gauge line on both edges from working face.

Sixth. Plane face parallel to working face down to the two gauge lines. This gives the required thickness. It only remains now to secure the required length.

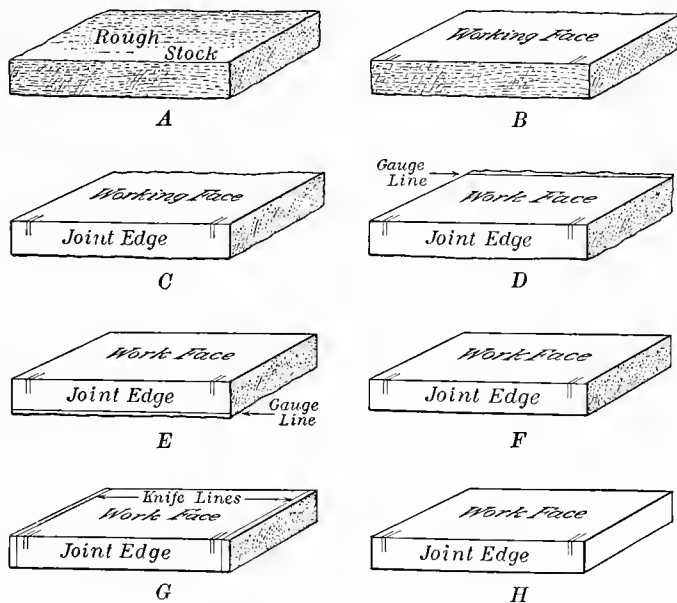

FIG. 49. The Successive Steps in squaring up Stock

Seventh. Square knife line around the four smoothed sides with knife and try-square as near one end as possible, carefully observing the precautions given in Chapter II.

Eighth. From the line just drawn, measure the required length along edge of working face and square a line on the four sides at the last point, as at first end.

Ninth. Block-plane first end to knife lines. If the second line is more than an eighth of an inch from the end of block, saw to the knife line with backsaw, and block-plane smooth and square.

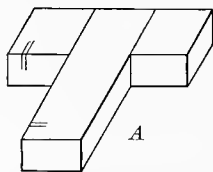
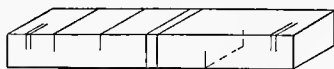
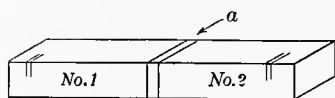

FIG. 50. Successive Steps in laying out and making a Middle Lap Joint

Sixth. Measure length of lap on No. 2, square the line across bottom and halfway up the sides. Gauge the horizontal lines *ll* from working face.

The above method should always be followed in preparing stock for laying out the exercise.

23. Laying Out. Let it be assumed that the exercise to be executed is the middle lap joint shown at *A*, Fig. 50.

First. Square up stock, leaving ends rough.

Second. Lay off the length of each piece, in this case $4\frac{1}{2}$ inches, with an eighth of an inch between for sawing, as at *a*.

Third. Square all the lines around four sides.

Fourth. Saw to end lines and block-plane ends.

Fifth. Lay off width of opening in piece No. 1 and square lines across face and half-way down on both edges.

Seventh. Saw pieces No. 1 and No. 2 apart and block-plane ends.

Eighth. Saw to the lines, chisel, and fit the pieces.

Although the above is the method of laying out a typical joint, each problem will require special treatment and here the student will be guided by his instructor.

24. Securing Parts.

Many articles made of wood consist of several pieces fastened together.

When two pieces are fitted together the surfaces of contact are called a joint. There are many kinds and shapes in joinery, and usually some extra fastening is required to hold the pieces together. These aids are glue, nails, and screws; while on heavy construction still others, such as wedges, pins, and dowels are used. The first three are commonly used in small work.

Glue is of two kinds, fish and animal. Both are made from refuse matter, — animal glue being manufactured from such products as bone, horn, hoofs, and hide.

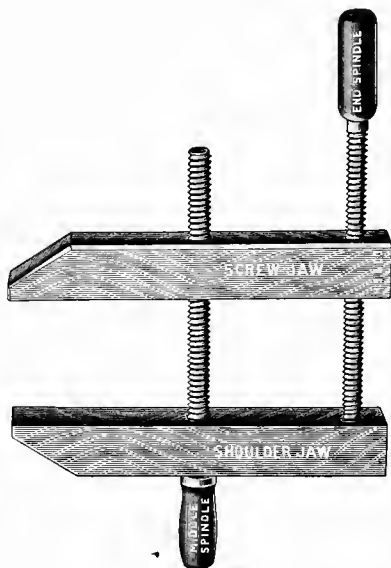

FIG. 51. The Hand Screw

The dry glue in the form of chips must be dissolved in water and heated, being applied while hot. Liquid glues sold in cans ready for use are now very common and require no heating.

In making a glued joint it is usually necessary to hold the pieces tightly together until the glue has *set*, or hardened, and as this takes some time, hand screws built on the principle of the vise are resorted to. Fig. 52 shows

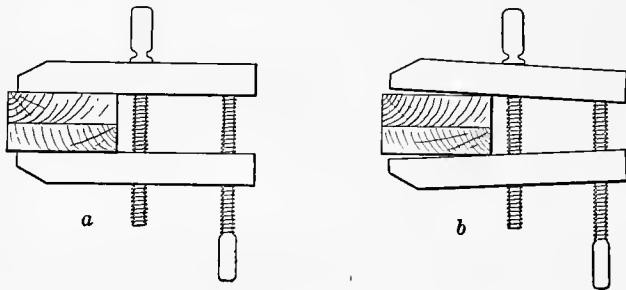

FIG. 52. Method of using the Hand Screw

two pieces glued together and fastened in a pair of hand screws. Care must always be taken to keep the jaws of the latter parallel. At *a* this is shown done properly, while at *b* is shown a careless method which, of course, will spoil the joint.

In gluing on the end grain a preliminary, or *sizing*, coat of glue must first be made to fill up the pores, which act very much like a sponge. This coat should be allowed to dry, or partially dry, before applying the

final coat; otherwise the pieces will be held weakly, if at all. Beginners are inclined to use too large a quantity, and this tendency should be avoided.

In some cases nails are used together with the glue, as at the corners of picture frames. It is customary in this instance to nail in only one direction, as shown in Fig. 53.

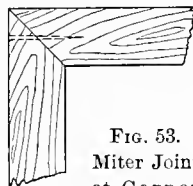

FIG. 53.
Miter Joint
at Corner
of Picture Frame

25. Nails. The nails in common use are of two kinds, *cut* and *wire*.

Two views of a cut nail are shown in Fig. 54, *a* being the side view and *b* the front view. Notice that in the front view the sides converge like a wedge, while in the side view they are parallel.

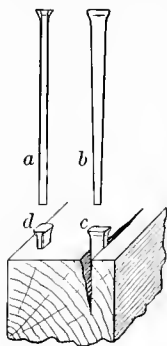

FIG. 54. Use of
Cut Nails

Care must always be taken that the point does not enter the wood as shown at *c*, as the wood will be split by the wedge action; *d* shows the proper method.

Steel wire nails are now in general use. They are made from wire and are consequently round in section, with a comparatively sharp point. There are two distinct kinds, named *flat head* and *bung head*.

Flat-head wire nails, as the name implies, have thin, flat heads, which prevent the nail from being driven beneath the surface.

Bung-head wire nails, or *brads* as the smaller sizes are called, have very small heads, which allow the nail to be sunk below the surface. This is done by means of the nail punch, or *set*, and is necessary when the surface is to be planed after the nailing.

26. Screws. Screws are much used, and allow the pieces to be readily taken apart. They are divided into two classes, *flat head* and *round head*, and are of steel or brass. Steel screws are either *blued* or *bright*. Bright screws are polished and blued screws are produced by treating the bright ones with heat or an acid.

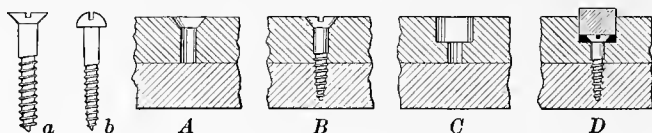

FIG. 55. Methods of using Screws

Fig. 55 shows a flat-head screw at *a* and a round-head at *b*. Flat heads are used for the more common work where it is desirable to have the screw head flush (even) with the surface or below it, while round heads are used where this is not necessary. In the latter case round heads are used partly because they are more ornamental. Flat heads must always be flush or below the surface, and in all but the softest woods it is necessary not only to bore a hole for the screw, but also to countersink it with a countersink bit in order that it may receive the

head. Two methods of fastening with flat-head screws are shown in Fig. 55.

Sketch *A* shows the two pieces of wood in position, the hole bored in upper piece (only) and countersunk; *B* shows the screw in position. In this case the screw head is visible. It is occasionally desirable to hide the screw entirely. Sketch *C* shows the hole prepared for the screw; *D* shows the screw in position and a circular wooden plug driven in over it. The plug is then leveled with the surface and the screw completely hidden.

27. Mechanical Drawing. A mechanical, or working, drawing is quite different from a pictorial drawing such as an artist produces.

The artist's drawing represents objects as they appear, while the mechanical drawing represents them as they really are. Things in nature do not look as they are. For example, when we stand on a railroad track the rails appear to converge until they seem to meet in the distance. We know that this is not the case, that the rails are really everywhere equally distant. The optical illusion of the rails meeting at the horizon is called perspective. Mechanical, or constructive,

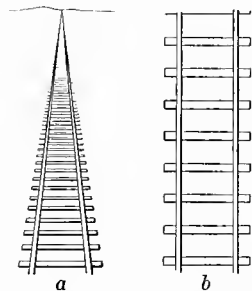

FIG. 56. The Difference between Perspective and Mechanical Drawing

drawing takes no account of perspective. In Fig. 56 *a* is the perspective representation of a track, while *b* shows a track by mechanical drawing.



FIG. 57. Mechanical Drawing of a Cylinder

In a working drawing more than one view is necessary to show the true shape of an object.

In Fig. 57 is shown the mechanical drawing of a cylinder, — the front view, as its name implies, being the image it would make in a mirror held before it vertically, and the top view the image it would make in a mirror held directly over it horizontally.

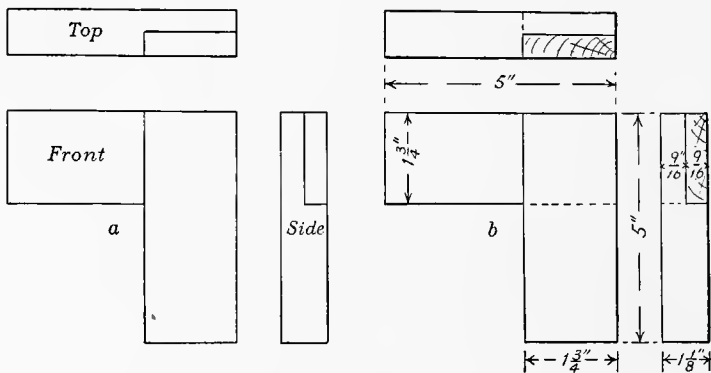

FIG. 58. Mechanical Drawing of End Lap Joint

Occasionally three views are necessary. Fig. 58 *a* shows the front, top, and side views of an end lap joint.

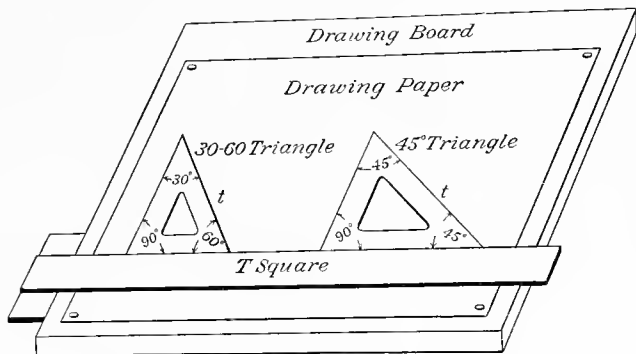

FIG. 59. Drawing Board showing T Square and Triangles in Position

The complete working drawing of this joint, with all the necessary dimensions, is shown at *b*.

In making drawings of this kind the greatest accuracy is required and special instruments are necessary.

The drawing board on which the paper is fastened must be perfectly flat, with one of its edges straight.

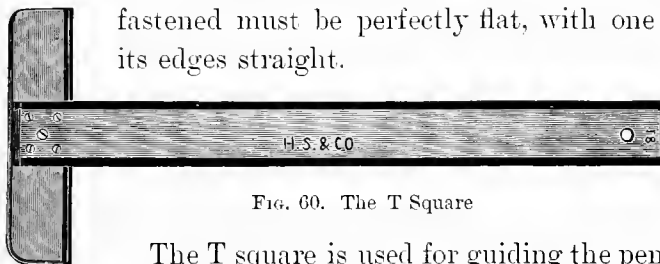

FIG. 60. The T Square

The T square is used for guiding the pencil or pen when drawing horizontal lines.

The two triangles *tt* (Fig. 59) are used for drawing vertical and oblique lines, and a pair of compasses is

needed for circles and arcs of circles. Each triangle contains one right angle, the one on the left being known as a thirty-sixty triangle because the two remaining angles are thirty degrees and sixty degrees respectively. The one on the right is called a forty-five-degree triangle because it has two forty-five-degree angles.

The position of T square and triangle when drawing vertical lines is that shown in the sketch, the line being drawn from the T square upward. Horizontal lines are drawn from left to right.

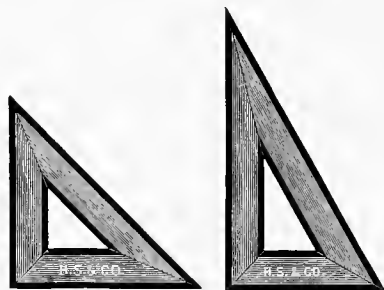

FIG. 61. The Triangles used in Mechanical Drawing

The rule used in mechanical drawing is called a scale, and should not be used for drawing lines. Its purpose is measuring.

In making a drawing the first step is to determine the spacing. The size of the paper may be measured, the number of views are known, and also the size of each. The views should be so arranged that the spaces between will be in good proportion. It is a good plan to make first a free-hand sketch, putting on dimensions and figuring the spaces before beginning actual work on the mechanical drawing. Fig. 62 at *a* shows

a free-hand sketch of a single dovetail joint, and *b* the mechanical drawing complete.

All dimensions must be given, and as far as possible they should be so placed as not to interfere with the

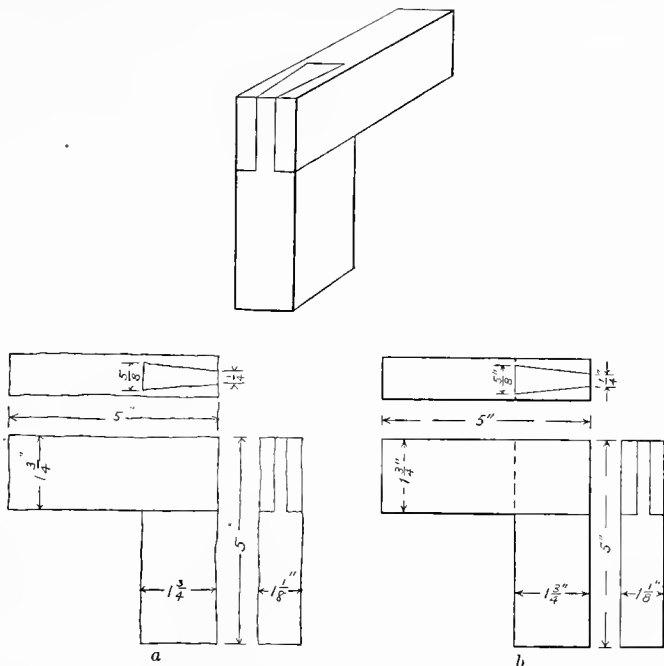

FIG. 62. Drawings of a Single Dovetail Joint

clearness of the drawing. Neat, small arrowheads and plain, clear figures add to the general appearance, just as does careful lettering in titles and all printed words.

A drawing which is made the exact size of the object represented is known as a full-sized drawing; but for large objects such a method would necessitate large and unhandy sheets of drawing paper. It is customary in such cases to make what is called a scale drawing.

A scale drawing may be half, quarter, or eighth size, and the fact is printed under the title in smaller letters, thus: $\frac{1}{2}$ inch = 1 inch, or $\frac{1}{4}$ inch = 1 inch.

Other scales may be used. In map making, for example, a sixteenth of an inch may represent one, ten, or even a hundred miles. Whatever scale is used, however, the dimensions must always give the exact size of the object represented.

ELEMENTARY WOODWORKING

PART II

CHAPTER V

WOOD

28. **Lumbering and Milling.** It is well to remember, when using wood for any purpose, that it was once part



FIG. 63. The Forest, Norway Spruce, Bavaria, Germany

of a living tree which had roots, bark, leaves, and flowers, and that the tree began life as a little sapling, which

grew taller and larger for years before it could be called a tree, and that it was between fifty and a hundred years old before it was large enough to cut down for timber.

The lumberman selects trees which have large, straight trunks. They are usually cut with the ax, although the



FIG. 64. Felling a Tree

first cut is often made partially through the trunk with a saw. The branches are then chopped off and the body of the tree cut into lengths convenient for handling. They are rolled into a stream and floated down the river to a sawmill, or, in case there is no river near by, are carted on sleds or wagons to the railroad and thence to the mill.

The cutting of the trees is usually done in winter, the floating of the logs, or *river driving* as it is called, beginning with the breaking up of the ice in the spring. River driving is a very interesting and dangerous business. Logs will often get caught sidewise and the whole river from shore to shore become jammed so tightly

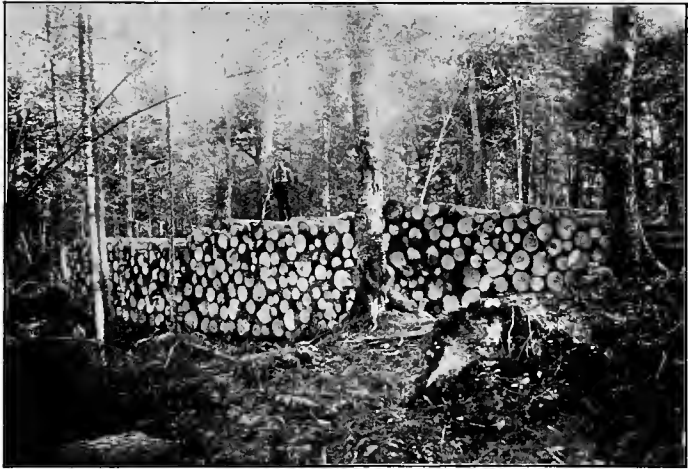

FIG. 65. A Skidway of Adirondack Spruce

that hundreds of thousands of logs are stopped in their course, forming an immense dam which the lumbermen call a *log jam*.

To break up this jam very often requires much labor and great daring on the part of the drivers, who wear

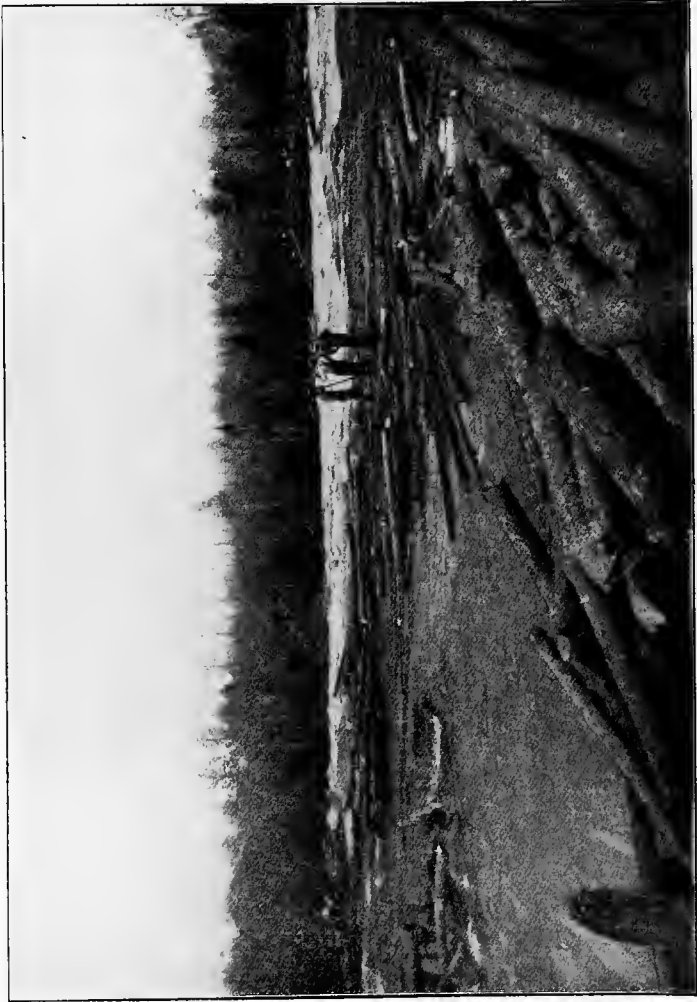

FIG. 66. River Drivers breaking up a "Log Jam"



FIG. 67. Log Boom and Lumber Piles at Tupper Lake, N.Y.



FIG. 68. A Modern Gang Saw — Interior of Modern Sawmill

spiked shoes and are armed with long poles having sharp steel points. When such a jam breaks up, the crashing of the logs and rush of water can be heard for miles.

Having finally reached the mill, the logs float in the river, inclosed in a *log boom*, until the mill men are ready to saw them into planks.



FIG. 69. A Modern Sawmill

The boom consists of logs chained together and stretched across the river just as a fence is built on land to inclose cattle.

The sawmill of to-day is a mass of automatic machinery, and after the log enters it is not touched

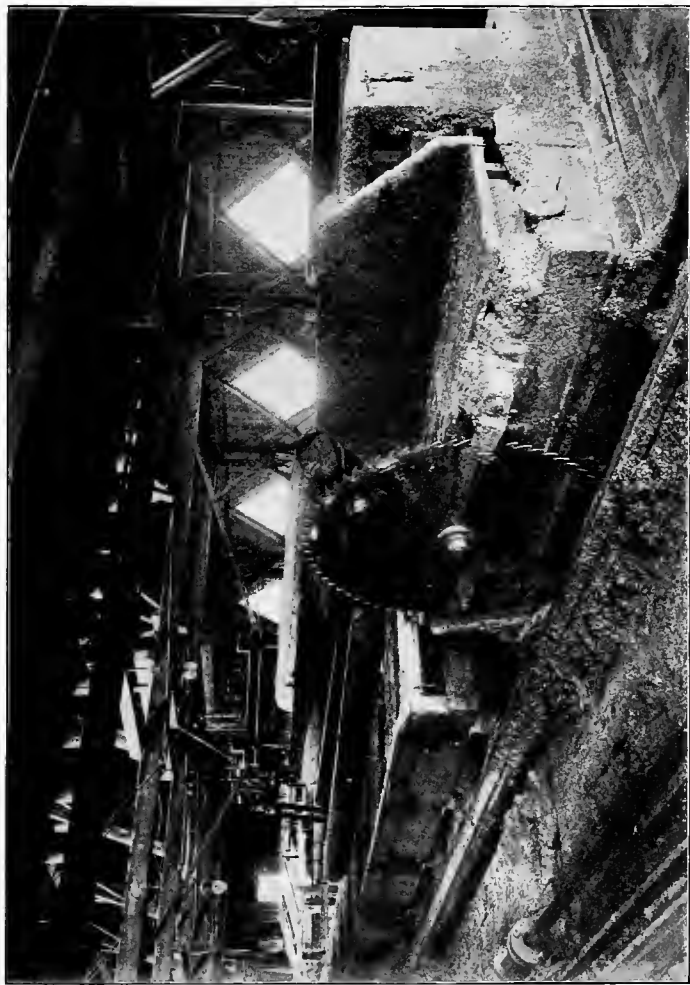

FIG. 70. The Circular Saw — Interior of Sawmill

by human hands until it comes out as lumber of various sizes ready to be loaded on boats or cars.

Logs are sawed into timber, planks, or boards, and these forms are called *lumber*.

Timber refers to all of the largest sizes, such as beams and joists. Planks are wide strips over one inch thick,

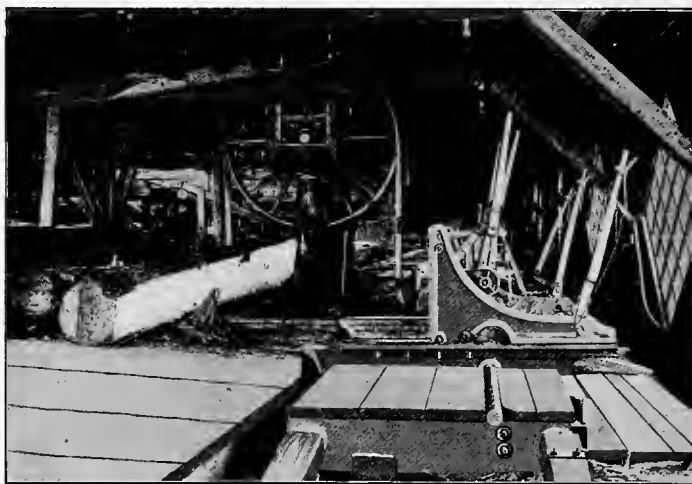

FIG. 71. A Large Band Saw

and boards are one inch or less in thickness, varying in width and length. Lumber may be planed at a planing mill, and is then known as *dressed* lumber. It may be dressed on one, two, or all sides. Dressed stock which is free from knots, shakes, and sapwood is called *clear*.

By examining the end of a log we can learn a great deal of the life of the tree. It is made up of a number of irregular rings and of lines radiating from the center and running in nearly straight lines toward the bark.

The number of rings tells us the age of the tree, as a new ring is added each year.

As the tree grows, the old wood near the center becomes compressed and dry and is known as the *heartwood*, while that portion between the heartwood and bark is called

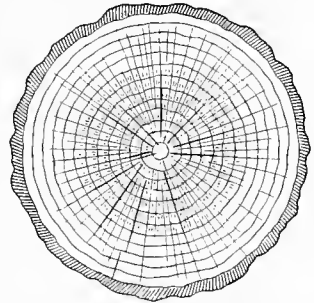

Fig. 72. End of Log, showing Annual Rings and Medullary Rays

sapwood.

In some woods the difference between the heartwood and sapwood is very marked. In ebony, for instance, the heartwood is coal black and the sapwood white.

The sketch shows half a log, the annual rings

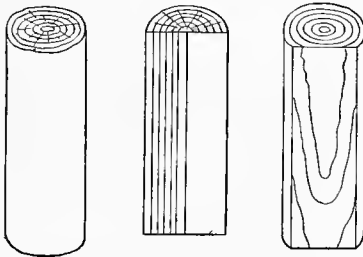

FIG. 73. Log cut lengthwise, showing how "Grain" is formed

being indicated, and also the radial lines, called *medullary rays*.

Looking at the length of the log we see that the lines in a board, which we call the *grain*, are really the edges of the annual rings.

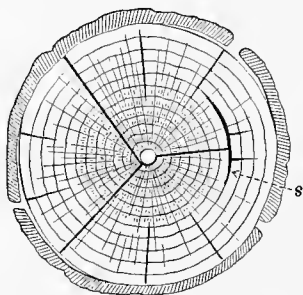

FIG. 74. Showing Weather Checks and "Shake"

It often happens in the forest that the wind sways the trees to such an extent that the annual rings separate and slide one within the other; this produces a defect in the wood called a *shake* (see s, Fig. 74).

There are other characteristics of wood known as *warping* and *shrinkage*.

After a tree has been cut down the cut end at first looks like Fig. 72. If it is allowed to lie for some time exposed to the weather, its appearance changes to Fig. 74. This is due to the evaporation of the sap, and as there is more sap toward the outside, the shrinkage is greatest there and becomes less toward the center where the heartwood is comparatively dry. This is an important fact to know, because if we had cut the log, while it was still green, into planks, as shown in Fig. 75, the

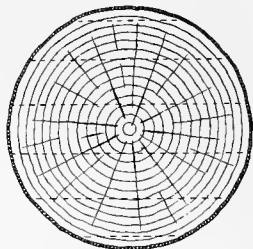

FIG. 75

boards would have curled up or warped, as shown in Fig. 76.

Besides warping, the evaporation of the sap causes the whole tree to shrink in diameter, and consequently our planks will tend to become narrower. This is called *shrinkage*, and in some woods amounts to a quarter of an inch to the foot, which means that a plank sawed twelve inches wide will, after a few months, measure only eleven and three quarter inches.

When we construct anything in wood we must always consider how the object will be affected by warping and shrinkage, remembering that the shrinkage is only across the grain.

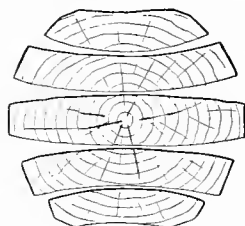

FIG. 76. Showing Effect of Warping

Let us consider the problem of constructing a drawing board to see how warping and shrinkage may be overcome.

If we make it of one piece, like *A* (Fig. 77), the board will soon change its shape to that shown in *B*, which would make it useless for mechanical drawing, as a perfectly flat surface is necessary. We can overcome the warping by screwing heavy cleats on one side across the grain, as shown at *C*. The cleats would need to be heavy or the warping force would bend them.

A better way would be to build the board up of several narrow strips glued together, as the warping of one would be counteracted by the warping of its neighbors in opposite directions; but to make doubly sure, cleats fastened with tongue and groove joint should be added at the ends, as shown at *D*. This has an advantage over the first method, as the cleats in *C* are often in the way and make the board clumsy to handle.

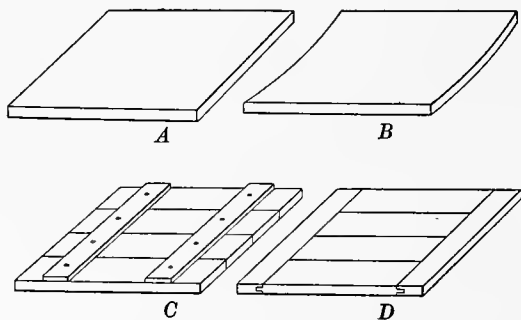

FIG. 77. A Study in Construction. Methods of overcoming Warping and Shrinkage

The student will find many evidences about the house of how the woodworker has tried to prevent warping and shrinkage, as, for instance, in the paneled doors, tables, etc.

The wood of the various trees differs greatly in hardness, evenness of grain, durability, etc., and every boy

should know not only what our woods are used for, but he should also know the trees when he sees them.

We are indebted to the trees for many things besides wood. They give us delightful shade and coolness in summer; many of them produce delicious fruit and nuts; from them we obtain such valuable products as maple sirup and sugar; while tar, pitch, turpentine, rubber, and tannin are only a few of the many tree products. The houses we live in, the chairs we sit on,—in fact, most of our furniture, even to the frames of our pictures, the cars we ride in, and the very pencils we write with, are of wood which was once part of the living forest.



FIG. 78. A Large Tree being moved by a Modern Tree Mover, showing Root Formation

CHAPTER VI

BROAD-LEAVED TREES: THE OAKS

Our American trees may be divided roughly into two classes: (1) those which keep their leaves the year round, known as *evergreens*; (2) those whose leaves drop off in the fall, called *broad-leaved*, or *deciduous* trees, in distinction from the evergreens, whose leaves are usually needle-shaped.

Among the broad-leaved family are such trees as the oak, chestnut, hickory, maples, elms, etc.; and among the evergreens or cone-bearing trees are the pines, spruces, hemlocks, firs, and cedars.

The oak family is a very important one, the wood being hard and strong and the tree a sturdy, healthy, and well-known specimen of tree life.

White oak is perhaps the most common member of the oak family. It grows to a very large size and has a leaf of the form shown in Fig. 79. Observe carefully the outline of the leaf and compare it with the sketch of the next form.

The white oak, like all oaks, bears acorns, and its timber is used as a standard when comparing different

kinds of wood. If we say that the strength of white pine is one half, we mean one half that of white oak, and in all timber calculations white oak is the standard, just as the yard and mile are standards of length. In work which requires strength, such as carriage making,

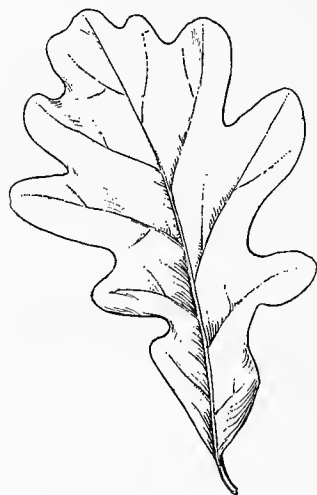

FIG. 79. Typical Leaf of the
White Oak

shipbuilding, and cooperage, white oak is used very extensively. The quartered oak used so much for furniture is obtained by cutting the logs in a special manner. The method of cutting gives a beautiful mottled effect with the silver rays spread out in irregular white splashes on a dark background. We might separate the oak into two distinct groups: (1) those trees whose acorns ripen in one season; (2) those which require two years. The acorns of this latter group remain on the tree throughout the first winter and ripen the second summer.

To the first class belong the white oak just mentioned, the post oak, chestnut oaks, mossy-cup oak, and live oak.

In the second class are the red, scarlet, black, pin, laurel, and willow oaks.

The difference in the leaves of these trees is so great that we need never mistake one for the other. Notice the cut of the red oak and compare it with that of the white oak. The latter has rounded lobes, while the red-oak leaf has sharp points and the fingers of the leaf are indented again with smaller teeth.

The different trees in the white-oak family all have leaves with rounded lobes, and most of those in the red-oak group have pointed ones, yet there is a difference between members of the same family, just as among human beings.

We can tell at a glance whether a man is a negro, a Chinaman, or a white man. If

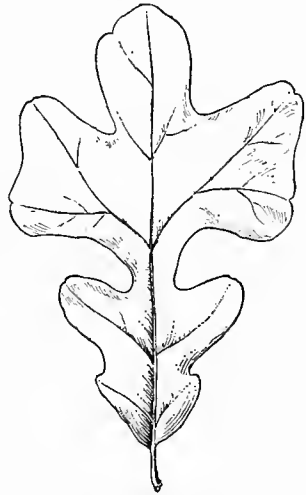

FIG. 80. Leaf of the Post Oak
 a white man, he may be a Frenchman or an American; and again, if an American, he may belong to the Jones family. But all the members of the Jones family do not look alike and we know one from another.

This is true of trees. No two are alike, and we can tell from observation whether a tree is an evergreen or

a broad-leaved tree, whether it belongs to the white-oak group; and after studying trees a little we can tell whether a member of this group is a white oak, a post oak, or a mossy-cup oak.

Compare the post-oak leaf (Fig. 80) with that of the white oak. There is not a great difference in form, but the post-oak leaf is thick, leathery, and dark green, while the white oak has a beautiful thin, light green leaf, which turns red in the fall.

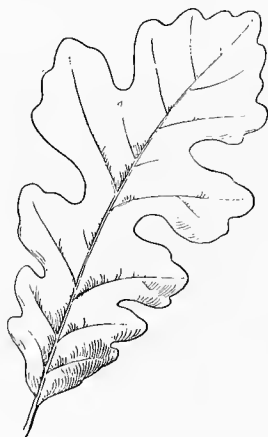

FIG. 81. Leaf of Mossy-Cup
Oak

The post oak is a rougher and coarser tree than the other, and is sometimes called *iron oak* on account of its very hard, tough wood.

29. The Mossy-Cup Oak. One of the most beautiful oaks we have in America grows in the South and West, and is only rarely found in our parks in the East. It is called the *mossy-cup oak* because the large acorn which it bears is surrounded by a bushy fringe which almost hides the nut. This acorn is a sight never to be forgotten. The leaf is larger than that of the white oak, and although the two leaves look somewhat alike, the divisions of the

mossy-cup leaf are not as regular as those of the white oak, and it is not so thin and delicate.

Its wood is very strong and is valuable for many purposes, such as boats, carriages, farming implements, railroad ties, and cooperage.

30. Black Oak and Black-Jack Oak. These two trees are usually found growing in wild places, and the



FIG. 82. Leaves of Black Oak and Black-Jack Oak (Black-Jack on right)

black-jack oak is often called *barren oak* from the fact that it frequents bleak and barren plains, such as the sandy stretches of New Jersey and Long Island.

The sketch shows the difference in the leaves, that of the black-jack having only three main lobes, or



FIG. 83. Leaf of
Red Oak

divisions, while the black oak has five. However, the leaves of these two trees vary considerably, and one must always look for the typical leaf, which is the one shown in the sketch. The black-jack is a small, shrubby tree, with branches often twisted and contorted, and its wood is not very valuable except as fuel or for making charcoal.

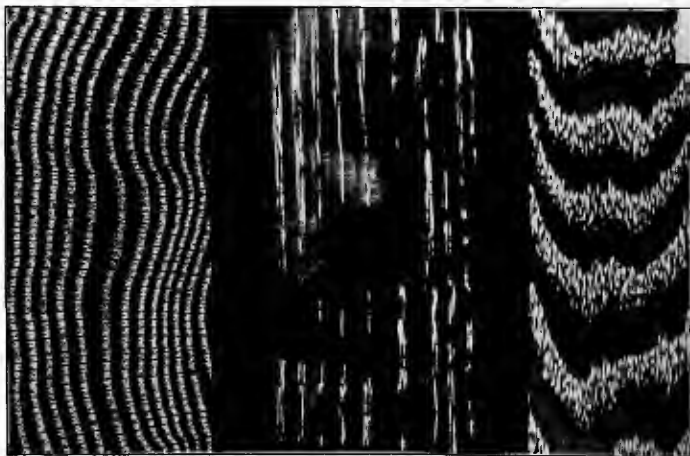

FIG. 84. Wood of the Red Oak, showing three sections. The one on the left shows annual rings obtained by a horizontal cut through the tree. Central view shows vertical cut at center of tree. View on right shows vertical cut between center and bark as illustrated in Fig. 73.

The acorns require two seasons for ripening, as do those of the red, scarlet, and pin oaks.

31. The Red Oak. The red oak is one of our largest and most noble trees, growing taller even than the white oak, and may always be distinguished by its very large, shiny, dark green leaves.

Its bark is also much smoother and darker than the white oak. Its acorn is very bitter and can easily be recognized by its shallow cup and by its large size.

It is the largest of the two-year acorns. The wood of the red oak is darker than that of the white, and is used in the manufacture of furniture.

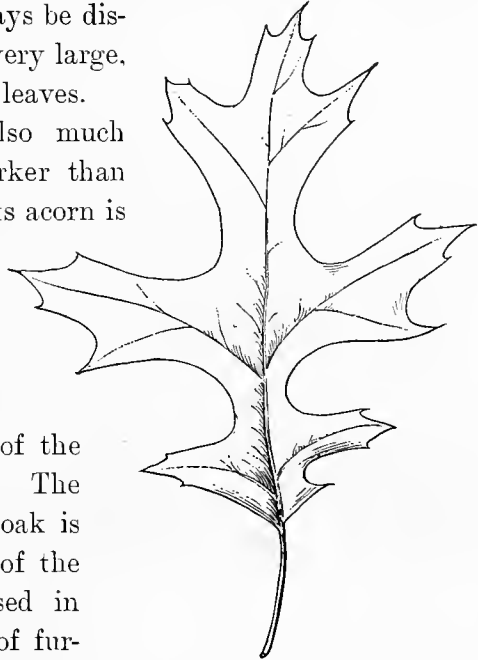

FIG. 85. Scarlet Oak

32. The Scarlet Oak. This tree is often confused with the red, but a glance at the leaves will show a great difference. That of the scarlet has deeper indentations and is much more slender and skeleton-like in shape. It

takes its name from the bright scarlet or red tinge it takes on when the leaves change color in the fall.

33. The Pin Oak. The pin-oak leaf is much more readily confounded with the scarlet oak than that of any other tree. In fact, no two trees have leaves so nearly alike as these two; yet a glance at two typical leaves

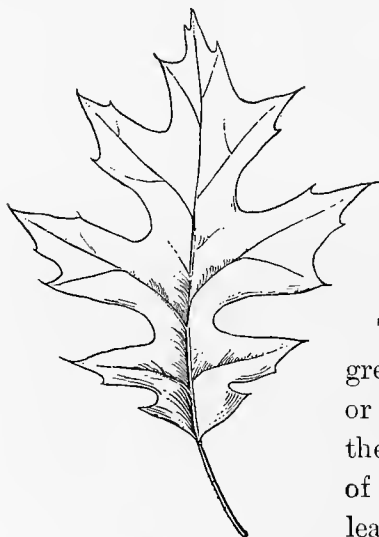

FIG. 86. Pin Oak

placed side by side will show considerable difference.

The pin-oak leaf is smaller than the other, and in proportion to its size the indentations are not so deep.

The pin-oak tree has a great many small branchlets, or stems, which give the tree the appearance of a bundle of pins, especially when the leaves are off in winter. It is a beautiful tree and is now being planted very extensively as a shade tree. It is hardy, and stands city air very well indeed. Its bark is rich in tannic acid, which is used in tanning leather.

The oak family is such a large and valuable one that we cannot afford to pass it over lightly. In the South

grows the willow oak, famous for its shade and its leaves, which resemble those of the willow. A little farther north we find, along the Ohio valley, the *shingle oak*, so called from the fact that its wood is mostly made into shingles. It is also known as the *laurel oak*, because its leaves are shaped like those of the laurel, although not so glossy.

This is such an odd shape for an oak leaf that one would be likely to pass it by and not recognize it but for the fact that it bears acorns. This is always the test, — “By their fruits ye shall know them.”

If we meet a new tree which seems not to be an oak because its leaves are new to us, and it bears acorns, we may be sure it is an oak.

A very interesting group of trees which come under this head are the chestnut oaks. At first glance one would take one of these trees to be a chestnut, but it



FIG. 87. Pin Oak in Winter

bears acorns and must therefore be an oak. The sketch shows the two leaves side by side.

Let us examine them closely. Although they slightly resemble each other, by looking carefully we see that the teeth on the chestnut leaf are pointed, while those on the chestnut oak are decidedly rounded. There is also

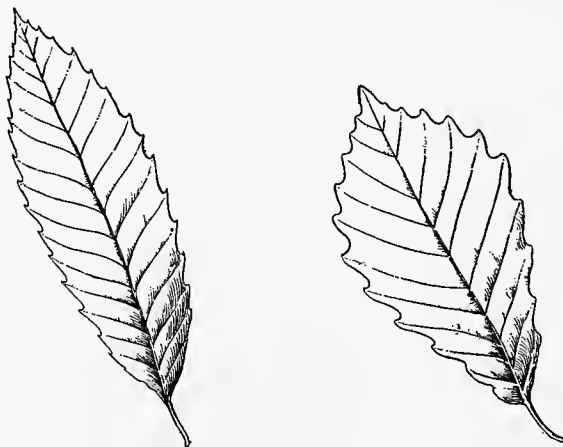

Chestnut

Chestnut Oak

FIG. 88

a difference in proportion, as the chestnut leaf is long and narrow, while that of the chestnut oak is broader.

There are several varieties of chestnut oak, but their leaves are quite similar and they all belong to the white-oak group and ripen their acorns in one season. They grow to a large size, one famous from Revolutionary

times at Fishkill-on-the-Hudson measuring seven feet in diameter. The acorns are sweet and are eagerly sought after by the squirrels.

The wood is durable in exposed places and is used for cooorage, railroad ties, and fencing.

34. The Live Oak. No list of American oaks would be complete without the live oak. This is a southern tree and is remarkable in many ways. Its leaf has no indentations, remains green all winter, and is thick and leathery.

The wood is extremely heavy, a cubic foot weighing nearly sixty pounds. It is as hard as it is heavy, and although it takes a high polish and has a fine grain, it soon dulls the edge of a tool.



Before the age of steel, when all ships were wooden, it was much used in ship-building, and the government bought large tracts of land where live oak grew abundantly, so that the United States navy should never lack the necessary timber.

It grows along the Atlantic coast, south from Virginia, and along the Gulf to Texas.

FIG. 89. Leaf of
Live Oak

CHAPTER VII

BROAD-LEAVED TREES: THE MAPLES

It is the maple family to which we are indebted for much of the glorious coloring of our autumn landscapes.

It is true that all trees play their part in the general color scheme, but for the brilliant reds and scarlets of the fall foliage we must look to the maples.

When we think of the word *maple* we are apt to have visions of other things besides trees. Maple and sugar or sirup seem to go together, and in fact some of us do not know that there are other maples besides the sugar maple.

This fine American tree is one of which we should be proud. Not only is it a handsome large tree, valuable for its shade and the beautiful colors it wears in the fall, but its wood is hard and valuable, — it is often called *rock maple*, — and besides all these good qualities it furnishes us with our maple sirup and sugar.

The process of making maple sugar is quite interesting and may be divided into two stages, — gathering the sap, and boiling down.

Very early in the spring, often as early as March, the sap begins to flow up through the tree. The farmer knows by experience when to tap the tree, which he does by boring a three-quarter inch hole with an auger. Into this hole he inserts a spout of wood or iron through which the lifeblood of the tree — the sap — flows in a steady drip, drip, drip, into a pail or bucket placed beneath to catch it.

The sap comes in drops about as regularly as the ticks of a clock, one a second. This continues for two or three weeks, until each tree has yielded something like twenty-five gallons. As it takes five gallons of sap to produce a pound of sugar, each tree yields about five pounds of maple sugar. In New England and New York there are maple groves containing thousands of trees, and one farm alone produces five thousand pounds of sugar in a season.

Strange as it may seem, this excessive bleeding of the trees does not kill them unless improperly done. The farmer must not tap them at the wrong time nor in too many places. The tree will stand a great deal if properly treated, but harsh treatment will kill it.

The boiling process is very simple. The sap is poured into large boilers or evaporators and boiled until it becomes a sirup. The old-fashioned test to find out when the boiling had been carried on long enough was to drop

a little of the hot sirup into the snow or into a cold dish. If it hardened, the boiling was finished.

Fig. 90 shows the leaf of the sugar maple, also that leaf which is most often confounded with it, viz., the Norway maple. Observe the two closely. The sugar maple has blunt, rounded points and is thick, while the

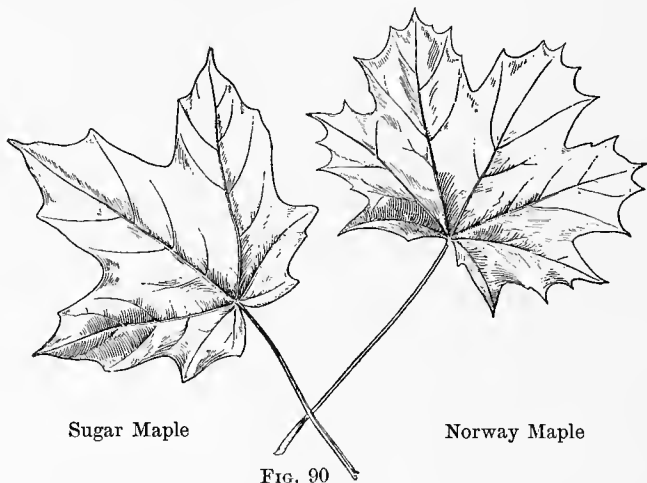

Norway has sharp points, which are more numerous, and the leaf is much thinner and more delicate.

The sugar maple grows taller and does not cast so dense a shade as the Norway, which is a low-growing tree with close, dark foliage.

35. The Silver Maple. The one which naturally comes next in the list is the *silver, soft, or white maple*, as it is

variously termed. From the ground up to the topmost leaf the whole character of this tree suggests the word *thoroughbred*. Clean-cut, refined, strong, and healthy in every detail, the silver maple is a thing of beauty

and might truly be called the acme of perfection in tree life. Its name is



The Silver Maple

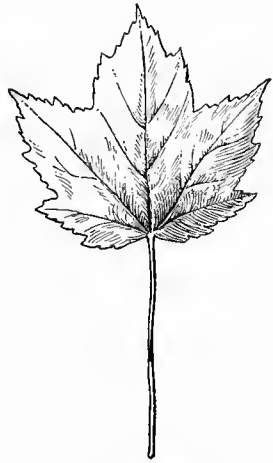

The Red Maple

FIG. 91

derived from the fact that the under side of the leaf is silvery white. The upper side being dark green gives a beautiful effect when the wind stirs the foliage, which as a whole has the grace and drooping effect of the American elm.

This description does not always fit, however, as it is planted extensively in cities where horses gnaw the fine bark; smoke, soot, and coal gas discolor the leaves; and the caterpillars complete the work of destroying its

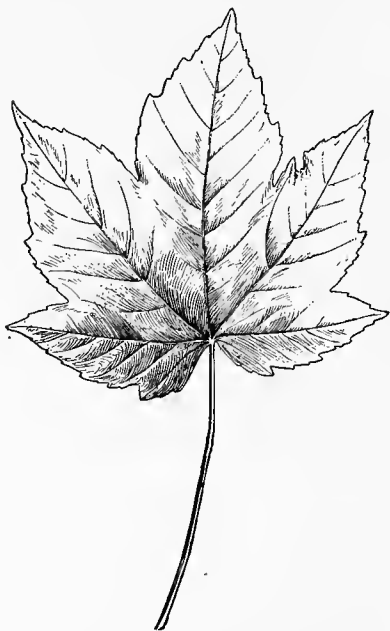

FIG. 92. The Sycamore Maple

beauty. Yet it still lives, even if it does not thrive under such harsh treatment. Its wood is white, soft, and not very valuable.

36. The Red Maple. A relative of the silver maple and one which might be mistaken for it is the red, swamp, or wild maple. It is this tree which displays the brightest reds in autumn. Referring to the sketch it will be seen that the leaf is smaller and three-fingered instead of five, as in the

silver variety. The stem of this leaf is also red during the entire season, as if it could not wait for autumn.

37. The Sycamore Maple. In the rows on rows of maples so common in our towns and cities one will

often find a leaf larger, heavier, and coarser than any of the others. This variety, like the Norway, is an importation from Europe, known as the *sycamore maple* because of its resemblance to the sycamore leaf. It is easily identified by its large size, coarseness, the very long, thick red stem, and by the fact that its entire edge is finely toothed,—in which point it differs from all the foregoing varieties. Its value as a shade tree is nearly equal to the Norway, and in Europe it is often planted in preference to all other maples.

38. The Striped Maple. Growing in the shade of other trees and forming part of the undergrowth of our North woods is a small tree known as the *striped maple*, from the stripes which run up and down its bark. The New England name for this little mountain tree is *moosewood*, from the fact that the moose is very fond of the bark and twigs, which form his chief food in winter. The leaves are quite large, but very thin, soft, and delicate.

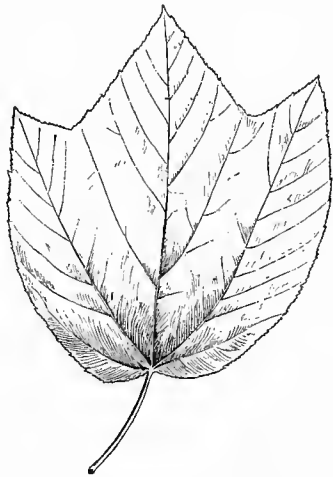

FIG. 93. The Striped Maple, or
Moosewood

39. Maple Keys. The fruit, or seeds, of all the maples are known as *winged*. The flat, thin part gives the seed a swirling motion as it drops from the tree. This is the way nature has of spreading the seed over a large area so that more trees may be started in life. Many tree seeds are winged, but the maple seed or key is so large and so common that every one must at some time have noticed it.

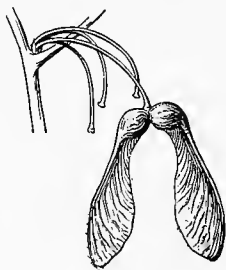

FIG. 94. Maple "Keys,"
a Common Form of
Winged Seeds

40. The Ash-Leaved Maple. The ash-leaved maple is a leaf very common in our parks. It has no resemblance to other maple leaves, yet it bears the unmistakable maple key, — "By their fruits ye shall know them." It is therefore a maple.

The box elder, or ash-leaved maple, is interesting because it is our only maple having a compound leaf; that is, a leaf stem with several distinct leaflets. Compound leaves are very common (notice the hickory leaf and the horse-chestnut), but not on maples, and our ash-leaved maple is a curiosity. It delights in swampy places, but grows almost anywhere. It is a small tree, and its wood is not especially valuable except for making paper pulp.

North America has only nine varieties of maple, while China and Japan have more than thirty. Indeed, it is

to Japan, whose forests are largely made up of maples, that we are indebted for some of the most dainty and exquisite trees to be found. The Japan maples planted so extensively on our lawns and in our parks have such a variety of form and color that no written description can do them justice. Fig. 96 will give some idea of their

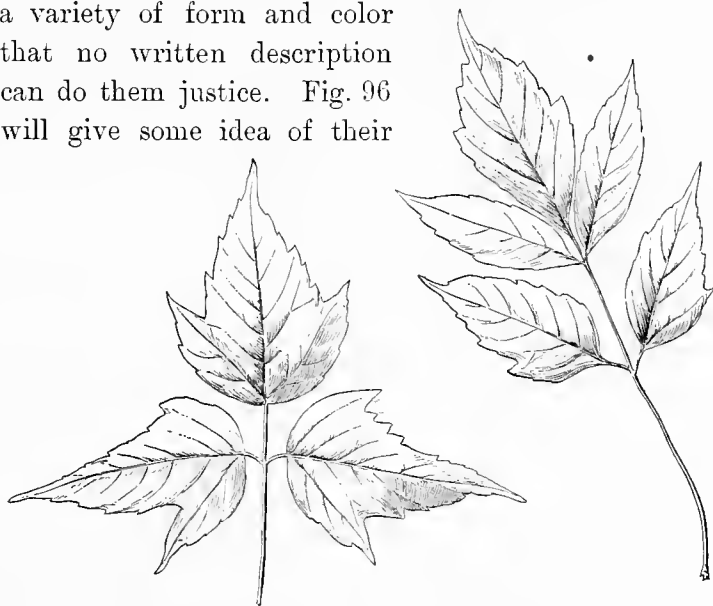

FIG. 95. Ash-Leaved Maple, or Box Elder

shape and delicacy. The colors, which of course cannot be shown, range from dark purple to the most delicate combinations of white and green. The finest of these dainty leaves bears a stronger resemblance to an ostrich plume than to anything in the line of tree leaves.

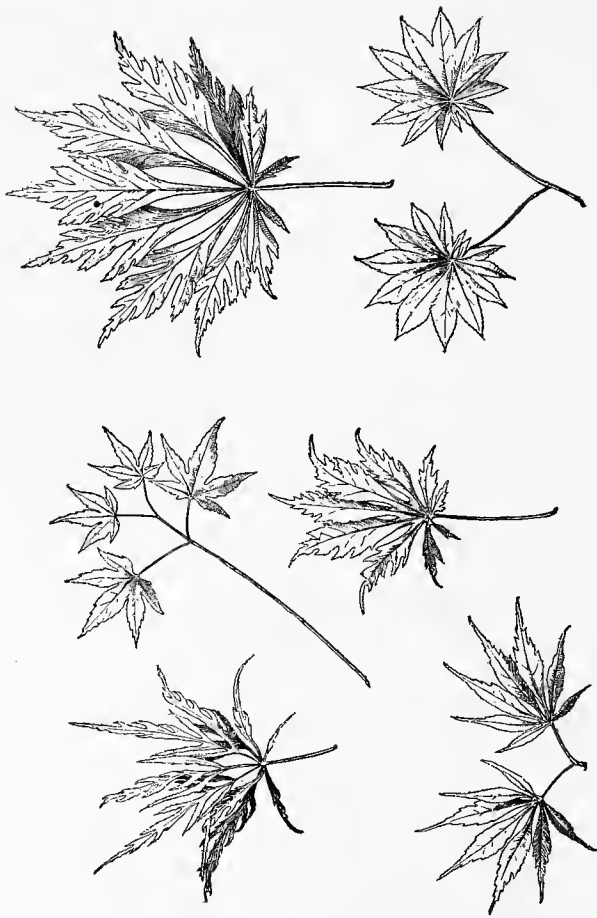

FIG. 96. Japan Maples

CHAPTER VIII

BROAD-LEAVED TREES HAVING COMPOUND LEAVES

The beginner is often in doubt as to whether a twig with several leaves is a compound leaf or a number of simple leaves. This is a very easy thing to decide. At the end of the leaf stem, where the leaf joins the twig or branch, is always a little bud.

When the leaf drops off in the fall the bud remains, and in the spring begins to swell and finally develops into a leaf. This bud then is the promise of next year's leaf, and it is always found at the base of the leaf stem, as shown at *A*. There is no such bud at the base of the leaflet on the compound leaf, as shown at *B*.

If then we find no bud at *B*, we must look farther down until we discover it at *C*. This furnishes the test and we know that our specimen is a compound leaf.

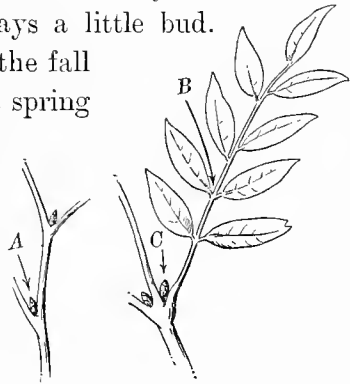

FIG. 97. Method of distinguishing Compound and Simple Leaves

This class of leaf is very common, as our horse-chestnuts, buckeyes, hickories, and walnuts all have compound leaves.

The horse-chestnut is not a native American tree, but was imported from Europe, where it is a great favorite. The leaflets number five or seven, always an odd number,

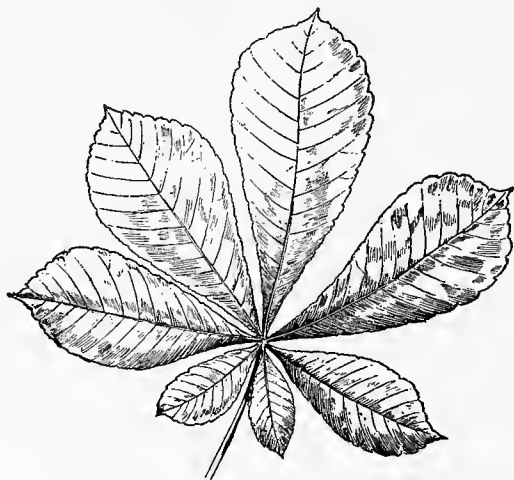

FIG. 98. The Horse-Chestnut

and they radiate from one central point, the odd one in the center usually being the largest.

It is very interesting to watch these leaves as they come out of the sticky buds in the spring. They unfold and grow very rapidly and soon the tree brings forth large pyramidal clusters of beautiful flowers.

The large, neat brown nuts which come later in the season do not seem to be very useful, yet they are so solid and shiny that every boy delights to gather them.

An American tree closely resembling the horse-chestnut is the buckeye. The leaflets on the buckeye leaf number five, sometimes seven, and radiate like the horse-chestnut from a common center.

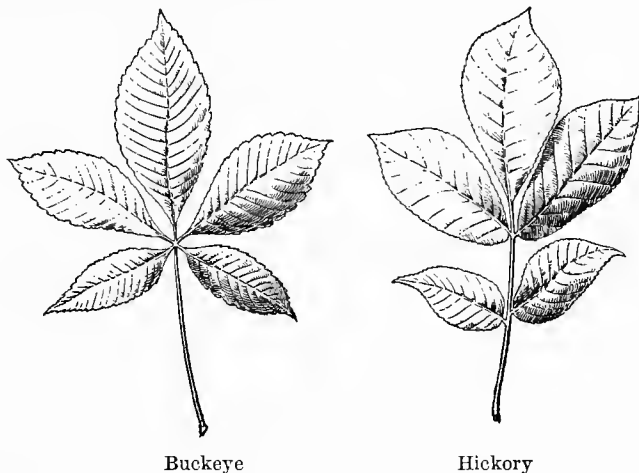

FIG. 99. Familiar Forms of Compound Leaves

This tree is well known through the Ohio valley, where it is very common, Ohio being called the Buckeye State. The nuts are not edible, but the wood is very tough and strong and is used extensively in making farm implements.

Compare the leaf of the buckeye and the hickory shown in Fig. 99. Both leaves are compound, and each has five leaflets, but they are quite different, because the hickory leaflets are arranged on opposite sides of the leaf-stalk instead of radiating from one point.

There are several varieties of hickory, including the shagbark, or shellbark, the pignut, and pecan.

The name *shagbark hickory* is taken from the peculiar appearance of the bark, which hangs in loose pieces nearly a foot long and gives the tree a very shaggy effect. *Shellbark* is another common name for this tree.

The nut which this tree bears is hard and thick, but the kernel is very sweet, and is considered by some superior to all other hickory nuts.

The *pignut hickory* is so called because the nuts in some parts of the country are used to feed the pigs. It is also called *broom hickory*. The nuts are small and become bitter after having lain awhile. The wood, however, like all the hickories, is valuable, being hard and tough. There is a difference between strength and toughness. Oak is strong, but not tough. Hickory is both hard and tough. A tough wood is one which will stand bending without breaking. A wood which will bend easily but is not strong cannot be called tough. It must be both strong and elastic, and hickory has both of these qualities.

41. **The Pecan.** We usually think of the pecan nut as different from the hickory, yet they belong to the same family. The pecan hickory is a southern tree which delights in the warm climate south of the Ohio

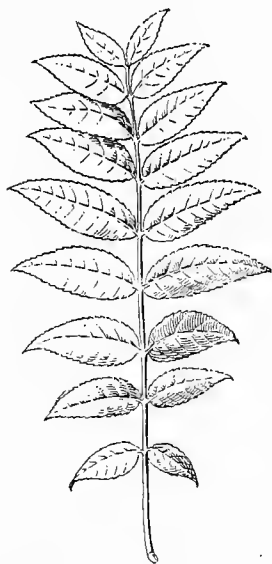

Black Walnut

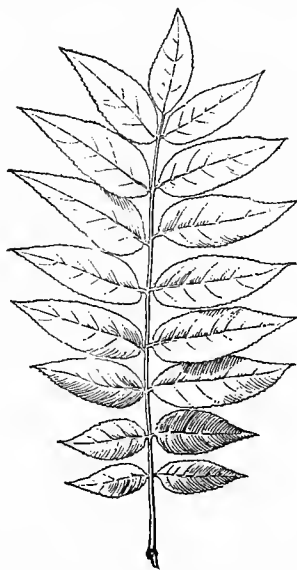

Butternut

FIG. 100

River, and in Texas is found as a grand forest giant one hundred and fifty feet high, producing an enormous crop of the sweetest and most delicately flavored nuts. The leaf has nine leaflets and occasionally as many as fifteen.

42. The Black Walnut and Butternut. Perhaps no two trees are so difficult for the city boy or girl to distinguish as the butternut and black walnut. Both have compound leaves, the number of leaflets varying from nine to seventeen for the butternut and from fifteen to twenty-three for the black walnut. A leaf having fifteen leaflets, then, might belong to either tree if there were no other way to distinguish them. The teeth on the black-walnut leaflet are larger and sharper than on the butternut, and the fuzzy stem is lacking. The green nuts, too, are different, the black walnuts being just about the size and shape of green lemons, the butternuts longer and thinner; but the unmistakable feature is the odor. Having once smelled the crushed leaves of a butternut and a black walnut, a person will thereafter need no other test.

The use of black-walnut lumber for making furniture was at one time very common. The great supply of this valuable wood has been exhausted and other woods have become fashionable. It is still used for gunstocks, for which purpose nothing seems better suited.

Butternut is a light-colored wood, but takes a good polish and is occasionally used in cabinet work.

43. The Locusts. The locust family is a large one; its members all bear compound leaves, and their fruit is in the form of beans instead of nuts.

The common yellow or black locust is famous for its hard, durable wood, its delicate light green leaves, and its white flowers.

The tree is not very beautiful when the leaves are off, but its wood is so valuable that its beauty is not considered. The wood is yellow and becomes very hard after it has dried.

The honey locust is another common member of this family.

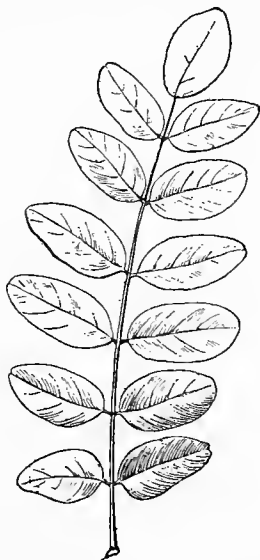

The Locust



The Honey Locust

FIG. 101

44. The Honey Locust. Its leaves are much finer and somewhat resemble ferns. It may always be known by the dangerous sharp-pointed thorns which grow all over the tree. These thorns are unusually large, sometimes

being found in great bunches and as long as six inches. Its fruit is a long, thin, brownish pod, which is sweet and contains little light brown beans. The wood is strong and durable.

45. The Ash. Every boy who has owned a rowboat knows that oars are made of wood from the ash. This is because the oar must be elastic as well as strong,



FIG. 102. Red Ash



and the timber of the ash tree supplies these two qualities. The ash is one of our tallest and noblest forest trees. It is rather slim in build, with beautiful clean shiny green foliage. The members of this group seem to be fond of colors, and we have the white ash, red ash, green ash, blue ash, and black ash.

There are slight differences in the leaves and seeds, but, as in other trees, when we have once seen an ash seed we can always thereafter distinguish an ash tree. Fig. 102 shows the seed of the red ash. It is a winged seed, with the seed part inclosed by the wing.

The compound leaf of the white ash has from five to seven leaflets and the black ash has from seven to

eleven. The wood is hard, tough, and elastic, has a handsome grain, and is used for many purposes besides making oars, such as furniture, carriages, and those farm implements which require strength. The Indian could find no better wood for his bow, and even Cupid is said to have first made his arrows of ash.

CHAPTER IX

BROAD-LEAVED TREES HAVING SIMPLE LEAVES

46. **The Elm.** The elm is the well-known shade tree of New England. Its tall, graceful form is familiar to



FIG. 103. The American Elm

every visitor and native of that section of country, where it is found along every roadway and in every city.

Who can think of New England without its noble elms? It would indeed be a different country. The

elm may be said to represent New England character,—dignified, sturdy, graceful, and refined. Being tall, with foliage well up, the general shape of the tree gives the desired shade, yet does not obstruct the view; while its stately dignity gives an air of comfort and repose to the grounds, which it seems to protect from the elements.

Its wood is valuable for certain kinds of work, being tough and strong, but it is not suitable for cabinetwork, as it is difficult to polish. It is used considerably for wheel hubs and in cooperage.

Observe the edge of the elm leaf carefully. The teeth not only curve gracefully toward the extreme tip of the leaf, but they are themselves also toothed,—a form known as double-toothed. The leaf is coarse and rough to the touch, in marked contrast to the birch family, whose leaves it slightly resembles. There are several elms famous in the history of our country. At Cambridge is the old elm under which George Washington drew his sword and took command of the American Army on July 3, 1775; there are several other “Washington Elms” in different parts of the country, while New Haven is known as the City of Elms. William Penn made his famous treaty with the

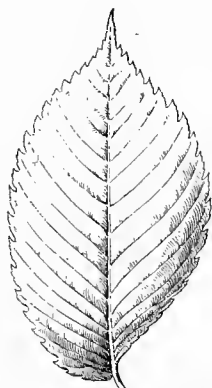

FIG. 104. Leaf of
American Elm

Indians under the branches of a magnificent elm, which remained standing until it was over two hundred years old, when it was finally blown down. The spot has been marked by a marble column.

The tree is called the *American*, or *white, elm*, and we have several other varieties growing wild, including the well-known *slippery elm*, so called because the inner bark is slippery and edible.

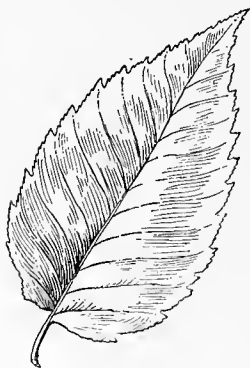

FIG. 105. Leaf of Black Birch

47. The Birches. If the black birch with its sweet, aromatic bark is not known to a boy, the white, or canoe, birch is sure to be. It seems to be the fate of this beautiful tree to be disfigured by every wandering youth who has strength enough to tear off a strip of its paper-like bark.

The leaf of the black, or sugar, birch may be distinguished from the elm by its smoothness and thinness. Its base is slightly heartshaped, the edge is double-toothed, the tender bark on the twigs is sweet to the taste, and the leaves grow in pairs.

48. White Birch. The famous white, paper, or canoe birch has a leaf somewhat broader than the black variety, but without the heartshaped base. Its bark is its peculiar



FIG. 106. Birches bordering a Canal

feature and cannot be mistaken. It comes off in layers and possesses a resinous quality which makes it waterproof, a fact fully appreciated by the Indians, who constructed their canoes of it. The wood is hard and tough.

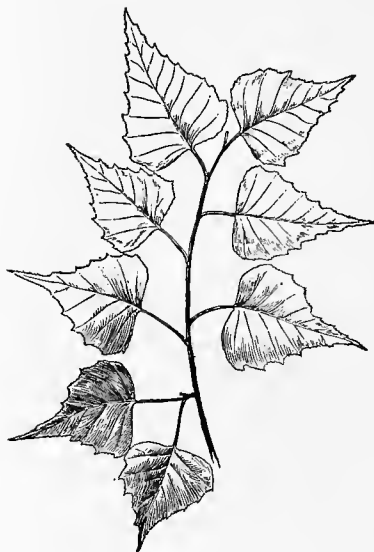

FIG. 107. Leaf of Gray Birch

49. Gray Birch. A smaller tree, known as the *gray birch*, also has white bark, but it is not as perfect as that of the canoe birch, does not peel in layers, and has triangular black spots on the trunk beneath every limb.

It loves barren, rocky places, abandoned farms, etc., and is sometimes called *old field birch*. It has a fine, delicate foliage, which is not duplicated in the forest. Each

leaf swings from a long, slender stem, and every passing breeze gives it a trembling effect, like the aspen. The leaf form is very odd, — a broad, flat base, and then a long, graceful curve out to a fine point, the whole edge being finely double-toothed.

50. The Beech. The difference in the leaf forms of the birch and beech is very marked. Both have toothed edges, but in the beech the spaces between the teeth are so remarkably shallow that one has to search for them.



FIG. 108. A Remarkable Growth of Beeches in Greater New York

There has been a common belief for generations that the beech is proof against lightning, and recent experiments prove that beech wood offers considerably greater resistance to the electric current than oak, poplar, or willow; so our ancestors were partly right. The wood is hard, strong, and tough, and will take a high polish.

51. **Hornbeam.** Closely related to the beeches are two little trees which have delicate birchlike foliage and wood of great hardness, — the hornbeam, or blue beech, and

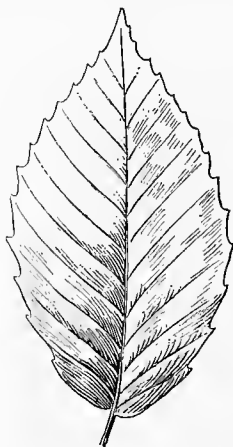

FIG. 109. Leaf of American Beech

the hop hornbeam, or ironwood.

The leaves of these two varieties

are quite similar, that of the ironwood being somewhat the larger.

The name *hop hornbeam* is derived from the fruit, which resembles the hop, and the name *ironwood* from the great strength and hardness of the wood.



FIG. 110. Ironwood, or Hop Hornbeam

52. Buttonball. No list of trees would be complete which did not include those three forest giants, buttonball, tulip, and sweet gum. The names *buttonwood*, *buttonball*, *sycamore*, and *plane tree*, as the same tree is called in different parts of the country, all apply to that fine American tree which sheds its bark as well as its leaves, leaving a ghostly monarch of tree life, which produces an enormous crop of buttonballs so well known to country boys and girls. The leaves are in proportion to the size of the tree, often measuring a foot in length, and being frequently covered on the under side with a white down called *fungus*.

The wood of the sycamore, as it is incorrectly called, is valuable for cabinetwork, having a beautiful grain and taking a high polish. It is, however, difficult to work, and has a tendency to warp.

53. Sweet Gum. The sweet-gum tree also produces a crop of balls, or seed pods, but although the same size as the buttonballs, they need never be confused, as the gum balls are covered with somewhat sharp points, while the buttonballs are comparatively smooth.

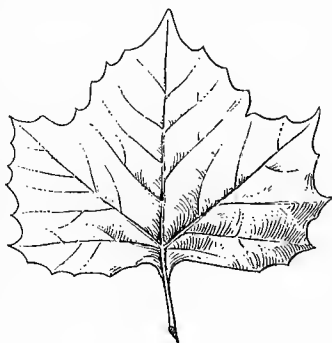

FIG. 111. Leaf of Buttonwood

The leaves of the sweet gum, or *liquid amber* — so called from the amber-colored gum the tree gives out — remind one of the starfish, being five-fingered and decidedly different from any leaf in the forest. The tree grows to a height of one hundred and fifty feet, and its wood is a handsome brown color with fine and intricate



FIG. 112. Sweet Gum, or Liquid Amber

markings. It warps badly, but is valued for wood turning on account of its softness and even grain.

54. Tulip. The lumber furnished by the tulip tree, commonly called *white-wood*, is less liable to warp than gum wood, and is somewhat harder. Just why it should be called whitewood is not clear, as it is much darker than white pine and of a greenish-yellow color.

The leaf of the tulip tree is very peculiar, having only four points, without any small teeth, and with an outline so odd that one often wonders if nature did not use a pair of scissors in cutting it out.

Each leaf stands out aggressively on a long stem. The glory of the tree — which gives it its name — is

the mass of tulip-shaped flowers it bears in the spring. They are large and brilliant, yellowish-green in color, with dashes of red, and develop a narrow, light-brown cone, which remains on the tree all winter. The tree thrives best south of the Ohio valley, where it is frequently found from five to seven feet in diameter. The Indians formerly made their dugout canoes from its trunk, and in some sections it is still called *canoe wood*.

55. Basswood, or Linden. A very valuable group of trees for both shade and timber are the basswoods, or lindens. There are several varieties, the European linden thriving here as readily as our native varieties. These trees may always be distinguished by



FIG. 113. Tulip, or Whitewood

the leaves, which are heartshaped and lopsided, i.e. one side from the middle line being always larger than the other, as if two leaves of different sizes had been joined along the center.

This is a very common feature among certain classes of trees, such as the elms. Another remarkable feature is the seed, or bract, shown in the sketch (Fig. 115).

The tree is sugar-loaf in shape, gives a dense shade, and has sweet flowers so fragrant that it is sometimes called the *bee tree*, because the bees swarm all over it in the summer time. Its timber is valuable, being free



FIG. 114. American Linden, or Basswood, showing the Sugar-Loaf Form of the Tree

from knots and of such an even grain that it is much sought after for some kinds of carving.

The familiar cigar-store Indian is usually carved from basswood.

Among the broad-leaved trees there are still several familiar families, all loved by some of us for some reason.

The willow is always a striking tree, not only because of its weeping or drooping appearance, but also because we usually associate it with water.

What is more common in the country than a stream hidden by the willows which crowd its bank and dip down into the clear water!

Then, too, we watch it for the first sign of spring, and friends in different states often vie

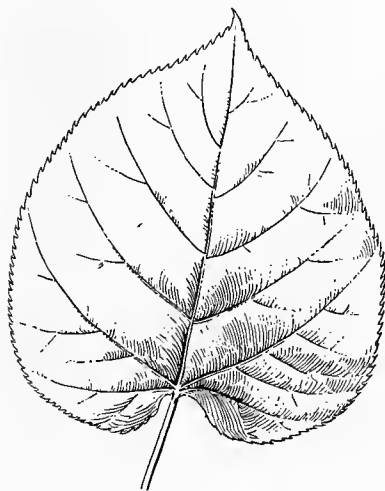

FIG. 115. Leaf and Bract of Linden



with each other to discover the first *pussy willow*, the name given to the soft, downy buds which appear often before the snow has melted.

The willow is dear to boys, because on the green twigs in spring the bark can be separated from the wood and a whistle or simple flute manufactured.

The wood of the willow is not very valuable, being used chiefly by pulp makers, but it grows where no other trees can exist, being found nearly all over the world, and creeping nearer to the north pole than any other broad-leaved tree except the birch. It has over



FIG. 116. A Weeping Willow

one hundred and fifty varieties, which vary from small shrubs up to trees a hundred feet high. Its soft and gentle beauty is sufficient excuse for its existence.

56. The Poplars. In the poplars we have a group of trees similar to the willows in some ways but very different in others. The wood is weak and of little

use except for fuel and paper pulp, but there the likeness ends.

To this family belongs the quaking aspen, whose leaves are continually trembling,—in fact, the whole family is a restless one, the constant motion being due to the shape of the long stems, which are flattened.

The people of Scotland have a superstition that it was of aspen

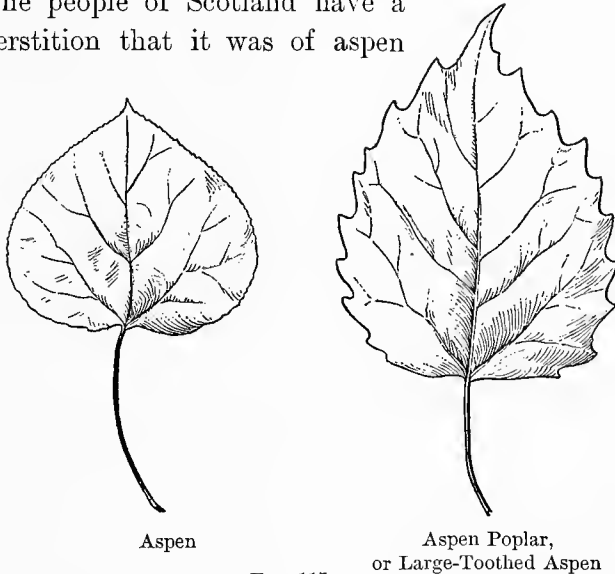

FIG. 117

wood that our Saviour's cross was made, and that the tree shivers in constant remembrance of that fact.

Beside the quaking aspen is the large-toothed aspen, the Lombardy poplar, and the cottonwood.

The Lombardy is the spirelike tree which seems to reach toward the clouds, and its tall, narrow form is familiar in many sections of our country, although the tree was originally imported from Europe.

Cottonwood and balm of Gilead are two well-known members of this family. Cottonwood is best known in

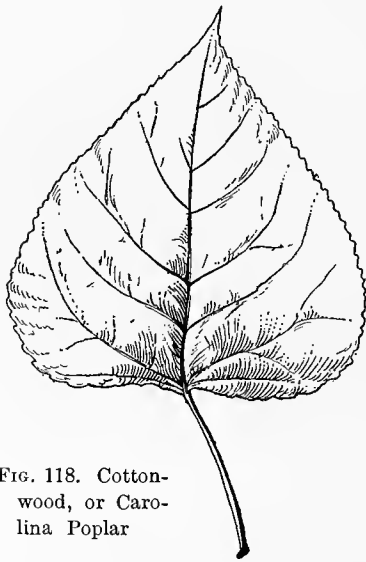

FIG. 118. Cottonwood, or Carolina Poplar

the West, where it often constitutes the chief and only growth along the water courses, and balm of Gilead is known as one of our common city shade trees. This latter tree, often called the balsam, is really an important tree of the great northwestern country, being found plentifully in the Klondike, and often forming in that far northern country great forests thousands of square

miles in extent. It is used as a shade tree because it stands the smoke and gas of the city where many other trees pine away and die.

57. Sassafras. We find many freaks in the tree world, and nature seems to have tried to see how odd

she really could be; for instance, on the sassafras tree we find three distinct kinds of leaves, having one, two, and three divisions.

This tree, which in the northern states is usually quite small, grows under favorable conditions to a height of fifty feet. It is noted for the pleasant taste of its leaves,



FIG. 119. Sassafras

twigs, and roots, which are used considerably in flavoring medicines.

58. Mulberry. Another tree noted for the peculiar shape of its leaves is the mulberry. There are three common kinds, named, from the color of their berries, *red*, *black*, and *white*.

It is the white mulberry whose leaves are the food of the silkworm. The leaves of this tree are quite regular,



FIG. 120. Red Mulberry, showing Variation in Leaf Form

but those of the red and black vary apparently as they please. No two leaves seem to be alike either in size or shape, and they are very soft and downy.

CHAPTER X

THE EVERGREENS

The evergreen trees, so called because their needle-like leaves remain on the tree all winter, are fully as



FIG. 121. White Pines at Westbury, Long Island

interesting as the broad-leaved trees. Without them our landscapes in winter would be much more barren and bleak, and their shade is very pleasant in summer.



FIG. 122. A View showing how Evergreens help to enrich the Landscape. Arbor Vitæ Hedges

A pine forest with its fresh balsam air and needle-covered floor is a sight to be long remembered.

The wood of the evergreens is usually classed among the soft timbers, although the yellow pine is far from soft.

59. White Pine. The king among evergreens is usually admitted to be the white pine. Its soft, bluish-green foliage, the widespreading branches, and the value of its fine, even-grained wood give it the first rank.

Pines have needle-shaped leaves which grow in groups of two, three, or five. White pine needles grow in groups of five and are from three to four inches long. The cones which contain the seeds are about five inches long. The tree grows tall and straight, and formerly grew in great forests covering thousands of square miles; the wood is so



FIG. 123. Needles and Cone of White Pine

free from pitch and is so easily worked with tools that these great forests have been almost annihilated by the lumberman's ax, and white-pine timber has become quite expensive. It takes many years for a tree to grow large enough for timber, and unless we are more economical in the future white pine will be only a memory.

60. Georgia Pine. The southern yellow pine, or Georgia pine, is a very different tree from its northern cousin, the white pine, furnishing us with a resinous yellow wood, much harder than white pine, and a beautiful and valuable material for the interiors of buildings. It is also very durable and is frequently used for exposed places, such as the decks of ships.

The needles are very long, measuring a foot and sometimes fifteen inches in length.



FIG. 124. Hemlock

The seed cones are from six to ten inches long, and the scales have little prickles on their ends. The tree grows throughout the southern states from Virginia to Texas, and the cutting of its timber is a valuable industry of the South.

61. Yellow Pine. The common yellow pine must not be confounded with the long-leaved Georgia pine. The former has needles growing three in a bunch, and the latter short needles three or four inches long, growing two and sometimes three in a group. The cone of the common yellow pine is also very much smaller, being only two inches long.

Its wood is very valuable and is used for flooring, ceiling, and interior finishing.

There are several less important kinds of pine, such as the northern and Jersey scrub pines, and the red, or Norway pine.

Spruce, hemlock, and fir are well-known members of the evergreen family.

62. Hemlock is a graceful, dainty-looking tree, with drooping branches and little needles not over half an



FIG. 125. The Influence of Hemlock on the Winter Landscape. Snow Scene

inch long. It is a northern tree except along the Allegheny Mountains, where it extends as far south as Alabama. The seed cones are the tiniest brown things to be found among the common trees. They are no longer than the hemlock needles.

The wood is not as valuable as pine, splitting very easily and being afflicted with *shakes*, a defect caused by the annual layers or rings breaking away from each other when the trees are swayed by the winter storms. The bark is valuable, however, as it is rich in tannin.

63. Spruce. The tall, dark, cone-shaped evergreen trees which ornament so many of our old farm door-yards are usually some species of spruce. The spruce is sometimes mistaken for the balsam fir, which is so commonly used for Christmas trees, but they are so different that they need never be confused.

There are several varieties of spruce, including the red, black, white, and Norway, but they all bear a family resemblance.

Looking at the end of a spruce twig, it will be found that the needles completely surround it. This is not true of the fir. Then the spruce needles are sharp at the tip, while the fir needles are blunt.

This family is distinctly a northern group, being found as far north as Hudson Bay and forming dense forests, particularly on mountain sides. One may often see on the steep slopes the dividing line between the broad-leaved trees and the evergreens, the dark spruces extending clear up to the summit.

The red spruce is found as far south as Tennessee, but in that latitude it grows only at high elevations.

It has cones about one and a half inches long, and its wood is light, soft, and close-grained. The wood is used for the sounding-boards of musical instruments and for the frames of buildings.

The black spruce is the northern brother of the red, and is really a Canadian tree which occasionally reaches down into the United States. It reaches the Mackenzie River on the north and covers large areas in Manitoba.

It takes its name from the dark, somber color of its foliage, which seems almost black against the snowy hillsides.

The cones are the same size as on the red spruce, but they persist in remaining on the tree for several years. The wood is soft and weak and is used for sounding-boards, pulp, and light framing for houses.



FIG. 126. Black Spruce

The white spruce is similar to the other two, but lighter in color, cones a trifle longer and softer, and needles more slender. It is a northern tree; its wood is very white and clear-grained, and is used for finishing the interior of houses.

Norway spruce, as its name implies, is an importation from Europe, where its majestic height graces the mountains from the Alps to Norway and Sweden. It

grows very tall, sometimes a hundred and fifty feet, and flourishes as well in America as in Europe. The cones are four or five inches long. Its wood is known in Europe as *deal*.

64. Cypress. In the swamps of our southern states, from Maryland south along the Gulf of Mexico, are found great dark forests of the bald cypress.



FIG. 127. Cypress

They grow directly out of the water and are famous for a peculiar formation of the roots called *cypress knees*, — lumpy growths which come up out of the water as if they were in search of air. The cypress is a tall, spirelike tree, which has the most delicate, feathery needles im-

aginable. They drop off in the fall, so that the tree is sometimes called *deciduous cypress*. The cones are roundish and about an inch long. The timber furnished by this tree is very handsome in grain and valuable for many parts of buildings, especially inside finishing.

65. The Balsam Fir, or our famous Christmas tree, is noted for its great healing qualities. In fact, sanitarium

for invalids, especially consumptives, are frequently built in the midst of great fir forests, that the sufferers may inhale the pure mountain air, laden as it is with the odors of the balsam fir. The needles are often used to fill pillows, which are said to soothe tired and worn-out people to sleep.

We are all familiar with the sweet, *woody* smell of the Christmas tree. No other tree can take its place. It brings visions of the country, of the woods and fields and flowers, and it will always be dear to us.

The balsam fir can always be distinguished from the spruce by the fact that the needles only come out at the sides of the twig instead of from all directions, as in the spruce, and its end is blunt, whereas that of the spruce is sharply pointed.



FIG. 128. Balsam Fir

The bark of the tree is gray and has tiny blisters which contain the balsam, *Canada balsam* it is usually called, well known for its healing qualities.

The cones are from two to four inches long, stand upright on the branches, and the wood is not very valuable.

66. The Cedars. No list of evergreen trees would be complete without the cedars. In this group is the well-known hedge tree, arbor vitæ, sometimes erroneously called *white cedar*. It is famous for its flattened, bright green, scaly leaves, with their strong, pungent odor.

This tree is usually so trimmed that we have very little knowledge as to its real shape and height if allowed to grow naturally; but it is said to reach a height of fifty feet under favorable conditions.



FIG. 129. Arbor Vitæ

67. White Cedar. The real white cedar has a more delicate leaf and is fond of cool swamps.

It has a conical shape and is much larger than the arbor vitæ, reaching sometimes ninety feet. The wood is very valuable, being soft but durable, and is used for shingles, posts, and boats. It has the property of enduring the changes such as posts or other structural members are obliged to withstand in contact with the soil, and ranks next to yellow locust in this particular.

68. Red Cedar is the tree which supplies our lead pencils. It is remarkable for its straight, even grain,

and the ease with which it can be worked. This is the familiar tree of our roadside, where the birds who feast on the cedar berries have stood on the fence rails and unconsciously planted rows of cedars for future generations by dropping the seeds on the ground.



FIG. 130. Red Cedar growing along Roadside from Seed dropped by Birds

The red cedar seems to grow where other trees cannot exist, but like other trees responds to good treatment and reaches its best development in the balmy and luxuriant South.

It is found from Maine to Florida and from the Atlantic to the Pacific. In the North it rarely grows

over twenty feet high, and is of compact growth, but in Florida it reaches eighty feet.

The leaves are remarkable in that there are two shapes, the sharp or awl-shaped, and the scale-shaped, growing upon the same branch.

The wood is valuable for many purposes and has been used so extensively that it is becoming scarce.

Florida has furnished the world with red cedar for lead pencils for years, and it is said that during the Civil War, when the whole southern coast was blockaded, the European manufacturers were obliged to scour the world to find a substitute for the Florida cedar.

CHAPTER XI

THE BIG TREES

Each section of country has its own peculiar trees, and those described have been mainly representative



FIG. 131. Big Trees scarred by Fire at the Base. Redwood Meadow, California

of the eastern states; but no list of American trees would be complete without the "big trees," as they are



FIG. 132. Big Trees, "General Grant" and "General Sherman,"
Calaveras County, California

commonly called, of California. The annual rings of these giants show them to be from two thousand to four thousand years old.

It is hard to realize this great age. It means that for centuries and centuries before the white men came these kings of the forests looked down on generations



FIG. 133. "General Grant," a Big Tree, Mariposa Grove, California

and generations of Indian tribes. They may even have seen the coming of the first Indians. What wonderful tales they might relate if they could only talk!

On that fateful day over four hundred years ago, when the three little caravels of Columbus sighted the



FIG. 184. Redwood Logs in Humboldt County, California

West Indies, these hoary old trees were twenty-five hundred years old. They should be sacred to every American, and not one should ever be cut down for lumber.

There are two distinct kinds of big trees, the redwood and the so-called "big trees," which are the largest trees in the world. They both belong to the cone-bearing (coniferous) group, and the needles are only three quarters of an inch long and the little cones an inch.

The wood is reddish, as the name implies, not unlike red cedar, but is softer and is used for many purposes on the Pacific coast.

The big trees are now carefully guarded by the government. One grove alone which contains seven hundred of these fine trees, called the Mariposa Grove, has been reserved as a national park, and is watched carefully to keep out forest fires, etc.

Many of the best known of these trees are given names. One is called "Uncle Tom's Cabin," because of a peculiar opening at the base.

The most famous perhaps is the "Grizzly Giant." This one is ninety-three feet in circumference at the ground, and its first branch is two hundred feet above the earth and eight feet in diameter. It is considered the largest tree in the world.

We can get some idea of what these figures represent when we know that it takes five men three weeks to

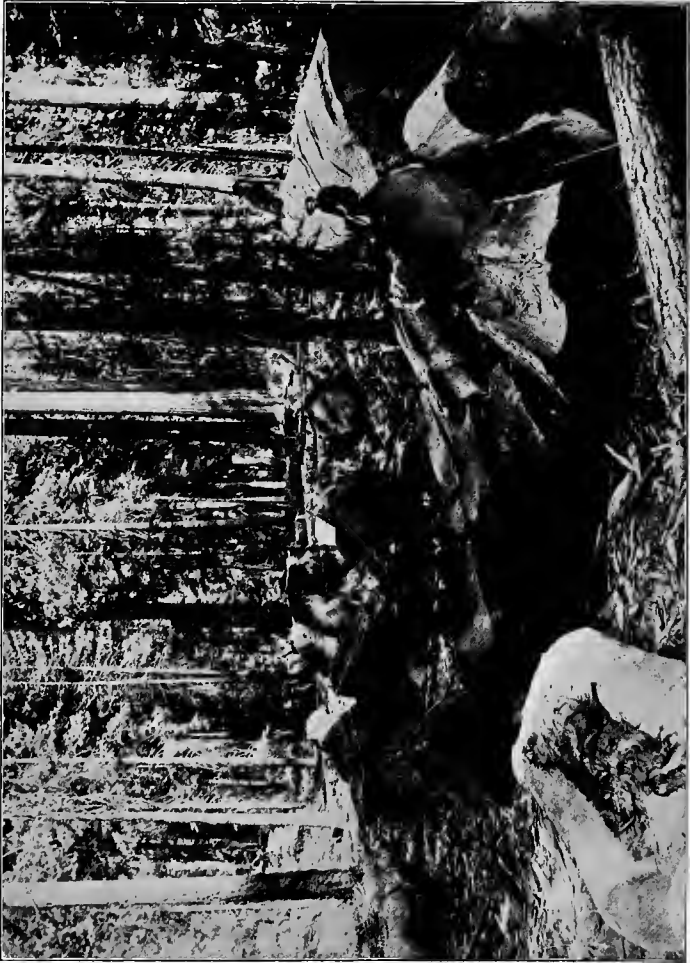

FIG. 135. Redwood Logs blasted apart for Easier Handling (a very wasteful method)

cut one down, and that the cost of felling one of these monsters is five hundred dollars.

A stump of one of these trees is so large that dances have been held on it, and on one very large one a ball-room has been built for this special purpose.

As one Californian has said, "The redwood forests are apparently imperishable, except through the ax, as the trees are rarely injured by fire. The redwood is the only lumber that can take the place of the white pine, answer as a satisfactory substitute for mahogany and black walnut, displace oak for railroad ties, cypress and cedar for shingles, and surpass all other woods for durability when in contact with the earth or when exposed to moisture."



FIG. 136. Immense Flock of Sheep being herded illegally in a United States Government Forest Reservation. (They kill the young seedling trees)

INDEX

	PAGE		PAGE
Annual rings	59	Chisel, cutting angle of . . .	23
Ash	92	firmer	24
Aspen	107	framing	24
		methods of using . . .	24
Band saw	58	sharpening	25
Basswood	103	Clamp iron of plane	18
Beech	99	Compound leaves	85
Bench, care of	3	Cottonwood, or Carolina pop-	
Bench hook	15	lar	108
Bevel	10	Cutting tools	11
Big Trees of California . . .	123	Cypress	118
Birches	96		
Bit, auger	27	Dovetail. <i>See</i> Joint	
auger, details of	28	Drawing board	45, 62
center	27		
countersink	29	Elm, American	94
gimlet	29	Evergreens	111
Black walnut	89		
Brace, common forms of. . .	26	Felling trees	52
and bit	27	Fir, balsam	118
Bract of linden	105	Framing square	8
Buckeye	87		
Butternut	89	Gang saw	55
Buttonwood	101	Glue, use of	39
		Grain of wood	59
Cap iron	17	Groups of tools	4
Cedar	120	Gum, sweet, or liquid amber	101

	PAGE		PAGE
Hammer, claw	31	Maple, sugar	76
use of	32	sycamore	80
Handscrew, use of	40	Maple keys	82
Hemlock	115	Marking gauge	8
Hickory	87	Mechanical drawing	43
Honey locust	91	of end lap joint	44
Hornbeam	100	of cylinder	44
Horse-chestnut	86	Medullary rays	59
		Miscellaneous tools	31
Ironwood	100	Mortise, cutting a	34
		Mulberry	109
Joint, definition of	39		
dovetail	47	Nail set or punch	32
end lap	44	Nails, cut and wire	41
middle lap	38	method of using cut	41
miter	41	withdrawing	32
Joint edge	37		
Jointers	21	Oak, black and black-jack	69
		chestnut	74
Laying out work	38	live	75
Linden, or basswood	103	mossy-cup	68
Locust	91	pin	72
Log boom	55	post	67
Log jam	53	red	70
Logs, redwood	126	scarlet	71
Lumbering and milling	51	white	66
		Oilstone, use of	25
Mallet	33		
Maple, ash-leaved	82	Pecan	89
Japan	84	Perspective drawing and	
Norway	78	constructive drawing	
red	80	compared	43
silver	78	Pine, Georgia	114
striped	81	white	113

	PAGE		PAGE
Pine, yellow	114	Saws	11
Plan of work	4	Scale drawing	48
Plane	17	Screw-driver	33
adjustments on	18	Screws, varieties of, and methods of using	42
block	21	Sections of red oak	70
block, method of using	22	Set screw of plane iron	17
jack	19	Shake in wood	60
smooth	20	Shrinkage	61
wooden	22	Spokeshave	29
Plane iron in action	17	Spruce	116
Poplars	106	Stock, squaring up	36
River driving	53	Sycamore	101
Rule, use of	6	T square, use of	45
Sandpaper, use of	34	Timber and lumber	58
Sassafras	108	Trees, broad-leaved, or decid- uous	65
Saw, back	15	Triangles, use of	45
circular	57	Try-square, use of	6
method of holding	14	Tulip, or whitewood	102
turning	16	Warping	61
Saw tapers	14	Weather checks	60
Saw teeth, shape of	13	Willow	106
Saw tooth action	11	Working face	37
Saw tooth set	13		
Sawmill	55		

