

*"Oliver" Combination Lathe*



# WOOD PATTERN-MAKING

The Fundamental Principles and Elementary  
Practice of the Art. To which is  
added an appendix on the Care  
and Use of Woodworking,  
(Bench) Tools.

BY

HORACE TRAITON PURFIELD

Instructor in Woodwork and Pattern Making, in the  
Department of Engineering

OF THE

UNIVERSITY OF MICHIGAN

---

PUBLISHED BY THE AUTHOR

1906  
THE SCHARF TAG, LABEL & BOX CO.  
YPSILANTI, MICH.

---

**COPYRIGHT, 1906, BY  
HORACE TRAITON PURFIELD**

119776

JUN 10 1908

6837267

TCH

P97

## PREFACE

An experience of seventeen years in teaching pattern-making and kindred subjects has made me feel the great need of such a work as this which I now offer as a text-book for students in technical and manual training schools, and universities. A number of excellent books on the subject have been published, to be sure, but most of them assume on their reader's part previous acquaintance with the fundamental ideas of pattern-making; such as do treat at all of the elementary part of the subject, happen to be works of an exhaustive character, which are consequently too expensive for use as text-books. The present work, therefore, will, it is hoped, find a field of usefulness for itself.

It is of course to be recognized that as pattern-making is an art, it cannot be learned simply by reading any book on the subject; but only by practice. Still a text-book may afford valuable assistance even to the artisan. This work, however, has a further and more important purpose,—that of imparting to the engineer or the draftsman the fundamental principles of pattern-making. For only as he is in possession of these can he make designs for patterns in accordance with which shop work can be performed in the most efficient and most economical manner. The reader should also understand that this work, being designed only as an elementary treatise, in no way exhausts the subject. It is claimed however, that the examples of pattern-making submitted indicate, on the whole, the best methods of construction and those most easily understood by the student.

In preparing the body of this work, I have received many valuable suggestions which have been incorporated herewith, and which will have contributed to any success the book may attain. The works of many previous writers on the subject have been consulted also; for specific ideas derived from them credit should be given to Joshua Rose, M. E., J. McKim Chase, and P. S. Dingey. In preparing the appendix considerable help was afforded me by the little book of W. F. M. Goss, on "Bench Work in Wood." With these few words of introduction, I leave the book to its readers with the hope that it will assist them to master the important subject of which it treats.

H. T. P.

## CONTENTS

CHAP.	PAGE
PREFACE . . . . .	V
LIST OF ILLUSTRATIONS . . . . .	VIII
I. INTRODUCTION . . . . .	1
II. MOLDING . . . . .	6
III. GENERAL PRINCIPLES . . . . .	12
IV. MATERIALS . . . . .	20
V. FILLETS . . . . .	30
VI. CORES . . . . .	37
VII. MOLDER'S JOINTS OR PARTINGS . . . . .	46
VIII. CONSTRUCTIONAL JOINTS . . . . .	55
IX. SPECIAL TYPES OF PATTERNS . . . . .	66
X. PLATE WORK AND IRREGULAR PARTING . . . . .	83
XI. PULLEY PATTERNS . . . . .	93
XII. PATTERNS FOR CAST GEARS . . . . .	108
XIII. PIPE FITTINGS . . . . .	126
XIV. MISCELLANEOUS . . . . .	132
STOVE PATTERN-MAKING . . . . .	145

## APPENDIX

READING MECHANICAL (WORKING) DRAWINGS . . . . .	154
LUMBER . . . . .	161
PATTERN TURNING . . . . .	199
PLANES AND PLANE-LIKE TOOLS . . . . .	188
CUTTING WEDGES . . . . .	195
BORING TOOLS . . . . .	181
SAWS . . . . .	111
INDEX . . . . .	212



## LIST OF ILLUSTRATIONS

### FULL PAGE

<p>"Oliver" Combination Lathe —<i>Frontispiece</i></p> <p>"Oliver" Bandsaw, 82</p> <p>"Oliver" Handjointer, 36</p> <p>"Oliver" Trimmers, 97.</p> <p>Bed of Trimmer, 98.</p> <p>"Crane" Core Box machine, 45.</p>	<p>Wood Lathe with Compound Rest, 54.</p> <p>Universal Sander, 29.</p> <p>Universal Bench Saw, 65.</p> <p>Williamsport Scroll Saw, 65.</p> <p>"Rogers" Double Surfacers, 153</p>
--	--

### IN THE TEXT

FIG.

1. Cylinder, with coreprints, 6
2. Molder's Flask, 7
3. To illustrate "draft," 14
4. Coefficients of shrinkage, 16
5. Screws in end wood, 28
6. Fillets sqr. corner, 31
7. Fillets round corner, 31
8. Pattern with square hole, 38
9. Mold made from No. 8, 38
10. Core and full box, 39
11. Different size core prints, 41
12. Taper core print system, 44
13. (a) Section of a mold, 47
14. Single flange wheel, 47
15. Double flange wheel, 48
16. Worm wheel, 48
17. Hook lever, 49
18. Small bracket, 50
19. Loose pieces skewered on, 50
20. Hollow cylindrical casting, 51
21. Hollow cylindrical pattern, 51

FIG.

22. Hollow cylindrical core-box, 52
23. Built up disc, 56
24. Built up disc edge, 56
25. Thin board and counter ribs, 57
26. Open joints cylinder hd., 58
27. Open joints boxing up patterns, 58
28. Open joints up corner, 58
29. Lagged or staved up cylinder, 60
30. Lagged up cylinder narrow lags, 61
31. Lagged up core box, 61
32. Annular pattern, 62
33. Square frame (plate work), 63
34. Square frame (plate work), 64
35. Round corner, 64
36. Gland (the casting), 67
36. (a) Gland leaving its own core, 69

- |   |   |
|---|---|
| <ul style="list-style-type: none"> <li>37. Gland Pattern, 67</li> <li>38. Gland core box, 71</li> <li>39. Laying out core box, 71</li> <li>40. Core box plane, 72</li> <li>41. Core box plane with guide, 73</li> <li>41. (a) Conical core box, 74</li> <li>42. Chuck with pieces nailed on, 76</li> <li>43. Cylinder with flange both ends, 77</li> <li>44. Cylinder with flange both patterns, 77</li> <li>45. Cylinder with flange (core box), 77</li> <li>46. Pump standard (casting), 84</li> <li>47. Pump standard (pattern), 86</li> <li>48. Core prints for No. 47, 88</li> <li>49. Core box for No. 47, 89</li> <li>50. A, Turning bosses, 90</li> <li>50. B, Hook lever drawing, 91</li> <li>53. Pulley, 93</li> <li>54. Shoot board, 96</li> <li>55. Center of spider, 100</li> <li>56. Three armed chuck, 109</li> <li>56. A, Form of gear rim, 110</li> <li>57. Methods of forming gear teeth, 112</li> <li>58. Box for laying out gear teeth, 113</li> <li>59. Laying out No. 58, 113</li> <li>60. Laying out tooth curves, 117</li> <li>61. Bevel gear lay out, 121</li> </ul> | <ul style="list-style-type: none"> <li>62. Chuck, 122</li> <li>63. Chuck, large, 123</li> <li>64. Pipe bend, 126</li> <li>65. Pipe bend, 127</li> <li>66. Pipe bend, 127</li> <li>67. Pipe bend, 128</li> <li>68. Pipe bend, 128</li> <li>69. Pipe bend, 128</li> <li>70. Pipe bend, core box, 128</li> <li>71. Pipe bend, core box, 131</li> <li>72. Pipe elbow, 129</li> <li>73. Pipe elbow ring, 129</li> <li>74. Pipe elbow ends and prints, 130</li> <li>75. Pipe elbow built together, 130</li> <li>76. Pipe elbow core box, 131</li> <li>77. Steam chest cover (casting), 132</li> <li>78. Steam chest cover pattern, 133</li> <li>79. Skeleton pattern, 134</li> <li>80. Skeleton pattern core, 134</li> <li>81. Skeleton pattern, boiler plate form, 136</li> <li>82. Gluing feather edge-board, 137</li> <li>83. Piston ring, 140</li> <li>84. Piston ring pattern, 140</li> <li>85. Drill press column, 141</li> <li>86. Loose piece dovetailed on, 143</li> </ul> |
|---|---|

## APPENDIX

## FIG.

- 1. Pattern-maker's bench, 167
- 1. (a) Pattern-maker's vise, 168
- 2. Bench hook, 168

## FIG.

- 3. Saw-horse, 169
- 4. Two-foot rule, 170
- 5. Framing square, 171

6. Try square, 171
7. Combination square, 172
8. Bevel, 172
9. Laying out angles with dividers, 173
10. Marking gauge, 174
11. Mortise gauge, 174
12. Tanged firmer chisel, 175
14. Socket firmer chisel, 175
15. Inside gouge, 176
16. Outside gouge, 176
17. Sweeps of gauges, 177
18. Draw shave, 177
19. Handsaw, 178
20. Backsaw, 178
21. Keyhold saw, 178
22. Compass saw, 178
23. Ripsaw teeth, 180
24. Cross-cut teeth, 180
25. Auger bit, 182
26. Square hole auger, 182
26. (a) Countersink drill bit, 182
27. Syracuse drill bit, 183
28. Expansive bit, 183
29. Forstner bit, 183
30. Center bit, 183
31. Countersink, 184
32. Bit-brace, 185
32. (a) Screwdriver, 185
33. Miter box, 186
34. Handscrew, 187
35. Iron clamp, 187
36. Iron plane with single iron, 190
37. Iron plane with double iron, 191
38. Wood plane with double iron, 191
39. Jackplane, 192
40. Blockplane, 192
41. Rebate plane, 193
42. Plow plane, 193
43. Dado plane, 194
44. Spoke shave, 194
45. Spoke shave, round, 195
46. Grinding a cutting wedge, 197
47. Turning lathe, 200
48. Fork center, 201
49. Screw chuck, 202
50. Cup chuck, 203
51. Turner's gouge, 204
52. Turner's chisel, 204
53. Group of scrapers, 205
54. Core box plane, 195
55. Use of turning gouge, 206
56. Use of turning or skew chisel, 207
57. Use of turning chisel (two positions), 208
58. Scraping a cylinder, 209
59. Outside caliper, 210
60. Inside caliper, 210

## CHAPTER I.

### INTRODUCTION

A pattern may be defined as a model about which is to be formed a sand mold, in which a casting is to be made. It is usually of wood or metal, and often constructed in several parts so as to facilitate removal from the mold. In the foundry and machinery business the word **pattern** is understood to mean any **form** or **device** by the use of which a **mold** may be **made**. Pattern-making differs from all other wood-work in several ways. The product of the pattern shop becomes a part of the tools or working outfit of another workman, viz., the molder. The joiner, in making a door, makes it just the size required by the drawing or specifications; the cabinet-maker does the same when called upon to make a table or other piece of furniture; the carpenter also follows this same idea when building a bridge. In all these, the ultimate object is reached when the work is complete. It is not so, however, with the pattern-maker; his product is only one step in arriving at the desired end, that end being the production of one or more castings of some kind of metal. Allowances must be made in constructing a pattern, that do not have to be considered in other wood-work; the principle of these allowances are for draft, shrinkage of the metal of the casting, and the machining of the casting where required. A pattern-

maker must be a good wood-worker, and able to work wood to accurate dimensions, both on the bench and in the lathe, as pattern-making consists largely of fitting, joining, and making circular and other forms to correct size. This knowledge and ability are necessary to the pattern-maker, because a large majority of patterns are made of wood. The pattern-maker must also know something, and the more the better, of the practical work of the molder. This is necessary in order that he may be able to produce easily-molded patterns. He should possess a good practical knowledge of the properties of metals, as, for instance, the contraction or shrinkage that these undergo in passing from the molten to the solid state, the strength of cast metals, and also their relative rate of cooling. He should also thoroughly understand the principles of Orthographic projection, so that, if it becomes necessary, as is frequently the case, he can make full sized working drawings of the work in hand.

The production of ordinary metal castings, such as those of iron or brass, involves three distinct operations. First, making the pattern; Second, from this pattern a mold is made in sand or some other substance that is refractory enough to withstand the action of melted metal; Third, the metal is melted and poured into this mold. Each of these operations require especial skill, and has given rise to a special trade, although the second and third, called respectively molding and founding, are often performed by the same person. These operations are sometimes so intricate, and admit of so much variety, that the above statements are only true in the main. Nevertheless, they hold good in general, and in a consideration of this subject the pattern-maker may be understood to be a wood-worker, the

molder as one that makes the molds, and the founder as the one that has charge of the furnace and the melting of metals.

In the first of these operations, that of the pattern-maker, there is needed a fine degree of skill in the arts of cabinet making and wood turning. Moreover, the two trades, the molder's and pattern-maker's, are so intimately connected, that it is almost impossible to describe one without frequent reference to the other, and as a matter of fact there is almost as much to be learned of pattern-making in the foundry as in the pattern shop. So intimately connected are the operations of pattern-making and molding, that one of the chief qualifications of a good pattern-maker is the ability to form a rapid and reliable judgment as to the best way of molding a given pattern out of several ways possible. As there is usually more than one way of molding a given pattern, it is advisable that the pattern-maker, if in any doubt, confer with the molder as to his preference in the matter; as the molder is responsible for the production of the casting, he should have the pattern as he wants it. As pattern-making, therefore, is to be regarded primarily from the molder's standpoint, and not from that of the wood-worker, the following matters are of first importance:

(1) Patterns being entirely enclosed in matrices of sand, provision must be made for pulling them out; this involves draught or taper, which is a thinning down of certain parts, division into sections, and provision for loosening by rapping.

(2) Molding sand is always used damp, and patterns are subject to rough usage, consequently they must be made so as to resist any tendency to change their form and size from the absorption of moisture from

the damp sand, and they must be strongly constructed.

(3) Most metals shrink or contract in passing from the molten to the solid state; therefore, patterns must be made larger than the required casting to allow for this.

(4) Patterns may be entire or complete, exactly like the castings wanted; however, if there are cavities to be formed in the casting, these hollow places will be represented by core prints. Moreover, the part the pattern-maker has to do with getting out a given casting may be the preparation of a sectional part or parts of a pattern from which only a part of the mold is made; the other part is made with a sweep, the boards for which are also prepared by the pattern-maker.

(5) The practice of pattern-making is largely governed by the requirements of the engineer; these requirements are that patterns must correspond to drawings in all dimensions, that all centers be correctly located, and that all necessary allowances be made both for machining and for the shrinkage of the metal of the casting.

It will thus be seen that the pattern-maker has very little in common with carpenters, or indeed, with any other wood-worker, except for the fact that he uses the same tools and processes. To understand, then, the fundamental principles of pattern-making, it is necessary to master the principles of molding, and much of its details as well; and to have a good working knowledge of modern machine shop practice. It is well to remember also that mere outside polish or finish on a pattern does not count for much if such matters as correct construction and others already spoken of, are neglected.

In many trades, to become an expert in handling tools, is the most necessary requirement, but this is not

the case in pattern-making, there being something far more important than cutting wood. In the construction of many patterns it is not so much a question of workmanship, as of knowledge. Certain patterns, for example, are very difficult to design, but after they are once made, they can be duplicated by any good wood-worker. In fact, it often requires but little skill to construct the necessary core boxes, etc., that may be required to produce certain castings. On the other hand, there is much pattern-making that calls for fine workmanship; in any event, pattern-making is not merely cutting wood.

From what has been said, then, it will readily be appreciated that pattern-making is an important and responsible trade. For while the duty belongs to the draughtsman of preparing the design, yet the pattern-maker must be able so to interpret it as to get the idea the draughtsman intended to convey. Moreover, he must look forward to the requirements of the molder; consequently, from the drawing alone he must be able to imagine the completed casting, and build a pattern that will produce it. As the medium by which the designer's ideas are put into the tangible form of a casting, his, then, is a two-fold responsibility. Another fact that adds to his responsibility is, that there are so many different ways of molding. This gives a great field of study for the pattern-maker. The fact that there are so many different ways of molding makes it advisable for the pattern-maker to consult the molder before making patterns for complicated work.



## CHAPTER II.

### MOLDING

A pattern-maker should know something about the operations of the molder, so that he can make a particular pattern of such a shape that it can be molded in the easiest way possible. This being the case, it is necessary to explain some of these operations. The form of pattern used in this illustration is what is known as a **parted pattern**; the molding operations that this form involves are generally few and simple. As will be seen by Fig. 1, the pattern is made in two parts, the **parting** or joint being along the axis of the cylinder. It is made in this way



FIG. 1.

for the convenience of the molder. These two parts are held sideways in relation to each other by what are called **pattern pins**, represented by dotted lines, c and d. Parts marked A and B are core prints, and will not appear on the casting.

The appliance used by the molder in which to make the mold is called a **flask**, and is illustrated by Fig. 2. The upper part, A, is called the **cope**, the lower part, B,

the **nowel**; C is the **bottom board**, D, **cope bars**, E, **guide pins**. Each flask is composed of at least these three main parts, viz., cope, nowel, and bottom board. Sometimes another part is introduced between the nowel and cope, called the **check**, or **middle part**. This is necessary when the casting is of such shape that its pattern cannot be taken from the mold with the one parting obtained by the use of cope and nowel alone, that is with the simple form of flask shown by Fig. 2. In addition to these

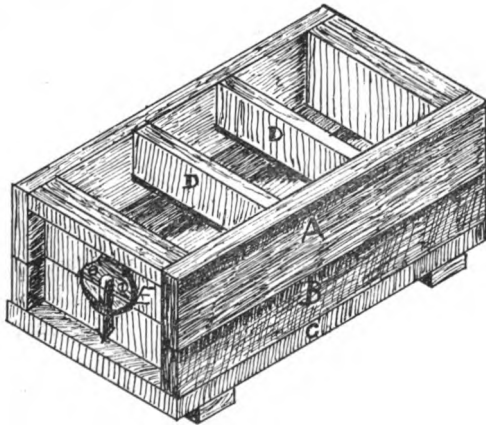

FIG. 2.

parts a **molding board** is needed, which may be just like the bottom board. Only one molding board is required by one workman for any number of flasks of the same size.

The words **top** and **bottom** will be frequently used in writing of this flask. They refer to the flask when standing in what may be called its **normal** position, that is, as it stands when the mold is **ready for the melted metal to be poured in**. The relative position of these two

parts is that the cope is always on top, the nowel at the bottom. Each part is a box having neither top nor bottom, the sides generally being about 5 or 6 inches high, and rough inside.

In order that, after being separated, these may be put together again in the same relative position, they are provided with guide pins (E) Fig. 2, the pins proper being on the cope, and the lugs into which they fit, being on the nowel. The cope is also provided with some form of handles. In Fig. 2, one of these is shown at E, being in this case a strip of wood about one inch square nailed across the end, directly above the guide pins. These handles are provided for the purpose of lifting the cope from the nowel at any time it becomes necessary to do so during the process of molding.

There are also cross bars fastened across the cope (D Fig. 2) to assist in retaining the sand, which is held in place by friction only, the cope from necessity having no bottom. In all other respects cope and nowel are alike, except that in some cases one may be deeper than the other.

In using this appliance the molder first places the molding board on the sand floor of the foundry in an approximately level position, and so it will not rock. He then places the half of the pattern that is without pins on its flat side in the center of the molding board. The nowel, or drag, which is the lower half of the flask, is next placed on this board, bottom side up, with the half pattern in the middle of it. Next he sifts molding sand on to this board until the half pattern is covered to a depth of an inch or more; he now shovels in sand until the nowel is filled and heaped up; then, with an implement called a rammer, he rams it down

solid. The sand is now struck off even with the bottom of the nowel, some loose sand thrown on, and the bottom board placed on and rubbed around so as to make a solid bed for the body of sand in the nowel. Clamps are now put on so as to hold all together, the whole is turned over, the clamps removed, and the molding board lifted off. This completes one half of the mold, or, as the molder expresses it, "the nowel has been rammed up and turned over." He now sleeks the surface with his trowel until it is even with the flat surface of the half pattern, which is thus exposed to view, surrounded by sand. He now scatters on some parting sand, which is a very dry sand, usually burnt sand that has been cleaned from castings already made. The purpose of this is to prevent the next body of sand from sticking. The other half of the pattern is now laid on, its position being determined by the pins already spoken of, and the corresponding holes in the other half of the pattern. The sprue pin or stick is now set up on the sand or parting just finished. This pin is a piece of wood, whose shape is the frustrum of a cone about ten inches long; its purpose is to make a hole through the cope sand into which the melted metal may be poured. Sand is put into the cope in the same way as was done with the nowel; struck off even with the top, the sprue pin pulled out, and the whole surface brushed over so as to remove all loose sand. The cope is lifted off carefully, and set to one side. Both halves of the mold now appear exactly alike, except that the cope has the sprue hole running through it.

The two halves of the pattern must now be drawn or **pulled** out. This the molder proceeds to do in the following manner: If the pattern is provided with lift-

ing plates, as all standard patterns should be, he introduces the end of the lifting screw into the hole provided for it in the lifting plate, and turns it in so that it is solid. If there are no lifting plates, he drives what he calls a draw spike into one of the halves. Then, with a mallet, a small hammer, or perhaps a sprue pin, he raps on all sides of the lifting screw or draw spike, so as to loosen the pattern. This operation, called **rapping the pattern**, enlarges the mold so that the pattern may be pulled or drawn out. This he now does, very slowly and carefully, gently rapping the pattern until it is entirely free from the mold. This is done to both halves. A channel is now cut in the sand of the nowel from the spot on the parting where the sprue pin was set, to the mold or cavity left by removing the pattern. Thus is provided a passage through which the melted metal may run and fill the mold. This channel is called the **gate**. The mold is now ready to have the core set in. After the core is set, the cope is put back into its original or normal position, which is determined by the guide pins; the whole is then clamped together, and set in position for pouring. As stated at the beginning, this process applies **only** to parted patterns. This same flask may be used in several different ways, the particular way being determined by the **shape** and **size** of the pattern. For some shapes of patterns it is necessary to use three (3) boxes or **parts**; this is usually called a **three-part flask**, thereby meaning that the mold is composed of three distinct bodies of sand. The central part of a three-part flask is called the **check**. The cheek has on it a set of guide pins the same as the cope, and also a set of lugs like those on the nowel, on the opposite edge. It is made in this way, so that any cope or nowel of the same size may be used with it.

These simple explanations will be enough to give the student of pattern-making a general idea as to the use of patterns in the foundry. Of course there are many details to be observed and carried out in the production of castings that are not mentioned above, but as these more particularly concern the molder than the pattern-maker, they will not be noticed here.

## CHAPTER III.

### GENERAL PRINCIPLES

In building foundry patterns several ideas must be kept in mind, either consciously or unconsciously. These are four in number, or (when we have no source of information as to what is wanted, except a drawing of the required casting), there may be five, as follows:

(1) What may be called the **designer's idea**; (2) the way in which the pattern is to be **pulled** from the sand; (3) the **draft**, or taper, which is a thinning down of certain parts of the pattern in order to **facilitate** its **removal** from the mold or sand; (4) the **shrinkage** of the metal of the proposed casting, while passing from the molten to the solid state; and (5) the **machining** or **finishing** of the casting after it is made or cast.

An experienced pattern-maker may not be conscious that he has in mind any one of these ideas, because he uses them so frequently that he does so without thinking especially of them; in other words, they become second nature to him. It is these last four ideas, among others, that separates this trade from all other wood-working trades and connect it with the engineering profession, for there is not one of them that has even to be thought of by those working at any other of the wood-working trades. Before we explain these ideas in detail, it will be best to have them arranged before the mind in such a way that

they may be easily remembered, and in the order of their use and importance. For convenience, then, we will put them in a vertical column, thus:

1. **Designer's idea.** —
2. **Way to be drawn from mold.** —
3. **Draft.** —
4. **Shrinkage of metal.** —
5. **Machining.** —

Besides these five ideas, the last three of which may be called **allowances**, there are two other allowances that sometimes have to be considered, viz.: for **shake** and for **warp**.

The two first of these five are purely abstract ideas. If it is desired to make a pattern from a drawing only, that is, if there is no other means of knowing what is wanted, then it will be necessary for the one building it to form as nearly as possible the same mental picture that the designer had in mind when making the drawing. This may be called the **designer's idea**, and to some extent, at least, must be realized before much can be done towards building a pattern. After having thus formed in mind the general shape and approximate size of the required pattern, it can be decided in which way it shall be drawn from the mold. This must be decided before very much can be done towards building the pattern, so that the draft may be made in the right direction, which is a very important matter.

The other three points that were mentioned are sometimes spoken of as the **allowances** to be made in pattern-making. They are really **additions** made to the size of the pattern in some one direction, or, as in the case of shrinkage, in all directions. The first of these, and in some respects the most important, is what



is technically called **draft**. This is a thinning down of certain parts of the pattern; that is, the vertical sides of the pattern are tapered, and it is sometimes spoken of as **the taper**.

The amount of draft to be allowed is governed by the case in hand, some patterns requiring more than others. The usual amount is 1-8 inch for 1 ft. in height; this is generally enough for small and comparatively plain work, but for complicated work it is not enough. No hard and fast rule, however, can be given for this allowance, or indeed for any work in pattern-making. What is nearest to a general rule may be

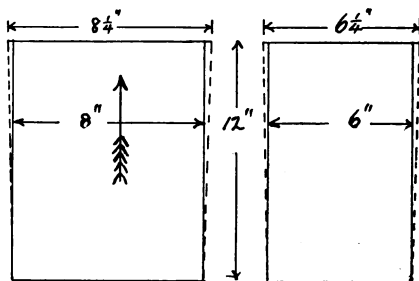

FIG. 3.

stated thus: Give the pattern as much draft up to **1-4 inch per foot** in height as will not **interfere** with the **design**. Whatever amount is allowed should be added to the size of the casting as given in the drawing. For small and plain work one-sixteenth of an inch will be enough, but if the pattern is at all complicated, one-quarter of an inch will not be too much. Of course, the requirements of the molder have to be considered, and if he was asked about it he would always say, give it the larger amount. To make this more plain, we will suppose that a pattern was wanted from which to make a mold for the casting represented by Fig. 3.

Now applying the above principle, we should make the top longer and wider by  $\frac{1}{4}$  inch than the size given, so that the top of the pattern would be  $8\frac{1}{4}$  inches long and  $6\frac{1}{4}$  inches wide. This addition, or allowance is shown by the dotted lines. In this case the pattern would be drawn out of the mold in the direction of the arrow. In practice it would not be necessary to allow so much draft on as plain a pattern as this, but we use it as an illustration of what is meant by the term draft. **All vertical sides** of the pattern, whatever its shape, **must have some taper** in order that the molder may get it out of the mold without breaking the mold. If no draft is allowed, the molder has to rap the pattern so much that the mold will be distorted and the casting will not be like the pattern.

The next important principle to be observed, especially when the casting is required to be exact in size, is that relating to **shrinkage**. Whenever this word is used in connection with pattern making, it always means the shrinkage or contraction of the metal of which the casting is made. An iron, brass, or steel casting is always smaller than the mold in which it was made, and this is true also of castings made of any of the other metals in common use. This is due to the shrinkage of the metal when cooling. The amount of the shrinkage varies in the different metals, and also in the same metal under varying conditions. Brass will shrink more than iron, and iron that is very hot when it is poured into the mold, will shrink more than iron that is comparatively cool when poured. The size and the shape of the casting also have much to do with the amount of shrinkage. An iron that will shrink one-eighth of an inch to the foot in light work, will shrink only one-tenth of an inch, or less,

in large work. For instance, in casting large box or cylindrical-shaped castings, one-tenth of an inch per foot is usually enough to allow for this shrinkage in the diameter, but one-eighth of an inch will not be too much in the length. The reason for this difference is due to the fact that the castings are practically unrestrained in their length, and are comparatively free to shrink in this direction, while in the diameter they are restricted by the cores and internal parts of the mold. The amount of allowance usually made in common practice is **1-8 inch per foot**, measured in **all** directions. But since the coefficient of shrinkage is different for different metals, this is only approximate. The following allowances for the different metals are made in the pattern when it is surely known just what metal the casting is to be made of, as, of course, is the case usually. One good way to remember these is to arrange the figures that represent these amounts in a group like Fig. 4.

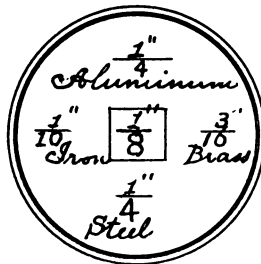

FIG. 4.

For iron, then, this allowance is  $\frac{1}{10}$  inch; for brass,  $\frac{3}{16}$  inch; aluminum,  $\frac{1}{4}$  inch, and for steel,  $\frac{1}{4}$  inch; the general amount, which is in the center of the group, is  $\frac{1}{8}$  inch. It must not be understood by this that these metals will always, and under all conditions,

shrink just these amounts; for, as has already been mentioned in the case of iron, the amount of shrinkage varies somewhat under varying conditions. For the use of pattern-makers, scales or rules are made. The one most commonly used provides for an allowance of  $\frac{1}{8}$  inch per foot; that is, the rule is made  $\frac{1}{8}$  inch longer than the standard foot rule, and each "inch" is correspondingly longer on it than the standard inch. Scales or rules can be bought at dealers, graduated for the other shrinkages above spoken of.

It has been a mooted question as to just when this shrinkage or contraction takes place in the casting, but it is generally conceded now that it takes place in passing from the plastic condition to the solid state. All metals, in passing from the liquid to the solid state, suffer expansion when in the plastic condition. It is this feature in the transition that enables metals to take and retain the impressions of the molds with such fidelity. Allowance for shrinkage is **not** regarded on patterns that are **six inches or less** in area, as the rapping of the pattern will usually make up for any shrinkage that may take place. Patterns that are **four inches or less** in size, are made slightly smaller than the desired size of the casting. This is called an allowance for shake. It is not regarded unless it is necessary that the casting be exact in size. Patterns between six and four inches may be made without regarding either shrink or shake.

In building machinery it is often necessary to fit two castings together. Wherever this is done, the two surfaces that come into direct contact are usually machined in some way in order to obtain a smooth, clean surface of metal. A part of a pattern that represents a surface of this kind on the casting, must be made larger. This is

the case, whether the two surfaces are to slide or rotate on each other, or whether one is simply bolted to the other. It is called an allowance for **machining** or **finish**. The amount of this allowance is generally  $\frac{1}{8}$  inch, measured perpendicular to the surface to be machined or finished. If the surface is simply to be machined to fit another surface, and the work is comparatively small, this will be enough. But if it is required to have a very nice finish, free from all sand holes, or if the work is large, it might not be enough; in some cases it might be necessary to make it twice the amount, or  $\frac{1}{4}$  inch on each surface. Moreover, as the casting increases in size, its irregularities also increase, so that a larger amount must be allowed. In the case of large work, such as engine beds, the allowance is frequently made from  $\frac{3}{4}$  to 1 inch. A large allowance is especially necessary on very irregular and new work, as the amount of distortion caused by the strains set up in the casting by shrinkage is very uncertain. Large steel castings are usually very rough, and also become more or less distorted in cooling and annealing, so that it is necessary to allow more on this account. Of course, the exact amount must be determined by the circumstances of any given casting, but there should be enough so that in taking the first cut, the tool used may get beneath the sandy scale that is always present on a casting, and still leave enough for a second cut at least, and a third or finishing cut if necessary. It, therefore, cannot be much less than one-eighth of an inch.

There is one other allowance to be mentioned that is not usually called for in making machinery patterns, but is frequently in making what are called architectural patterns. Some castings, because of their varying thickness, or because of one surface being more exposed than

another, therefore cool more rapidly, warp or become distorted in the mold when cooling. To overcome this, patterns for castings of shapes that are known thus to warp, are made of such a shape that in cooling they will assume the desired shape. This change in shape of patterns is called an allowance for "warp."

## CHAPTER IV.

### MATERIALS

Wood is the material used for a large majority of patterns. At first thought it would seem that wood is a particularly unsuitable material to be used in matrices of damp sand, and to be subject to such rough usage as the ramming and rapping of a pattern necessarily involves, but there are several reasons why wood is used. The first that may be mentioned is that it is easily worked and altered. Secondly, it is light and portable. Furthermore, by exercising due care in construction, its disadvantages may in a degree be overcome. The pattern-maker, of course, meets with the same difficulties with which other wood-workers have to contend, and as interfere with the durability of patterns. The chief one among these is due to the tendency of wood to shrink and swell, which cause warping and change in form and size. This cannot be wholly overcome, but by arranging the different pieces in a given pattern with a due regard for this natural tendency, it may to a degree be counteracted. To prevent warping it is necessary to know the effect this tendency has upon the individual board; and this may be determined, if the position of the board in the log is known, which may be determined by examining the end. If a board is cut from the middle of, and directly through the diameter of the log, it is not very

likely to warp; but if a board is cut from a position midway between the heart and the outside of the log, it is sure to do so, for it will assume a curved outline between the edges, the heart side always becoming convex. This is caused by the more rapid drying of the board on the sap side. For as the board is cut through the concentric cylindrical layers of which the log is composed, the outer side of the board contains more exposed fibre ends and more open pores than the heart side. Consequently, the sap side of a board gives off the moisture it contains more rapidly, and it will also absorb moisture more rapidly. In view of this fact, the sap side of any board should be placed where it will be the least likely to be exposed to any change in atmospheric conditions. That is, whenever it is possible, this side of the board should be always placed on the inside of any pattern work.

What is known as **quarter-sawn** lumber is the best for pattern-work and all wood-work, because it is not so likely to warp as is the regular, or bastard-sawn. Quarter-sawn lumber is lumber that is sawn approximately parallel with the medullary ray. The trunk of a tree is made up of concentric cylindrical layers, bound together with radial fibres, which are known as medullary rays. It is the exposure of these rays that gives to quartered oak the beauty that is so much prized. However, quartering is a very wasteful way of sawing lumber, and involves an extra cost. But for pattern work that must be made thin, it pays to use quarter-sawn lumber, even if it does cost more.

Another very important factor in connection with lumber for patterns is, that it should be thoroughly seasoned before being used, if possible, by what is known as the **natural** or **air seasoning** process. The seasoning

4



should continue for at least **two years**, in order that the natural gums of the wood may be fixed; that the rapid drying of the kiln will not drive them out and in that way make the wood more porous. Lumber intended for pattern work, if allowed to remain in a shed with a waterproof roof for two years, will give better results than lumber exposed to all sorts of weather for six months, and then placed in a dry kiln to finish the process. For one-inch lumber two years is enough; thicker planks will, of course, need more time, say four years for two-inch. However, lumber cannot be so thoroughly seasoned as to give entire permanence of form and durability to patterns made from it.

Besides being thoroughly seasoned, lumber for patterns should be **straight, and even in grain**, not too hard to be easily worked, yet not so soft as to be unduly injured by the rough usage patterns must necessarily undergo in the foundry. There is no wood that fulfills these conditions better than what is known as White Pine (*Pinus Strobus*), sometimes called "cork pine" because of the cork-like appearance of the bark. This wood, when thoroughly seasoned, will retain its shape very admirably under the excessive atmospheric changes that patterns have to undergo from pattern-shop to foundry, and from foundry to the storage loft. When first cost need not be considered, and it should not be in the case of small standard patterns, Mahogany, what is known in the market as Honduras M., is the best wood for all patterns; it is very even and straight in the grain, not so hard but that it can be easily worked, and retains its form and size to a remarkable degree. One thing to be mentioned in this connection is the arranging or

combining the several pieces of which a pattern is made in such a way that any shrinking or swelling of the wood shall not change the shape or size of the pattern. This is an important matter in some classes of work, and should have the careful consideration of the pattern-maker, especially in the case of standard patterns. If this is done it will add considerably to the durability of a pattern.

There is one principle it is well to observe in combining the several pieces of wood in a pattern, and that is to have as near as possible the grain of the wood run in the same general direction, so that as it shrinks or swells it will do so in the same direction, and therefore will not distort the pattern.

Special patterns are often made of **brass, iron, white metal** or **aluminium**. These metals would be used in light or curved work, and also when a large number of castings of the same size and shape are wanted. With few exceptions, however, original patterns are made of wood. Statuary and other ornamental work is usually modeled in wax or clay, which serves as the pattern. When it is proposed to use a metal pattern for the production of castings, the original pattern is made of wood and is called a **master** pattern or **double-shrinkage** pattern. This is made with a **double-shrinkage** allowance, so that a casting made from it will still be large enough for the pattern from which to make the castings wanted. Patterns made of wood must be varnished or they will soon go to pieces.

#### SANDPAPER

In pattern work sandpaper should be used with discretion. The pattern should be formed as nearly to shape and size and finished as accurately as possible with the

cutting tools before sandpaper is used. Under no circumstances should sandpaper be used for cutting down or removing any considerable amount of stock, or for doing anything that can be done with tools. Otherwise the draft and the accuracy may be impaired. Sandpaper, as its name implies, is made of sharp sand (Quartz or Garnet) glued on paper. It is graded according to the grains of sand, and numbered accordingly. The grades most useful to the pattern-maker are Nos. 0-2. No. 1½ is best for use directly on the wood, and No. 1 for the varnished surface. Ordinarily, sandpaper should be rubbed across the grain of the wood. In the last two or three years, what are called pattern-grinding or sanding machines have been introduced to the trade to take the place, in some kinds of work, of sandpapering by hand, and they accomplish the work much better and more rapidly. Any kind of abrasive that can be fastened to the machine may be used.

#### GLUE

In pattern-making as in most of the wood-working trades, glue is depended on for adhesive fastening. For fastening leather fillets, shellac varnish is sometimes used. Since much depends on the character of the glue used, it should be of the best. There are many kinds and qualities of glue on the market, including liquid, pulverized or ground, and sheet. The liquid glue is always ready for use and is very good for small work. The sheet or flake form, ground, dissolved and applied hot is the best for general use. Animal glue comes in thin sheets; it is the best, and likewise the most expensive. Of late years the large manufacturers of glue have taken up the practice of grinding these sheets, which

makes it much handier for use. However, this enables dishonest dealers to grind the cheaper kinds of glue and pass them off as the best, for when ground it requires an expert to tell the difference, but when it is cooked, the odor given off will generally indicate its quality. As a rule, the best quality of glue is of an amber color, and the sheets rather thin. Whichever kind (excepting of course the liquid) is used, it should be soaked in cold water for a short time before cooking; only a small quantity should be prepared unless the shop is provided with a steam glue heater that is kept hot. Glue is much stronger if used while fresh, as frequent heating and cooling destroys its strength. To obtain the best and strongest joint, the wood should be slightly warmed too, say from 90 to 120 degrees, and the glue applied as hot as possible, and the work quickly clamped. As a rule, the harder the glue the better it will resist moisture. When it is necessary to glue two pieces of wood together so that the joint is on the end grain, the end should first be given a coat of thin glue, which should be allowed to dry before applying the glue for the joint. This is called **sizing** the joint. Plenty of time should be given the joint to dry—ten to twelve hours, according to the size of the work, will usually be enough if in a warm and dry shop or room. Too much care cannot be exercised in the use of glue for pattern work, indeed it is not advisable to use it at all when nails or screws will answer the purpose. But there are some kinds of patterns that cannot be made without it.

#### VARNISH

All wooden patterns should be covered with some kind of protective coating so as to prevent as much as possible the absorption of moisture from the damp sand

of the mold, for this is very injurious to all wood work. The protective coating should be of such a nature as to be unaffected by **moisture** and also to **insure a hard, smooth surface** that will "draw" easily from the mold.

In practice there are two general classes of varnishes, Shellac and Copal. The first, which is the kind most generally employed, is composed of common Gum Shellac cut with alcohol and colored, if so wanted, with some kind of coloring ingredient. The second comprises the better grades of Copal varnishes used by finishers. This may also be colored. By changing the color of the varnish employed, it is possible to distinguish between core prints and the body of the pattern, and also between patterns for castings of different metals, such as brass, iron and steel.

For shellac varnish a good grade of gum should be used as the cheaper grades will not stand up to the work. This is usually called **yellow** varnish. **Black** varnish is made by adding lampblack; a good quality of lampblack should be used, one that is free from grit. **Red** varnish is made by adding some red powder, usually Indian red, or Vermillion (Chinese is best) to the yellow varnish. The use of these in varnish seems to give it a better body and greater durability. Copal varnish, however, is still more durable, and if time (about three days) can be given it to dry, it is much the better and will outlast several coats of shellac varnish.

#### BEESWAX

Beeswax is used for making small fillets, and filling small holes, such as nail holes, etc., and any other slight defect in either material or workmanship. It may also be employed for making a slight change in the form of

a pattern that is not much used. It is not good practice, however, to use it in this way on standard patterns, as it is very liable to melt and run out in the storage loft during warm weather.

Wax is sometimes used for coating iron patterns to prevent them from rusting. To cover iron patterns with wax, they should first be made as warm as they can be handled, then the wax should be spread on them as evenly as possible and brushed over with a soft brush.

#### NAILS

For pattern work, what are known as "wire brads" are the best nails. They can be driven almost anywhere in the wood without splitting it. They may be had of all lengths from one-half inch to three inches and of different sizes of wire. However, owing to the necessity of rapping patterns when drawing them from the mold, it is always best to use screws when fastening the different parts of a pattern together. They are much better than nails on account of the clamping effect they give to the pieces to be joined. This is a very desirable effect in the case of standard patterns. Another reason why screws are much better than nails for this purpose is that when it is necessary to change or repair a pattern, screws can be taken out without tearing the wood of the pattern, and if needed, can be replaced exactly in the same place. Screws are also handy for temporarily securing loose parts of a pattern, and for this use are much superior to nails or pins. When screws are to be used for fastening two pieces of wood together, holes as near the size of shank of screw as possible should be bored through the upper piece. If this is not done the screw will cut a thread in both pieces thus hindering the clamping effect

that is otherwise obtained by the use of screws for this purpose.

As is well known to most wood-workers, end grain wood, especially soft wood, does not hold a screw very securely, unless some special method is used. One of the best ways of putting screws into end grain is to bore a hole of a size as near as can be to the size of the solid part of the screw. The thread of the screw will then cut its way into the wood without disturbing the fiber and thus the full shearing strength of the wood will serve to hold the strain put upon the screw. The hold of a screw in end wood may be increased by taking it out, placing a small amount of glue in the hole, and putting the screw back in at once while the glue is soft. It is

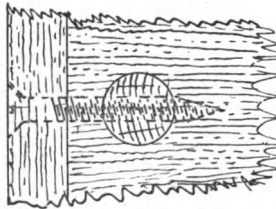
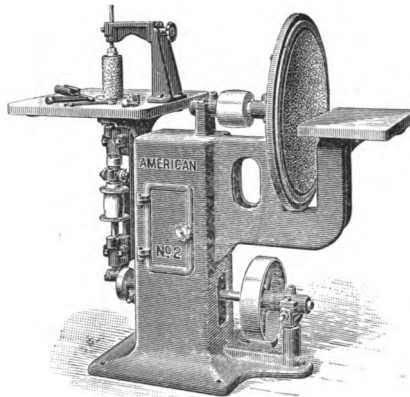

FIG. 5.

sometimes necessary to take out and reinsert screws in end wood, repeatedly,—for instance, when pattern work has to be taken apart for convenience in molding. In such cases, simply screwing them into the end wood should not be depended upon, as they get loose and do not hold. A good way to overcome this difficulty is illustrated by Fig. 5. It is to bore a hole at right angles to the direction of the screw in such a position that the screw shall pass through it; fill this hole with a hardwood

plug, bore a hole of suitable size for the screw and insert the screw. If now the screw from frequent taking out and screwing in becomes loose, the plug may be taken out and another put in its place. As noted elsewhere, screws make a much stronger fastening than nails and should always be employed in pattern work that is to be much used, as in the case of a standard pattern.



*Clement Universal Sander*



## CHAPTER V.

### FILLETS

Sharp corners on a casting, whether inside or outside, generally detract greatly from its appearance, and also, in the case of internal angles especially, injure its strength. This being the case, sharp corners must be avoided in the pattern, as the casting will be of the same shape as the pattern. The weakness due to sharp corners, especially in the case of internal angles, is caused by the way iron acts in cooling, or in passing from the

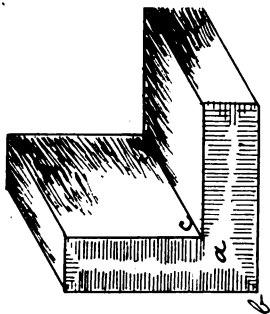

FIG. 6.

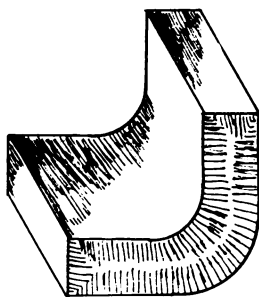

FIG. 7.

molten to the solid state. There are always more or less strains set up in a casting by the shrinkage or contraction that takes place at that time. As the iron hardens the crystals seem to arrange themselves in such a manner that their lines of strength are perpendicular to the

faces of the casting. For instance, in a casting of the general shape shown by Fig. 6, these lines arrange themselves as shown by the short lines drawn perpendicular to each face and thus leave the space (a) open or honey-combed, consequently the casting will be very weak through the line (bc), and when a strain is put upon it, it will be likely to break. In some shapes of castings these strains caused by shrinkage will of themselves crack the casting at this point and at all similar sharp internal angles. If the above casting is made with a **fillet** or rounded-in angle, this is not so likely to be the case, and if it is made as represented by Fig. 5 it will be just as strong at that point as at any other. For, as will be noticed, there is no place for this irregular crystallization to take place. In view of these well-known facts, **all internal angles** should be thus rounded in or "filleted" on the pattern.

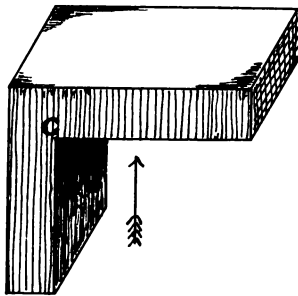

FIG. 7 (a)

There is another advantage gained in thus rounding in these internal angles that is appreciated by the molder. In molding a pattern of the general shape of Fig. 7(a), that for some reason has to be pulled or drawn from the mold in the direction of the arrow, a very sharp corner of sand

will be left at the point (c). As the pattern is pulled up by it, a slight movement of the pattern sidewise would break it; then as soon as the pattern became clear of the mold, the sand would fall down into it, thus making what the molder would call a dirty mold. It would cause him some trouble to remove this sand from the mold, and it must be all cleaned out, for otherwise it would surely make a poor spot on the casting and might render it unfit for the use to which it was intended to be put. Therefore, for the molder's benefit as well as to strengthen the casting, it is best to round in any internal angles. Fillets may be made of wood, wax or leather. The last is undoubtedly the best; it also is the most expensive, at least in its first cost. Wood is generally used for straight work, the best practice being to fit and glue a piece of wood of the right size into the angle and allow it to dry before cutting the required curve. By working the curve after it is glued in place, the tendency of thin edges of wood to curl when made wet, which of course is done in the glueing, is entirely overcome. There is no objection to using wood for this purpose if the wood that is used is straight in grain, and if the grain of the wood of which the fillet is made lies in the same direction as the grain of the wood composing the part of the pattern to which it is glued. Leather is the best material of which to make fillets, since it is elastic enough to come and go with the wood as it shrinks and swells. It is as permanent as the pattern itself, gives a very smooth finish, and is easily applied. Wax is not very good except for very small fillets or for temporary patterns. It should not be used for fillets on standard pattern work as it is likely to melt and run out when exposed to summer heat in the storage loft.

In making and applying fillets of wood, the process is something like this: First, a piece of wood of the proper length is ripped out square, so that each side is equal to the radius of the curve of the proposed fillet. One corner is fitted to the angle proposed to be filleted; it is better if this does not exactly fit clear into the angle, that is, the fillet piece may be a little loose at the apex of the angle but should fit tightly on the other two sides of the triangle. When this is properly fitted the remaining or outside angle may be planed off with the jack plane so as to make a triangular-shaped piece. The third side, the one last made, is a good place in which to drive brads for holding the piece in place while the glue is drying. The brads should be placed about four inches apart. When a sufficient number of brads have been started, the glue may be applied to the piece, the piece set into the angle and the brads driven in as far as

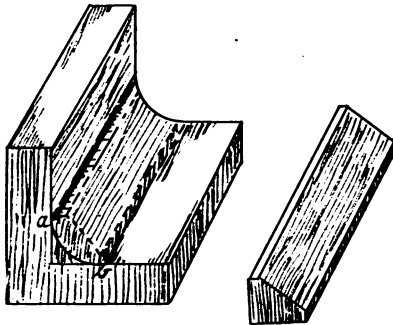

FIG. 6 (a)

can be, while still leaving the heads protruding, so that they may be pulled out when the glue is dry. When the glue is thoroughly dry the nails may be pulled out, and

the required curve cut or worked with gouge and sand-paper, making it as nearly tangent as possible to the two sides it connects. This work is illustrated by Fig. 6 (a). In order to apply leather fillets successfully, a tool known as a "filleting tool" is needed. It consists of a sphere of iron, or, still better, of brass, fastened to a short rod somewhat smaller than the sphere. The diameter of the sphere should be equal to that of the fillet. After the leather fillet is cut to the required length, moderately thick, clean glue, not too hot, is applied; the leather is placed in the angle, and the filleting tool is run along the angle, pressing the leather firmly into place. The pressing should be done heavily enough to squeeze out all surplus glue, which should be cleaned off at **once** with a piece of cloth or waste dampened with hot water; then the surface thus made wet should be wiped as dry as possible with a dry piece of the same material. The filleting tool should be quite warm for this operation.

Wax fillets are put in in the following manner: Some wax is softened by heat and rolled into a small cylinder, the diameter of which is governed by the size of the fillet. It is then laid in the angle. The filleting tool before mentioned is warmed enough to soften the wax, and the cylinder is pressed into the angle. The wax, being softened, conforms to the shape of the tool, which, as it is passed along, leaves a circular surface tangent to the two sides of the angle. The surplus wax should be cleaned off up to the line made by the tool. This makes a very nice job, and is a good way of making fillets for patterns that are not to be much used. There are on the market small presses that turn out cylinders of wax for making wax fillets. They are so arrange

that different sizes of cylinders are made for different sizes of fillets. These small cylinders of wax are also used for venting cores and molds. These machines save considerable time and trouble in this kind of work, and also do it more satisfactorily.

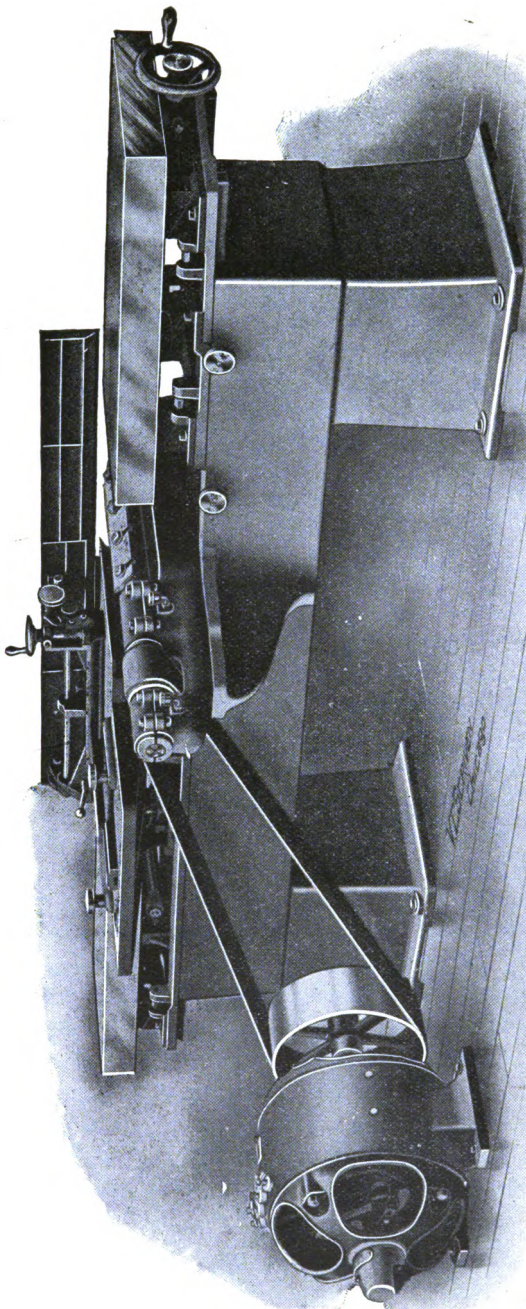

*“Oliver’s” Handjointer*

## CHAPTER VI.

### CORES.

When castings with holes through them, or with internal cavities, are to be made, a projecting body of sand must either be made in the mold at the same time as the rest of the mold, or else be introduced into the mold after the pattern is removed or pulled out. These projecting bodies of sand are called **cores**. When the pattern can be withdrawn from the mold

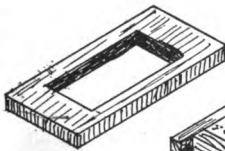

FIG. 8.

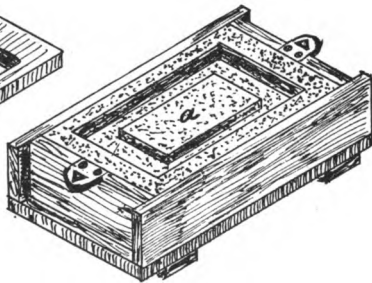

FIG. 9.

and leave a core, or cores, as a part of the mold, it is said to **leave its own core or cores**. This is illustrated by Figs. 8 and 9. Fig. 8 represents a pattern that has been molded and removed from the mold; (Fig. 9) leaving core (a) projecting above the lower surface of the mold. When the cope is closed the cope sand will, of course,



touch the upper surface of these cores; when the mold is filled with melted metal, it cannot get where these cores are. The result is that the casting will have a hole through it the shape of the core (a). Where patterns cannot be so made and molded with the ordinary appliances of the foundry to form their own cores, there is added to the pattern an **attachment** or projection that forms a mold in the sand, into which a separate core may be placed. These attachments are called **core prints**.

These cores that are made separate from the mold are usually what are called **dry sand** cores, although **green sand** cores are sometimes made in the same way. A simple form of pattern for a mold with a dry sand core, is represented by Fig. 1, parts A and B being core prints.

A dry sand core is made in a separate device called a **core box**. In the case of a symmetrical core, a core box is made only for a small portion of it. For a cylindrical core only a half box need be made; two cores from such a box be pasted together, thus forming a complete core. This same principle may be used in the case of very large work. A symmetrical mold, like one for a fly wheel, may be built up almost entirely with cores.

Core boxes require as great care in their manufacture as patterns, and as much thought must be given to their shape, durability and finish. The shape of a pattern is nearly like the required casting; but the inside of the core box, which is, of course, the necessary part, is just the reverse, resembling more nearly the shape of the mold. When cores are made in boxes and inserted in the mold, it is necessary that they be supported in such a way that there will be no chance for a change of position

during the time the mold is being filled with the molten metal. To give this support, special recesses are made in the mold to receive them. These recesses are made by the core prints previously mentioned. The core should exactly fill the recesses left by the core prints, and this part of the core should be large enough to support the core properly in place, so that the sand of the mold will not be crushed out of shape by the weight of the core, nor by the action of the metal while being poured into the mold.

Core prints should be given more taper than the pattern itself, so that the work of withdrawing the pattern from the mold may not be unduly increased by their presence, and also so that the core may be the more easily adjusted to its proper position. In the case of plain cylindrical cores, whose length does not exceed

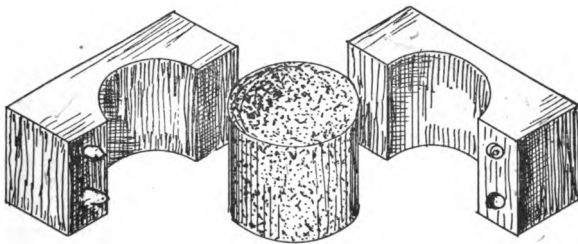

FIG. 10.

five times their diameter, or of such as may be stood on end while drying, a full box may be constructed and the cores made whole. This, of course, saves the time of the core-maker, as he does not have to cement the two halves together. A core made in this way, with its box, or mold, is represented by Fig. 10. In making these core boxes and core prints, care should be taken that the

part of the box corresponding to the print on the pattern should be exactly the same size and shape as that print, so that when the core is set into the mold it shall exactly fit.

All core prints should be of ample size, so that their impression will hold the cores in their place, and so that the weight of the core and the weight and action of the melted metal will not change the position of them. It is well to remember that the material that must do this holding is only loam, or, as it is technically called, "sand." It therefore requires a comparatively large surface to make them secure against the weight and action of melted metal during the process of pouring it into the mold. On account of the varying shapes and conditions there can be no exact rule given for the sizes of these prints, that will cover all cases. The **length** of the core prints for a plain cylindrical **horizontal** core should approximate its diameter, and its shape should be that of a cylinder. For a **vertical** core of this same general shape, the print should be the **frustrum of a cone**, with the large end next the pattern; the height should be **one inch**, and the diameter of the small end **one-half inch less** than the large end.

In core work that requires prints of other shapes than those mentioned above, that is, where the opening into or through the casting is not round, then the prints should correspond in shape.

The making of core prints properly located and of correct size and shape is a very important part of the pattern-maker's art, especially so from the molder's standpoint. Prints that do not show the exact position of the core may be very misleading and may result in the loss of the casting. One form of core where this mistake might easily be made and not be noticed until the cast-

ing was formed is illustrated by Fig. 11. The figure represents a casting that requires a cylindrical horizontal core with a part enlarged to make the cavity (A) which, it will be noticed, is not in the center of the length of the casting. In this case if both core prints are made of the same size, the molder will be quite likely to set the core wrong end to. The molder would not be altogether to blame for this mistake as he generally does not have anything to guide him in this work except the pattern and core box furnished by the pattern-maker.

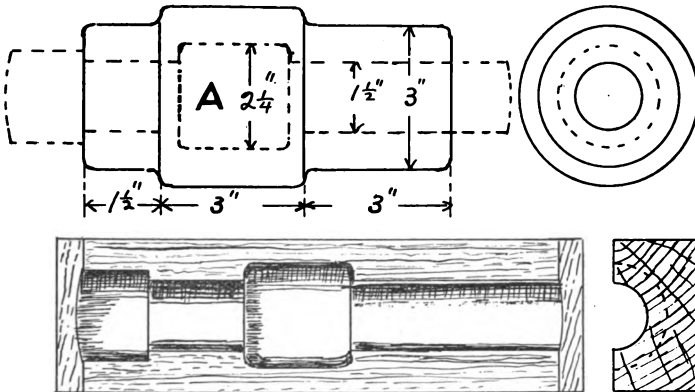

FIG. 11.

But if one core-print is made larger than the other, then it will be impossible for him to set it incorrectly without deliberately cutting the mold. In all core work, therefore, the prints should be of such size and shape that it will be impossible to set the core into the mold in any other than the correct way. As mentioned above, one method is, as shown in Fig. 11, to make one print larger than the other or of a different shape. For cylindrical

cores, the first is of course the best, and is sure to accomplish the desired result. Sometimes it is required that a cylindrical core should lie in the mold in a certain position with regard to its circumference. In that case it would be necessary to change the shape of at least one of the prints, making one or both square so that the core cannot be set wrong or revolve after being set.

Some prints for horizontal cores are not made long enough, consequently the metal when poured into the mold will, by its own static pressure, raise or displace the core and make the casting thinner on the cope side because of this movement.

It is advisable to make the prints of cylindrical horizontal cores about equal in length to the diameter of the core. This may seem excessive and in some cases it may be, but it had better be too long than too short. When it becomes necessary to make them shorter than this on account of the size of the flask to be used, or of the core oven, and the casting is quite heavy, it is good practice to imbed a plate of iron in the mold for the core to rest on, thus the weight of the core will be distributed over a larger area of sand than the core-print alone would afford.

A great many castings are lost because the lower print of vertical cores are made nearly **parallel** or with the ordinary pattern draft. The probable cause of this is that the core does not go down to the bottom of the mold since the sand is cut down by the core on setting. So when the cope is closed, being too long, it breaks the mold around the print of the core, allowing metal to flow into the vent and thereby causing the casting to "blow." This may be overcome to a large degree by tapering the lower print as is usually done in the case of the upper

one. If this is attended to there can be no trouble in setting the core. Indeed, in the case of small cores, the molder can set them enough faster to pay for the extra work of pasting such cores together. As this is the main objection to this shape of print, viz., the necessity of making the cores in halves, it will be more than overbalanced by the advantage of the greater facility and rapidity with which the cores can be set, to say nothing about the larger output of **sound** castings.

The subject of taper core-prints for vertical cores is one of considerable importance, especially from the molder's standpoint. It is well to adopt some standard taper, so that if a core-print is lost, another may be made of the correct size whether the core box is in sight or not. Probably the best taper for the purpose is one of one-fourth inch to one inch in height. This is an easily remembered taper and will give entire satisfaction to the molder. This taper can be employed for all vertical prints large or small, (the smaller sizes being reduced in length) one inch is long enough for any size of cylindrical **vertical** core. A good rule to follow for cores less than one inch in diameter is to make the length of the print equal to the diameter, while preserving the same taper. It might be objected that one inch is too short for large cores, say of 12 inches or more in diameter.

But there is not much strain on the print, that is on the print in the sand of the mold which holds the core in place,—for it simply locates the core. Nearly all the strain, if, to be sure, there is any, comes on the end of the core. Therefore, any extra length given the print would be of no advantage, and one inch is as good as a greater length. One reason why there is but a slight strain on the sides of these prints is that the metal on

being poured into the mold completely surrounds the core so that the pressure is practically equal in all directions. This, however, is not the case with the horizontal cylindrical core. As has been already mentioned a taper of one-fourth inch on each side is the best. This is illustrated in Fig. 12, where it is reduced to a system. In this system, for cores that are less than one inch in diameter, the dimensions of the print are derived from

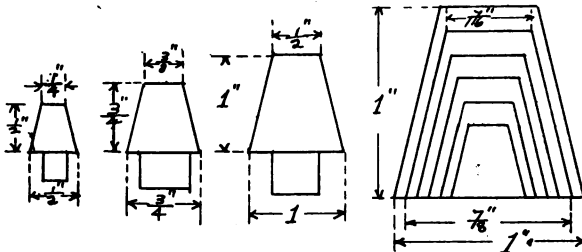
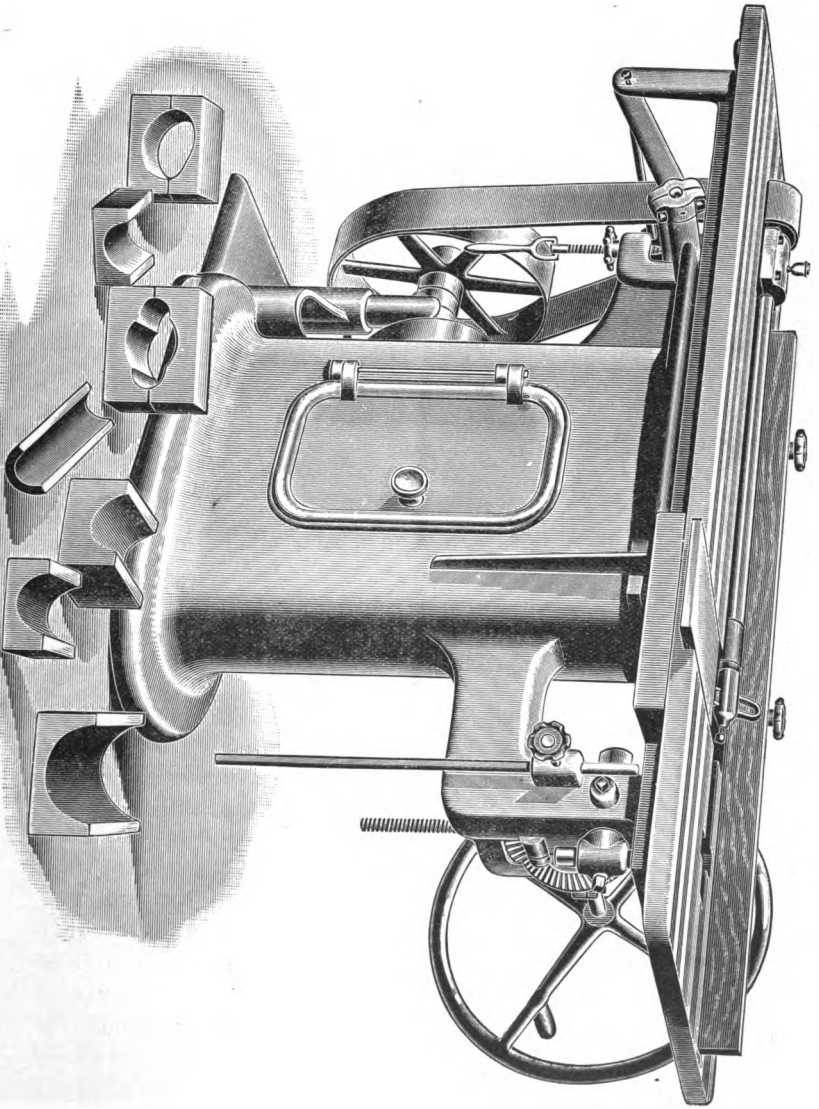

FIG. 12

the diameter of the core; for instance, if it is required to provide for a core that is seven-eighths inch in diameter, the length of the prints will be seven-eighths inch, or the diameter of the core, the large diameter also, seven-eighths inch, the small diameter seven-sixteenths inch or one-half the large. Therefore, in using this system, all that we need to know is the diameter of the core, and this will give the other dimensions. Now if a print is lost, as often happens, another can be made without seeing the core box, if this system is carried out for all cores of this kind.

*The "Crane" Core Box Machine*





## CHAPTER VII.

### MOLDERS' JOINTS OR PARTINGS.

The jointing of patterns is fundamental, and must be considered from two points of view; that of the molder, and that of the wood-worker. The first is concerned more particularly with the removal of the pattern from the mold, or, as the molder expresses it, **pulling the pattern**. The second is constructional, and into it enters the combination and arrangement of the different pieces of wood composing the pattern. The joints that are arranged for the purpose of removing the pattern from the mold are usually called **partings**, or **pattern-makers' partings**, and strictly speaking, are not joints. The joints made in the construction of the pattern are true joints, and should be made as nearly perfect as possible, since the strength and durability of the pattern depends largely on their efficiency as joints.

The first mentioned of these joints, the **molder's partings**, will be considered in this chapter. Whether a pattern is made correctly or not, from the molder's standpoint, will depend largely on the understanding that the pattern-maker has of these partings, and of their position in the mold itself. In order to explain these points a few examples will be mentioned. It requires at least one of these molder's partings for every pattern, as the mold must consist of two bodies of sand,

so that the pattern may be taken out. The simplest form of pattern is a square block like that represented by Fig. 13. The parting will be made on the line A B,

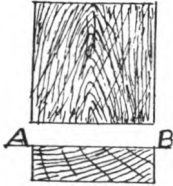

FIG. 13.

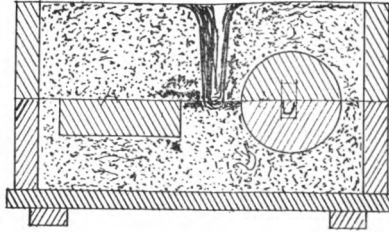

FIG. 13 (a).

the part of the mold below that line being in the nowel; in this case **all** the mold will be in the nowel, the cope forming the top surface only. The next in point of simplicity is known as a **simple parted** pattern, and is represented by Fig. 1, on page 6. In a mold made off this pattern, one-half would be in the nowel, and one-half in the cope, as represented by Fig. 13 (a). The line A B is the parting line of the mold and also of the

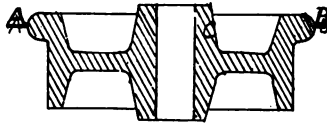

FIG. 14.

pattern. In this form of pattern, it will be noticed, the molder's parting and the pattern-maker's parting exactly coincide. When a pattern is so made that the partings can be arranged in this way, the molding may be very easily and quickly done. The process of molding such a pattern is described in Chapter II. Fig. 14 may be

considered typical of a large class of pattern work. It is a pattern for a small car wheel having a central web. The molder's parting will be made on line A B. No parting is required in the pattern except that the boss, or hub, C, is usually left loose, so it will lift with the cope.

Fig. 15 represents a pattern of a double flange wheel, and is a good example of a class of patterns where the molder's and pattern-maker's joints do not coincide.

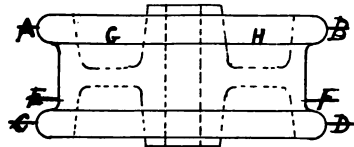

FIG. 15.

This would need what is called a **three-part flask**, meaning that the mold is composed of **three distinct bodies of sand**, which, of course, involves the making of two molder's partings. One of these will come in the centre of each flange or lines A B and C D. The pattern will be parted at E F. The sand, or cores, that will form the part of the mold at G and H will be lifted with the cope

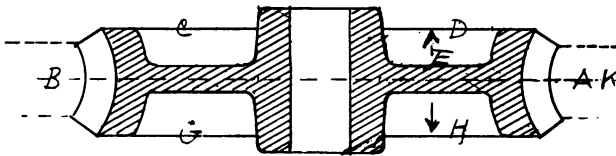

FIG. 16.

down to the upper line of the web. The mold for a worm wheel is another good example of molding where the parting of the pattern does not coincide with that of the mold Fig 16 will make this quite clear. The pattern

will be parted along the line A B; the molder's partings, of which there must be two, will come on the lines C D and G H. All of the teeth will come in the middle part, or cheek, included in the space K. The two halves will, of course, be drawn from the mold in opposite directions, the inner curves of the rim, and the taper of the hub, affording plenty of draft. There is another form of molder's parting known as an "irregular parting," that must frequently be used on account of the shape of the pattern. The pattern represented by Fig. 17 is an example of this form of parting. In the molding of this pattern the molder's parting will be made along the

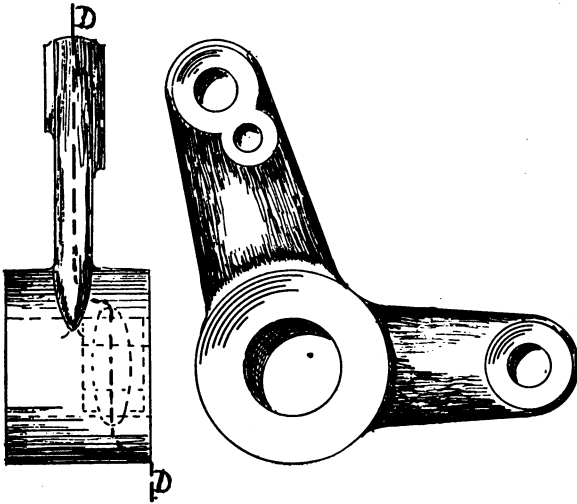

FIG. 17.

dotted line DD, so that the most of the mold will be in the nowel, which is very desirable, as it leaves less to be lifted by the cope. As indicated by the tapered prints

shown at A and B in Fig. 50, a core will be used for forming a round hole through the casting. Another, but a more simple joint of this kind is shown by Fig. 18, which represents a cast-iron bracket. The parting of

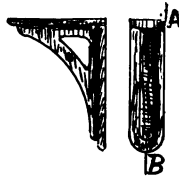

FIG. 18.

the mold will be made along the dotted line AB. If a number of comparatively small brackets of this shape is wanted, the pattern can be parted through the central web, or a follow board can be made and fitted to a one-piece pattern.

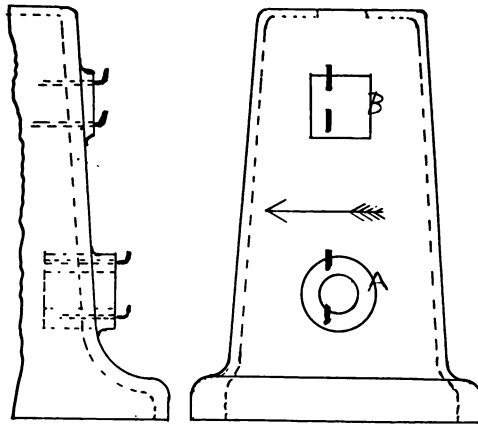

FIG. 19.

A contrivance frequently used in molding, called **skewering on loose pieces**, saves considerable time and

work in both pattern shop and foundry. An example of this is illustrated by Fig. 19, which represents a part of a cast-iron base for a wood-working machine. The whole casting is cored out; and, for convenience in molding, the pattern was boxed up to form a one-piece pattern, to be pulled from the mold in the direction indicated by the arrow. If the two bosses, A and B, were fastened on, they would tear up the sand. In order to prevent this they are **skewered on**, that is, held in place temporarily with wire skewers, as shown. As the mold is being rammed up, after sand enough has been rammed around the bosses to hold them in place, the skewers are pulled

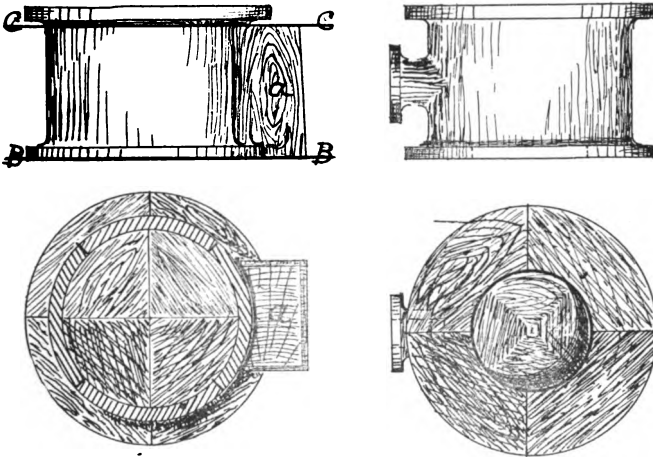

FIG. 20.

FIG. 21.

out. This, of course, allows the main pattern to be pulled out, thus leaving in the mold these loose pieces which can be pulled sidewise into the mold. Of course, this pattern could be parted through the center line, but that would entail a large amount of extra work in both

the foundry and the pattern shop. By the use of this method, therefore, the extra work of making another parting is saved. Another way sometimes adopted for forming projections on a casting is made clear by Figs. 20 and 21. They represent a hollow, cylindrical casting, with a flange on both ends, a projecting boss for a pipe on one side about midway of its height, and an opening through the top. The pattern will have to be parted on the line CC, and will require a three-part flask, with molder's parting along line BB. To form the projection on the side, one of two methods may be adopted: One, the use of a core print and core; the

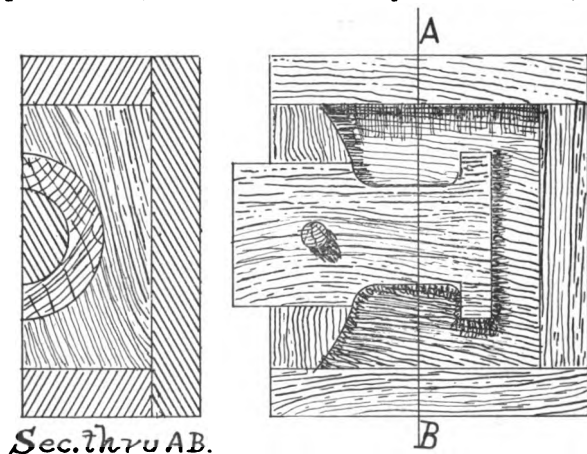

FIG. 22.

other a core only, to be set in place at the time of ramming up the mold. If the second method is used, all that the pattern-maker needs to do is to make a core box with a pattern projection located in it.

This core box is represented by Fig. 22. If the first method is adopted, a core print will have to be put on

the side of the pattern, so as to extend from the top parting down to a point just below the projection. If a hole is to be cored through the projection, this would be the best way of doing the job.

The examples given above of molder's joints do not introduce nearly all the ways and means employed by the molder for making molds. But they do give a good general idea of the most common ways, and will afford such suggestions to the beginner in pattern-making as to enable him to make patterns so that they can be "pulled" without injury to the mold. This should be the first consideration of the pattern-maker, as on it depends in a large degree the accuracy of the casting. If the mold is injured in any way by the pulling of the pattern, so that the molder has to mend it, the casting is rarely correct in shape. In the next chapter, the matter of constructional joints will be taken up, that is, the building of wood patterns from the view point of the wood-worker.



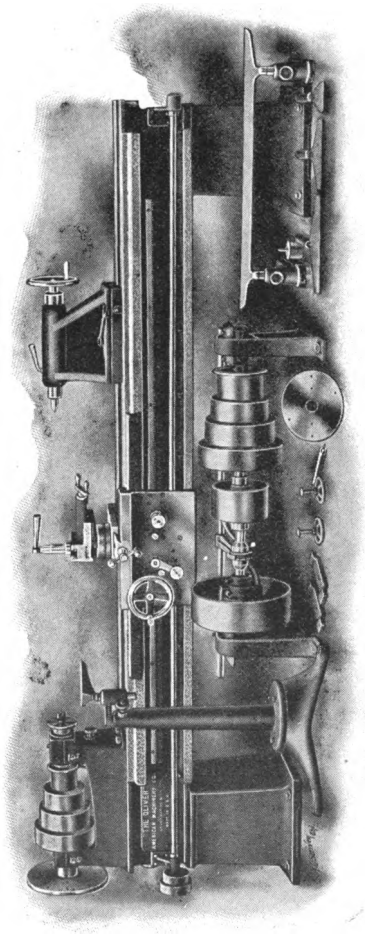

*“Oliver” Wood Lathe with Compound Rest*

## CHAPTER VIII.

### CONSTRUCTIONAL JOINTS

In a consideration of this part of the general subject of pattern-making, two things must be given prominence, viz. : the strength and durability of the pattern, and its permanence of form. This latter is very likely to be interfered with by the absorption of moisture from the damp sand, thereby causing the wood to swell, and perhaps to warp. The amount of moisture thus absorbed depends upon the time the pattern has to remain in the mold, and upon the condition of its protective coating of varnish. To overcome any change likely to take place from this cause, several methods of arranging the various pieces of which the pattern is built up, are used. The particular method to be employed in a given case depends on the size and shape of the pattern, and also depends, to a degree, on whether a large number of castings is wanted or only one. In order to secure the requisite permanence of form, it is better, other things being equal, to build a pattern of several pieces rather than to cut it out of one piece. For then the warping in the whole pattern is reduced to a minimum. In small patterns, however, this warping may be disregarded; therefore, a **small** pattern may be cut from a single piece of wood. This matter of constructional joints may be most easily comprehended by studying examples of forms likely to be required.

When thin disks are wanted it is best to build them up of three layers with the grain of the pieces running tangentially to a small circle in the center, as illustrated by Figs. 23 and 24. The grain of the wood must run

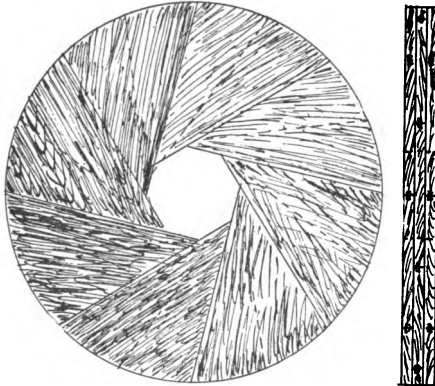

FIG. 23.

FIG. 24.

lengthwise and parallel to the longest side of each sector. After the pieces have been fitted together, a groove is cut in the edge of each, in which tongues of wood are glued and driven as illustrated by Fig. 24. When one disk has been glued up and the glue has dried, the sectors for the other disks may be glued directly to it with the joints running across the others, the angle depending on the number of sectors used to form the circle. This makes a very rigid construction and one which will not warp.

If in building a pattern a thin, wide board is required and the other parts of the pattern are of such shape that they do not afford it sufficient support to keep it from warping, a good way is to rip the board up into strips of

from two to four inches wide (according to the width of the required board) and then glue the strips together with each alternate strip reversed, as shown in Fig. 25. In this way the warping will be reduced to the minimum because the alternate pieces are inclined to warp in opposite directions.

A good way to support patterns of this general shape during the process of molding is illustrated by the lower part of Fig. 25. The additional pieces B and C are called **counter ribs**. The recesses made by them in the sand will be filled by the molder, or, as he expresses it, they are "stopped off in the mold." The shape of these counter ribs, which is more clearly shown at D, indicate to the

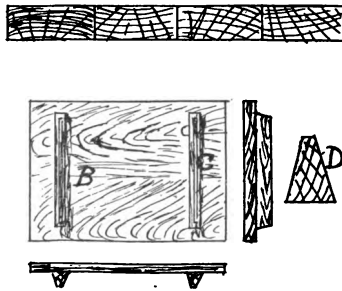

FIG. 25.

molder that they are to be stopped off in the mold. Whenever possible these should be put on the pattern so they will come in the nowel of the mold; these are also called "stop-off" pieces. Another way of building patterns that are round and flat and are supported by segments running around them, is to make the flat part of several strips rather than of a wide board. This is illustrated by Fig. 26. These strips should not be glued together, but

held in position by the segments that are built on to them. If the pattern is more than 12 inches in diameter on the inside, it is advisable to insert at least one dowel in each of the joints between these strips to keep

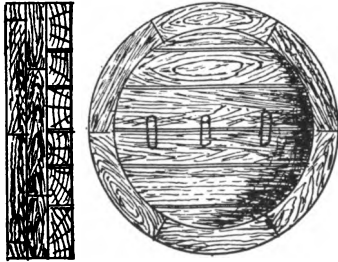

FIG. 26.

them from springing sidewise. This need be done only for three or four of the joints near the center. A "slip" tongue joint may also be used instead of dowels. Another way to overcome the effect of shrinking and swelling in large patterns is the use of what is termed **open joints**.

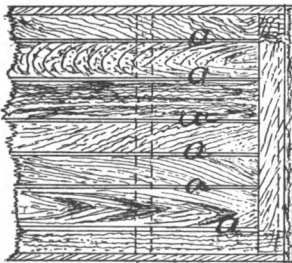

FIG. 27

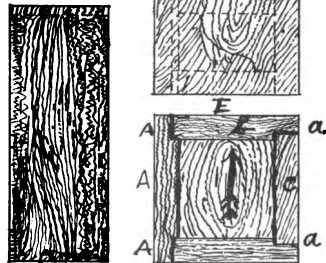

FIG. 28

If it is required to build a large pattern that is flat and comparatively thin, either circular or square, it

would be built as shown by Fig. 27; that is, the sides would not be built up by gluing narrow boards together, but they would be laid side by side with open joints between, of from one-sixteenth inch to one-eighth inch in width, and a slip tongue inserted. If the boards expand with moisture the width of the pattern as a whole does not increase; the only effect is to partly close these open spaces. If the boards shrink the only effect is that the spaces increase in width. As broad-plated work is usually stiffened with ribs and flanges, the fact that the joints are open will not lessen the rigidity of the pattern. If a case should occur where there could not be support enough in the pattern itself, then the boards could be held in place as shown in Fig. 27, by a method which is practically paneling. A frame is made as for a panel door, and the ends of the boards fitted to a groove.

This method may be used in connection with what is known as **boxing up** a pattern. This is illustrated in Fig. 28. Open joints are represented at a, a, a, Fig. 27. This method, **boxing up**, is frequently used for large patterns which if made solid would be unduly heavy and would be especially liable to become affected by moisture and dryness. The rebated joint should always be used at the corners in boxing up a pattern that is of a square or rectangular cross section. This is illustrated by Fig. 28. If the pattern was to be pulled from the mold in the direction indicated by the arrow, and was built as at (a) Fig. 28, then any change due to shrinking or swelling of the relative position of pieces b and c would leave an uneven surface on the vertical side which on being pulled from the mold would be likely to tear up the sand and thereby cause the molder some trouble. If the joints are arranged as at (A) Fig. 28 this cannot

occur. This form of joint has another advantage, for if the joint were simply a butt joint, the ramming of the sand of the cope down on the face (E) would be likely to drive the top board down below the edges of the sides, but in this case, the piece E, being rebated into A and C, cannot be driven down.

Fig. 29 represents an example of another type of hollow work, which, however, is not called boxing up, but **lagging** or **lagging up**. This method may be defined as the building of patterns with longitudinal strips that run parallel with the axis of the proposed cylinder. It is used for turned work. The figure represents a section of the pattern of a pipe or column of any diameter ver four or five inches. A A is the joint of both pat-

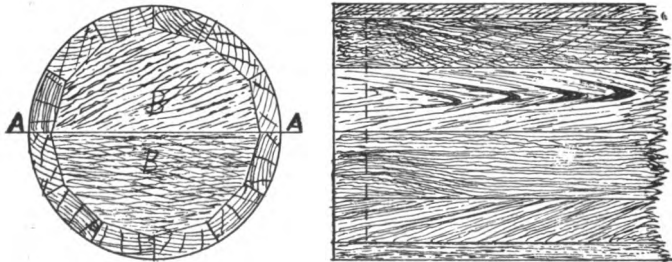

FIG. 29

tern and mold. B B are cross bars of polygonal shape on which the strips or lags are laid and fastened with glue and screws. The lags are also glued to each other except on the line A A.

Fig. 30 illustrates another way of building by lagging. In this way much narrower strips are used, thereby reducing the work of turning and also requiring less lumber. The parts for the core prints are built up first, and then the lags for the rest of the pattern are fitted an

glued and screwed to these, as is indicated by the figure. Should the body of the cylinder be long, two or more semicircular discs must be used to insure rigidity. Fig. 31 shows how this method of building up may be used for large cylindrical core boxes. If the work is done accurately, the work of finishing the inside of the box is reduced to a minimum.

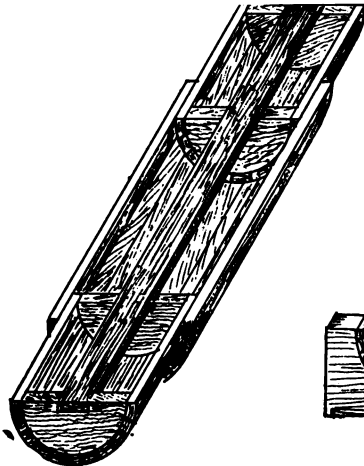

FIG. 30.

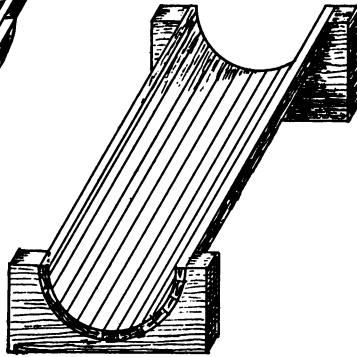

FIG. 31.

When annular patterns of six inches or more in diameter are wanted they are made by what is known as **building up with segments**. This is illustrated by Fig. 32, and when properly done makes a very strong construction. The several pieces should be cut from the board in such a way that the grain of the wood follows the circle as near as may be. Therefore, in laying out the segments the chords of the curves should be parallel to the grain of the wood. In building patterns of this type, a number of short segments are sawn out and glued in



courses, one over the other with the end joints alternating or **breaking joint**, when the glue is dry the correct outline is imparted by turning or otherwise. By this construction shrinkage in the segments is reduced to practically nothing.

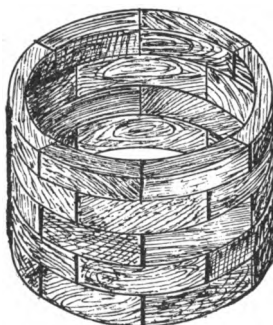

FIG. 32.

Examples of constructional joints of still another type of patterns, sometimes termed plate work, is represented by Figs. 33 and 34. Fig. 33 shows a frame cut from solid wood, 18 inches wide and 2 feet 6 inches long, by 1 inch thick. It is clear that strength and permanence of form is entirely lacking in bars (a a). Contrast the construction in Fig. 34. In this there cannot be any material alteration in width or length, in general or local dimensions, and there is the maximum of strength. The frame is made of five narrow strips. Alternative methods of making half lap points are shown. At the corners plain halving is shown. At D the dove-tailed form of halving is illustrated. The plain halving if properly made, glued and screwed, is very strong

and permanent. For standard patterns, however, it is advisable to employ the dove-tail form.

Another example of this same type, but of a very distinct form, is shown by Fig. 47. The finished casting is shown by Fig 46. It will be noticed that the joints are of the half-lap form. This figure (Fig. 47) shows the plate part of the pattern only,

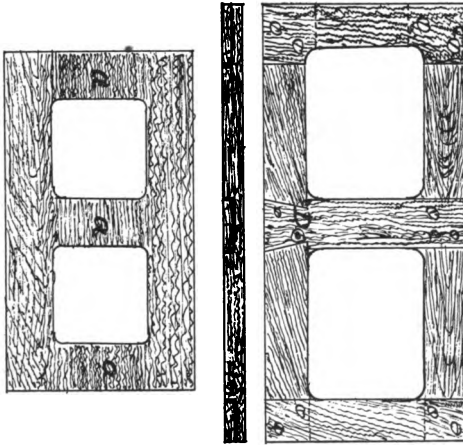

FIG. 33.

FIG. 34.

made up of three pieces. The pieces are so arranged that wherever there is a curve there is wood with the grain running practically tangent to it; consequently, if the joints are properly made and glued, it can be worked into shape without being broken out. Moreover, there is wood enough at all the angles so that the fillets may be worked in the solid wood instead of separate pieces being glued in for the fillets. For standard plate work it is always best to do this, even if it does take wider material. The added durability will more than pay for

the extra lumber, and then it also saves the time of making and gluing in the separate pieces.

Round corners may be formed, as shown by Fig. 35.

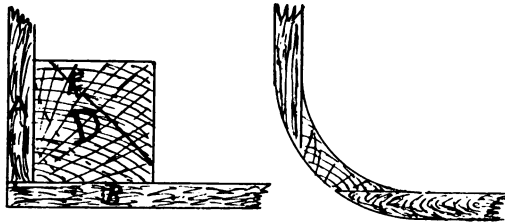
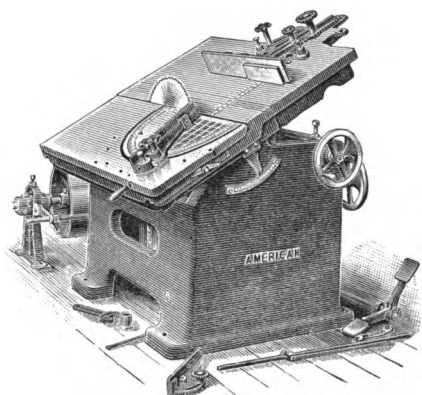

FIG. 35.

In this case the two pieces, A and B are joined in the usual way with a butt joint as at C; the piece D is glued into the angle and allowed to stand long enough to dry; then the corner is worked to the required form outside and inside. In work of this kind it is best to work the inside first, because the piece can usually be held better if the outside corner is square, than if it is rounded. The block, after being fitted to the angle, may be sawed or planed to form, as indicated by line E. This can be done more easily before, than after it is glued in place.

As pattern-making is one of the most comprehensive of trades, and the demands of the engineering profession for complicated castings are limitless, it is impossible to anticipate the next form a pattern-maker will be called on to make. This being the case, only general methods can be considered in a volume of this size, treating on the subject. The joints and methods of construction that have thus far been considered are those most frequently employed in pattern-making. Special examples of types of pattern-making will next be taken up, for which one or more methods of construction will be given in detail.



*Clement Universal Bench Saw*



*Williamsport Scroll Saw*

## CHAPTER IX.

### SPECIAL TYPES OF PATTERNS.

Before taking up the subject of making special types of patterns, certain matters that apply, not only to special types, but to all patterns, must be considered.

One of these is the preparation of the lumber.

This consists in the first place of cutting roughly to size, the several pieces required for making the proposed pattern. They are then allowed to stand for as long a time as the job will allow, so that they may warp into and assume a nearly permanent form. If this is done, when they are cut to the final shape, they will not again warp and change the original form of the pattern. This additional seasoning is necessary, because lumber will change more or less in shape, when much of it is cut away, exposing a surface that has heretofore been on the inside of the plank or board. The foregoing constitutes the first step and may be termed **cutting the stuff roughly to size**. The next step is **planing up** one or two sides to a true plane, and **marking** them as **working faces**. Usually these planes should be made at right angles to each other. This is quite important, as, generally speaking, the accuracy of the work will depend to a degree upon the accuracy of these two faces. All lumber to be used in making patterns should be planed by hand before being put into the pattern, especially if a flat surface is

desired. The ordinary rotary knife planer will not plane stuff flat, therefore the hand plane must be used. If there is a Daniels planer in the shop it may be used to plane one side of the board; the other may be passed through the ordinary planer. But even if this is done, the lumber should be planed by hand to insure a good finish, as the rotary knife will leave the surface more or less corrugated.

The simplest patterns are those which are made in one piece, and which require no coring, although the

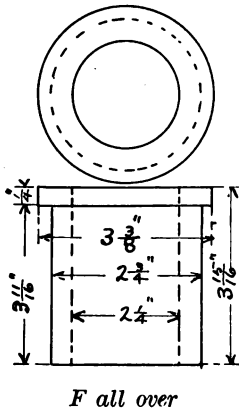

FIG. 36.

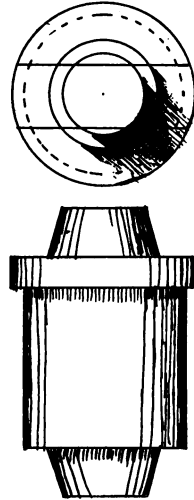

FIG. 37.

castings themselves may be hollow. In commencing a pattern, one must first decide how it is to be removed from the sand, and where the parting line, if one is needed, should be.

A simple one-piece pattern, around which to form a

mold with a dry sand core, is exemplified by the stuffing box gland shown in Fig. 36. This figure shows the finished casting, which is to be finished all over.

This is a type of a very large class of patterns which must be cast on end. It is what is generally known as a stuffing box gland. The finished casting is represented by Fig. 36, the finished pattern by Fig. 37, and the requisite core box by Fig. 38. Fig. 36 represents also the drawing that would be sent to the shops. The gland is made from this drawing.

Considering this pattern from the molder's standpoint, it is clear that if it is molded endwise, with the flange up, and if the molder's parting is made along the top of the flange, it can be readily pulled. The draft in this case should be one-eighth inch for 12 inches. Each core print should be one inch long. When the amount of draft and finish is decided on, it is a good plan to make a full size sketch of the pattern as it will appear when ready for the molder, and with all required dimensions plainly shown on it. This should be done before one begins to make the pattern. Indeed, one may well follow this in the case of every pattern, for thereby many mistakes and much loss of time will be avoided. According to the drawing Fig. 36, this gland is to be finished all over, so that in making the pattern there must be allowance for both finish or machining, and draft. As none of the dimensions are over six inches in any one direction, shrinkage may be disregarded. As this pattern is to be pulled from the mold endwise, the draft on the outside will have to be like that shown by Fig. 3, on page 14. One way to make a pattern for this casting is shown in Fig. 36 (a). If it is made in this way, it may be molded and leave its own core, but the hole can-

not be made parallel. It is usual to allow double the amount of draft on the inside for all small cores similar to this one. This would make considerable more work for the machine shop if the hole had to be finished. For this reason, if a large number was wanted, the pattern would be made as described in the following pages:

To make this pattern it will be necessary to build

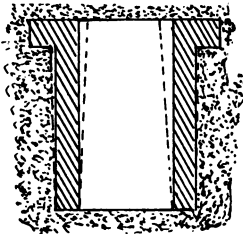

FIG. 36 (a)

up a block of wood that is at least  $3\frac{3}{4} \times 3\frac{3}{4} \times 7$  inches long. The best way to do this is to use two pieces  $1\frac{1}{2}$  inches thick, and one piece three-fourths inch thick, gluing them all together, with the thinner one in the middle. In gluing up work of this kind, it is always best to have the thicker pieces on the outside; for if the piece on the outside is too thin, it will, during successive moldings, be likely to become loosened on account of the action of the damp sand on the glue. As soon as the glue is quite dry, the corners may be cut off with an axe or a chisel and mallet. The piece is now ready to be mounted in the lathe, and should be turned to a cylinder of three and five-eighths inches in diameter, which is the outside dimensions of the flange. Now, laying a rule along the tool rest up against the cylinder, point off the measurements as indicated by the drawing, preferably



commencing at the right hand end, that is, next to the back or dead center of the lathe. By commencing at that point any surplus material will be left at the other end, so that it will not be necessary to get so close to the chuck or driving center with the tools. First, then, make a mark about one-sixteenth inch from the right hand end for the end of the print. From this point measure one inch for the length of the print; from this measure three and three-fourth inches for distance from the end of the pattern to the under side of the flange; from this point measure three-eighths inch for the thickness of the flange; from this mark measure one inch for the length of the print on this end. Check up by measuring total length between the outside marks, which should be six and one-eighth inches. Now hold the point of a pencil at each of these marks, allowing the side of the pencil to lay on the tool rest; give the belt of the lathe a pull which will turn the cylinder, making a mark all the way around it. Now cut the cylinder to the required size below the flange, remembering that the core prints will have to be tapered, because this will be a vertical core. Now, if the successive steps have been done correctly, the pattern will be like Fig. 37. The top print should be loose for the convenience of the molder. All the lathe work on this pattern should be done with scraping tools, except that the gouge should be used for roughing it to the approximate diameter.

The next thing will be the making of the core box in which to make, or form, or mold the dry sand core. This box is shown by Fig. 38. This being a symmetrical core, one half box will be enough. To make this we proceed as follows: Take a piece of straight-grained pine, of such a width that after the semicircular groove

forming the body of the box is cut out, there will be left about three-fourths inch on each side. In this case, the box being two and one-quarter inches in diameter, and one and one-half inches for the two sides, the width of the piece will be three and three-fourths inches. The

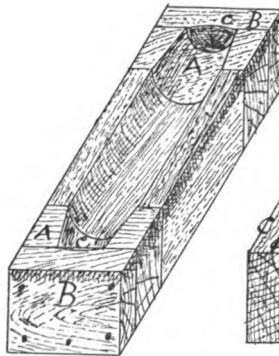

FIG. 38.

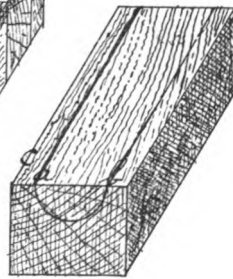

FIG. 39.

depth of the groove will, of course, be one and one-eighth inches, and there should be at least seven-eighths inch thickness of wood below this, which will make the required block  $2 \times 3\frac{5}{8}$  inches and five inches long. The block should be planed on all sides; one of the wide sides (for the top of the box,) and its adjacent narrow sides are to be straight and exactly at right angles to each other. To lay out the lines for this, fasten the block in the vise with one end down even with the top of bench, or vise. Now set the dividers to the radius of the required curve, one and one-eighth inches, and put one leg of the dividers in between the block and the vise jaw, on the side intended for the top of the box, approximately in the center of the side; then describe a semi-circle on the end of the block, as shown at Fig.

39. Now with the gauge set to the distance  $c$  to  $a$ , make a mark along the top or face side for the whole length from the point  $a$ , then extend the gauge to point  $b$ , making another line the whole length of the block. On the other end make another semicircle. This completes the laying out of the core box. The wood must now be taken out just to these lines. This may be done in two ways, the better of which is by the use of the core box plane. This is a plane whose face instead of being just one surface, is composed of two surfaces set at right angles to each other, as shown by Fig. 40. The cutting iron is narrow, and ground to

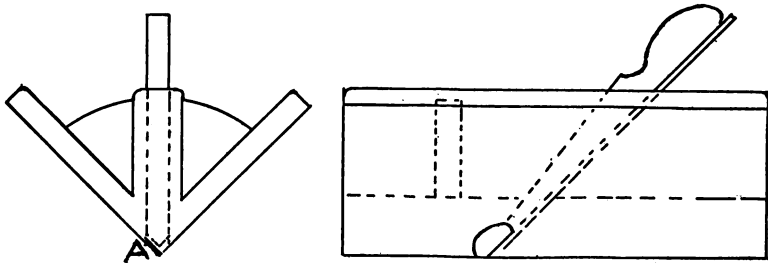

FIG. 40.

an acute angle, so as to conform to the shape of the plane at the apex of the angle forming the two sides of the face of the plane. The principle of its construction and use is, that the greatest inscribed angle in a semicircle is a right angle. The whole of the wood on the inside of semicircle cannot be cut out with this plane, so first use a gouge to cut it out to within one-eighth inch of the mark; then cut it exactly to line along both gauge marks; then, holding the plane in such a way that the fingers of the left hand will form a guide to keep the plane to the line, cut a shaving along the line on the side

farthest from the operator. This is illustrated by Fig. 41, in which the upper curved line represents the work as done by the gouge, and the semicircle immediately below it is the circle to which the work is to be cut. There is now a guide for both sides of the plane, so that by exercising a little care the plane may be passed along through-

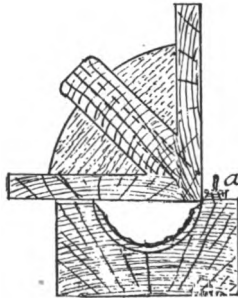

FIG. 41.

out the length of the block, cutting a shaving at each stroke. This may be continued until about one-third of the whole is worked out. Now the block may be turned end for end, and the other side treated in the same way down to about midway of the distance; then turn the block again and finish the other side. This will make a very neat and accurate job if the plane is in proper condition. Another way by which the plane may be started is to nail a thin strip of wood along the gauge line as represented at (a) Fig. 41. This is used as a guide for the plane. After the groove has been cut down a short distance (about one-sixteenth inch), this extra piece must be removed to the other side and again used as a guide. This guide piece must be taken away before work-

ing the groove down very much, for if allowed to remain it would change the size of the semicircle made by the plane. The cutting iron of the plane should be so sharpened and set as to cut on one side only, preferably on side A, Fig. 40. If it is allowed to cut on the other side, and used as indicated by Fig. 41, it will cut the groove too large, making the core box larger in diameter than wanted. Another way to cut out this part of the core box is to use a gouge to remove almost all the material, using a round plane to finish with. Doing the job in this way will involve the use of a straight edge to test the straightness of the work from end to end. For this purpose, a straight edge with a thin cross section is necessary. A try-square if long enough, is a very good tool for this purpose.

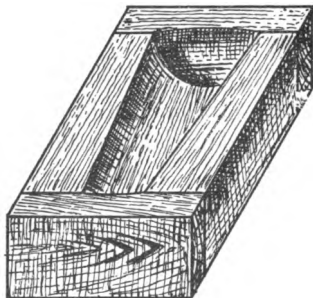

Fig. 41 (a).

It will be a great advantage to set the cutting iron so it will cut the wood on one side of the plane only. In order to do this it is best to cut away a small amount of wood on one side of the plane, as indicated at A Fig. 40. This plane is almost indispensable for making core boxes of the shape represented by Fig. 41 (a), for what may be

called conical cores. As the curve changes continually throughout the entire length, it is almost impossible to make a cavity that is uniform, if one uses the gouge and round plane. A straight edge and templet must be used frequently to test the work. But the core box plane overcomes all these difficulties, and if only the two sides of the cavity are correctly located, and then worked to the lines with the gouge, the plane will do the rest of the work. There are machines on the market which do this kind of work very accurately and rapidly. One of them is illustrated on page 45. This is the Crane Core Box Machine.

Whichever method is used in making this part of the core box, it needs to be smoothed on the inside with sandpaper. If the box is small, this is best done with sandpaper placed around a cylinder of wood, the cylinder being about one-fourth inch smaller in diameter than the box. If the box is large, a piece of wood about four or five inches wide and an inch thick, with one side planed approximately to the curve of the inside of the box, will be better.

To form the ends of the box marked A A in Fig. 38, the following is the best way: Make two pieces of wood four inches long and two inches wide, and exactly one inch thick. Plane them so that two of the narrowest faces will make a good joint at right angles to the wider sides. Now face up a chuck about six inches in diameter, and while it is revolving in the lathe, make a fine pencil mark or dot in the center. Place one of the pieces flat on the chuck, so that one of the face edges will pass through this dot mark; nail it to the chuck in this position, and then place the other piece alongside, and nail it also. If this work is correctly done, the chuck, with

pieces nailed on, will look something like Fig. 42. This is now to be put on the lathe, and a hole of the shape of the core print on the pattern turned into it. If the blocks were properly placed, each will have a semicircular hole in it, representing one-half the frustrum of a cone, whose dimensions correspond exactly with those of the core print on the pattern. These are now to be taken from the chuck and nailed and glued, one on each end of the body of the box previously made. This must be cut to the exact length required, which in this case will be four and one-fourth inches. It is necessary that a core box for a **vertical** core should be about one-eighth inch

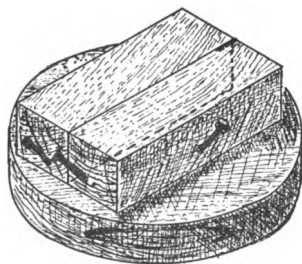
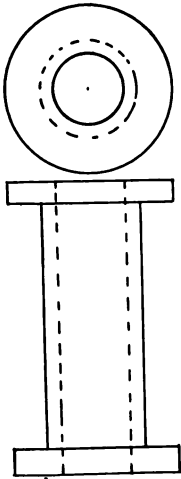

Fig. 42.

longer than the pattern, so that the cope of the mold will be sure to fit tightly around the core; then no metal can flow up alongside of it and over the end of the core, thus covering up the vent and causing the casting to blow. For the above reason all **vertical** cylindrical cores should be one-eighth inch longer than the total length of the pattern and prints. To complete the box it is only necessary to nail pieces (B B. Fig. 38) one on each end, and then give a taper at the point C. To make the core,

two halves are made in this box; after drying, they are pasted together, making a complete core.

The next example is very similar to the former one, but, having a flange at both ends, it will have to be molded **horizontally**, and will therefore require a **horizontal** core. The completed casting is represented by Fig. 43, and a pattern for producing it by Fig. 44. On account



FIGS. 43.

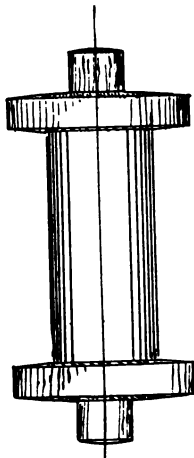

FIG. 44.

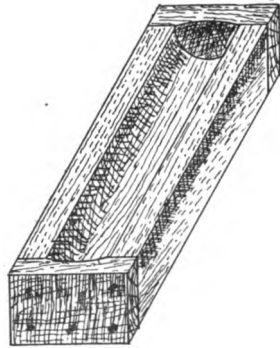

FIG. 45.

of the shape of this casting it will be best to make the pattern a **parted** pattern. This will save the molder some time and work, as it will give a form that is easily removed from the sand. In making this pattern, the first thing to do will be to get two pieces of wood of such dimensions that when they are put together the pattern can be turned out of them. As will be noticed by the



drawing, there is no finish required except on the face of the flanges. Allowing for finish, the length of the pattern without the core prints will be six and one-fourth inches. The core is to be one and one-half inches in diameter, so the prints will be one and one-half inches long; then two inches more must be added for fastening together at the ends, making a total of eleven and one-fourth inches for rough size. Two pieces then are needed, eleven and one-fourth inches long, four inches wide and two inches thick. The next step will be to plane one of the larger sides of each piece to a true surface, to form a joint between them.

The next thing is to locate the holes for the **pattern pins** that will be necessary to locate the two halves in relation to each other after being separated. The most practical way to do this is as follows: On the plane surface of one of the pieces locate these holes with a pencil mark; this mark to be, say four and five inches from a center line approximately on the center of the width. If the pins are thus located, the molder will not err in putting the two halves together, for if he happens to do it incorrectly, he will at once recognize his mistake.

Having marked the points where it is desired to put the pins, take two small brads and lay them on the block with the heads at these points; now carefully lay the other piece on these brads, and having brought it into exactly the desired position, strike the top piece a light blow with the hammer or mallet. This will cause the heads of the brads to make corresponding impressions on both blocks. At these impressions, bore holes one-half inch deep. The diameter of the hole is of small moment; for patterns of this size, one-fourth inch is about right; the larger the work, the larger the pins should be.

The next thing will be to make the pins, for which a piece about ten inches long will be found the best. Select a piece that is straight in the grain, and rip to such a size that one side of the square stick equals the diameter of the hole, plus one-eighth of an inch. With the jackplane plane this into an octagonal form. Then, grasping one end in the left hand and laying the other end on the bench, with the block-plane plane off the the corners, making it as nearly round as possible for about three inches of its length. This round part should be made to fit the hole exactly, that is, at the extreme end. With knife and sandpaper, or file, round this end to an approximately parabolic form. Now set it into the hole in the piece into which the pins are **not** to be fastened, far enough so that it exactly fits the hole. Make a pencil mark part way around it, right at the surface of the block. Now measure the depth of the hole into which the pin is to be fastened, and mark this distance along the pin from the mark previously made. This is the point at which to saw the pin off. Now, if this pin be driven down into the hole clear to the bottom, the first mark will come even with the parting and will exactly fit. By means of these pins, the two parts, after being separated, may be brought together again in exactly the same relative position, and will be held firmly so that they will not slide or shift sidewise during the process of molding. They should be loose enough so that the pattern will fall apart of its own weight, but still not loose enough so that there is any perceptible movement sidewise. When both pins are in place, the blocks are ready to be fastened together. There are three ways in which this may be done. If there is time to wait for glue to dry, the best way is to put glue on the ends of each piece for a dis-

tance of about one-half inch, and clamp them together with a handscrew or other clamp. If it is desired not to wait for the glue, then a screw may be put through the ends, fastening them together in that way. It is advisable, for convenience in turning, to use a short screw, boring a hole large enough to receive the head of the screw. For a piece of this size a one and one-fourth inch screw may be used. If care is taken to have one-half the length of the screw in each piece, it can be turned to the required size of the print, out to the extreme end. The third method is to clamp them together with "dogs," which are small square staples made for the purpose. When the pieces are thus fastened together, they are ready to be placed in the lathe and the turning proceeded with. This may be done practically in the same way as in the previous example. One must allow for draft, and also for finish on the faces of the flanges, making these faces, and the ends of the prints convex as shown in Fig. 44.

The next thing will be the core box. As this pattern requires what is known as a plain, cylindrical, horizontal core, and is therefore symmetrical, only a half-box is needed. But if it is desired to reduce the cost in the foundry, a core box like the one represented by Fig. 10, page 39, in the chapter on cores, would be used, the core being made complete at one operation. The half-box would be made as directed for the straight part of the core box in the last example, with end pieces, as represented by Fig. 45. If a whole box is made, then the block would need to be twice as long, and worked out as in Figs. 38 and 39. After this is worked out, it should be cut in two pieces and pinned together in the same way as was done with the two pieces for the

pattern. One way that is quite practical is the following: After cutting the pieces the correct length; place them together in their proper relation to each other; fasten them in the vise in a vertical position, with one end above the bench top, and bore a hole of the size required for the pin clear through the first piece and about half an inch into the other. Now by putting the pin through the hole, it will be filled and make an accurate and workmanlike job. If brass pins are used, this could not be done, because the pin would not fill the hole; and as the pin and its tube are of a different size, the hole could not be bored with the same bit. The inside length of this core box should be about one-eighth of an inch shorter than the total length of the pattern and prints, so that the core may be more easily set into the mold.

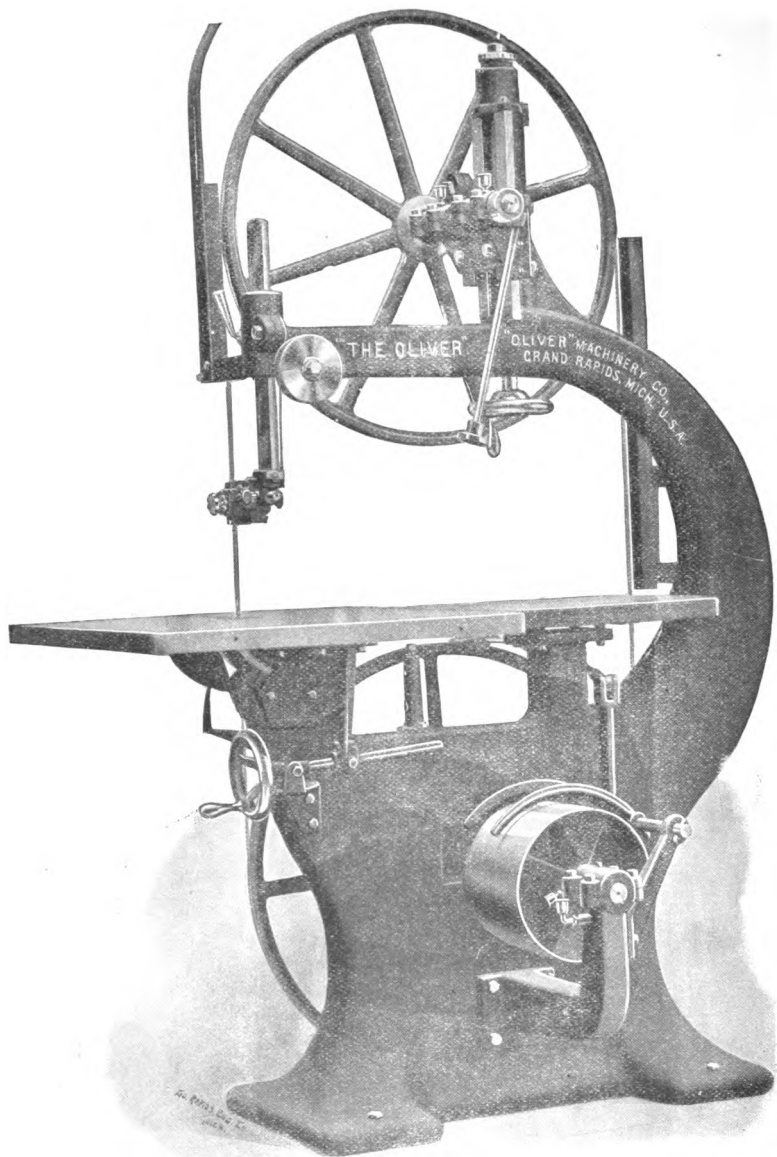

*"Oliver" Bandsaw*

## CHAPTER X.

### PLATE WORK AND IRREGULAR PARTING

The next example to be taken up is typical of a quite large class of pattern-work, generally known as plate work. It is usually comparatively thin in cross-section in at least one direction. This class of work includes shafting, hangers of different patterns, some kinds of small pump standards, and any kind of work that is composed of two webs running into or crossing each other. This last is illustrated by Fig. 46. The example to be used to demonstrate the methods usually followed in building patterns of this type is represented by Figs. 46 and 47. In order to make the best pattern for durability and permanence of form, the foundation should be built of three pieces, as shown in Fig. 47, which is almost self-explanatory. Of course, this part of the pattern could be built of one piece of board, but it would be very weak through the portion marked A. By building it as represented, two things are gained; it is uniformly strong throughout, and smaller pieces of wood may be used. As in the case of all other patterns, so in this, it should be first determined how the pattern is to be withdrawn from the mold. It will soon be seen that the best way will be to have the face marked B (Fig. 46) down in the nowel; thus there will be left an almost flat surface for the molder's parting, which will then occur along line C D. It will, of course, be neces-



general type; modifications of it may be introduced when needed.

The first step to be taken in making this pattern is the making of two pieces of board about fifteen inches long, by two and one-half inches wide, and five-eighths inch thick, and one piece about nine inches long, four inches wide, and five-eighths inch thick. These must be planed on one side to a true plane, with the edges straight and at right angles to the side; a **face mark** should be put on each piece. Now the two long pieces should be cut to shape, so as to make a good joint at F, care being taken that the two lower corners are far enough apart to include all of the pattern at that point. Tack these to the bench or laying-out table in their proper position with relation to each other; then locate points G H, and lay the third piece on the others with its edge at these points, and make knife marks across the two pieces. Now, without moving the third piece, make marks on it with the point of the knife at the points K, L, M, and N; then finish the laying-out, and cut out gains half way through the two long pieces. Then cut out the ends of the short piece to the same thickness, but on the opposite side; fit them together and glue them and put them in clamps till dry. While this is drying, a piece of board about fifteen inches long, six inches wide, and one-half inch thick, can be gotten out. Out of this can be sawn pieces for making the curved pieces that are built on to form the raised portions that are to be glued on to the main piece. These should be cut from the board so that the grain of the wood will run parallel with a chord of the curve, making the segment not to exceed one-quarter of the circumference of the circle. If they are made longer than this, there will be too much end



grain. The straight pieces may also be gotten out at this time, so they will be ready when wanted. When the glue is dry on the three pieces that together form an A-shaped piece, it is to be planed on both sides to true planes until it is one-half inch thick. It is now ready to have the lines laid out on it as shown by Fig. 47. In

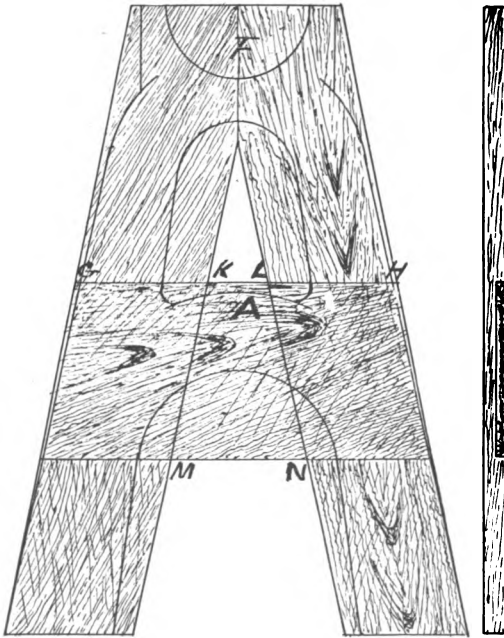

FIG. 47.

laying out these dimensions, the shrink rule should be used, as that will allow for the shrinkage of the metal in the casting. After these are all laid out, it may be sawn

out on the band and jig saws. In doing this sawing, it is best to cut just outside the line, so that in filing and finishing the edges, the marks may serve as a guide. It is now ready to have the pieces set on to form the projecting webs, which may be cut from the one-half inch piece already mentioned. It will be best to commence at the top of the pattern.

The first will be a solid piece extending all over the upper end down to and including the semi-circle that joins the long outside webs. After this the other circular parts may be cut out and put on. Now the pieces to form the feet may be made and glued in place; then the straight pieces should be nicely fitted to these and glued in place. Now a piece of wood may be gotten out to form the fillet around the bearing where it joins the main part of the pattern. This should be about three-eighths inch thick, and should be large enough to extend three-eighths inch all round outside the bearing. For convenience in cutting out the fillet, it is best to let the grain of the wood in this piece run parallel with the outside line of the pattern at this point. A piece is also needed to go on the other side to form a fillet on which to pin the loose piece. (E Fig. 46.) Now a piece to form the bearing itself may be made. As this is required to be more than a half circle, it will be best to make it with the planes. According to the dimensions given, it will need to be of the following finished measurements: about four inches long, two and one-fourth inches wide, and one and three-eighths inches thick. It should be planed square to these dimensions, and a semi-circle described on each end, and then planed and sandpapered down to it. A piece can now be cut from this just two inches long, and fastened on top of the three-eighth inch fillet

piece. Both ends of this piece must be square, so it will set in a vertical position on one end, and so the core print to be made later will fit well. A piece of this is required for the other or cope side, one inch long. This, however, will not be fastened in place permanently, but will be pinned on so that it will lift with the cope sand when the cope is lifted off. The best way to do this is to place it in a correct position and drive two small brads through it, taking care not to put them where the pin holes are to be bored. Now, with brace and bit, bore two holes clear through it and into the other part of pattern to a depth of about one-half inch. A one-fourth inch auger bit is a good size to use for this purpose.

Now make pins as directed for use in the parted pattern on page 78. In this case they can be put through

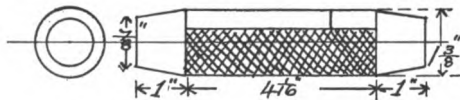

FIG. 48.

and fill the holes, as they will have to be on the loose piece.

The next thing will be to make the core prints. These will extend the whole length of the bearing, and of course the length of the prints besides, and as this is a vertical core, will project one inch beyond the pattern on each side. To make these prints for this particular job, take a piece of wood about seven inches long and one and one-half inches square, place it in the lathe and turn to shape and dimensions as shown by Fig. 48. The shaded portion will be cut out so it will fit down on to

the pattern already made. The line just above the shaded part is the point to cut through so as to coincide with the pattern parting.

To complete this example a core box will be needed, which will be made as shown at Fig. 49. The process is

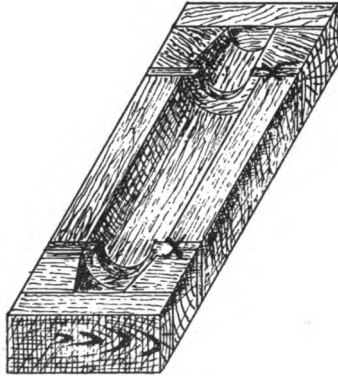

FIG. 49

the same as already described, except as to the pieces marked X. These are to form a crease or groove in the core, to form the babbitt pieces on the casting shown at O, Fig. 46. These are simply pieces of wood one-eighth inch thick, of a size equal to the cross-section of the core box, and with a semi-circle cut in on one side, whose diameter is one inch, that is the size of the shaft the bearing is intended to carry. In building the box, the pieces must be nailed in between the body of the box and the parts forming the prints. The completed box is shown at Fig. 49.

The pattern for a hook lever for Corliss valve gear will be the next one taken up. This gives a good example of what is known in the foundry as an irregular part-

ing, and is illustrated in the chapter on molders' joints by Fig. 17, the molders' parting following the heavy dotted line. It is also a good example of what may be called a built up solid, **one-piece pattern**, meaning that the completed pattern has no **parting**. This is typical of a very large class of patterns, as all patterns would be made **one-piece** if they could be conveniently molded in that shape. Before commencing the actual work on this pattern, notice particularly the position of the molders' parting and then the direction of the required draft. The first pieces to be gotten out will be the two of which to make the arms, each about four and one-half inches wide, ten inches long and three-fourths inch thick. These should be planed to a true surface on both sides

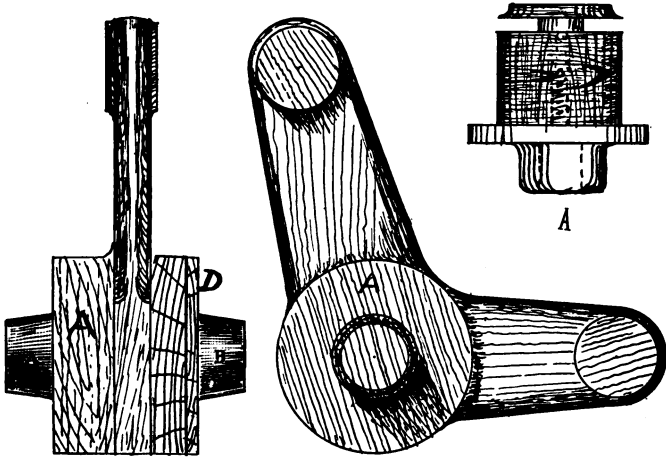

FIG. 50.

to the exact thickness, three-fourths inch, then nailed together so their center lines will be at the required angle



This can be easily settled by comparing the work already done with the drawing. A screw chuck affords a good means for holding these pieces in the lathe, and also the stock out of which to turn the four bosses required for the ends of the arms. These four may all be turned out of one piece by cutting off a piece from a two-inch plank about two inches long, measured in the direction of the grain, and six inches long, across the grain, and mounting it in the lathe so that the grain is perpendicular to the axis of the lathe. This is plainly shown by Fig. 50A. After these bosses are all fastened in place (they should be so placed that the grain will run in the same direction as it does in the arms) the arms may be shaped or rounded into the elliptical form indicated at L, Fig. 50(a) and all the different surfaces blended into each other so as to make one general even surface. The central hole or bore as it is sometimes called, will of course be made with a dry sand core, so that it will be necessary to use coreprints and a core box. This being a vertical core, the shape of prints and core box will be the same as for the first exercise, Fig. 38 on page 71.

## CHAPTER XI.

### PULLEY PATTERNS

The next kind of pattern-work to be considered is the making of patterns of the general shape of Fig. 32, sometimes called annular patterns. The example used for the purpose of explaining how such work is done is the pattern for an eight-inch pulley with a three-inch

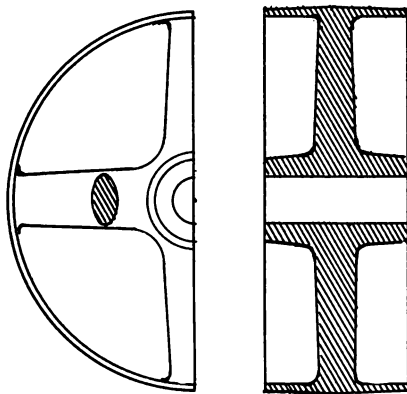

FIG. 53

face. The technical description for shop use is written like this: Pulley 8'' x 3'', hub  $2\frac{3}{4}$ '', four arms, rim  $\frac{3}{16}$ '' thick. The "8''" means the outside diameter of the



pulley; the "3'" the width of face; "2 $\frac{1}{4}$ "' the diameter of the hub or central boss, through which the shaft runs; and "4 arms", the radial arms or spokes that connect this central boss with the rim of pulley; the " $\frac{3}{16}$ " rim" is the thickness of the rim at its outer edge. The finished pulley is represented by Fig. 53.

The first step in the case of this pattern as of all others, is to determine how it is to be molded. As to mold it from a one-piece pattern would be quite difficult, it is best to make a parted pattern, the parting being made on a central plane running through the center of the arms; this means that two halves will be made. The first thing to do is to prepare a chuck about 9 inches or nine and one-half inches in diameter and about one inch thick, and face it off true. On this chuck build up a ring or hollow cylinder high enough so that both halves may be cut from it. If enough is built for both halves, it will need to be three inches, equal to the width of pulley face, plus one inch for cutting off, making in all four inches in height. This is to be built of straight-grained white pine about seven-eighths inch thick; therefore it will take five thicknesses for the required height. These pieces will be cut into segments or cants of such length that four will complete the circle. They must be cut so that the grain of the wood is **parallel** to the **chord** of the **curve**. These will be cut on the bandsaw or jigsaw, and made large enough so that the ring may be turned and still allow for draft and finish. As one-sixteenth inch is to be allowed for draft and one-eighth inch for finish, and as the finished pattern will need to be eight and three-eighths inches in diameter at the center, the rough built-up ring should be about eight and three-fourths inches in diameter. For a guide in

building, make a pencil mark on the chuck while it revolves in the lathe so that the circle thus made will be of the required diameter. To mark out the segments, proceed as follows: Set the dividers at the radius required ( $4\frac{3}{8}$ "') and describe an arc tangent to the edge farthest from you of the board from which it is proposed to cut the cants. Set the dividers to three and one-half inches, and describe another arc; this will leave the cants three-fourth inch wide; lay a framing square on the board at an angle of  $45^\circ$  with its edge, with the heel exactly over the center from which the arcs were struck; and at the point where the sides of the square cross the arcs, make marks. This will give the length of the required segment and at the same time give the radial line which is the correct line for cutting the cants. If the board is too long to carry to the bandsaw conveniently, cut off with the handsaw a piece just long enough for the segment. Saw out this one segment, using it as a pattern with which to mark out all the other nineteen cants required. This pattern segment should be cut out so that it will be a little too long; then the others, when marked out by it, may be cut to the mark and still be long enough to allow for fitting, as the joints must be exact. Now saw out four more and then proceed to fasten them on the chuck. The others may be sawn out while the glue is drying. Now a trimmer or shoot board will be needed on which to shoot or plane the ends of the pieces. The shoot board and the method of its use are shown in Fig. 54. The trimmer is a more complicated machine and is represented by half-tone on page 97. Plane or trim both ends of one of the segments and drive a two-inch brad into it at each end, from the top side almost through it; put some glue on

the ends and on the under side, and place it on the chuck just inside the circle already made, driving the brads down until the heads protrude just far enough so that they may later be withdrawn with the claw hammer. Now fit another segment up to this one, being sure that it makes a good joint, especially on the inside of the ring.

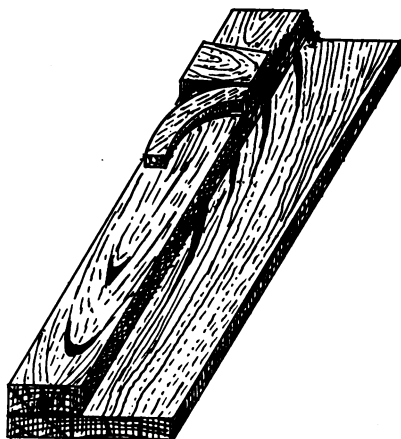
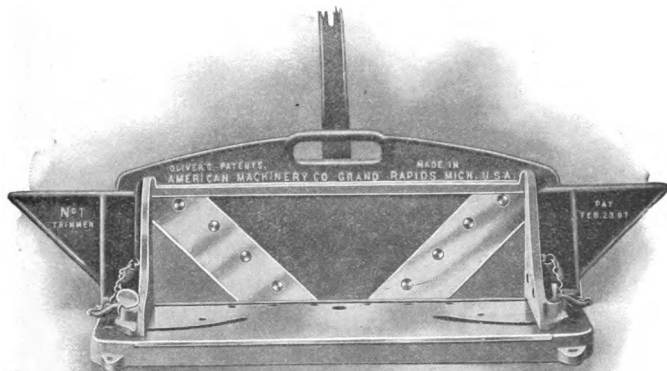
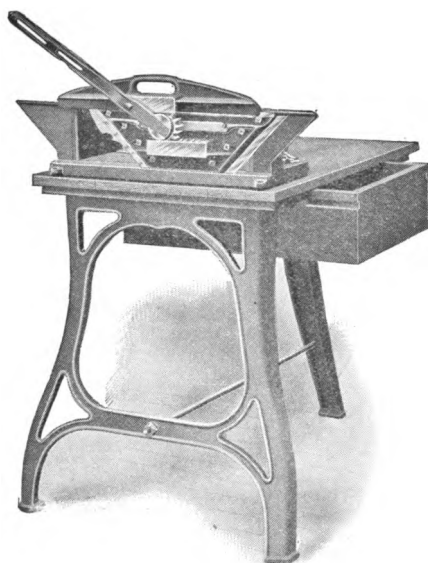
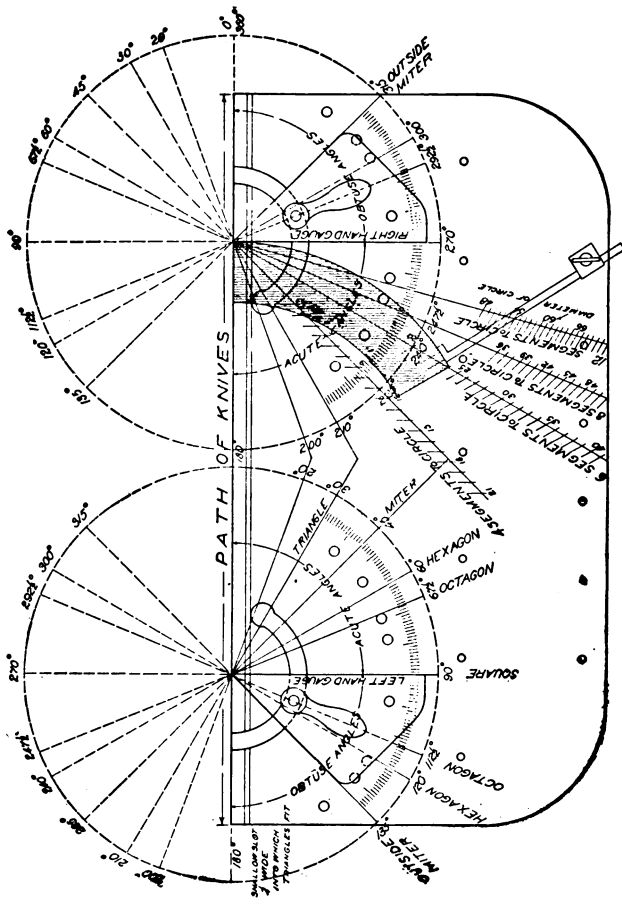

FIG. 54.

For if a poor joint is made, the small triangular pieces formed in cutting the segments will be torn out by the chisel during the process of turning. The second piece may now be glued into place, being sure as before to put glue on **both ends** and also on the **end** of the **piece** that is in **place**. Thus the ends of the pieces are glued twice, which is very necessary if a strong joint is wanted. This is called **sizing** the joint. If it is not done, the first coat of glue will be absorbed by the wood and the joint will be weak. This course may be followed until the first ring or layer of segments is complete, when it should be



*"Oliver" Trimmers*



Bed of Trimmer

allowed to dry. After the glue is dry, the brads may be pulled out and the chuck put in the lathe and the ring faced off, making it true in both directions. The next layer may now be put on in the same way. The ends of the cants should be placed about in the center of those in the lower layer, so as to break joints.

The above is the method usually followed in making this form of pattern when the cross-section of the ring is small, that is, of three-fourths inch, or less. If the ring is to be one inch or more thick, it is best to use hand-screws to hold the different layers down until the glue is dry. If simply a ring is wanted, that is one inch or more in thickness, and we are sure there is no cutting to be done on it in the future, then the brads may be driven clear in and left in the work, except in the first layer. This will, of course, obviate the waiting for the glue to dry, so that a ring may be built up very rapidly. Zinc nails or wooden pegs may also be used in this class of work, but if a good quality of glue is used, they are not necessary, except in very thin work. The work is now ready for the lathe. It is advisable before turning it to glue up the stuff for the arms and hub; then we need not wait for the glue to dry, as it will dry by the time the rim is turned, unless this is done much more quickly than it usually is.

There are two general ways of building up the **spider**, as it is sometimes called, of a pulley; which is the better way is determined by the size, number of arms, and some other things. One way is what is known as **checking** the arms together, and then gluing the boss on afterwards. This is a good way, if care is taken so that they fit exactly. If they are made too tight, however, the ends are likely to be bent out of the correct position.

This method, of course, cannot be used for spiders having an odd number of arms. A better way for most work is to miter the arms together. The only objection to this method is that it is comparatively weak. But this defect is easily overcome; for, if there is no hub or boss required, a recess may be turned into the arms after they are glued together, and a piece of hardwood, or metal, set in and a screw put into each arm, as shown in Fig. 55.

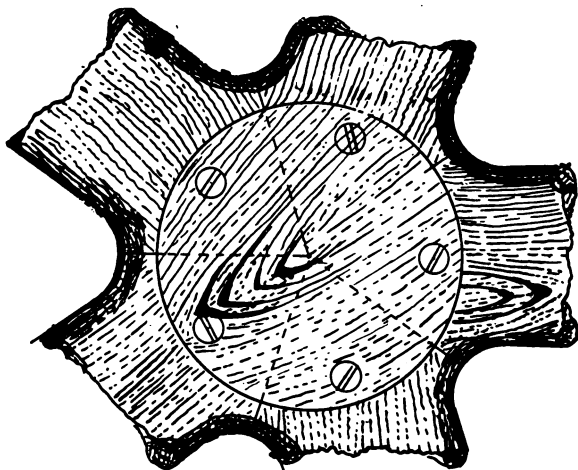

FIG. 55.

If a hub is wanted, and it usually is, this will give the required strength. This method may be used for spiders of any number of arms.

To make the spider, then, for this pattern and in the last mentioned way, the first thing to do is to get out eight pieces, four and one-half inches long, one and three-fourth inches wide, and about five-sixteenths inch thick; cut one end of each piece so as to make an angle

of  $90^\circ$  at an angle of  $135^\circ$  to each edge. Now saw out on the band or jig saw, two disks about three inches in diameter, and one and one-fourth inches thick, and glue four of the thin pieces on to each disk, with the point of the  $90^\circ$  angle directly in the center. The best way to do this is to start three one-inch brads, one in each corner of the triangle; put on some glue, lay the piece in place and drive the nails down, leaving the heads projecting so the brads may be afterwards withdrawn with the claw hammer or pincers. Now these may be set aside to allow the glue to dry. While these are drying, the rim may be turned to size and cut off. The chuck, with the built-up rim on it, may now be put in the lathe and the rim turned to size. The extreme outside diameter should be eight and three-eighths inches. This is for the central plane through the hollow cylinder. At the ends of the cylinder, that is at the point where it is glued to the chuck and the opposite or outer end, the diameter should be eight and one-fourth inches. These measurements must be made with the shrink rule. Before starting the lathe, see to it that it will not run too fast. The work to be turned should run at a surface velocity of from 1200 to 1400 ft. per minute for pine wood. This will also give very satisfactory results on all ordinary soft wood. If the wood is unduly soft, a higher speed may be required. It may run much faster than this with safety, but it is best to keep the speed down as low as may be and still do good work. The work in hand should be run comparatively slow at first, so as to turn off any inequalities of building, both on the inside and outside; as the work becomes cylindrical in form, a higher rate of speed may be used. The inside had better be turned first, and a diamond-pointed tool will be the best to rough it out



with, using a regular scraper for the finishing. The size inside at the center will be seven and three-eighths inches diameter; at the two ends, seven and five-eighths inches diameter. Finish the outer end back to a short distance beyond the center; in other words, back far enough to make a little more than one-half of the rim, which will be one and five-eighths inches.

When it has been turned as suggested, it is ready to be cut off. Locate the cutting-off point by holding a pencil exactly one and five-eighth inches from the edge, while it is revolving; this will make a mark at the proper point. Now take a parting tool, and cut into the work just outside this mark and almost through, leaving a very thin section which may be cut through with a knife. It is not good practice to cut clear through, for the work may fall on the floor, receiving more damage than can be repaired in the time it takes to cut it off with a knife. If the work has been done correctly, we have one-half of the required rim. As for the other half, it is already turned to size at the outer end, and all that needs to be done is to turn the rest of it to the size and shape of the first one.

Before being cut off, both of these halves should be thoroughly sandpapered, first with coarse, and then with finer; No. 2 for the coarse, and No. 1 for the fine are the best numbers to use. After they are taken from the lathe it is well to give the rims a good coat of black varnish, as it will prevent, to a degree, their tendency to warp out of shape.

The spiders are probably dry by this time, so that work can be resumed on them. First, they must be planed to a perfectly plane surface on what will be the parting in the completed pattern, so that they will exactly

fit each other. Now take the chuck you have just used for turning the rim, and face it off to a surface that is a very little concave; then while the lathe is revolving, make a circle about the size of the disk in the spider. Set one-half of the spider on the chuck so that the disk coincides with this circle, and drive a brad in two of the arms and into the chuck. Before doing this, though, it is well to select two one-inch screws, and with brace and drill bore a hole through two of the arms just the size to fit the screws; these holes should be countersunk for the head of the screw, so that they will set in below the surface of the arms, to permit of their being turned to the proper surface. Now the half spider may be set as suggested, and the brads driven far enough so that they will hold the spider while the screws are being turned in. With the scraping tool face off the whole thing in order to true up the faces so that a mark can be made, and make a circle on the face of the arms equal in diameter to the outside of the rim on the center of the pattern. You will notice that this is where the arms will finally be joined to the rim. **Inside** of this circle the arms will be cut down to the required thickness (one-fourth inch), and to the required thickness at the hub (five-sixteenths inch). The surface of the arms should be a straight line between these two points. The hub can now be turned to size, (two and one-fourth inches), in diameter. There must be a fillet in the angle between the arms and hub of about one-fourth inch radius. In the center of the hub turn a hole about three-fourths inch in diameter, and one-half inch deep, to receive a core print. Sandpaper the hub and also the arms for a short distance from the hub, taking care not to get your fingers caught by the arms as they swing

around. On the arms should be marked a circle whose diameter is the same as the inside of the rim at the center of the pattern. This circle will serve two purposes, as it furnishes a place to space around to locate the center of the arms, and also locates the point of tangency between the arm and the fillet that must be formed on the arm. Another circle should be made around the hub; this may be about three inches in diameter; the exact size is not material. Now this half may be removed and the other half put on and treated in the same way, except that the two circles last mentioned need not be made. The next thing to do is to lay out the lines for the shape of the arms. First make a mark that is exactly radial along the whole length of one arm, and as near the center as can be. Starting from this line, by the use of the dividers divide the circle near the outer end of the arms into four spaces; the points thus formed will locate the center line of all the arms. Divide the circle that is near the hub in the same way, starting from the same line. Set the dividers to one-half the width of arms at these points, and make marks on each side of these points; these marks will locate the sides of the arms; now with a short straight-edge, join the marks by a line along both sides of the arms. It is required to have fillets at the intersection of the last made lines and the outer circle, which may be marked out by setting the dividers to the required radius (one-fourth inch), and describing an arc that shall be tangent to the straight line and the circle. Fillets are also required at the point where the arm joins the hub; these should be tangent to a circle about one-half inch out from the hub and to both arms; the radius to be such that one arc shall touch all three points. The sides of the part of the arms that are set into the rim are

now to be located and marked. This is done by making a mark parallel with the center line of the arm; it should start from the point of tangency of the fillet arc and the circle representing the inside of the rim, and should extend to the end of the arm. All of the above marks should be on the same side as the hub.

Next put the two half spiders together so that the two hubs shall be exactly over each other, or exactly concentric, and fasten them temporarily by driving a small brad through two of the arms. These brads had better be put as near the end of the arms as may be. With a brace and five-sixteenths inch auger-bit bore holes through two of the arms for pattern pins. These pins should be located so that they will not be symmetrical with the center of the pattern; that is, one should be about three-fourths inch further from the center than the other. These are now ready to be sawn out, which can be done either on the band saw, jig saw, or with the keyhole saw, sawing out one half at a time. This will be easy to do in the case of the first half, but in that of the other not so easy; for, as the second has been marked from the first one, the marks will be on the flat side, so that the hub will come on the under side. To do the work more easily, take a small block of wood with one dimension equal to the distance that the hub projects above the arms, and set it under the end of each arm as it is being sawn. It will be safer to drive a brad through the arm into the block, so that in moving it around on the table of the saw machine it cannot get out of place. If it is preferred, both halves may be sawn at once; but if this is done, the pattern pins should first be put in so as to make sure that the two halves will be exactly alike, and will set over each other just right. After these are sawn out they must

be filed nicely to the lines; then give them the required elliptical form by rounding off the corners and blending in all the curves with each other so that a uniform surface is formed.

The rims and spiders are now ready to be put together. Lay one of the half rims on the bench with the side up that will be the center of the pattern, and lay on one of the half spiders. If everything has been done as directed, they will be self-centering because of the extra thickness that was left on the end of the arms when turning them. If this has not been done, they may be centered by the use of inside calipers, measuring from the side of the rim into the hub on three or more sides. This should be done very carefully, for if the hub is not in the center it will not look very well when the hole is bored for the shaft, and of course it will not be balanced. When the spider has been correctly located, make a mark with a knife on the edge of the rim on both sides of each arm; before taking the spider off be sure to mark one of the arms and the place where it belongs, so that it can be put back into the same position. Now set a gauge to the thickness of the ends of the arms, and gauge a line parallel with the edge of the rim between the marks on the edge for the recess for the arms. Now saw down to this gauge mark and remove the wood, making a nice clean gain exactly to lines. Now the arms may be glued and nailed in place.

The other half should be treated in the same way. Before marking recesses, lay them together and notice if everything is coming concentric; if not, you can change the position of the second spider slightly, so as to make it right. After getting them together in this way, the extra length of the arms may be sawn off and the parts

smoothed up. Two core prints will be wanted for the hubs; these, of course, will be tapered because the core will be vertical. A coat of varnish should be put on the spider, the rim having been varnished before. The whole thing is now ready to be finished. First, fill up with beeswax any small holes and any other defects in wood or work. A fillet is needed on the inside of the rim, on the side of each arm of both halves. This can also be of wax, put in with a filleting tool of one-half inch diameter. Further directions for finishing will be found on page 141. To make this job complete, a core box will be needed, the same as one described on page 71, (Fig. 38), except as to dimensions.

## CHAPTER XII.

### PATTERNS FOR CAST GEARS

The next class of work to be taken up requires the greatest amount of care and attention on the part of the pattern-maker, as in order to obtain the best results his work must be correct in all its details. The class of work referred to is the making of gear patterns, especially patterns for what are known as **cast gears**. By this is meant, gears of which the teeth are cast to the required size and shape, without being cut. There are two general ways of manufacturing gears.

One way is to cast what is known as a **gear blank**, which is turned to size and the teeth cut from the solid metal. This is the method usually employed for small work, and for gears that are required to run very smoothly. They are spoken of as a class, as **cut gears**.

But if the gears are large and of coarse pitch, the patterns are made with the teeth of the approximate size of the finished teeth. That is, each surface of each tooth on the pattern is treated the same as a finished surface on any pattern, i. e., about one-eighth inch is allowed for finish or machining. After the casting is made, the teeth are cut on the gear cutter just as the full blank would be for a small gear. Casting them in this way, of course, saves an immense amount of cutting, thereby economizing on time and the wear of cutters. When, however, only one

gear of a particular size and pitch is wanted, it is not profitable to do this; in this case the pattern is cut to the exact size of the teeth; as in a large class called "cast gears."

It best serves the purpose of this volume to illustrate some general principles in regard to making gear patterns that can be applied by the student to any par-

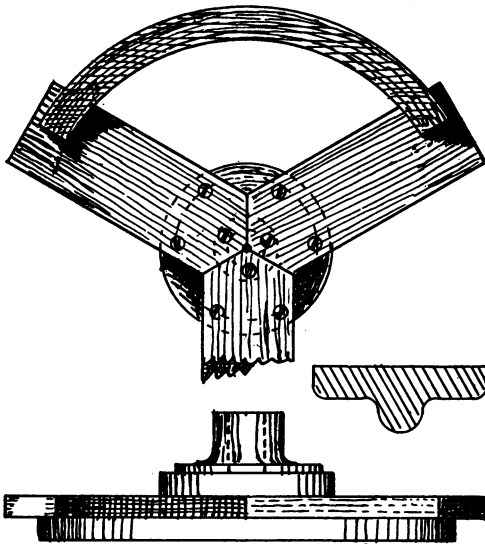

FIG. 56.

ticular case. Consequently, in preference to a gear of any specific size, gears of the last mentioned kind will be considered.

The part to be considered first is the rim or periphery of the wheel, to which the teeth are fastened. There



are several ways that this may be built up; the difference is mainly in regard to the method of holding it in the lathe while being turned. The actual building should be done as explained for the pulley rim, that is, with segmental pieces of wood of the required size and thickness. As the cross section is of somewhat different shape, the segments will of course vary also. If the gear is to be large enough so that both sides can be gotten at at the same time while running in the lathe, the best way is to build up the rim on what may be called a three-armed chuck. This is made as illustrated by Fig. 56. The width of the arms will be determined by the

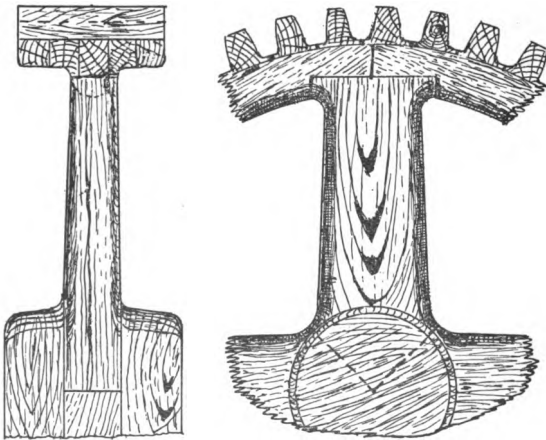

FIG. 56A.

size of the gear. For gears up to two feet in diameter, pieces seven-eighths inch thick by three inches wide, will be heavy enough. The length of the arm will be equal to the radius of the rim only. These arms are to

be mitered and fastened to a disk a little larger than the face plate that it is proposed to use; the fastening is to be done with screws, as indicated. The face plate should be put on, and the chuck put in the lathe; then the face of the arms, for a distance somewhat more than the width of the stock for the rim should be faced-off true.

It is now ready to have the segments glued on for the rim. As will be seen, the first row of segments must be made up of three pieces and jointed in the center of each arm. After this is glued in place, the rest of the structure may be made up of shorter ones, in fact, of any length desired. The building process should be continued in this way until completed, leaving the arms of the chuck as near the center of the rim as possible.

It is now ready to be turned to size and shape, which should be done with scraping tools; it should be tested for shape with a templet. It is not well to cut the arms down too thin until the teeth blocks have all been glued on and turned to size. In other words, all the turning to be done should be completed before cutting into the chuck arms very much; otherwise the rim may spring. When all the other turning is done, the arms may be cut almost through with very little danger. Of course the more nearly through they are cut, the less work will have to be done by hand after it is taken from the lathe; this should be left, however, until the tooth blocks are glued on and the turning all done.

The next thing to do is to mark out the spaces in which to fasten the tooth blocks. If the pitch of the gear is not more than one inch, these blocks may be made of such a size that, allowing one for each tooth, they will form a complete circumference around the rim. The grain of the blocks must be perpendicular to the side of

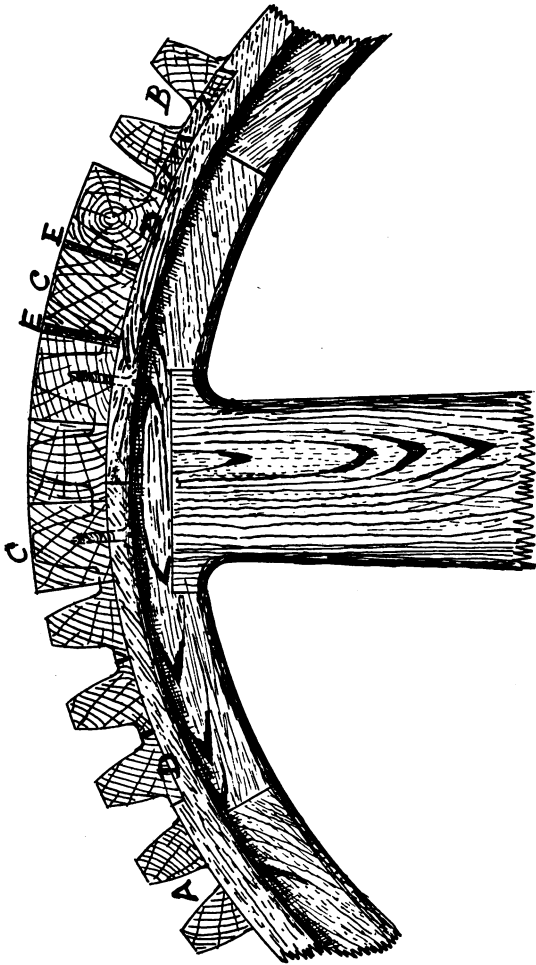

FIG. 57.

the gear, or in other words, parallel with the axis of the wheel. They should be made of good, clear, straight-grained wood, thoroughly seasoned.

There are several ways of putting these blocks on the rim. Three ways will be explained that will include all the practical ideas and principles of this branch of pattern-making. In all three, the rim at its present stage will be laid out in the same way, that is, spaced into as many spaces as it is required to have teeth in the wheel. The three ways spoken of will be more clearly understood by referring to Fig. 57.

The method shown by the tooth A is what may be called the cheap way. In this case the teeth are formed

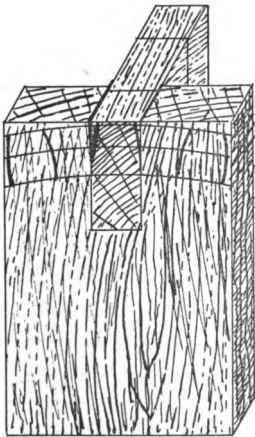

FIG. 59.

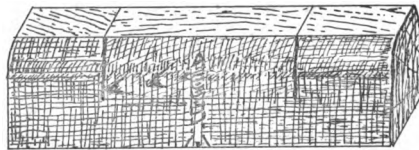

FIG. 58.

before being fastened in place. They may be formed in two ways. One is to plane up strips of wood to the desired shape, and then cut them off to the required

length. A better way is to make a box as illustrated by Fig. 58, each block being cut to exact length and held in place by a screw, as shown. Fig. 59 shows the method of getting the shape of this box. In using this box, care must be taken not to cut away any part of it in planing the tooth to shape. To locate a tooth on the rim, set the dividers to exactly half its thickness; place one leg on the center marks already made, and with the other leg make a mark on each side; these marks will indicate the position for the sides of the tooth block. Of course these marks must be squared across the face of the rim so that the teeth may set square. When gluing them on use a try-square to test them; do not depend wholly on the marks for this. The above method does very well for a job where only one or two wheels are wanted, and for cases where it is not desired to go to the expense of a good job of pattern-making. The second way is to glue all the blocks on the rim, lay them out in that position, and then cut to the lines. This makes a good job when properly done, but it is rather inconvenient to cut the teeth, especially if the face of the gear is very wide. There is another way that is known as the dove-tailing method, so named because each tooth is glued to a thin block let in to the rim. One disadvantage of this way is, that if the dovetails are driven a little too tight, it is very likely that the rim will be sprung, and the resulting casting will not be round. About the only advantage claimed for this method is that one or more of the teeth may be removed and used by the molder for patching up a broken mold; but this can be attained in another way. The method of dovetailing is illustrated at B. Fig. 57. It is a very expensive method, and is now almost obsolete.

The best way to fasten and form the teeth on gear patterns is the one shown in the center of Fig. 57. It should be used on all standard patterns. This method was first published by P. G. Dingey in the *American Machinist*. Before entering into the details of this way, some of its advantages should be noticed. It does away entirely with the objection mentioned in connection with the dovetailing method, viz., springing the rim by driving the dovetails; and at the same time it permits that one or more of the teeth be removed by the molder, if necessary. Another great advantage gained is that the fillets are made in solid wood, thus producing a much smoother pattern and casting. None of the other methods shown have this advantage. In the dovetailing method a very thin edge must necessarily be left at this point. In the first method described a wax fillet would generally be used, which in the course of frequent use is very liable to be loosened by the shrinking and swelling of the wood, leaving the pattern rough just where it ought to be the smoothest. Another advantage in the method under consideration is that one-half of the teeth being fastened on with screws, each alternate tooth may be removed, thus making room for working those glued on.

In this method the first thing to be done, after building up the rim, is to turn the rim down about one-half inch smaller in diameter than the diameter of the whole depth circle, or to the point lettered D in Fig. 57. Then, of course, the tooth blocks will have to be made larger by that amount than the size of the tooth proper. After the rim is turned to size it should be spaced as previously suggested. This should be done accurately so that each tooth may come in the center of each block.

One set of lines will do if the pitch of the gear is not too coarse to allow the stock of which the tooth blocks are to be made, to fill the spaces. Otherwise, two sets of lines will be required, and pieces must be glued in between the blocks, as represented at E, Fig. 57. When the blocks are ready and the rim is marked out, one of the blocks may be glued in place. Do not get too much glue on, as it will be likely to make trouble in putting on the next block, for this is to be fastened on without any glue. With a brace, and a bit, of the proper size for the screws to be used, bore two holes through the rim as near the center of the space for the next block as may be; counter-sink them on the inside of the rim to receive the heads of the screws. Hold the second block in position, and with a brad or small drill mark on the block the places for the screws, and bore them with a suitable sized drill. Now, holding the block in position again, insert the screws, driving them in until the heads are slightly below the surface of the rim. This process should be carried on until the blocks are all fastened on. Be very careful **not** to glue the blocks together for at least half an inch from the surface of the rim, and also **not** to glue the blocks having screws, to the rim, or it will make trouble later on. In getting out the blocks for any of the last three methods described, they should be made about one-eighth inch longer than finished size, and then turned off in the lathe so as to make a good smooth surface on which to lay out the pitch circle, base circle and tooth curves, and also on which the spacing of the teeth may be done. When the blocks have been glued on and allowed to dry, the whole of the work should be put in the lathe, the ends of the teeth blocks turned off even with the edge of the rim, and the face turned down to the

required size. After this is done, a coat of yellow varnish may be put on the parts that are to form the teeth. This makes a much better surface on which to make lines than does the bare wood.

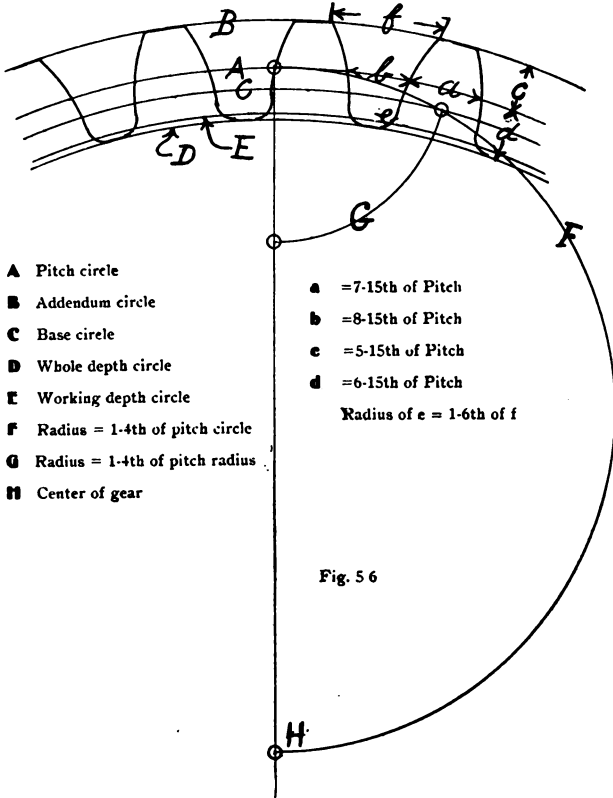

There are several ways of laying out the tooth curves on the pattern. First, however, it must be decided what method is to be used for developing these tooth curves.



These may be developed by the Epicycloidal curve, by the Odontograph, or by the Involute curve. It is not intended in this volume to enter into a discussion of the merits or demerits of any one of these systems, or even to explain them, but simply to call attention to them and to indicate one or two ways of applying them to the pattern. Theoretically, the use of the Odontograph is probably the best, especially for large work; but for comparatively small work a careful use of the dividers will give as good results, and if only single curve or involutes are desired, the use of the dividers afford the quickest way. In deciding what method of development is to be used, one or two further facts should be considered. The involute form will give uniform angular velocity if the distance between the centers of any two gears does not remain uniform, as, for instance, in the feed rolls of the common rotary knife planer. Other forms of teeth will not do this. Again, if dividers are used for marking out these forms on the pattern, the single curve is much more quickly laid out. The single curve method is fully illustrated by Fig. 60, and is what may be called a simple shop method. It can be used to advantage when the data supplied by the draftsman to the pattern-maker does not indicate any particular method.

The first thing that needs to be known is the pitch and number of teeth. Of course this was learned before building up the pattern; so all that needs now to be done is to apply this knowledge to the work. The first line to put on the work will be the pitch circle; divide this into as many equal parts as there are to be teeth in the gear; this is for the purpose of locating the center of each tooth. In doing this it will be found advantageous to commence at one side of the center of tooth block for the

trial spacing; then having the dividers set to the correct distance, start from the center of a block. Then there will not be several points to confuse one in fixing the correct one for the center of the tooth, as is likely to be the case if the centers of the blocks are used for the trial division. Now set the dividers to one-half of the tooth thickness as derived from Fig. 60 at (a); and mark a point, one each side of the teeth centers: this will locate the sides of the teeth. The base circle (C, Fig. 60) should now be put on, its diameter is found as indicated by arcs F and G. Now setting the dividers to one-fourth of the radius of gear, as at G, Fig. 60, proceed to describe tooth curves, being very careful that the arc runs through the points located for the side of the tooth on the pitch circle. The centers for these tooth curves are all on the base circle. At the points where these tooth curves intersect the addendum circle (B, Fig. 60), lines must be drawn square across the face of the pattern, and the opposite side laid out with corresponding curves, each curve starting from the point where these squared lines intersect the corner. Arcs for fillets at the base of all the teeth will now be put in, which will complete the laying out of the teeth.

The next work to be done is to saw out on a band-saw, if one is available, the wood between the teeth to form the spaces. This should be done very carefully; leave one-half of the marks on the work so that there will remain very little to be done with chisel and gouge. The fillets will have to be made with a small gouge, as the ordinary bandsaw is too wide to turn in so small a curve as is required in small or medium sized work. If a gear of coarse pitch is being made, there would be little difficulty in making the saw do most of that work also. If

the teeth were put on the rim as suggested for standard work,—that is, if only each alternate tooth is glued on, and the others fastened with screws,—then by taking out those with screws, the finishing can be done very easily; the teeth so taken out should be numbered and corresponding numbers put on the spaces, so that they may be replaced in their proper places after being finished. The temporary arms of the chuck may now be cut through, thus finishing up the work of making the rim and teeth. The shape of this rim may be more clearly seen by referring to Fig. 56A. The way of attaching the arms also is shown in this figure, as well as in Fig. 57.

The next process is to make the spider, or arms. This may be done as described in the making of the 8-inch pulley pattern, except that in this case they must be made of one thickness and fastened in as shown in Fig. 57.

As these arms are made of one thickness, one side will be turned up after the face plate is removed. This may be done in a cup chuck shown by Fig. 50, in the chapter on Turning. In this case the cup will be turned out to fit the hub already turned. The arms will be made of the same elliptical shape and in the same way as described in the case of the eight-inch pulley, Fig. 53.

#### BEVEL GEAR PATTERNS.

Before taking up the construction of bevel gear patterns, it will be well to say something about the lines required for laying them out. The first thing is to make two lines at right angles to each other, to represent the center line of the shafts on which the bevel gears are to be fastened. Bevel gears may be made to run shafts at

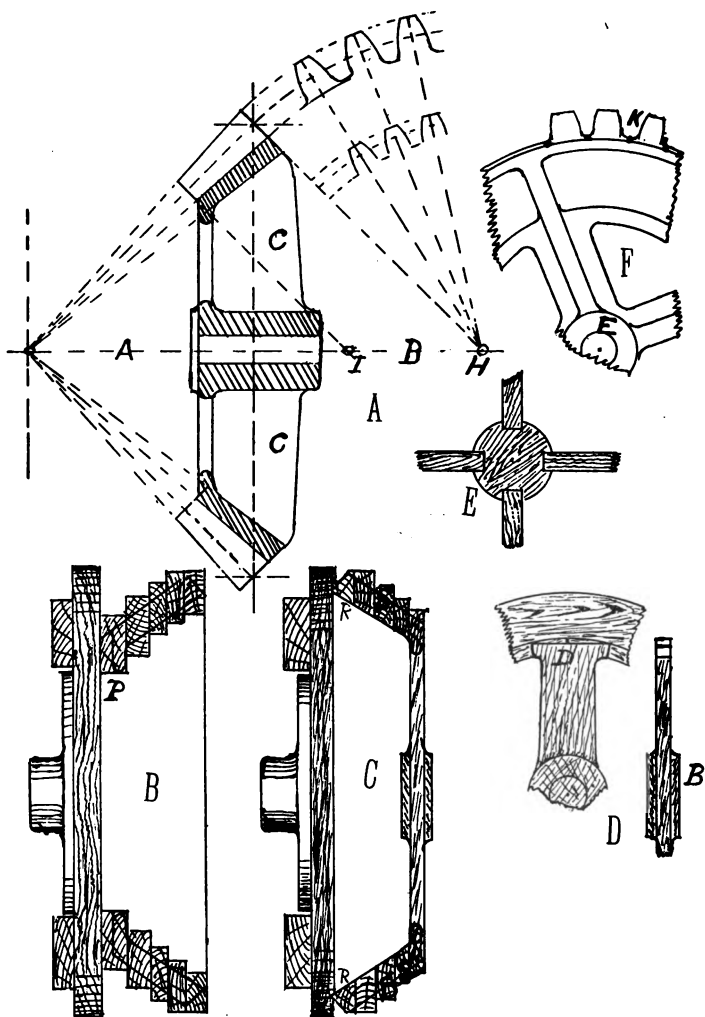

FIG. 61.

other angles than right angles; if this is required, the first two lines laid down must be drawn to this angle. The next step is to determine the size and the ratio of the pair of bevel gears to be made. The pitch diameter of a bevel gear is always measured at the large end. The pitch of the teeth is also measured and calculated for this end. Having determined on the size of the gear, set the dividers to the pitch radius of the gear and prick off this, equidistant from line A B, in Fig. 61A, which will give the pitch diameter. Now proceed by laying down the other lines in Fig. 61A. Notice that the teeth are not developed on the pitch circle, but on a projected

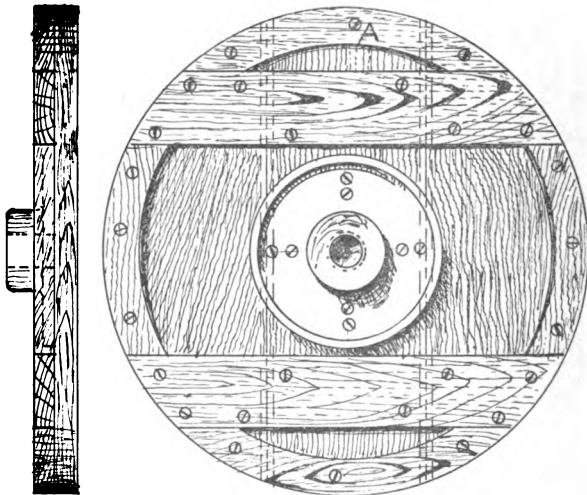

FIG. 62.

circle, the center of which is obtained by producing the line that forms the end of the teeth back until it intersects the center line of the gear at H; the small end is treated in the same way, which locates the center for

that end at I. The dimensions of tooth elements may be obtained from Fig. 60. The drawing makes it clear as to how a bevel gear should be laid out.

The building of the pattern may now be considered. The first thing to do is to select a chuck of proper size, if we have one, or make one if we have not. A chuck for this purpose may be built as shown by Fig. 62; or 63,

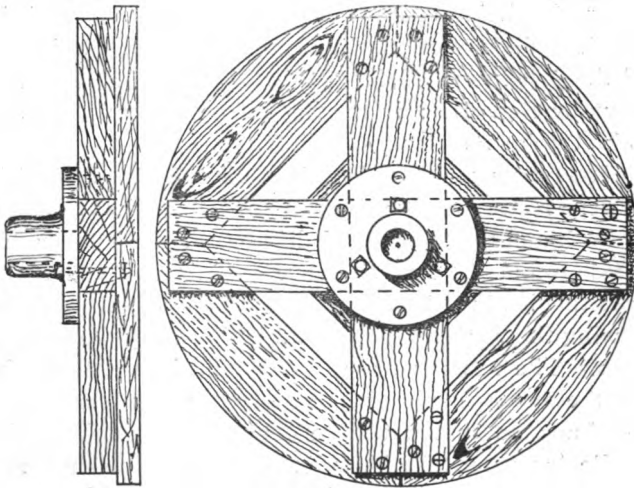

FIG. 63.

if very large. The rim at A may be left off if thought best; but its presence is an advantage if it becomes necessary to use handscrews for holding the material on the chuck during the process of gluing, for the handscrews may all be set to the same size, and so more quickly applied; this is quite an advantage, because the glue dries very quickly. The chuck will need to be faced off

to a true surface, and some fairly thick paper glued on the part where the segments for the rim are to be fastened on. With this exception, the process of building this rim will be the same as for the eight-inch pulley. The laying-out and the sawing of the cants will also be the same, except that each layer will have to be described with different radii. The necessity for this will be readily seen by consulting Fig. 61B, which shows the rim as it will appear after being built on to the chuck, and before it is turned. When there has been enough segments built on, and the glue has dried, it is ready to be turned to shape, as shown by Fig. 61B; in turning it, get around into the work at point P as far as possible.

It is now ready to be taken off the chuck, which can very readily be done by introducing a chisel between the work and the chuck, and driving it lightly at several places around the circumference. This will cause the paper that is glued between the work and chuck to split, allowing the work to come off, without any damage to either. The rim must now be mounted on the chuck, with the opposite side out. The best way to locate it on the chuck so that it will be concentric with the lathe spindle (as it must be in order that the inside and outside may be concentric), is to turn a small V-shaped groove into the chuck that will exactly fit the corner of the rim at the point marked R, Fig. 51C. The work must be fastened to the chuck this time with screws put through the chuck. To do this, bore holes through the chuck, at the bottom of the V-groove just made, of a suitable size for the screws selected. The number of screws to be used will, of course, be determined by the size of the work; from four to six will be enough for work up to three feet in diameter. Now take

the chuck off the lathe; and, having laid the rim on the bench with its proper side up, lay the chuck on it and drive the screws through the chuck into the rim. It is now ready for the lathe again, and may be turned to the size and shape indicated at points S, Fig. 61C; turn it small enough so the tooth blocks may be put on as indicated at K, Fig. 61F, and more plainly shown in Fig. 57 at C C. The arms may now be made, and mitered together in the center, with a piece on each side for strength; the same pieces also serve as fillets, as indicated at B, Fig. 61D. The arms should be set into the rims as shown at D, Fig. 61D, before the work is taken from the chuck. The vertical arms C C, with the central hub E must be left loose so it will lift with the cope. These will be built together as shown by Fig. 61E.



## CHAPTER XIII.

### PIPE FITTINGS

Another large and interesting class of patterns are those required in the manufacture of cast-iron pipe fittings, two types of which will now be taken up. The castings are what is known as a bend, shown at Fig. 64,

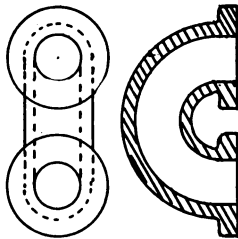

FIG. 64.

and an elbow, shown at Fig. 72. The larger part of the pattern work can be done on the lathe for both of these examples.

The pipe bend will be taken up first. The first thing is to prepare a chuck large enough in diameter; turn its face perfectly flat, and glue paper all over it.

The stock required, as illustrated by Fig. 65, must be large enough to contain the size of pattern it is proposed to build, indicated by the circle on the figure. This

should be put on the chuck in two pieces, as shown in the cut; each half has one side and one edge planed straight and at right angles to each other, as the edges are to form the joint. These must be so placed on the

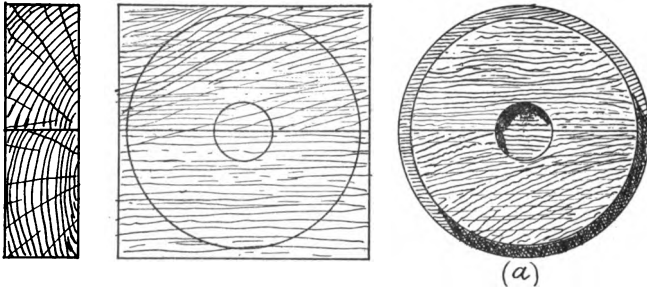

FIG. 65.

lathe that the joint shall be exactly on the center of the lathe. The best way to do this has already been explained in connection with core box ends, page 75. They are now to be turned to the shape indicated by Figs. 66. The

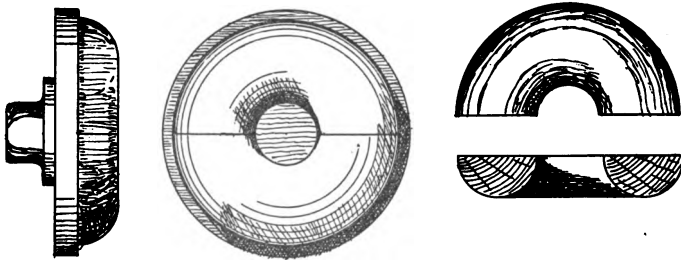

FIG. 66.

next parts to be made are those shown at Figs. 67 and 68. These must be made in halves and turned. Before

they are turned, a pattern pin should be put into each, so that it will not have to be done after the pattern is completed. It is always best to put in these pins before the turning is done. After the pieces are turned, the parts should be fitted together as shown at Fig. 69. The

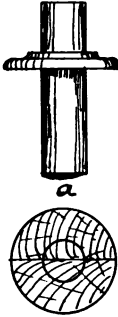

FIG. 67.

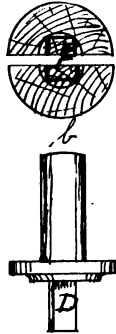

FIG. 68.

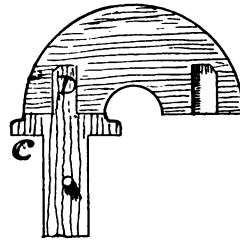

FIG. 69.

part marked (d) should be made square, as shown by E, Fig. 68. Of course, both halves are to be made in the same way. The core box for this pattern is shown at

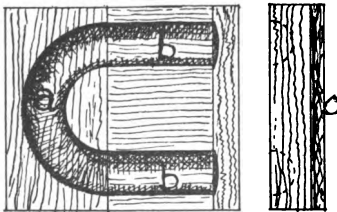

FIG. 70.

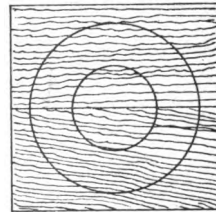

FIG. 71.

Fig. 70. The circular part (d) can be made on the lathe; the way is clearly shown at Fig. 71. The grooves

marked (b) may be made in one piece of lumber, and made, of course, with the core box plane. If it is desired to make this very strong, a piece of board is nailed on the bottom, as indicated at (c).

As elbows are usually cast in pairs to save work in

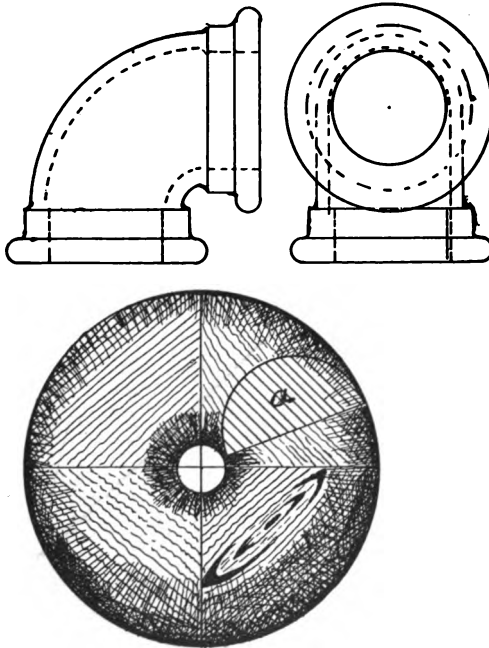

FIG. 73.

FIG. 72.

the foundry, the pattern must be made double. The economy resulting is great, as it will take but very little more of the molder's time to make the mold for both than for one. Besides the core can be more easily set and held

in place if two are made in the one mold. If only one is made, a chaplet would be needed to hold the core; or else very long prints would have to be put on the pattern, either of which would increase the work of the molder.

The pattern for the elbow is a little more complicated

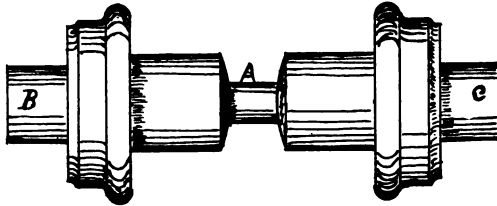

FIG. 74.

than for the bend, though the work is quite similar in character to that of the last pattern. It is made as follows: A ring, as shown at Fig. 73, is first turned, with its cross section as indicated at (a). The best way to make this is to get out four pieces with the grain as indicated

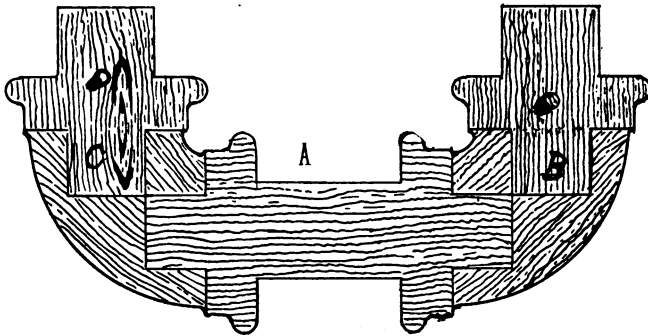

FIG. 75.

in the figure; that is, the chord of the curve should be parallel with the grain of the wood. Fit them together very accurately, and glue them to a chuck (but not to

each other) that has been previously covered with paper, and turn them to the required shape. A solid piece may be used and cut into the required number of pieces after being turned, but this method is not as good. In mounting these pieces on the chuck, care should be taken to see that the point where they meet is exactly on the center of the lathe. Now two pieces are required like Fig. 74. These will be made in halves and turned. Both will be

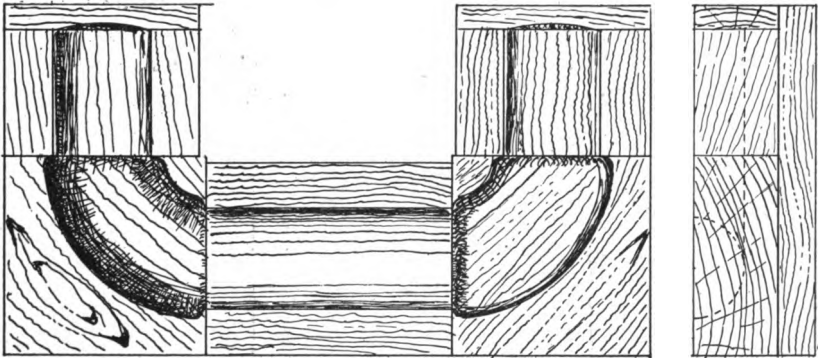

FIG. 76.

alike, except that on one the shape at A will be left the full size and of a length to equal A in Fig. 75. The one made like the figure will be cut in two, the parts B and C squared as at E, Fig. 69; it is fitted into the first piece as shown at B and C, Fig. 75.

The core box to go with this pattern is shown at Fig. 76. The circular parts A and B can, of course, be made on the lathe in the same way as for the core box shown at Fig. 70.

## CHAPTER XIV.

### MISCELLANEOUS EXAMPLES

Fig. 78 shows a good method of building patterns that are flat, square, or rectangular, and of comparatively thin cross section. The casting required is shown by Fig. 77. It is a common form of steam chest cover. In

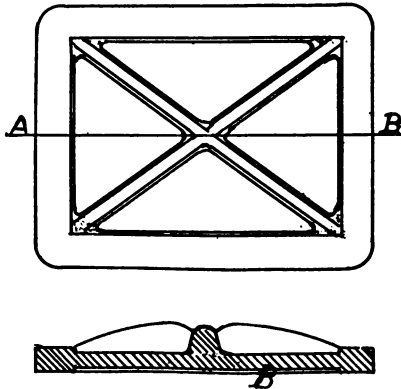

FIG. 77.

building the pattern, the central part is made up of narrow strips set into a groove in the outside pieces; these are mitered together and tongues driven into grooves as shown by dotted lines at A, Fig. 78. The diagonal ribs made and halved together and then cut to the shape

shown. They should be left loose and pinned in place with pattern pins, so that the molder may take them off in order to lay the pattern flat on the molding board during the first operation in molding. This is necessary, as in order to have the side B good and sound, it must be cast with that side down; then the ribs will come in the cope.

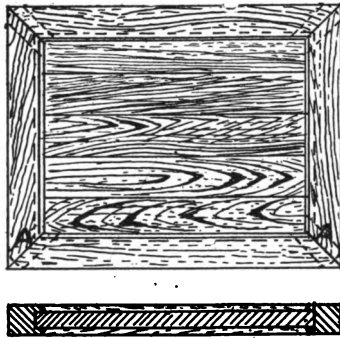

FIG. 78.

## SKELETON PATTERNS

The term "skeleton patterns" embraces a large variety of patterns; it refers to those that are made of a combination of wood and sand; that is, both wood and sand are used to form the complete pattern. The pattern-maker constructs the required woodwork, and the molder makes the rest of the pattern with sand. The sand commonly used for this class of work is called **loam**.

One example of this class of patterns is shown by Fig. 79. It is a skeleton pattern of a pipe bend, from which only one or two castings are wanted. The drawings give a good idea of the general make-up of the pattern.



The core and method of making it are shown at Fig. 80. The parts the pattern-maker would have to make in order that the core-maker could produce this core, are the core board, as it is called, indicated by (b) and the

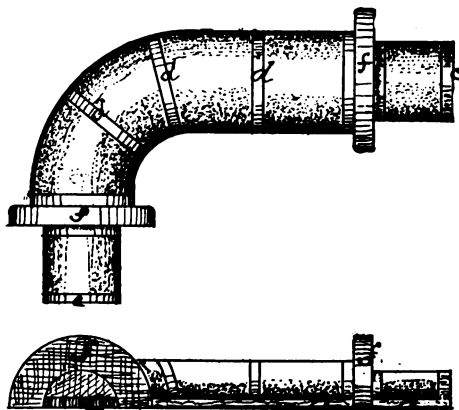

FIG. 79.

strickle shown at (c) in Fig. 80. The core board is simply a piece of board planed up true on both sides, and cut to

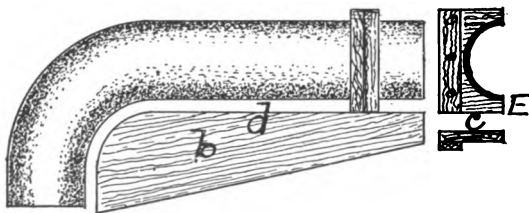

FIG. 80.

the correct shape. Its side (d) is cut in such a way that when the strickle is set at right angles to it and slid along

its length, it will give the desired size and shape to the core. When the molder uses this apparatus, he first lays this prepared core board on an iron plate, and clamps or fastens it down so it cannot move. He piles on some sand and then slides the strickle along so that the point (E) remains in contact with edge (d), taking care to keep it perpendicular to the straight part, and to keep the cutting edge exactly radial in passing along the curved part. If there is any point on the sand that the strickle does not touch, more sand is put on and the strickle again passed over it. This process is continued until a good smooth surface is produced. The core board is now removed, and the plate with the complete half core on it set into the core oven to be baked. To make the other half, the core board is turned over and the process repeated. These two halves are baked, and, when hard, are pasted together, so forming the complete core. The making of the pattern is carried out in a very similar way, but requires more work on the part of the pattern-maker. The first thing is to prepare two boards of suitable thickness for the job; this is determined by the size of the pattern to be made. One of these boards is shown at (a) Fig. 79. They will be sawn out to the shape of the pipe on its axial line, including the core prints.

These boards are pinned together the same as would be done if a complete wooden pattern was to be made. The flanges (f f) are also to be cut out so that they will fit over the board at the correct points. The semicircular pieces (d d) are also cut out and fastened on at equal distances, and also for the core prints (c c). Two strickles will be needed, similar to the one used for making the core, Fig. 80 (c), one for the body of the pat-

tern, and one for the prints. The molder completes the pattern by laying down one of these boards on the bench, with the pieces all fastened in place, puts on sand, filling up the spaces, and then passes the strickle over it, thus making a smooth surface the same as for the core. The other half is made the same way. When the pattern is complete the molder scatters parting sand all over it so it will leave the mold freely.

Another class of skeleton patterns is illustrated by Fig. 81. It represents a pattern for a curved cast-iron

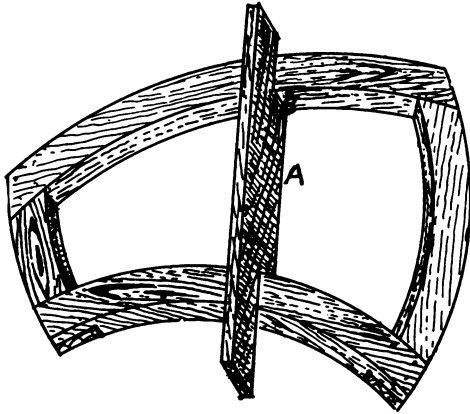

FIG. 81.

plate, over which a blacksmith or boiler-maker may bend or form a plate of wrought iron or steel. Instead of making a complete pattern, which would be a slow and expensive process, a frame is made as shown, and halved together at the corners. The rest of the pattern will be made by the molder, with the strickle, shown at A in the figure. Flat plates of large area may be made in this

way, that is, with the open frame and strickles, thereby saving lumber and also a large amount of pattern work. A pattern of this kind may be molded by first bedding the frame in the nowel, or if too large for that, in the floor. Then fill the inside with sand, and strike it off even with the top; put on parting sand and then ram up the cope. Lift off and set to one side. With a strickle cut like A, Fig. 81, with shoulder B the same depth as the thickness of the plate, cut out the sand to that depth. Now take out the frame or pattern, and there is left a cavity in the sand of the size and thickness of the required casting.

#### GLUING FEATHER-EDGE BOARD

In building some large patterns it becomes necessary to glue on what may be called a **feather-edged** piece of wood, in order to make a shape something like Fig. 82.

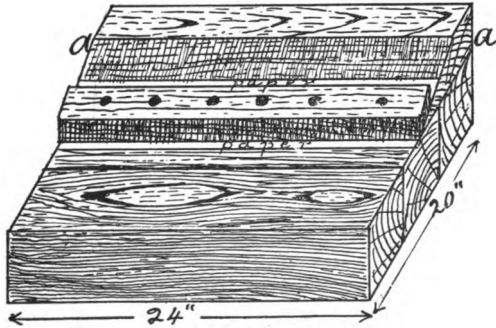

FIG. 82.

This cannot well be made with solid wood on account of the difficulty of guiding a rebate plane along

the obtuse angle, without the corner of the iron cutting into the other side. The best way of overcoming this difficulty is to use the method as shown at Fig. 82. But this introduces another problem. How can the feather-edge be glued on and still be smooth, without a subsequent planing? Of course the trouble comes from the fact that a thin piece of wood on being made wet with glue, will, unless held in some way, warp and curl all out of shape while drying. A way of overcoming this difficulty will now be described. After having prepared both pieces to the shape indicated in the figure, get out a strip of wood about one-half inch by one inch, and long enough to extend the whole length of the piece to be glued; drive a number of brads through it about six inches apart. This strip must exactly fit the whole length. Now prepare a piece or pieces of good paper about one and a half to two inches wide, and long enough to extend the whole length. Apply the glue to the feather-edge piece, put it in place, and tack it with a brad or two so that it will not slip around out of place. Then lay the paper on top of the thin feather-edge of the piece being glued on, and lay on the strip of wood so that one edge comes exactly along and even with the thin edge; then drive the brads down, which will pull down the thin edge into place. Examine the feather-edge to see that it is down tight to the other piece. If any spots are found that are not in contact, put in another nail at that place; if this does not bring it down to place, drive a sliver of wood under the strip and on top of the paper. The paper is employed in this case to prevent the strip from sticking to the work, if by chance some glue should get on to the upper side of the thin edge. Moreover, if the edge is very thin, the glue is very likely to ooze through the

pores of the wood and thus glue the strip to the work, and when it was taken off, it would tear up some of the wood and make it rough. By interposing the paper, this is prevented.

The work should now be allowed to stand for several hours, or until the glue is thoroughly dry. If the strip be now removed, it will be found that the feather-edge has become practically one piece with the other, and all that is needed to finish the job is to sandpaper the surface.

#### LARGE LATHE CHUCKS

The method of building a chuck shown at Fig. 62, on page 122, is very good for one of twelve to twenty inches in diameter; but larger ones should be built as illustrated by Fig. 63, on page 123. Of course the size will determine the number of arms required; for chucks up to four feet in diameter, four arms of two inches by six inches in cross section would be suitable; if larger than that, it would be preferable to use more arms, so that the segmental pieces joining the arms need not be so long or wide. In building all these chucks, each piece of corresponding shape and position should be of the same size and weight as nearly as possible, so that the chuck will be accurately balanced; otherwise, it will be impossible to do good work, and besides, an extra strain will be put on the lathe, which may cause an accident. If, after building a chuck, it is found to be out of balance, it can be balanced by fastening a block of wood to the back on the light side.

#### LUGS OR PROJECTIONS FOR MACHINISTS' USE

Some castings must have special parts cast on them which serve the purpose of holding them in a

machine while they are being worked upon, but are usually cut off after the machine work is completed. These parts it is the pattern-maker's business to provide for on the pattern. One form of such a casting is a piston ring shown at Fig. 83. The pattern for this should be

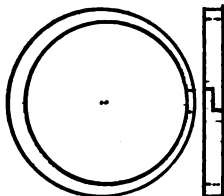

FIG. 83



FIG. 84

made large enough so that two to four rings may be made from the same casting, leaving plenty of stock for finish. A good allowance for this is about one-fourth inch on each surface. The reason for this extra allowance is that these rings being comparatively small in cross section, the metal must be very clean and sound to give the required strength. As the surface of castings is usually more or less porous, it is necessary to turn off this outside part in order to get down to the more solid metal on the inside. The pattern for a piston ring of this size should be made as represented by Fig. 84. The projections, c, c, c, called lugs, are for the purpose of bolting the casting to the lathe chuck while the rings are being turned. This is the usual form in which piston ring castings are sent to the machine shop and is the best way for this particular job. If these lugs are not provided, the machinist has to grip the casting in a chuck;

this is liable to spring it, so that the resulting rings will not be true, as they must be, to fit the cylinder. Another way of providing for the convenience of the machinist is illustrated by Fig. 85. Two different methods are illus-

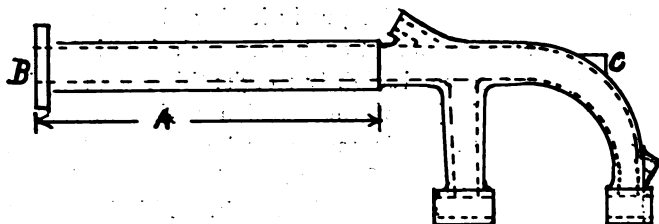

FIG. 85.

trated here—one being on the outside of the casting, the other on the inside. This casting is the column for a small drill press. It is finished the whole of the distance A, so it will have to be mounted in the lathe between centers. In order that this may be done, there will have to be a boss cast on at C and a bar cast in across the round opening at B. This latter need not be cut out, as it will be entirely hid and out of the way in the completed machine. The boss at C may be cut off or allowed to remain to suit the fancy of the designer. These are examples of simple contrivances to accommodate the machinist.

#### FINISHING PATTERNS

After the woodwork of the pattern is completed it must be "finished" by the application of one or more coats of varnish, all small holes or other defects in the material and workmanship filled with beeswax and the whole surface made smooth so that it will draw easily.

This is usually done in the following manner: The



dust from sandpapering is all cleaned off with either brush or waste and then a coat of moderately thick varnish is evenly applied. When this is dry all nail-holes and any defects in material are filled with beeswax; if any wax fillets are to be put in it should also be done at this stage. As this first coat of varnish dries it leaves the surface of the wood slightly rough; this is caused by the wetting and drying of the varnish which raises the grain of the wood. This may now be smoothed down by sandpapering it with fine and partly worn sandpaper until it becomes smooth to the touch. This is all that needs to be done if the pattern is to be used but once or twice. If it is to be used frequently one or two more coats should be applied. For a permanent finish, several thin coats will give better results than one or two thick ones, and will also make a better appearance. To make a very nice finish each coat should be rubbed smooth with fine sandpaper before applying the next. When patterns become rough from use in the foundry, or from any cause, they should be cleaned and refinished, for if a pattern is smooth and well finished it will give the molder little trouble and hence will not receive such hard usage. If a pattern is rough the molder must rap and jar it considerable in order to draw it, and such treatment always injures wood patterns. In finishing patterns a varnish differing in color from that used for the body of the pattern should be put on all core prints, so that the molder can tell at once the general position the cores will occupy in the mold.

#### LOOSE PIECES

It is almost impossible to make some patterns without **loose pieces**, however objectionable they may be.

They are, however, in some cases at least, preferable to cores. When a choice must be made between a core and a loose piece the latter should generally be chosen, as it will insure a truer casting. These loose pieces are usually held in place on the pattern during the process of molding by skewers or draw pins. Brads of suitable size

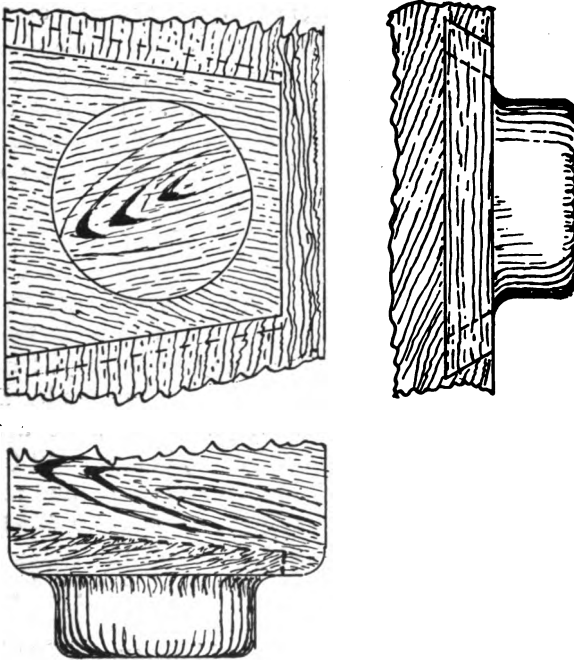

Fig. 86.

for the job in hand and bent to a right angle near the head make good draw pins. In some cases it is better to fit these loose pieces to the pattern with dovetails,

because when so fitted they are less liable to be pushed out of place by the molder in ramming the sand around them. Another reason is that the molder does not have to stop and take out any skewers, but can go right on until the mold is all rammed up. In fact no notice need be taken of the loose pieces until after the main part of the pattern has been pulled. The best way to fit these dovetail pieces is to bevel them on the edges, and also in their thickness as shown in Fig. 86. They should be fitted very accurately as, if they are not, they are very liable to stick when drawing the pattern. The fact that they are beveled in both directions as suggested above and shown in the cut will almost always insure them against sticking.

#### STANDARD PATTERNS

Standard patterns made of wood, and often used, should be made as durable as it is possible to make them, using hard wood, such as Mahogany or Cherry, for all the parts that come in direct contact with the sand. For all parted patterns metal pattern pins should be used, brass being the best. The first cost is more, but time and labor required for applying them is less, and most important of all; they never stick, if properly fitted at first, so that in the "long run" they are the cheapest; and standard patterns are usually made for the "long run."

Rapping and draw plates should always be fitted to all standard patterns, as they will save their cost in repair work in a very short time, to say nothing about the convenience of the molder. There are several kinds of these plates on the market at very reasonable prices. For anything except very large patterns, plates combining both

rapping and drawing holes are the best. The rapping holes in these plates are simply drilled, drawing or lifting holes are taped to fit some standard screw thread. Another method of preparing standard patterns for the foundry is to fit them to a **follow board**. This is almost always done when a large number of castings are wanted off from a pattern that requires an irregular parting, or if the pattern is thin in cross section and is liable to be injured by ramming the sand around it. The cope side of the pattern is fitted to the top side of the board down to where the molder will make his parting, and the board cut to such a shape as will form the parting. This follow board is used the same as a turn over or mold-board in molding a simple pattern.

#### STOVE PATTERN-MAKING

The fundamental ideas underlying the making of patterns for stove castings are practically the same as for machinery pattern-making; but on account of the shape and generally delicate character of the castings required, the methods of their production are in many respects quite different. The drawings furnished the stove pattern-maker are also radically different from those sent to the maker of machinery patterns. Generally a new design of a stove is first developed by making a drawing, and, at the same time, a model is also worked out in wax or clay, and in some cases a complete model is made of wood.

This gives the designer the opportunity of comparing curves and other ornamental features of the finished stove which is impossible from drawings alone, and enables him to see how it will be best to have the different parts fit each other at the many joints necessary. This

is especially advantageous in the case of artistic heating stoves, on which there is usually a large amount of carving. A model, however, is not generally made in the case of plain work, such as cook stoves or ranges, these being carried through from drawings alone. There are also several tools that are used by the stove pattern-maker that are not used by others. These are made necessary by the requirements of the art; one of which is that the castings, and therefore the patterns, must generally be of uniform thickness, and comparatively thin in cross section, usually not exceeding one-tenth of an inch.

Almost all machinery pattern drawings are made and all dimensions given in finished sizes so they may be used in the machine shop as well as in the pattern shop. Stove pattern drawings seldom go farther than the pattern shop. They are usually made full size and in some cases at least, the dimensions are not marked on them, so that the pattern-maker must take the sizes directly from the drawing by measuring it, and this is usually done with trams and applied to the shrink rule to be used. The plan is first drawn and then the elevations or side views are drawn in, usually on the same paper so that the lines of each view are all mixed up, which makes the reading of them very difficult for those unfamiliar with this kind of work. Sometimes the lines of these different views are made with different colors, so as to be the more easily read. The same shrink rule to be used in making the original patterns is used by the draftsman in making these drawings.

The stove wood pattern-maker is provided with from five to seven different shrink rules; the one to be used for any given pattern is determined by the kind of metal of which the master pattern is to be made and also

the method of producing it. These rules are spoken of as one shrink, two shrink, or one and a half shrink according to the ratio of the rule to the standard rule. The word "shrink" in this instance meaning the general amount allowed in making machinery patterns, viz: one-eighth inch. Which one of these is to be used is determined by the material to be used in the production of the master pattern.

Because of the necessity of beveling the edges of all stove plates where they come together, and to have these bevels uniform throughout the stove, it has been found advantageous by stove pattern-makers to have a set of "bevel gauges" for measuring and laying out these bevels. Such a set of bevel gauges was originated by Mr. N. Vedder, formerly a stove designer of Troy, N. Y., and which have come into extensive use among stove manufacturers during the last few years. In order that these gauges may be convenient for use, they are made of thin wood or metal similar to the triangles used in making mechanical drawings. There are eight of these bevels in use ranging from one of about  $2^{\circ}$  to that of  $30^{\circ}$ , which is the largest angle used. These are numbered as follows: From two degrees to eight degrees are four bevels numbered by ciphers, two degrees being designated by 0000, the next by 000, the next by 00, and the next by 0, which is eight degrees. The other four bevels are designated by the numerals 1, 2, 3, 4, number one being an angle of  $10^{\circ}$ , number two,  $16\frac{2}{3}^{\circ}$ , number three,  $23\frac{1}{3}^{\circ}$ , and number four,  $30^{\circ}$ . As in a large part of stove patterns it is necessary to make them of curved outline, and as these curves cannot very well be marked out with trams, a set of standard curves have been adopted. These are used by having them made up of thin wood or

metal (metal being best) so they may be used in the same way as the bevel gauges. These are likewise used by both draftsman and pattern-maker.

It sometimes becomes necessary to make a center line across a carved or other uneven surface. For this purpose a simple contrivance known as a "vertical plumb" has been devised. It consists of two boards fastened together lengthwise at their edges and at right angles to each other. This must be set up on two parallel blocks of such a height as will raise it above a pattern or other object on which it is required to make a straight line across the uneven surface. A scribe with which to make the mark is also needed. This consists of a thin flat piece of wood on which is fastened a thin plate of steel sharpened to a keen cutting edge.

Stove patterns must be carved very thin and made of uniform thickness throughout. If they are not the castings will not be of even thickness, so that one part will cool more rapidly than others, thereby causing them to warp and sometimes to crack from the shrinkage strains. To insure that the patterns are of uniform thickness, a special form of calipers are used for measuring their thickness. These calipers are made with a loose joint something like a pair of shears. Just at the back of these shear-like handles are short projections, through one of which a screw is put, the end of the screw abutting against the other. The points of the caliper may be set to a definite distance apart, the above screw turned in until its end comes in contact with the other projection mentioned. The calipers may now be opened and passed over any intervening thick part of a pattern and the points closed again to the same distance as before. Now if the screw does not touch, or come to

a bearing, the pattern is too thick at that point and must be pared down. Most stove plate work is very uneven on the surface on account of the carving and other ornamental work. In order that the pattern may be of equal thickness it has to be "backed out," as it is called, that is, it has to be carved out on the back to conform to the shape of the carving on the front. This makes it necessary that the outlines of the carving be transferred to the back. This is most easily and accurately done by the use of what are known as "marking calipers." These are usually made of hard wood and similar in shape to the ordinary wing caliper that is hinged together at the end of what may be called the handle. One leg is provided with a steel point, the other with a pencil point. A spring is set in between the two parts of the handle that tends to open the points, so that in order to bring the points together this spring must be compressed. By following the outline of the carving with the steel point, and at the same time compressing the spring and keeping the pencil point in contact with the back of the pattern, the outline may be accurately and rapidly transferred to that side. Many parts of stove patterns have to be joined on an angle, and as the stock is generally very thin, it is quite difficult to joint the edges to the correct angles, therefore it is necessary that some device be provided for holding the stock in fixed position with regard to the plane. For this purpose some form of shoot board is found useful. One form of shoot board is represented by Fig. 54 on page 96. For stove pattern work, however, it must be more complicated than is this, as it is necessary that it be adjustable to several different angles, and be set accurately to any given angle within its limits. As a large amount of carving is necessary in stove-



pattern-making which cannot be done with the chisels and gouges of the ordinary pattern-maker's outfit, the stove pattern-maker is provided with a series of carving tools, usually about twenty in number. In large establishments making stove-patterns, the carving is usually done by men especially skilled in that work, and in some cases stove-patterns pass through the hands of several men, each doing his own special kind of work. A large quantity of very thin stock, some of which is less than one-twelfth inch in thickness is required for this class of patterns. As this cannot very well be made on the ordinary planer without some special attachment a suitable one is provided for the planer in stove pattern shops with which thin boards may be planed smoothly and to a uniform thickness.

Almost all machinery patterns are fairly thick and stiff enough of themselves for the purpose of molding; moreover, in the production of this class of patterns, the application of the principles of joinery is an important part. Stove patterns are usually very thin, and practically of uniform thickness throughout and therefore require special treatment. Stove patterns are rarely stiff enough of themselves for the purposes of molding and must be supported by what is called a "match" during the process of molding to produce the metal patterns. The match is very frequently made first and the pattern made or built on it. In many cases these patterns are very intricate having quite a large amount of carving on them.

Because of these many facts, stove pattern-making differs considerably from ordinary pattern-making and is a distinct branch of the art. The original pattern for stove work is usually made of wood; in some shops,

however, original patterns are sometimes modeled in clay or plaster-of-Paris. From this original pattern a master pattern is made of iron. For this purpose, however, some foundries use a white metal alloy consisting of nine parts lead and one part antimony, which has a shrinkage of one-sixteenth inch per foot. This is preserved and from this the pattern to be used in the production of the castings for the stoves is made. The original wood patterns are rarely kept as they are sure to change their form. There are several distinct processes used in making stove-patterns, but on account of space they cannot be described and will for that reason be just barely mentioned. One of these is what is known as the "carving and backing out wooden patterns." This is the simplest, and means that the pattern is carved out of wood to the exact shape and thickness. For a small pattern, like a stove leg for instance, this would be all that is necessary from which to make the mold for the master pattern. For large patterns in this process, however, a match or follow board must be made to support the pattern while ramming up the nowel. Another distinct process is the "wax process." This is used to avoid backing out the wooden pattern. Considerable practice or experience is necessary to work this method successfully. Then there is the "carving and blocking" process, in which the molder surrounds the pattern with a thin layer of blocking just the thickness of the required casting, when ramming up the drag. In all these processes the block of wood used for the pattern is "built up" of thin pieces of wood, so as to reduce the effects of shrinking and swelling to the minimum. In many stove patterns allowance has to be made for the warping of the casting. This is usually done by preparing a special

form of mold board which is curved so as to give the required curve to the pattern, as it is built on to and over the mold board. This is necessary because a casting made from a straight pattern often comes out warped or bent so that it is necessary to bend the pattern in the opposite direction, so that the casting will come out straight.

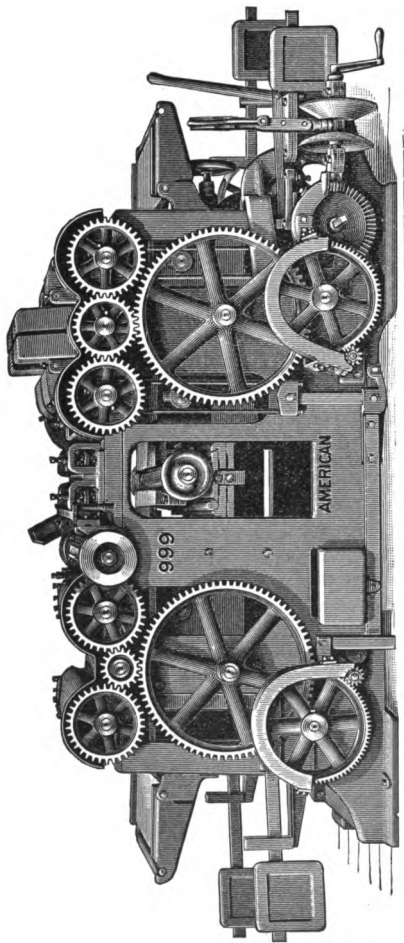

*"Rogers'" 30"x12" Double Surfacer.*

# Appendix

---

## READING MECHANICAL (WORKING) DRAWINGS

Mechanical drawing has been defined as the universal "language of the engineer." A drawing made in one country can be read and worked to in another, that is, the drawing proper. Notes on the drawing in the language of a country could not be read except by one acquainted with its language; and, the unit of measurement also might be different, but the main idea represented by the drawing would be readily apprehended.

One who desires to read working drawings and get from them the information they are intended to convey, must know something of the principles underlying their construction, and the conventionalities used. All working drawings are made on the principle of orthographic projection, usually spoken of simply as **projection** drawings. That is, all the imaginary lines of sight, (projectors), are parallel, and perpendicular to the picture plane. There are three principal **views**, or elevations, as they are called, used in the representation of objects by drawings, viz.: the **plan**, or **top view**, and **end** or **side view**, called in descriptive geometry the three planes of projection. It is sometimes necessary to introduce a **fourth view**, which becomes a **second end or side view**. Each of these views is drawn so as to represent the different sides of the object at right angles to each other. When some parts of an object extend at an angle other than a right angle,

---

auxiliary views are projected on the center lines of these angular parts, in order to show their true shape. In the representation of simple or symmetrical objects, one view is omitted, usually the plan, as it is not necessary. Many objects or parts of machinery, (with which the pattern-maker has most to do), can be represented with sufficient clearness by two views. When these do not clearly delineate the object, the third, and if necessary a fourth is used.

The obscured parts of a simple object, that is, parts that do not appear on the surface represented, are shown by broken lines. In complicated objects this is not practicable because of the many lines that become necessary, which would be confusing and lead to mistakes. When for this reason this method of broken lines is not feasible, it is customary to imagine the object cut, or that an assumed plane has been passed through it, and the surface thus produced exposed. A drawing of such a surface is called a **section**, and indicates the shape of a piece at the place cut by an imaginary plane. A piece of varying section may be cut by planes at as many places as is desired, and the section shown at each. Complete sectional views show not only the parts cut by this assumed plane, but also any other parts of the object which may be seen beyond. Such sectional views are usually made by passing a plane through the line of centers, or other line of symmetry. To indicate the cut surface of a section it is filled with uniformly spaced diagonal lines. This is called **cross-hatching**. Different pieces of material appearing in the same section are indicated by the lines running in different directions. Different materials are indicated by using different kinds or grouping of lines. An incomplete section shows the

objects partly in full elevation, and partly in sectional elevation. Such drawings are also called broken drawings. Long, symmetrical parts, as a piece of shafting, may be shown by making drawings of the ends close together with the middle portion broken out. These are also called broken drawings, and are used to save space or to get a long piece on a small sheet.

Various arrangements of views on a drawing are possible, each of which will be equally effective in conveying the necessary information. Attempts have been made to establish uniformity of practice in this respect, without effect, for the reason that such a vast variety of forms are encountered, and difficulties of execution are met in practical work, that in general it is not possible to follow any cut and dried rules. When making drawings for use in engineering construction, especially for workshop use, that draftsman is the best one who can convey the necessary information with the least expenditure of time and labor spent in making the drawing, consistent with neatness of execution and accuracy of dimensions. About three things must be kept in mind in making or interpreting a drawing.

First—Each view of the part of machine or structure represented must be a projection of the adjacent view of the same object.

Second—It must be clear which end or side view is shown in the adjacent view, whether it is the end or side nearest the adjacent view, or the one farthest from it.

Third—In the case of unsymmetrical parts it is necessary to be sure whether the piece to be made is "Right hand" or "Left hand."

These last are shop terms that have originated in practice, and may be illustrated by considering a photo-

graph and its negative. An object appearing on the right side of the photograph will appear on the left side of the negative, and the whole picture is reversed. Suppose the pattern being made is curved on one side and straight on the other, we must be sure which side is straight and which curved.

A good general method of procedure in reading a working drawing is as follows: First, ignore for the time being the dimensions and dimension lines entirely until an idea is obtained and fixed in the mind of the general shape of the object. Second, referring to the several

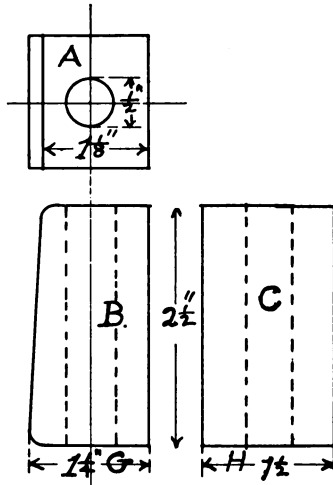

FIG. 1 (d)

views, notice if its outline is to be a cylinder, a cube, a cone, etc., or a combination of several of these elementary forms. This being clearly impressed on the mind,



observe how it is modified by details, and, always referring to the several views, determine whether they project from the main body, or are recesses or holes. Finally form an idea of the relative sizes of the component parts by referring to the dimensions. Pay strict regard to all conventional representations that have been used.

At Fig. 1 (d) is shown how the views are usually arranged when three views of an object are given. This arrangement may be modified when some other will better convey the meaning. If still another view was thought necessary to represent the object as it would appear when looking at its left side it would be located at the left of the front view; this would be called the left side view. In the drawing, "A" is the plan or top view, "B" is the front view, and "C" is the right side view. These names are purely arbitrary and are used only as conventionalities, as any side of the object may be assumed as the front view except when the object has a natural base, as a table, or a machine, etc. Then the top view would be a drawing of the top side of the machine as it stood in its normal position, that is, on its natural base.

One good way of determining the shape of an object from a drawing is to imagine the paper on which the drawing is made to be bent on a line somewhere between two of the views until the surfaces are perpendicular to each other, or actually bending the paper with the drawing on it in this manner, then imagine some object that if projected on the two planes would give outlines like the ones shown on the drawing, treating sectional views in the same manner as full views.

On page 159 is introduced a working drawing of the headstock of a lathe. It illustrates several of the pre-

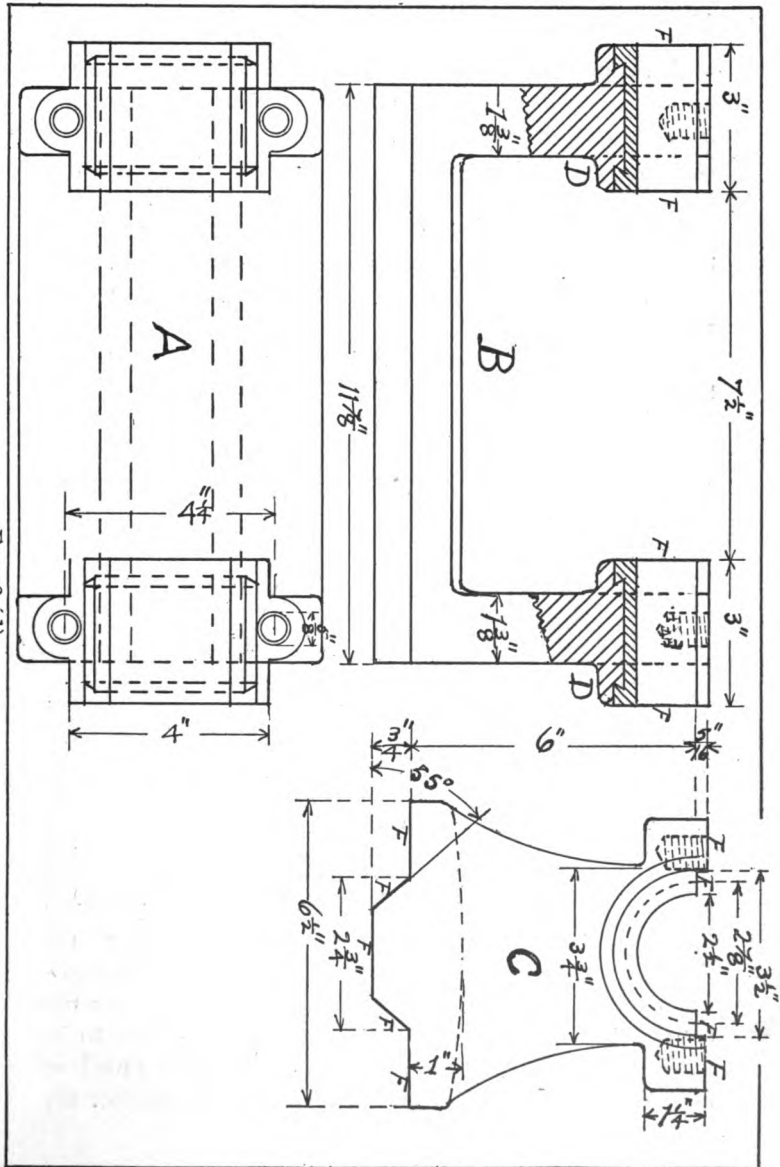

FIG. 2 (d).

viously mentioned conventions. One of these is the arrangement of the views, which is different from that of Fig. 1 (d). In Fig. 2 (d), the plan, (A) is below the front view (B), therefore the front view shows the side of the plan that is the farthest from it. In Fig. 1 this is reversed; but this does not interfere with the interpretation of either, as when any one of the views is studied with relation to the others the form of the object can be readily imagined.

What is known as a "broken drawing" is also illustrated in this figure at D and D. In this case one-half

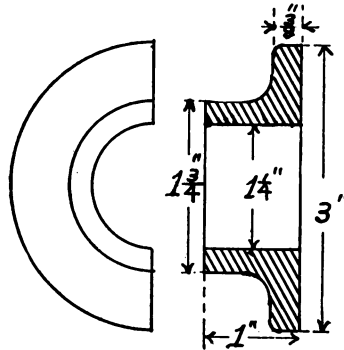

FIG. 3 (d)

of the object is supposed to be broken away, and a view given as the object appears at that point after its removal; this makes it easily understood as to the desired shape. Another convention illustrated is the method of indicating which surfaces are to be machined. It is by the use of the letter F, placed on or near the surface to be machined or finished. One method, (broken lines) of indicating the location and size of tapped holes for the

reception of bolts is also shown in the center of each bearing. Fig. 3 (d) shows one way of representing simple circular objects that is used quite frequently in machine drawings. The sectional view is a complete section.

#### LUMBER

Lumber is produced by sawing trunks of trees lengthwise into planks or boards of commercial sizes. In order to produce special sizes and shapes, the sawing is done in several different directions without regard to the grain of the wood. There are, however, two general directions or methods used, by one or the other of which the larger part of all lumber is produced. One of these is called **straight** or **bastard** sawing; the other **quarter** sawing. Straight sawn lumber, sometimes called "rift sawn," is produced by passing the saw through and through the log, without any regard to the grain. Quarter-sawn lumber is made by passing the saw through the log approximately parallel with the medullary rays, or radially with the log. There are several ways of doing this, one of which is as follows: The log is first squared and then sawn into four quarters. Each one of these is set on the carriage of the sawing machine so that the saw will pass through it diagonally. The sides of the center board will then be parallel with the medullary ray. This method gave rise to the term "quarter sawn." The larger part of the lumber produced is made by the first method. The last is very wasteful of timber, and the product is therefore much more expensive.

If the trunk of a tree is cut transversely, it is found to be composed of a series of concentric cylindrical layers, the cross sections of which form rings that are quite

distinct from each other. These layers are formed, one each year during the period of the tree's growth. They vary in thickness in different kinds of wood, and in different specimens of the same kind. They also vary in density and color; the more dense or hard are always found near the heart. These variations are due to the difference in rapidity of growth, length of season, and other circumstances that may change from year to year. The location and soil in which the tree grew also modifies to a degree the above characteristics of these layers. It is these layers of woody fiber that give to boards the appearance called "the grain." This appearance varies according to the position the board occupied in the log. The part of the wood next to the bark is called "sap wood"; all on the inside of this is called "heart wood." Heart wood is generally more dense, of a darker color, and is much more durable than sap wood. During favorable weather the sap of the tree circulates through the sap wood, but during the winter it is supposed to cease; it is this period of non-circulation of sap that causes the distinct lines that appear between successive annual rings. The darker color and greater density of heart wood is caused by the closing up of its cells by the gums of the wood that were previously held in solution; for this reason it is nearly or quite impervious to sap. There is a difference in the proportion of sap wood in different kinds of trees, and in different individuals of the same species. The slower growing trees usually have the least.

For a tree to afford the best quality of lumber it should not be cut until it has arrived at maturity. The oak is said to reach this period in about 100 years, the pine in 70 to 100 years, and ash and elm at from 50 to

100 years. Midwinter or midsummer are the seasons of the year best adapted for the felling of timber to secure the best quality of lumber. The principal reason for this is the fact that at these seasons the trunk of the tree contains less sap than at others.

Seasoning lumber is **driving out the water** from its pores. This may be done by natural or artificial means. However it is done it should be a slow process, especially in its first stages, therefore, natural, or air seasoning, gives the best results. For any purpose where strength or permanence of form is very desirable, it is best to properly "stick up" the lumber in a seasoning shed that will protect it from the sun, rain, and snow, for at least one year, and then put it in a drying kiln to complete the process. If lumber is put into the kiln when green, the water is driven out so rapidly by the high temperature that it carries with it more or less of the gums of the wood. This is prevented by "sticking up" in the shed, as during the time it is under these natural conditions the process is comparatively very slow. All these gums should be retained, if possible, as they add strength and density to the lumber, and the more dense wood is, other things being equal, the more permanent will be its form under varying conditions of the humidity and the temperature of the surrounding atmosphere. Conversely, then, if these gums are driven out during the process of seasoning, the wood is not as strong, and is more porous, also, and will therefore absorb and give off moisture more readily, which will interfere with its permanence of form. Lumber cannot be so well seasoned as not to shrink when placed in a dryer atmosphere.

If wood is placed in **air** that is quite dried of its moisture, it will continue to retain a portion of its

original moisture. A log taken from a freshly cut tree (green) contains about 50 per cent, by weight, of water. (The sap wood contains more than this percentage, the heart wood less). When the log (stripped of its bark), is allowed to remain in the open air, more than half of this water will evaporate in a few months. If it is sawn into lumber and "stuck up" in a seasoning shed, the water will be further reduced to from 12 to 15 per cent. of the total weight; if it is put into an ordinary living room it will be reduced to from 8 to 10 per cent.; if it is put into a drying kiln operating at a temperature of from 160° to 180° F., only from 2 to 4 per cent. of water will be left; but though the temperature be raised to 300° F. (when chemical destruction begins), water will still be given off. Immediately after wood is taken out of a kiln it begins to absorb moisture. In a week it will have regained from 5 to 6 per cent. of moisture; in a month or so, its condition, if kept in the open air, will be normal—that is, 12 per cent. of its weight will be due to the water it contains. Whenever wood gives off moisture it shrinks. Green wood will by seasoning shrink about 8 per cent. of its width across the grain. One of the objects of seasoning is to reduce the moisture to the proportional limit that will obtain between the wood and the air with which it will be surrounded after it is manufactured into some article of use or ornament. Neither air seasoning nor kiln drying at a temperature below 200° F., will affect the capacity of wood for taking up moisture when there is an excess of humidity in the air, and whenever wood takes up moisture it increases in size (swells).

This faculty in wood of resuming original size, of being larger or smaller, according to atmospheric con-

ditions, is one of the most difficult problems with which wood-workers have to deal. To paint wood-work, or to varnish it makes little difference to these qualities; these coatings simply retard these changes, they do not overcome them. For these reasons, whenever it is required to cover large areas with wood-work, some method must be adopted to nullify the effect of, or of concealing altogether, the "working" of the various pieces of wood after they are placed in position. The combined precautions of intelligent framing, and the application of protective coatings fail to secure immunity from these hygroscopic effects. Wood is doubly affected by the cold, damp air of the winter months. By the natural or air seasoning process, two years for small or thin, and four years for large or thick lumber is necessary to secure good results; lumber is, however, rarely over-seasoned. It may be much more rapidly seasoned by high temperatures in drying kilns. It is not impossible to season one-inch thick boards by this means in two days, but it "kills the life" of the timber. As a rule, the softer a wood is, the more readily it will shrink or swell. Great care should be taken in preparing the foundation on which to pile lumber for the purpose of seasoning it. The edges of the timbers on which the boards are laid should all be in the same plane, so that the boards (which will retain the shape given to them by the pile), may be true planes when taken out of the pile after seasoning.

Warping in wood is a **change of form** resulting from unequal shrinking or swelling. It is sometimes caused by unequal exposure; in fact this is its most fruitful cause. When a board is so placed as that one side is exposed to the direct rays of the sun or



other heat, and the other to a damp atmosphere, the first side will become concave. A board, especially a green one, will also warp when it is equally exposed, that is, when it is surrounded by equally dry air. The cause of this is, that the board, because of the arrangement of its cells, gives off the moisture it contains more rapidly from one side than the other. The side that dries first will become concave. Now if a board is cut from a log midway between the heart and sap, there will be a larger number of the cells, (which lie parallel to the sides of the annual layers), opened on the sap side; therefore, moisture will be given off more rapidly from that side, and, as wood always shrinks when it gives off moisture, that side will shrink first and become concave and the heart side convex. The medullary rays, as they shrink, also conduce to this form in a slight degree.

If these facts are kept in mind, and the end of a board is examined it may be known in what direction the board will warp, when any of the above conditions obtain as to its surroundings. Quarter-sawn lumber is cut radially to the log, and so does not contain these characteristics, therefore will not warp much.

From these facts, then, the following principle may be deduced: In all wood work, the heart side of the board should always be placed on the side of the work that will be the most exposed to any change that is likely to take place in the surrounding atmospheric conditions, for the reason that it is the least susceptible to change of the two sides.

Because of the above noted characteristics of wood, it is best to cut the pieces to be used in any construction roughly to size, and allow them to stand for some time before they are cut to the finished size. If this is done,

they may warp into a more permanent form, and so will be less likely to change the form of the final construction. A board that has recently been planed to a true surface should not be left lying flat on the bench, as it will warp and become concave on the upper side. This is due to the greater exposure of the upper surface compared with the under, which remained in contact with the bench. A board having reasonably straight grain, and which has been planed to a true surface all over, should be left on its edge or end.

#### TOOLS FOR BENCH WOODWORK

For all hand wood work the bench is the first requisite. The best form of bench for pattern-making

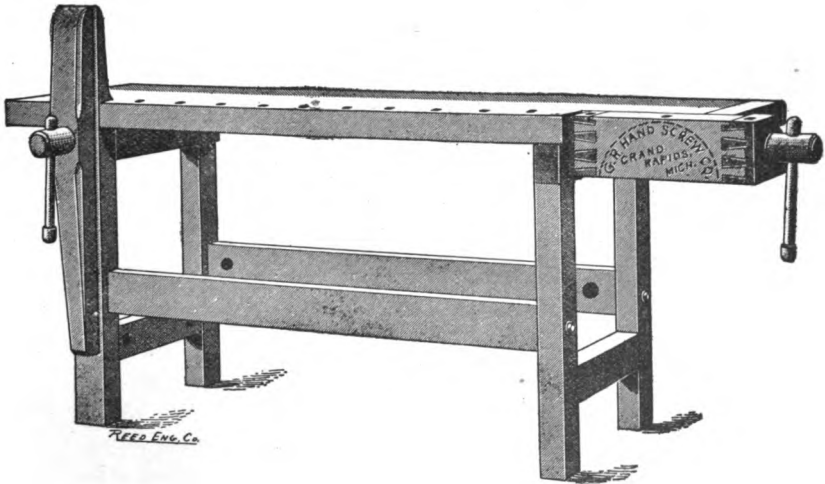

FIG. 1.

is that illustrated by Fig. 1. If this is fitted with a No. 1 "Emmert" Pattern-Maker's Universal Vise, shown by

Fig. 1 (a), instead of the one shown at the head of the bench, it will be the best that can be obtained for this part of

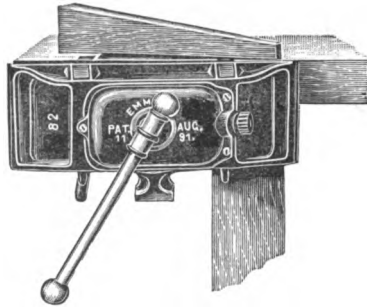

FIG. 1 (a)

shop equipment. The **bench hook** is a very useful part of bench equipment, one form of which is shown at Fig. 2; it should be twelve to fourteen inches long. Some form of saw-horse is also a necessary part of pattern shop

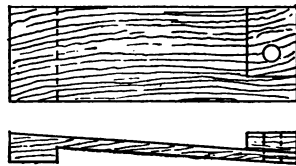

FIG. 2.

equipment; a handy and easily built form is shown at Fig. 3. Another almost indispensable article, something like a bench in its nature, is what is known as a **laying out table**, or large drawing board, on which work can be laid out at full size when necessary. It should be built

very solidly, and have a top that is a true plane. This will be found very convenient on which to build some classes of patterns, for by using this they may be built

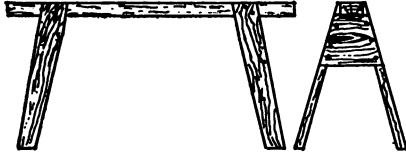

FIG. 3.

up over the lines laid out, as is sometimes necessary. In some shops this laying out table is of iron, with the top planed true.

#### MEASURING AND LINING APPLIANCES

The standard of length used by mechanics and engineers in the United States is the English yard. The standard for reference is the "Troughton Scale," a bronze bar with an inlaid silver scale, made for the coast survey of the United States, by Troughton, of London. This was adopted as the standard by the Treasury Department in 1832, on the recommendation of Mr. Hassler, who was at that time the superintendent of the United States Coast Survey. The **meter** has since been made the legal standard; the act of Congress making it such was passed in 1877. The most commonly used measuring appliance, however, is what is known as the **two foot rule**. This is a strip of wood, usually boxwood, twenty-four inches long, and about half an inch wide. For convenience in carrying, it is jointed so that it can

be folded into two or four folds. These rules for general wood workers' use are graduated in sixteenths of an inch on one side and eighths of an inch on the other. The better class have the inside of each leg graduated in 10ths and 12ths of an inch. (See Fig. 4).

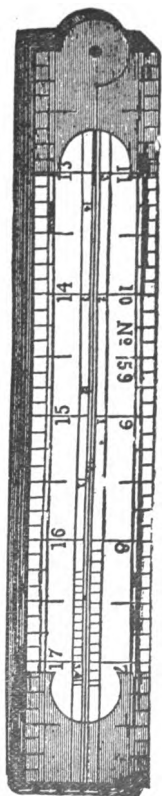
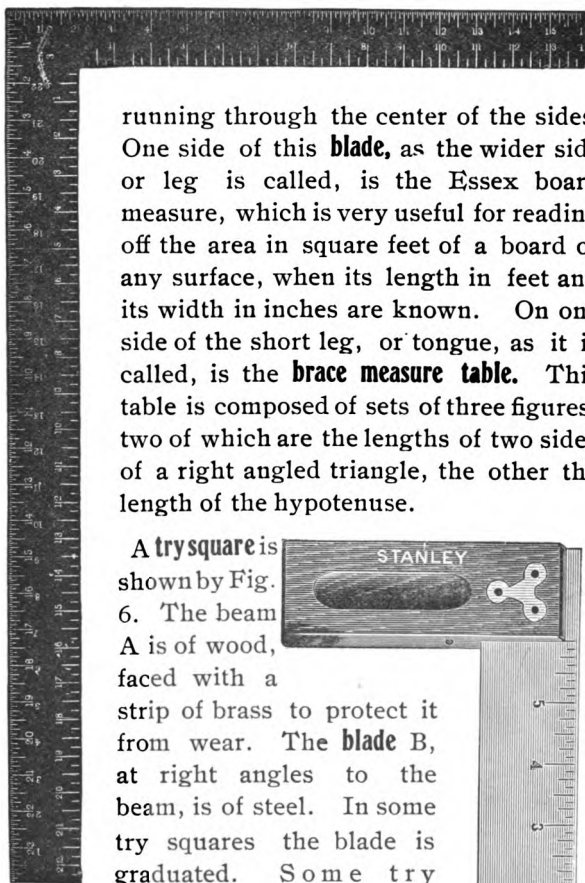

FIG. 4.

Another form of rule is what is known to pattern-makers as the **shrink rule**. By the use of this in pattern-making, due allowance is made in the pattern for the shrinkage that will take place in the metal of the casting. The common form of this rule is a strip of boxwood, one and one-fourth inches wide, and twenty-four and one-fourth inches long. It is divided equally into twenty-four parts, and each one of these parts is subdivided as in the ordinary two-foot rule. Another measuring instrument that is very useful to all wood workers, especially to those having much laying out to do, is the **framing square**. This is made of steel, and consists of two flat, thin pieces of that metal, united at right angles to each other. One piece is two inches wide and twenty-four inches long; the other one and one-half inches wide and seventeen inches long. (See Fig. 5). These are graduated along the edges of the flat sides the same as the two-foot rules; but besides these graduations there are others



running through the center of the sides. One side of this **blade**, as the wider side or leg is called, is the Essex board measure, which is very useful for reading off the area in square feet of a board or any surface, when its length in feet and its width in inches are known. On one side of the short leg, or tongue, as it is called, is the **brace measure table**. This table is composed of sets of three figures, two of which are the lengths of two sides of a right angled triangle, the other the length of the hypotenuse.

A try square is shown by Fig. 6. The beam A is of wood, faced with a strip of brass to protect it from wear. The blade B, at right angles to the beam, is of steel. In some try squares the blade is graduated. Some try squares are made entirely of metal. Fig. 7 represents a combination square; the blade A is moveable so it can be used at any length on either side of the head. The

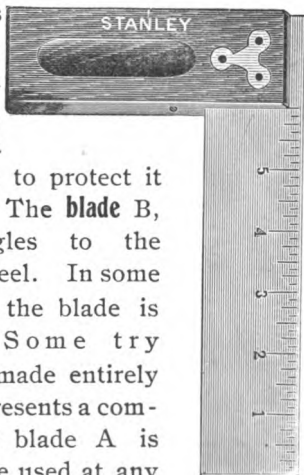

FIG. 5.

FIG. 6.

**bevel**, Fig. 8, sometimes improperly called a bevel square, is made up of parts which are similar to those of the try

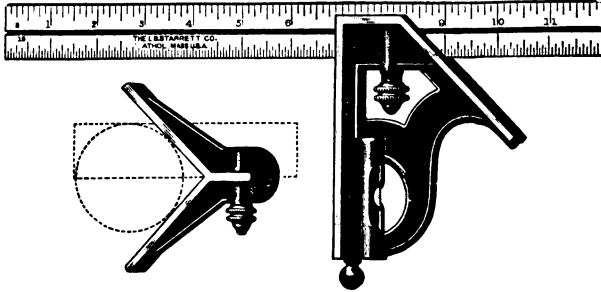

FIG. 7.

square, and have the same names. The blade is adjustable to any angle with the beam, and when set the



FIG. 8.

thumb screw fastens it. The size of both square and bevel is expressed by the length of the blade in inches. The **miter square** is similar to the try square, but has the blade set permanently at an angle of  $45^\circ$  to the stock or beam.

The dividers are used in spacing and in laying out circles. They are also very useful for laying out and transferring angles. One way of using them for this purpose is illustrated at Fig. 9, which shows how to set

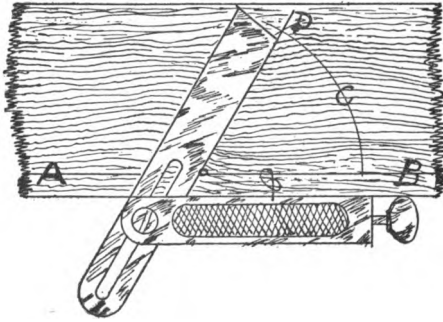

FIG. 9

a bevel at an angle of  $60^\circ$  and  $120^\circ$ . To do this, take a board that is planed flat and one edge jointed, that is planed straight. Gauge a line at any distance from this straight edge; from any point on this line, with any radius, use the dividers to make the arc (B C). With same radius from (B) make the arc (D). Now draw a line intersecting these two points. This line will make an angle of  $60^\circ$  with the edge of the board if measured on one side, and  $120^\circ$  if measured on the other. To set the bevel, place the stock or beam against the edge of the board and swing the blade until it exactly coincides with the line.

Fig. 10 shows the usual form of **marking gauge**. The steel spur should be filed to a thin cutting edge; the



long way is to stand at or near a right angle to the beam in such a way that when pushed along with the left hand, its tendency will be to pull the gauge onto the piece gauged. The square-shaped piece through which

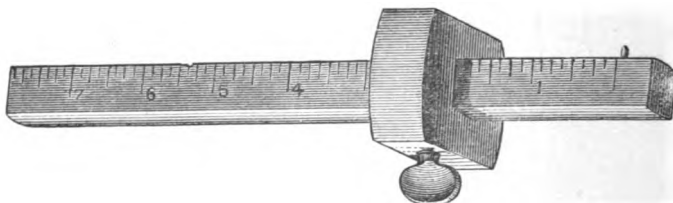

FIG. 10.

the beam slides is called the **head**. The graduations on the beam are not to be depended on for accurate measurements. The **mortise gauge** has two spurs; one of them is moveable on the beam and is fastened to a brass slide

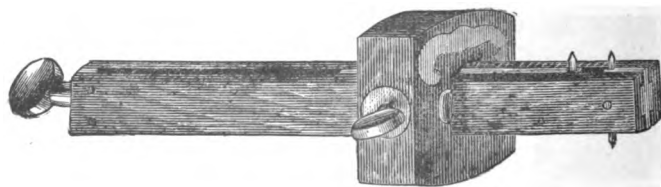

FIG. 11.

that is moved back and forth by a thumb screw at the end of the beam. This is shown at Fig. 11.

## CHISELS AND CHISEL-LIKE TOOLS

There are two general forms of chisels used by wood-workers, viz., the tanged or shank, and the socket. These terms refer to the style of handle and to the way it is fastened to the chisel. Almost all chisels are now made entirely of steel. The tanged form is shown by Fig. 12, and is called a **firmer** chisel. It has a long tongue or **tang** which is driven into the handle, the bolster (a) coming up against the end of the handle, and so preventing its being driven further into it. The end of the handle is provided with a ferrule to prevent splitting. It is this form of chisel that is usually used by workers in soft woods, such as joiners and pattern-makers. The better quality of this form of chisel has beveled edges as shown. The other form, known as the **socket firmer**, is shown at Fig. 14. It is so called because the handle sets into a socket provided for it. This form of chisel is more generally used than any other, as all classes

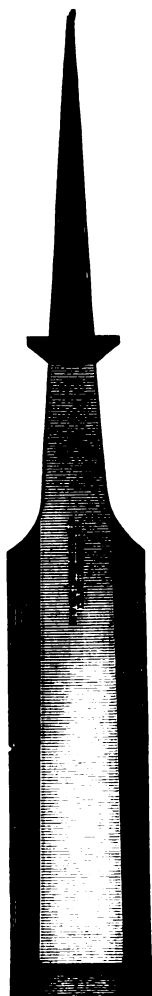

FIG. 12



FIG. 14

of wood-workers except joiners and pattern-makers employ it almost exclusively while even some of these prefer this kind because it is stronger than the tanged firmer. Socket firmers are made of different weights and lengths for different kinds of work. The better grades of these also are made with beveled edges.

**Gouges** have blades that are curved in section throughout their length, and are named and used like chisels. There are two general forms of this tool, viz: the inside gouge, (Fig. 15) and the outside gouge (Fig. 16). The bevel of the first is ground on the inside of the curve; that of the other on the outside; the latter is generally the more useful. They can be bought with the cross section of three different curvatures, known as **quick**, **middle**, and **flat sweep**; this is shown at Fig. 17, which represents the cutting edge of each. The sizes of all gouges and chisels are designated by the width of the blade; a two-

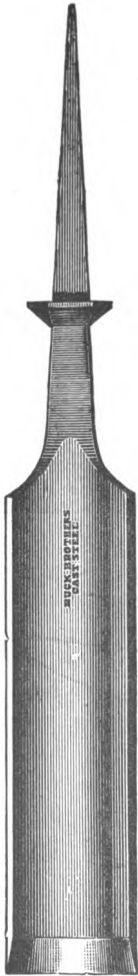

FIG. 15



FIG. 16

inch chisel or gouge, for instance, has a blade that is approximately two inches wide. They are made in sizes

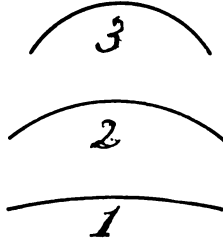

FIG. 17.

as follows: From one-eighth inch up to one inch by eighth inches, from one inch to two inches by quarter inches.

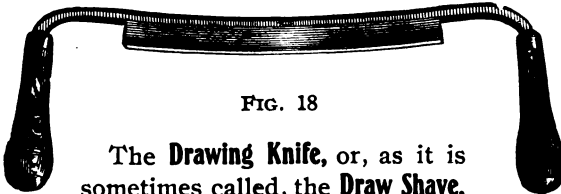

FIG. 18

The **Drawing Knife**, or, as it is sometimes called, the **Draw Shave**, is in reality a very wide chisel, but is not used in the same way. It is shown in Fig. 18.

## SAWS

The saw is one of the most useful and effective wood-working tools, but is perhaps the most difficult to keep in good order. Saws are of two general kinds; the **rip saw** is intended to cut with the grain of the wood; the **cross-cut saw** is used for cutting across the grain. A rip saw should be from 24 inches to 26 inches long and should have from four and a half to six teeth to the inch. A cross-cut saw for bench use, is called a **panel**



FIG. 19

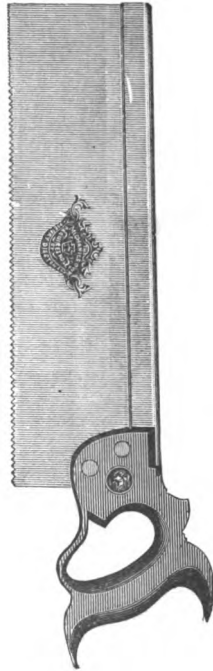

FIG. 20

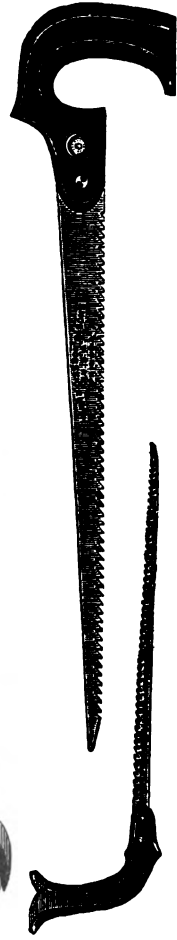

FIG. 21 FIG. 22

**saw**; it should be about 20 inches long, and should have from eight to ten teeth to the inch. A full sized cross

cut saw, called a **hand saw**, is 26 inches long and should have from seven to nine teeth to the inch, (Fig. 19). The **back saw** (Fig. 20), is a cross-cut saw with a very thin blade and fine teeth; the blade is reinforced with a strip of brass or steel along its back edge, hence its name. The **key-hole saw** (Fig. 21), is a narrow bladed one used for entering small holes for the purpose of cutting a short distance so that a larger saw may be used, or for cutting along curved lines. Another saw that is sometimes used for similar work but is somewhat larger, is called a **compass saw** (Fig. 22). The key-hole and the compass saw are likely to be used both across the grain and with the grain, and are therefore filed differently from those designed especially for just one of these purposes.

As the rip saw has to cut or sever the ends of fibers of the wood, its teeth should have chisel-like points. The cross-cut saw has to also sever the fibers of wood, but in a different way. As the cutting is done across the fiber of the wood, it requires what may be called a **scoring** of the fiber. The friction of the other parts of the teeth on the wood loosen the particles cut or separated, and carries them away in the form of sawdust. The size of the teeth are governed largely by the size of the pieces of wood to be sawn: for cutting trees into saw logs the teeth are very large; the back saw has very small teeth, as it is used for cutting comparatively small pieces of lumber.

In the actual filing of saws the size of the tooth is determined by the number of teeth in a given distance. The size of its teeth, other things being equal, does not help or hinder the smooth cutting of a saw. For a rip saw the best form of tooth is a chisel-pointed one; the best form of teeth for cross-cutting effect is a triangular one.

These two forms of teeth are shown in Figs. 23 and 24.

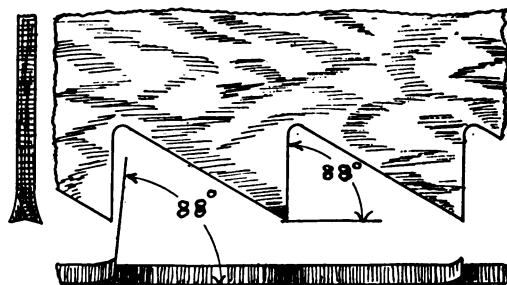

FIG. 23.

The different angles most suitable for general work are also indicated in the same figures, Fig. 23 representing the teeth for a rip saw and Fig. 24 the teeth for a cross cutting saw. These should be varied according to the kind of wood; they should be less acute for hard wood and more acute for soft wood. The keyhole

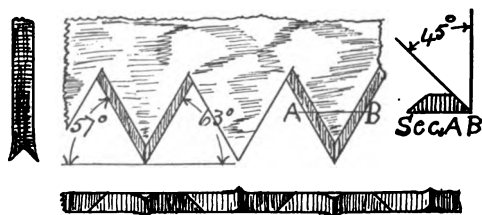

FIG. 24.

and compass saws are filed with a combination of these angles.

In fitting or sharpening a saw for use, there are four distinct operations to be performed: 1. It must be **top-jointed**; that is, a file should be passed along the tops of

the teeth, so that they may all be of the same height and extend in the same general line, the line being a slight curve. 2. It must be **set**; that is, the point of each tooth is bent sidewise, adjacent teeth being bent in opposite directions. 3. It must be **filed**; that is, the individual teeth must be filed to a point. 4. It should be **side-jointed**; that is, a file or, preferably, an oil stone, should be passed along the side of the teeth, which will even up the set.

#### BORING TOOLS

At Fig. 25 is shown the auger bit. This is the Russell Jennings pattern, one of the best of its kind. Fig. 26 represents what is called a square-hole auger. The boring is done by a common auger bit on the inside of a thin shell, which is square; the corners are sharpened, and, as the extra long spur or screw on the end of the auger draws it into the wood, these square corners cut the hole made by the auger into square form. Fig. 27 is the Syracuse drill bit. This is the best all-round drill for wood on the market. Because of its shape it will bore in any direction of the grain, and it will also operate close to the end of a piece without splitting it. If it becomes dull it can be easily sharpened. At Fig. 29 is shown the Expansive bit, one of the most useful boring tools, because of its range in size. It can be set to bore any sized hole within its range. Two sizes can be had, one boring holes from one-half inch to one and one-half inches, and the other seven-eighths inch to three inches. Fig. 28 shows another boring tool that is very handy, especially to pattern-makers and to others who want to bore holes with smooth bottoms. It is called the **Forstner** bit. It has no spur or leading screw, so must be pushed to its work. Fig. 30 is what is known





FIG. 25.



FIG. 26.



FIG. 26 (a).

as the centre bit. It is very convenient for boring holes



FIG. 27.



FIG. 28.



FIG. 29.

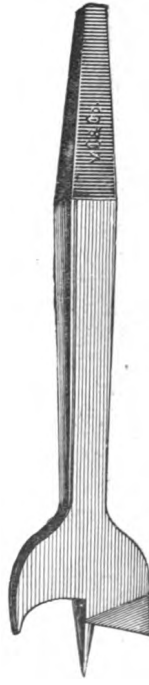

FIG. 30.

in work as it revolves in the lathe. The central spur is

not a screw, but simply a triangular point, so that this bit, like the last one, must be forced to its work; thus it can be made to do its work rapidly or slowly as the job may demand.

In providing holes for screws it is found to be almost necessary, especially in hard wood, to countersink the top for the screw head. At Fig. 31 is represented one



FIG. 31.

form of tool used for this purpose; it is called a **countersink**. At Fig. 32 is shown one of the best forms of what is called a **bit brace** or **bit stock**. This is Fray's ratchet bit brace. For general use the auger bit is preferred, as when sharp it will cut a very clean, smooth hole, and do it rapidly. In boring a hole through a piece of wood with this bit, when it is desired to leave both sides smooth, care should be taken not to let the bit go clear through from one side, but to bore just far enough so that half the length of the screw comes through; then remove the bit and finish the hole from the other side. Another way this may be done is to clamp a piece of waste wood to one side of the piece through which the hole is to be bored.

#### MISCELLANEOUS TOOLS

Hand screw-drivers are of several shapes. Fig. 32(a) shows one very common form which is a very good one for the bench worker. Some of the other forms are better for special uses. The part of a screw-driver that enters the slot of the screw head should never be wedge-shaped; otherwise, when force is applied, the tendency is

to lift it from its place instead of turning the screw. The correct shape is shown at one side of Fig. 32(a). Brace

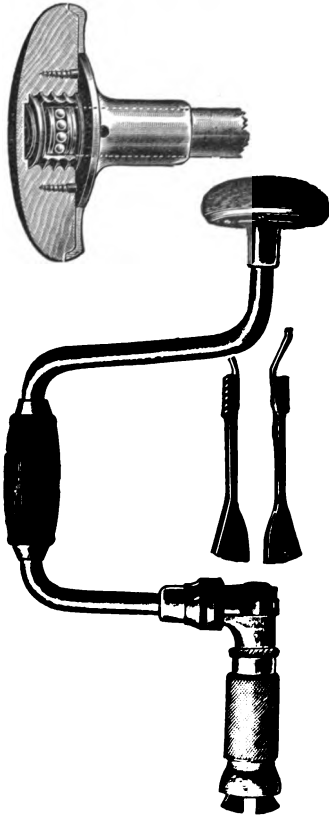

FIG. 32.



FIG. 32 (a).

screw-drivers instead of having a handle, are provided with a shank for use in a brace.

A hammer and a mallet are needed for bench work. The **square** form of mallet is for some reasons the best.

What is known as the **claw hammer** is the best for general bench use. The nail-set, though small, is a very necessary tool for bench work.

The miter box, one form of which is shown

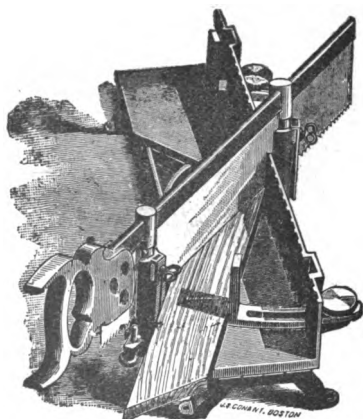

FIG. 33.

at Fig. 33, is an almost indispensable tool for bench workers. It is the most useful when small pieces of irregular outline, such as mouldings, have to be cut to a miter line, in the case of a picture frame, for instance. The word **miter**, when used without a qualifying word, is understood to mean the intersecting line between any two pieces at right angles to each other, as the diagonal of a square. When pieces are to be mitered at any other angle than  $45^\circ$ , the angle of the intersecting line is indicated in degrees; for instance, a sixty-degree miter.

When pieces of wood have to be held together temporarily, for gluing or any other purpose, some form of clamp is necessary. The form shown by Fig. 34, known as **hand screws**, are the most used by pattern-makers. In

using hand screws care should be taken not to force the jaws too far from their normal parallel position; otherwise, the threads of the screws may be stripped, or even

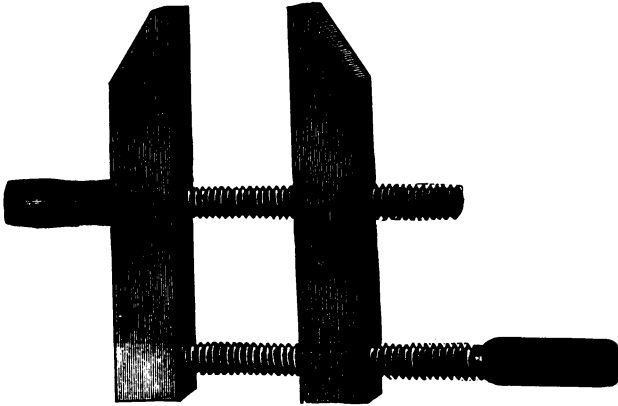

FIG. 34.

the screw broken. There are several forms of iron clamps on the market, one of the best of which is illustrated by Fig. 35. These are sometimes very useful, but,

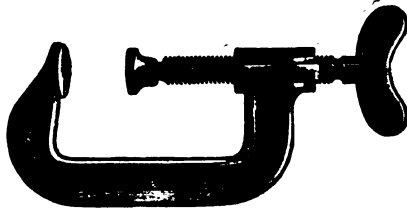

FIG. 35.

all things considered, hand screws are the best for bench work.

A grindstone of some form is a necessity for grinding the cutting edges of wood-working tools. It is to be

selected with reference to its grit; one that is rather fine and soft is best. A power grindstone should have a speed of from 500 to 600 peripheral feet per minute, depending upon its diameter, and upon the steadiness and accuracy with which it runs. When a stone throws water from its face it is running too fast for doing good work in tool grinding.

#### PLANES AND PLANE-LIKE TOOLS

A bench-worker's "set" of planes consists of four, the jointer, the short jointer or fore-plane, the jack-plane and the smoothing-plane. To separate these into a class they are usually spoken of as surfacing planes. These differ in length from 8 inches in the smoothing plane to 30 inches in the jointer.

The jack-plane is the first one used in planing a rough surface, or in removing surplus material. If the surface is simply to be smoothed, then the smoothing-plane may immediately follow the jack-plane; but if a true surface is wanted the jack-plane should be first followed by the short jointer, and then by the jointer. With the last named plane in good condition, practically a true plane may be made. The carpenter or joiner would call this a surface that is **out of wind**.

To test a surface during the process of planing, "winding sticks" or strips are used. A winding stick is a strip of wood of wedge-like cross-section about two inches wide, and with both edges straight and parallel to each other. Two of them are needed to test a surface, one being placed near each end of it. After setting them on the surface exactly parallel to each other the operator should sight across from one to the other. As the eye is lowered, if the one farther away is lost sight of all at

once, the surface, if straight between the points on which the strips set, is a true plane, and is said to be **out of wind**. If the farther one does not disappear all at once but the top edges appear to cross each other, then the surface is not a true plane, and is spoken of as a winding surface or **in wind**. If the surface is in wind, notice which ends of the winding sticks are the higher. Then if a true surface is wanted, plane off some of the surface at the points under the higher ends, and test again. In order to obtain the greatest advantage to be gained from the use of winding sticks, they should be considerably longer than the width of the surface to be tested. Thus the width of the surface is exaggerated, which is one object sought in using these strips. The blades of two framing squares answer admirably for this purpose. The use of these surfacing planes should be thoroughly acquired, so that the surfaces of any piece or pieces to be used for the construction of any object may be readily and correctly planed. As plane surfaces are to a degree the foundation for the future work to be done on them, it is very essential that they should be correct; if otherwise, poorly fitting joints will result. Good work cannot be done if the working faces are incorrectly planed.

The cutting irons of all these planes are true cutting wedges of different widths, the width varying with the length of the plane. To each of these wedges is added a supplementary iron called a **cap** or **back iron**, which is placed, as its name indicates, on the back of the cutting iron, thus making it a **double iron**. The purpose of the back iron is to break the shaving as it is made by the cutting wedge.

The exact way in which this is done can be explained better with a cut than with words alone. Fig. 36 shows



how the wedge acts as a single iron. At Fig. 37 is shown the double iron and the effect of the back iron on the shaving. As the shaving is cut and bent by the

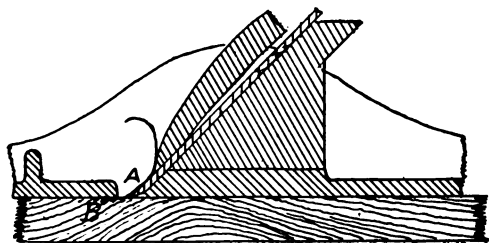

FIG. 36.

wedge, its tendency is to follow the back of the plane iron as at A, Fig. 36. As seen at A, Fig. 37, the back iron prevents this, by changing its course and breaking it before it has time to split down into the wood. The single iron does very good work so long as the grain is favorable, but when it comes to a place on the

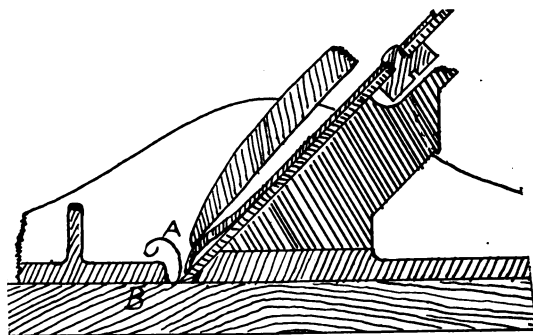

FIG. 37.

board that is cross-grained, as at B, the shaving will split ahead of the cutting iron and leave the surface rough.

Fig. 38 shows the wood plane and the advantage of a **narrow mouth**, which the iron plane shown by Fig. 37 lacks. This, too, changes the direction of the shaving. It has also the advantage that it aids the plane in doing smooth work at a spot where the lumber is cross-grained, for the narrow mouth holds down the wood

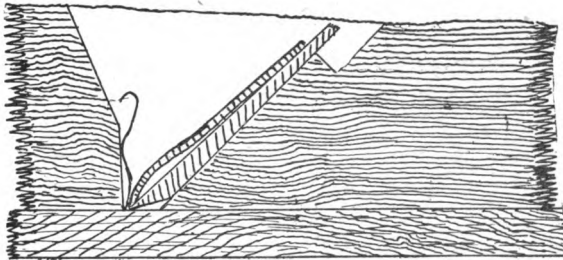

FIG. 38.

immediately in front of the cutting iron, and so prevents its being torn up before it is cut. This is one of the advantages that the wood plane has over the iron, another being the comparative ease of working. Still, when everything is considered, iron planes are the best. Their principal advantage is that they will not warp or appreciably wear; consequently the face or **sole** of the plane is always a true plane.

The cutting edge of plane irons should not be straight but slightly curved. For the jack-plane this curve ought to be much quicker than for the other planes. The jack-plane is frequently used for removing very thick shavings and if the iron were straight, it would tear out a rectangular groove for the whole width of the iron. This would be very likely to clog the plane and would also consume much more force than if the edge

was curved. In a given time with a given amount of force applied, much more wood can be removed if the iron is curved than if it were straight.

Theoretically, the outline of the cutting edge for the jointer and smoothing-plane irons should be straight in

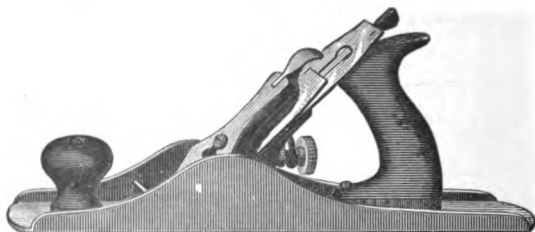

FIG. 39

order to produce a straight flat surface, but in practice this is not the case. So for these irons the corners should be slightly rounded, or, what is better, be slightly curved, but the radius of the curve should be much larger than for the jack-plane iron.

Fig. 39 shows the iron jack-plane, the other three of the set are the same shape. Fig. 40 shows one form of the block-plane. The principal use of this plane

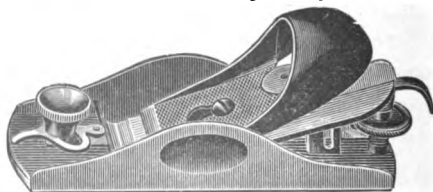

FIG. 40

is to smooth end grain. The angle at which the iron is set in this plane is much smaller than that of other planes. This being the case, the iron, which is always a single

one, is inverted. If it were not, the angle of the cutting wedge would have to be so small that it would not stand up to the work. To prevent this plane from breaking over the corners of the wood, when being used on the end of a board or other piece, another piece should be placed back of the one being planed. If the board is of

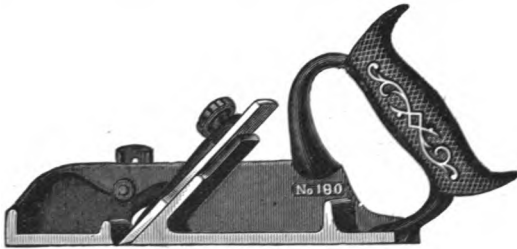

FIG. 41

considerable width the plane may be worked both ways and not carried clear across.

Another plane that is very useful to wood-workers is shown at Fig. 41, called a **rebate** plane. The iron is

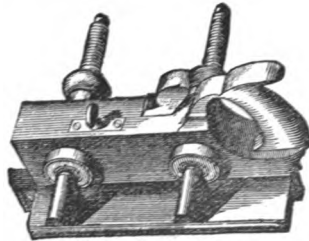

FIG. 42

set **askew** in the plane and extends the whole width of the face. It is used for cutting a rectangular space called a **rebate**, into the corner of a piece of wood. This word has been corrupted into "rabbit."

Another plane-like tool is illustrated by Fig. 42. This is the carpenter's **plow**. Its principal use is the cutting of rectangular grooves into wood parallel with the grain. It is adjustable and can be set to cut the groove at any distance from the face of a board. Irons of different widths are supplied so that grooves of any width and depth may be cut.

A plane called a **dado** plane, shown at Fig. 43, is

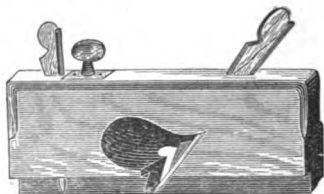

FIG. 43

used for cutting rectangular grooves **CROSSWAYS** of the grain. Its iron is set askew. It has a depth gauge to regulate the depth of the groove.

Combination planes made of metal; which may be used in the place of the plow, dado, matching planes, beading planes, etc., are on the market and some of them are very

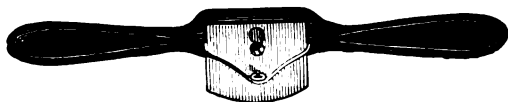

FIG. 44

serviceable tools. Spoke-shaves have the action of planes but are not usually classed with them. A simple form is shown at Fig. 44. It has a very small face which adapts it for use on irregular surfaces. Another form which is very serviceable for quite small curves is shown at Fig. 45. There are several other forms of planes in

use, but most of them are designed for specific uses, and are not commonly used by the pattern-maker.

There is one plane, however, that is used by pattern-makers, and which is mentioned in the body of this work, but represented there in the wooden form, that should be noticed here; that is the latest form of iron core box plane, and is represented by Fig. 54.



FIG. 45

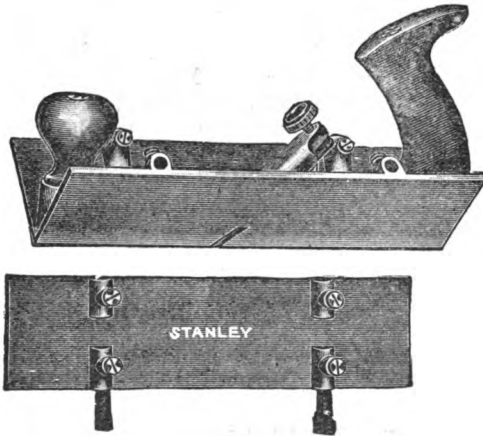

FIG. 54

#### CUTTING WEDGES

From the wood-worker's point of view, the chisel is the typical **cutting** tool. It has two operations to perform when in action, viz.: **cutting** the fiber of the wood, and **breaking, crushing** to one side, or **bending** the wood out of the way, so that the cutting edge may go on with its work. Every cutting tool is a wedge, more or less acute. To widen the cut the wood must be bent; this

the cutting wedge of the plane does, and thus forms a shaving. The chisel, when driven into the wood, as in cutting a mortice, crushes the wood and so widens the cut. When the wedge is driven in parallel with the grain, the fibers are pressed apart, the cut is widened and the wood split. It can be demonstrated that much less force is required to carry the wedge forward when first entering the cut than after it has extended into the material for some distance. It is reasonable, therefore, to suppose that the larger part of the force applied to form a shaving or chip, is consumed in this bending or crushing, and a very small part by the actual cutting of the fiber of the wood. A very acute angled wedge will do a given amount of work with less force than one not so acute. But the one with the larger angle will do the actual cutting as easily as the other. The angle of the wedge has very little to do with the force required to do the cutting, at least up to any angle that would or could be used for cutting wood. The acuteness is limited only by the strength of the steel, so it must vary as the kind of work and material varies. A more acute one may be used for soft wood than for hard wood. And again, a larger angled wedge is needed in a chisel that is to be used or driven to its work with the mallet than in one that is to be used with the hands only.

If it was insisted on that a cutting wedge should always have its maximum of delicacy, it would necessitate that the angle be changed for almost every shaving or chip made. This would be impracticable, so that the results of the experience of wood-workers may be expressed as follows: "Make the cutting wedge as acute as the metal will allow without breaking, when fairly used." The angle of the wedge for all wood-

cutting tools for general use should be from  $25^{\circ}$  to  $30^{\circ}$ .

The sharpening of a cutting wedge requires considerable care and skill, if it is required to do first-class work with it. If the chisel or other edge tool is new, or very dull, it must first be ground. This is best done on a medium grit, soft grindstone. Emery wheels are largely taking the place of grindstones for this purpose. Greater care is necessary in the use of emery wheels than with grindstones for grinding **wood-working** tools, for the wedge being thin, the temper of the steel is very liable to be drawn by the heat generated by the friction. In grinding a cutting wedge, the grindstone should revolve **toward the cutting edge**. The correct position in this regard, and also to produce the best angle for general use is shown in Fig. 46. Plenty of water must be kept



FIG. 46.

on the stone during the process of grinding. The water serves two purposes; one is to reduce the temperature generated by friction, the other to keep the stone clean or to carry off the particles of sand and metal loosened in the process of grinding. The surface produced by the grinding is called the **bevel**.

As the coarse grit of the grindstone will not produce a clean, smooth cutting edge; the tool will have to be **whetted**. This is done on an oil stone, either natural or artificial. The latter kind, if made by a reliable firm, is the best, as it wears more evenly. The tool, while held



in such a position that the heel of the wedge does not quite touch the stone, should be carried back and forth along the whole length of it, care being taken not to give the tool a rocking motion, which would produce a curved instead of a straight line. This operation should be continued until a slight wire edge is produced on the **back**, as the straight side is called. The wire edge must be removed in order to produce a sharp edge that will cut smoothly. To do this, lay the tool on its **back**, flat on the oil stone, and give it a few light strokes toward the edge. Great care should be taken **not** to raise the handle of the tool, as that would bevel this side of the wedge and impair the proper working of the tool. There are two tests that may be used to determine if the edge is sharp. One by the eye, the other by the sense of touch. If a sharp edge is examined by the eye, it will be noticed that a dull line appears where the edge is. If the edge is not sharp, a bright line will be seen. The more dull the tool is, the larger the bright line will appear. To test by the sense of touch, place the thumb or finger on the edge, and try to move it along the edge. If it is not sharp, no difficulty will be found in doing this. If, however, the edge is sharp, a clinging or pulling sensation will be felt. The best test, however, is to cut wood in the same direction as the work to be done. If the surface cut is smooth and glossy, the tool is sharp. If the tool is dull it will cut a surface that is rough and dull to both touch and sight.

#### LAYING OUT WORK

The production and location of lines is one of the most important parts of wood work, as of all mechanical work, in the production of work of a definite size and shape. Any carelessness in this direction will always

make itself manifest in the finished product. This is so much the case that one who is habitually careless in this regard seldom makes a good mechanic. Let it be understood at the outset that a scratch is not a line, and that patience and accuracy in the making and locating of lines is one of the first requisites to success in all mechanical manipulations, and in the production of all articles made by mechanical processes.

The tools used for marking lines are four,—the chalk line, pencil, gauge and knife. For bench work the knife and gauge are the most used. The knife is used for marking across the grain, and should have a sharp point so that it will cut into the wood, not merely scratch it. In making a mark where a cut is to be made with a saw, the lines may to advantage be cut  $\frac{1}{32}$  of an inch deep. The gauge is the best implement for marking lines lengthwise of the grain. A great deal more might be said about this part of wood-working,—**laying out work**, as it is usually called—but space forbids.

#### PATTERN TURNING

The term **wood turning** is generally understood to mean the making or forming of any circular form required of wood, while revolving at a high rate of speed in some form of lathe. Wood turning is done in two distinct ways; first, along or parallel with the grain; and second, across the grain, or, as it is sometimes called, **plankwise**. Wood turning may be divided into two kinds, **cabinet turning**, by which balusters and other decorative articles are produced; and **pattern turning**, a method used by pattern-makers, by which the many circular forms required in that trade are made. The same tools are used on both kinds of turning, but the processes are, in some

respects, quite different. The cabinet turner is more concerned as to the beauty of outline and finish than with exact size, and uses methods that will accomplish these results. The pattern turner, on the other hand, **must have exactness** in size, the finish being a secondary matter. This being the case, whereas the cabinet turner actually cuts the fibers of the wood, the pattern turner uses what is called a **scraping** cut for most of his work.

A common form of turner's lathe is shown by Fig. 47.

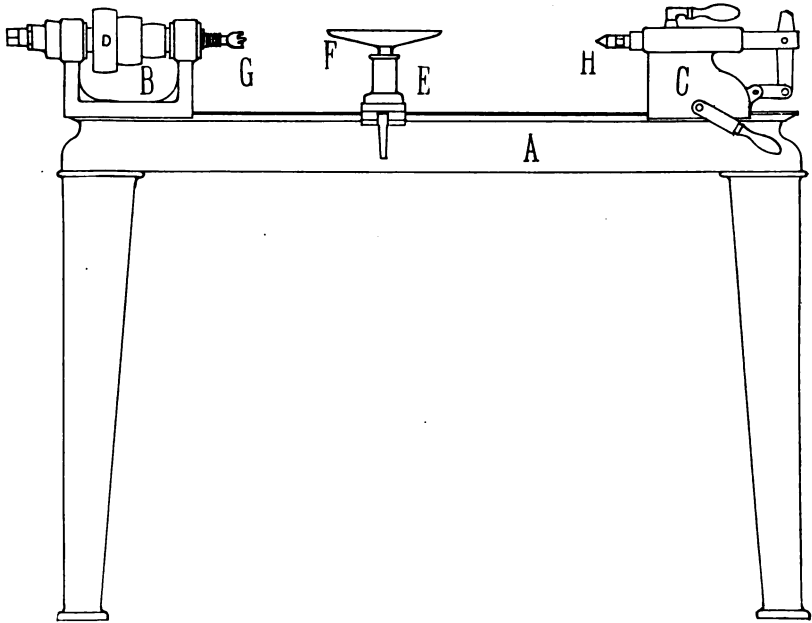

FIG. 47.

In the figure, A is the bed, B is the **head stock**, C is the **tail stock**, D is the **step cone pulley** on which the belt runs that drives it and the **spindle G**, and with it the **driving or**

**fork center**, which in turn drives the work. The fork center is driven into a tapered hole in the spindle, and is held by friction only. In the tail stock is the **back center**, H. At F is the tool or hand rest.

Fig. 48 shows an enlarged view of the most common

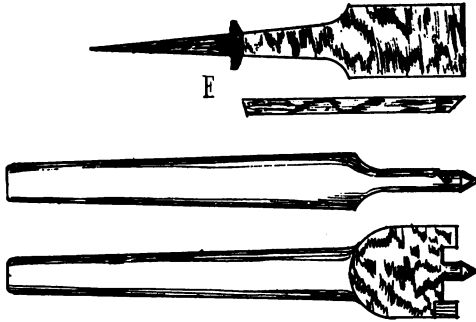

FIG. 48.

form of fork chuck. The fork chuck at the left hand, and the back center at the right, make up the common appliance for holding work in the lathe, when the turning is to be done **lengthwise** or **parallel** with the grain. For turning **plankwise** or across the grain, there are several kinds of **chucks** employed, the simplest being the **screw chuck**, shown at Fig. 49, in two forms. A **face plate** is shown in the center of Figs. 62 and 63, pages 122 and 123, and a chuck for large work at Fig. 62, and one at Fig. 63 adapted to still larger work. The pieces shown at A, Fig. 62, are not necessary, but they are a great convenience when it is required to hold work on the chuck with hand screws, as in gluing up work. If the chuck has such a rim, the hand screws may all be set open the same distance, and therefore quickly applied, which is necessary when using glue. For small work, a chuck

may be simply a **disk** of wood. Each chuck must have a face plate fastened to it during its use. There are several different ways of fastening work to these chucks, generally determined by its size and shape. It may be fastened with screws or nails, it may be glued directly to the

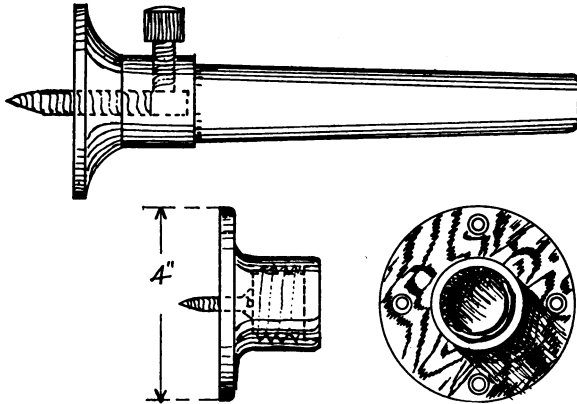

FIG. 49.

chuck, and it may be glued to paper already glued to the chuck. When this last way is used, the work may be taken off without damaging it, because the paper will split. When it is glued directly to the chuck it will have to be cut off, so this way is not usually employed except for patterns of **thin cross section**, such as pulley rims, that can be easily cut through. Besides these plain chucks, several other forms are in use for special work, one of which is represented by Fig. 50, and is called a **cup** chuck. One of its uses is to hold a sphere in the lathe while it is being given the finishing touches. Some of the specific uses of these appliances are described in the body of this volume.

Not many different forms of tools are required for pattern turning, but quite a number of different sizes of the same form are needed. The first to be noticed is the turner's gouge, shown by Fig. 51, and the **skew**, or **turn-**

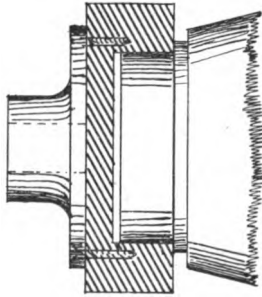

FIG. 50.

**ing chisel**, illustrated at Fig. 52. These two, in their different sizes are the only tools used by the turner for **cutting** the fiber of the wood. All the others are really **scraping** tools, and do not actually cut. The other tools most used for pattern turning are illustrated by Fig. 53. At A is shown a pair of the ordinary scrapers, the tool most used on flat and convex surfaces. At B is shown the round-nosed scraper, used for concave surfaces; several sizes of this are needed for a medium range of work. At C the ordinary parting tool is shown. This is a very useful tool for working wood plankwise; its special form gives **clearance** in whatever position it may cut the wood. The tool shown at D is also a very good tool for turning wood across the grain, especially if a large amount of wood is to be removed. This it will do rapidly and easily. It is called a **diamond point parting** tool. At E, in Fig. 48, is shown a straight scraper, which is very useful for finish-

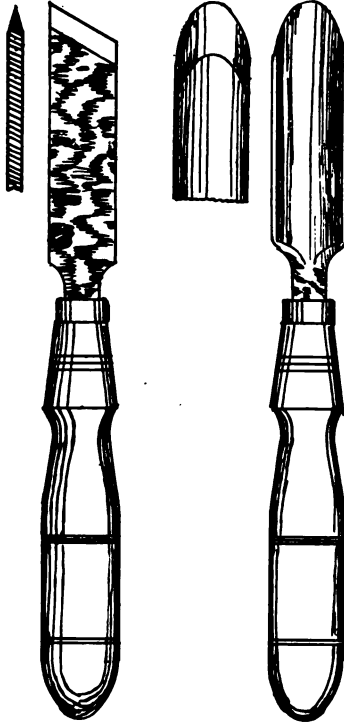

FIG. 52.

FIG. 51.

ing large straight surfaces. It is made from a firmer chisel that is worn too short for its original use. Indeed, worn-out chisels of this type make first-class turner's scrapers. All the scraping tools, except those shown at A and D, may be made of these and will serve their purpose admirably. The two noted above are sometimes needed longer than the others, and are better if made of heavier stock.

The art of turning can be learned by the student only in the same way that any other mechanical trade or craft is learned, i. e., by actually doing the work and perform-

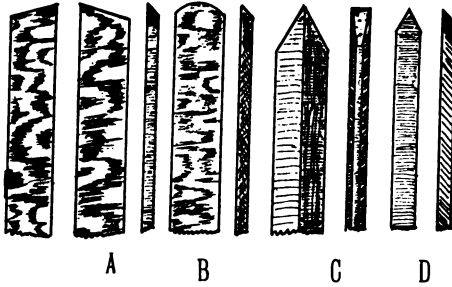

FIG. 53.

ing the operations involved in the practice of that art. This being the case, only a few simple directions will be given here. These directions may best be given by explaining the operations that must be performed in turning a cylinder. The first thing to be done is to saw out the stock square, with the sides about one-eighth inch larger than the diameter of the proposed cylinder. Next make a center mark on each end by drawing diagonal lines across it; at these points the lathe centers are to enter. To set the work in the lathe, place one end against the driving center, or head center, and with a hammer or mallet drive on the other end until the chuck has entered the wood far enough to revolve the wood against the tools; now while holding the right hand end in the left hand, slide up the tail stock with the right hand until its center touches the wood, and clamp it to the bed. With the handle connected with the tail center, push the center into the right hand end far enough



to make it secure. Adjust the tool rest so it will just clear the corner of the piece when revolving. It is a good plan, before applying the power, to give the belt a pull with the hand to ensure that everything is clear.

The gouge is the first tool to be used on this kind of turning; the cutting done by it at this stage of the work is termed the **roughing cut**. The gouge is so held that a center line through the tool will be perpendicular to the axis of the work. The bevel of the cutting wedge should be held tangent to the proposed cylinder, and rolled on its side as indicated by Fig. 55 at A. The

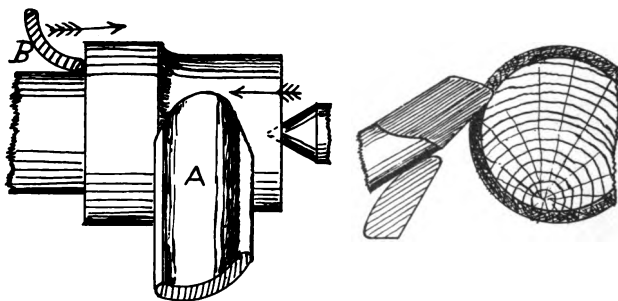

FIG. 55.

direction in which the tool is moving is indicated by the arrow in each case. In this position the angle of the cut will be about  $25^{\circ}$  to  $30^{\circ}$  with the axis of the cylinder, which is the best for this kind of turning. The gouge is used by good turners for doing a very large proportion of the work on plain cylindrical and concave surfaces.

Plain cylindrical and convex surfaces are finished with the turning or skew chisel, the only other cutting tool used by turners. Its use requires a great deal of skill on the part of the operator. On account of its shape

it has a great tendency to rip or tear into the work with its long corner. One reason for its so doing lies in the fact that it **cannot be laid flat** on the tool rest, but must be supported as shown at Fig. 56, and at A and B, Fig. 57.

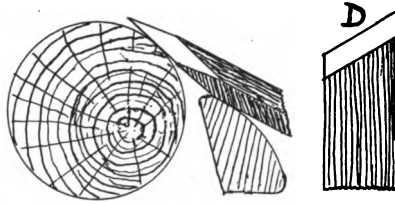

FIG. 56.

This being the case, the keeping of the edge of the chisel in its proper position and angle with the work depends entirely on the skill of the workman. This skill cannot be imparted, but some suggestions can be given that will aid the student in acquiring it. Do not let the chisel cut above the central point of the length of the cutting edge, that is at D, in Fig. 56. Retain a firm grip on the handle with the right hand.

The bevel, like the gouge, should be laid on the cylinder exactly tangent, and held so that the handle is perpendicular to the axis of the cylinder. As **one corner only** of the chisel touches the rest, it is very difficult to keep it in its correct position. If the bevel is exactly tangent, it will not cut; so it must be tipped enough to be tangent to a circle slightly smaller than the one already cut. This is best done by simply rolling the chisel with the hand until it cuts a shaving of the desired thickness. As a general thing, the cylinder should be cut almost to size with the gouge, leaving only a shaving or two to be removed by the chisel.

Pattern-makers do almost all this finishing with a scraper like E, of Fig. 48. The position of this tool for scraping plain cylindrical surfaces is, as shown in Fig. 58, exactly on the diameter of the cylinder. The cutting of shoulders like those in Fig. 57, and also the square

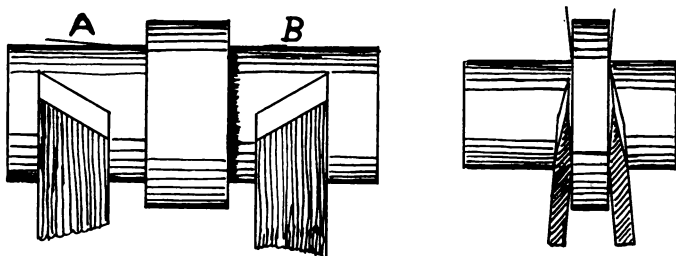

FIG. 57.

ends of the same figure is done with a skew chisel. The chisel is held as there shown, that is, at a slightly larger angle than the one at which it is sharpened; so no part of the **edge**, except the extreme point, should touch the wood. The ends of nearly all plain cylindrical patterns have to be made **convex**. To make them so, the chisel may be held with the center line of its length perpendicular with the axis of the cylinder, while at the same time the edge of the chisel is perpendicular. For making other forms in the lathe, the tools shown in Fig. 53 are used. These are all scraping tools.

#### SHARPENING LATHE TOOLS

The cutting wedges of the turning gouge and the turning chisel are sharpened in the same way as other cutting wedges. The wedges for soft wood, however, should be more acute than the bench chisel for general work. The wedge of turning chisels for use in soft wood

may be ground to an angle of  $20^{\circ}$ , and must be kept very keen if good work is to be done. The **roughing gouge** should have a wedge of  $30^{\circ}$ . The scraping tools should have wedges of about  $45^{\circ}$ , and be ground on one side only, as shown. As the cutting edge of the scraping

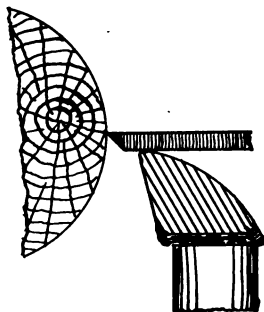

FIG. 58.

wedge is on the side instead of on the end, as in the cutting wedge it requires a different treatment to secure the best results. After sharpening the chisel in the usual way, place it on the oil stone on its bevel, and, while holding it in that position, give it two or three strokes parallel with the back. This will give a continuous wire edge, which is just what is needed. Pushing the chisel back and forth in the usual way also produces a wire edge, but it is a serrated one, and therefore is quickly dulled.

#### TOOLS FOR MEASURING TURNED WORK

The special tools for measuring turned work are shown at Figs. 59 and 60. The former is the outside caliper, the latter the inside caliper. The outside caliper is used for measuring the outside of round or cylindrical work,

the inside caliper for measuring holes and cavities either cylindrical or of other forms. The outside caliper may be used when the work is revolving, provided it is very

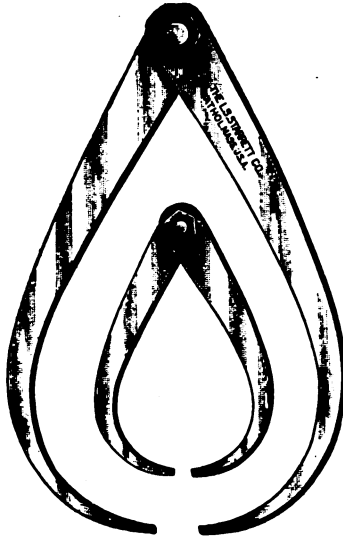

FIG. 59.

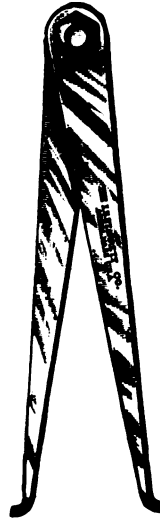

FIG. 60.

nearly cylindrical. The inside caliper should not be applied to work that is revolving, as it is likely to be caught by the wood and jerked out of the hand. The common two-foot rule is used for measuring along a cylinder, when the caliper would be unhandy. When a number of pieces, balusters for instance, are to be made alike, a special measuring device is usually made use of by turners. It consists of a light stick of wood with sharpened wire brads driven into it at certain points along

its length, where the deeper cuts are to be made. After the piece is turned down roughly to size, this scriber, as it is called, is laid on the tool rest in such a way that the sharpened nails will just touch the cylinder as it revolves, thus making a line around it where it is to be cut. This, of course, saves time, for the reason that the lines are all made at once, and the distances between them are measured at the same time for all the pieces. It is not often, however, that the pattern-maker has any use for this device, as his work is seldom duplicated.

## INDEX

### A

- Amount of shrinkage in small patterns, 17.
- Annular patterns, 61, 140.
- Angles, 173.
- Arms of wheels, 99.

### B

- Bevel gear patterns, 120.
- Bit, sqr. hole, 182.
  - auger, 182.
  - center, 183.
  - drill, 183.
  - brace, 185.
  - countersink, 184.
- Black varnish, 26.
- Boxing up patterns, 59.
- Brads, 27.
- Brace bit, 185.
- Brackets, 50.
- Building up thin discs, 56.
  - patterns, 59, 61, 140.
- Brass, shrinkage of, 16.
  - for patterns, 23.

### C

- Cause of distortion in castings, 19.
- Castings, distortion of, 19.
- Casting of gland, 67.
  - of double flange bushing, 77.
  - of hook lever, 49.
  - of pulley, 93.
  - of pipe elbow, 129.

- of pipe bend, 126.
- of steam chest cover, 132.
- Cabinet turning, 199.
  - making, 1.
  - maker, 1.
- Chords of curves, 61.
- Chucks, 122, 123, 201, 203.
- Chuck, cup, 203.
  - fork, 201.
  - large, 123.
- Constructional joints, 55.
- Copal varnish, 26.
- Cores, 37.
- Core box, 39, 41.
  - prints, 38, 40, 42, 44.
  - box, finishing of, 75.
  - board, 134.
  - strickle, 134.
  - box plane, 72, 195.
  - box, conical, 74.
- Cope, 6, 7, 10.
  - bars, 7.
  - sand, 8, 9.
- Contraction, 15.
- Concentric, 161.
  - layers, 161.
  - hubs to be, 105.
- Corners in patterns, 30.
  - inside, 30.
  - outside, 30.
- Counter ribs, 57.
- Cylindrical layers, 161.
  - patterns, 61.
  - cores, 39, 110.

## D

- Distortion in castings, cause of, 19.
  - caused by shrinkage, 18
- Dividers, 173.
  - laying out angles with, 173. ¶
- Double shrinkage patterns, 23.
  - allowance for, 23.
- Dirty mold, 32.
- Drawings, reading of, 154.
- Draft on patterns, 13, 14. ¶
- Diagonal lines,

## E

- Engineer, requirements of the, 4
- End wood, 25.
  - grain to be sized, 25.
- Emery wheels, 197.
  - for grinding tools, 197.

## F

- Face plate, 201.
  - plate lathe. (Frontis-piece.)
- Faces, working, 189.
- Framing square, 171.
- Fillet, 30.
- Fillets, making, 33.
  - in patterns, reason for, 31.
  - leather, 32.
  - wood, 33.
  - wax, 34.
- Filing saws, 179.
- Fitting saws, 179.

## G

- Gauge, marking, 174.

- mortise, 174.
- Gears, 108.
  - bevel, 120.
  - spur, 108.
  - the laying out of, 111, 113, 117, 120.
  - tooth curves for, 117.
  - patterns for, 108.
  - patterns, arms for, 120.
  - patterns, teeth for, 118.
  - patterns, tooth blocks for, 113.

## Glue, 24.

- joints, 24.
- use of, 24.

## Gouge, 175.

- outside, 176.
- inside, 176.
- paring, 176.
- turning, 204.

## Grindstone, 197.

- Grinding cutting wedges, 197.
  - chisel, 197.
  - plane iron, 192.

## H

- Hand screw, 187.
- Handscrews, use of, 187.
- Handsaw, 178.

## I

- Iron planes, 190, 192.
  - castings, 2.
  - shrinkage of, 16.

## J

- Jointer plane, 188.
- Joints in patterns (constructional), 55.



- in patterns (molder's), 46.
- K
- Knife, draw, 177.
- L
- Lags, patterns built of, 60, 61.  
Lagging, 60.  
Lagging up, 60.  
Loam, 133.  
—patterns, 134.  
Leather fillets, 32.  
—the application of, 32.  
Lugs for machinist's use, 140.
- M
- Making pattern pins, 79.  
—semi - circular core box, 70.  
—pulley patterns, 93  
Marking gauge, 174.  
Master patterns, 23, 151.  
Metals, shrinkage of, 16.  
Measuring tools, 169.  
Mitre square, 172.  
Mahogany, 22.  
Mortise gauge, 174.  
Molding, 6.  
Mitre box, 186.
- N
- Nails, 27  
Nails, best for patterns, 27  
Nowel, 7.
- O
- Oil stones, 197.  
Open joints, 58.
- P
- Parting, pattern-maker's, 77.  
—molder's, 9.  
Patterns, construction of, 66.  
Pattern-making and molding (connection between), 2, 3, 5.  
Pattern pins, 79.  
—wood for, 20.  
—lathe, 54, 200.  
Pegging segments, 99.  
Plane, core box, 72.  
—rebate, 193.  
—dado, 194.  
—plow, 193.  
Planes, surfacing, 188.  
—combination, 194.  
—wood, 191.  
—iron, 190.  
Pins, pattern, 79.  
Pulley, pattern for, 93.
- S
- Segments, building with, 61.  
Screwdriver, 185.  
Spoke shave, 194, 195.  
Shrink rule, 17.  
Shake, allowance for, 17.  
Sprue pin, 9.  
Saws, 177.  
Saw, hand, 178.  
—back, 178.  
—keyhole, 178.  
—compass, 178.  
—band, 82.  
—circular, 65.  
Scale on castings, 18.  
Scales for measuring, 170.  
Scrapers, 201, 205.

Scraping a surface, 209.  
 Sap side of board, 21, 166.  
 Sandpaper, 23.  
 Sandpapering machine, 29.  
 Shellac varnish, 26.  
 Shoot board, 96.  
 Shooting joints, 96.  
 Shrinkage of iron, 16.  
   —of brass, 16.  
   —of steel, 16.  
   —of aluminum, 16.  
   —double, 23.  
 Screws, 27.  
   —in end wood, 28.  
 Stove pattern-making, 145.  
 Strickles, 134.  
 Square, framing, 171.  
   —try, 171.  
   —combination, 172.  
 Stone, oil, 197.  
 Surfacing planes, 188.

T

Taper on patterns, 14.  
 Tools for wood work, 167.  
 T bevel, 172.  
 Trimmer, 95, 98.  
 Turning lathe, 200.  
   —tools, 204, 206.

—cabinet, 1.  
 —patterns, 199.  
 —in cup chuck, 203.  
 —parted pattern, 80.  
 Thin discs, building of, 56.  
 Thin boards, building of, 56.  
 Template, 111.

## V

Varnish, yellow, 26.  
   —red, 26.  
   —black, 26.  
 Vertical sides of patterns, 15.  
 Vise, pattern-maker's, 163.

## W

Warp, allowance for, 18.  
 Warping in wood, 165.  
   —in castings, 19.  
 Wheels, gear, 108.  
 Wood, drills, 183.  
   —turner's lathe, 200.  
   —for patterns, 20.  
   —fillets, forming of, 33.

Wheels, gear, 108.  
   —arms of, 99.  
   —teeth of, 111.  
   —laying out, 117, 121.

