

A LABORATORY COURSE
IN
WOOD-TURNING

BY

MICHAEL JOSEPH GOLDEN, M.E.
PROFESSOR OF PRACTICAL MECHANICS, PURDUE UNIVERSITY

ILLUSTRATED



NEW YORK ·· CINCINNATI ·· CHICAGO
AMERICAN BOOK COMPANY

Copyright, 1897, by HARPER & BROTHERS.

All rights reserved.

W. P. 5

13:5329

153958
MAY 31 1911
SH
G56

INTRODUCTION

THE practice of wood-turning is an art relative to which there is little published, and there is, in consequence, little chance for arriving at conclusions as to the best method for performing any given operation; so there is a wide diversity in the methods by which different operators arrive at the same results. Some use one tool almost exclusively, while others use a large variety of tools.

The following exercises are designed to give the operator command of the more commonly used tools, using each for the operations for which it is especially fitted.

The first four exercises are of special importance, and the operator is urged to continue the practice of them until he can perform them easily and safely; the operations involved in the third exercise, when mastered, will be found to give special confidence.

As the exercises have been arranged to give in the most direct manner, and without repetition, the typical operations of the wood-turner, some learners may desire to add further practice in some or all of them, and, for the benefit of such, further exercises, involving similar operations, have been added in the form of an appendix. These have drawings, and, where necessary, additional instructions. The operator is urged, however, to perform the regular exercise before attempting the added one.

In wood-turning the first essential is that the material being operated on be revolved on an axis with a fair degree

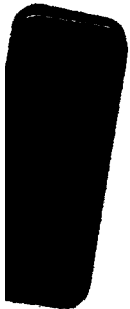

Library
of the
University of Wisconsin



4

11

1



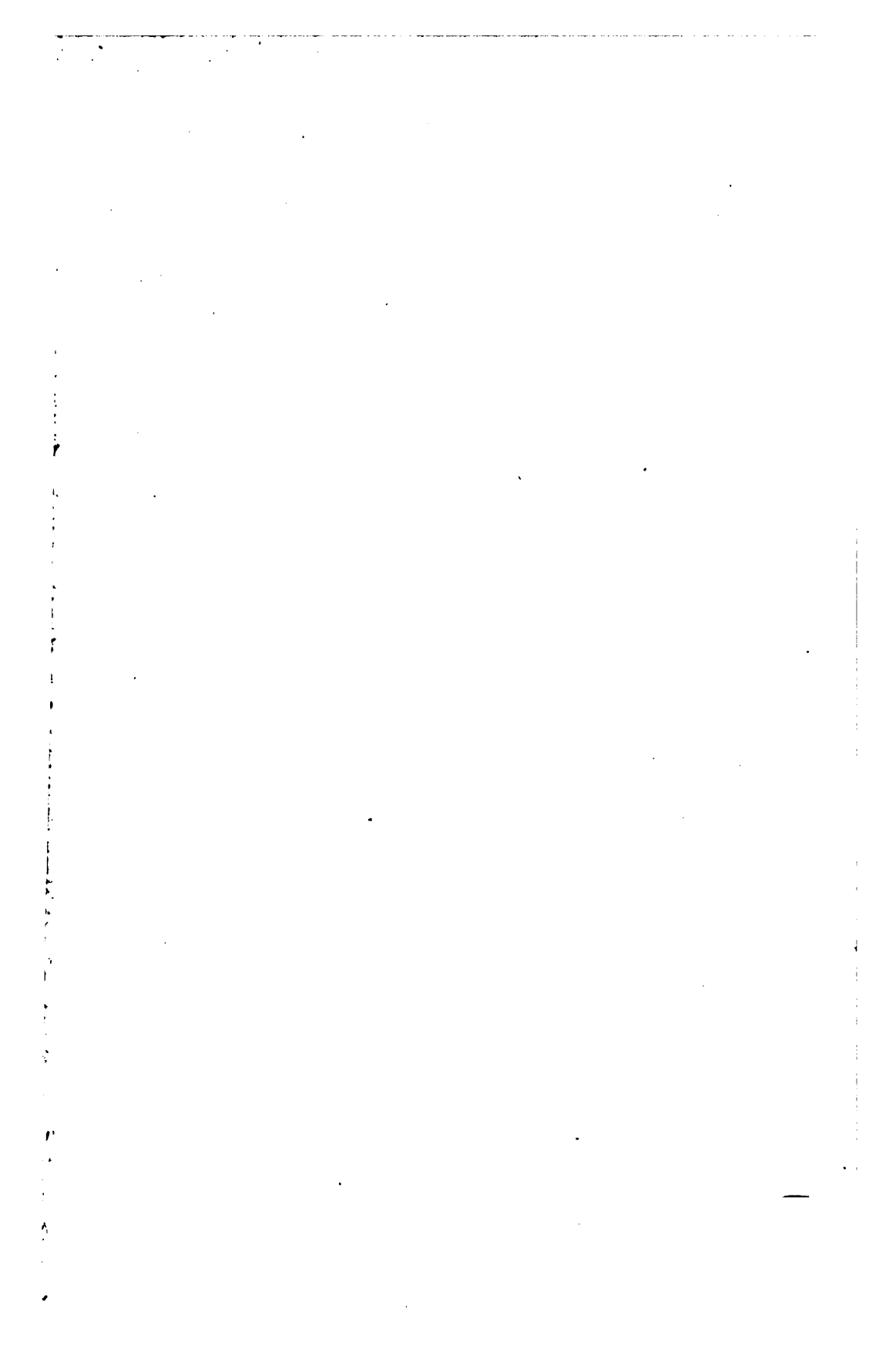

When hollowed work, such as cups and boxes, are being turned, it may be fixed with its end inside the hollow, and so better support be given to the cutting tool.

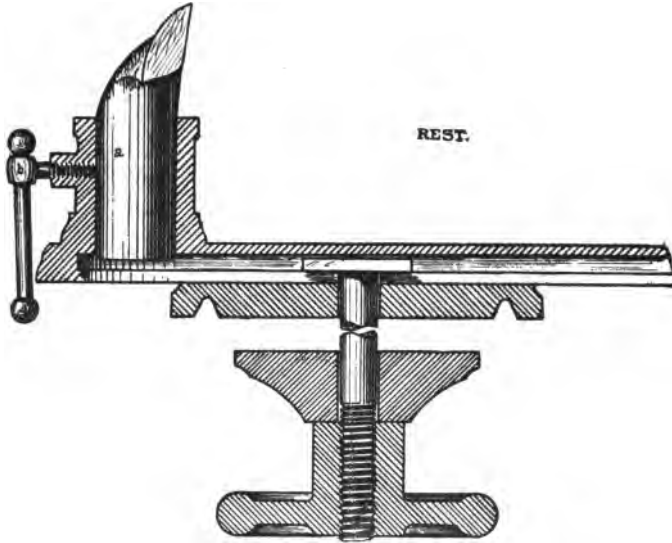

Fig. 5

The **Fork-centre**, shown in Fig. 6, is used in the *live-spindle* to make the work revolve, one end of the wood being driven on the *fork-centre* by a mallet, and then the

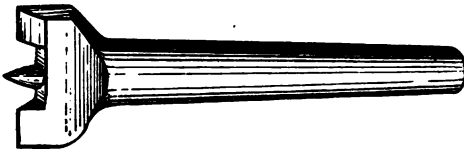

Fig. 6

Cup-centre, shown in Fig. 7, is brought against the other end.

The *cup-centre* is held in the *spindle* of the *tail-stock*, and, in common with the *cone-centre*, is spoken of as the *dead-centre*. The *cone-centre* is used when metal is being turned. They are both shown in Fig. 7.

The **Face-plate**, shown in Fig. 8, is used when the

work is of such character that it cannot be held between centres. It is attached to the *live-spindle* by the screw on the end, and is used in turning cups, balls, disks, and such other pieces as require that turning-tools be used on one end. The piece being operated on is not fastened directly to the *face-plate*,



Fig. 7

but is held in a wooden disk that is fastened to the *face-plate* by means of screws. This disk is called a *chuck*.

Face-plates are made in various diameters to suit the size of the work. When they are made more complex in character, as with raised rims and attachments in the form of adjusting-screws, they are themselves called *chucks*.

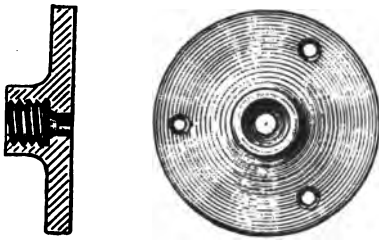

Fig. 8

The *swing* of a lathe is twice the distance from the centre of the front end of the *live-spindle* to the nearest point of the *shears*.

The *size* of a lathe is determined by the *swing* and the length of the *shears*.

The **Gouge**, shown in Fig. 9, is the tool of greatest use to

the wood-turner. Any piece to be turned is first rapidly dressed to a rough approximation to the desired form by

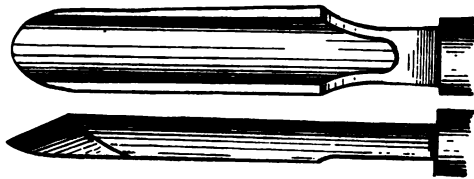

Fig. 9

means of the gouge; and most surfaces having compound curves are shaped by its use. In the hands of a skilful wood-turner it may be made to do most of the work done in the lathe. The edge should be a smooth curve of the elliptical form shown, and the bevel should be straight, as it is the guide by which the depth and outline of curves

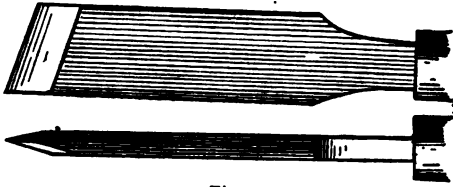

Fig. 10

are regulated. The elliptical form is necessary in order that it may be turned in a small space. The handle ought to be long in large sizes, in order

to give command of the tool during a heavy cut. The size is determined by the width across the concave side, and varies from a quarter of an inch to three inches by eighths of an inch.

The **Skew Chisel**, shown in Fig. 10, is used in finishing straight outlined work, such as the cylinder and cone, and for making convex curves and beads. It is bevelled from both sides to the cutting edge, which, instead of being at a right angle to the side of the tool, as in the carpenter's chisel, is "skewed" slightly. This gives better command of the cutting edge, because



Fig. 11

of a better position of the handle. The edge ought to be straight and the bevel flat, as by these is regulated the depth of the cut. The size is determined by the width of the blade. The larger sizes ought to have proportionally long handles.

The smaller sizes of chisels having straight edges are

sometimes ground in such manner that the edges are at right angles with the sides, to avoid the necessity for reversing them when in use.

The **Round-nose Chisel**, shown in Fig. 11, is usually made by grinding the edge of a carpenter's chisel to the elliptical

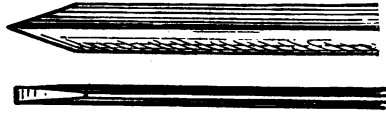

Fig. 11

form of the gouge. This tool is used in cutting recesses where the use of the gouge would be dangerous. Skilful turners frequently use the gouge for nearly all the work for which this tool is commonly used.

The **Parting-tool**, shown in Fig. 12, is used for cutting off finished work. It has, however, a greater use, in conjunction with the calipers, in regulating the outline of work, by making a narrow groove that will have a diameter at the bottom equal to some principal dimension of the work, and to which the general outline will, later, be reduced. The seventh exercise involves this use of the parting-tool. Its size is determined by the width of its cutting edge.

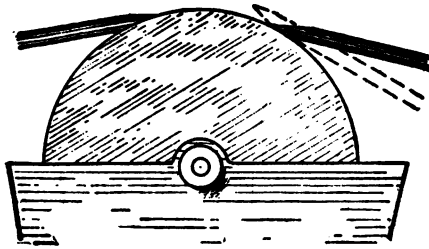

Fig. 12

Sharpening Turning - tools. — When sharpening these tools, one is liable to spoil the shape of the cutting edge unless great care is exercised, and as the shape determines the ease with which the cutting edge

is guided, an irregular shape will render the management of the tool much more difficult.

The operator takes position with the stone turning tow-

ards him, and applies the tool in the position shown by the dotted lines in Fig. 13, and at once carefully draws it back



Fig. 14

to the position shown by the solid ones, with the bevel resting on the stone. The chisel is applied in this manner to avoid the danger of touching the cutting edge against the revolving stone, and so making it duller than before. The bevel is held square across the face of the stone, as shown in Fig. 14, where the solid lines show the position when one

side is being ground, and the dotted lines when the other one. The tool should be moved slowly across the face of the stone, so that the whole of the face may be used, and it must not be allowed to rock, as that would round the bevel. The position

of the operator is shown in Fig. 15. The grinding is complete when the ground surface reaches the cutting edge, and this can readily be seen by holding it so that the light from a window falls across it. If the grinding be continued after this, the extreme end, becoming thin from the grinding, bends away from the stone, producing what is

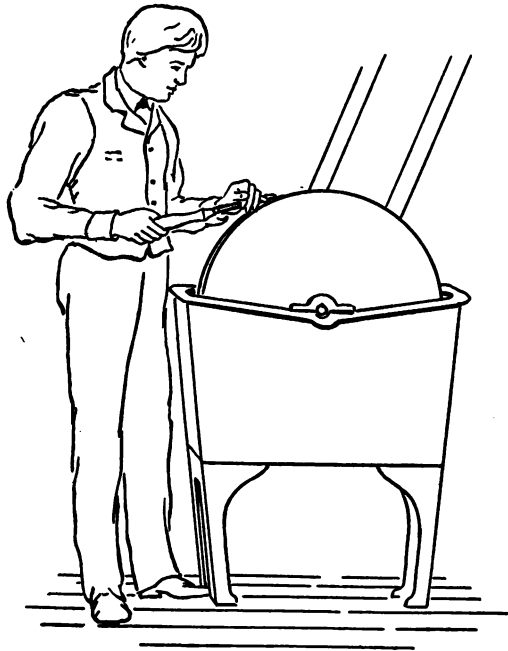

Fig. 15

called a "wire edge." The wire edge will have to be broken off before the tool can be properly sharpened, and this is usually done just before it is applied to the whetstone. It may be done by drawing the cutting edge in the direction of its length across the grain of a piece of soft wood.

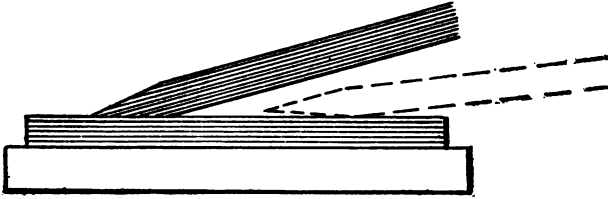

Fig. 16

The edge left by the grindstone is too rough for use in turning, so to secure the necessary smoothness and to further sharpen the tool the whetstone is used. The chisel is applied to the whetstone with the same care with which it was applied to the grindstone. It is first placed in the position shown by the dotted lines in Fig. 16, then raised to that shown by the solid lines, and is then moved steadily back and forth on the stone; this operation being performed on both bevels until it is sharp. The manner of grasping the chisel during the operation of whetting is shown in

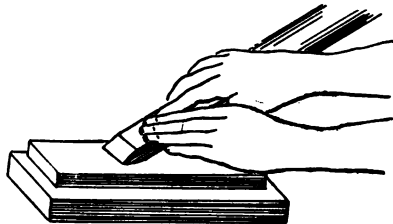

Fig. 17

Fig. 17. The chisel is held in the right hand, and the fingers of the left hand used to steady it. When the sharpening is nearly complete, the tool is frequently turned over from one bevel to the other and given a few rubs on each. Any fine wire edge now formed may be removed,

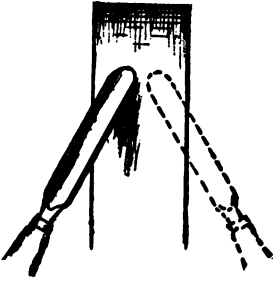

Fig. 18

as before, by drawing the edge through a piece of wood, or it may be "buffed" off by rubbing the edge on a leather strap or on the palm of the left hand.

The gouge may be ground by being held against the grindstone in the manner shown in Fig. 18, a manner similar to that for holding the skew chisel. It must not be held in one position, but must be slowly rolled on the bevel, so that the part in contact with the stone is constantly changing. It will pass from the position shown by the solid lines in Fig. 18 to that shown by the dotted ones, and then back again; and this should be continued during the process of grinding.

A grindstone having a groove made in its face is used where there are many gouges to be ground. The groove may be made near one side, as shown in Fig. 19.



Fig. 19

An oil-stone slip is used to whet the gouge, and is applied to the bevel in the manner shown in Fig. 20. After the bevel on the outside of the gouge has been whetted, the round edge of the slip may be rubbed against the inside, but care must be taken that the slip has contact along its whole edge with the inside of the gouge.



Fig. 20

The round-nose tool is made from a narrow carpenter's chisel, and is ground and

whetted in nearly the same manner as the gouge, so no special instruction is necessary to do it.

The parting-tool is sharpened as the skew chisel is, except that the edge is not to be skewed.

The lathe ought to come fitted with the following parts: a fork-centre, cup-centre, cone-centre, face-plate, tee-rest, and, when it is driven by mechanical power, a counter-shaft with cone-pulleys, and fast and loose pulleys.

The following tools will be found to make a satisfactory set, and must be bought apart from the lathe:

- 1 skew chisel and 1 turner's-gouge, each 1 inch wide.
- 1 " " 1 " " " $\frac{1}{2}$ " "
- 1 " " 1 " " " $\frac{1}{2}$ " "
- 1 round-nose chisel, $\frac{1}{4}$ inch wide.
- 1 cutting-off tool, $\frac{1}{2}$ inch wide.
- 1 pair-wing calipers, 6 inches.
- 1 pair-wing dividers, 6 inches.
- 1 wooden mallet—light weight.
- 1 oil-can.

The following table of speeds may be used during the exercises:

DIAMETER OF WORK	REVOLUTIONS PER MINUTE	SURFACE SPEED IN FEET PER MINUTE
1 inch	about.....3000	about..... 785
2 inches	"2500	"1308
3 "	"1500	"1178
5 "	"1000	"1259
8 "	" 600	"1257
12 "	" 600	"1880
18 "	" 300	"1414
24 "	" 250	"1571

In each case the speed ought to be slower by one change on the cone-pulley when the work is started and until it has been turned to the round form.

When the work is turned plankwise, the starting speed would be slower by yet another change.

FIRST EXERCISE

Material.—Poplar or pine, 3" × 3" × 8".

Exercise.—To turn a smooth cylinder and mark spaces across it 1 inch apart.

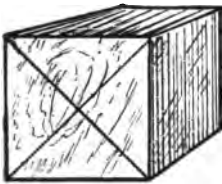

Fig. 21

Use the fork-centre in the head-stock and the cup-centre in the tail-stock.

Find the centre of both ends of the wood, either by drawing diagonals, as shown in Fig. 21, or by setting the dividers to as nearly one-half of the least

diameter as they can be taken without measuring, and then, resting the faces of the stock in succession on some flat surface, drawing lines across the ends in the way shown in Fig. 22. These lines will show as in Fig. 23, and the centre of this smaller figure may be easily guessed, and

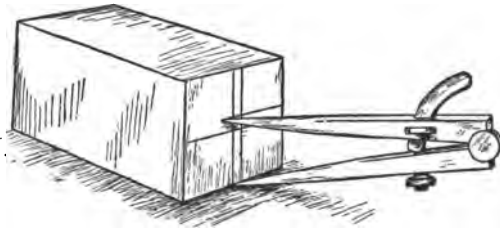

Fig. 22

will be nearly the centre of the end of the block. Now place the centre, so found, against the point of the fork-centre and drive the stock against the fork with a few light blows of the mallet until the fork penetrates the wood for a short distance, and then advance the cup-centre against the other end, and force it in also for a short

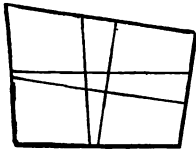

Fig. 23

distance. Put a few drops of oil on the wood where it has contact with the cup-centre. If the dead-centre be forced too strongly against the wood, it will pinch the live-centre against its bearings and stop it from turning or cause it to heat. The pressure can be tested by revolving the live-spindle by hand.

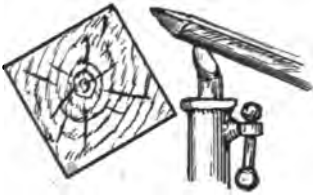

Fig. 24

Start the lathe, and adjust the belt to the position that will give the proper speed of revolution—usually the speed next to the slowest. When it is desired to change

the position of the belt on the cone-pulley, it must first be “shifted” to the smaller and then to the larger of the steps on which it is to run; examination will show that otherwise the belt would be stretched.

The wood is first to be turned to a rough cylinder with the 1-inch gouge. To do this, adjust the rest to the position relative to the wood shown in Fig 24, so that the cutting tool may have its handle slightly lower than its edge, and the edge above the centre of the work. This makes the action of the gouge a cutting one, whereas, if the edge were lower, the action would be scraping.

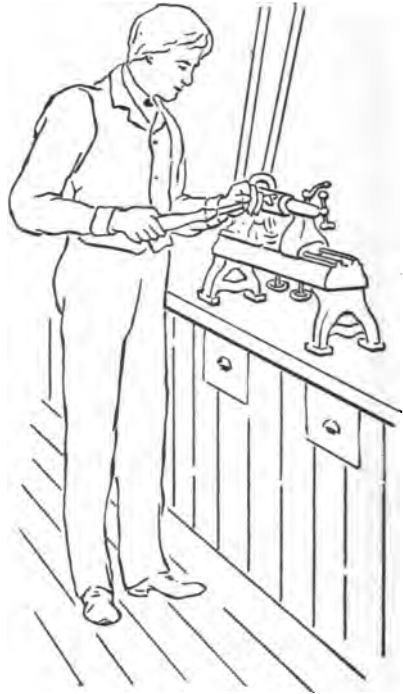

Fig. 25

The general position of the operator when using the gouge is shown in Fig. 25. The right hand grasps the handle near the end and is steadied in its movement by resting against the side, as shown. The left hand presses the gouge firmly on the rest and moves the cutting edge along the work, regulating the depth of the cut by keeping contact with the rest.

It will be found that if the side of the hand lose contact with the rest, the depth of the cut cannot be regulated so nicely.

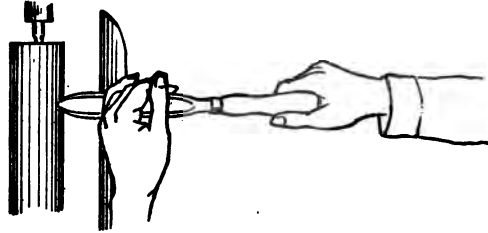

Fig. 26

The position of the hands is further shown in Fig. 26—a view of the hands from above.

Advance the cutting edge cautiously, and start a light cut near one end of the wood, and carry the cut out to the end near which it was started. The end of the rest ought to be outside the end of the wood, as shown in Fig. 27.

Start a second cut a short distance inside the first and continue it to the end also; and repeat this until the end is round and $2\frac{3}{4}$ inches in diameter. The end will appear as in Fig. 27. The diameter is measured between the points of the calipers, used as shown in Fig. 28. If the

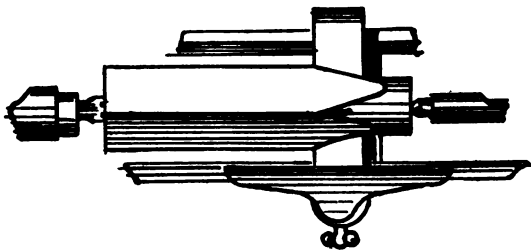

Fig. 27

points of the calipers are not held square across the work, the measurement cannot be correctly taken.

It will be found

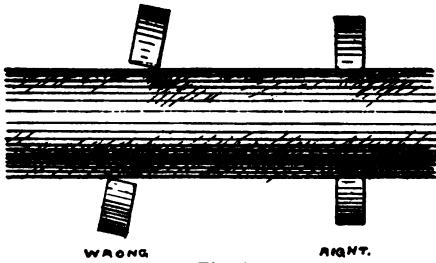

Fig. 28

better to stop the lathe when using the calipers during the few first exercises, though, later, they may be used while the work is revolving.

Change the position of the rest to the other end of the wood, and turn that down in the same manner as the first, after which place the rest at the centre, and turn the centre to the same diameter as the ends, using the ends as guides in determining the size. There will be no need of the calipers.

Finishing with the Skew Chisel.—In using the skew chisel, the rest is set higher than when using the gouge—the height is determined by the stature of the operator, the rest being so set that it can be most conveniently used.

The manner of grasping the chisel is nearly the same as with the gouge; it is applied to the work, however, in an entirely different manner.

In using the skew chisel for straight outline work three conditions relative to the position of the chisel must be borne in mind: first, the chisel must have contact of its bevel with the surface being cut, as in Fig. 29; second, the acute angle of the edge must be kept clear of the work, and the cutting done between the corners, as in Fig. 29 and Fig. 30; and, third,

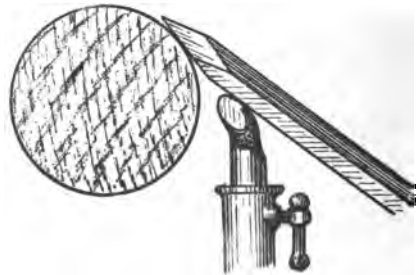

Fig. 29

the chisel must have contact with the rest, as in Fig. 29 and Fig. 31.

That the bevel of the chisel may be brought into position without danger of the edge catching in the revolving wood,

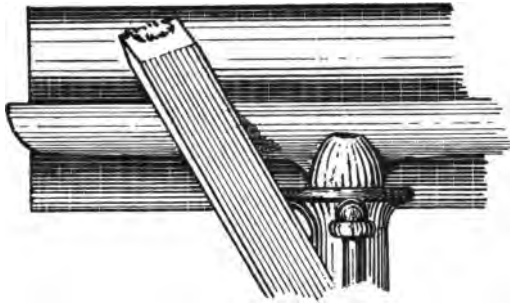

Fig. 30

first lay it on the work in the position shown in Fig. 32 and Fig. 33, and then draw it back, swinging



Fig. 31

the handle to the right, until it arrives at the position shown in

Fig. 29 and Fig. 30. In these sketches the left hand is not shown, that the position of the tool may be shown more clearly; the hand, however, grasps the tool as in Fig. 34, the right hand holding the end of the handle, as when using the gouge.

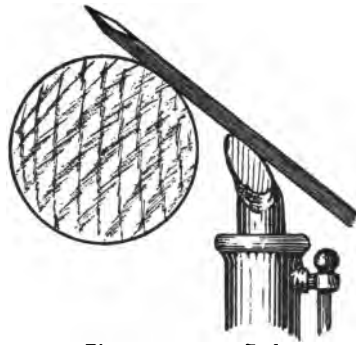

Fig. 32

End

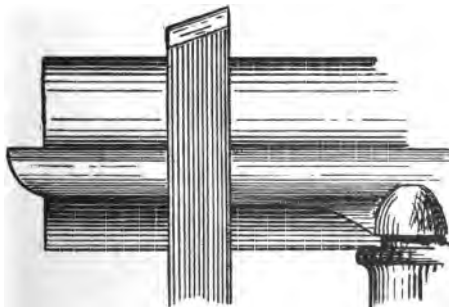

Fig. 33

Side

The bevel of the chisel should now rest on the revolving work in the direction shown from [x] to [y] in Fig. 35. Raise the handle slightly until the edge cuts into the surface about $\frac{1}{8}$ of an inch. By

advancing the chisel for a short distance a smooth surface is produced where the chisel cuts, and this smooth surface

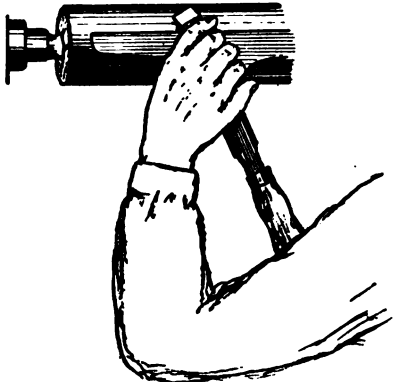

Fig. 34

may be used as a guide in regulating the depth of the cut as the cutting edge is advanced to the end of the wood. Start the cut about 2 inches from the tail-stock end and produce it to the other end.



Fig. 35

Now turn the chisel over and bring the other bevel into con-

tact with the surface, as the first one was, except that the

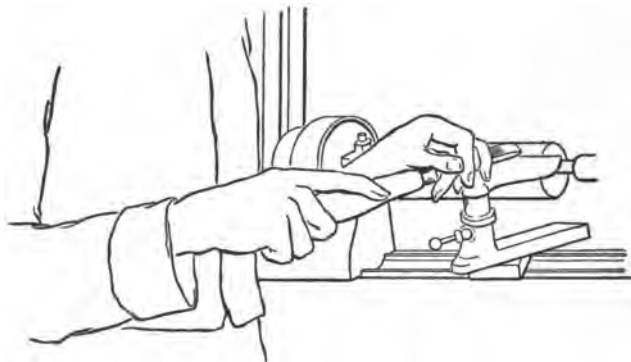

Fig. 36

handle must be swung to the left, and finish the cut to the tail-stock end of the wood. The position of the hands when cutting to the tail-stock end is shown in Fig. 36.



Fig. 37

Repeat these cuts un-

til the work is reduced to $2\frac{1}{2}$ inches in diameter from end to end and the surface is smooth, and then mark the surface of the work, with the dividers, to the divisions shown in Fig. 37.

Set the dividers to 1 inch between points, and placing one point at the end of the wood, and just clear of it, advance the other point until it scratches the surface lightly, holding the dividers in the position

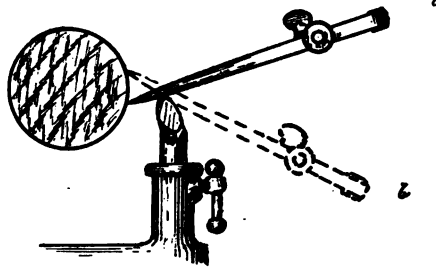

Fig. 38

shown by the solid lines in Fig. 38. If held in the position shown by the dotted lines, they may catch into the wood and be thrown from the hand. Next, set the dividers to 2 inches, and mark that dimension; and increase the opening of the dividers by 1 inch for each of the remaining dimensions.

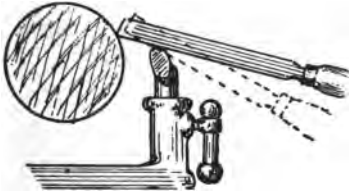

Fig. 39

To finish the exercise, remove the "burr" raised by the dividers. Do this with the acute corner of the skew chisel, as shown in Fig. 39, first placing the chisel in the position shown by the dotted lines, and then raising the handle until the corner cuts off the burr. The burr on one side is removed by holding the chisel in the position shown by the dotted lines in Fig. 40, and, on the other side, in that shown by the solid ones.

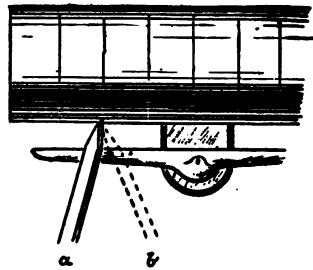

Fig. 40

SECOND EXERCISE

Material.—Poplar or pine, 3" × 3" × 8".

Exercise.—To turn a piece of the form and dimensions shown in Fig. 41.

Turn a smooth cylinder 2½ inches in diameter in the same manner that the cylinder was turned in the first exercise. Make divisional marks around it with the dividers, using the dimensions given in Fig. 41 for the spaces.

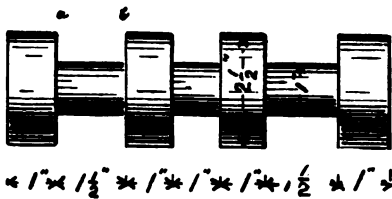

Fig. 41

Recesses are to be cut in the alternate spaces between the marks. Start a recess by holding the

skew chisel in the position shown in Fig. 39, the acute corner down and a little inside the mark, and with the bevel on the side on which the cut is started, having the direction in which the cut will be made, as shown in Fig. 42 and Fig. 39. Now raise the handle and force the corner of the chisel a short distance into the wood, and repeat this on the other side of the space to be cut. Remove the

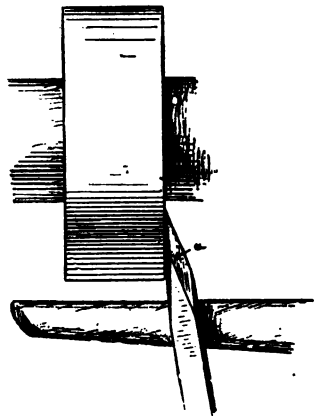

Fig. 42

material between these two cuts in the same way as that in which the surface was made smooth, except that now the obtuse corner of the chisel is used in the cutting, instead of the edge between the corners.

Use the acute corner of the chisel in cutting the sides, and take care that the obtuse corner is clear of the wood by making the edge take the position relative to the side shown in Fig. 42 and Fig. 43 at [a].

Keep the corner of the chisel not in use clear of the work when removing the material between the sides.

Finish the central recess first and then the others.



Fig. 43

THIRD EXERCISE

Material.—Poplar or pine, 3" × 3" × 8".

Exercise.—To cut the beads and fillets shown in Fig. 44, on a cylinder.

Turn a smooth cylinder $2\frac{1}{2}$ inches in diameter, and mark it off to the dimensions shown in Fig. 44.

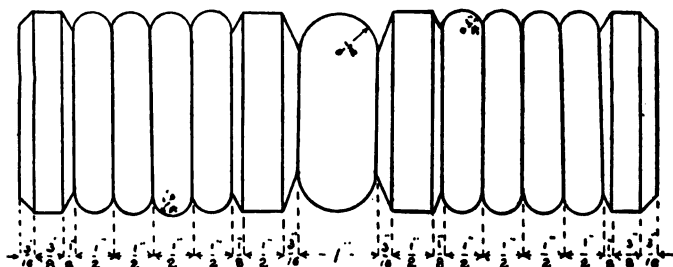

Fig. 44

It will be found better to first cut grooves at the points of division, as shown in Fig. 45, as this helps to define the beads and keeps the size more nearly right. These grooves are cut in the same manner that the recesses in the second exercise were cut—with the acute corner of the chisel, the obtuse corner being held clear of the surface being cut. Use the obtuse corner in cutting the convex curves. Place



Fig. 45

the chisel in the position for smoothing the work used in the previous exercise, except that the obtuse corner is now to be used instead of the

edge between the corners. Cut the curve by passing the chisel from the position for cutting across, shown in Fig. 46, to that for cutting in, shown in Fig. 49, passing it

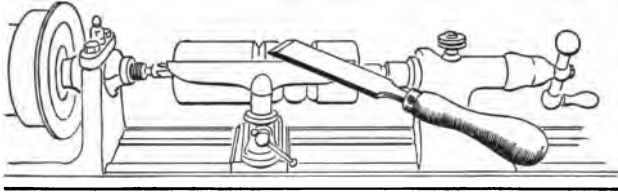

Fig. 46

through the positions shown in Fig. 47 and Fig. 48. The movement must be smooth and continuous, and must not be hurried, the tendency being to hurry the latter part of it.

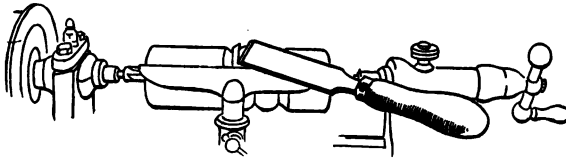

Fig. 47

Take care that the handle is swung around and at the same time raised slightly, as shown in the figures. This

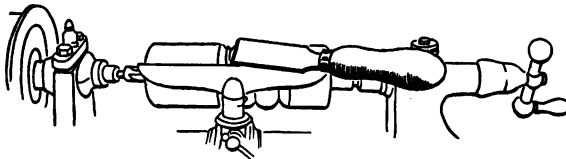

Fig. 48

keeps all of the edge but the cutting corner free of the work, and keeps it from cutting into and tearing the surface. The chisel passes from the position shown in plan

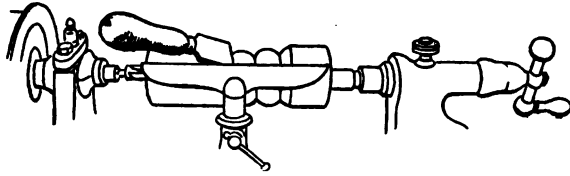

Fig. 49

at [a], Fig. 50, to that shown at [b]; the blade at the time being rolled on its lower edge, as from [c] to [d] in same sketch. The cut is started near the centre of the space, and is terminated at the bottom of the groove already cut.

When cutting the other side of the curve, start the chisel as when cutting to the tail-stock end. Use the movements just described, only from left to right instead of from right to left.

In cutting curves of this description the chisel must be well ground, the edge straight, and the bevel flat, or the necessary support and guidance cannot be given to it. If any part of the edge but the corner used in cutting be allowed to come into contact with the wood, it will be likely to catch into and to tear the surface.

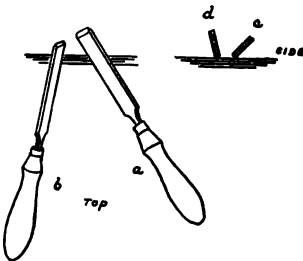

Fig. 50

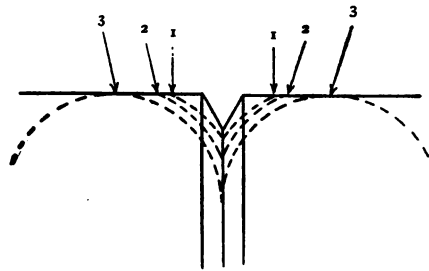

Fig. 51

The aim should be to so combine the features shown that the cut will be a smooth and continuous one.

The curve at the centre is greater than the others, so the grooves at the sides of it are deeper. In forming large beads several cuts should be taken, as shown in Fig. 51.

FOURTH EXERCISE

Material.—Poplar or pine, $3\frac{1}{4}'' \times 3\frac{1}{4}'' \times 8''$.

Exercise.—To cut compound curves of the form shown in Fig. 52.

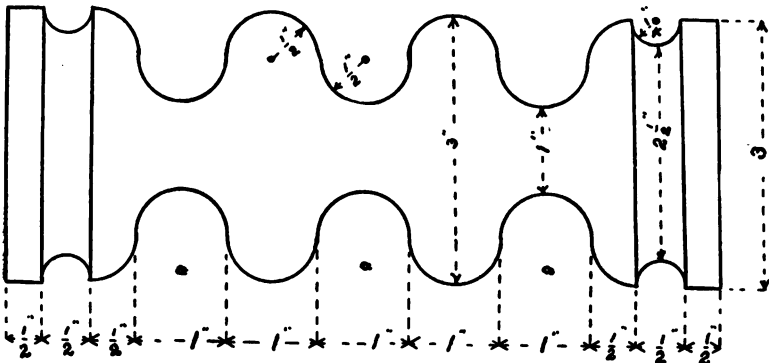

Fig. 52

Turn the wood to a smooth cylinder 3 inches in diameter, and mark it to the dimensions shown in Fig. 53. Both concave and convex curves are to be half-circles in outline. The concave curves are to be cut first, in the divisions marked [a], with the $\frac{1}{2}$ -inch gouge. The material between the lines is removed by a series of cuts, as shown in Fig. 54. The exact

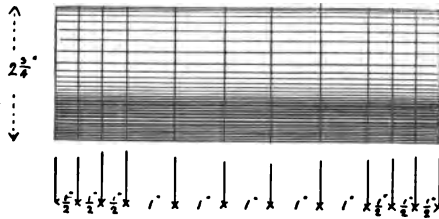

Fig. 53

height at which to place the rest cannot be given, as it should be that which will be found most convenient. It ought to be above the centre of the work, as when using the skew chisel.

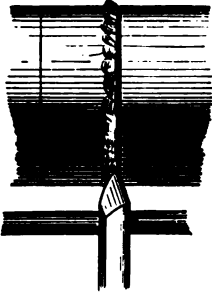

Fig. 54

Start the cut on the right-hand side of the middle division by placing the gouge in the position shown in Fig. 55, the cutting portion of the edge being square across the work. If the cutting edge is not square across the work when it is pressed



Fig. 55

into the wood, it will run off to one side or the other, as it may have been started, and so mar the stock. Force the gouge a short distance into the work, as shown in Fig. 54, and then withdraw it and repeat the operation on the left side, as shown in Fig. 56, forcing the gouge farther into the wood, however, as shown in Fig. 57, and gradually turn it over on its back during the cut, as shown

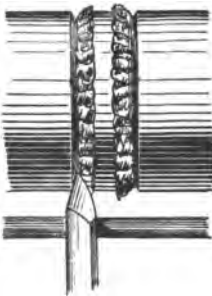

Fig. 56

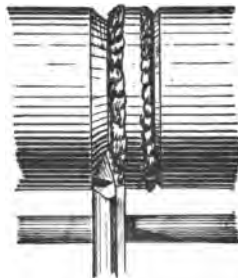

Fig. 57

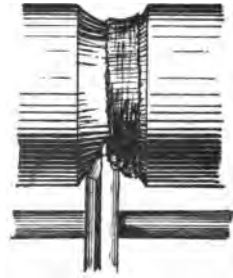

Fig. 58

in Fig. 58, until it arrives at the position shown in Fig. 59. The cut is again started on the right-hand side, but with the edge nearer the boundary-line for the hollow, and the bevel more nearly a right angle with the axis of the work,

as shown in Fig. 60. Finish this cut from the left side as the first one was, and so continue the cutting until the gouge has taken the position shown in Fig. 61, and the cut is of the right depth and shape. The sides are straight for half the depth.

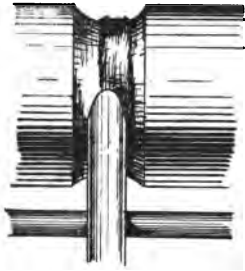

Fig. 59

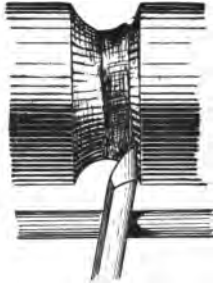

Fig. 60

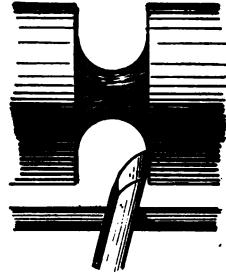

Fig. 61

Next cut the convex portion of the curve by placing the gouge in the position shown in Fig. 62, and using it in nearly the same manner that the skew chisel was in the last exercise. The handle is swung around in a nearly similar manner, but must be elevated to a greater extent than the chisel handle was. The whole movement is so nearly similar to that of the skew chisel that more detailed description is not necessary.

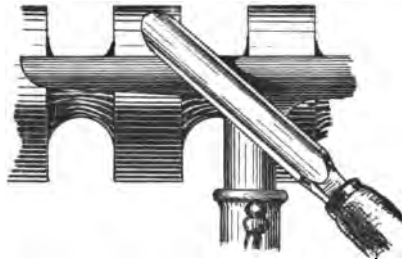

Fig. 62

The small concave curves near the ends are cut in the same manner that the larger ones are, the $\frac{1}{4}$ -inch gouge being used.

FIFTH EXERCISE

Material — Poplar or pine, 3" × 3" × 8".

Exercise. — To cut the material to the form and dimensions shown in Fig. 63.

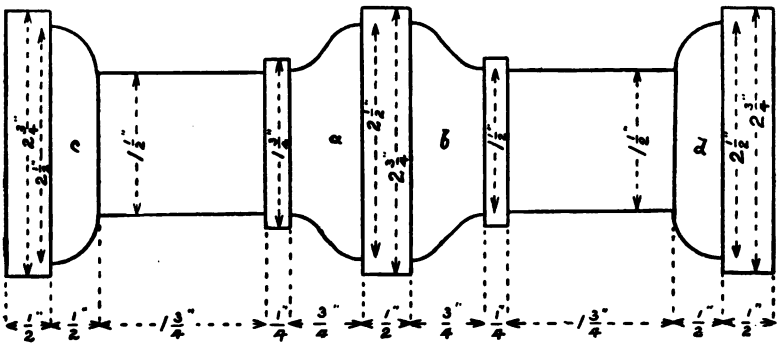

Fig. 63

First turn the material to the form and dimensions shown in Fig. 64, using the skew chisel. Next cut the part

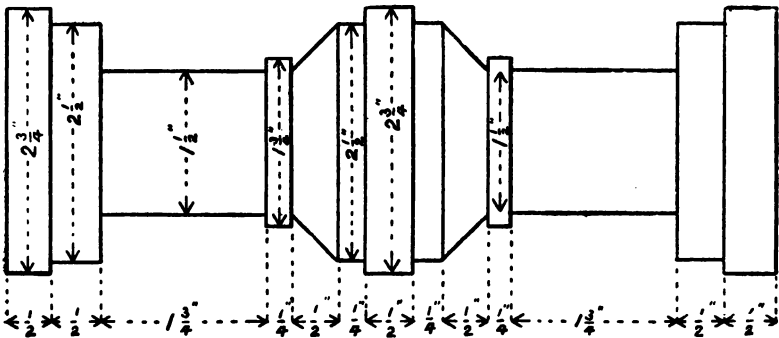

Fig. 64

marked [a] with the $\frac{1}{4}$ -inch gouge. Start the cut on the right-hand side, holding the gouge in the position shown in Fig. 65, and keep the cutting part of the edge supported on the bevel directly behind it. As the cut proceeds, roll the gouge on its back in such manner that the cutting portion of the edge changes from the right-hand side to the left-hand side, where the cut finishes, as shown in Fig. 65, Fig. 66, and Fig. 67. During this cut each portion of the cutting edge is successively brought into use, as shown. Take care to have the portion of the edge that is



Fig. 65

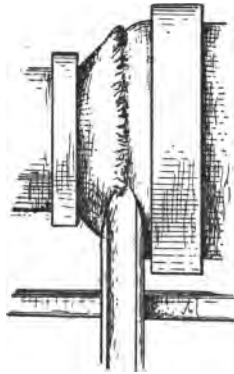

Fig. 66



Fig. 67

being used supported, by having the part of the bevel directly behind it in contact with the revolving stock, and the corresponding part of the back of the chisel in contact with the tee rest, as shown in the sketches. The gouge must be grasped quite firmly, and the handle raised slightly during the cut. The cut is started against the shoulder on the right-hand side and finished against the one on the left-hand side of the curve to be cut.

The curve marked [b] is cut in a similar manner, the direction of the cut, however, being from left to right instead

of from right to left, as here the cut starts against the shoulder on the left-hand side and finishes against the one on the right-hand side.

Cut the curve marked [c] by starting the cutting edge against the shoulder on the right-hand side in the same manner that it was started when cutting [a], and roll the

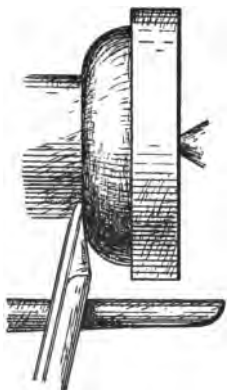

Fig. 68

gouge on its support from right to left, as before, carrying it slightly farther in the movement, and drawing it a very little way backward towards the end of the cut. The cut starts against the shoulder on the right-hand side, in the position shown in Fig. 65, and finishes against the cylinder on the left-hand side, in the position shown in Fig. 68. In this cut the handle of the gouge is swung around to a slightly greater extent than when cutting the curve [a].

The part marked [d] is cut in a similar manner to [c], the movements, however, being from left to right instead of from right to left.

SIXTH EXERCISE

Material.—Hickory or ash, 2" × 2" × 8".

Exercise.—To make a chisel-handle of the form and dimensions shown in Fig. 69.

It is sometimes necessary to turn a number of pieces to be precisely alike of such things as handles, balusters, and

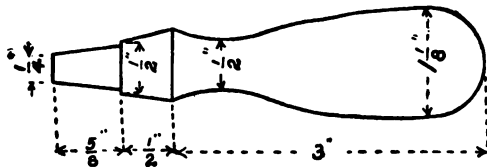

Fig. 69

similar articles. To avoid the necessity for frequent adjustment of the measuring tools a "templet" of the form shown in Fig. 70 is made. The templet may consist of a

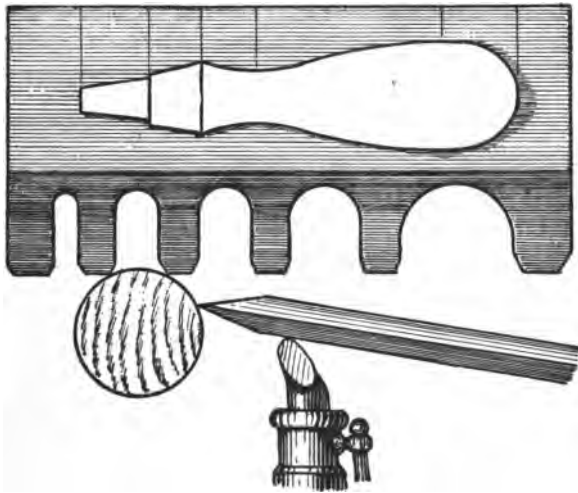

Fig. 70

piece of sheet-iron, or of wood and iron, as shown in the sketch, or be entirely of wood. The principal dimensions for length are notched on one edge, and the caliper sizes to correspond are cut out of the other, as shown in Fig. 70.

To Make the Handle.—First turn the stock to the diameter represented by the largest opening in the templet, and then hold the notched edge of the templet against it, and mark lines around it to correspond to the notches on the edge of the templet, as shown in Fig. 71. Next, with

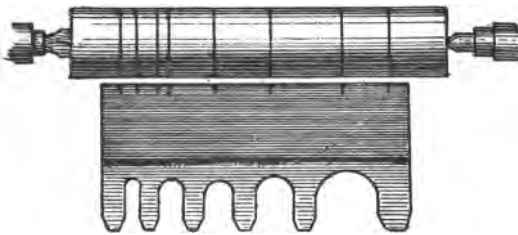

Fig. 71

the parting-tool, cut grooves into the wood where the marks were made, using the notches cut from the edge of the templet, instead of the calipers, to determine the diameter of the work, as shown in Fig. 70,

using the opening that corresponds to the notch whose mark is being cut. After the grooves have been cut, the work will have the form shown in Fig. 72. Next, using the skew chisel and gouge, finish the work to the desired form, referring frequently to the pattern, to be sure the wood is assuming the correct outline.

After the wood has been cut to the desired form, it may have a coat of oil given to it, and then be polished by rubbing



Fig. 72

it with a rag while it is revolving, or a coat of varnish may be given to it.

Good results may be gotten in this and the succeeding exercises by using a shellac varnish made by dissolving amber shellac in alcohol and applying a thin coat with a brush. The wood ought then to be put away for an hour to dry and harden, when it will be found that the varnish has caused small particles of the wood to project from the surface. These may be removed with a piece of fine sandpaper, care being taken that the sandpaper is applied with only enough pressure to remove the hard particles and not to scratch the surface. The surface is then wiped clean of dust and another coat of the varnish applied, and this is continued until the desired effect is obtained.

When the varnishing and polishing are complete, trim off the ends by which the piece was held in the lathe.

Balusters and other similar pieces may be turned in this way, a way used when there are many pieces to be turned that are to be alike.

SEVENTH EXERCISE

Material.—Gum or cherry disk, $5\frac{1}{2}$ " diameter, 1" thick.

Exercise.—To turn the disk to the form and dimensions shown in Fig. 73.

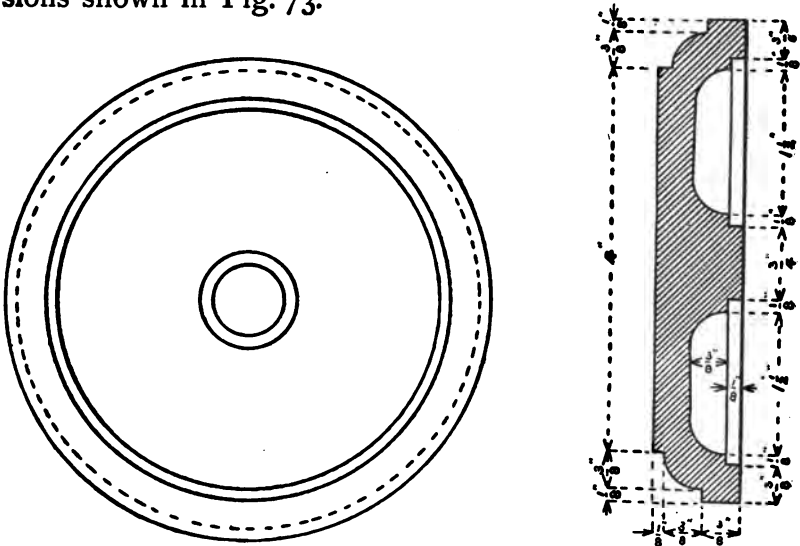

Fig. 73

Fasten the disk to a face-plate with $\frac{3}{4}$ -inch screws, placing the centre of the plate over the centre of the disk, and selecting such a face-plate that the holes left in the disk by the screws will be cut away in the subsequent turning—that is, the holes made by the screws must come in some place where a recess will be turned in the disk. Screw the face-plate easily on the spindle of the head-

stock; if screwed on tightly it will "jam," and be difficult of removal. Adjust the driving-belt so that the proper speed will be gotten, and with

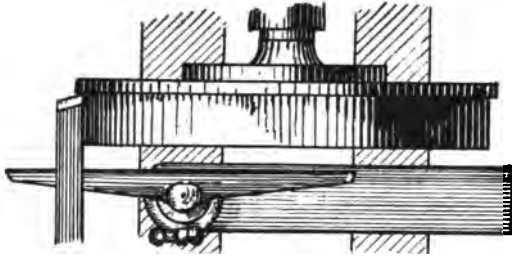

Fig. 74—Top



Fig. 75—Front

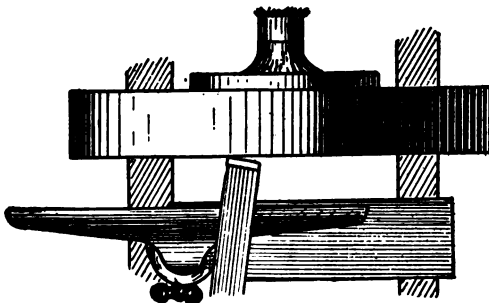

Fig. 75—Top

the 1-inch skew chisel used as shown in Fig. 74—that is, as a scraping instead of a cutting tool—turn the edge of the revolving disk true, making the diameter to be 5 inches. Next "face" the disk by holding the same chisel in the position shown by the views of Fig. 75, one corner of the chisel having contact with the work, and make the face flat and smooth by advancing the chisel across the work in the direction of the corner having contact. The chisel must be sharp, or the work will not be smooth.

Next make two

pencil-marks around the edge of the disk—one $\frac{1}{8}$ inch back from the face, and the other $\frac{1}{8}$ inch back from the face. Make

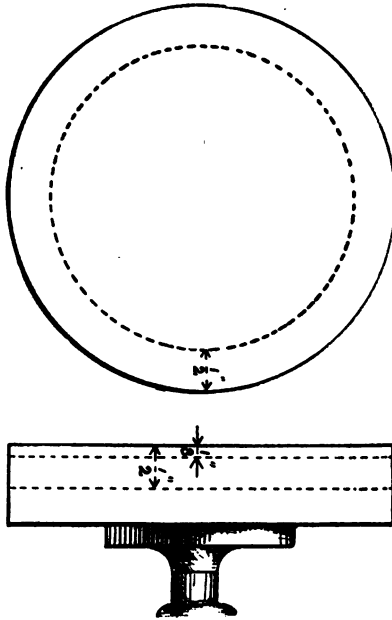

Fig. 76

another on the face $\frac{1}{8}$ inch in from the edge. These marks are shown by the dotted lines in Fig. 76. Now, with the chisel held as shown in Fig. 74, and using the pencil-marks as guides, cut a recess around the edge, as shown in Fig. 74. On this recess, and $\frac{1}{8}$ inch back from the face of the disk, make another pencil-mark, and with this mark and the one made on the face as guides, cut the edge of the disk to the form shown in Fig. 77. Round the fillet left on the corner with the $\frac{1}{8}$ -inch skew chisel, held as shown in Fig. 77;

and then, after varnishing and polishing, remove the work from the face-plate.

Instead of the disk just removed from the face-plate, fasten to it one of pine, 1 inch thick and 6 inches in diameter. True the edge of this disk, and then face it in the same way that similar operations have been already performed. Next mark a circle that will be a very little less than 4 inches in diameter on the face of the disk, and, using this circle as a guide, cut a recess $\frac{1}{8}$ inch in depth in the face.

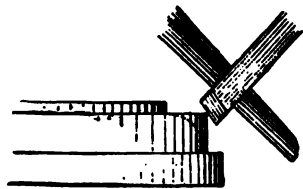

Fig. 77

This is done with the skew chisel held and used as when cutting the edge of the first disk. This recess is now to be very carefully enlarged in diameter until the projection that was turned on the first disk will fit tightly into it, when on pressing the disks together they will have the appearance shown in Fig. 78. The first disk is said to be "chucked," the second being the chuck.

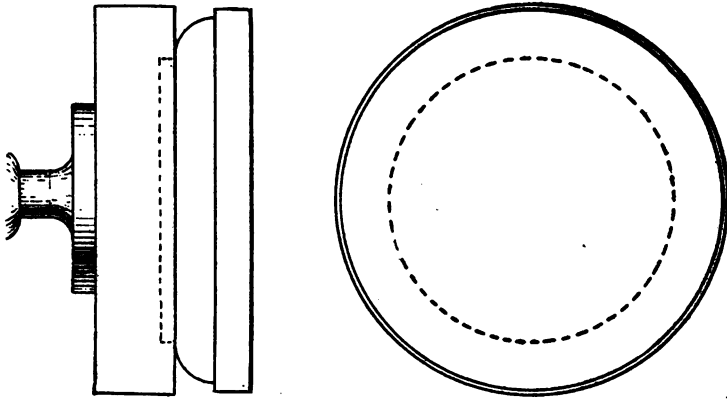

Fig. 78

Next mark on the face of the outer disk a circle 4 inches in diameter and another $\frac{3}{4}$ inch in diameter, and cut a recess $\frac{1}{8}$ inch in depth between these marks with the skew

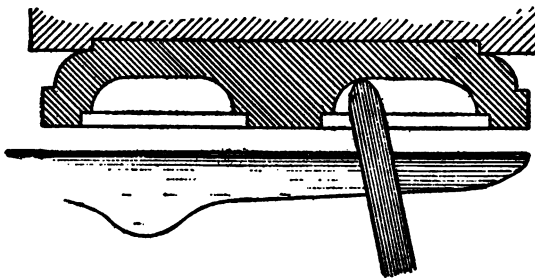

Fig. 79—Top section

chisel. On the bottom of this recess, $\frac{1}{8}$ inch from the sides, make two more circles, and with these as guides cut another recess, of the form shown in Fig. 79, into the disk. As the sides of this recess are rounded, use the round-nose chisel to cut it. The round-nose chisel is used as a scraping tool, as the skew chisel was during this exercise, and its position when in use is shown in Fig. 79.

Varnish and polish this face also, and then remove it from the chuck.

EIGHTH EXERCISE

Material.—Gum or cherry disk, $3\frac{1}{4}$ " diameter, $\frac{7}{8}$ " thick.

Exercise.—To turn a rosette of the form and dimensions shown in Fig. 80.

Fasten the disk to a screw-plate of the kind shown in Fig. 89, and turn it

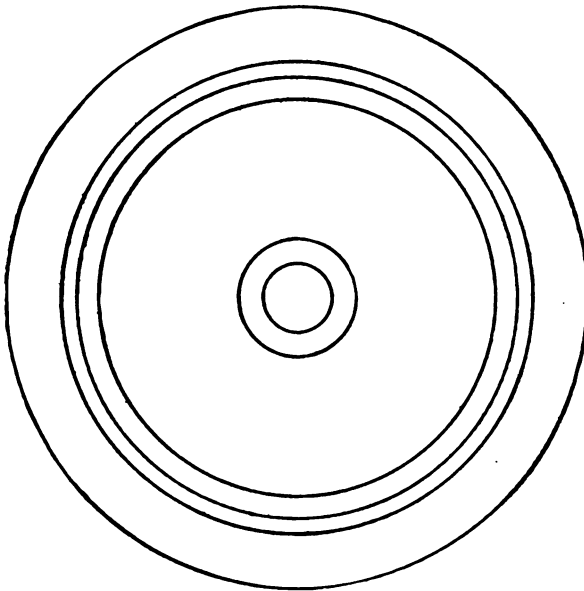
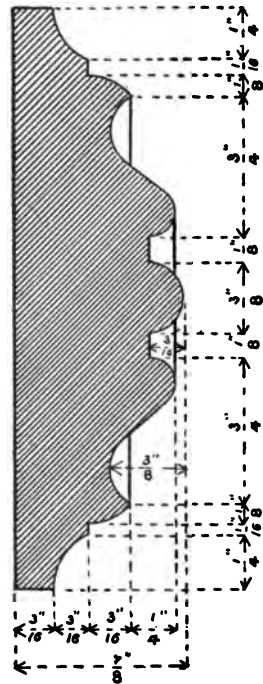

Fig. 80



to the form shown in Fig. 81. This is done with the skew chisel, except the recess that is $\frac{1}{8}$ inch in width, and this

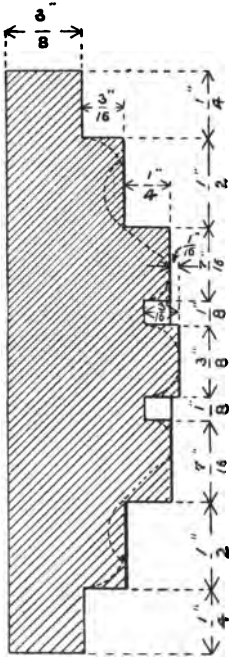

Fig. 81

latter may be cut with the parting-tool. The work is next cut to the form shown in Fig. 80, the curves being cut with the skew chisel and the round-nose chisel, the operations being similar to those already performed.

Varnish and polish the work, and remove it from the screw-plate.

When a number of rosettes of this character are to be turned, a templet, similar in its use to that employed in the Sixth Exercise, may be prepared and used. Only the principal dimensions, such as those for the steps in Fig. 81, need be marked on it, and from these dimensions the operator can produce a sufficiently close degree of similarity in the successive pieces to serve his purpose.

NINTH EXERCISE

Material.—Gum or cherry disk, $7\frac{1}{2}$ " diameter, 1" thick.

Exercise.—To turn the material to the form and dimensions shown in Fig. 82.

Fasten the disk to a face-plate with 1-inch screws, and then turn the face smooth and the edge true, making it to be 7 inches in diameter. Next,

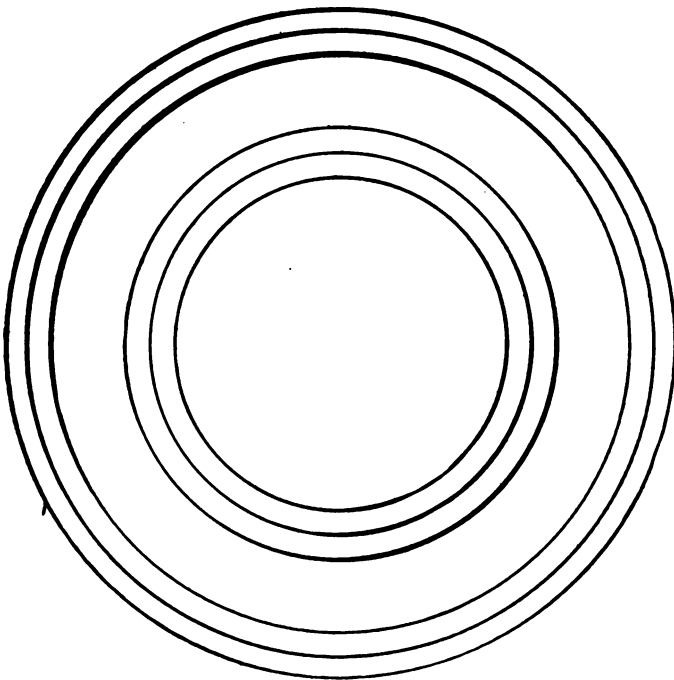
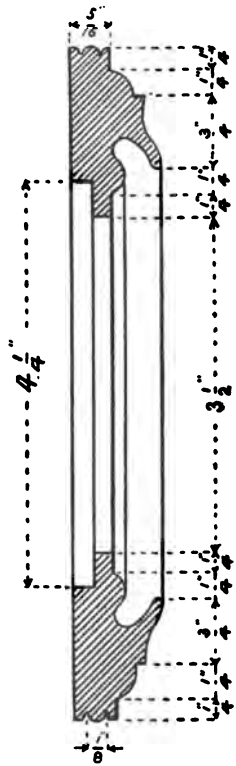

Fig. 82



turn a recess in the face $4\frac{1}{4}$ inches in diameter and $\frac{3}{8}$ inch in depth, and when this is done remove it from the face-plate. Put on instead of the disk just turned a pine one 5 inches in diameter, and turn from it a chuck to fit tightly into the recess turned in the first disk. Put the disk on the chuck, and turn its edge to the form shown in Fig. 83, after which round the fillet to the form shown by the dotted line, using the $\frac{1}{4}$ -inch skew chisel. Next cut the recess shown at [A].



Fig. 83

The curve shown at [b] in Fig. 84 is cut with the 1-inch gouge, used as a scraping tool. When using a gouge as a scraping tool, have the cutting portion of the edge supported on the rest. If, while the gouge is in the position shown in Fig. 85, the cutting is done with the part marked [a], the tendency will be to press [a] down, and so roll the cutting edge into the work, rendering the edge unmanageable and tearing the work. Undercut the inner curve with the $\frac{1}{4}$ -inch round-nose chisel, held as shown in Fig. 86, where the manner in which it is supported by the tee rest is also shown. After the undercut portion has been turned, round the fillet left on the inside and then cut the open-

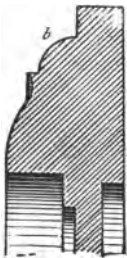

Fig. 84



Fig. 85

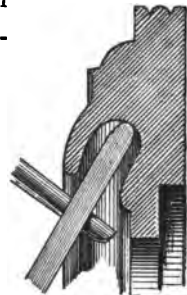

Fig. 86

ing at the centre through, using the parting-tool. Next cut the bead around the edge of the disk with the acute corner of the $\frac{1}{4}$ -inch skew chisel, using it as a scraping tool. All of these cuts are shown in Fig. 86.

Varnish and polish the work, and then remove it from the chuck.

Turned pieces of this character are used principally in making wooden patterns for metal castings, and in cabinet work and the interior finishing of buildings.

TENTH EXERCISE

Material.—Walnut or cherry disk, 3" diameter and $2\frac{1}{4}$ " thick, and a piece of same stock $2\frac{1}{2}$ " \times $2\frac{1}{2}$ " \times 4".

Exercise.—To make a cup of the form and dimensions shown in Fig. 87.

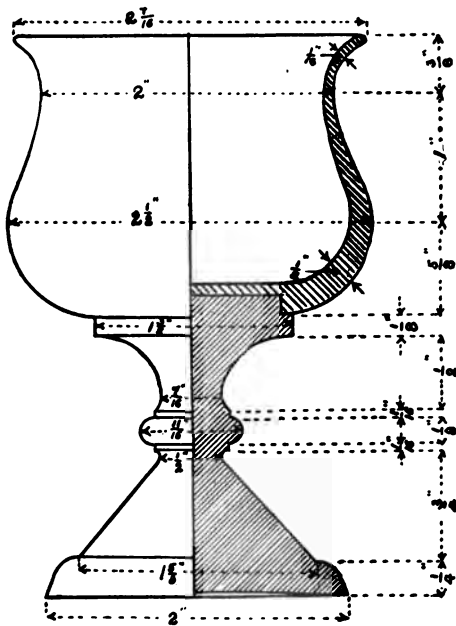

Fig. 87

Prepare a chuck by attaching a piece of pine wood, four or five inches in diameter and one inch thick, to a face-plate, and turning it round and smooth; after which, with the face-plate still attached, remove it from the lathe and fasten to it the disk from which the bowl of the cup is to be made. This may be done by inserting a screw from the back through the opening for the lathe-spindle, as shown in Fig. 88.

A face-plate having the form shown in Fig. 89 may be used.

Turn the outside of the bowl and the recess in the bottom, as shown in Fig. 89, and then remove it from the chuck. Next fit the

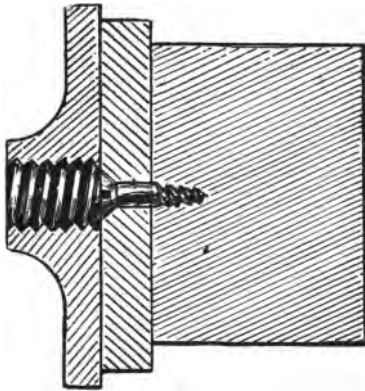

Fig. 88

chuck to the bottom of the bowl, as shown in Fig. 90, and cut the recess shown in the front, using the $\frac{1}{2}$ -inch skew chisel, and make the recess $1\frac{3}{4}$ inches in diameter and $1\frac{1}{8}$ inches

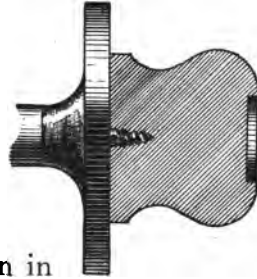

Fig. 89

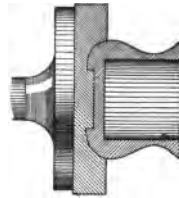

Fig. 90

deep. Finish the bowl to the form shown in Fig. 91 with the $\frac{1}{4}$ -inch round-nose chisel.

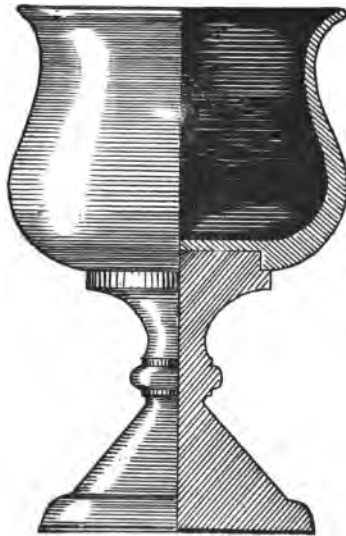

Fig. 91

All of these operations are similar to operations already performed.

Varnish and polish the bowl, and then remove it from the chuck.

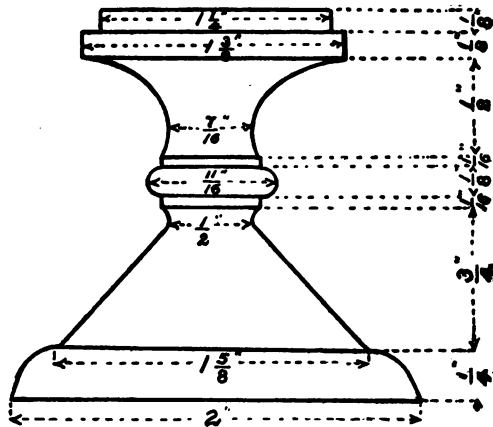

Fig. 92

Put the second piece of stock between the lathe-centres, and turn from it the stem to the form and dimensions shown in Fig. 92. Varnish and polish it before taking it from the lathe.

The stem may be fastened to the bowl with glue.

ELEVENTH EXERCISE

Material.—Cherry or maple, $2'' \times 2'' \times 8''$.

Exercise.—To turn a cup of the form and dimensions shown in Fig. 93.

Place the material between the lathe-centres, and turn it to the form shown in Fig. 94, taking measurements from Fig. 93. Remove as small an amount of material from the bottom of the bowl as may be done and have the shape well defined, as shown in Fig. 94. When turning the part [a], that is to be fitted to the chuck, turn the sides straight and parallel, as on this being done depends the possibility of fitting it to the chuck.

Make a chuck from material 2 inches in thickness, and exercise the same care in turning the hole for the end of the bowl-piece that was exercised in turning the end of the bowl—that is, have the sides parallel and perpendicular to the face, and the opening of such size that the work will be a tight fit

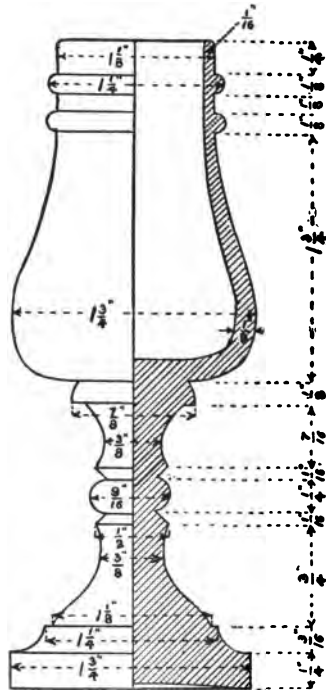

Fig. 93

and not quite reach to the bottom. The shoulder turned on the bowl-piece ought to rest against the face of the chuck, as shown in Fig. 96. If it be found on starting the

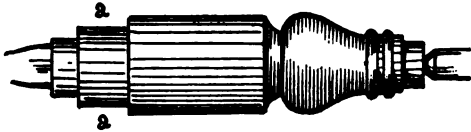

Fig. 94

lathe, after fitting the work into the chuck, that the work runs untrue, it will be better to fit another chuck rather than try to correct it.

When the bowl-piece has been fitted to the chuck so that it turns true to its axis, cut a small V shaped opening in the centre of the end, as shown in Fig. 95, using the acute corner of the skew chisel to make it. This opening is used to start a bored hole into the bowl. The hole may be made with a twist-drill, used as shown in Fig. 96—that is, with the cutting end in the small opening in the bowl, and the other end in contact with the cone-centre held in the tail-stock. The bowl, not the drill, is revolved during the boring, and this is done with the driving-belt so placed as to give the slowest speed. The drill is forced into the wood by advancing the tail-stock spindle, and is prevented from turning by holding



Fig. 95



Fig. 96

its end in a wrench. The depth of hole in the bowl is measured on the drill, and may be marked before starting to bore. The inside of the bowl is finished to shape with the $\frac{1}{4}$ -inch round-nose chisel used, and supported by the

tee rest in the manner shown in Fig. 97. It will be found safer to have the cutting edge a small distance above the centre of the cup.

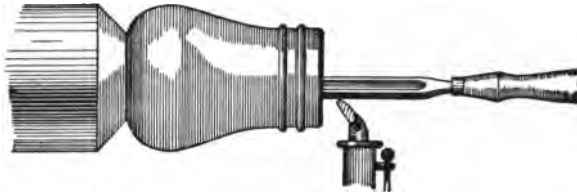

Fig. 97

After the inside of the bowl has been finished, turn the stem to the form shown, without removing the cup from the chuck, and then varnish and polish it. It may be cut from the chuck with a parting tool.

TWELFTH EXERCISE

Material.—Maple, $3\frac{1}{4}'' \times 3\frac{1}{4}'' \times 5''$.

Exercise.—To turn a sphere $3\frac{1}{8}''$ in diameter.

Care must be taken in the preliminary steps to have the dimensions as given.

Turn the material to the form and dimensions shown in Fig. 98, and with a pencil mark the lines shown—one in the centre first, and the other two at the same distance on each side of it. Next, cut the

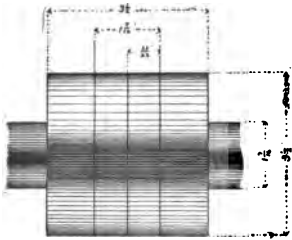

Fig. 98

material to the form shown in Fig. 99, using the outer lines and the corners at the stem as guides.

Find the centre of each of the sloping faces, and then mark on all three faces the lines shown in Fig. 99. Next, cut the stem on which the work is revolving to a diameter of $\frac{1}{8}$ inch, as shown in Fig. 100, and using the corner where the stem joins the body

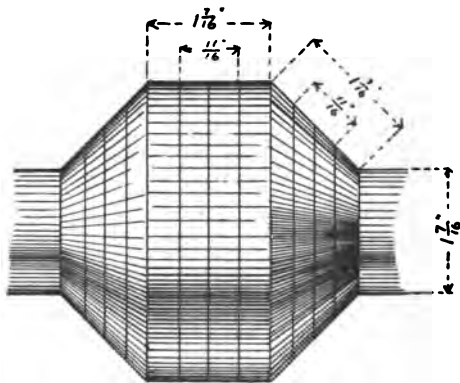

Fig. 99

and the lines on the faces as guides, cut the work to the form shown in Fig. 100. Use the skew chisel as a scraping tool, as in Fig. 77, and dress off the corners, making the work to be as nearly spherical as possible, as shown in Fig. 101, taking care to leave the centre of each face untouched. Next, cut off

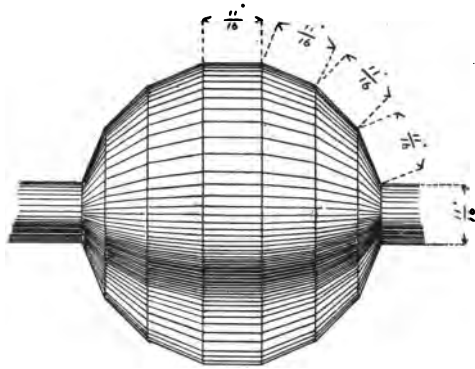

Fig. 100



Fig. 101

the stems on which the work revolved, keeping the spherical form at the ends.

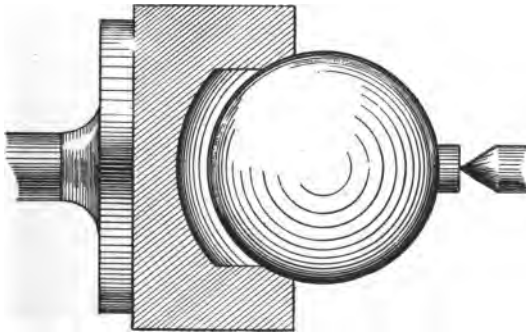

Fig. 102

Prepare a chuck of the form shown in Fig. 102, and fit it to the ball, as shown. The ball may be held in place by putting a small piece of thick leather against

the outermost end and bringing the cone-centre into contact with the leather. The ball may be pressed into closer contact with the chuck by advancing the cone-centre.

Place the ball with its axis in nearly the same position it had while it was revolving between the centres, and remove the eccentric portions with the skew chisel, used as a scraping tool; then change the position of the ball in the chuck by a small amount and again scrape off the eccentric places, and so continue until the ball is a true sphere.

Varnish and polish it before removing it from the chuck.

THIRTEENTH EXERCISE

Material.—Pine or poplar, $3\frac{1}{4}'' \times 3\frac{1}{4}'' \times 5''$.

Exercise.—To turn a ball 3 inches in diameter.

Turn the material to the form shown in Fig. 98, making the two principal dimensions, those of length and diameter, to be 3 inches. Next, with the skew chisel cut it to the form shown in Fig. 101, keeping the proper dimension by frequent use of the calipers.

Turn the ends as small as possible, and then varnish and polish it, and, when this is done, remove it from the lathe and cut off the ends with a knife, taking care to preserve the spherical outline. Next, varnish the ends.

SUPPLEMENTAL EXERCISE

(FIRST)

Material.—Poplar or pine, 3" × 3" × 8".

Exercise.—To turn a plain cylinder 3 inches in diameter, and then to cut two angular grooves in it, as shown in Fig. 103.

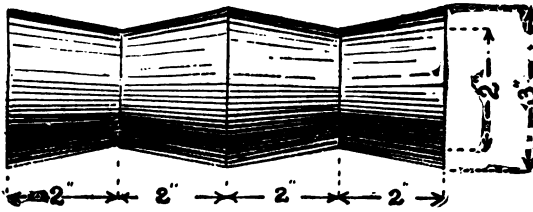

Fig. 103

Turn the cylinder and mark the divisions on it in the same manner that similar operations were performed

in the regular first exercise, after which start a cut at the left-hand end and continue it through the first space. As the cut progresses, slightly raise the handle of the chisel and force the cutting edge deeper into the wood. The amount the cutting edge is forced into the wood ought to be small during any cut, and the necessary depth gotten by a succession of cuts. The operation is repeated in the opposite direction through the next space, and the two cuts made to meet at the centre. A second cut is started on the left side and is carried also to the centre, and this is met by one from the right side; the work is continued in this manner until the groove is $\frac{1}{8}$ inch in depth, the sides being kept straight. The second groove is made in the same manner.

SUPPLEMENTAL EXERCISE

(SECOND)

Material.—Maple, $3\frac{1}{2}'' \times 3\frac{1}{2}'' \times 12''$.

Exercise.—To turn a plain cylinder 3 inches in diameter, and then to cut it to the form shown in Fig. 104.

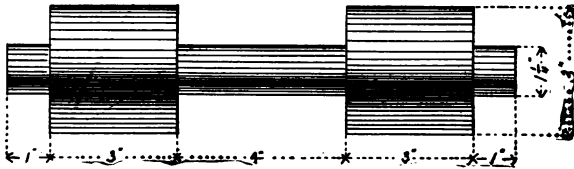

Fig. 104

The cylinder is turned, the divisions are marked on it, and the recesses are cut in the manner the corresponding operations were performed in the regular second exercise. This exercise differs from the regular one in having the recess at the centre larger, and so giving greater likelihood of vibration if the chisel be pressed too strongly against it. There is no material difference between the operations and those already described.

SUPPLEMENTAL EXERCISE

(THIRD)

Material.—The turned piece made in the second supplemental exercise.

Exercise.—To turn a dumb-bell of the form and dimensions shown in Fig. 105.

Turn the handle first, using the $\frac{1}{8}$ -inch skew chisel, and make it $1\frac{1}{8}$ inches in diameter and $\frac{7}{8}$ inch at the sides.

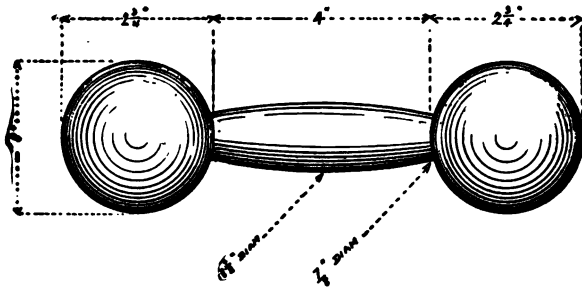

Fig. 105

Next, find the centre of each of the larger parts, and mark it around with a pencil, and, using these centre lines as the starting-places for cuts, turn each end to the spherical form shown in Fig. 97, operating in the same manner that the convex curves were made in the regular third exercise. Turn the inside first and then the outside, cutting the ball a small amount inside the outer corner, that the spherical

form may be retained. When the balls have been turned on each end, the surplus stock outside of them may be cut off by being first turned quite small in diameter and then cut off with a knife or chisel.

Though these curves are larger than the curves on the regular exercise, they will be found more difficult to cut.

SUPPLEMENTAL EXERCISE

(FOURTH)

Material.—Poplar or pine, $3\frac{1}{4}'' \times 3\frac{1}{4}'' \times 8''$.

Exercise.—To turn a piece of the form and dimensions shown in Fig. 106.

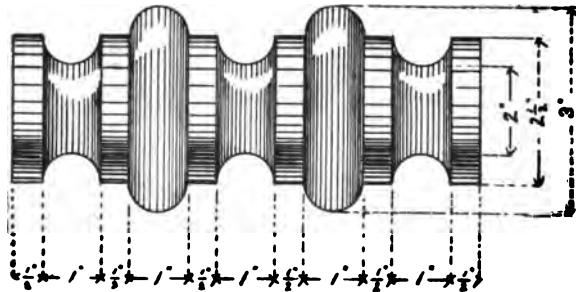

Fig. 106

Turn a plain cylinder 3 inches in diameter, mark on it the lines that determine the convex curves, and reduce the remainder of the stock to a diameter of $2\frac{1}{2}$ inches, and then cut the convex curves. Next, mark the position of the concave curves and cut them in the same manner that the concave curves were cut in the regular fourth exercise.

SUPPLEMENTAL EXERCISE

(SIXTH)

Material.—Cherry, size determined by the handle selected.

Exercise.—To turn one of the handles shown in Fig. 107.

Use only the principal dimensions—that is, the length, largest diameter, and size of ferrule on the end. The remaining dimensions to be taken as a matter of judgment, and to be such that the handle will have the appearance shown. In the screw-driver handle the octagonal

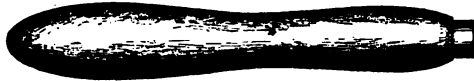

Fig. 107



Fig. 107



Fig. 107

portion is made by leaving that part untouched during the turning and afterwards planing off the corners.

SUPPLEMENTAL EXERCISE

(NINTH)

Material. — Black-walnut disk, $6\frac{1}{2}$ " diameter and 1" thick. Black-walnut disk, $3\frac{3}{4}$ " diameter and $\frac{1}{2}$ " thick. Black-walnut disk, 2" diameter and $\frac{1}{2}$ " thick. Black-walnut, $\frac{3}{8}$ " \times $\frac{3}{8}$ " \times 4".

Exercise.—To turn the pieces composing the stand shown in Fig. 108.



Fig. 108

The base, shown in Fig. 109, and the standard, shown in Fig. 110, require no special instruction as to the manner of turning: the piece shown in Fig. 111—a quarter of a ring—may be turned from the 2-inch disk by fastening it to a wooden chuck with a screw, and turning one side of it, then changing it on the chuck so that the other face is outermost, and turning that face, and so completing the ring, which may then be sawed to the required shape. The piece

shown in Fig. 113 is made from the larger disk by fastening it to a face-plate or to a wooden chuck and turning the back, then turning it over and fastening it to the same plate or chuck by screws that do not pass quite through it, and then cutting the front side, using the same methods for get-

ting the proper form that were used in the regular sixth exercise. The holes left in the back by the screws used

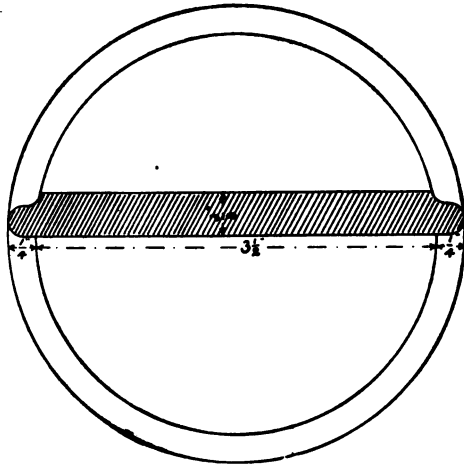

Fig. 109

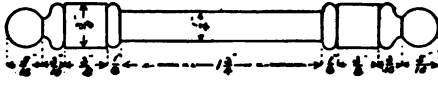

Fig. 110



Fig. 111



Fig. 112

to hold it to the chuck may be filled with small plugs of the same material as that of which the piece is composed. The

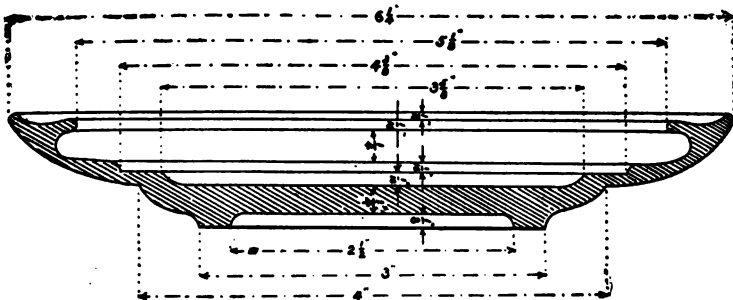

Fig. 113

pieces shown in Fig. 112 are glued in place, as are also the other pieces.

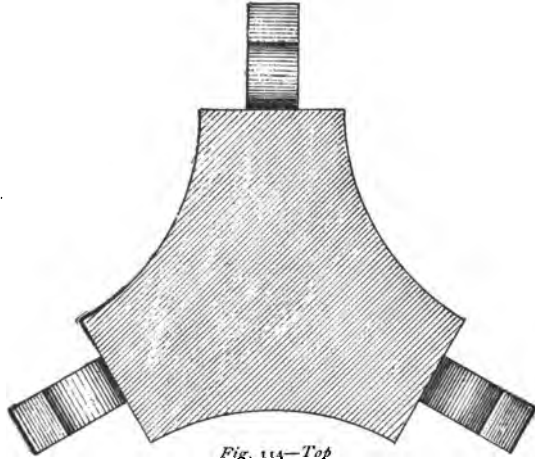

Fig. 114—Top

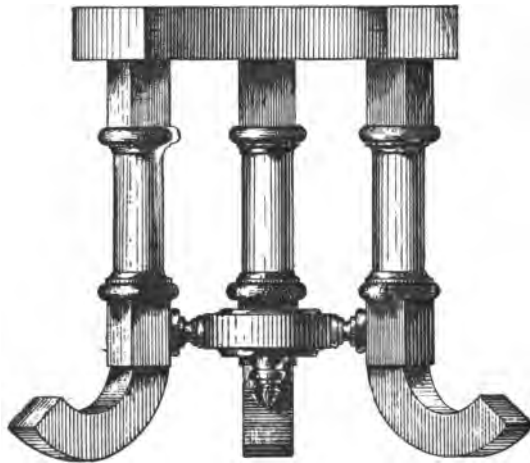

Fig. 114—Front

Where turned work is used in the construction of house furniture, this method of turning the parts separately and then fastening them together is freely used. An illustration of combined sawed and turned work is shown in Fig. 114.

SUPPLEMENTAL EXERCISE

(ELEVENTH)

Material.—Cherry, 3" × 3" × 8".

Exercise.—To turn a vase of the form and dimensions shown in Fig. 115 and Fig. 116.

Turn the outside and fit it to a wooden chuck in the



Fig. 115

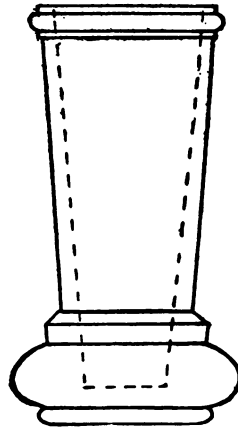

Fig. 116

same manner that similar operations were performed during the regular eleventh exercise. The inside may be bored and then turned with the round-nose chisel, or the work may be done wholly with the skew-chisel. The skew-chisel may be used to finish the square corners.

Varnish and polish it before removing it from the chuck.

SUPPLEMENTAL EXERCISE

(TWELFTH)

Material.—A sphere turned as in the ninth exercise.

Exercise.—To turn a ball inside the one already turned.

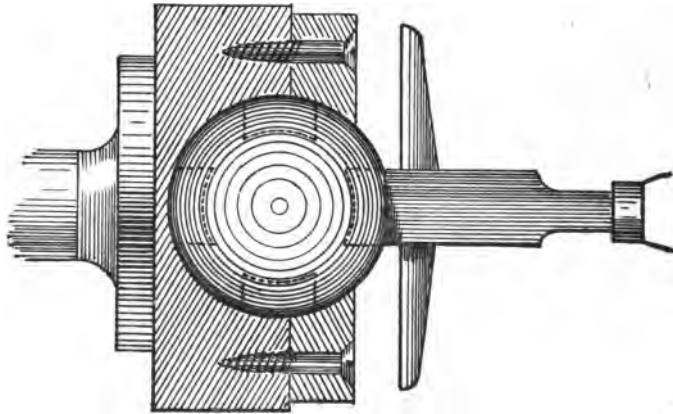

Fig. 117

Over the wooden chuck used in turning the ball fit a wooden disk, and turn a hole in the centre of it, so that it may be fastened to the chuck with screws, and have a portion of the ball project through the front, as shown in Fig. 117.

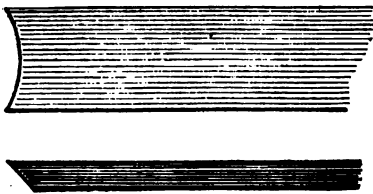

Fig. 118

The fit to the ball must be close, so that the ball will be held firmly in any required position.

Procure two tools of the form shown in Fig. 118 and Fig. 119. The curvature of the end must be the same as that of the inside ball. These may be made from old files by grinding.

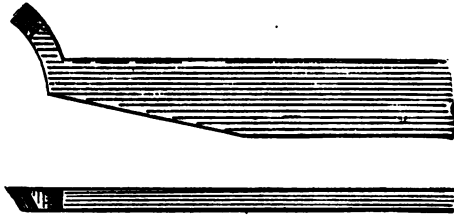

Fig. 119

Mark the extremities of the three axes of the sphere that are perpendicular to one another. This may be done by setting the sphere in a corner

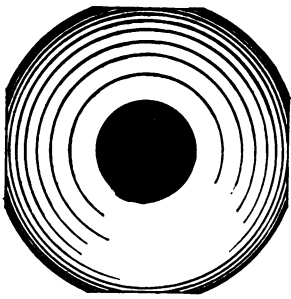

Fig. 120

of a square box and marking the points of contact, and then finding a point on the sphere opposite each one of the three so found by means of the calipers. When the points are found, fasten the sphere in place in the chuck in such position that one of the points is exactly in the centre of the opening in the disk that covers the chuck, and with the

tool shown in Fig. 118 cut a hole into the ball in the man-

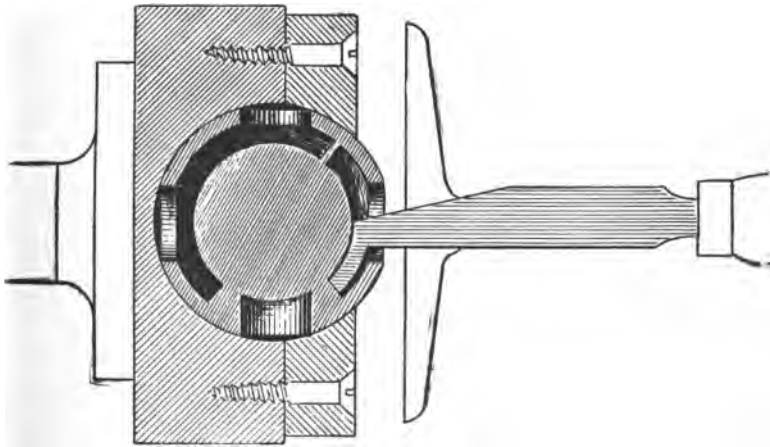
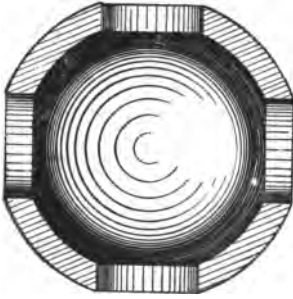

Fig. 121

*Fig. 122*

ner shown in Fig. 117. The depth of the hole should be $\frac{1}{4}$ inch, and this may be regulated by making a mark on the corner of the chisel before starting the cut. Next, loosen the front part of the chuck and move the ball until a second mark is in the centre of the opening, and cut in again, and so continue until

the six marks have been used and the ball has the ap-

*Fig. 123*

pearance shown in Fig. 120. , Now, using the second tool in the manner shown in Fig. 121, remove the material between the holes so cut until the inner ball is free from the outer shell, as shown in Fig. 122. The last cut taken must be made with great care, or the freed inner ball will catch on the tool and break the outer shell. The lathe-spindle would better be revolved by hand during the latter portion of the cut.

This is but one of many solids that may be turned inside the sphere in nearly the manner indicated, and the turning of which is most fascinating work for a skilful turner.

THE END

