

Better Homes and Gardens®

WOOD

THE MAGAZINE FOR HOME WOODWORKERS

\$3.50

April 1986 • ISSUE NO. 10
Display Until April 17

- **PLASTIC LAMINATES**
Shop-tested guide
to application
Purchasing tips
- **TOOL SHARPENING**
Do waterstones
have the edge?
- **5 STRATEGIES**
for stretching
shop space
- **AIR COMPRESSORS**
What one can do
for you
- **PROJECTS
THAT PLEASE**
Parsons table
Dining chair
Light cover-ups
2 terrific projects for
kids to build

FAMILY WOODWORKING

Just for the Fun of It
page 66





INTRODUCING PLANE JANE. THE PORTABLE PLANER THAT'S ANYTHING BUT PLAIN.

It weighs just 58 lbs. It'll fit in a 2 ft. x 2 ft. space with room to spare. It can almost get lost in a corner of a workshop or even the back of a truck. And therein lies the beauty of Plane Jane.

For serious woodworkers, it's small enough to be practical for any size workshop, yet will plane material up to 10" wide and 5" thick.

It will virtually pay for itself in time and money saved because it reduces hand finishing and buying of expensive finished lumber.

And don't overlook Plane Jane's portability. You can take it to job sites as easily as you could a drill.

It's everything you could ask for in a planer. You'll see at a glance, the real beauty of Plane Jane is how it works.

Made for more than weekends.  **RYOBI**

Bensenville, IL 60106
312-766-1621

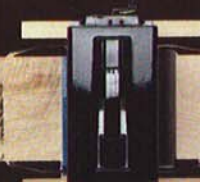

COMPARE

Total Shop®

WITH SHOPSMITH.®
You'll actually see
the improvement.

For Example:

1. 1½hp motor develops nearly 3hp while Shopsmith® motor is 1½hp developing 2hp.
2. Motor can be altered by owner to 220V. Shopsmith® does not have this option.
3. In more than 85% of the comparisons, the Shopsmith® machine is priced higher than the Total Shop® machine.

Let us send you 11 more reasons
Total Shop is a better buy.

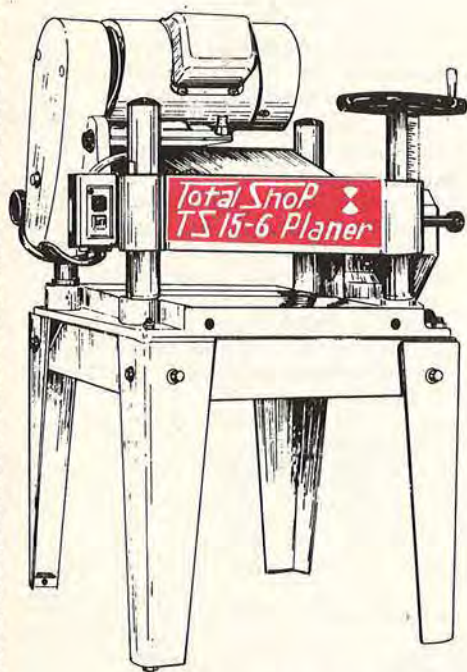

Total Shop®

TS 15-6 Planer

- 110 V or 220 V
- Stand & dust collector available
- 2 HP or 5 HP motor
- 15" width, 6" thickness

Attention Shopsmith® Owners:
Call today for our accessory brochure
and save money.

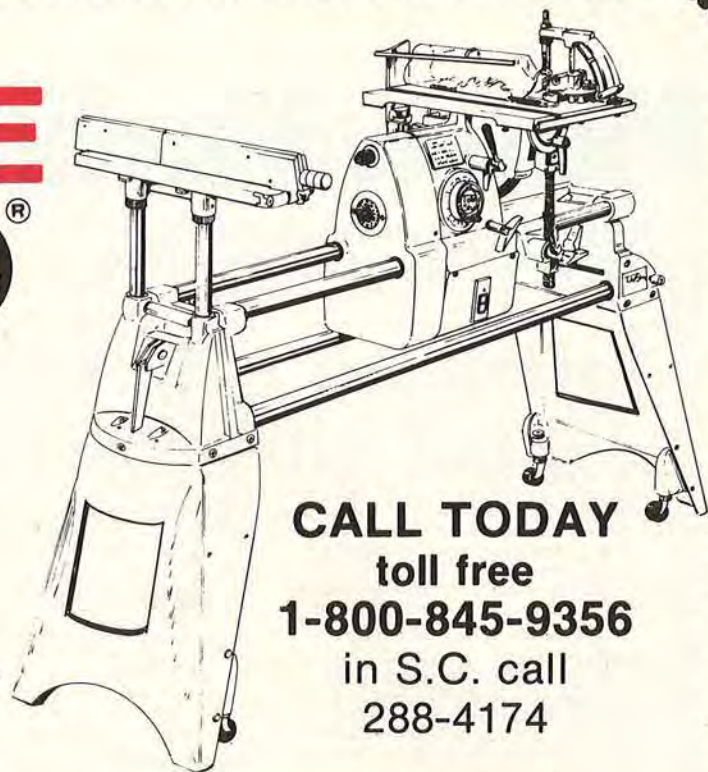

CALL TODAY
toll free
1-800-845-9356
in S.C. call
288-4174

Total Shop®

has proudly
created an in-home
WOODWORKING
VIDEO.



- The first of its kind!
- 30-min. presentation of the Total Shop and the TS 15-6 Planer.
- In-home viewing.
- \$20.00 refundable deposit.
- Available in VHS and Beta.

Now you can see
our product at work
before you buy.

clip and mail coupon for: Free Informational Kit

Total Shop®

Dept. Q
P.O. Box 16297/Greenville, S.C. 29606

Your Name _____

Address _____

City _____ State _____ Zip _____

Phone _____

- Multipurpose tool TS 15-6 Planer
 Video (\$20.00 deposit enclosed)

©United Metal Services, Inc.

Money Machine.

This revolutionary invention, the *Paralok Table Saw Fence* makes cutting at least *seven times more accurate* than any other fence... much faster... and is super simple to operate.

Time was.

"We spent hours in the shop fighting with our rip fence and usually losing. Finally we retired it to a corner and resorted to a 1"x6" and pair of C-clamps. At least it was accurate. But crude and slow. We remember the test cuts, measuring front, blade and rear... tapping to get everything in place, only to repeat it again for the next cut."

We set out to solve the problem.

Our ideas lead to the invention of the Paralok Fence. It took three years to perfect it. Now it is perfect and accurate. How accurate? Accurate in thousands of test cuts to .002" or less. This Paralok Fence saves time and materials and that spells *money*. We call it the *money machine*.

In the two years we've been marketing the Paralok Fence nationwide, we haven't talked to one customer who doesn't agree.

How it works.

The Paralok fence works on the same principle as a drafting table. Super strong aircraft cable (5/64", 49 strand) runs in a closed loop around 6 precision ground nylon pulleys located underneath the rails. The aircraft cable is engaged by the fence in both the front and rear. Move the front end 1/64" and the back goes 1/64".

Single handed operation. Lift up the handle and slide the fence down the rails with one hand. Use the combination of the tape mounted on the front rail and the vernier cursor next to the handle to set the fence at intervals of 1/64". You'll march right through your cutting list without having to stop the motor.

Both the front and rear lock. Two hefty locks, each with 750 pounds clamping pressure, independently lock the fence to the front and rear rails without squeezing the rails together. No distortion at the rear, no kickbacks due to binding the material.

Owners tell us.

"I'm a believer. I've had the Paralok on for a week now and we won't part company. The action is smooth, the parallelness is absolutely dead on, and it locks with a commitment to purpose that should be an inspiration to us all!" G. B. Lee Baker, Redmond, Oregon

"The Fence is incredibly accurate... It has cut the time of any saw work by a measureable amount... I wish we had gotten this fence about four years ago!" Bill Tongate, shop supervisor, Valley Cabinet & Trim, Ridgecrest, California.

More features.

The Paralok is easy to install, taking about 1½ hours or less. (It can also be mounted with an auxiliary fence.) The Paralok is easy to remove for cross-cuts. It gives you long infeed and outfeed for better control. The fence is always perfectly parallel, even when being reset for the next cut. The anodized aluminum finish is tough, wear resistant and looks great. Because of such a smooth finish, material glides right through.

Fits almost all table saws.

The Paralok fits Rockwell-Delta, Powermatic, General, Wadkin-Bursgreen, Walker-Turner, Oliver, Jet, Sears Craftsman, and most others.

The important dimension is the depth of your table saw from front to rear. Then select from rails in six sizes: 4', 5', 6'8", 8'8". That is gross length. You decide how much you want to the right and left of the blade.

Standing behind our fence.

We're so confident you'll be more than pleased we offer a *five year warranty* on parts and labor for defective material or workmanship. And, if you're not satisfied with your Paralok, send it back in 30 days for a full refund.

For more information.

Give us a toll free call. We'll answer any questions and direct you to your nearest dealer (Dealer inquiries invited). If we don't have a dealer near you yet, you can place your order direct.

We figure the Paralok Fence makes about ten million existing fences obsolete. And the real bonus is that it pays for itself — quick.

QUINTEC

Post Office Box 736
Newberg, Oregon 97132
Call 1-800-423-9611
Oregon & Alaska call (503) 538-1875 collect

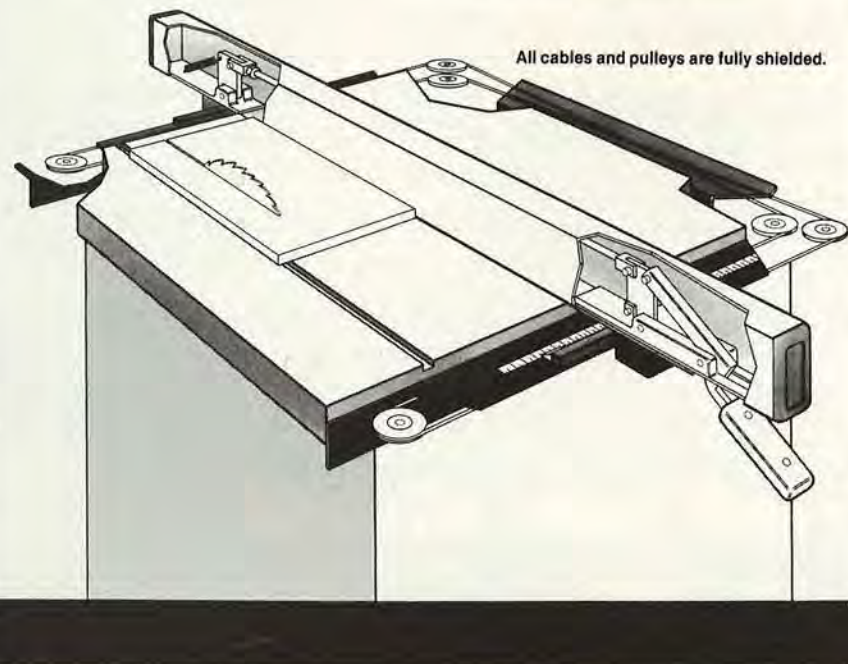

Better Homes and Gardens® WOOD

THE MAGAZINE FOR HOME WOODWORKERS

April 1986 • Vol. 3, No. 2 • Issue No. 10

Editorial/Art Staff

Editor **LARRY CLAYTON**
Managing Editor **DAN KAERCHER**
Art Director **C. L. GATZKE**
Design Editor **JAMES R. DOWNING**
Features Editor **PETER J. STEPHANO**
How-To Editor **MARLEN KEMMET**
Project Builder **JAMES E. BOELLING**
Graphic Designer **PERRY A. McFARLIN**
Administrative Assistant **DARLENE REYNOLDS**

Technical Consultants: **GEORGE GRANSETH** Product Testing; **VERNON U. WARD** Collectible Tools; **PAUL L. McCLURE** Wood Technology

Editorial Director **DORIS M. EBY**
Publishing Director **ADOLPH AUERBACHER**

Editorial Services

Executive Director **DUANE L. GREGG**
Director, Editorial Research **C. RAY DEATON**
Administrative Editor **ROSE ANDERSON**

Publisher **JERRY KAPLAN**
Promotion/Research Director **THOMAS J. TROLAND**
Circulation Director **WILLIAM HUMMEL**
Production Director **DALE SCHENKELBERG**

Publishing Group Officers

President **JACK D. REHM**
Senior Vice Presidents
General Manager,
Magazines **JAMES A. AUTRY**
General Manager,
Books and Newspapers **FRED STINES**
Group Vice President
Editorial Director **DORIS M. EBY**

Corporate Officers

Chairman of the Board **E. T. MEREDITH III**
President **ROBERT A. BURNETT**
Group Presidents: Publishing **JACK D. REHM**; Broadcasting **W. C. McREYNOLDS**; Real Estate **ALLEN L. SABBAG**
Vice Presidents: Corporate Relations **DONALD L. ARNOLD**; General Counsel and Assistant Secretary **THOMAS G. FISHER**; Product Development **NEIL KUEHNL**; Corporate Planning **HERB SCHULTE**; Finance **WILLIAM H. STRAW**; Administrative Services **GERALD D. THORNTON**
Secretary **BETTY CAMPBELL MADDEN**
Treasurer **MICHAEL A. SELL**
Controller **LARRY D. HARTSOOK**

Better Homes and Gardens WOOD — the magazine for home woodworkers (ISSN-0743-894X) is published bimonthly in February, April, June, August, October, and December by Meredith Corporation, 1716 Locust Street, Des Moines, IA 50336. Second-class postage paid at Des Moines, Iowa. Trade-mark registered in Canada and Australia. Marca Registrada en Mexico. **SUBSCRIPTION PRICES:** One year \$18 in the United States and its possessions. Canada and other countries add \$6 per year. **POSTMASTER:** Send address changes to WOOD, 1716 Locust Street, Des Moines, IA 50336. April 1986, Vol. 3, No. 2, Issue No. 10. **CUSTOMER SERVICE:** For service on your magazine subscriptions, including change of address, write to Customer Service Manager ROBERT AUSTIN, P.O. Box 10628, Des Moines, IA 50336. Please enclose a recent address label.

© COPYRIGHT MEREDITH CORPORATION 1986. ALL RIGHTS RESERVED. PRINTED IN U.S.A.

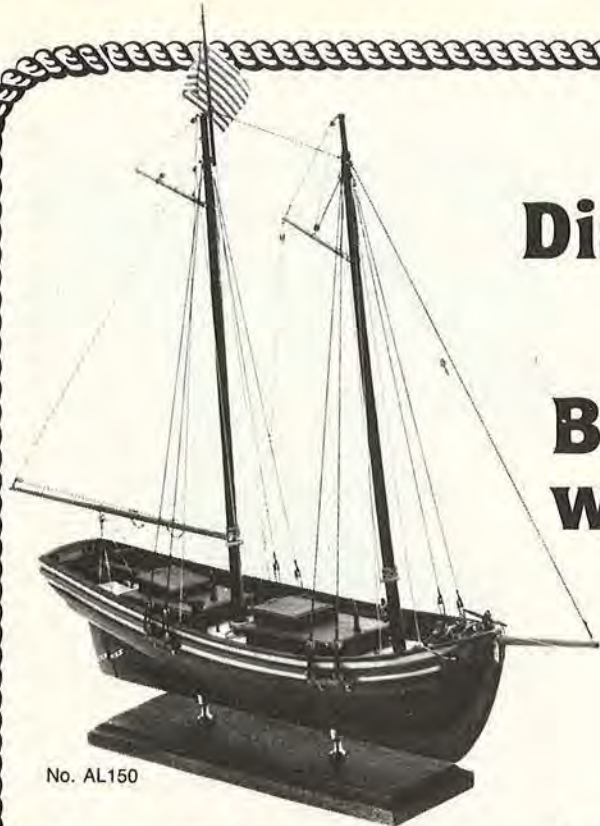

No. AL150

Discover the world's oldest hobby!

Build this beautiful wooden ship model.

Special offer for those who have never built a ship before!

Wouldn't you love to build this historic ship model? It's a true-to-scale, 21" replica of the 2-masted schooner *Swift*, a Virginia pilot boat of 1805. Well, now you can! And you don't have to be a skilled craftsman to do so.

It really isn't hard

Even if you've never built a model before, you can experience the relaxing pleasure and pride of accomplishment that is offered by this fascinating hobby. You can build the *Swift*. The

secret's in our kit, designed especially for the first time modeler, with pre-cut parts that make assembly easy. Clear, large scale plans and instructions that virtually take you by the hand and guide you every step of the way through hours of the most relaxing fun you'll ever have. And when completed—a museum quality model you'll display with pride, with gleaming brass fittings, walnut planked hull, delicate rigging—lifelike in every detail.

Quality you can see and feel

The materials in our kit may be better than those used in the original *Swift*. The keel section and frames are pre-cut plywood, ready for quick assembly. The *Swift's* hull is planked twice; once with thick, flexible lime-wood for strength, then overlaid with planks of African walnut for lasting beauty.

You won't have to make the fittings—we've done that for you. Our kit contains ready-to-use blocks and deadeyes

of rare, yellow boxwood. We include eyelets, bracers and belaying pins—over 70 parts of solid brass! Even the cabin door hinges are brass, as are the 250 miniature nails you'll use to fasten the planking to the hull and deck. And, since the original wooden *Swift* had no plastic parts, our kit doesn't either—*anywhere!*

Creative? And how! Overwhelming? Not a bit! But be prepared for hours of the most challenging, engrossing, relaxing fun you've ever had.

An "everything you'll need" special offer, with free tools and handbook.

We want to introduce you to this great hobby, *now!* So we've made it easy for you to get started. Our special offer includes the *Swift* kit plus all the tools you'll need to build her: pliers, hammer, knife, file, tweezers, sandpaper, glue, wood oil, and more. You'll also receive a free copy of "Ship Models from Kits," a 110 page beginner's guide. You don't have to buy anything else. The tools normally cost \$17; the book retails for \$7.95. But they're yours, FREE when you buy the *Swift* kit at its regular price of \$39.95 (plus \$4.00 for delivery).

Credit card holders order toll-free

Call 800-228-2028, ext. 68, 24 hours a day. In Nebraska, call 800-642-8300. Use Visa, Mastercard, American Express, or use coupon below to send check or money order.

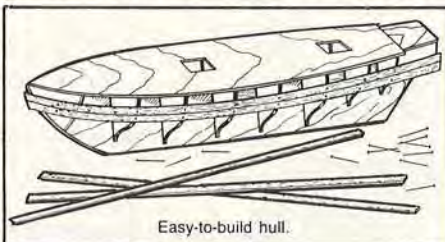

Easy-to-build hull.



Everything you need to build...included.

Miniature Cannon Kit Bonus!

Set of two solid brass cannon on walnut carriages to be mounted amidship. \$4.00 value, sent FREE with your order.



model expo, inc.

23 Just Road, Fairfield, N.J. 07007

MODEL EXPO, INC. 23 Just Road, Fairfield, NJ 07007 Dept. BHW-36

Please send me ___ kits of the *Swift* (No. AL150) at \$39.95 plus FREE tools, book and cannons. Check or money order enclosed. (Add \$4.00 for delivery. NJ residents must add 6% sales tax.)

Name _____

Address _____

City _____ State _____ Zip _____











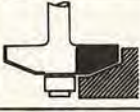

116 page full color hobby catalog sent FREE with your order.

If less than delighted, you may return your purchase within 30 days for a full refund. © Model Expo, Inc. 1985

**CARBIDE TIPPED ROUTER BITS
PROFESSIONAL PRODUCTION QUALITY
SPECIAL OFFER — SAVE 50% - 75% BELOW COST**

1000's SOLD TO READERS OF FINE WOODWORKING

BEST CUT BEST PRICE	ITEM NO.	DESCRIPTION	RADIUS	LARGE DIAM.	CUTTING LENGTH	PRICE
	COVE					
	#01	1/4" R	1/4"	1"	1/2"	\$13.00
	#02	3/8" R	3/8"	1 1/4"	9/16"	14.00
	#03	1/2" R	1/2"	1 1/2"	5/8"	15.00
	ROUND OVER					
	#04	1/4" R	1/4"	1"	1/2"	15.00
	#05	3/8" R	3/8"	1 1/4"	5/8"	16.00
	#06	1/2" R	1/2"	1 1/2"	3/4"	19.00
	ROMAN OGEE					
	#07	5/32" R	5/32"	1 1/4"	15/32"	18.00
	#08	1/4" R	1/4"	1 1/2"	3/4"	20.00
	RABBETING					
	#11	3/8" RABBETING	Deep 3/8"	1 1/4"	1/2"	14.00
	#09	1/8" (KERF) SLOT CUTTER		1 1/4"	1/8"	14.00
	#10	1/4" (KERF) SLOT CUTTER		1 1/4"	1/4"	14.00
	#12	45° CHAMFER	45° Angle	1 1/2"	5/8"	15.00
	#15	RAISED PANEL	20° Angle	1-5/8"	1/2"	25.00
	DOVETAIL BITS					
	#16	3/8" DOVETAIL	9°	3/8"	3/8"	7.50
	#17	1/2" DOVETAIL	14°	1/2"	1/2"	8.50
	#18	3/4" DOVETAIL	14°	3/4"	7/8"	10.50
	CORE BOX (ROUND NOSE)					
	#19	3/8" CORE BOX	3/16"	3/8"	3/8"	11.00
	#20	1/2" CORE BOX	1/4"	1/2"	11/32"	14.00
	#21	3/4" CORE BOX	3/8"	3/4"	5/8"	18.00
	GROOVE FORMING OGEE					
	#22	1/2" GROOVING OGEE		1/2"	3/8"	16.50
	#23	3/4" GROOVING OGEE		3/4"	7/16"	21.00
	#24	1/4" Straight Bit		1/4"	1"	7.00
	#25	5/16" Straight Bit		5/16"	1"	7.00
	#26	3/8" Straight Bit		3/8"	1"	7.00
	#27	1/2" Straight Bit		1/2"	1"	7.00
	#28	3/4" Straight Bit		3/4"	1"	10.50
	#13	1/2" FLUSH TRIM		1/2"	1"	8.50
	#14	3/8" KEY HOLE (This Bit only HSS)	CUTS 3/8" KEY HOLE FOR FLUSH MOUNTING PICTURE FRAMES, ETC.			8.50

**WHEN ORDERING ANY 3 OR MORE, DEDUCT \$1.00 EACH
ALL PRICES POSTAGE PAID**

- Professional Production Quality
- 1/2" Ball Bearing Pilot
- 1/4" Diameter Shanks x 1 1/4" Long
- One Piece Construction
- Two Flute Thick High Quality Tungsten Carbide Tips

To order by Master Charge or Visa Toll Free
7 Day — 24 Hour Order Service Call

1-800-523-2445 Ext. 56 (in PA 1-800-346-7511 Ext. 56)

or send check to: **MLCS, Box 53D, Rydal, PA 19046**

THE EDITOR'S ANGLE



I've got a confession to make. Until two weeks ago, I'd never carved anything other than a Thanksgiving turkey now and then. Not because I have anything against carving; I just thought I couldn't do it. As it turns out, I was not alone. None of the other WOOD staffers had much experience in this area, either.

That's all changed now. As part of our continuing education program, we spent a full day with wood-carver Harley Refsal learning about and doing some Scandinavian wood carving. Under Harley's able direction, each of us was able to transform a chunk of basswood into a cute little Scandinavian farmer by the end of the day. I've got to admit, though, that I had to ask Harley if he could somehow salvage the face on my carving so the farmer would look a bit less Neanderthal.

Carving has been good to me so far. And it sure made my recent stay while in Chicago on business more enjoyable. Usually, I either watch the tube or curl up with a good book or magazine. But not this time. I carved for a couple of hours before dinner, then went at it again later that night.

There is one potential problem with carving on business trips, though—getting through the airport X-ray scanners with a carving knife in your suitcase. But don't worry too much; I made it through twice! 🌲



 Print this article

Larry Clayton

Your home workshop can PAY OFF BIG!

This One Low-Cost Power Tool—
SAWS to desired Width...
PLANES to desired Thickness...
MOLDS all popular Patterns...

—All at once or separately... All By Power Feed!

The Only Complete Workshop Tool Of Its Kind In The World!

From the Day It Arrives... the Planer will make and save you money. With shortages and inflation driving lumber prices sky-high, this versatile power tool quickly pays for itself by easily converting low cost rough lumber into high value finished stock. In just one pass turn out your own quarter-round, door and window stop, casing, tongue-and-groove... all popular patterns. Other operators are making cases for grandfather clocks, furniture, picture frames, bee hives, bed slats, surveying stakes... all kinds of millwork.

Built For Pros... Priced For Home Craftsmen... it is engineered and built to industrial standards, but factory-direct selling keeps the price low. Handles tough oak and walnut as easily as pine, and so simple to operate even beginners with no experience can use it.

**Start
Your Own
Business!
Earn Extra
Income
Right At
Home.**

With just this one low cost power-feed machine in a corner of your garage or basement, you're set up to supply lumberyards, cabinetmakers, carpenters, remodelers, contractors and hobbyists in your area with custom-planed lumber, trim, molding... ALL of their millwork requirements. You can supply picture molding to art shops, hardware and department stores, or sell direct to framing shops. All standard patterns are available from stock, or we'll custom grind a knife to your own special design or sample.

Does The Foley-Belsaw Pay? YOU BET! READ WHAT OWNERS SAY:

A Good Investment • Robert Sawyer, Roseburg, Oregon: "I believe that the Foley-Belsaw is the best investment I ever made. I've been a planer man for years and am now retired. The Foley-Belsaw has earned me \$60,000 extra income in the past eleven years."

Pays For Itself: • R.S. Clark, Springfield, Ohio: "I bought a batch of walnut in the rough, and after planing it on the Foley-Belsaw I figured up the money I saved. It was enough to pay for two-thirds the cost of the Planer. It really does a good job."

More Than Expected • Stephen Schultz, Orangeville, Penna.: "This machine pays for itself by making money out of scrap boards. It is a very well built machine and I confess it is more than I really expected for the price. It does everything you say it will!"

... **And Foley-Belsaw Is The Choice Of Professionals:**
"I recommend Foley-Belsaw Planer-Molder-Saw as the most useful shop tool any craftsman could own. We use one every day in the Workbench model shop, and couldn't get along without it."

JAY HEDDEN — Editor WORKBENCH Magazine



**FOLEY
BELSAW**

Try The
Foley-Belsaw In Your
Own Shop On Our

**30-DAY FREE
TRIAL OFFER**

Mail Coupon Below
For Complete
Details!

You Take NO RISK! The Planer/Molder/ Saw Is Backed by Our Exclusive 100% Guarantee of Satisfaction:

- "Try the Foley-Belsaw in your shop for a full 30-Days and put it to work for you. Give it a thorough test and make it prove that it can do everything we say it will... use it just as much as you want. Then if you are not completely satisfied, just send it back and we'll return every penny you sent. And YOU are the sole judge! There are no questions asked... there are no fine print 'use' charges. Our flat guarantee is that YOU must be 100% satisfied or you get your money back."

**FREE
BOOKLET!**

Get FREE
Book with
facts and
full details
... RUSH COUPON TODAY!



**Just Mail Coupon...
NO OBLIGATION and
NO SALESMAN Calls!**

**ACT NOW!
Coupon
Brings
Full Details!**

If coupon has been removed, just send postcard with name and address to:

FOLEY-BELSAW CO.
90783 FIELD BLDG.
KANSAS CITY, MO 64111

**FOLEY
BELSAW**

FOLEY-BELSAW CO.
90783 FIELD BLDG.
KANSAS CITY, MO 64111

YES, please send me the FREE Booklet that gives me complete facts about your Planer-Molder-Saw and full details on how I can qualify for a 30-Day Free Trial right in my own shop. I understand there is No Obligation and that No Salesman will call.



NAME _____

ADDRESS _____

CITY _____ STATE _____ ZIP _____

**NOW!
REDUCE THE
RISK AT YOUR
TABLE SAW**



folds down neatly

WITH THE NEW MOBILE™ SAWING CENTER

OUTFEED ROLLERS

- safe, accurate sawing
- handle panels with ease
- available in 15" and 37" widths
- dual-position table

AND INCREASE FLOOR SPACE



MOBILE MACHINE BASES

- increase shop working area
- maximize usable floor space
- 3 point base will not rock
- locking wheels
- makes machine so easy to use and store
- over 80 standard models

PLANER STAND WITH ROLLERS

- raises planer to proper working height
- provides machine mobility
- five-fold increase in workpiece support
- storage is a snap



NEW



ROLLERTABLE Rock Solid Support

- adjustable
- portable
- use at any machine

PEDESTAL ROLLER

Discover HTC's many unique products designed only with you, the dedicated woodworker in mind. Find out how you can make your machining safer, increase working area of your shop and accomplish nearly impossible tasks easily, quickly and accurately - **all by yourself!**

CALL TODAY!

HTC PRODUCTS, INC.
120 E. HUDSON S-8
ROYAL OAK, MI 48067
(313) 399-6185



1-800-624-2027 ext. 112

Better Homes and Gardens®
WOOD

THE MAGAZINE FOR HOME WOODWORKERS

APRIL 1986

ISSUE NO. 10

WOOD PROFILE

ASH: THE HOME-RUN HARDWOOD

25

This sporting wood shows up in all sorts of athletic equipment, but its durability also makes it ideal for tool handles and furniture.



CRAFTSMAN CLOSE-UP

PORTRAIT OF A YOUNG CARVER

26

Ohio teen-ager Michelle Feasel is carving up a storm these days. Come see why her miniature wildlife figures command such attention—especially from her dad, who taught her the craft.



SHOP-TESTED TECHNIQUES

APPLYING PLASTIC LAMINATES

30

No, it's not exactly "wood." But plastic laminate is a key auxiliary material in many projects. Here's a guide to the basics of laminate application, as well as some surefire tips for special situations.



NOW YOU CAN BUILD IT

PICTURE-PERFECT PARSONS TABLE

36

A single sheet of 3/4" plywood and another of high-gloss laminate join forces in this easy-as-pie project. The finished product is perfect for a conversation grouping like the one shown here. Or, adapt our design to your specific requirements.



FURNITURE PROJECT

**PLEASE BE SEATED!
SOLID OAK DINING CHAIR**

40

No project demands more attention to snug joinery and properly scaled dimensions than a chair—however simple. This sturdy oak dining chair will remain wobble-proof, eye pleasing, and comfortable for years to come.



SHARPENING YOUR SHOP TOOLS

DO WATERSTONES HAVE THE EDGE?

46

More and more woodworkers sure seem to think so! We think we've learned some of the reasons why.

TOOL BUYMANSHIP

AIR POWER! WHAT AN AIR COMPRESSOR CAN ADD TO YOUR WORKSHOP 50

Yes, an air compressor can indeed earn its keep in your shop—and for more tasks than spraying finishes and blowing dust.



YOUR WORKSHOP

5 STRATEGIES TO MAKE SMALL SHOPS WORK BIG 54

Ready to set up a shop of your own—if only you can find the space? Or maybe you already have a small shop that seems to be contracting as your woodworking needs expand. Use these sample layouts and tips to stretch your shop space.

TWO BRIGHT IDEAS FROM OUR SHOP

THE OLD LAMPLIGHTER REDWOOD LANTERN 58

This appealing fixture of redwood, brass, and acrylic lends distinction to any outside entry or patio. Build one or a pair and enjoy the glow.



THREE-TIER WALNUT CEILING FIXTURE 62

You won't find another ceiling fixture that stacks up as handsomely. It's simply three mitered walnut frames joined to white acrylic and a mounting frame.



FAMILY WOODWORKING

TIME OUT FOR KIDS 66

This special section focuses on woodworking as a family hobby. Learn how to share your skills with youngsters. There's no greater satisfaction!

SIMPLY SPECIAL WREN HOUSE 68

It's an ideal project for a parent-child team to tackle in an evening or two. Build our wren house soon and welcome the first occupants this spring.



THE RED BARON, JR., TOY AIRPLANE 70

With your supervision, a youngster can handle most of the layout, cutting, and assembly of this high-flyin' project—depending on his or her age and skill level, of course.



SHORT-SUBJECT FEATURES

Editor's Angle	4	Buying Plastic Laminates	76
Talking Back	10	Ask WOOD	82
Shop Tips	13	Products that Perform	85
Talking Shop	22	Plant Pedestals	87
Magazine Customer		End Table Cube	88
Service Information	23	Woodworking Videos	89
Project Showcase	48	Bulletin Board	96

Woodworkers' Hardware ORDER FORM

Qty. Total

Note: C = 100

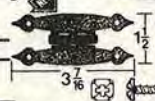
Black Hammer Hinge

 \$2.70/2 \$1.62/2
 \$11.95/10 \$7.17/10
 Screws for above are included.

Birch Mug Peg

 \$.43/ea. \$.25/ea.

Birch Shaker Peg

 \$.47/ea. \$.28/ea.

Birch Furniture Spindles
 6 inch \$1.70/ea. \$.42/ea.
 9 inch \$1.20/ea. \$.72/ea.

#S4 Galley Spindle

 Birch \$.28/ea. \$.17/ea.
 Oak \$.35/ea. \$.24/ea.

#S5 Galley Spindle

 Birch \$.41/ea. \$.25/ea.

Wood
 7/8" \$7.80/C\$4.70/C
 1" \$11.68/C\$6.00/C
 1 1/4" \$15.00/C\$8.00/C
 1 1/2" \$18.35/C\$11.00/C
 1 3/4" \$26.00/C \$15.60/C

Wheels
 2" \$32.60/C \$19.50/C

#AP1 Axle Peg
 Fits 1" to 2" Wheel \$6.95/C\$4.10/C

Brass Plated Flat Head Wood Screws

 (3/8" x #2) \$4.17/C \$2.20/C
 (1/2" x #2) \$4.28/C \$2.30/C
 (1/2" x #4) \$4.40/C \$2.40/C
 (1/2" x #5) \$5.03/C \$2.50/C
 (3/4" x #7) \$5.27/C \$2.60/C

Screw Hole Buttons
 3/8" \$3.03/C \$1.70/C
 1/2" \$3.23/C \$1.70/C

Dowel Pins 3/8" x 2"
 \$3.08/C \$1.80/C

Saw Tooth Hangers

 \$6.95/C \$4.17/C

Brass Pkt. Picture Hanger

 \$7.95/C \$4.70/C

Clock Movements w/ Hands

 Q82 \$10.62/ea. \$6.48/ea.
 \$49.50/5 \$25.50/5

5" Clock Dial
 — White Plastic \$2.50/ea. \$1.80/ea.

Lazy Susan Bearing

 3" \$1.15/ea. \$.69/ea.
 4" \$1.60/ea. \$.96/ea.
 6" \$2.80/ea. \$1.73/ea.

Brass Plated Candle Cup

 \$5.00/10 \$2.80/10
 \$49.00/C \$25.90/C

Two Prong, 6" Brass & Porcelain Hook

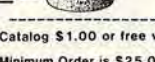
 \$4.95/ea. \$2.97/ea.
 \$45.00/10 \$27.00/10

Three Prong, 6" Brass & Porcelain Hook

 \$8.25/ea. \$4.95/ea.
 \$29.00/4 \$18.00/4

Jiggle Eyes

 (1/4") \$2.45/C \$1.40/C
 (1/2") \$3.45/C \$2.00/C
 (4/5") \$6.85/C \$4.10/C

Disk Magnets

 \$2.98/6 \$1.61/6

Note: C = 100

Catalog \$1.00 or free with order Total Order

Minimum Order is \$25.00 MN Res. - 6% Tax

Order Amount: \$25.00 to \$49.99 \$3.50 Shipping
 \$50.00 to \$99.99 \$4.50 Shipping
 Over \$100.00 \$5.00 Shipping

Visa Master Card

MONEY BACK GUARANTEE! Alaska, Hawaii, Canada & APO Orders Add \$6.00

SIGNATURE _____

CARD NO _____ EXP DATE _____

NAME _____

ADDRESS _____ CITY _____

STATE _____ ZIP _____ PHONE () _____

MEISEL HARDWARE SPECIALTIES
 P.O. Box 258 W4, Mound, Minnesota 55364 • (612) 472-5544

Build furniture, cabinets, interiors like a pro!

Here's the latest how-to for fine wood-
working: Cabinetmaking, Furniture-
building, Built-ins, Veneering, Lami-
nating, Panelling, Joinery, Finishing,
Woodworking projects, much more!

- 992 pages! • Thousands of ILLUSTRATIONS!
- Special COLOR SECTION showing fine hardwood grain patterns actual size!
- Plans for power tool jigs! Handy project plans!

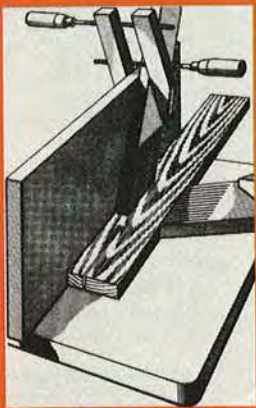

Use this setup for ripping long, thin stock.



Making a compound miter cut.

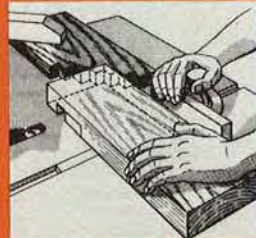

Use a notched stop block to control the width of cut for a lap joint.



Mobile mixing center.

One of the finest
training manuals of all time!
Now completely revised
and better than ever!

CABINETMAKING AND MILLWORK



- Nearly 1,000 pages.
- Big 7 1/4" x 9 1/2" format.
- Thousands of explanatory pictures.

FREE

HANDY
20-IN-1
SHOP
GUIDE
When
You
Join



When you join Popular Science Book Club with this special offer, you also get the handy Popular Science 20-IN-ONE Shop Guide. It measures in inches and centimeters. It's a compass, protractor, drill and chisel grinding gauge, a bolt and screw sizer, a bolthead and penny nail measurer and much more. It's printed and die-cut on durable vinyl to last for many years of handyman projects.

To get your 992-page copy of
CABINETMAKING & MILLWORK
MAIL ATTACHED CARD TODAY

This giant woodworking classic shows you how!

You simply agree to buy just two more regular selections or alternate books at regular Club prices within a year. You can choose from hundreds of brand new, hard-to-find handyman books offered to the membership each year.

**Yours now
for just \$39.95**

as your welcome to Popular Science Book Club

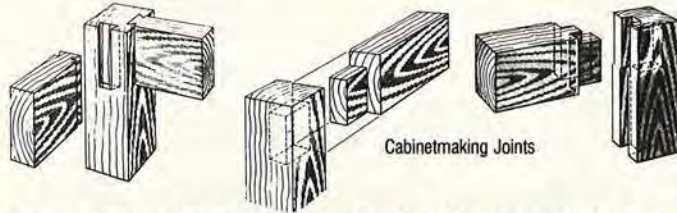

Cabinetmaking Joints

Make a drawer for a kitchen cabinet • Veneer a table top • Glue together a bookcase • Read blueprints • Sharpen a hand saw • Turn a chair leg on a lathe • Make a scale drawing • Bleach wood • Install drawers, doors in built-ins • Make a skeleton frame for a cabinet • Make rabbet joints, dado joints • Select the best wood for every job • Bore holes at an angle with a drill press • Apply plastic laminate to a countertop • Order lumber • Much, much more!

CABINETMAKING AND MILLWORK

by John L. Feirer

NEWLY REVISED SECOND EDITION

If you're like most do-it-yourselfers, you probably do most of the routine woodworking jobs around the house yourself and pay to get the fancier work done. Yet the real satisfaction of woodworking comes from doing those fancy jobs yourself: making a wall of handsomely grained built-ins... wood-panelling an entire room... constructing a table with a perfectly matched veneer top. Yes, you can do all of these fancy jobs yourself even without experience when you've got a copy of CABINETMAKING AND MILLWORK as your guide.

Thousands of show-how pictures guarantee success!

This excellent, 992-page volume is a complete education in fine woodworking. It teaches you exactly how to do every step of every woodworking job you'll ever want to do. Thousands of explanatory pictures, charts, assembly drawings, finishing illustrations, construction details and more make this book very easy to use...even for a novice! (Think of the money you can save by building, repairing, finishing and refinishing all kinds of home woodworking projects yourself!)

Super clear how-to on tools, wood, construction materials, finishing and much more!

CABINETMAKING AND MILLWORK is such a giant how-to book that it takes more than 1700 separate index listings just to tell you where to look for each step-by-step answer. You get more than 200 pages on how to use hand tools, power saws, shapers, routers, drills, boring machines, lathes and more, including how to sharpen and care for tools and make a variety of jigs for power tools. More than 300 pages of specific construction plans for built-ins, kitchen cabinets, room dividers, tables, bookcases, furniture of every description.

Includes A-to-Z wood finishing section!

You get more than 100 pages of step-by-step how-to for all kinds of fine hardwoods and practical softwoods, plywood, composition, hardware, plastic laminates, etc. There's much, much more on how to read blueprints, how to make construction drawings, estimate costs, purchase materials at big bargains, plus up-to-date information on metrics. Every detail you need to know is given the complete, clear-cut treatment in this excellent do-it-yourself book. You'll use it for years as one of your favorite "handyman tools"

If card is missing write to:

POPULAR SCIENCE BOOK CLUB P.O. Box 2006, Latham, N.Y. 12111

NEWLY REVISED SECOND EDITION

Regular Price: **\$39.95**

CLUB MEMBERSHIP gives you first choice of the best new, hard-to-find handyman books on today's most important do-it-yourself subjects:

- HOME REPAIR AND IMPROVEMENT, HOUSE BUILDING, WIRING, PLUMBING, CONCRETE, MASONRY, WOODWORKING, WORKSHOPS, FURNITURE BUILDING, APPLIANCE REPAIR, CARS AND CAR REPAIR, ELECTRONICS, MACHINES, TECHNOLOGY, INSULATION, ENERGY SAVERS, & MUCH MORE.

HOW POPULAR SCIENCE BOOK CLUB WORKS

First, you get your 992-page copy of CABINETMAKING & MILLWORK and your free Popular Science 20-in-1 Shop Guide for just \$3.95 plus delivery and handling. Send no money now. We'll bill you after you receive your shipment.

Then, about every four weeks (14 times a year), you'll receive a colorful Club members' bulletin package describing the coming main selection and alternate books also available. In addition, up to 4 times a year, you may receive selected mailings on seasonal products of special interest to the membership—many at giant bargains! If you want the main selection only, do nothing. It will be sent to you automatically. If you don't want the main selection, or want alternate books, or no books, simply indicate your wishes on the handy form that comes with the bulletin and return it to us by the date indicated. (No envelope is needed.)

You will always have at least ten days in which to do this, but in the unlikely event that you don't, and you receive an unwanted selection, you may return it at our expense.

Your only obligation is to buy just two more regular selections or alternates at regular Club prices in the next year. After that, membership may be cancelled at any time, by either you or the Club.

Club books are comparable to the higher-priced publishers' editions, yet you may save up to 50% and sometimes more on many bargains offered throughout the year to the membership.

What a great way to build a valuable library of the best new, hard-to-find handyman books on just about every do-it-yourself subject. It's always your choice and you are never pressured to buy a book you don't want. Club membership is easy, convenient, and there are many bargains to choose from. To start the bargains coming your way, simply mail the enclosed postpaid card today. You'll be glad you did!

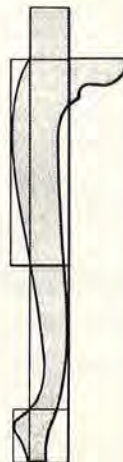
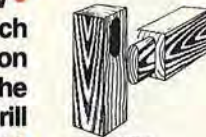
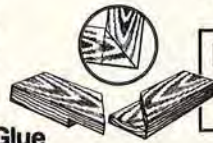

TOOL CITY

BEATS ANY AD PRICE THIS ISSUE

FREIGHT PREPAID (USA)

MAKITA

ALL MAKITA TOOLS
30-45% OFF • PHONE FOR PRICE

HITACHI

All Hitachi Tools
30-45% OFF • PHONE FOR PRICE

MILWAUKEE

ALL MILWAUKEE POWER TOOLS
25-40% OFF • PHONE FOR PRICE

PORTER CABLE

ALL PORTER CABLE POWER TOOLS
25-45% OFF • PHONE FOR PRICE

BOSCH

ALL BOSCH POWER TOOLS
25-45% OFF • PHONE FOR PRICE

RYOBI

ALL RYOBI TOOLS
25-45% OFF • PHONE FOR PRICE

A E G

ALL A E G POWER TOOLS
30-45% OFF • PHONE FOR PRICE

SENCO

ALL SENCO NAILGUNS & FASTNERS
BIG DISCOUNTS • PHONE FOR PRICE

BIESEMEYER RIP FENCES

28" Home Shop \$189 40" Home Shop \$199
52" Home Shop \$239 52" Commercial \$289
Blade Finder \$119 Angle Finder \$119

Call for other Biesemeyer Products

FREUD

SAW BLADE SPECIALS

FREUD SAW BLADES 10" = 3/4"

Bore Carbide Tipped 12" = 1" Bore

No.	size	teeth	use	list	sale
LU72m10	10"	40	general	\$ 68.58	\$ 34.50
LU73m10	10"	60	cut-off	79.65	35.00
LU73m12	12"	72	cut-off	113.35	76.00
LU78m10	10"	80	plastic	117.02	83.50
LU82m10	10"	60	cut-off	86.40	44.00
LU82m12	12"	72	cut-off	123.36	85.95
LU84m11	10"	50	comb	74.51	37.00
LU85m10	10"	80	cut-off	110.88	62.00
LM72m10	10"	24	ripping	68.58	35.00
DS306	6"		Dado	139.00	94.00
DS308	8"		Dado	179.00	107.00

WE CARRY EVERY ITEM FREUD MAKES
CALL FOR BIG DISCOUNTS



FREE
WOODEN
CASE

FREUD TOOL SETS

	REG.	SALE
4pc Chisel set	\$ 29	\$ 19
6pc Chisel set	39	29
10pc Chisel set	67	49
8pc turning set	68	49
6pc carving set	75	58
12pc carving set	139	109
Carvers mallet	10	8

ALL FREUD ROUTER BITS & SHAPER CUTTERS 25% OFF

TOOL CITY

14136 E. FIRESTONE BLVD.
SANTA FE SPRINGS, CA 90670

5 Fry at Valley View Exit

Open Monday-Saturday 8:00 am-5:30 pm

WE SHIP IT FAST!

OUTSIDE CA 1-800-423-7899

INSIDE CA 1-800-826-7819

METRO LA 213-802-1236



or personal check

BANDSAW BLADES 1/4" to 3/4" widths,
5¢ per INCH and a \$1.85 weld charge
per blade because we ship prepaid.
Minimum order is 5 blades.



HITACHI PLUNGE ROUTER SALE

Both come with
\$60 worth of
accessories

HP	MDL#	List	Sale
1	TR8	\$206	\$119
3	TR12	\$299	\$169



RYOBI 10" Miter Saw with
Freud LU85 10 x 80 T. Teflon Blade
Last month of this sale
\$209 (Reg. 439.00)
Accessory Kit \$20.00

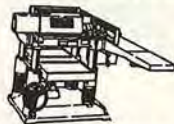

HITACHI F1000-A 12" planer
6 3/4" jointer combination
15 amp 2.7 HP 26 feet
Min list \$2100
SALE \$1239.00 prepaid
P-100-F 12" Planer Sale
\$949.00 prepaid

FREE WITH ANY ORDER
#1 PREPAID FREIGHT
#2 2-YR SUBSCRIPTION
TO TOOL CITY CATALOG



RYOBI
10" PLANER
\$399.00



FREUD Raised Panel Bit Sale
Reg. \$129

SALE Your choice \$89.00

EC202 EC209 EC210

EC211 EC212 EC213

For 3/4" stock, 3/4" bore
with 1/2" bushings



CARBIDE TIPPED

6-pc. complete stile & rail set for 3/4"
stock, 3/4" bore with 1/2" bushing.



FREUD 15-piece router bit set.
Complete with wooden case,
retail price is well over \$300.
On SALE now \$139.

TALKING BACK

Print this article

We welcome comments, criticisms, suggestions... even an occasional compliment. The volume of mail we receive makes it impossible to answer every letter, but we promise to do our level best. Send your correspondence to Letters Editor, Better Homes and Gardens® WOOD Magazine, Locust at 17th, Des Moines, IA 50336.

POSTSCRIPT TO A SHOP SAFETY TIP

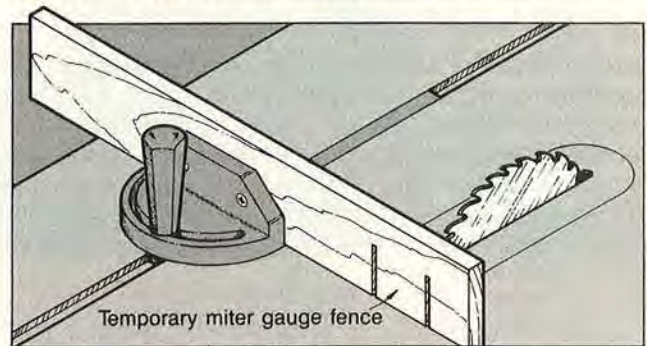

In your December, 1985 issue (p. 10), you printed a safety tip about flicking away small scraps from the table-saw blade with the eraser end of a pencil. There's another way: What I do is screw on a piece of, say, 1/2" stock just a little higher than the crosscut fence and let it extend about 2" on the blade side. Then, when I miter, I push the piece through and don't have to worry about flicking the small scrap piece into the saw blade.

—John Rendl, North Riverside, Ill.

MORE ADVICE ABOUT THE SURFACE SANDER

Few of our projects have generated as much enthusiastic response as the surface sander that appeared in our October, 1985 issue (p. 48). It sounds as if this homemade tool filled a void in a lot of workshops. Here's the latest tip we received from a reader who built one:

When using the shop-built thickness sander to sand boards 6" wide or less, wind one-half of the drum with medium paper and the other half with fine, instead of removing the sandpaper to change to a finer grit. Use strapping tape to hold paper on the drum.

Another piece of tape is used to divide the infeed table. I am now looking for pillow blocks that easily can be removed so that a set of drums with different grits of paper can be made up and changed as needed.

—Joseph C. Denefeld, San Francisco, Calif.

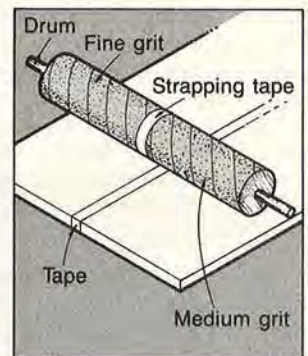

Continued on page 78

SHOPSMITH® HELPS YOU BUILD A HORSE THAT CAN SURVIVE THE "JAMES" GANG!

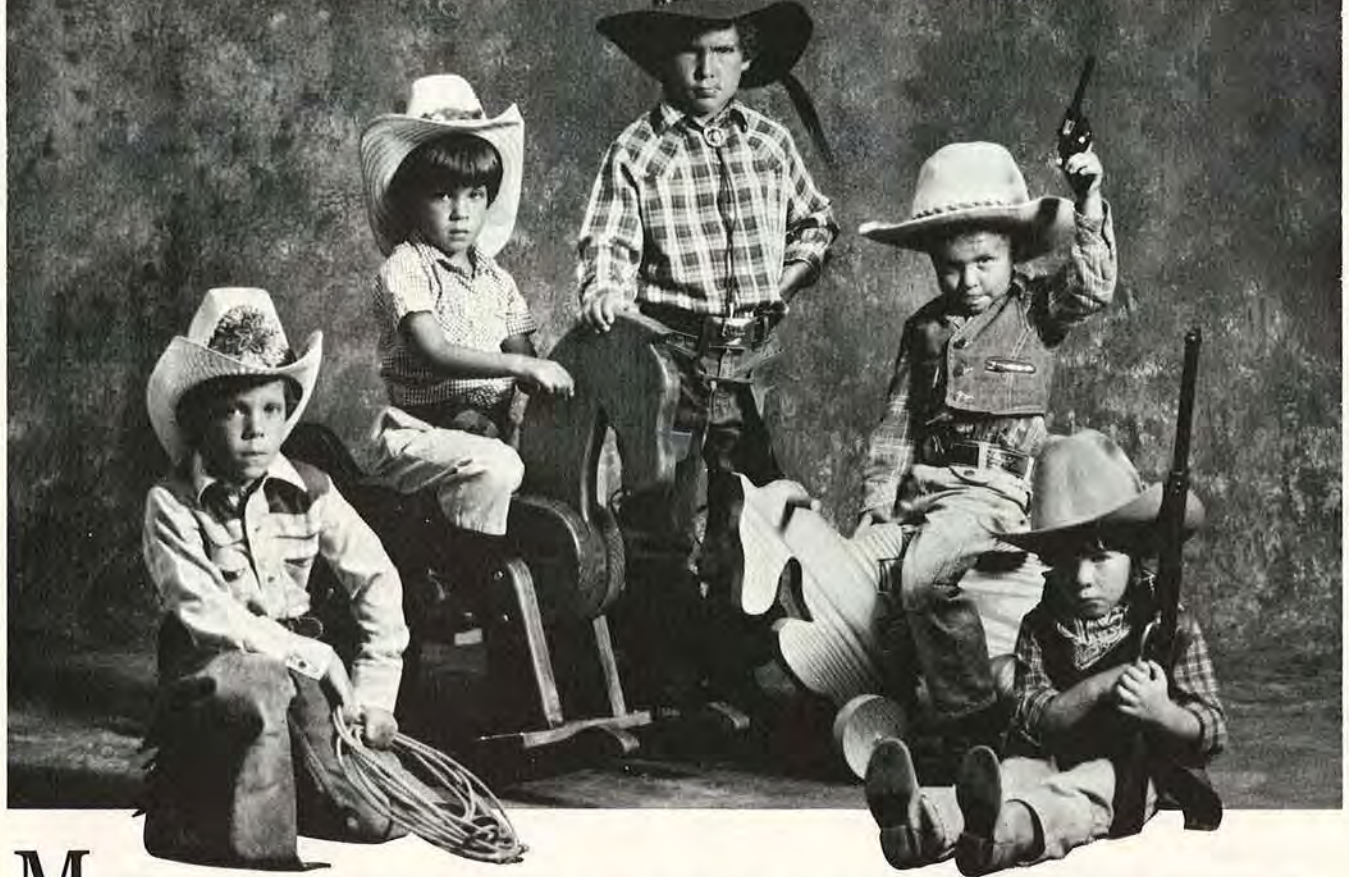

Meeet James and the gang. They're tough customers when it comes to toys. But their little broncos pictured here are just as rugged. Hand-built from solid oak, they'll ride tough for years to come, even with this rough and tumble bunch.

Shopsmith gives you the tools.

With some wood and a bit of time, you can build a one-of-a-kind hobby horse, a new deck for your house or a wall of custom hardwood bookshelves. And you can do it all with the Shopsmith MARK V.

The MARK V gives you the five most-needed woodworking power tools in a compact unit no bigger than a bicycle. You can saw, drill, bore, sand and shape lumber into finished projects with this one amazing multi-purpose tool. And since the MARK V is easy to operate, you can start building

the things you want the day you roll it into your shop.

And the know-how.

Shopsmith provides the instruction, advice and education you need to become the best woodworker possible. You can order a MARK V by mail, by phone, at one of our free demonstrations or at one of our Shopsmith stores. But when you buy a MARK V, you'll get more than America's best-selling five-in-one power tool. You'll have a gang of woodworking experts you can count on every step of the way.

Free Information Kit and Magazine Subscription!

Send in the coupon below and receive a Free MARK V information kit, including a copy of "How To Determine Your Best Power Tool Buy." Act now and you'll also receive a Free one-

year subscription to "Hands On," the famous Home Workshop Magazine.

Call Toll-Free 1-800-821-2103
In Nebraska - 1-800-642-8788



© Shopsmith, Inc. 1985
Shopsmith® is a registered trademark of Shopsmith, Inc. Available in the U.S.A. and Canada only.

Please send me a Free MARK V Information Kit and start my Free one-year subscription to "Hands On." I understand I am under no obligation.

Name _____

Address _____

City _____

State _____ Zip _____

I currently own a Shopsmith woodworking power tool.



Shopsmith Inc.

For better woodworkers
And those who want to be

6640 Poe Avenue
Dayton, OH 45414-2591

Dept. 378H

QUALITY PLUS BIG SAVINGS!



Makita
Mitre Box with
dustbag and vise
LS1000
LIST \$348.00
SALE
\$209.95

Makita

Order No.	Description	LIST	SALE
2030*	12" planer/jointer	1980	1395
1805B	6" planer	416	265
1900BW	3" planer kit	154	90
2040*	15" planer	1780	1179
1100	3" planer kit	278	160
6800DBV	Drywall driver	123	89
5007NB	7" circular saw	158	100
JR3000V	Recipro saw	178	120
5402A	16" circular saw	468	315
3700B	Laminate trimmer	124	85
3612BR	Plunge router	286	180
6510LVR	3/8" VSR drill	114	69
6012HDW	Cordless drill kit	178	100
DP3720	3/8" VSR drill	88	55
DP4700	1/2" VSR drill	154	95
9030	1 1/8" x 21" belt sander	185	125
9401	4" x 24" belt sander	279	160
9501	4" sander/grinder kit	119	87
9900B	3" x 21" belt sander	198	120
9924B	3" x 24" belt sander	204	135
9924DB	3" x 24" dustless belt sander	214	135
B04510	Finishing sander	79	44
9045N	Dustless finishing sander	156	105

Metabo

Order No.	Description	LIST	SALE
EP564	VS barrel-grip jigsaw	239	186

BLACK & DECKER

Order No.	Description	LIST	SALE
3157	VS orbital jigsaw	178	120
3051	7 1/4" worm drive saw	232	140
3052	8 1/4" worm drive saw	247	170
3102	2-speed cut saw	156	93
3107	Cut-Saw*	188	130
2034	2500 rpm drywall Scrugun*	123	82
2037	4000 rpm drywall Scrugun*	146	91
3030	7 1/4" circular saw	159	99
3047	7 1/4" circular saw	232	150
3048	8 1/4" circular saw	246	159
4008	Palm grip sander	76	50
4247	4 1/2" grinder	105	68
1179	3/8" VSR Holgun* drill	116	70
1311	1/2" VSR Holgun* drill	157	104
1920	Reversible cordless drill	160	115
1980	reversible adjustable clutch cordless drill	179	129

VIRUTEX

Order No.	Description	LIST	SALE
081	Plate jointer	335	299
Plate #0		31	28
Plate #10		32	28
Plate #20		33	28
AU93	Veneer hand trimmer	20	18
U78	Veneer sheet trimmer	140	130

RYOBI

Order No.	Description	LIST	SALE
TS-251U	10" mitre saw with carbide blade	411	230
X2300	Vise, holder, bag kit for TS-251U		20
TS380	14" mitre saw	550	375
AP-10	10" portable thickness planer	659	425

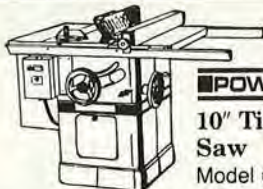

POWERMATIC

10" Tilting Arbor Saw
Model 66 (Specify either 3 hp/single phase or 5 hp/triple phase motor)
LIST \$2129.00

SALE
\$1850.00

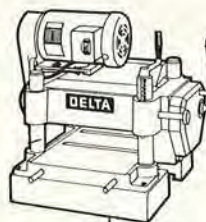

DELTA
RC-33 13" Planer
22-651
LIST \$1729.00
SALE
\$995.00



BLACK & DECKER
Palm Grip Sander
4008
LIST \$76.00
SALE
\$49.95

DELTA Super Savings!

Order No.	Description	LIST	SALE
46-541*	Wood lathe with accessory package	2771	1399
46-140*	11" wood lathe	551	430
34-150	UNIFEEDER stockfeeder	574	199
34-155	Unifence adapter kit for 34-150	50	20
43-150	Shaper adapter kit for 34-150	199	95
34-781*	10" UNISAW 1 1/2 hp	1784	1499
34-782*	10" UNISAW 3 hp	2081	1850
34-783*	10" UNISAW 5 hp	2081	1850
34-784*	10" UNISAW 5 hp	2081	1850
34-172*	Tenon attachment for UNISAW	215	169
34-010S	9" mitre saw	231	170
15-091*	15" floor model drill press	486	375
15-231*	15" step-pulley drill press	1101	940
15-331*	15" VS drill press	1243	1062
23-650	6" bench grinder	173	139
23-750	7" bench grinder	283	240
23-850	8" bench grinder	330	282
28-243/62-142*	1/2 hp bandsaw	717	562
28-243/62-246*	3/4 hp bandsaw	818	645
28-283*	3/4 hp bandsaw	933	699
22-651*	RC-33 13" planer	1729	995
50-651*	Stand for RC-33	276	225
22-460*	20" planer 7 1/2 hp	4667	3990
22-461*	20" planer 5 hp	4667	3990
22-600*	24" planer 7 1/2 hp	6496	5554
22-602*	24" planer	10900	9310
22-610*	24" planer	6700	5725
33-150*	Sawbuck* frame & trim saw	707	519
31-730/52-611*	Finisher	1384	1180
33-890*	12" radial arm saw	1367	1050
33-990*	10" radial arm saw	606	469
34-621/52-493*	9" builder's saw	710	539
34-410/62-042*	10" contractor's saw	1032	799
34-429*	10" tilting arbor saw	1193	899
34-790*	14" tilting arbor saw	3993	3365
34-889*	10" scoring saw 3 hp	2950	2595
34-890*	10" scoring saw 5 hp	2950	2595
34-794*	14" panel saw	6109	5225
37-420*	16" precision jointer	4657	3980
37-220/50-290/62-247*	6" jointer	1139	975
37-220/52-891*	6" jointer	1292	1105
37-315/49-054*	8" jointer	1583	1355
40-601*	Electronic scroll saw	1074	859
50-180*	1 hp dust collector	463	389
50-181*	2 hp dust collector	658	550
43-122*	LD wood shaper	680	519
43-375*	2-speed shaper with 1/2" and 3/4" spindles	2111	1805
43-385*	2-speed shaper with 1" spindle	2111	1805
43-561*	Overarm router	2525	2158
43-780*	5-speed shaper 7.5 hp	3655	2950
43-781*	5-speed shaper 5 hp	3655	2950

CALL FOR SPECIAL PRICES ON ALL DELTA CUTTERS

This ad expires 5-1-86. Watch for our next ad.

While Supplies Last

w.s. JENKS & Son



2024 West Virginia Ave. NE 738 7th Street NW
Washington DC 20002 Washington DC 20001
(202) 529-6020 (202) 737-7490



SPECIAL!
FREUD LU73 10x60th General Purpose ATB Saw Blade
LIST \$79.65
\$29.95

with the purchase of any three FREUD blades or cutters
freud

Order No.	Description	LIST	SALE
LU82M010	10" x 60th general purpose TCG	86	40
LU72M010	10" x 40th general purpose ATB	69	34
LU81M010	10" x 40th general purpose TCG	69	36
LU85M010	10" x 80th super saw ATB	111	65
LU84M011	10" x 50th combination 4&R	62	39
LM72M010	10" x 24th straight line	64	39
LU85M009	9" x 72th super saw ATB	102	64
PS203	7 1/4" x 24th general purpose ATB	27	18
PS303	7 1/4" x 40th general purpose ATB	33	24
DS308	#3 Dado	170	119
04-106	1/4" diam. solid carbide 1/2" diam. mortising bit C.T. 1/2" radius cove bit C.T.	11	8.80
16-100	1 1/4" diam. rabbeting bit C.T. 1/4" rounding bit C.T.	13	10
30-106	1 1/2" diam. solid carbide flush trim bit	34	25
32-100	1 1/4" diam. solid carbide flush trim bit	27	22
34-110	5/32" ogee bit C.T.	28	22
38-100	flush trimming bit	33	26
64-100	Solid carbide flush trim bit	16	12
66-100	Solid carbide 7" bevel bit	7.84	6.10
3557R	35mm dia. boring bit	8.30	6.64
06218	2 1/8" dia., 1/2" shank boring bit	32	25
C310	Set of 3-4" jointer knives	89	69
C350	Set of 3-6" jointer knives	18	13
C441	Set of 3-8" jointer knives	27	19
	NOTE: All saws and Dado have 5/8" bore.		
	All router bits have 1/4" shank.		
	ATB = Alternate Top Bevel		
	4&R = 4 Teeth & 1 Raker Tooth		
	C.T. = Carbide Tipped		

POWERMATIC

Order No.	Description	LIST	SALE
1660750TS*	10" tilting arbor saw 5 hp	2129	1825
1660760TS*	10" tilting arbor saw 3 hp	2129	1825
1680170TS*	12" tilting arbor saw 5 hp	2815	2395
1260100*	Shaper	2025	1799
1260050*	Shaper	2025	1799
1500040*	6" jointer	1188	999
1610040*	8" jointer	1870	1775
1610050*	8" jointer	1620	1499

PORTER-CABLE

Order No.	Description	LIST	SALE
9627	Tiger saw	194	132
9629	VS electronic tiger saw	194	142
7348	Bayonet saw	163	114
7548	Top-Handle jig saw	199	136
7648	Barrel-Grip jigsaw	199	139
314	4.5 amp saw	180	126
315-1	13 amp saw	166	108
346-1	12 amp saw	162	113
368-1	13 amp saw	177	123
587	14.5 amp saw	199	139
336	3x21 belt sander	180	126
337	3x21 belt sander dustless	190	133
360	3x24 belt sander dustless	280	196
361	3x24 belt sander	260	182
362	4x24 belt sander dustless	295	201
363	4x24 belt sander	280	196
503	3x24 worm gear dustless	510	357
504	3x24 worm gear	495	346
330	Finish sander	87	54
505	Finish sander	175	113
100	7/8 hp router	141	96
536	1 1/2 hp router	300	210
630	1 hp router	150	105
690	1 1/2 hp router	194	132
691	1 1/2 HP Router D-handle	218	153
537	1 1/2 hp router	315	220
518	Spectronic router	490	343
520	3 hp router	460	314
513	HD lock mortiser	952	708
5009	Mortise & tenoning jig	50	35
9118	Porta-Plane kit	299	204
9652	Versa-Plane kit	419	293
319	Laminate trimmer	215	145
309	Laminate trimmer	130	91
310	Laminate trimmer	190	133
312	Laminate trimmer	205	143
9725	2-speed Porta-Band kit	405	277
9728	2-speed Porta-Band kit	499	341
695	Shaper table with motor	278	190
696	Shaper table	150	103
7540	VSR drywall driver	153	104
7545	Drywall driver	158	108
621	3/8" VSR drill	130	78
666	3/8" HD VSR drill	165	122
7514	1/2" drill	169	115
7511	3/8" pistol drill	164	112
97650	1/2" VSR drill kit	201	137

FREE FREIGHT ON ALL PORTABLE MODELS!

Items marked with * are considered non-portable. Call for prices on shipping.

TOLL FREE ORDER LINE 1-800-638-6405
MASTERCARD • VISA • AMERICAN EXPRESS

6 SPECIAL VALUES FROM TREND-LINES

ACCURATELY SET JOINTER KNIVES IN 10 MINUTES



MGJS Jointer Set \$39.95

The Magnaset fixture allows you to quickly and accurately set jointer knives. Actually get finish cuts to a tolerance of plus or minus .0005! Works on steel or carbide blades.

BLADE SHARPENER HANDLES LONG PLANER BLADES

By Makita



MK98202 \$169.95

Sharpen flat blades up to 15 3/4" wide. 7 7/8" grinding wheel for scissors, knives, planer blades and more. Water feed system assures no heat build-up. With 1000 grit grinding wheel, blade holder, rule assembly.

RYOBI 10" PLANER HANDLES MOST WORK, COSTS LESS THAN 1/2 AS MUCH AS 12" PLANERS!

Power-feed planing to handle boards 10" wide and 5" thick. 1/8" cutting depth. Feed 26" of wood per minute. RYAP10

\$399.95



Trend-lines, Inc. 375 Beacham St., Chelsea, MA 02150

Order Hot Lines: 800-343-3248 (USA) 800-322-6100 (MA)

SAVE ALMOST 50% ON DELTA'S 12" WOOD LATHE!

\$2771.00 LIST
SALE PRICE: \$1399.00

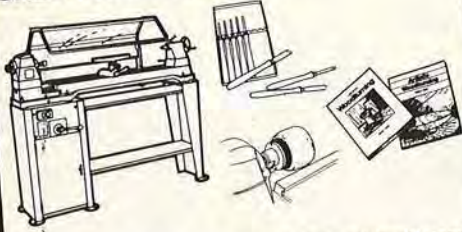

Smooth operation (340 to 3600 RPM) with efficient variable speed drive. Unique indexing pin engages drive quickly. Turn 12" x 39" over bed, 16" x 2 1/2" over gap. 3/4 H.P. motor with push button start stop switch. Special set includes Delta's new Super-chuck, eight turning tools and two how-to books. RW46541S Sale Price \$1399.00

FREE FREUD LU85M10 BLADE WITH PURCHASE OF RYOBI 10" MITER SAW

GET FREUD'S FINEST BLADE FREE!



A rugged saw, with positive stops at 90°, 22.5°, and 45° right and left. Electric brake, and spindle for easy blade change. 12 1/2 amps for 5000 RPM performance. Only 33 lbs. With vice assembly, extensions, stop and dust bag. RYTS251UB \$229.00

THE 3 H.P. ROUTER WORKSHOP A TREND-LINES 4 FOR 1 EXCLUSIVE

ROLLER EDGE & GUIDE BUSHING KIT

Handle any curve or shape with this invaluable kit. Adapter plate, edge guide and four guide bushings.

FREUD 15 PC. CARBIDE TIPPED ROUTER BIT SET WITH CASE



ROUTER HANDBOOK

Patrick Spielman's definitive book on the router will allow you to use your equipment in ways you never dreamed possible.



RYOBI R-500 3 H.P. ROUTER



OUR PRICE \$299.00
LIST PRICE \$590.00
CODE TFRW500

TIPS FROM YOUR SHOP (AND OURS)

Print this article

In woodworking, as in life, no one knows it all. But through experience, we all discover—or stumble onto—better, safer, faster, or easier ways to do things. When we devise interesting tips or techniques, we'll share them with you in this column. And when you send us your favorites, we'll pay you \$25 for each submission we publish. No shop tips can be returned. Mail your tips to:

Shop Tips
Better Homes and Gardens®
WOOD Magazine
Locust at 17th
Des Moines, IA 50336

An eraser you'll almost never wear down

You should always carefully erase pencil marks before sanding wood projects, but laying your hands on a pencil with a "business end" on it isn't easy to do.

TIP: The cleaning stick that does such a fantastic job of dressing your abrasive belts makes just about the finest shop eraser you'll ever find. Use it for eliminating light pencil marks. It's tough and sure to last a long time.

—William Becker,
Deep River, Conn.



No soap

Yuck! You use a bar of soap to lubricate wood screws, but it's a mess keeping the soap damp. In addition, soap can cause rusting.

TIP: Someone finally has found another application for the wax gaskets used as toilet bowl seals. The wax is ideal for lubricating screws and nails and reduces the chance of breaking screws driven into hardwood. It will not attract moisture and can be purchased at your local hardware store.

—Max Beard,
Silver Spring, Md.

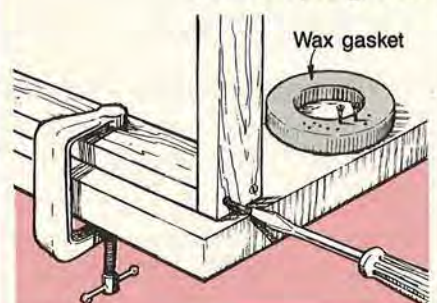

Continued



\$20 AN HOUR

YOU CAN EARN UP TO THAT AMOUNT IN YOUR OWN BUSINESS!

Yes there's plenty of business waiting for the man who can professionally sharpen saw and all types of edge cutting tools. BELSAW SHARP-ALL does them ALL and at a BIG PROFIT for you. No inventory is involved... No selling. You earn a year-around CASH income and make 90¢ PROFIT out of every dollar you take in. Work spare time hours or full time right at home, and no experience is needed.

With the BELSAW SHARP-ALL It's Easy To Get Started!

You don't need to invest thousands of dollars to get started in business for yourself. Low cost Belsaw Sharp-All and our 50 years of experience in helping sincere men to earn extra income, plus the desire to get ahead is all you need. Complete Operator's Manual gives clear, step-by-step instructions, shows exactly how to sharpen each tool, where to get the "tricks of the trade". And the Belsaw Sharp-All does the kind of precision job that brings customers back time after time. There are NO franchise fees of any kind. With the Belsaw Sharp-All YOU are the boss... YOU set the hours YOU want to work... YOU put the PROFITS in YOUR pocket!

30-DAY FREE TRIAL OFFER

If coupon has been removed, just send a postcard with your name and address to—
BELSAW MACHINERY, DEPT. 60590, P.O. BOX 34620, N. KANSAS CITY, MO 64116

	BELSAW MACHINERY DEPT. 60590 P.O. BOX 34620 N. KANSAS CITY, MO 64116	RUSH COUPON TODAY!
	<input type="checkbox"/> YES, please send me the FREE booklet "LIFETIME SECURITY" and full details on your 30-Day Free Trial Offer. I understand there is No Obligation.	
Name _____		
Address _____		
City/State _____ Zip _____		

GET IN ON THE PROFITS



There is NO OBLIGATION!

TIPS FROM YOUR SHOP (AND OURS)

Continued

The chips are down

A power miter box is a slick device, but chipping and splintering can be a nuisance.

TIP: Use clamps or screws to secure a 1/2"-thick birch or maple fence to the back of the vertical guide. When the slot enlarges after prolonged use, replace it with another liner. You'll find these liners particularly helpful when the face side of molding is opposite the cutting direction of the saw blade.

—From the WOOD Shop

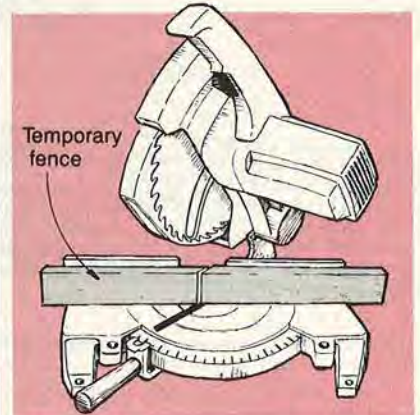

Mirror image in half the time
Drawing half of a full-size pattern is hard enough, but matching the pattern for the other side is just as taxing.

TIP: Draw one-half of your pattern on a piece of folded paper. Fold and insert a piece of carbon paper, carbon side out, into the folded pattern. Then trace the pattern, open the paper, and unfold a full-sized pattern with identical halves. Now transfer your "perfect" pattern.

—L.E. Masters,
Holloman AFB, N.M.

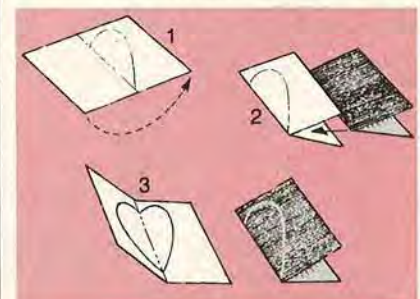

Continued on page 17

FREE SANDING BELTS

DIRECT FROM THE MANUFACTURER

GET SIX FREE BELTS FOR EACH DOZEN ORDERED. All belts are aluminum oxide first quality. Our electronic presses make smooth bump-free splices.

Check your size and how many dozen. We will ship assorted grits unless otherwise specified.

- 1" x 30" — \$12.70/doz.
- 1" x 42" — 12.75/doz.
- 1" x 44" — 12.80/doz.
- 3" x 18" — 13.75/doz.
- 3" x 21" — 14.25/doz.
- 3" x 23 3/4" — 14.70/doz.
- 3" x 24" — 14.75/doz.
- 3" x 27" — 15.25/doz.
- 4" x 21 3/4" — 16.75/doz.
- 4" x 24" — 17.25/doz.
- 4" x 36" — 20.95/doz.
- 6" x 48" — 26.95/1/2 doz. (3 FREE)

Other size belts on request.

9" x 11" Paper Sheets

A/O Cabinet Paper

- | | | |
|-------|-----------------------------------|-----------------------------------|
| | 50/pk. | 100/pk. |
| 40-D | <input type="checkbox"/> \$17/pk. | <input type="checkbox"/> \$31/pk. |
| 50-D | <input type="checkbox"/> 16/pk. | <input type="checkbox"/> 28/pk. |
| 60-D | <input type="checkbox"/> 15/pk. | <input type="checkbox"/> 26/pk. |
| 80-D | <input type="checkbox"/> 14/pk. | <input type="checkbox"/> 24/pk. |
| 100-C | <input type="checkbox"/> 13/pk. | <input type="checkbox"/> 22/pk. |
| 120-C | <input type="checkbox"/> 13/pk. | <input type="checkbox"/> 22/pk. |
| 150-C | <input type="checkbox"/> 13/pk. | <input type="checkbox"/> 22/pk. |

No Load Finishing Paper

- | | | |
|-------|-----------------------------------|-----------------------------------|
| | 50/pk. | 100/pk. |
| 180-A | <input type="checkbox"/> \$11/pk. | <input type="checkbox"/> \$19/pk. |
| 220-A | <input type="checkbox"/> 11/pk. | <input type="checkbox"/> 19/pk. |
| 280-A | <input type="checkbox"/> 11/pk. | <input type="checkbox"/> 19/pk. |
| 320-A | <input type="checkbox"/> 11/pk. | <input type="checkbox"/> 19/pk. |
| 400-A | <input type="checkbox"/> 11/pk. | <input type="checkbox"/> 19/pk. |

Wet or Dry S/C Paper

- | | | |
|-------|-----------------------------------|-----------------------------------|
| | 50/pk. | 100/pk. |
| 220-A | <input type="checkbox"/> \$15/pk. | <input type="checkbox"/> \$25/pk. |
| 320-A | <input type="checkbox"/> 15/pk. | <input type="checkbox"/> 25/pk. |
| 400-A | <input type="checkbox"/> 15/pk. | <input type="checkbox"/> 25/pk. |
| 600-A | <input type="checkbox"/> 15/pk. | <input type="checkbox"/> 25/pk. |

NEW ITEM!

BELT CLEANING STICK - \$6.95

Prompt delivery from stock.
MONEY-BACK GUARANTEE

Shipping Charges - Under \$35 add \$2.50; \$35 or more add \$4.00—PA residents add 6% sales tax.

- Check or Money Order.
 MasterCard VISA Exp. Date _____

Acct. # _____

Name _____

Address _____

City, State & Zip _____

CALL TOLL FREE
1-800-428-2222

PA Only - 1-800-222-2292

INDUSTRIAL ABRASIVES CO.
643 North Eighth Street
Reading, PA 19603



HOW-TO BOOK CLUB

Discover the Troubleshooting and Repair Secrets of Skilled Auto Mechanics and Home Craftsmen

- Repairing
- Restoring
- Customizing
- Refinishing
- Remodeling
- Renovating

with the Book Club that Makes it Easy

Select 5 Books for Only \$2⁹⁵

Values to \$124.75



1982 List \$19.95



1454P List \$16.95 (paper)



2602 List \$27.95



1638 List \$26.95



1655 List \$21.95



1744 List \$23.95



1922 List \$21.95



1046P List \$8.95 (paper)



1971 List \$21.95



1928 List \$18.95



1528 List \$18.95



1458P List \$12.95 (paper)



1909 List \$21.95



1546P List \$13.95 (paper)



1687 List \$15.95



1245P List \$16.95 (paper)



1238P List \$8.95 (paper)



1122 List \$18.95



1440P List \$9.95 (paper)



1975 List \$22.95



1809 List \$22.95



1321 List \$14.95



1868 List \$18.95



1574P List \$15.95 (paper)



1801 List \$14.95



1354 List \$15.95



1648P List \$11.95 (paper)



1639 List \$16.95



FREE Shop Apron

7 very good reasons to join the How-To Book Club

- **Big Savings.** Save 20% to 75% on books sure to increase your how-to know-how
- **No-Risk Guarantee.** All books returnable within 10 days without obligation
- **Club News Bulletins.** All about current selections—mains, alternates, extras—plus bonus offers. Comes 13 times a year with hundreds of up-to-the-minute titles to pick from
- **Automatic Order.** Do nothing, and the Main selection will be shipped automatically! But . . . if you want an Alternate selection—or no books at all—we'll follow the instructions you give on the reply form provided with every News Bulletin
- **Bonus Books.** Immediately get Dividend Certificates with every book purchased and qualify for big discounts of 60% to 80%
- **Extra Bonuses.** Take advantage of added-value promotions, plus special discounts
- **Exceptional Quality.** All books are first-rate publisher's editions selected by our Editorial Board and filled with useful up-to-the-minute information



HOW-TO BOOK CLUB

P.O. Box 8, Blue Ridge Summit, PA 17214

Please accept my membership in the How-To Book Club and send the 5 volumes circled below, plus my FREE shop apron billing me \$2.95 plus shipping and handling charges. If not satisfied, I may return the books within ten days without obligation and have my membership canceled. I agree to purchase 4 or more books at regular Club prices (plus shipping/handling) during the next 12 months, and may resign any time thereafter.

1046P 1122 1238P 1245P 1321 1354 1440P 1454P 1458P
 1528 1546P 1574P 1638 1639 1648P 1655 1687 1744 1801
 1809 1868 1909 1922 1928 1971 1975 1982 2602

Name _____
 Address _____
 City _____
 State _____ Zip _____ Phone _____

Valid for new members only. Foreign applicants will receive ordering instructions. Canada must remit in U.S. currency. This order subject to acceptance by the How-To Book Club.

BHGW-388

DO-IT-YOURSELF KITS

BUILD YOUR OWN GRANDFATHER CLOCK



Prices Starting **\$280**
Under
(including movement and dial)

- Do-it-yourself case kit, parts pre-cut
- Finished clocks
- Solid 3/4" hardwoods: black walnut, cherry, oak
- Heirloom quality
- Factory direct prices
- Solid brass West German chiming movements
- Money back guarantee
- Prompt shipment
- No woodworking experience necessary

WRITE FOR FREE COLOR CATALOG



EMPEROR
CLOCK COMPANY

WORLD'S LARGEST MANUFACTURER OF GRANDFATHER CLOCKS

Dept. 1805, Emperor Industrial Park
Fairhope, Alabama 36532 • Phone 1-205-928-2316

I am interested in Do-It-Yourself Kits
 Finished Clocks

Name _____
Street _____
City _____
State _____ Zip _____
(please print)

CALL US FOR QUOTATIONS ON MACHINES & ACCESSORIES BEFORE YOU BUY!



POWERMATIC Model No. 26 Shaper
from \$1,650.00 up

Model No. 66 Table Saw
from \$1595.00 up

Miss. residents add 6% tax.

SPECIAL NET PRICES

FREUD carbide raised panel cutters.

- #EC-202 #EC-209
- #EC-210 #EC-211
- #EC-212 #EC-213

\$79.90 each Prepaid in U.S.A.

Call us for your special prices on other Freud and Delta blades and cutters.

Call toll free 800-821-2750.
In Miss. call 800-321-8107.
Ask for Tools Department.

Addkison
HARDWARE CO. INC.

126 E. Amite St., P.O. Box 102
Jackson, MS 39205

DISCOUNT PRICES

ON QUALITY TOOLS AND REPLACEMENT PARTS

Zip-Penn

- Save Up To 35% Off Retail
- Complete Line of Chainsaws and Brushcutters
- Hard to Find Parts for Chainsaws, Lawnmowers and Small Engines
- Hand and Shop Tools
- Tablesaws and Bandsaws
- Repair Manuals and Safety Equipment
- Over 23 Years Experience



SEND FOR OUR FREE CATALOG!

NAME _____
ADDRESS _____
CITY _____
STATE _____ ZIP _____

MAIL TO: ZIP-PENN, DEPT. WOO-03
P.O. BOX 15129
SACRAMENTO, CA 95851

Quality By Design PORTER-CABLE

SUPER PORTER CABLE TOOL DEALS

List	Your Cost
\$ 10.85	5 Bi Metal Assorted Blades
199.50	Model 7548 Orbital Jig Saw - New!
\$210.35	Jig Saw Deal #1
	+ 6.95 Shipping & Handling

List	Your Cost
\$ 2.50	1 Pr. Safety Goggles
134.00	Model 100 7/8HP Router
\$136.50	Router Deal #2
	+ 5.95 Shipping & Handling

List	Your Cost
\$ 13.20	Dust/Mist Respirator w/Filter
190.00	Model 337 Dustless Belt Sander
\$203.20	Belt Sander Deal #3
	+ 6.95 Shipping & Handling

List	Your Cost
\$ 13.20	Dust/Mist Respirator w/Filter
278.00	Model 695 1 1/2HP Router W/Shaper Table
\$291.20	Router w/Shaper Table Deal #4
	+ 7.95 Shipping & Handling

Add Applicable Sales Taxes. Limited Quantities



BRADY SUPPLY CORP.
649 MADISON AVENUE
P.O. BOX 326
ELMIRA, NY 14902-0326
607-733-6591

BUILD IT YOURSELF

TOYS • PUZZLES • PLAQUES • PLANTERS
FURNITURE • LAWN ITEMS • BIRD HOUSES
ROCKING & RIDING HORSES • PLAY SETS



BLUEPRINTS

CREATE HUNDREDS OF ITEMS WITH SAME SIZE PATTERNS PLUS WHEELS AND BOOKS

ILLUSTRATED CATALOG \$1

Design Group, Box 514-Z, Miller Place, N.Y. 11764

CLASSIC CAR PLANS

Easy To Build Full Size Plans



FOR CATALOG OF AVAILABLE FULL SIZE PLANS • SEND \$1.00 TO:



Route 6
Box 29
Neosho, MO
64850

Queen Anne Lowboy Full-Size Professional Plan



You can build this classic piece of furniture. Plan gives construction details of cabriole legs, dove-tailed drawers and chip carving of middle drawer. Overall size: 35 1/2" wide, 20 1/2" deep and 30 1/2" high.

Order Plan #194 .. \$11.75

CATALOG
180 diff., full-size prof. furniture plans — \$2.00
(catalog free with order)

FURNITURE DESIGNS, Dept. BE-36
1425 Sherman Ave., Evanston, Ill. 60201

Wood Moisture Meter

Avoid Moisture Problems
Protect your Masterpiece

Mini-Ligno
\$110 only

Pocket-Size: 1 1/2" x 2 1/4" x 5 1/4"
Incl. Cables, Batteries, and Pins for 1/4" and 3/8" Measuring Depth.

also from Lignomat:
Mini-Ligno E
Range: 6, 7, 38%

Easy to use, sturdy instrument for the professional woodworker or serious hobbyist. Great for lumber, veneer, fiberboards. Ask for free catalog on all moisture meters and accessories for kiln drying. Don't waste money time on wet wood, order a moisture meter now.



Lignomat USA Ltd.
503 257-8957 • 800 227-2105

PO Box 30145 bh
Portland, OR 97230

TIPS FROM YOUR SHOP (AND OURS)

Continued from page 14

Outstanding in a supporting role

If you have a basement shop, there's a good chance you've cursed the steel posts that support beams in many newer homes.

TIP: Put those posts to work in your basement workshop as a stand for a grinder or drill press. Determine the size of the stand your tool requires, and glue a stack of 2x4s together. Now, lay out and cut a hole the diameter of the post, less 1/16" toward the rear of the table. Rip the lamination through the hole. Then "clamp" the two parts of the table around the posts with 6" lag screws.

—Gary Paine, Davison, Mich.

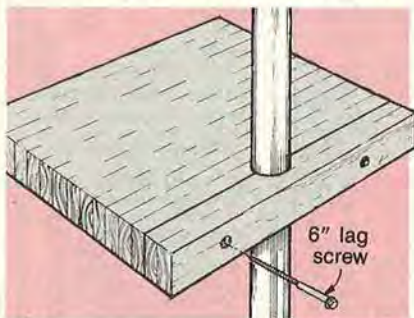

Shock treatment for power cords

When power-cord connectors are subjected to rain, the possibility of electrical shock increases.

TIP: An empty plastic milk jug can protect cord ends from moisture. Cut a hole in the bottom of the jug and enlarge the top if necessary to allow the male and female ends to pass through. Pull one cord entirely through the jug, connect, and suspend the connection in the middle of the jug.

—From the WOOD Shop

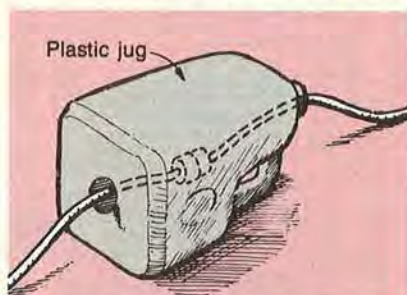

Continued on page 19

START YOUR OWN
PROFITABLE CASH BUSINESS
EVEN WHILE LEARNING!

BE YOUR OWN BOSS... BE A LOCKSMITH

There is a difference
in locksmithing
training and
the difference
is NRI

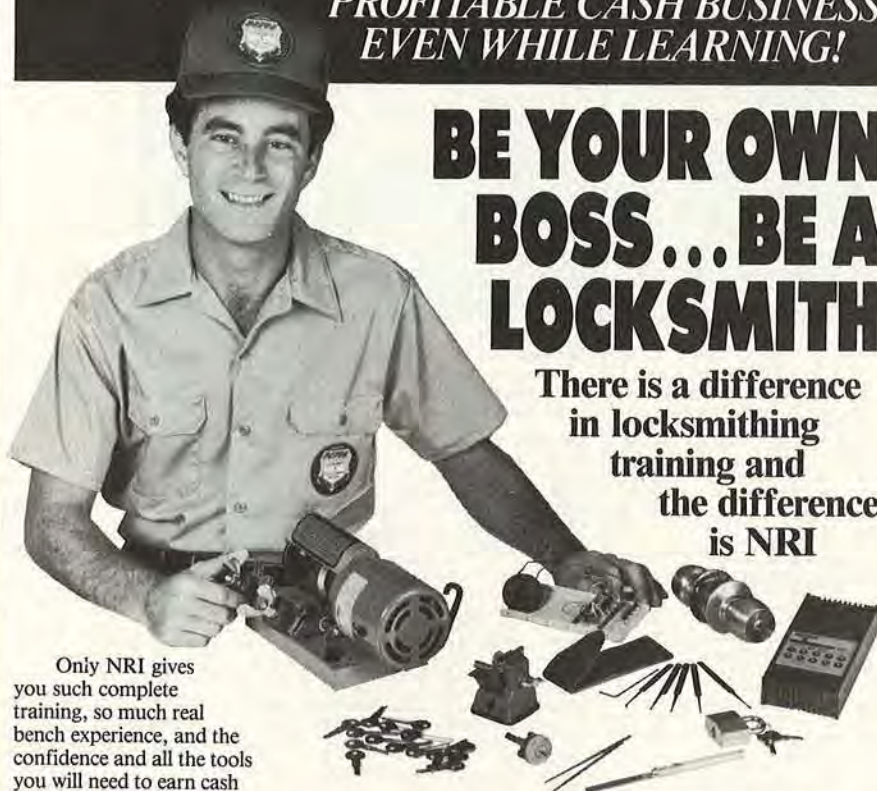

Only NRI gives you such complete training, so much real bench experience, and the confidence and all the tools you will need to earn cash money fast.

A well-trained locksmith earns money in many different ways—installing locks in apartments, homes, businesses, and automobiles, fixing broken locks, cutting new keys, and more. And this huge market is just begging for new qualified locksmiths. Today there is only one locksmith for every 18,000 people!

The Newest, Most Advanced Course of Its Kind

Thorough step-by-step lessons and professional locksmithing equipment such as the Taylor KD5 Key Machine give you hands-on experience in this exciting growth field. You'll start earning huge cash profits of 800% to 900% duplicating keys. And only NRI offers you an Electronic Security Alarm training system.

Compare! NRI offers the only course that is nationally approved by the accrediting commission of the National Home Study Council.

Compare! NRI's course training has been broken down into 10 learning modules, each with the right number of lessons to keep you

training at an easy-to-follow pace. All the lessons, hands-on training, and experiments have been developed to ensure that you begin practicing from the very first day... and can begin making cash as soon as you like. All the money-making secrets of a locksmithing trade will become yours with your NRI training.

Plus, only NRI gives you training in both locksmithing and electronics security systems in one complete course.

Start Your Own Business, Full or Part-Time, Even From Your Home

Add to your income with part-time work with established locksmiths... start your own part-time or retirement business in your own home... make locksmithing and security a full-time career as a skilled technician in your own growing business. There is opportunity everywhere!

NRI's free 4-color booklet will show you how quickly you can train to be your own boss in a profitable locksmithing business and gain the respect you deserve as a trained technician like other professionals in your community.

SEND FOR FULL INFORMATION BOOKLET TODAY! COMPARE.
THERE'S NO OBLIGATION AND NO SALESMAN WILL CALL!

NRI SCHOOLS
McGraw-Hill Continuing Education Center
3939 Wisconsin Avenue, Washington, DC 20016

We'll give you tomorrow.

- | | | |
|--|---|---|
| <input checked="" type="checkbox"/> CHECK ONE FREE CATALOG ONLY | <input type="checkbox"/> Digital Electronics | <input type="checkbox"/> Appliance Servicing |
| <input type="checkbox"/> Locksmithing & Electronic Security | <input type="checkbox"/> Communications Electronics | <input type="checkbox"/> Automotive Servicing |
| <input type="checkbox"/> Data Communications | <input type="checkbox"/> Industrial Electronics | <input type="checkbox"/> Air Conditioning, Heating, Refrigeration, & Solar Technology |
| <input type="checkbox"/> Robotics & Industrial Controls | <input type="checkbox"/> Basic Electronics | <input type="checkbox"/> Building Construction |
| <input type="checkbox"/> Color TV, Audio, and Video System Servicing | <input type="checkbox"/> Telephone Servicing | <input type="checkbox"/> Computer Electronics with Microcomputers |
| <input type="checkbox"/> Electronics Design Technology | <input type="checkbox"/> Small Engine Servicing | |

For Career courses approved under GI bill
 check for details.

Name (Please Print) _____

Age _____

Street _____

City/State/Zip _____

Accredited by the National Home Study Council

1726-036

RYOBI TOOLS		List Sale
S500A	3x5 1/2 Finish Sander	70 41
SUB200	Finishing Sand. 1/2 Sheet	142 88
87105	3x21" dustless Belt Sand.	179 116
87100	3x24" dustless Belt Sand.	208 140
B7200A	4x24" dustless Belt Sand.	269 185
D100V9	3/8" VSR 0-1200 rpm drill	91 49
W640	7/8" 13 amp circular saw	158 99
W740	8 1/4" 13 amp circular saw	171 109
JS60	Jig Saw-Single Speed	172 99
JS60E	Jig Saw-electronic speed	198 123
R150	1 H.P. Plunge Router	138 86
R330	2 H.P. Router	220 138
R500	3 H.P. Router	265 163
E3800	DrYWall screwdriver 0-4000 rpm	126 79
L1200	3 5/8" Planer	142 89
BD1020R	3/8" 2-sp Cordless Drill w/ free holster-Xtra special buy	148 95
TS251U	10" Mitre Box	300 169
SG1150C	4 1/2" H.D. Mini-Grinder	99 59

YOUR ATTENTION PLEASE!
All Above RYOBI TOOL Prices
Take Additional 10% Off Sale Prices

MILWAUKEE TOOLS		List Sale
0224-1	3/8" drill 4.5A magnum	159 109
0234-1	1/2" drill 4.5A magnum	159 115
0244-1	1/2" drill 4.5A magnum	159 115
0222-1	3/8" drill 3.3A 0-1000 rpm	146 99
0228-1	3/8" drill 3.3A 0-1000 rpm	129 95
0375-1	3/8" close quarter drill	175 118
0210-1	3/8" cordless drill	154 114
6539-1	cordless screwdriver	84 64
1007-1	1/2" drill 4.5A D-Hdle	204 145
1107-1	3/4" drill 4.5A D-Hdle	249 170
3300-1	magnum rt angle drive kit	263 180
3102-1	Pimbrs rt angle drill kit	233 155
1676-1	HD Hble Hawg w/ice 2 sp	303 205
5395	3/8" sgle sp hammer drill	233 155
5397	3/8" var sp hammer drill	208 155
5371-1	HD mag. hammer drill 1/2"	287 207
5373	HD mag. ham. drill 3/8"	240 175
6511	2 speed Sawzall w/ice	181 123
6226	port band saw 2 sp w/ice	382 280
6234	TSC band saw port w/ice	382 280
6365	7/8" circ. saw 13 amp	159 109
6405	8 1/4" circ. saw 13 amp	179 127
6460	10 1/4" 15 amp w/ice	349 245
6377	7 1/4" HD worm saw 13 amp	235 155
6376	8 1/4" HD worm saw 13 amp	249 185
6165	12" Chop Saw 15 amp	287 189
6170	14" Chop Saw 15 amp	289 209
6255	vsp Jig Saw 3.8 amp	189 140
6245	sgle sp Jig Saw 3.8 amp	175 125
6012	1/2" sheet HD Orb. sander	169 110
6014	1/2" sheet HD Orb. sander	169 115
5935	4" by 24" belt sander	191 215
5860	1 1/2" HP router 10 amp	256 175
5880	2 HP router 12 amp	314 220
8950	Wet/Dry 8 gal vac 6 amp	145 110

BENCH GRINDERS		List Sale
4901	1/4 HP 2.6 amp 24"	159 110
4921	1/2 HP 4 amp 26"	179 130
4891	1/2 HP 4 amp 41"	279 195
5041	3/4 HP 8.2 amp 58"	379 270

DRYWALL SHOOTERS		List Sale
6753-1	3.5 amp 0-4000 rpm new	115 79
6747-1	4.5 amp 2500 rpm	144 100
6750-1	4.5 amp 0-4000 rpm	129 90

MILWAUKEE Super Specials!
Model 6507 Trigger Speed Control Sawzall
Go Cordless with MILWAUKEE
#6305 - 6 1/2" Cordless Circular Saw
12 volt - 1 Hour Charge
Cuts (80) 2x4's (Pine)
List Price 195.00 * SALE PRICE 135.00

FREUD SAW BLADES		List Sale
Univ. Bore - Professional Series	CARBIDE TIPPED SAWBLADES	
Item No.	Description	Diam. Teeth List Sale
PS203	Gen'l Purp.	7 1/4" 24 27.24 17.50
PS303	fine cutting	7 1/4" 40 32.97 20.50

5/8" Bore - Industrial Grade		List Sale
Item No.	Description	Diam. Teeth List Sale
LU72M010	Gen'l Purp.	10" 40 68.58 34
LU81M010	Gen'l Purp.	10" 40 69.30 35
LU73M010	Cut Off	10" 60 79.65 36
LU82M010	Cut Off	10" 60 86.40 44
LU84M010	Combination	10" 40 70.99 36
LU84M011	Combination	10" 50 74.51 37
LU85M010	Super Cut Off	10" 80 110.88 62
DS 306	8" Dado	139.00 92
DS 308	8" Dado	170.00 105
TR 100	3 blades & Dado set	399.00 255

FORSTNER BITS (ARCO)		West Germany
Model	Size	List Sale
2121	1/4	6.40 4.00
2122	3/8	7.00 4.50
2123	1/2	7.80 5.00
2124	5/8	10.35 6.50
2125	3/4	10.95 7.00
2126	7/8	11.40 7.25
2127	1	12.25 7.75
2128	1-1/8	12.75 8.00
2129	1-1/4	13.65 8.75
2130	1-3/8	16.45 10.50
2131	1-1/2	18.15 11.50
2132	1-5/8	21.25 14.50
2133	1-3/4	23.95 16.50
2134	1-7/8	25.50 17.50
2135	2	26.25 18.50
2136	2-1/8	30.50 20.50

16 Pieces (one of every size of above)
List Price 254.80 * SALE PRICE 150.00
4 Pieces (1/2 - 5/8 - 3/4 - 1")
List Price 38.95 * SALE PRICE 25.00

MAKITA TOOLS		List Sale
B04510	Sander	79 43
9800B	3" x 21" belt sander	198 119
9824B	3" x 24" belt sander	188 135
9824DB	3" x 24" belt sander w/bag	214 130
9035	1/2 sheet finish sander	79 48
9045B	1/2 sheet finish sander	156 90
9045N	1/2 sheet finish sander	158 105
4200N	4-3/8 circ. saw 7.5 amp	152 95
5008NB	8 1/4 circ. saw 13 amp	179 105
5201NA	10 1/4 circ. saw 12 amp	348 215
4300VB	vsp Jlg saw 3.5 amp	192 120
4301VB	orb vsp Jlg saw 3.5 amp	208 125
2401BW	10" mitre saw	329 185
2400WB	10" mitre saw (for vice)	369 249
JR3300WL	2 sp recip saw w/ice	188 120
JR3000V	vs recip saw w/ice	178 120
6010DWK	3/8 cordless drill w/ice	152 89
5081DV	3-3/8 cordless saw kit	165 100
1900WB	3 1/4" planer w/ice	154 92
1100HD	3 1/4" planer w/ice	278 160
3608BK	1/2 hp router w/ice	132 85
3601B	1-3/8 hp router	168 115
3700B	1/2 hp trimmer	124 82
B04530	6" Round Sander	84 55
6710DW	Cordless Screwdriver	148 105
DA3000	3/8" angle drill	158 105
DP4700	5/8" vsp w/rev 4.8 amp	154 92
HP1030W	3/8 v.s.r. hammer drill w/ice	145 90
6300LR	1/2" angle drill w/rev	229 152
84188B-2W	1/2" 2 sp. hammer drill w/ice	238 150
GV5000	Disc Sander	79 53
6900DW	2500 rpm 3.5 amp	123 79
6800DRV	0-2500 rpm 3.5 amp	133 89
6801DB	4000 rpm 3.5 amp	123 79
6801DBV	0-4000 rpm 3.5 amp	133 89
2030N	12" planer/jointer	1980 1350
2040	15-5/8" planer	1780 1195
1805B	6-1/8" planer kit w/ice	418 265
LS1400	14" Mitre Box	578 410

NEW from MAKITA!
Model List Sale
9822-2 Blade Sharpener 235 160
6802DWK 3/8" 2-sp cless drill kit 154 94
6010SDW 3/8" cordless drill rev 82 46
DA3000DW 3/8" cless angle drill 172 105
JV1600 var. speed Jlg saw 145 89
JV2000 var. speed orb. Jlg saw 165 100
4300DW cordless Jlg saw 158 102
5005BA 5 1/2" circular saw 154 98
5000DW 8 amp. with brake 224 139
9207SPC 7" var/speed electronic sander/polisher 209 130
9303BH 4 1/2" sander-grinder kit 146 95
9035DW cless finishing sander 128 79
4014NV var/speed blower 128 79

DELTA		List Sale
34-621	9" contr. saw w/o motor	500 395
34-410	10" contr. saw w/o motor	871 650
34-710	super 10" motorized saw	579 450
15-091	15" floor model Dipress	467 375
15-090	15" bench model	467 375
37-207	Saw/Jointer Combination	1018 810
37-609	8" Motorized Jointer	413 335
37-290	4" delta Joiner w/o motor	346 275
22-851	RC-33 - 13" Planer	1943 1450
43-122	Wood Shaper w/stand and 1 HP Motor	869 495
46-140	11" lathe, gap bed model w/stand w/o motor	407 335
52-493	1 hp motor for #34-621	170 130
62-042	1 1/2 hp motor for #34-410	230 170
62-144	1/2 hp motor for #37-290	138 105
62-142	1/2 hp motor for #28-243 and #46-140	121 85

TOOLS ON SALE
AMERICA'S LOWEST PRICED TOOLS
* PLUS * ... FREE ... Freight On Every Item

1985 TOOL CATALOG AVAILABLE
Call Toll-Free 1-800-328-0457 - In Minnesota Call (612) 224-4859
4 WAYS TO BUY: CHECK - MONEY ORDER - VISA - MASTERCARD
SEVEN CORNERS ACE HDW. INC.
216 West 7th St. • St. Paul, MN 55102 • Est. 1933

SAW-A-THON by PORTER CABLE
#314 1/4" trim saw
List 180... SALE 109
#348-1 8 1/4" top hdl
List 181... SALE 100
#617 7/4" Push Hdl
List 186... SALE 103
#687 7/4" Speedtronic
List 189... SALE 125
#315-1 7 1/4" Top Hdl
List 186... SALE 103
#388-1 8 1/4" Top Hdl
List 176... SALE 110

DELTA SUPER SPECIALS!
#33-150 SAWBUCK
List 658... SALE 499
#28-560 BANDSAW
3 wheel
List 449... SALE 349
#28-283 14" Band Saw
with enclosed Stand
and 3/4 hp Motor
List... \$897.00
Sale... \$675.00
#28-243 14" Band Saw
with Open Stand
without Motor
List... \$594.00
Sale... \$440.00
#22-951 13" Planer
List... \$1943.00
Sale... \$1295.00

DELTA
34-010 Motorized Mitre Box 231 149
* NEW LOW PRICES *
PONY CLAMP FIXTURES
Model List Sale of 12
#50 for 1/4" Black Pipe 11.23 7.40 80.00
#52 for 1/2" Black Pipe 9.36 6.10 67.50

JORGENSEN HAND SCREWS
Model Jaw Length Open Cap. List Sale of 8
#50 4" 2" 11.59 7.25 39.15
#40 5" 2 1/2" 12.45 8.10 43.75
#30 6" 3" 13.35 8.50 45.95
#20 7" 3 1/2" 14.35 8.95 48.35
#10 8" 4 1/2" 15.97 9.95 53.75
#1 10" 6" 18.25 11.35 61.25
#2 12" 8 1/2" 20.94 13.50 72.85
#3 14" 10" 28.58 16.75 81.35
#4 16" 12" 34.55 23.75 128.25

JORGENSEN BAR CLAMPS
STYLE 37 - 2 1/2" Throat 1/4" x 3/4"
Model Jaw Length List Sale Lots of 8
#3708 8" 7.88 5.50 29.70
#3712 12" 8.73 5.95 32.13
#3718 18" 9.84 6.95 37.53
#3724 24" 10.54 7.25 39.89
#3730 30" 11.78 8.25 44.55
#3736 36" 12.85 8.95 48.33

SUPER CORDLESS SPECIALS
from BLACK & DECKER
Model DRILL KITS List Sale
1930 3/8" rev/hl speed 165 110
1950 3/8" High Torque 165 110
5930 Reversible Hammer 179 120
1970 3/8" rev/hl torque screwdriver 179 120
1980 Rev adj. clutch ScruDrill 179 120

BRAND NEW! SUPER SPECIALS
from MILWAUKEE
0214-1 3/8" cless driver/drill 154 109
8975 H.D. Heat Gun, 11.6A Low 570°F - High 1000°F 69 49
5920 belt sander 3x24 w/o bag 289 199
5925 belt sander 3x24 w/bag 309 215
5930 belt sander 4x24 w/o bag 299 209
5935 belt sander 4x24 w/bag 319 225

BRAND NEW! BLACK & DECKER
#9425 8 1/4" Compound Mitre Saw
Special Sale Price - \$115.00

PORTER-CABLE (buy of the year)
Model 621 REVERSING DRILL
3/8" H.D. var/speed-4 amp 0-1000 rpm
List 120... SALE 72
6 or more \$69.00 each

*** X-TRA SPECIALS ***
MAKITA TOOLS List Sale
6010DL Cless Drill w/flashlight charger & w/ice 162 90
DP3720 3/8" drill Rev. 0-1800 rpm 90 47
6510LVR 3/8" drill Rev. 0-1050 rpm 116 67
6013BR 1/2" Drill Rev. 8 amp. 174 105
5402A 16" Circular Saw-12 amp 468 310
2414 14" Cut Off Saw-13 amp 292 169
3612BR 3 HP Plunge Router 286 175
9401 4x24 belt sander w/bag 248 160

PORTER-CABLE List Sale
696 H.D. Shaper Table 150 105
695 H.D. 1 1/2 hp Router/Shaper 278 190
399 Drywall Cut-Out Unit 100 70
736 V/Speed Speedtronic Band Saw 450 330
7584 1 1/2" X.H.D. Drill 8 amp 205 145

BOSCH TOOLS List Sale
1581VS Top Handle Jlg Saw 225 120
1582VS Barrel Grip Jlg Saw 128 118
1604 1 1/4" H.P. Router 198 110
1942 Heat Gun 650° - 900° 99 65
1272 3x24" Belt Sander 259 159
1272D 3x24" Belt Sander w/bag 274 169
1273 4x24" Belt Sander 274 169
1273D 4x24" belt sander w/bag 289 179

DELTA List Sale
34-010 Motorized Mitre Box 231 149
* NEW LOW PRICES *
PONY CLAMP FIXTURES
Model List Sale of 12
#50 for 1/4" Black Pipe 11.23 7.40 80.00
#52 for 1/2" Black Pipe 9.36 6.10 67.50

JORGENSEN HAND SCREWS
Model Jaw Length Open Cap. List Sale of 8
#50 4" 2" 11.59 7.25 39.15
#40 5" 2 1/2" 12.45 8.10 43.75
#30 6" 3" 13.35 8.50 45.95
#20 7" 3 1/2" 14.35 8.95 48.35
#10 8" 4 1/2" 15.97 9.95 53.75
#1 10" 6" 18.25 11.35 61.25
#2 12" 8 1/2" 20.94 13.50 72.85
#3 14" 10" 28.58 16.75 81.35
#4 16" 12" 34.55 23.75 128.25

Who Has The Saws That Cut It Across The Board?

BLACK & DECKER of course!!!
Model WORM DRIVE SAWS List Sale
3050 6 1/2" 12 amp - 4600 rpm. 247 169
3051 7 1/4" 13 amp - 4300 rpm. 232 149
3052 8 1/4" 13 amp - 4300 rpm. 247 169

SUPER SAWCATS
3047-09 7 1/2" w/brake - 12.5 amp. 226 149
3048-09 8 1/4" w/brake - 13 amp. 240 155
BUILDERS SAW CAT
3030 7 1/4" 13 amp - 5800 rpm. 155 100
3035 8 1/4" 13 amp - 5800 rpm. 175 125
3034 7 1/4" 13 amp - 5800 rpm. 162 115
3033 6 1/2" 13 amp - 5800 rpm. 162 115

JIG SAWS
3157-10 var/sp orb action d/hdle 174 115
3153-10 var/sp speed 4.5A 0-3100 158 105
3159-10 2sp orb action barrel grip 178 120
CUT SAW KITS
3103 2 sp 6 amp 2400 strokes 163 100
3105 V/Sp 6 amp 2300 strokes 170 110
3107 V/Sp orb 6A 0-2300 strokes 183 119
4300 Drill Bit Sharpener 299 205
1321 1/2" drill 450 rpm 6 amp 175 115
4010 Palm Sander 160 105
4015 1/2" Sheet Finish Sander 160 105

DRYWALL GUNS
2034 v.s.r. 0-4000 rpm 121 79
2037 v.s.r. 0-4000 rpm 139 89

"Door Openers" from MAKITA
9501B 4" Grinder Kit 119 55
6012HDW Cordless Drill w/Battery & Case 178 98
5007NB 7 1/4" Circ. Saw 158 94

MAKITA
Model 2708 - 8" Table Saw
List Sale
8" Table Saw \$336.00 \$199.95
Holder Set 28.00 23.95
Carbide Blade 19.00

TIPS FROM YOUR SHOP AND OURS

Continued from page 17

Chip-free dadoing on the table saw

It's all too easy to chip the thin veneers covering plywoods when you use dado blades and a dado-blade insert on your table saw.

TIP: Make your own insert that will undergrid the plywood (or any wood, for that matter) with support and reduce chipping. With a scroll saw, band saw, or jigsaw, cut out an insert blank from the correct thickness of plywood or solid stock. After you've mounted the blades, install and secure the blank. Then raise the blades to the proper cutting height. Now you will be cutting with maximum support.

—Arnold J. Schafer,
Yakima, Wash.

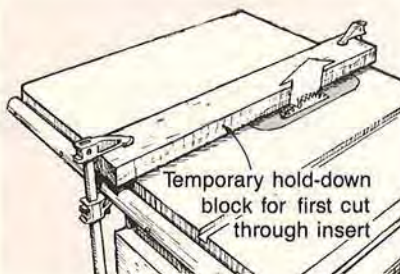

Take the slip out of slick glue
When you apply pressure to boards or sheet goods that you're trying to surface-laminate, the stack wants to slide around.

TIP: To prevent this from happening, drive wire brads into the material before applying the glue. Snip off the brad head at a sharp diagonal. Now apply glue and, after aligning the boards, tap them together with a mallet.

—C.P. Squires,
Warrensville, N.C.

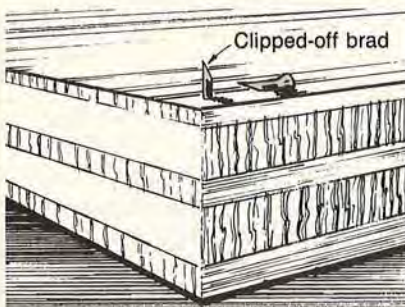

Be Your Own Boss and Make

\$18.00 to \$30.00 AN HOUR!



Your FREE Lifetime Security Fact Kit tells you how to make \$18.00 to \$30.00 an hour in your own Foley-Belsaw Full-Service Saw and Tool Sharpening Business. Your FREE Fact Kit explains how you can:

- be your own BOSS!
- work full time or part time, right at home.
- do work you enjoy and take pride in.
- operate a CASH business where 90¢ of every dollar you take in is clear CASH profit.

And it is so easy to learn. Foley-Belsaw gives you all the facts and instructions. No experience or special training is necessary. Foley-Belsaw tells you everything you need to know to be successful.

And there's plenty of business available in your area. You will be able to sharpen all types of saws, garden and shop tools for home, farm and industry.

You will be able to set your own hours and not have to worry about layoffs and strikes. And there are no franchise fees. Any age person can succeed.

But you've got to get the FACTS before you can get started. So write NOW for your FREE Lifetime Security Fact Kit. It's yours to keep with NO OBLIGATION.

... send NOW for your FREE Lifetime Security Fact Kit!



FREE
LIFETIME
SECURITY
FACT KIT



The Foley-Belsaw Co.
20211 Field Bldg.
Kansas City, MO 64111

YES, I want to know more!
Please rush my FREE Lifetime Security Fact Kit.

Name _____
Address _____
City _____ State _____ Zip _____
(Area Code) Phone _____

MOLD, PLANE & EDGE

... in Your Shop or On the Job!

Attention: Renovators, Hobbyists & Carpentry Professionals: Now you can save up to \$145.00 on any new W-7 Series Molder/Planer System from Williams & Hussey—just by sending for our FREE information kit!

The portable, American-made W-7 Series is one of the safest, most versatile, most economical lines of combined-function woodworking machines you can own—in your shop or out on the job!

Save on America's Most Versatile Molder/Planers!

Now \$145 OFF!

Molds, Planes and Edges!

America's most versatile shop tool turns useless scrap into smooth, saleable items every craftsman can be proud of:

Picture Frames • Crown Moldings • Raised Panels Boat Decks • Casings Sashes • Rails



Cuts Any Molding, Planes Any Hardwood

Duplicates thousands of moldings from 7" wide to 3/4" deep... planes 15 feet per minute (even rock maple!) ...edges any width of board, thanks to the open-sided design.

Super-Fast Changeover

Your W-7 converts from Molder to Planer in less than two minutes. No gauges or special tools needed! The safety recessed blades bolt on or off in seconds—no arbor changes required!

Three W-7 Models

For power infeed/outfeed, power in-feed only, or manual operation—all at 15 feet per minute and even faster using multiple cavity blades!

5-YEAR WARRANTY

100% American Made • Weighs Only 85 lbs. • Cast-Iron Base & Head • Chrome Steel Posts Serrated Steel Roller • 2-Minute Changeover

BUILT TO GO THE DISTANCE.

Save up to \$145! Limited time only. Write or Call for FREE Information Kit!

1-800-258-1380
In NH 603-673-3446

Please rush specs on the W-7 Series Molder/Planers.

Name _____
Street _____
City _____ State _____ Zip _____

JOINT-MATIC

Revolutionary
Performance

Exceptional
Capabilities

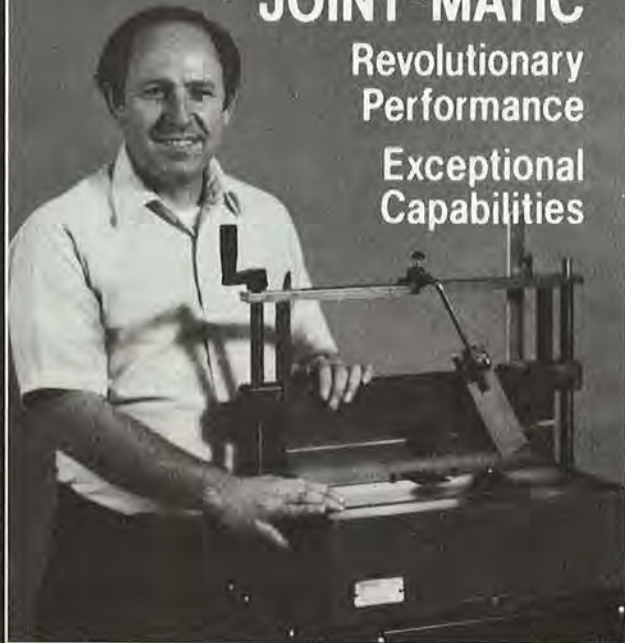

... The Joint-Matic 4200 is a new system in joinery that offers operating convenience, efficiency and accuracy that can not be compared to anything on the market. The Joint-Matic will help you produce woodworking pieces of elegance, precision and beauty more quickly and expertly than you ever thought possible. Now, in minutes make ... Mortise, Tenon, Sliding and Through Dovetail, Box Finger Joint and much much more. Exclusive features of the Joint-Matic are so advanced in design and simplicity that set up time has been all but eliminated.

Features:

- Built for ruggedness and rigidity the table and slide unit have extra deep ribbing allowing a more accurate and chatter free cut.
- The base is heavy ribbed 1/2 inch thick casting, hardcoat anodized aluminum to a 52 Rockwell.
- The adjustment screws are rolled thread with a thread pitch of 3/4-16.
- Accuracy can be achieved to as close as .001th of an inch.
- Comes equipped with a 1-3/4 H.P. router.

For Your Brochure Please Send \$2.00 to:

Strong TOOL DESIGN

20425 Beatrice
Dept. W
Livonia, MI. 48152

Joint-Matic Machine Is Protected By U.S. Patent 4,163,465

ASSOCIATIONS YOU SHOULD KNOW ABOUT

 Print this article

AMERICAN FORESTRY ASSOCIATION



The American Forestry Association's reason for existence goes to the very root of every woodworker's pleasure and endeavor: our forest trees. The 40,000 members have essentially one common bond: Each is a tree lover in a group known as "the tree people."

Education and travel opportunities

AFA membership puts you in touch with an unequalled educational resource about the woods you use in your craft. The 111-year-old citizens' association offers members a 20 percent discount on books, such as *Know Your Trees*, a definitive work on woods. In AFA's monthly, four-color, 64-page magazine, *American Forests*, you'll read about forestry and trees from backyards to the wilderness.

On the fun side, AFA invites you to help find a national champion in its National Register of Big Trees, a list of the largest trees in about 680 native species. The Association also offers group tours of natural monuments, wildernesses, and backcountry.

A voice in the wilderness: Speaking out on the issues

You could join AFA for the educational resources or just the fun. The real bond that ties together members, though, is an urgent belief that each of us has a responsibility to protect and intelligently use our forests and related resources. AFA membership gives you a voice in the future of our forestlands. Through AFA, you can make a difference on problems such as acid rain, endangered animal habitats, deforestation, soil erosion, or domestic lumber pricing.

"AFA has a reputation of not being biased because we go out of our way to present several sides to a question," explains Rita Malone, membership director. "Because of this, our testimony is highly valued on Capitol Hill."

With AFA, you can be an active part of the solution. Get your hands in the soil through national programs that are tailored to your area—such as planting trees in cities or improving public lands.

Annual membership dues are \$24. Sign up in 1986 and AFA will send you a blue spruce seedling (from a nursery in your area at planting time).

For more information and a membership application, write: Rita Malone, Director of Communications and Membership, The American Forestry Association, Dept. W, 1319 18th St., NW, Washington, DC 20036. 🌲

BAND SAW BLADE SPECIALISTS

We think that when it comes to Bandsaw Blades we are **THE BEST**

Band saw blades cut and welded to your exact specifications

WIDTH	TEETH	PRICE/INCH
1/8" thru 3/4"	3 thru 32	\$.05

Price=inch length x price per inch+1.75 weld charge

NO MINIMUM ORDER

Add \$2.50 for shipping & handling
Speedy Delivery

Send payment with order - write or call

ROBERTS HARDWARE
P.O. Box 1276 • Taylors, SC 29687
803/879-2470

Distinguish Your Fine Workmanship
With Your Own, Personal

BRANDING IRON

For Hard and Soft Wood

Available with your:

- ★ Initials
- ★ Name—w/wo Address
- ★ Logo
- ★ Choice of Wording

Changeable date available for most units
Call or write for free brochure

NOVA TOOL CO.

4533 Colfax Circle, Dept. BH
P.O. Box 29341, Lincoln, NE 68529
(402) 464-0511



GUARANTEED

National Carvers Museum



LEARN WOODCARVING AT HOME

Receive sample instructional pack on whittling and woodcarving. Includes copy of *Mallet* monthly magazine.

Send \$1.00 to The National Carvers Museum, 14960 Woodcarver Rd., Monument, CO 80132.



A FRESH APPROACH TO AN OLD TIME FAVORITE

SIMPLIFIED FRAMING

8 feet X 8 feet

584 GAZEBO with CUPOLA

theWORKSHOP
BLUEPRINT COMPANY
P.O. Box 65725
West Des Moines, Iowa
50265

PLAN #584 \$19.95
POSTAGE & HANDLING... \$ 1.50
TOTAL \$
Iowa Res. Add Sales Tax

WOOD TOY

- ★ Patterns
- ★ Parts
- ★ Wheels
- ★ Many New Patterns to Choose from.
- ★ Executive toys



SEND \$1.00 FOR NEW CATALOG & RECEIVE COUPON FOR FREE WHEELS & AXLE PEGS.

toys and joys

Box 628W Lynden, Wash. 98264

FINE FINISH WOOD ENNOBLER

THREE SIMPLE STEPS TO PROFESSIONAL PERFECTION

- Prepare wood surface. Wipe on penetrating Sealacell® to repel moisture.
- After 12 hours wipe on Varnowax® to enhance the coloring and beauty of the wood.
- After 12 hours wipe on Royal Finish® for a satin smooth, stain resistant surface.



Write for FREE guide to wood finishing.

GENERAL FINISHES

P.O. Box 14363B • Milwaukee, WI 53214
414 774 1050

SEALACELL 1-2-3

The wipe-on finish that's been making craftsmen proud since 1928.

DUBUQUE CLAMP WORKS.



827 Garfield
Dubuque, Iowa 52001

8" Kit ~ 6.95 / 10" Kit ~ 7.95
12" Kit ~ 8.95 / 14" Kit ~ 9.95

PARTS FURNISHED

- 2-Heavy Steel ferrules with spiral pins...
- 2-7/16 ACME, double lead, threaded rods...
- 4-5/8 Pivot nuts...
- Complete Instructions.

Also available — 2 Wood handles. — \$1.00

Send Check or Money Order
Visa or Master Card accepted.
WE PAY FREIGHT!



Van Dyke's

Presents a Catalog

with supplies for upholstery, antique restoration, wood working, caning, brass hardware, carvings and many related trades!

36 Years in Creative Arts & Trades

Many Hard-To-Find Items!

SEND \$1.00 FOR CATALOG TO:
Van Dyke's Restorers
Dept. D55 - Woonsocket, SD 57385



PRECISION MOVEMENTS

(215) 967-3156

QUARTZ MOVEMENT "Six-Pack" ONLY \$21.00

SAVE OVER 30%

- Solid Brass Shaft
 - On-Off Switch
 - Accurate to Within 15 sec./month
 - 5 YEAR GUARANTEE
 - 4 Sizes Available
3/8" 9/16" 3/4" 7/8"
- Sizes May Not Be Assorted

EACH QUARTZ "Six-Pack" INCLUDES:

- 6 QC Quartz Movements
- 6 Pairs of 2 1/2" Contemporary Brass Hands
- 6 Pairs of 3" Traditional Brass Hands
- 6 Brass Second Hands
- 6 Sets of Hangers and Hardware

PA. Residents Please Add 6% Sales Tax + \$2.50 Shipping and Handling Each.

P.O. Box 689 DEPT. G • EMMAUS, PA 18049



RECANE for fun and profit

Recane or re-rush heirloom chairs — for yourself or for others as a profitable hobby — with our full line of materials & instruction books.

Since 1934 America's largest selection of caning & basketry materials & supplies —

- Superior quality weaving cane & machine woven cane
- Flat oval & round reeds
- Fibre & genuine rush
- Danish sett cord
- Raffia, rattan, seagrass
- Hoops & handles

Illustrated catalog with complete how-to-do-it information, prices, order form: \$1 (refundable with 1st order)

CANE & BASKET SUPPLY CO.

1283 S. Cochran, Dept. W, Los Angeles, CA 90019

A Complete New Combination Kit for Whittling and Carving By WARREN TOOL CO., INC.

BASIC WOODCARVING



In Ten Lessons

Basic Woodcarving lesson book, prepared by the National Carvers Museum, teaches and illustrates proper carving techniques through clear instructions and simple projects.

COMBI-TCE \$79.95 + \$2.25 p&h
OUR FINEST COMBINATION WHITTLERS AND CARVERS KIT
Contents: 1 Redwood Box, 1-# CWH-R Rosewood handle, 1 #L-Palm Walnut handle, (one each) #PTV-1, #L.B.G., #S.B.G., #PTV-2, #STC, #STG, #SFTG, #SKU, Gouges, 1-#LD2 (Large Blade), #6SBL (6-Small Blades), 1-Leather Strop Block, 1-Abrasive Paper Block, 1-Instruction Booklet. All blades and gouges sold in their own plastic storage tubes to avoid damage to these honed ready-to-use tools.

WARREN TOOL CO, INC.

Rt 1, Box 14A-W, Rhinebeck, NY 12572

Catalog 60¢ FREE with order • (914) 876-7817

N.Y. residents add 5.25% sales tax • Foreign shipping: "all foreign orders (including Canada) send MO in US funds plus additional \$1.75 for P&H.

WOOD REPAIR

Durham's Rock Hard Water Putty makes lasting repairs in wood. Won't shrink or fall out. Sets quickly, holds tight and can easily be painted. Economical, easy to use. Available at lumber, paint and hardware stores.



DONALD DURHAM COMPANY

Box 804-W Des Moines, IA 50304

WOODWORKS

SHAKER PEGS



	Qty.	Total
3-1/2" Maple Shaker Pegs	\$20.00/100	
1-3/4" Mini Shaker Pegs	7.00/100	
3-3/8" Kitchen Mug Pegs	20.00/100	
2-7/16" Tie Rack Pegs (NEW)	7.00/100	
Bean Pot Candle Cup	17.00/100	
Brass Pltd Candle Cup Insert	3.00/25	

LOW PRICES



Maple Toy Wheels with 1/4 holes		
1 x 3/8 Maple Toy Wheels	\$6.50/100	
1-1/4 x 7/16	8.50/100	
1-1/2 x 1/2	10.00/100	
1-3/4 x 9/16	14.00/100	
2 x 5/8	17.50/100	
Axle Pegs For Above		
Pickle Barrel-Toy Cargo	1.90/6	
Little Man	1.60/7	
Smokestacks 2-3/4" Tall	4.80/12	

HIGH QUALITY

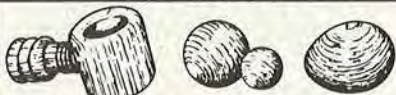

3/4" Full Round Balls	\$8.00/100	
1" Full Round Balls	10.00/100	
Grade A Large Hen Eggs	35.00/100	
Nutcracker - White Birch	3.00/Each	

FAST SERVICE



3/8" Maple Buttons	\$2.15/100	
1/2" Maple Buttons	2.25/100	
3/8" x 2" Dowel Pins	2.20/100	
1-1/2" Maple Spindles	9.00/100	
1-1/2" Oak Spindles	12.00/100	
Clockmaker's Finial	1.50/Each	

LARGE SELECTION



1/4" x 36" Birch Dowels	\$4.25/25	
3/8" x 36" Birch Dowels	6.50/25	
1/2" x 36" Birch Dowels	10.50/25	
3/8" x 36" Oak Dowels	5.50/10	
1/2" x 36" Oak Dowels	8.00/10	
3/4" x 36" Oak Dowels	15.00/10	

MONEY BACK GUARANTEE



CHECK THIS BOX, AND AS A BONUS WITH ANY ORDER FOR WOOD PARTS, WE WILL SEND YOU A COMPLIMENTARY 8 OZ. BOTTLE OF FRANKLIN TITEBOND WOOD GLUE.
 CHECK HERE

\$2.25 VALUE #B3



ORDER NOW

TOTAL FOR GOODS

TEXAS ONLY
 ADD 5% SALES TAX
 HANDLING AND
 INSURANCE

\$3.00

FINAL TOTAL

MC OR VISA CHECK ENCLOSED

ACCOUNT # _____

EXPIRES _____ PHONE _____

NAME _____

SHIP TO _____

CITY/STATE/ZIP _____



817/281-4447

WOODWORKS

4013-A CLAY AVE. • FT. WORTH, TX 76116



Our resident woodworking pro, Jim Boelling, shares tips, commonsense advice, and 20 years of shop know-how.

SHOP FOR PARTS, NOT BOARD FEET



In the woodworking classes I've taught over the years, it amazes me how students who know how to cook and sew have less difficulty buying project lumber than those who don't. Maybe it's because they're used to thinking in terms of quantity—how many batches of cookies they can get from one pound of flour, or the pairs of curtains in six yards of 36"-wide fabric. Then again, maybe it's because they don't have preconceived notions about how to buy hardwood lumber.

The rest of us get all caught up in board feet. I knew one woodworker who calculated how many board feet he needed for a project, then phoned the lumberyard to have it readied for pickup. When he got there, his ten board feet were all in one large board—2" thick x 6" wide x 10' long!

Use cutting diagrams when you buy

Like yards in a fabric store and pounds in a meat market, board feet only represent a unit of issue—the basis on which cost is calculated. More important when you shop is the ability to look at a board and see the parts you need.

Hardwoods come in random widths and lengths, so each board varies in dimension. You can't calculate your needs in the 1x6s, 2x4s, and 1x2s of construction-grade lumber and expect to find hardwood in those dimensions.

That's where cutting diagrams, such as those we furnish with many projects in *WOOD*, come in handy. Take a cutting diagram to a hardwood dealer and he'll help you select the boards that will make the parts you need. If you have a project plan without a cutting diagram, make one.

Plan it out in *units*—the end panels, the top, the back, the legs, etc. When you plan to cut all the parts for one unit from a single board, all the pieces in that unit will match in grain and color.

Buy enough stock for usable waste

The biggest mistake people make in buying stock is not buying enough. If you buy sufficient wood the first trip, you won't have to stop working to make a second. Even more importantly, if you buy enough the first time, all your wood will come from the same pile. That often means the same tree, with little or no variation in figure or color.

Buying just enough stock to leave only an inch or two of cutoff in length proves to be penny-wise and pound-foolish, too. Buy your stock *long* and have enough left to make something later or to replace a ruined part.

You can edge-join long, narrow scraps to make up width in a future project. When you buy long, length will be there when you need it. You can't make up length, as you can width. It doesn't pay to be overly dollar conscious when buying stock.

Save on "discount" plywood

Most lumberyards have "scratch and dent" bins where you can save big on damaged (often only slightly) hardwood plywood. You can patch or cut off bad spots.

Remember that you can also laminate a thin, premium sheet to thicker, lesser-grade plywood, such as CDX, to make up for thickness. This works great for the sides in a chest of drawers. You'll have a good-looking panel, and can pocket the difference between your lamination and a thicker, premium sheet. 🌲

BAND SAW BLADES

WELDED TO YOUR EXACT LENGTH

WIDTHS TEETH PRICE/INCH

1/8" thru 5/8" 3 thru 32 \$.05

COMPLETE BAND SAW BLADE LINE INCLUDING SAW MILL BLADES

TO FIGURE PRICE:

Inch Length x Price/Inch + \$1.85 Weld Charge

MINIMUM ORDER \$10.00. Add \$2.50

per order for packing and shipping.

MasterCard and VISA accepted.

TO ORDER Phone or write to:

BUCKEYE SAW COMPANY

P.O. Box 14794, Cinti., OH 45214

1-800-543-8664 (Except Ohio)

1-513-621-2159 (In Ohio)

MAKE TOYS & WOOD PROJECTS

7 CAR TRAIN

\$6—Plan only.

\$27.50—Plan &

turned parts

(92 parts

in all).

Visa

& M/C

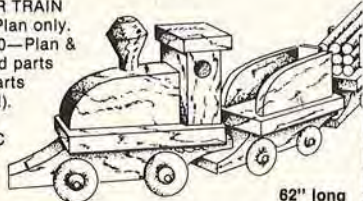

62" long

100's of plans, kits, colored & unfinished hard-wood parts for toys, crafts & furniture; plus tools, wood, finishes & supplies. Bulk prices available. Color catalog subscription \$1. (614)484-4363

Cherry Tree Toys, Box 369-9, Belmont, OH 43718

Have a problem with your subscription?

We want to solve it to your complete satisfaction, and we want to do it fast. Please write to: Robert Austin, *Better Homes and Gardens*® WOOD, P.O. Box 10628, Des Moines, Iowa 50336.

You can help us by attaching your magazine label here, or copy your name and address as it appears on your label. Send this along with your correspondence.

Name _____		
Address _____	Apt. # _____	
City _____	State _____	Zip _____

Moving? Simply attach the mailing label from this magazine and write in your new address below. (Please allow 4-8 weeks.)

Your New Address Goes Here

Name _____	
Address _____	Apt. # _____
City _____	
State _____	Zip _____

Subscription Rate:

6 issues — 1 year — \$18. Add \$6 for Canadian or foreign postage.

Renewal New Order

For Fast Service...

...it is better to write us concerning your problem and include the magazine label. Also, address changes are handled more efficiently by mail. However, should you need to reach us quickly the following toll-free number is available:

800-247-2504

Better Homes and Gardens®

WOOD

P.O. Box 10628 • Des Moines, Iowa 50336



NATIVE AMERICAN HARDWOODS

WALNUT, BUTTERNUT, CHERRY
CURLY & BIRD'S-EYE MAPLE
Most Other Domestic Woods

- EXTRA WIDE/EXTRA THICK STOCK
- TURNING SQUARES/BLOCKS
- QUARTERSAWN/BOOKMATCHED LUMBER
- SPALTED LUMBER/BLOCKS
- THIN STOCK NO MINIMUM
- FLOORING/PANELING WHOLESALE & RETAIL

Comprehensive Listing—One Dollar (Refundable)

NATIVE AMERICAN HARDWOODS LTD.

B1, W. VALLEY, N.Y. 14171 • (716) 942-6631

WOODWORKERS

FULL SIZE PATTERNS

Simple to make — Fun — Profitable

- 75 pattern packet plus "Shop Secrets"
- Over 50 "Folk Art" patterns
- 6 "Wind-Action" whirligigs packet
- 40 craft plaques plus projects
- 8 child pleasing aircraft packet
- 6 decorative magazine racks

Send \$6.00 per blueprint packet or choose any 3 FOR ONLY \$12.00.

ACCENTS, Dept. MA36

P.O. Box 262

Danvers, MA 01923

Brochure of 400 designs \$2.00
(Free with order)



KILN DRY YOUR OWN LUMBER

nyle corporation

the nation's largest manufacturer of dehumidification dry kilns is now offering small 500 to 10,000 board feet drying systems.

- ★ Made completely in the USA
- ★ The leader of the industry
- ★ Offering excellent warranties
- ★ Expert consultation and service



Box 1107-A, Bangor, Maine 04401

Telephone 1-800-648-9200

or 207-989-4335

LIKE OWNING YOUR OWN LUMBER-YARD!



FREE 30-DAY TRIAL

NEW SOLID STATE ELECTRONIC CONTROLS!

Just a twist of the dial gives you from 70 to over 1,000 cuts-per-inch!

Made in U.S.A.

Makes you money... saves you money!

New 4-in-1 power-feed shop planes, molds, joints, sands! Quickly converts low-cost rough lumber into high-value finished stock! Turns out perfect picture frame, quarter-round, casing, tongue & groove...all popular patterns...any custom design. Planes or joints without change-over. Converts in just minutes to a powerfeed drum sanding machine! This one low-cost power-feed shop opens up a truly astonishing range of products you can make and sell. Find out how you can try this versatile tool in your own shop on our 30-day Free Trial! Easy terms.

PHONE TOLL-FREE 1-800-251-4888

SEND FOR FREE FACTS TODAY



Woodmaster Tools, Inc.
Dept. PW11, 2908 Oak
Kansas City, MO 64108

YES! Please rush my FREE Information Kit and details on your 30-Day Free Trial Guarantee.

Name _____	
Address _____	
City/State _____	Zip _____

"Jorgensen"® AND "Pony"®

CLAMPS

Dependable extra hands for all types of clamping and work-holding jobs: woodworking projects, home maintenance, and furniture repair.



Write for FREE LITERATURE. For big 32-page "how-to-clip-it" catalog, send \$1.00.

ASK YOUR DEALER

ADJUSTABLE CLAMP COMPANY
THE CLAMP FOLKS
410 N. Ashland Ave./Chicago, IL 60622



"IF YOU BUY A
GENERAL

WOODWORKING
MACHINE
SOMEWHERE
ELSE YOU'LL
PROBABLY PAY
TOO MUCH."
J. Philip Humfrey

Every General machine receives and is shipped with Humfrey's all-points inspection report.

CALL TOLL FREE **1-800-387-9789**

#350
10" Table Saw
\$1345. US FREIGHT COLLECT
3 HP motor, Magnetic switch

#1180-1
6" Jointer
\$765. US FREIGHT COLLECT
1 HP motor, Manual switch

#160-2
Variable Speed Lathe
\$1095. US FREIGHT COLLECT
1 HP motor, Manual switch

#490-1
15" Bandsaw c/w Base
\$845. US FREIGHT COLLECT
1 HP motor, Manual switch

SIMILAR SAVINGS ON OTHER GENERAL MACHINES

J. Philip Humfrey Ltd.

We sell more General year after year - the reason is value - we satisfy our customers!

CATALOG \$2.00 (Refundable from order)

LAMINATED Southern Pine TABLE TOP

Make your own
Woodworker's Bench

For information write:
Southern Pine, Box 1056
Bay Minette, AL 36507

DOWELS - PLUGS - PEGS

Manufacturer Direct
Largest & finest selection Oak, Walnut, Hickory, Maple, Cherry, Mahogany, Teak, even Treated Dowels. Quantity discounts.

MIDWEST DOWEL WORKS, INC.
4631 Hutchinson Road
Cincinnati, Ohio 45248
(513) 574-8488
Catalog on request



SHAKER PEGS

Hard Maple 15¢
Red Oak 22¢
Walnut 22¢

Quantity Prices

Catalogue on Request

NEW! AFFORDABLE 24" KIT SCROLL SAW

FINALLY - At last a 24" throat precision scroll saw that is affordable to any woodworker - saw complete or kit form.

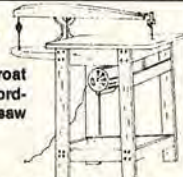

PEDAL SCROLL SAW

Beautiful all cast-aluminum reproduction of the time proven Velocipede No. 2 Scroll Saw. Great attraction when working craft shows. Total speed control. 24" throat can cut material modern scroll saws can't. Write or call—

Mo. res. add 5.625% sales tax

THE TOOL COMPANY
1306 S. Commercial
P.O. Box 629, Dept. BHG-8
Harrisonville, MO 64701
(816) 884-2679

THE WOODWORKING SHOW

machinery
tools - supplies

PASADENA, CA
Feb. 28 - Mar. 2, 1986
The Pasadena Center
300 East Green St.

PORTLAND, OR
Mar. 14-15-16, 1986
Multnomah County
Exposition Center
2060 N. Marine Dr.

ATLANTA, GA
April 4-5-6, 1986
Atlanta Civic Center
395 Piedmont Ave., N.E.

Call 1-800-826-8257 for further information.
With this ad \$1.00 off
general admission
price of \$5.00.

3 SPECIAL
SHOWS!

- FREE WORKSHOPS
- 100 EXHIBITS
- DOOR PRIZES

HARDWOODS DOMESTIC AND IMPORTED

Veneers

Boat Lumber · Cabinet Lumber
Red Oak · White Oak · Ash · Birch · Birdseye · Teak
Mahoganies · Cherry · Walnut · Maple · Poplar · Basswood
· Bubinga · Pearwood · Osage · Pines · Padouk · Ramin · Rosewood
Wenge · Zebrawood · Bocote · Cocobolo · Che Chen · Ziricote
Oak Mouldings · Dowels · Hardwood Plywoods
Planing · Rippling · Millwork

Send \$1.00 for price list.

No Minimum · Shipments Worldwide
30 Yr. Member National Hardwood Lumber Assoc.
Direct Importers of Foreign Hardwoods



United States Mahogany Corp.
746 Lloyd Road, Matawan, NJ 07747
(201) 583-6300

Open Monday thru Saturday

CLOCK COMPONENTS

QUARTZ CLOCK MOVEMENTS

WE FEATURE BATTERY, PENDULUM, CHIME QUARTZ MOVEMENTS OF ALL TYPES. UR-GOS, HERMLE, GRANDMOTHER, GRANDFATHER CABLE DRIVE AND CHAIN DRIVE, KEY WIND MOVEMENTS OF ALL TYPES, 400 DAY CLOCKS, MUSIC BOX MOVEMENTS, FLAT AND BEZEL TYPE DIALS—PLUS A VAST ASSORTMENT OF WEATHER INSTRUMENTS. HUNDREDS OF CLOCK ITEMS. VERY COMPETITIVE PRICES. WRITE OR CALL FOR FREE 75 PAGE CATALOG. \$2 FOR AIR MAIL.



THE QUARTZ FITUP THE MINI QUARTZ
Send To:

NEWPORT ENTERPRISES INC.
2313 W. Burbank Blvd.
Burbank, CA 91506
818-845-0555

On the Baltic's northern shores, where ash once grew thick and tall, ancient Scandinavians called the tree *Yggdrasil*. Its branches were said to hold the gods, its trunk their path to earth, and its roots the way to the underworld.

American Indians pounded "basket ash" to soften it for peeling into weaving strips. Canoe paddles were made from it, as well as tomahawk handles and spear shafts.

Today, the handles of many picks, shovels, rakes, and axes are made of ash. It also may be the most sporting wood around, the mainstay in laminated-wood tennis racquets, hockey sticks, and skis. Baseball bats have always been made of ash because of its ability to absorb shock, bend without breaking, and add heft without unwieldiness.

These uses, combined with its popularity with furniture makers, place ash among the commercial hardwood leaders.

Wood identification

Botanically a member of the olive family, ash grows throughout the Northern Hemisphere and numbers nearly 60 species. In North America, there are 18 species of ash. However, only a few provide commercial hardwood timber.

Foremost among them is white ash (*Fraxinus americana*), which grows from Nova Scotia and Maine west to Minnesota and south to Texas and Florida. Green ash (*Fraxi-*

ASH

the home run hardwood



Ash veneer



Brown ash



White ash

nus lanceolata) and red ash (*Fraxinus pennsylvanica*), both smaller trees than white ash, duplicate its range and are sold under its name. Black ash (*Fraxinus nigra*), the Indians' basket tree, is marketed as brown ash. It likes northern climes.

Oregon ash (*Fraxinus latifolia*), grows on the Pacific Northwest coast from Washington through northern California. Equal in size to white ash, Oregon ash stands as one of

the few commercial hardwoods in its region.

You can spot ash by the telltale gray bark with deep fissures in a diamond pattern. White ash, with its oval crown, may rise to 120' in the wild. Other ash species normally approach 60' to 80' tall.

Ash yields straight, close-grained wood that often displays a wavy figure. Its color ranges from creamy white to tan, but brown ash, as its name implies, is distinctly

darker and brown in color. For the most interesting grain and figure, brown ash gets the nod.

Dry white ash weighs about 42 lbs. per cubic foot. Brown ash is slightly lighter in weight.

Working properties

Despite ash's strength and toughness, you still can work it readily with either hand or power tools. When steam-bent, it holds its shape admirably.

The wood's close grain gives it high nail- and screw-holding power. Gluing poses no problems, nor does sanding and finishing. Ash works to a beautiful natural or stained finish. Darkened, it imitates oak.

Uses in woodworking

The same abuse-resistant properties that make ash the commercial choice for tool handles make it ideal for chairs and other furniture. Because it doesn't impart any taste, ash is also perfect for food containers and cutting boards.

And don't overlook ash when it comes to lathe work. It turns exceptionally well.

Cost and availability

You can buy ash lumber and plywood nationwide at about the same price as red oak. Brown ash, when available, costs less.

You may see Japanese ash, or *sen*, sold as plywood. It costs less than American ash, but doesn't take stain as readily.

You'll find ash veneers available both flat and quarter sawn. 🌲

Photographs: Hopkins Associates
Illustration: Steve Schindler

Portrait of

"I owe my father thanks for being the best teacher and dad a girl could ever want. . . . An article featuring my father and me with our hobby would be of value to many teens and parents.

Thank you for your time. I am awaiting your reply in great hopes."

Michelle Feasel

—from a letter to WOOD dated Jan. 18, 1985



Five years ago, Michelle, now 19, was carving lapel pins for high school friends. Now, she carves full time on a commission basis and for direct sale, traveling with her father, Bill Feasel, 40, to carving shows in the East and Midwest.

When Michelle isn't carving, she enjoys the outdoors—hunting, fishing, or hiking—with her parents, brothers, and sister near their Fremont, Ohio home.

Palm-sized miniatures of shorebirds, ducks, and geese proved salable for Michelle. They also reflected her love of the outdoors. Those shown here are displayed on blocks of jelutong.



a young carver



In the letter excerpted at left, Michelle told us about her budding career in carving. We just had to see for ourselves what she could do, and hear what she had to say about her work. What we found makes a great pitch for family woodworking, one of the themes of this issue (see pages 66-72).

"Michelle knows more about the workshop than she does the kitchen," Linda Feasel remarks about her oldest daughter. You sense Linda's pride as she continues: "Michelle is doing now what most kids never get to do, and she's accomplished it by herself."

At a stage in life when other youngsters are pondering jobs, higher education, and the future, Michelle seems to have found her way through the maze and is building a reputation as an artist with her wood carvings. She spends 40 to 60 hours each week in the workshop, and sells all she can produce.

Yet Michelle doesn't view her success as an early-arriving career, or even a job. "I look at it as a paying hobby," she says. "I still carve because I like what I'm seeing as the work progresses, and still give each piece 100 percent of my effort. I hope I never reach a point where each piece would be a duplicate of the one before. Then, that would be a job."

In that respect, Michelle is much like her father, Bill, a carver who tutored her about wood, tools, finishes, and other aspects of the craft.

Bill describes his work as something far removed from the commercial. He's been carving and selling in the off-hours from his position with a package delivery firm for 15 years. To Bill, carving represents more of a therapeutic release than a business.

Wildlife carving comes naturally

The buck deer spied on a hunting trip, the migrating snow geese seen from a blind, the heron spooked out of a marsh, or the salmon caught on a Lake Michigan vacation all become candidates for creation on Bill and Michelle's workbench.

"We put into wood things we've seen or visualized. We both love the outdoors and want to express what we've seen in our carvings," the father says.

This expression in wood of the outdoors grew from family experience. The Feasels have always found enjoyment there.

Bill, Linda,
Michelle,

Continued



Portrait of a young carver



brothers Michael, 17, and Mark, 15, and little sister Jackie, 11, work together weekends on 17 undeveloped acres they own a few miles from Fremont. There, in a setting "almost like Canada," they put in ponds, have built a rustic cabin, and siphon water from a crystal-clear spring for their living needs. There, too, they hunt, fish, walk the forest, and wade the streams.

together. You don't have to spark their interest—they'll manage to do it themselves."

Everybody loves a carver

Michelle's first carvings were tiny lapel pins her schoolmates ordered to wear on their blazers. They had admired some pins her father had carved, and Michelle decided to begin making them herself.

and admire them, and wish I could do as well," Michelle remembers.

At one show, a carver encouraged her to do miniature shorebirds. They were a simple start for salable work, something to build on.

Give and take: How father and daughter work together

Once Bill discovered his daughter's interest in carving was serious, he spent more and more time helping her. As her expertise grew, her own ideas flowered.

"We see things differently at times," Michelle explains, "as any two artists would. I have to make him understand occasionally how I see something. If it differs from his view, it pulls us apart temporarily from what we do together."

Despite the differences, sharing work space also fosters the sharing of new directions, as with the colorful carousel animals Michelle now focuses on.

Michelle's history teacher suggested she carve and paint a tiny carousel animal to fit a miniature carousel replica he owned. While she had never carved anything with four legs before, she liked the idea, and asked her father for help.

The first figure, a horse, stood 6" high, and was a hit right off. It resulted in orders for a giraffe and a zebra. They sold for \$35 each. Carousel animals were a delightful, enchanting departure for both father and daughter.

"There's something about carousel music and the larger-than-life impressions of riding a carousel animal that stick with you all your life," says Michelle. "The animals allow me to be very creative. With wildfowl, fish, and game animals, you have to stick to the shapes and colors nature provided. And you can never carve and paint a piece better than God made it in the first place. With carousel animals, you have freedom."

Buyers also like the fantasy. A horse, similar to the one shown above, sold recently for \$875.



Carving and painting carousel animals like the 8"-high horse and pig, above, allow Michelle's creativity in form and color to flourish.

At first it was only Bill who captured the wild in his carvings, the children watching his perceptions being re-created in wood. Then the children began to carve, too. Even young Jackie found fascination in sanding the carvings her father made for her. Michelle, however, became totally involved with creating in wood.

She acquainted herself with the carving tools by straightening up her father's workbench, and with paints by washing out his brushes. Finally, she asked Bill to teach her his techniques.

To Bill, his oldest daughter's interest was simply a natural outgrowth of the family's penchant for doing things together: "Nowadays, it seems, so many families go off in different directions without any ties that bind. I think if children are to become interested in what one of the parents is doing, it'll happen if you have always done things

"I really started to like carving because the other kids admired my work. I could reach out and talk with them more easily when the focus was my carving," Michelle recalls of high school.

Meeting people and having something in common with them has always been a part of carving that attracts her.

When Bill traveled to Midwestern decoy shows to sell carvings and swap knowledge, he took Michelle along to broaden her interest in the art of the outdoors. "I had never seen anything like it—all the decoys, the hunting dogs, the interesting people. They accepted me and gave me attention that I wasn't used to getting from adults except my dad," says Michelle.

She was inspired, too, by the work she saw. It gave her direction. "I couldn't believe they could make decoys look so real, so close to nature. I'd walk around for hours

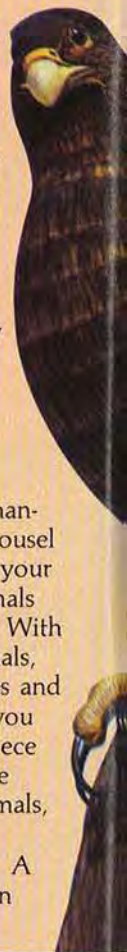

Learning to use the tools of the carving trade

Michelle thinks nothing of cutting 2" stock to pattern on the band saw, a task she once feared.

Bill works nights, and wasn't always around when Michelle needed stock cut. So he taught her how to use the saw safely.

"Dad didn't want to take the chance of my cutting a finger, but I told him I'd accept all the blame if anything happened. Learning how to use the band saw was something I needed to do, and he understood."

There was a whole lot to learn. Bill taught her how to use the power carving tools to remove wood fast when roughing the patterned stock to shape. The palm gouges and knives, for cutting details, came next.

Both prefer X-acto knives over the traditional carving knife. "I don't have the patience to put a real fine edge on a knife," Bill admits, "with these you change blades."

Texturing in the feathers on wildfowl or duplicating scales on game fish carvings requires a woodburning tool. The Feasels make the red-hot tip from soft metal, bending it to the shape they want to burn into the wood. A small, three-quarter circle of metal becomes a fish scale, to be embossed on the carving hundreds of times before it's painted.



Michelle's life-size peregrine falcon



Bill Feasel shows his daughter where he thinks she should remove more wood with the power carver in her hand.

For carvings requiring lots of burned-in detail, Bill and Michelle like *jelutong*, which comes from Indonesia. Most of their carvings, however, begin as high grade, C-Select pine. They've also experimented a little with *tupelo*, which grows in the southern U.S.

Acrylic colors add life to the wood

For lifelike finishes on their carvings, both father and daughter apply acrylics, despite doubts about how long the colors will last.

"Acrylics haven't been around long enough to judge how good they'll look over the long haul," says Bill. "You can still see the rich colors on signs that were painted with oils a hundred years ago, but we don't yet know how long acrylics hold up."

Michelle admits that she uses acrylics simply because they dry faster. "When you're trying to keep up with orders, that really counts."

To get a shiny surface, Michelle sprays lacquer or varnish over the acrylic paint, as with her carousel animals. For a dull, soft finish, like a duck or kingfisher might have on their feathers, she adds a clear matte sealer, which also protects the paint from oily fingers.

When Michelle and her father start painting for a carving show and sale, they move up to the kitchen. Taking up all available countertop space, they spread duck

carvings, fish plaques, and carousel animals everywhere to take advantage of the natural light that floods the counters. Linda says it looks like a "decoy factory."

The life of a full-time carver

Michelle believes her carving gives her a jump on an art career that's as yet still undefined. "I know I'll do something in the art field, but it may be fashion design or something else really different. Right now I'm still thinking about it," she says.

At present, Michelle's long hours fulfilling orders and stockpiling for future carving shows at times causes her to reflect on whether or not she really wants to continue carving on a money-making basis.

"I worry that if I turn carving into a career, and keep at it, I'll eventually burn out. Carving is lonely. But I think about the people I'll meet and the friends at shows that I'll see again. And when I'm sitting there in the workshop I don't even think if it's worth it. I just enjoy," Michelle says.

No matter what the young carver may do in the future, she knows she'll never give up carving. When that future eventually includes her own family, she wants to be able to share carving with them. "My dad has shared so many things with me, I want to do the same with my children." 🍀

Produced by Peter J. Stephano
Photographs: Jim Elder

Applying Plastic Laminates

How to Get the Job Done Right

Do "self-respecting woodworkers" use plastic laminates? You bet they do! It's never going to replace wood as the material of choice among woodworkers, but we think you'll find it an interesting surfacing option for certain projects. And, boy, is it fun to work with!

We've divided this article into two parts. "The Basics" will serve as a refresher for those of you who have some experience with plastic laminate already (and as an introduction for those who don't). In "Nifty Solutions for Special Situations," we deal with some situations and some new materials you may not have encountered yet.

Photographs: Bob Calmer
Illustration: Advertising Art Studios Inc.

With today's new solid-color surfacing materials, you can create an array of striking edging treatments. Here we combined a walnut banding with Formica-brand "pale gold" solid-color surfacing material, then routed a cove along the top edge.

The Basics

2 GOOD WAYS TO CUT LAMINATE DOWN TO SIZE

1 The score-and-snap method of cutting laminate works well with all standard laminates, but not with the new solid-core surfacing materials. Start by laying the laminate face up on a clean surface. Then mark the cutoff lines, allowing at least $\frac{1}{2}$ " in both directions for overhang. Put a piece of thin scrap beneath the cutoff line, locate the straightedge so that it protects the panel you'll be using, then score along a straightedge several times with a sharp-pointed tool. We use an inexpensive carbide-tipped scoring tool we bought at a local floor-covering tool supplier. When you see the dark backing showing through the color layer the entire length of the cutoff line, you're there.

2 With your hands positioned as shown and with the laminate face up, lift up on one end of the laminate, exerting pressure until the material snaps. The photo inset shows what happens at the score line (a) if you press down on the laminate rather than lift up; (b) if you do as we suggest; and (c) if you don't score the laminate completely.

3 In situations where you need to cut the laminate in two or more directions, lay out and mark the cutoff lines, then drill a small hole in the scrap portion where the cutoff lines intersect. Doing this prevents you from accidentally scoring too far and also lessens the chance of stress cracks developing at the corner. Score completely

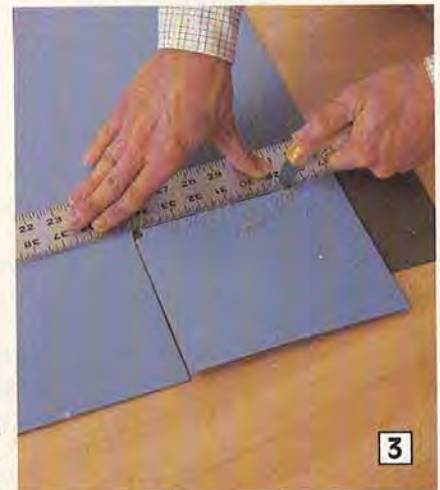

through the shortest dimension, then score and snap along the other.

4 We've also had good luck cutting laminate with a router fitted with a flush trimmer bit. Just mark your cutoff line, clamp a straightedge beneath the laminate, and run the router along the straightedge. You'll get a super-smooth cut.

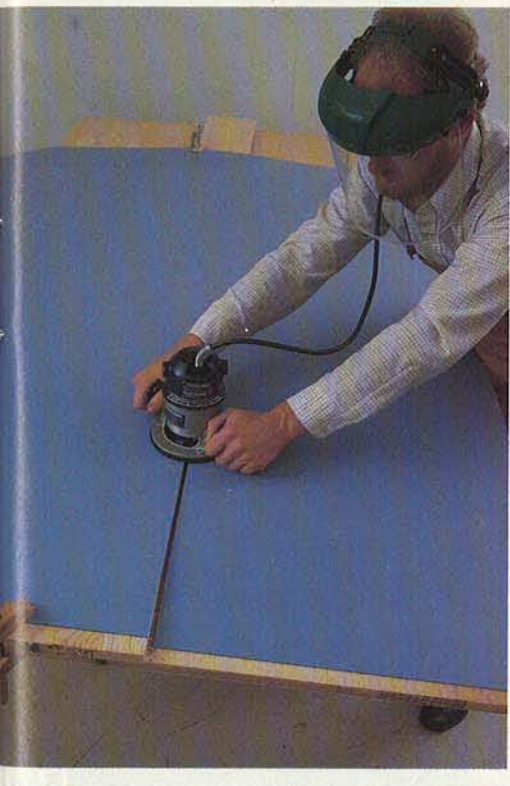
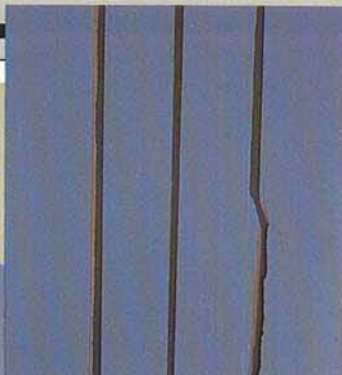

Applying Plastic Laminates

PREPARING THE SURFACE FOR PLASTIC LAMINATE



We've used both good-quality plywood and particleboard as a substrate for laminate. Regardless of which material you use, though, fill surface voids before applying the laminate. Also true up the edges and fill voids with wood putty.

The photo, *above*, shows the setup we use to guarantee a smooth edge. This technique comes in handy if you plan to band the edges of a panel with wood.

When putting an edge banding on a shelf or countertop (see the photo, *below*), glue and nail the wood to the substrate, making sure the top edge of the banding is slightly higher than the substrate. Go back later and either plane or scrape the surfaces flush. Don't use a belt sander; it may gouge the surface or round over an edge.



APPLYING THE ADHESIVE AND LAMINATE

1 Because you want to minimize the visual impact of the joint lines, the sequence of application is every bit as important as the technique. As a general rule, cover the underside of a panel first, the back and side edges, the front edge, and finish with the top surface. Contact cement sets up quickly, so on all but very small projects we recommend using a narrow, short-napped roller. Give both mating surfaces one liberal coat of contact cement (use only the non-flammable type), then allow the adhesive to dry. How do you know when the surfaces are ready for contact? Give them the touch test! If the adhesive sticks to your finger when you touch it, it's not ready.

2 To keep from mispositioning the laminate on the substrate, we lay venetian blind slats between the substrate and the laminate. Once we have laid the laminate into position and have checked to make sure we have excess to trim off on all edges, we withdraw the slats one at a time. Smooth the laminate with one hand as you work toward the other end.

3 If for some reason you goof, we've found that you can retrieve laminate even if it's already made contact. With a spray bottle partially full of contact cement solvent, dust a fine mist of solvent along the edge. Then, lift up the edge with a putty knife. Continue spraying and lifting, and the substrate and laminate will part company. Allow the solvent to evaporate, recoat both the laminate and substrate, and relay the laminate.

4 After the substrate and laminate make contact, you want to ensure a good bond between the two. Though you can accomplish this by tapping the entire surface with a scrap block and hammer, we use a rubber J-roller. With it, we can apply a lot of pressure, and we also avoid the problem of fracturing the laminate at the edges, which is a possibility with the other method.





TRIMMING AND FINISHING OFF THE EDGES

We've trimmed laminate with carbide-tipped flush-trimming router bits with ball-bearing pilots, but we can honestly say that a much less expensive solid-carbide bit with a solid pilot works just as well for us. And that's the opinion of some professionals we've talked to as well. With either type bit, you've got to be on guard against burning or scratching adjoining surfaces. We've found the two best strategies here are to keep the router moving and to apply a layer of petroleum jelly to the surface that the bearing guides against before routing off the excess. Theoretically, a router bit with a ball-bearing guide should prevent mishaps. But as you trim an edge, for example, the contact cement builds up and restricts the movement of the bearing.



Trimming laminates with a flush-trimming bit results in a sharp, square edge. For safety's sake, dress the edge with a single-cut file as shown, *below*. Hold the file so that the edge will be beveled slightly, and move the file across the edge lightly several times.



MORE TIPS ON WORKING WITH LAMINATES

- Before working with plastic laminate or the new solid-color surfacing materials, allow a day or so for the material to acclimate. Also make sure that the contact cement is at room temperature before applying it.

- Be *extra* careful when handling and working the solid-color surfacing materials. They're even more brittle than standard laminates. They also have the habit of chipping when being cut, so use sharp, carbide-tipped cutters when cutting or shaping them. And if you glue several layers of these materials together to create decorative edge treatments, be sure to scuff up the face of the layers to which other material will be applied to ensure a good bond.

- If you apply laminate to any surface that won't be anchored securely to another assembly, always apply laminate, or the less-expensive "backing sheet," to the back side of the panel to minimize the chances of warping due to moisture.

- Always work in a well-ventilated area when applying contact cement, as its vapors can be dizzying if inhaled for too long a period. And don't work around heat or flames.

- Sometimes air bubbles form between the laminate and the substrate after application and cause the bond to break. (Usually the cause of this is laying down the laminate before the cement has "flashed off.") To correct this situation, lay a damp cloth over the area in question, then place an iron set at the cotton setting onto the cloth. Doing this reactivates the cement and allows you to press the laminate and substrate together.

- To help prevent stress cracks at inside corners, hold the contact cement back about 6" in all directions from the corner, then apply white glue to both surfaces and clamp them together.

- To keep the contact cement applicator relatively pliable between coats, wrap it in plastic to keep the solvent from escaping.

Continued

Applying Plastic Laminates

Nifty Solutions for Special Situations

WRAPPING LAMINATE AROUND CORNERS

Ever wonder if you could wrap plastic laminate around a relatively tight radius? We were curious to find out, so one of the staffers brought in a blow dryer to see if we could do a little coaxing by heating the laminate. Nothing doing; it didn't heat the laminate to the 313° temperature that postforming manuals specify as the correct laminate bending temperature. So we got hold of a commercial heat gun at a local rental outlet. With it, we formed the laminate around radii down to about 1". We bent the laminate first, then applied contact cement.



ALIGNING GEOMETRIC-PATTERNED LAMINATES

One of the new-generation "designer" laminates, the geometrics can cause you headaches if you're not careful. To make them look good, the surfaces you adhere them to must be square. This, combined with the fact that the patterns themselves aren't always true, makes aligning these laminates difficult. To make things easier on ourselves, we cut four like-sized wood scraps, and use them as shown. We make any needed adjustments, then apply contact cement to both of the surfaces and then lower the laminate down onto the substrate.



PICTURE-PERFECT JOINT LINES

When you want a perfect joint line between two pieces of laminate that butt end-to-end or edge-to-edge, try this technique: Clamp two pieces of scrap to your workbench with a small space between them, then butt the two pieces of laminate together. Now secure the pieces of laminate with two more scrap lumber cleats. One pass with your router fitted with a carbide trimming bit, and you've got it made. Hold the router against one of the guides, and don't rotate the base of the router because many bases are not perfectly round.

HIDING UNSIGHTLY SEAM LINES AND DEFECTS

What if you end up with a less-than-perfect joint line or need to repair a defect of some sort? We decided to try a product called Kampel SEAMFIL from a local laminate retailer. We color-mixed some according to the directions and forced it into a seam. It worked as advertised, although we did have quite a time getting a color match. If we used the product again, we'd pay to have the factory color-match the product for us so as to guarantee good results.

WRAPPING A CYLINDER

Start by cutting the laminate to the length and width required. Be sure to allow extra for trimming. Apply contact cement to both mating surfaces, wait until the cement is dry to the touch, and apply the laminate to the substrate, except for the last 8 to 10". Slip a piece of waxed paper beneath the laminate, then carefully mark both edges of the laminate as shown.

Carefully align one edge of a straightedge with the marks you just made, and clamp the straightedge in place as shown. Run your router along the edge.



FINISH-SANDING WOODEN EDGE BANDING

When you choose the option of dressing up the edge of a shelf or counter with a wood banding, getting the wood perfectly flush with the top of the laminate is tricky. When we apply the banding, we try to make sure the wood projects a bit above the laminate. Then we mask off the laminate and use a sanding block to bring the two surfaces flush. When we begin to see scuff marks on the masking tape, we call it quits.

DRESSING UP THE EDGES OF TEXTURED LAMINATES

You can trim the edges of textured laminates as you do other laminates, but the bearing or pilot will follow all of the depressions and other irregularities in the material along the way. We dress the edge by working a triangular file carefully as shown here. A time-consuming technique to be sure, but necessary when working with these kinds of textured patterns.

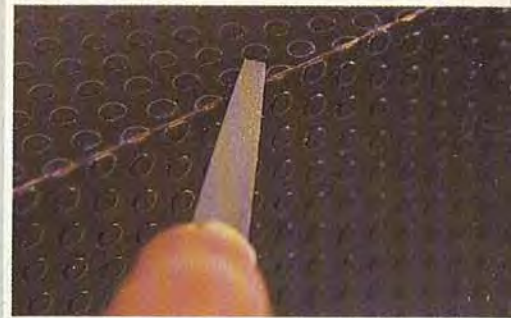

THREE COMMON COUNTERTOP PROBLEMS

Countertop installations give most people fits, mainly because the walls countertops fit up against are irregular. But scribing to fit allows you to compensate for those imperfections. In the instance shown at left, we used a thin piece of scrap material and a pencil to scribe the irregularities of both walls onto the laminate.

Most laminate-trimming routers can't trim laminate right up to the wall. To trim the remainder of the excess material, we guide our scoring tool along a straightedge several times until we work our way through the material. Then we put the finishing touches on with a file.

Here's a tip for those situations when you install a sink in a countertop. We mark the cutoff lines, then bore a 1/2" hole in each corner of the cutout. These holes do two things. First, they provide a radius at each inside corner, which helps to prevent stress cracking. And they also prevent you from accidentally scoring surrounding laminate. We score along each of the cutoff lines, then use a jigsaw with a metal-cutting blade to cut out the top. (This blade reduces chip-out.)

For more information on what's available in plastic laminates, how they're sold, and where to purchase them, please turn to the article on page 76. 🌿

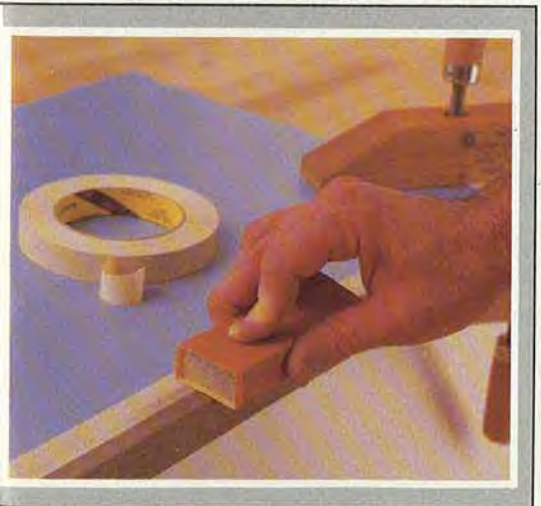
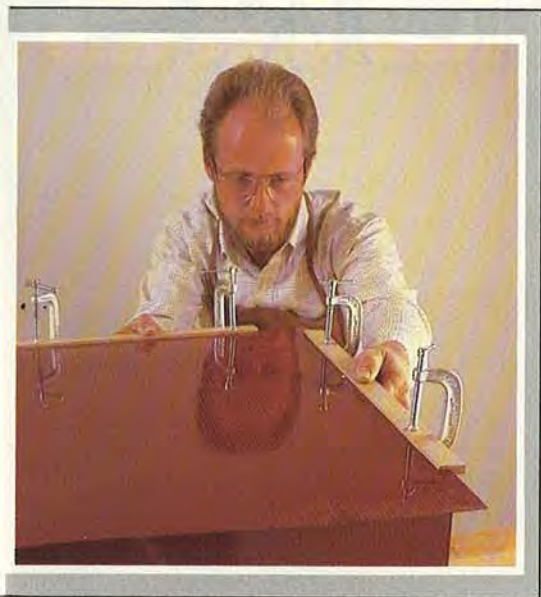

Picture
Perfect

PARSONS



TABLE

A single sheet of $\frac{3}{4}$ " plywood and another of high-gloss laminate join forces in this easy-as-pie project. The finished product measures 36" square and 17" high—ideal for a conversation grouping like this one. Or, adapt our dimensions to suit your specific requirements. If you want another color or finish, today's selection of laminates gives you choices galore. For two other laminate project ideas using the same construction techniques, see page 87 of this issue.

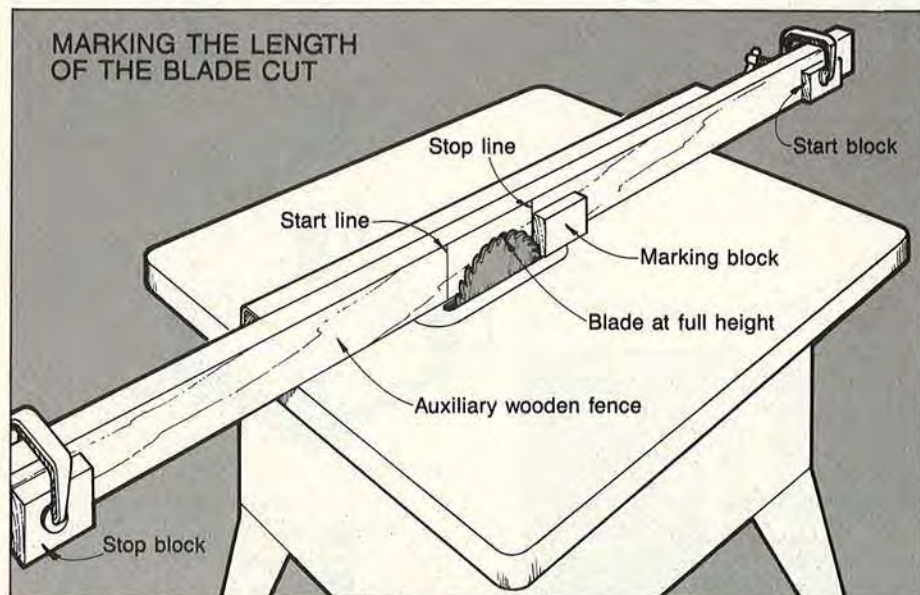

BUILDING THE PLYWOOD FRAME

1 Lay out all the parts of the frame on the face side of the plywood, as shown in the Cutting Diagram.

Then, with a table saw (and helper if you can find one), cut the top (A) to size.

2 Using the Cutting Diagram as reference, rough-cut the table legs (B, C) with a jigsaw. Then trim the exterior edges and the leg bottoms with the table saw.

3 To make the interior cuts on B and C easier to cut perfectly straight, attach a long wooden auxiliary fence to your table saw fence. Unplug the table saw, raise the blade to its full height, and position the fence against the blade. Slide a piece of wood along the fence until it comes into contact with the blade, and mark the maximum length of the blade cut on the wooden fence, as shown in the drawing, *left*. Extend these lines up the side of the wooden fence so that they will be visible when you cut the plywood.

4 Using a straightedge, mark start and stop lines on each A and B, as shown in the Cutting Diagram. Now, move the table saw fence $\frac{1}{4}$ " away from the inside edge of the blade. Lower the blade below the surface of the table, and set one of the B legs on the surface of the saw. Line up the start and stop lines on B with those on the wooden fence, and clamp start and stop blocks to the fence at those points (see the photo, *left*).

5 With one of the Bs against the auxiliary fence and the start block, plug the table saw in, turn it on. Slowly raise the rotating blade up through the $\frac{3}{4}$ " plywood stock until the blade is extended upward to its full cutting height. Not only is the blade at its full cutting height, it is at its full cutting length as measured in Step 3.

Warning: When raising the moving blade through the plywood, be sure to hold the plywood firmly against the table, but do not put your hand near the area where the blade will protrude!

Continued

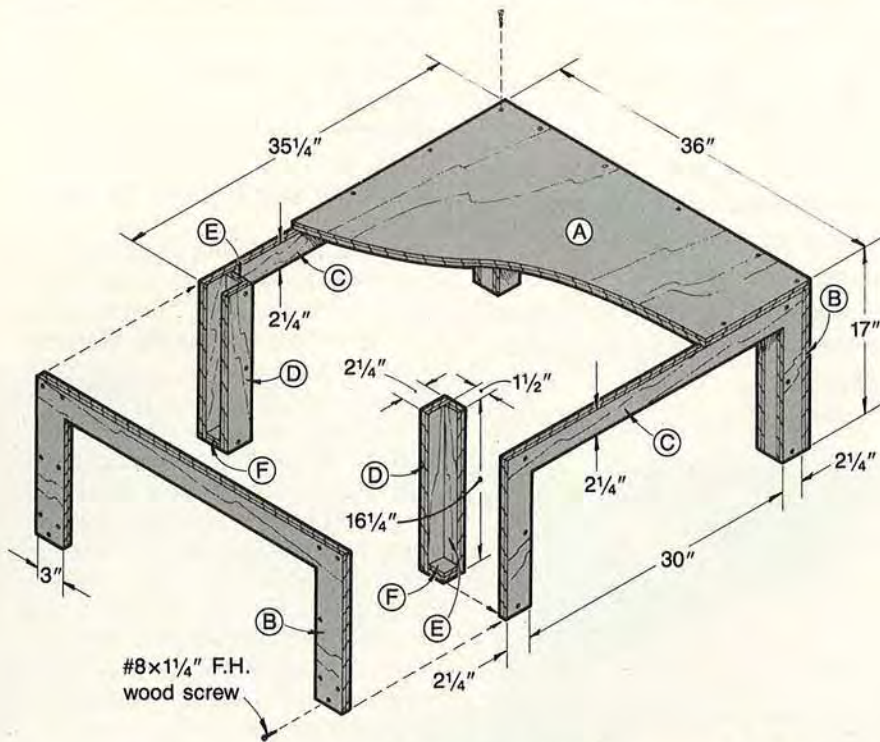

Cutting Diagram

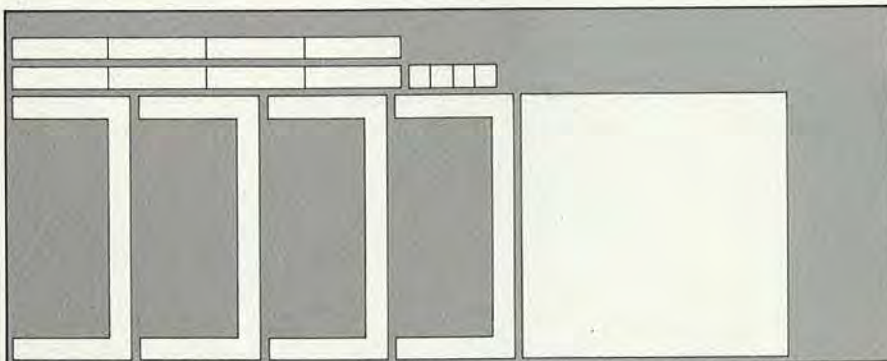
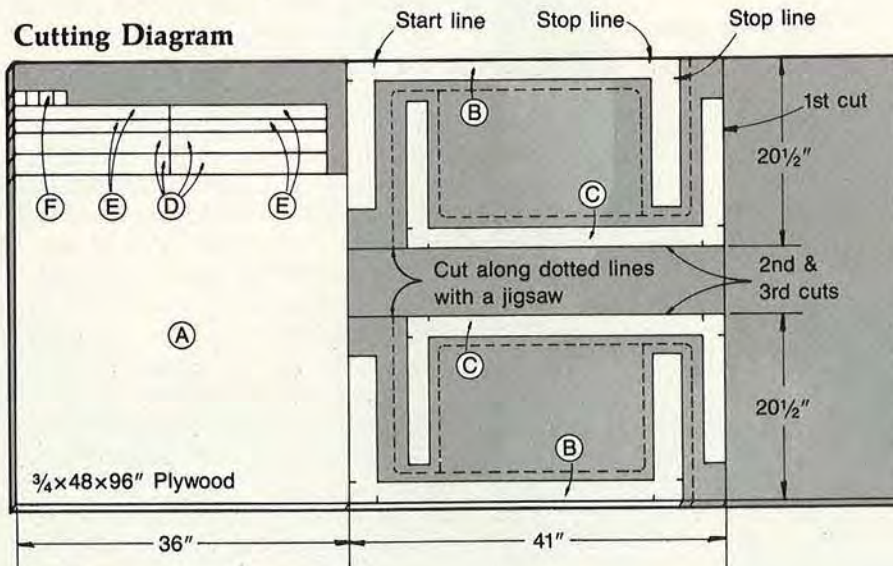

LAMINATING SEQUENCE

Step A

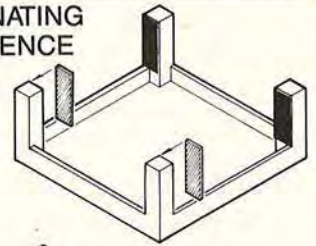

Step B

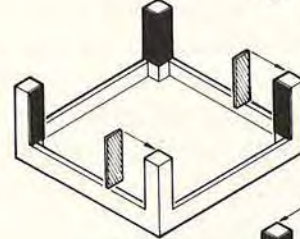

Step C

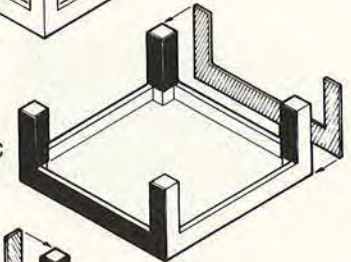

Step D

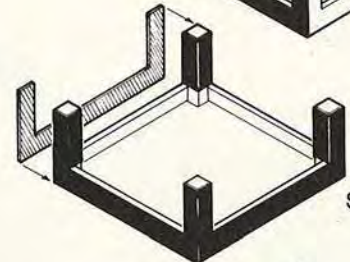

Step E

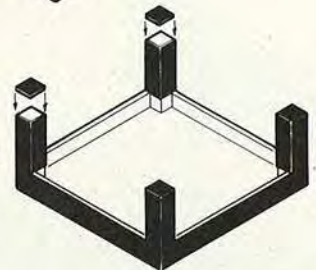

Bill of Materials

Part	Finished Size*			Material	Qty.
	T	W	L		
A	3/4"	36"	36"	plywood	1
B*	3/4"	16 1/4"	36"	plywood	2
C*	3/4"	16 1/4"	34 1/2"	plywood	2
D	3/4"	2 1/4"	16 1/4"	plywood	4
E	3/4"	1 1/2"	16 1/4"	plywood	4
F	3/4"	1 1/2"	1 1/2"	plywood	4

*These parts are cut larger initially, then trimmed to finished size. Please read the instructions before cutting.

Supplies: #8 x 1 1/4" flathead wood screws, wood filler, contact cement, plastic laminate, black paint, petroleum jelly, permanent black felt-tipped marker

6 Push the leg along the fence until you meet the stop block at the other end of the fence (see the photo, *right*). Holding B in place, shut off the saw and wait until it comes to a complete stop before removing the piece. Lower the blade, place the other B in position, raise the blade through it, and cut it in the same manner. To cut the C legs (they are $\frac{3}{4}$ " narrower), you will need to move each stop block toward the center by $\frac{3}{4}$ ".

7 To make the cuts along the legs of B, move the fence 3" from the inside edge of the blade. Position a stop block on the fence, and cut both inside cuts on each B as shown in the drawing, *right*. Move the fence 2 $\frac{1}{4}$ " from the blade, and make both cuts on the inside edge of each C using the same stop block. You will need to use a hand-saw to square up the cuts, as the blade leaves an arc shaped cut.

8 Dry-clamp the leg assemblies (B-C) together, and check for a proper fit of all the parts. Trim if necessary. Then, glue and clamp the leg assemblies together, checking for square. Be careful not to round-over or dent the square edges when clamping. To reinforce the joints, drill pilot holes and drive #8 \times 1 $\frac{1}{4}$ " flathead wood screws where shown in the Exploded-View Drawing. Make sure the head of each screw rests flush with the surface of the plywood (otherwise they will show through when you apply the laminate).

9 Glue and clamp the tabletop onto the leg assembly, and secure it with screws.

10 Cut the plywood parts D, E, and F to the sizes given in the Bill of Materials for the inner legs. Glue up one D, one E, and one F for each inner leg. Secure the pieces together with #8 \times 1 $\frac{1}{4}$ " flathead wood screws.

11 Glue and screw the inner-leg assemblies to the table assembly to form the completed carcass.

12 After the glue dries, fill *all* voids and holes with filler. Sand the carcass assembly smooth, being extremely careful not to round-over any edges.

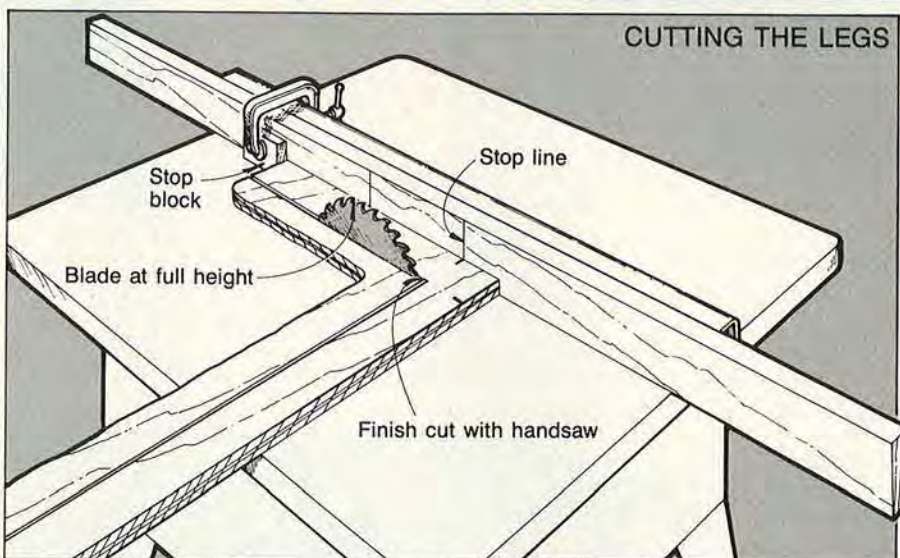

APPLYING THE LAMINATE

Note: If you don't have any experience with applying plastic laminate, or you're a little rusty, read the preceding techniques article, "Applying Plastic Laminate," for some helpful hints.

1 Using the Laminating Sequence Drawing as a guide, cut and apply laminate to the inner edges of each leg (see Steps A and B).

2 Lower the table onto the face side of the laminate, and trace the outline of the legs and tabletop with a colored grease pencil. Allow at least $\frac{1}{2}$ " in all directions when cutting for overlap, as it will be trimmed with a router later. Apply the laminate to the plywood legs as shown in Steps C and D, then to the tabletop, and then to the bottom of the legs (Step E). Trim after each step with a router fitted with a flush-cutting bit. (We rubbed

petroleum jelly along the path of the bit's pilot to prevent it from marring the already-applied laminate. The pilot may clog with glue and burn the laminate.)

3 To minimize the seam lines of the laminate, "stain" the exposed laminate edges with a permanent black felt-tipped marker. Wipe off the excess with a clean rag.

4 Mask off the laminate and paint the remaining exposed plywood on the bottom side of the table black.

Buying Guide

● **Plastic laminate.** 4 \times 10' sheet Nevamar Black S-6-1G "Glossie" Finish. For the distributor nearest you, write Nevamar Corp., 8339 Telegraph Rd., Odenton, MD 21113, or call Nevamar at 301-569-5000 and ask for ext. 394 (customer service). 🌲

Project Design: James Downing
Photographs: Hopkins Associates
Illustrations: Kim Downing; Bill Zaun

PLEASE



This chair complements the oak dining table that appeared in the February, 1986 issue of *WOOD* (page 64).

BE SEATED!

Solid Oak Dining Chair

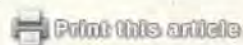

Note: The instructions explain how to make one chair, and the Bill of Materials gives the number of pieces required for one chair. You will need to determine how many chairs you want, then cut and machine as many parts as

necessary. When making four or six chairs, cut all identical pieces at the same time. We tried upholstering our own chairs with mixed results; you may be better off having a professional do the upholstering for you.

No woodworking project demands more attention to snug joinery and properly scaled dimensions than a chair. We've taken special pains to ensure that this sturdy oak dining chair will remain comfortable and eye-pleasing for years to come.

FORMING THE LEGS

1 Cut the front legs (A) to size.

(You can use 1½" stock or laminate two ¾" pieces together.)

2 To make the back legs (B), start by cutting two 1½" thick pieces 4½" wide by 36" long. Using the drawing shown below, lay out and mark the shape of just *one* of the back legs. With a helper, use a flexible thin strip of wood to mark the curved lines.

3 Lay out and mark the position of the mortises on the front and back legs as dimensioned in the Leg-Rail Assembly Drawing, below, and as shown in the Back/Leg Drawing.

Note: Remember that you are working in pairs (pairs of front legs and pairs of back legs). You'll want to mark the mortises on each pair before cutting to ensure that you machine the correct side of each

part. (We marked one right leg and one left leg and used these as templates to mark the rest of the legs.) We also taped the pairs together after each marking and machining procedure.

4 To form the mortises in the front legs, use a drill press with a ⅜" flat-bottomed bit, and drill out the stock within the marked mortise lines ½" deep, as shown in photo A, p. 43. You can drill one of the

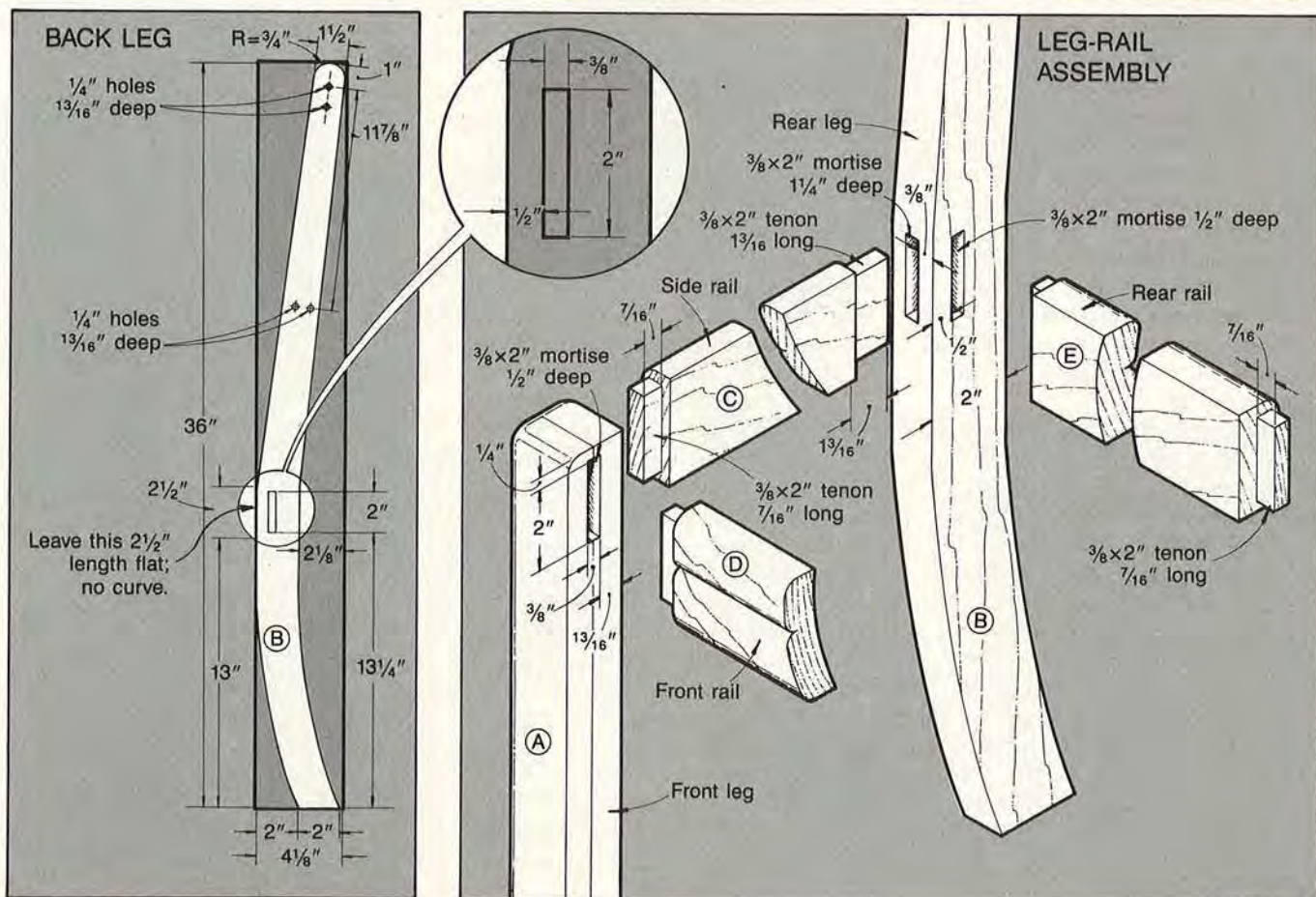

Continued

SOLID OAK DINING CHAIR

Bill of Materials For One Chair					
Part	Finished Size			Material	Qty.
	T	W	L		
A	1 1/2"	1 1/2"	15 1/2"	oak	2
B	1 1/16"	4 1/8"	36"	oak	2
C	3/4"	2 1/2"	16 1/8"	oak	2
D	3/4"	2 1/2"	15 7/8"	oak	1
E	1 1/16"	2 1/2"	16 3/4"	oak	1
F	3/4"	3"	15 7/8"	oak	1
G	3/4"	1 1/4"	15 7/8"	oak	1
H	3/4"	2 1/8"	7 1/2"	oak	4
I	3/4"	1 3/4"	3 3/4"	oak	4
J	1/2"	16"	17"	plywood	1
K	1/4"	15 3/4"	10 3/4"	hardboard	1
L	1/2"	1/2"	9 3/4"	pine	2

Supplies: #8x1" flathead wood screws, #8x1 1/2" flathead wood screws, 1/4x1 1/2" dowel pins, 1/2" foam padding, fabric, Stanley 1" corner braces (no. CD997), staples.

Cutting Diagram for One Chair

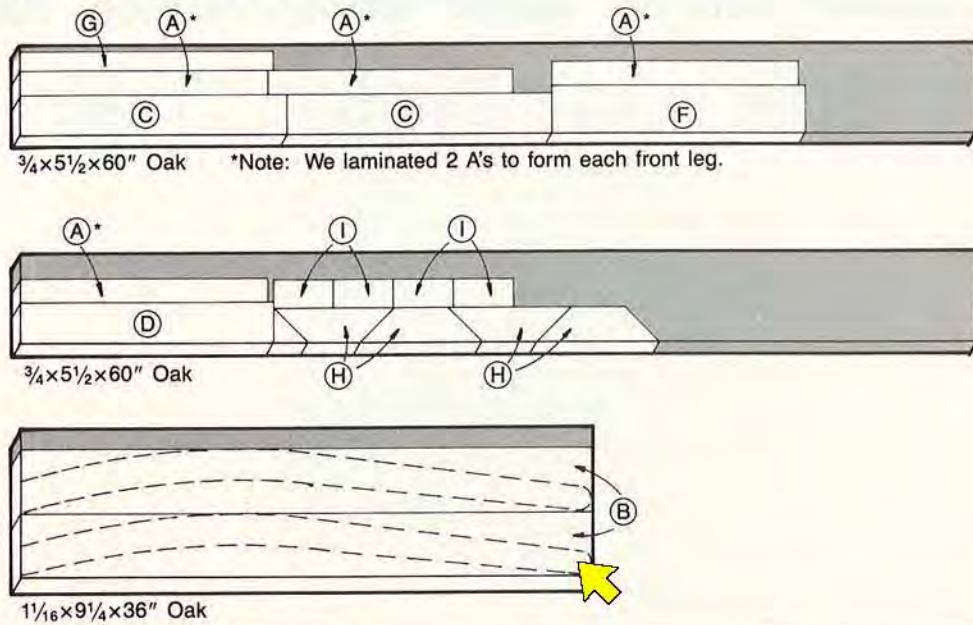

mortises in each front leg with the setup shown. You must then move and reclamp the stop block to the other side of the bit, and drill the other mortises in each leg. Marking the mortise locations earlier sure prevents confusion here! We used a back fence and stop to ensure that all the mortises were consistent in size and location. And we set the stop on the drill press to make sure that all holes were drilled to the same depth.)

5 Drill the mortises in the front of the back legs the same way the front ones were drilled. However, note that you will need to construct a longer fence with stops for your drill press table.

6 Using a double fence (shown in photo B) on the router table to ensure a perfectly straight routed groove, and a 3/8" straight bit, rout the mortises clean in each front leg as shown in the photo. Use a stop to ensure a consistent mortise length. You'll be able to rout one mortise on each leg front with the setup shown. Move and reclamp the stop block to the other side of the bit, and rout the other drilled mortises clean.

7 Use the same double fence on the router table and the same 3/8" bit 1/2" above the surface of the table. Adjust the fences and stops and

rout the mortises clean (1 1/4" deep) in the front edge of each back leg, as shown in photo C. Make at least two passes to achieve the 1 1/4" depth and not strain the bit.

(As shown in the photo, we marked the length of the mortise on the side of each rear leg, and marked the location of the router bit on the front fence. The marks on the fence indicate the exact position of the 3/8" bit. This enabled us to rout the mortise to exact size, despite the fact that this is a "blind-routing" operation. Using the marks, you can eliminate the use of a long back fence and stops.) Photo D shows the routed mortise.

8 Drill the mortise in the inside face of each leg. Then move back to the router table, adjust the fence, stops, and depth of cut, and rout the mortises clean.

9 Use a sharp chisel and a mallet to square the rounded ends of each routed mortise.

10 With a band saw, cut the previously marked back leg to shape, cutting just slightly outside the line drawn. Now, sand the leg to the marked line. Using this leg as a template, mark the shape of the other back leg. Then cut and sand it to shape. (Accurately shaping the first leg ensures a good template for tracing the other legs.)

TIME TO MACHINE THE RAILS

1 Rip and crosscut the side rails (C), front rail (D) and back rail (E) to size as listed in the Bill of Materials. Note that the back rail is longer than the front, as shown in the drawing, below.

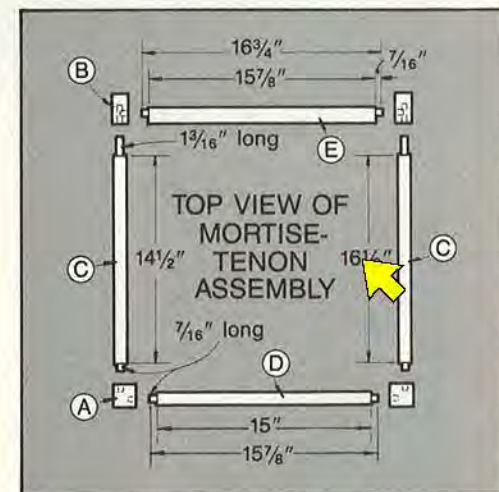

2 Cut the ends of each rail to form tenons as dimensioned in the Leg/Rail Assembly Drawing. (We did ours on the radial-arm saw using a dado blade. We cut our tenons 1/16" less than the depth of the mortise to allow for glue pocketing. We test-cut scrap material first and checked the fit of the test tenon into the mortises previously machined in the legs.)

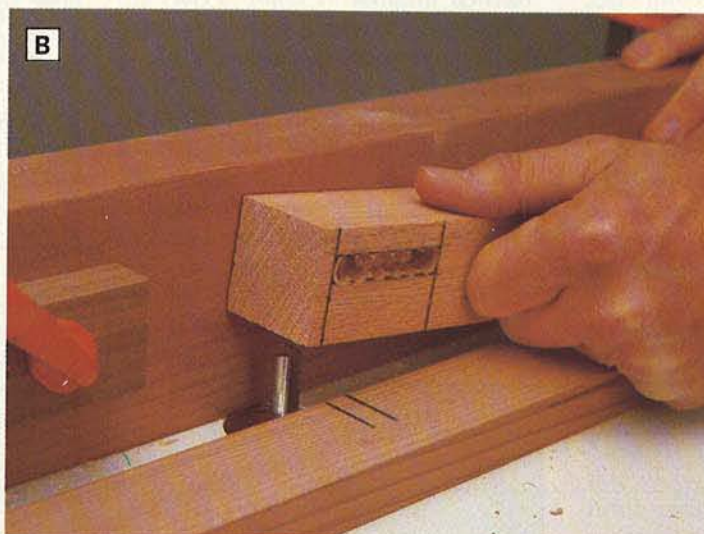
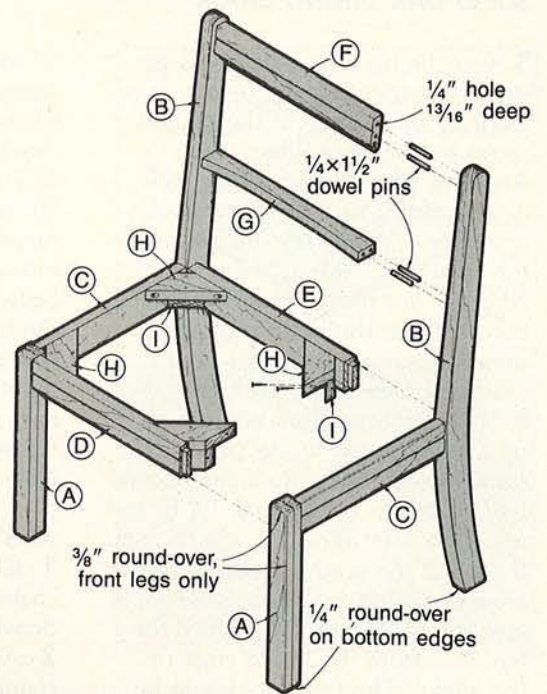
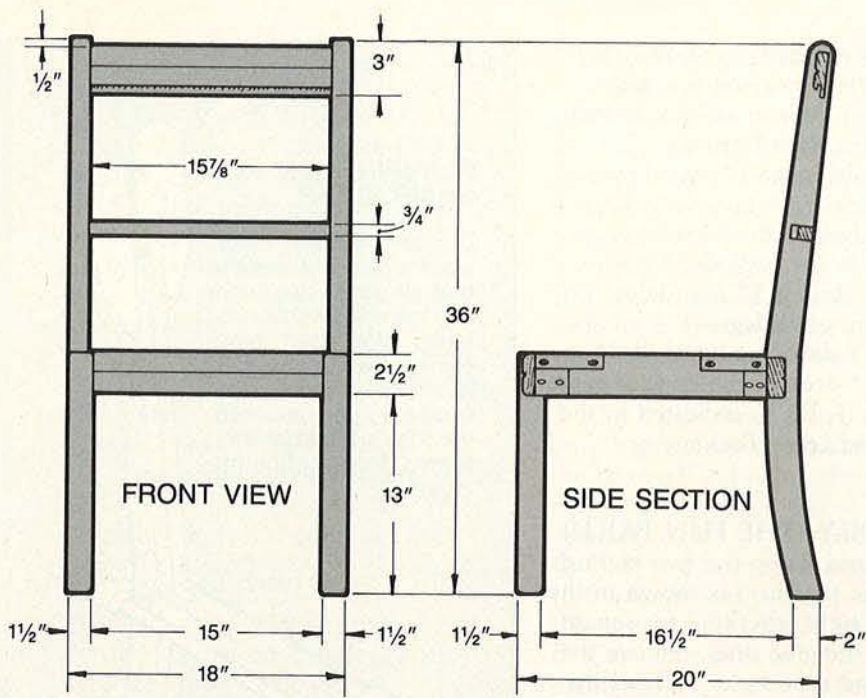

A Drilling the Marked Mortise

B Routing the Front Leg Mortise

C Routing the Mortise in the Back Leg

D The Completed Back-Leg Mortise

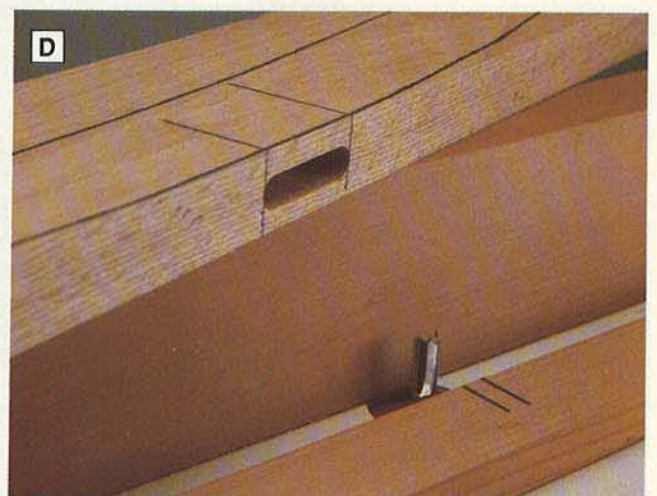

Continued

SOLID OAK DINING CHAIR

3 Cut the backrest rails (F, G) to size. (Use the drawing, *below*, as a guide to mark and cut the shallow recess on the front edge of G.)

4 Using the drawings of the rails (C, D, and E) and the upper backrest shown *below*, lay out and mark the location of the $\frac{3}{32}$ " ogee cuts. Also lay out the $\frac{1}{4}$ " groove you'll be cutting in the bottom of the upper backrest rail (F). Fit your table-mounted router with a $\frac{3}{32}$ "-point cutting ogee bit, and set up a fence to guide the cut as shown in photo E. Rout the decorative groove in the rails (C, D, E) and upper backrest (F).

5 To cut the groove in the bottom edge of F, start by fitting your table saw with a dado blade. Move the fence $\frac{1}{4}$ " from the inside edge of the blade. The first cut should be $\frac{1}{4}$ " wide by $\frac{3}{4}$ " deep along the bottom edge of F. For the second cut, switch back to a $\frac{1}{8}$ " blade set $\frac{3}{8}$ " above the surface of the table with the outside edge of the blade $\frac{1}{2}$ " from the fence.

6 To round-over the top and bottom edges of the upper backrest (F), use the point-cutting ogee and a fence on your router table. Using a

$\frac{3}{8}$ " round-over bit, round-over the edges of the front and side rails (C, D), and the rear rail (E), as indicated in the Rails Drawing.

7 Using the same $\frac{3}{8}$ " round-over bit, rout the front outside and top outside edges of the front legs, as indicated in the Exploded-View Drawing. Rout a $\frac{1}{4}$ " round-over on the bottom of all legs.

8 Using a doweling jig, drill $\frac{1}{4}$ " holes $1\frac{3}{16}$ " deep in the ends of the back rails (F, G), as indicated in the Upper- and Lower-Backrest Drawings.

ASSEMBLY (THE FUN PART!)

1 Glue and clamp the two mating chair sides together, as shown in the drawing, *right*, checking for square.

2 After the glue dries, remove the clamps and excess glue. Chisel the remaining mortises in the back legs to their original $\frac{1}{2}$ " depth. The mortises have been partially filled in by the tenon of the side rails (C).

3 Dry-clamp the front and back rails (D, E) to join the two chair sides together. Check the fit of pieces (F, G) between the back legs. (Part G should be positioned flush with the back edge of B.)

CLAMPING THE CHAIR SIDES

Clamp the two chair sides together to ensure that all edges are flush and the sides will be uniform. We used pipe clamps and handscrews as shown. We also used waxed paper between the chair sides to prevent them from sticking together.

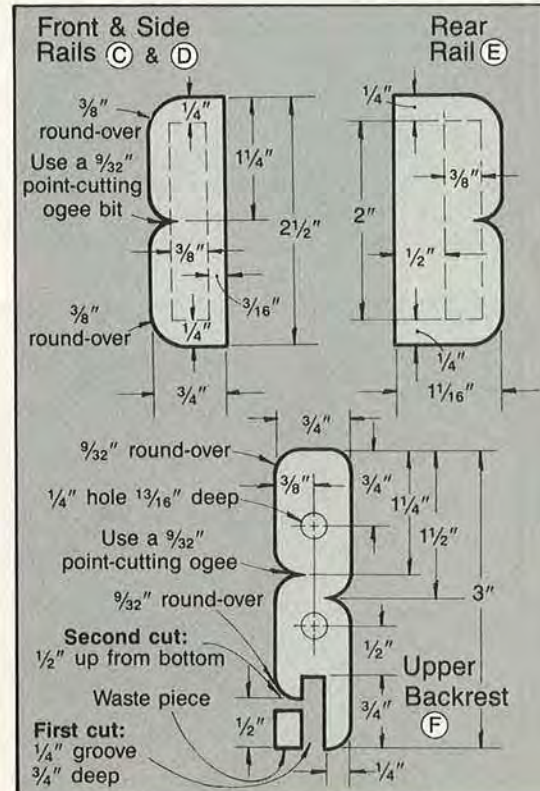
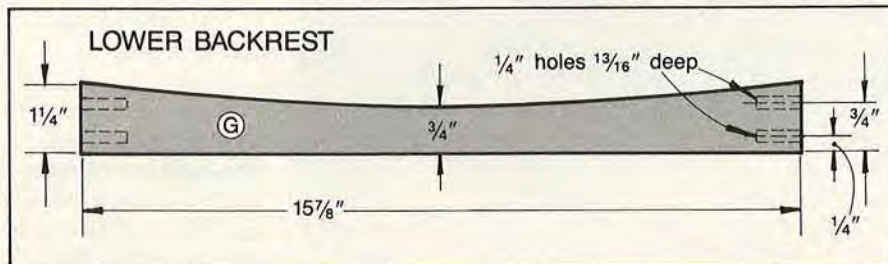
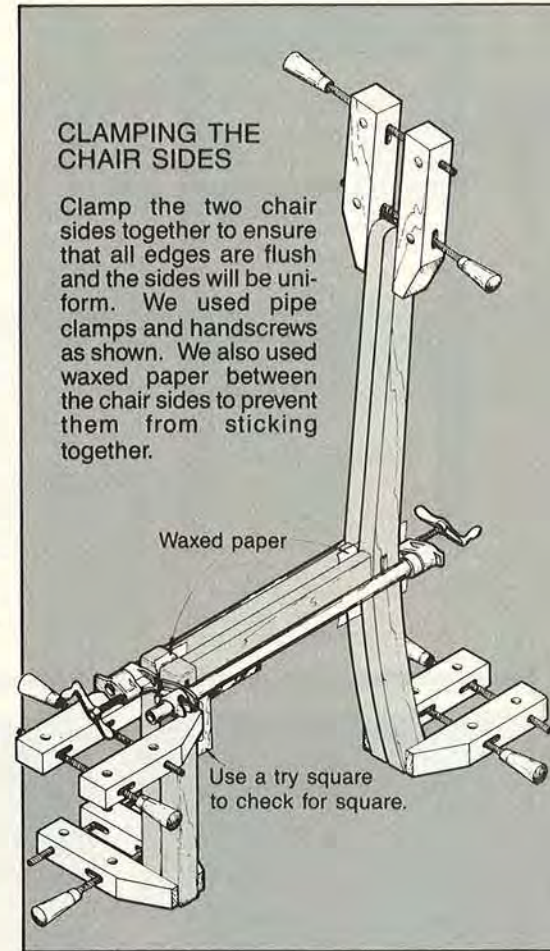

4 Loosen the clamps slightly. Using $\frac{1}{4}$ " dowel centers (you'll need to buy two sets of dowel centers for this project) in the ends of F, correctly position F between the back legs. Once positioned, compress the back legs together to transfer the dowel center's mark into the back legs. Repeat this process for the lower backrest (G).

5 Remove the clamps, and drill $\frac{1}{4}$ " holes $\frac{1}{16}$ " deep at the marks on the back legs. A doweling jig helps ensure correct hole location.

6 Glue and insert the dowels, then glue and clamp the two chair sides together with the front and back rails (D, E), and upper-back rails (F, G). Check that the rails are square with the legs. Make sure that the chair is sitting on a perfectly flat surface while clamping.

7 Cut the corner braces (H and I) to size. (We found that a couple of corner braces didn't fit, as the chair was a bit out of square. To correct this, we cut the braces slightly larger, scribed the angles needed, then recut the pieces for an exact fit.)

8 Clamp the corner braces in position as shown in the Exploded-View Drawing. Then drill the pilot holes, and glue and screw the corner braces (H) in place. Follow the same procedure to mount the lower braces (I). Fasten H to I with a $\#8 \times 1\frac{1}{2}$ " wood screw.

NEXT, THE CUSHIONS

1 Cut the plywood seat (J) to size. Radius the front corners, and notch the back corners, as shown in the drawing, *right*. Bore 1" vent holes through the plywood. Sand or rout a slight round-over on the top and bottom edges of the plywood.

2 Cut two pieces of $\frac{1}{2}$ "-thick foam padding to the same size as the plywood seat. Cover the seat (J) and foam with fabric.

3 Cut the backrest panel (K) and pine staple cleats (L) to size. Bevel the top end and radius the bottom end of each cleat as shown in the drawing, *right*.

4 Glue and clamp the pine cleats to the hardboard panel flush with the bottom and outside edges.

5 Cut two pieces of $\frac{1}{2}$ "-thick foam padding—the first to fit between the cleats and the second to overlap the cleats. Attach the fabric to the panel and cleat assembly as shown in the Seat-Back Drawing.

YOU'RE ALMOST THERE! FINISHING AND FINAL ASSEMBLY

1 Sand the entire chair assembly smooth, breaking any sharp edges with sandpaper. Finish the chair as desired. (We used several coats of polyurethane.)

2 After the finish is completely dry, turn the chair upside down on

SEAT CUSHION

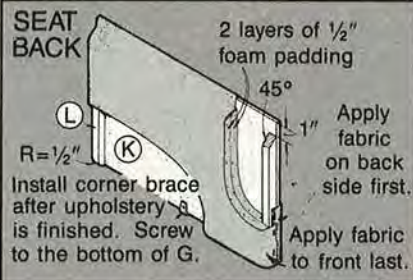
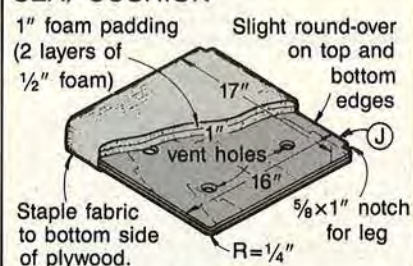

a clean work surface. Drill pilot holes and fasten the seat-cushion assembly to the corner braces.

3 To achieve the curve in the lower part of the backrest, make a small cut ($\frac{1}{2}$ " long) in the fabric along the bottom edge of the upholstered back, just in front of the hardboard. Then slip the top part of the upholstered back into the groove in the upper backrest. Press the hardboard back against the lower curved backrest (G) and clamp in position.

Insert a metal corner brace in the cut and in front of the hardboard as shown in the Seat-Back Drawing. Then screw the brace to the bottom side of G to secure the hardboard firmly against the backrest. (While we used the metal braces in the chairs we upholstered, an upholsterer used brads to fasten and bend the hardboard to the curved-lower backrest, eliminating the need for a metal brace.)

BUYING GUIDE

● $\frac{9}{32}$ " *Point-cutting ogee bit*. Stock no. 9GT25583. \$7.49 from Sears.

● *Dowel-center set*. Accurately locates matching dowel holes. Two centers each; $\frac{1}{4}$ ", $\frac{3}{16}$ ", $\frac{1}{8}$ ", $\frac{1}{2}$ "-diameters. Stock no. 9GT4184. \$3.99 per set from Sears. ●

Produced by Marlen Kemmet
Project Design: David Ashe, Blueprint Workshop Company
Photographs: Hopkins Associates
Illustrations: Bill Zaun; Randall Foshee

FRONT CORNER BRACE

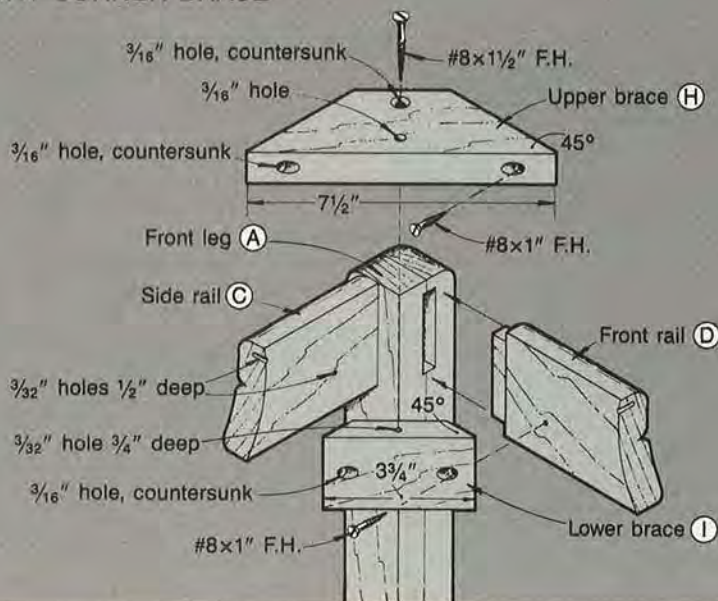



MORE AND MORE WOODWORKERS

Just a decade ago, only a handful of U.S. woodworkers knew anything at all about Japanese waterstones—except for the obvious fact that you use water, not oil, to lubricate them. Then, about five years ago, woodworking suppliers made waterstones available in the U.S. on a big scale. The stones caught the fancy of woodworking pros and now are intriguing home woodworkers.

Why all the fuss about these man-made sharpening stones (like natural oilstones, high-quality

natural waterstones are disappearing fast—some now cost as much as \$2,000!). In part, the stones' popularity reflects Americans' increasing fascination with Japanese woodworking methods and tools: The Japanese traditionally have preferred softer, finer waterstones for sharpening the hard steel used in their tools.

But other factors, such as speed of sharpening and grit consistency, also are selling waterstones for sharpening any tool that demands a finely honed edge.

WHAT WATERSTONES CAN OFFER YOU

Speed tops the list of waterstone attributes. All the woodworkers we talked to who use waterstones reported that they sharpen much faster than oilstones—"up to 10 times as fast," according to enthusiast Leonard Lee, president of Lee Valley Tools, a Canadian supplier.

It's not just that you spend less time getting a keen edge, Lee explains: "You can concentrate on controlling the exact shape of an edge. You make fewer mistakes."

WATERSTONE COMPARISON CHART

GRADE	JAPANESE NAME	GRIT	USES	HINTS & WARNINGS	AVERAGE COST*
VERY COARSE	<i>kongōsha-do</i>	80x to 220x	Part of complete sharpening system; removes maximum amount of metal. Takes out nicks and breaks, leaves cleaner edge on damaged blades, sets the bevel.	The coarse scratches it leaves need to be removed with finer-grit stones. Constant splashing with water required to flush the metal particles.	\$9-20
COARSE	<i>ara-to</i>	700x, 800x	Removes small nicks, refines badly dulled edges, establishes bevels. Also helps clean edges scratched by VERY COARSE stones.	Raises burrs and leaves light scratches, which are removed by finer stones. Many bladed tools do not come presharpenered: They have grind marks on the back and on the machine-ground basic bevel. COARSE and/or MEDIUM stones remove them.	\$10
MEDIUM	<i>naka-to</i>	1000x, 1200x, 1500x	Sharpens knives, finishes carpentry tools, removes scratches caused by stones coarser than 1000x.	Raises burrs.	\$10-20
FINISHING	<i>awase-do</i>	4000x, 6000x, 8000x	For fine honing, polishing, burr removal, etc. Use on both sides of blade to produce a fine edge.	Hones backs of blades until they are flat. Letting swarf (mud) accumulate and using less pressure as you finish honing will increase polishing action and produce mirror-bright finishes.	4000x: \$15 6000x: \$15 8000x: \$25
COMBINATION	-----	various combinations (see right)	100x/220x handles rough work; 180x/600x sharpens axes, drawknives, shears, sickles, etc.; 250x/1000x shapes and finishes blade for carpentry. With 1000x/6000x, the 1000x side takes out scratches, sharpens knives; 6000x side provides very good sharpness for finer work.	The 1000x/6000x is an excellent introductory waterstone. Along with a coarser stone, it makes a good basic sharpening system.	\$5-25

*Varies by size; thicker deluxe stones cost more

HAVE THE EDGE?

SURE SEEM TO THINK SO!

Lee Valley Tools stocks both oilstones and waterstones and has researched the topic of sharpening stones extensively—even examining stones and sharpened chisels under the electron microscope in a procedure called photomicroscopy.

Their research confirmed manufacturers' claims that waterstone technology is superior in controlling at least two critical factors that determine the quality of a stone—consistent size of the particles bound together in the stone, and fewer hidden impurities that can ruin even the best natural stones for sharpening. And you get all this at a price that's competitive with comparable oilstones.

SOUND TOO GOOD TO BE TRUE?

Make no mistake—there are some disadvantages. Because they wear faster, waterstones show chips, gouges, and unevenness more quickly than oilstones. Depending on how much you use them, they may wear out faster than oilstones, although they still last many years. (You'll probably drop and fracture one before you have to buy a new one.) Another potential frustration has been eliminated, since you now can obtain waterstones in a variety of unusual shapes and forms for sharpening curved edges, just as you can oilstones.

In the view of most woodworkers we talked to, the pros definitely outweigh the cons. A typical comment came from David Jordan, Editor of our parent publication, *Better Homes and Gardens*, and an avid woodworker. David has used waterstones for two years. "They cut fast, and you can really feel the bevel on the stone when you're sharpening," David says. "I'd pay five times as much for them. I still have my oilstones, but now I rarely use them."

What do the oilstone folks have to say about their new rivals from



During the sharpening process, water helps keep blade edges cooler and washes away loose particles of stone and steel. This prevents the stone surface from glazing over.

across the Pacific—competitors like Matsunaga Stone Co., Ltd., (King brand)? It's no surprise that they are taking note.

Bruce Anderson is product manager for Norton Pike Sharpening Stones, which markets both man-made and natural oilstones. "The Japanese do indeed have an excellent man-made stone. Their

waterstones sharpen quickly and produce an edge comparable to that of our finest natural oilstones."

Watch for innovations from the oilstone manufacturers in the next few years. "We're working on a finer, harder man-made stone that you can use with oil, using technology that already exists in our industrial grinding wheels."

SOME NOTES FROM OUR SHOP

You never know till you try for yourself! We turned a couple of our editors loose in the shop one afternoon with Project Builder Jim Boelling and some very dull, nicked plane irons and chisels.

No doubt about it, the waterstones did the job faster than the oilstones we tried. We noticed cutting action immediately with the waterstones. The oilstones required several strokes before they really started to cut.

The oilstones we used had to be clamped in a vise during sharpen-

ing, which wasn't necessary with the waterstones (many come with their own wooden bases). Tip: The key to using most waterstones is to soak them for about 5 minutes before use; save time by storing larger stones in water.

We paid just over \$50 for the 220-, 1,000-, and 6,000-grit waterstones we used (a combination stone would have saved us some money). Comparable grits in oilstones cost us about \$40. ♣

Written with Richard Mudrow
Photograph: Hopkins Associates

 Print this article

Here we show off more examples of your handiwork, from the purely decorative to the decoratively functional: a minutely detailed clock, a painstakingly reproduced Victorian table, a whimsical child's door, and an intricately carved Polish eagle emblem. Once again, your projects demonstrate the many turns that woodworking takes.

A. All in good time

*James Q. Buffenmyer, 65
Lombard, Ill.*

Industrial model maker, retired

Jim set the hands of time in motion with this unique, interpolated, wall-hung timepiece. An inlaid mother of pearl dot on the moving dome marks the minutes while the inlay

in the rotating star tracks the hours.

Think of the 12-pointed star as a large, glued-up sandwich of various woods. Jim first slices the wood at 45° on a table saw with a fine-tooth blade. Then he reslices the pieces at 60°. Finally, he reassembles the 1"-long, pointed pieces.

Making the star required a challenging 48 separate cuts, but as a former model maker for the Atomic Energy Commission, Jim had the experience. He's learned a few things, too. When working with small pieces, Jim uses the eraser end of a pencil to guide the tiny wood shapes through the table saw.

Jim mounted the dome on the minute-hand spindle of a battery-powered clock movement and used the hour-hand spindle to rotate the 8"-diameter star.



B. It all began with a jigsaw

*Bill Kern, 40
Des Moines, Iowa
Photographer*

Bill traces his woodworking activity back to a simple \$9 jigsaw he bought to install a fireplace 8 years ago. That successful venture into the world of do-it-yourself piqued his interest to the point that the jigsaw now has been joined by a full complement of woodworking tools, many of which he used in crafting this 24"-high walnut Victorian table.

From a photograph in a furniture book, Bill drew his authentic design and working plans. To support the Italian marble top, he made a 2¼" apron from laminated walnut. The legs were rough-cut on a band saw, then routed to shape. Supporting spindles were lathe-turned, as was the large, globe-shaped finial in the center. Bill shaped the flutes on the sphere by hand with carving chisels.

"I spend a lot of time on the finish because I'm very particular about what I put on the wood," Bill says. To begin with, Bill uses Victorian-type aniline dyes rather than stain to even out the color. Then he progressively sands with up to 220-grit paper. Next, he applies a sanding sealer and goes over it with wet/dry 220 paper. Two coats of sprayed-on satin varnish get sanded in between with 320-grit.

Bill, you're a stickler for a fine finish—and it really shows. Great work!



SHOWCASE



C. Eagle eye for detail

*James J. McMahon, 61
Easthampton, Mass.*

Chief petty officer, USN, retired

Jim's work reflects his travels. While in the Navy, he carved at sea what he recalled from many ports around the world. In Poland, the national eagle caught Jim's eye, but he waited for retirement to carve it. Eight-five hours of carving went into this uniquely personal memento.

His 22"-wide by 24"-high Polish eagle took three types of wood. New England "pumpkin" pine forms the body and head. To lessen the chance for breakage, Jim used hard maple for the legs, feet, and claws. Ash fit the bill for a pliable wood to fashion into curved tail feathers. Jim soaked and steamed the ash, then bent it into shape. All parts were first carved, then glued up.

For a finish, Jim applied artist's oils, dulled first with clear matte to knock down the sheen.

The carver says ready-made carving tools often don't allow him to shape every nook and cranny his eye perceives. So, he sometimes forges his own—a fast-shaving 4"-wide chisel, for instance. Now, that's complete talent!

D.



D. A spline in time

*Lynn Yaple, 40
Grass Valley, Ca.*

Printer/part-time cabinetmaker

Lynn didn't have to hover over a drafting board sketching out ideas for his child's bedroom door. The design came naturally when a friend gave him the "Winnie the Pooh" stained glass.

He completed the entire door in two days, but a good deal of that time was taken up by the window molding. A square or circular molding would have made life easy, but the elliptical molding proved a tough cut to make. Lynn rabbeted the door panel to accept the window. Then, he also rabbeted the molding so that it would fit into the door and help hold the window in place.

In a departure from typical door construction techniques, Lynn used splines and mortises to join the redwood stiles and rails of the frame.

"The spline gives you more gluing surface so the door is stronger than with dowel construction," he explains. Lynn cut the 5½"-long × 3¼"-deep mortises with a plunge router to control the cut. He finished the door with lacquer. ♣

To submit your projects . . .

Send a 35-mm color slide, with the project as the focal point and a simple background—no people. Include a capsule description—materials, special joinery, finish, and dimensions, for example. *WOOD* will pay \$25 for published projects. Slides cannot be returned unless you enclose a self-addressed, stamped envelope.

Project Showcase
Better Homes & Gardens®
WOOD magazine
Locust at 17th
Des Moines, IA 50336

AIR POW

If you think the only thing you can do with an air compressor is inflate tires, think again. Compressors make many shop chores easier, and accessories can replace conventional power tools. But they don't come cheap, and noise and moisture can pose problems.



Until we set up the workshop at WOOD, most of us on the staff thought of an air compressor as a nice but expensive luxury. Now, we use it consistently for blowing sawdust off workbenches, machinery, and ourselves, as well as for spraying finishes. Our compressor has become a handy, efficient, and very nearly indispensable tool.

While we are just experimenting with other air-powered tools, at least one woodworker we've come to know quite well—industrial arts professor and cabinetmaker Roger Cliffe—finds pneumatic tools essential in his custom cabinet shop. Before you rush out and

buy an air compressor, though, there's plenty to consider to ensure that you make the best choice.

HOW AIR COMPRESSORS WORK

Basically, an air compressor uses an electric motor or gasoline combustion engine to power a pump (for safety's sake, gas engines shouldn't be used in the shop). The pump itself, similar to a small engine, has a piston, connecting rod, crankshaft, flywheel, head, and valves.

While running, the pump draws air in through a thin metal valve in the head and compresses it with a piston.



POWER! WHAT AN AIR COMPRESSOR CAN ADD TO YOUR WORKSHOP

Compressed air exits the pump through another valve for storage in the receiver, or tank. This pumping process continues until enough pressure builds up to trip the sensitive pressure switch, which then shuts off the

PISTON-TYPE COMPRESSOR PUMP

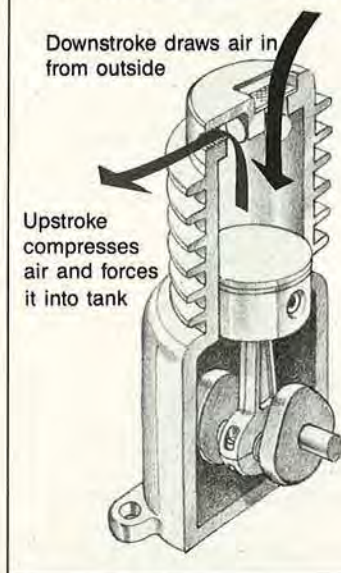

power source. As the air is used up and the supply is depleted, pressure drops and the switch restarts the pump for another cycle.

An air compressor also requires a regulator, mounted on the tank, to control the pressure at which air is delivered to the tool you're using. You can adjust the regulator for more or less pressure as required. A safety valve, also tank-mounted, will open and relieve pressure should a malfunction fail to shut off the compressor motor. All air compressors must have this valve.

Compressor options

If you added another cylinder with a piston to the compressor pump just described, you would have a *twin-cylinder* compressor. It pumps and compresses air twice as fast as one with a single cylinder, but can run on the same size motor. Of course, it also costs more.

Two-stage compressors add another pumping chamber to the process already described. These units take in air and compress it in one pumping cycle, or stage, then further compress it in a second stage to a higher pressure. For practical purposes, a two-stage compressor delivers air at a higher pressure than a single-stage unit, the air supply lasts longer, and the motor won't run as often. Most commercial and industrial compressors are two-stage units.

Direct-drive or "oil-less" compressors operate similarly to a single-stage model, but the motor directly drives the pump without benefit of flywheel and pulley. Because of this arrangement, they have less power and capacity.

WHAT YOU CAN DO WITH A COMPRESSOR

Spray surface finishes

Jim Boelling, our project builder, has switched completely to spraying for surface finishes. Why? "Until now, finishing has always been a real chore. Using the compressor to spray on a fin-

ish is not only fast and easy, it gives a super result because you can control the amount of material being applied and the pattern," Jim says.

That's because an air compressor-powered spray gun emits the finishing material in an extremely fine mist that lays down exceptionally smoothly. Preparing a surface for finishing also becomes a snap with air power. You simply blow the surface clean.

Power pneumatic tools

Nail guns, glue guns, chisels, sanders, screwdrivers, saws, and even routers are available for compressors nowadays. Roger Cliffe, in his cabinet work, uses two air-powered nailers that shoot fasteners from $\frac{3}{4}$ " to $2\frac{1}{2}$ " long for 90 percent of his fastening. Together, the nailers cost more than \$700. "They're fast, they have enough impact that you don't have to drill pilot holes, and they're long-lived," he notes. "You *do* have to oil their seals regularly with a special lubricant or they harden."

According to Cliffe, air tools are insensitive to abuse and dirt—except in the air line itself—and they don't often break down. "When they do, they're inexpensive to fix."

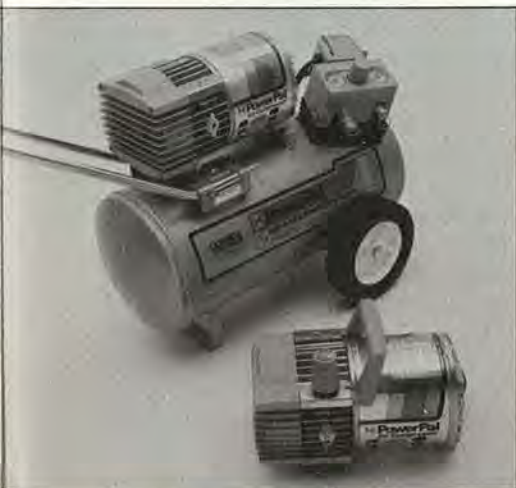

Three popular compressor types. At left, a 1 1/2 hp., single-cylinder compressor does a host of shop chores; it requires regular maintenance. Top, a 3/4 hp. maintenance-free, direct-drive model will spray and power a few air tools. Above, a 1/2 hp. direct-drive compressor with no air storage. For cleanup and light spraying, it must run continuously.



This straight-line pneumatic sander from Sears is lighter than an electric belt sander and produces 3,000 back-and-forth strokes per minute.

Continued

AIR POWER!

Air tools generally weigh less than conventional electric tools, since they use a small, turbine-type motor or air cylinder rather than the metal windings and housing of an electric motor. They won't get hot after prolonged use, or lose power in tough work. However, air tools cost more than a comparable electric tool, and many of them require a large-output commercial compressor.

HOW TO CHOOSE AN AIR COMPRESSOR

Shop for capacity

Home centers, large hardware stores, major retail department stores, and mail-order woodworking tool suppliers all sell air compressors. So do local suppliers to the building and construction industry. You can find businesses specializing in their sales and service in the Yellow Pages under "compressors."

Wherever you decide to buy, shop for *capacity*. Know what air tools you want to use and their compressed-air requirements, then match your needs to a compressor with that capability. Delivery capacity simply means the amount of compressed air the unit will provide, the pressure at which the air gets delivered, and how long that air supply will last during use.

Understand air delivery requirements for different uses

"In choosing an air compressor," advises Nick Antonecchia of Campbell Hausfeld, a manufacturer of air compressors for home use, "have in mind what you want to do with it. Each tool requires a certain air delivery rate stated in cubic feet of air per minute (c.f.m.) at pressures ranging from 40 to 90 pounds per square inch (p.s.i.). Look for an air compressor that fits your tools' needs, in both c.f.m. and p.s.i."

If, for instance, you plan only on doing some spraying and pneumatic fastening, you can get by with a much smaller compressor than if you want to do much sanding, since sanders require a greater amount of air. With too small a compressor, you'll always be playing "catch-up"—waiting for it to build up enough air for you to continue working.

Many manufacturers place a chart

CHOOSE A COMPRESSOR BY THE TOOLS IT CAN POWER							
NOTE: Specifications based on <i>Chargeair Pro</i> compressors by Ingersoll-Rand; others may vary.							
COMPRESSOR SIZE/DELIVERY			All-purpose spray gun	Nail gun	6" dual-action sander	3/8" drill	Straight-line sander
hp.	voltage	c.f.m. at 40/90 p.s.i.					
3/4	115	2.9/2.6	Yes	No	No	No	No
1	115	4.5/4	Yes	Sometimes*	No	Sometimes*	No
1 1/2	115	4.8/5	Yes	Yes	Sometimes*	Yes	No
2	115	6.8/6.1	Yes	Yes	Yes	Yes	No
3	230	10.9/10.6	Yes	Yes	Yes	Yes	Yes

*Adequate for less than constant-use, production-type work.

decal right on their compressors that lists which air tools the compressor will handle.

Horsepower doesn't always tell the story

While home-type electric air compressors (normally 2 hp. and under) carry a motor horsepower rating, the size of the motor isn't as important as the amount of air it will deliver and at what pressure. Because of differences in pump design, two compressors of equal horsepower made by different manufacturers may not have the same air-delivery performance. (Refer to chart, *above*.)

Remember, too, that motors 2 hp. and under normally run on 115 volts; those over 2 hp. (and some 2 hp. models) require 230-volt operation. Your shop wiring could limit your compressor choices.

Air storage—think big!

Henry P. Van Ormer of Compair Kellog, maker of Kellog-American air compressors, suggests that it's also important to buy air-storage capacity. "The homeowner is looking at a choice of 10-, 12-, 20-, 30-gal., and even larger tanks. I'd recommend the largest you can afford, since the cheapest thing you can buy when you're talking air compressors is storage." We've found that a 20-gal. tank proves more than adequate, at least for a portable unit.

Stationary compressors, which you can't easily move around the shop, normally are equipped with larger (and thus heavier) tanks. They also have larger motors—usually 3 hp. or more.

While your storage capacity options

in a portable compressor may be limited at the top end by tank weight, portables get the nod for versatility. If you're going to use a compressor both in and out of the shop, you won't want a heavier tank than you can push or pull with little effort.

Whatever size tank you choose, remember not all like-sized tanks are created equal, however. Better-quality tanks carry a plate that says they meet the code set by the American Society of Mechanical Engineers (ASME). And tanks should have a drain valve so you can empty them of condensation.

WHAT AIR POWER COSTS

Simply put, the more cubic feet of air per minute that a compressor can deliver at a given p.s.i., the more it will cost. You can buy a 3/4 hp. air compressor suitable for spray finishing, non-production fastening, and shop cleaning for under \$200. For one that will handle about any air power chore in the home workshop, you'll pay up to \$600. And commercial, two-stage units that can run pneumatic routers and other high-power air tools start around \$1,000.

Used units occasionally turn up in the classifieds. You can save big this way, buying larger commercial units originally owned by service stations, farms, and auto body shops.

MAINTENANCE GUIDELINES

Compared to many other tools, standard air compressors are reliable and trouble free, if you maintain them. (Oil-less types are totally maintenance free.) This means checking the oil level in the sight glass and cleaning or chang-



Air tools, a woodworking option. Shown above: 1) *Bostich brad tacker*, requires 4.7 c.f.m. at 80 p.s.i. for 100 nails per minute, \$435; 2) *Binks production spray gun*, 6.5 c.f.m. at 40 p.s.i., \$90; 3) *Allied Pneumatic 1/8" air drill*, 4 c.f.m. at 90 p.s.i., \$60; 4) *Rockwell industrial router*, a hungry 50 c.f.m. at 90 p.s.i., \$750; 5) *Powerdyne orbital sander*, 6 c.f.m. at 60 p.s.i., \$30; 6) *Speedaire blower*, all pressures, \$5.

ing the air intake filter. "When you don't, the suction and discharge valves will clog, burn, and have to be replaced," says Russ Morine, a repair specialist at AirMac, a compressor sales and service company in Des Moines.

Roger Cliffe looks at air compressors as if they were cars: "You feed them oil and change filters, then run them until they're due again."

Both Morine and Cliffe agree that moisture which condenses out of compressed air can be a problem. It can ruin a sprayed-on finish or rust a tank. They recommend draining air lines and tank both before and after use, espe-

cially in high humidity. This eliminates oil in the lines, too.

Short air lines with moisture traps at the end of runs help a lot, too, because the hot compressed air won't have as much time to cool off and let the water vapor condense out. When water does collect, it's easily emptied.

WHAT ABOUT NOISE AND HEAT?

An air compressor's on-again, off-again recycling can be bothersome to others, and to you. Cliffe suggests situating a compressor outside the shop, if at all possible, to reduce the noise level. This

also keeps a unit sawdust free.

Morine solves the noise problem by retrofitting even a home compressor with an industrial-type inlet filter/silencer. The cost: about \$20.

Besides creating noise, compressors create heat. In normal operation they may reach over 200 degrees F. Insulated heat shields, found on many compressors, make a sensible feature. Compressors without shields should be placed to reduce the possibility of burns or damage from heat.

AIR COMPRESSOR CAUTIONS

- Wear eye protection when cleaning with compressed air. Harmless wood chips can become shrapnel.
- A compressor constantly running close by could damage hearing, so wear ear plugs or muffs.
- Spray in a well-ventilated area. Keep overspray off surfaces by setting aside a place for finishing.
- Unplug the motor before any maintenance. A drop in pressure could suddenly trigger the unit.

For more information on air compressors for the home workshop, write the following major manufacturers:

- American I.M.C.*, P.O. Box 7582, Charlotte, NC 28217
Atlas Copco Standard Pneumatic, 4070 W. 150th, Cleveland, OH 44135
W.R. Brown, 2701 N. Normandy Ave., Chicago, IL 60635
Campbell Hausfeld, 100 Production Dr., Harrison, OH 45030
Champion Pneumatic Machinery Co., 1301 N. Euclid, Princeton, IL 61356
Dayton Electric Manufacturing Co., 5959 W. Howard St., Chicago, IL 60648
Ingersoll-Rand Co., P.O. Box 241154, Charlotte, NC 28224
Kellog-American Inc., P.O. Box 159, Rt. 125, Kingston, NH 03848-0159
Sanborn Manufacturing Co., P.O. Box 206, Springfield, MN 56087
Sears Roebuck & Co., Sears Tower, Chicago, IL 60684
Sofragraf Unifix Inc., 2520 Electronic Lane, Suite 804, Dallas, TX 75220
Thomas Industries, Inc., Power Air Division, 1419 Illinois Ave., P.O. Box 29, Sheboygan, WI 53082-0029
Total Shop, P.O. Box 16297, Greenville, SC 29606

Written with Gregory C. Erickson
 Photographs: Bill Kern; Hopkins Associates;
 Perry Struse
 Illustration: Jim Stevenson

5 STRATEGIES TO MAKE

Ready to set up a shop of your own—if you could find the space? Or maybe you have a small shop that seems to be getting smaller as your woodworking expands. Whatever situation you find yourself in, here's help. We mapped out three typical small-space shops, then came up with surefire strategies to beat the space squeeze.

1 CHOOSE YOUR TOOLS THOUGHTFULLY

Which tools do you have to have? Admittedly, in tight quarters your options are limited. Thousands of craftsmen in such situations turn to a multi-purpose tool that saws, drills, bores, turns, and sands.

The other approach is task-oriented tools. Here's where you must focus and select the stationary power tools you *really* need to do the work you want to do. Perhaps a table saw, or radial arm, and some portable power and hand tools will fill the bill. But most of us either have—or would like to have—a greater selection. Our model shop layouts on the following spread indicate how you can fit them in.

How do you choose? Look at what the tool can do for you. A band saw, for instance, cuts thicker stock faster and makes smoother curves than a scroll saw. A scroll saw cuts a tighter curve, can remove the center from a pattern, and the blades cost less.

Have you ever considered what you can do with a power miterbox? This tool solves the problem of how to cut off long stock in short spaces where the table saw would be hindered. A radial arm does that, too, but it takes up more than its share of space in a shop that already has a table saw. The power miterbox, on the other hand, is space efficient.

No matter which tools you elect to have in your shop, keep their quality in mind. You can't do first-rate work with second-rate tools, or those not designed for the job.



2 MAKE YOUR EQUIPMENT DO DOUBLE DUTY

A workbench acts as the hub of any workshop. For small spaces, select a workbench 4' to 5' long and 24" wide. If you make it the same height as your table saw top, it can also support sheet goods when ripping. In our drawing, *top right*, we added storage for portable power tools and bins for supplies below a table-type bench.

A good-quality 8" or 9" table saw, properly adjusted and fitted with a sharp carbide-tipped blade,

can cut accurately enough to do much jointer work. For an extension, equip it with a plastic laminate-covered plywood router table. Also consider making a lift-off top, as shown, *top far right*, and you have extra bench space.

Too cramped for a table saw? Opt for a radial arm against a wall, as in our long, narrow shop plan. With a little cabinet work, you can transform the space it occupies into a real work center, with bench and storage above and below (see the drawing, *above right*).

SMALL SHOPS WORK BIG!

DOUBLE-DUTY IDEAS

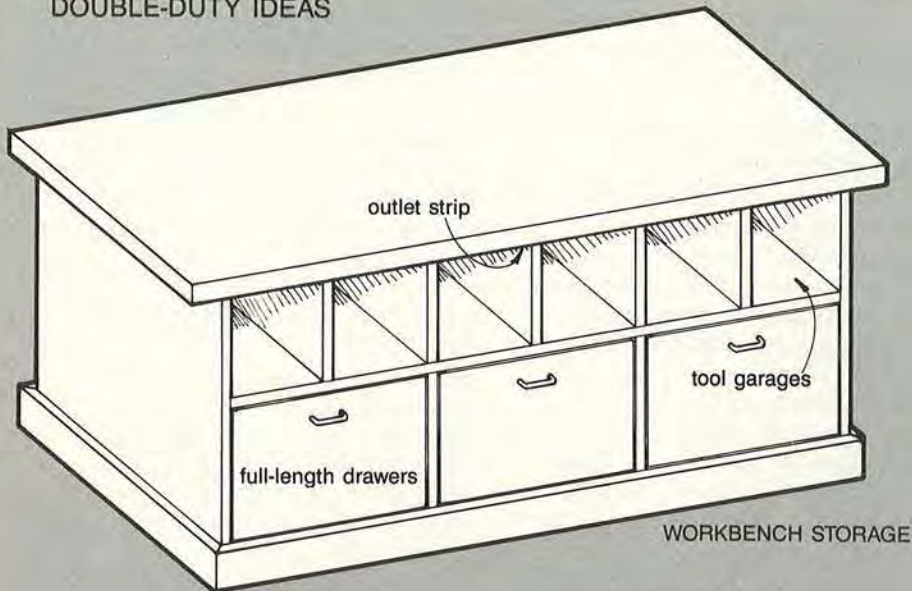
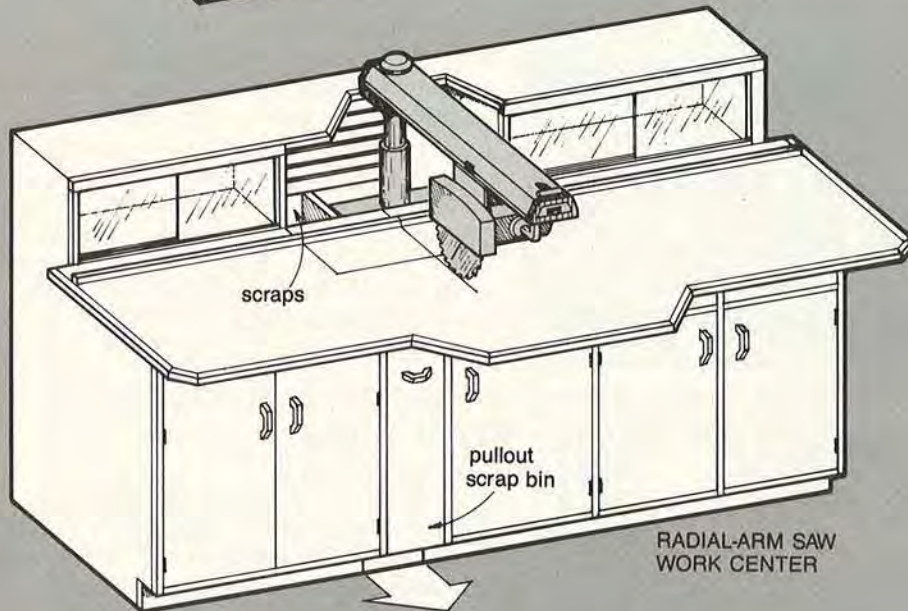
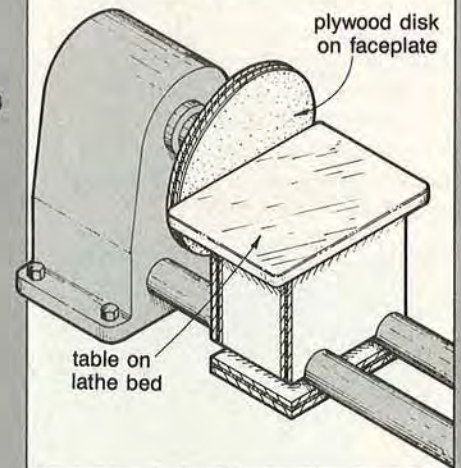

TABLE-SAW EXTENSION AND CAP



DISK-SANDER TABLE



The drill press, considered essential in many shops, easily fits into a corner. If you have a floor model, fit it with a plywood table and use an accessory drum sander for maximum versatility.

Lathes can do double duty, too. Attach a table to the bed, mount a sanding disk to the head stock, and you'll have a two-in-one tool. You can even call on the lathe stand for needed support when cutting long stock on the miterbox, as in our basement shop plan on the following page, by slipping in a "stool"

under the stock to gain height. Our close-up view, *above right*, shows the customized lathe.

A note about lighting: Use 4' or 8' 80-watt fluorescent fixtures or 150-watt bulbs on a separate lighting circuit. Check for proper intensity by setting a block of wood at different places around the shop—if it doesn't cast a shadow, your lighting is bright enough. Paint, too, brightens a small shop situation. Paint all walls, and even the ceiling where possible, stark white. It makes the room seem larger.

3 PLAN YOUR WORK IN STAGES

In small shops you can't afford clutter. Organize your work into stages, or steps, and cleanup after each session so there's enough room to get each step completed. Here's how it's done:

Step 1. Rip and cut off stock into manageable parts, so you won't have to handle large pieces in the middle of the project.

Step 2. Complete cuts, joinery, and assembly necessary for all sub-assemblies.

Continued

MAKE SMALL SHOPS WORK BIG!

Step 3. Use your assembly bench to join the sub-assemblies.

Step 4. Apply finish in the assembly area, but use only those finishes in the shop that don't require a dust-free atmosphere. Spray outside or in a separate area.

4 KEEP MATERIAL NEATLY AT HAND

Boards and other long stock such as molding should nestle against the ceiling or along a wall. You can make a simple overhead rack of 2x4s, then hang it from the rafters. On the wall, use shelf brackets.

You have two ways to go with 4x8' plywood panels. To take up the least amount of floor space, stand them on end, if you have enough head room. This works well in a garage.

You can also store plywood on edge behind a partition, but this requires one end of the space adjacent to a doorway for access, such as in our basement shop plan.

Another alternative is the fold-down sheet-goods rack shown in the drawing, *right*; it allows you to remove panels from the front. This is a real space-saver. It's used in our long, narrow shop layout.

Then, there's always the garage if you lack space. Use a portable circular saw to rip sheets before moving them to your shop.

5 GO FOR EFFICIENT SHOP LAYOUT

Just as in your kitchen, getting things done efficiently depends largely on shop layout. Where you position your equipment determines how workable your shop will be, and how comfortable it will be.

Situate your stationary power tools according to your working patterns, and the shape of the space. Do allow for certain minimum passageways and areas. For guidelines, we figure on 18" to 24" walkways between benches and

machinery or between stationary tools. To work between benches and equipment, rather than just walk, you need 30" to 36".

At the bottom of this page and on the next page are workable, efficient shops in three typical configurations—one of which may be just like the space you have or want to create.

MAKE YOUR STRATEGIES PAY OFF

By combining your tools with an efficient plan, you can make your small space shop work big, as the three examples show. If you're fortunate enough to already have a big shop, you'll find that adopting some of our ideas can help you, too.

Have an idea of your own on how to make small space work better? Jot it down and send it to us! Include a snapshot or sketch to help explain, if you like. We'll pay you \$25 if we publish your idea. Sorry, your material cannot be returned unless you enclose a self-addressed, stamped envelope. **Send your ideas to:** Small-Space Shop Strategies, Better Homes & Gardens® WOOD Magazine, Locust at 17th, Des Moines, IA 50336.

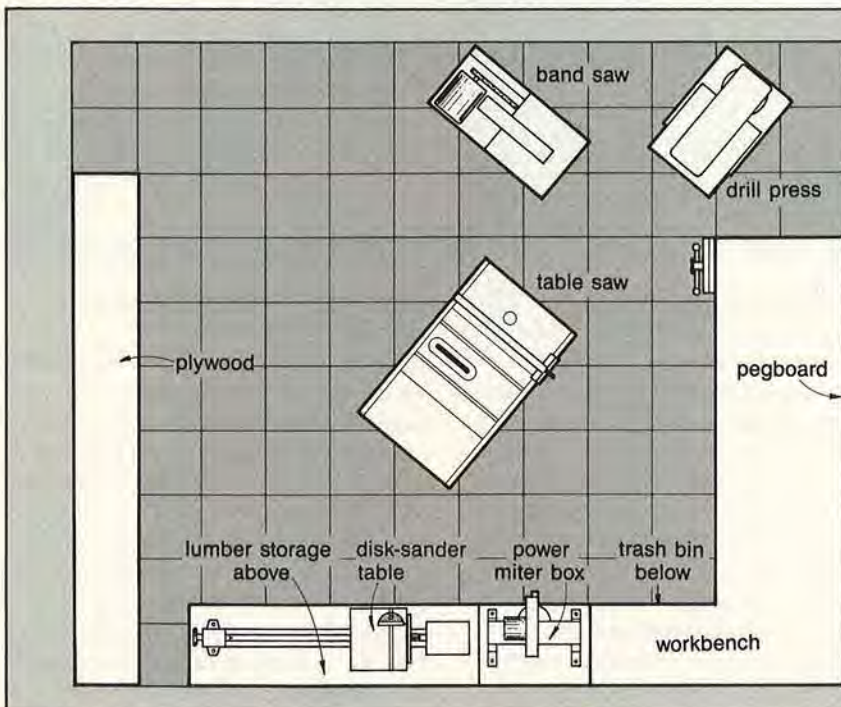
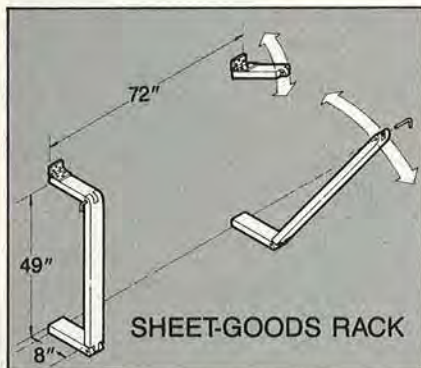

● TYPICAL 10x12' BASEMENT SHOP

A table saw centered in the room at a diagonal accommodates long ripping chores. If you cap the saw with a lift-off table, you add a centralized assembly bench.

Note how the power miterbox nestles on the end of the L-shaped workbench to leave plenty of room for cutoff. You can even use a "stool" on the lathe bed for extra support of long pieces. Tucked out of the way under the bench next to the miterbox is a trash bin. Above and below the bench there's storage for tools and supplies. For ripping support, the bench is the same height as the table saw.

Across the room, the drill press and band saw are set diagonally to allow clearance for workpieces.

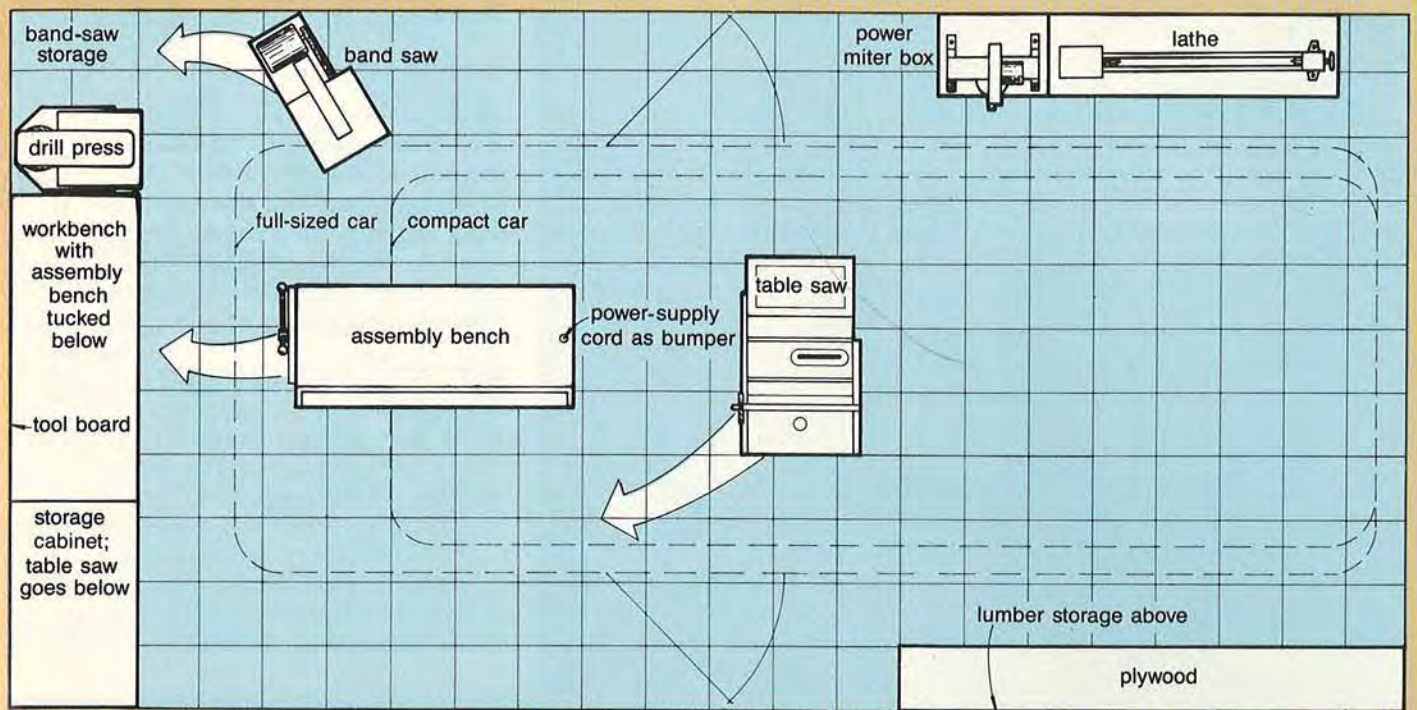

● **THE 11×22' GARAGE SHOP**

This space could be in a single-car garage or in one-half of a double garage. In either case, we've assumed you have to share space with a vehicle. Here mobility plays a prominent role.

Casters on the table saw, band saw, and the assembly bench allow

you to easily push them out of the way. Since concrete floors tend to be uneven, use heavy, wide casters equipped with locking devices.

At the back of the garage, ahead of the parking area, you'll see the permanent part of the shop. An electrical cord with a rubber-clad outlet hangs from the rafters as a

reminder of where to park. It nudges the windshield when it's time to stop, and provides electricity to the assembly bench.

We kept the height of the assembly bench the same as the table saw for panel support while ripping. When you're not using the bench, it tucks away beneath the other.

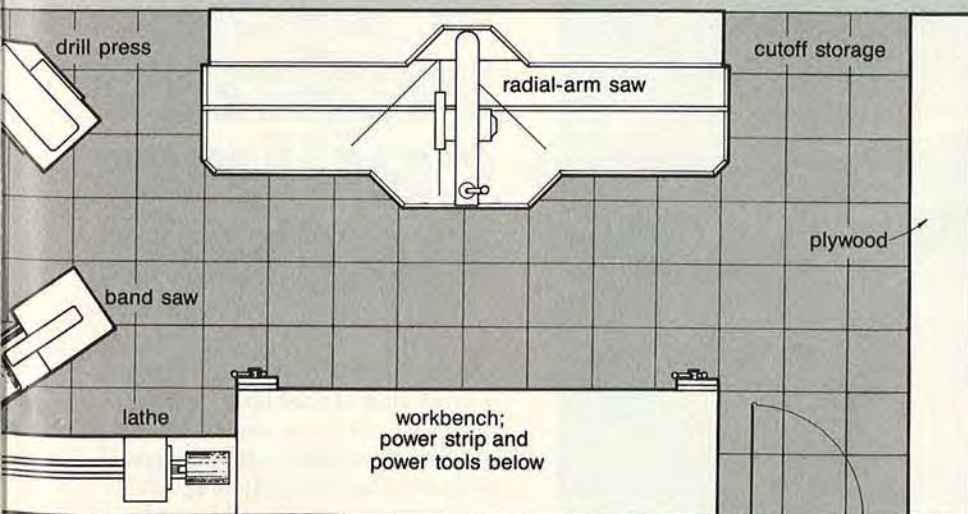

● **THE 8×16' LONG, NARROW SHOP**

Because this type of space lacks the all-around clearance a table saw needs, we chose a radial arm and tucked it against a wall in its own work center. Now, workpieces run the length of the room for cutoff; the blade changes direction for rip and miter operations.

Convenient to the saw, the workbench is just a few steps across the room. Tools hang over it and other tools and supplies go below.

The lathe fits nicely in a corner at one end of the bench. Sheets go on edge in a fold-down rack. ♣

Illustrations: Jim Stevenson; Bill Zaun

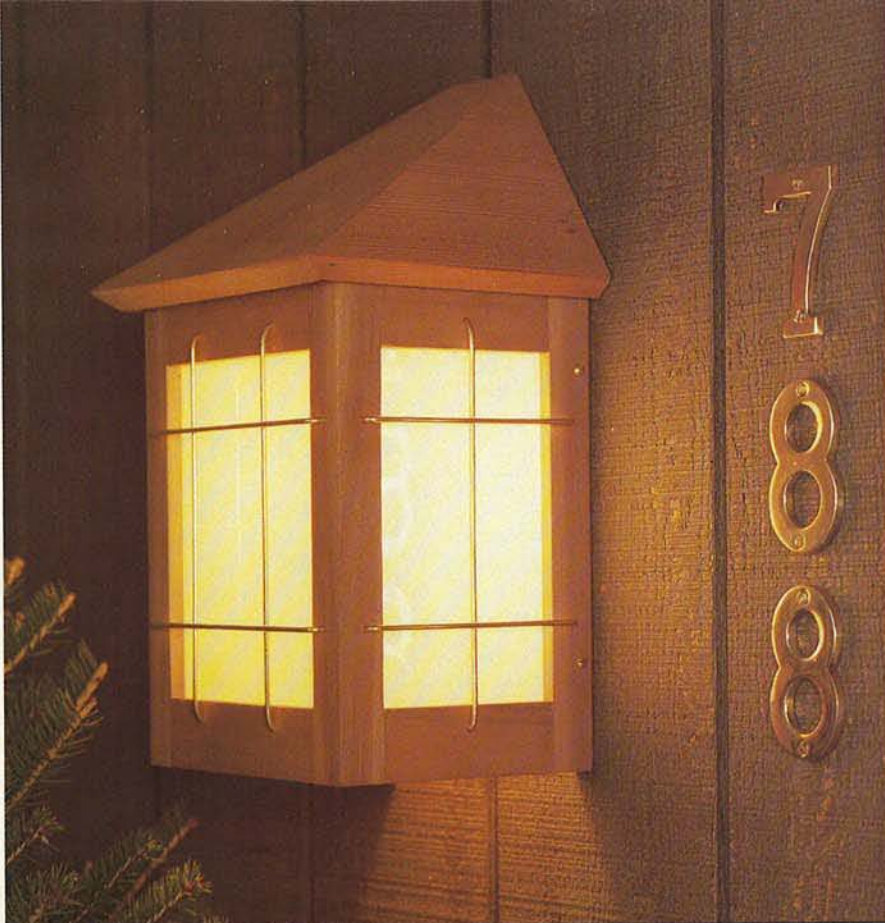

The Old Lamplighter **REDWOOD LANTERN**

 Print this article

An exterior light fixture must not only look distinctive—it also has to withstand the elements. We think this appealing fixture of redwood, brass, and acrylic fits the bill on both counts. Build one or a pair for your entry or patio.

BUILDING THE LANTERN CARCASS

1 Rip, then crosscut the stiles (A), rails (B, C), and mounting-frame members (D, E) to the sizes listed in the Bill of Materials. Letter each piece for future ease in assembling.

2 With a table saw and dado blade or a table-mounted router fitted

2 Bright Ideas

Nifty Light Cover-Ups from Our Shop



3-tier walnut ceiling fixture

You won't find another lighting project that stacks up as handsomely as this one does. It's simply three mitered walnut frames joined to white acrylic and a mounting frame.

BAND-CLAMPING THE CARCASS

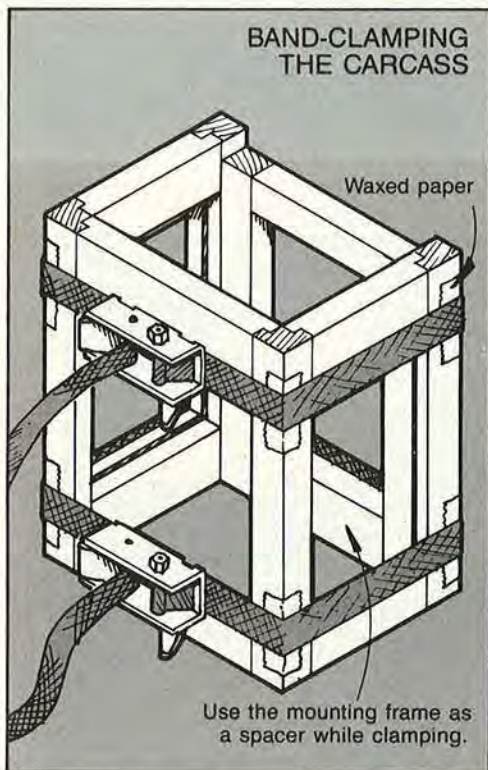

with a $\frac{3}{8}$ " rabbeting bit, cut $\frac{3}{8}$ " rabbets $\frac{1}{4}$ " deep along one edge of the stiles (A) and rails (B, C). Turn the rails (B, C) over, and cut the same-sized rabbets on both ends. Test-fit the rails and stiles together; adjust the rabbet depth if necessary so the faces are flush. (We cut the rabbets along the edges of the stiles and rails on a table saw fitted with a dado blade and an auxiliary wood fence. We then switched to a miter gauge when rabbeting the ends of the rails.)

3 Individually glue and clamp the two side frames (A-B), the front frame (A-C), and the mounting frame (D-E) together. Remove excess glue after it forms a tough skin. After the glue dries, sand the frame smooth.

4 Set your table-saw blade at 45° and bevel-rip both edges of the front frame and the front edge of

each of the side frames, as shown in the Exploded-View Drawing on p. 61.

5 Glue and clamp the front and side frames together, as shown in the Band-Clamping Drawing, *left*, using waxed paper to keep the glue from sticking to the band clamps. [We used the mounting frame (D-E) as a spacer; it's *not* glued in place.]

CONSTRUCTING THE ROOF

Note: You've probably already learned that cutting compound angles can be confusing. To guarantee a tight fit, read the instructions and study the drawings carefully, then make test cuts in scrap before sawing into your redwood stock.

1 Lay out and mark the angles and notches on the redwood roof supports (F, G) as dimensioned in the drawing on the next page, then cut F and G to shape, as shown.

Continued on next page

Ready to scrap that old fixture for something better? Then shed some new light on the subject with these two clever cover-ups—a traditional redwood lantern for outside and a contemporary walnut fixture for inside. Each is guaranteed to add a new glow to your home.

BUILDING THE WALNUT FRAMES

Note: We designed this fixture to cover up a round fluorescent light fixture. Measure your existing fixture and adapt our dimensions to fit your light if necessary.

1 Resaw $\frac{1}{2}$ " stock from $\frac{3}{4}$ " walnut stock. Rip 12 frame members (A) to width and crosscut them to $17\frac{1}{4}$ " long from the $\frac{1}{2}$ " stock. Miter-cut all frame members, as shown in the Frame-Member Drawing, to a finished length of $16\frac{1}{8}$ ". (We cut scrap material first to ensure an accurate 45° miter.)

2 Using miter clamps as shown in the photo, *right*, glue and clamp the three walnut-frame assemblies together. Sand the mitered joints

smooth and rout a $\frac{1}{4}$ " round-over on all outside edges.

3 Finish-sand the three frame assemblies and finish with several coats of polyurethane.



Note: If you plan to use the cover-up over an incandescent or other high-heat generating light, cut ventilation slots. Start by marking their position, then drill $\frac{1}{4}$ " holes at each end of the marked slots. Use a router with a $\frac{1}{4}$ " straight bit to rout the acrylic between the drilled holes. You'll also need at least 1" clearance between the incandescent bulb and the bottom acrylic panel (C). To meet the 1" requirement, cut the acrylic panels (B) wider.

ASSEMBLING THE COVER-UP

1 Using a table saw fitted with a sharp blade, preferably carbide, cut the acrylic side panels (B) to size plus $\frac{1}{32}$ " to $\frac{1}{16}$ " in width and length. With a sanding block, hand-sand

Continued on page 62

REDWOOD LANTERN

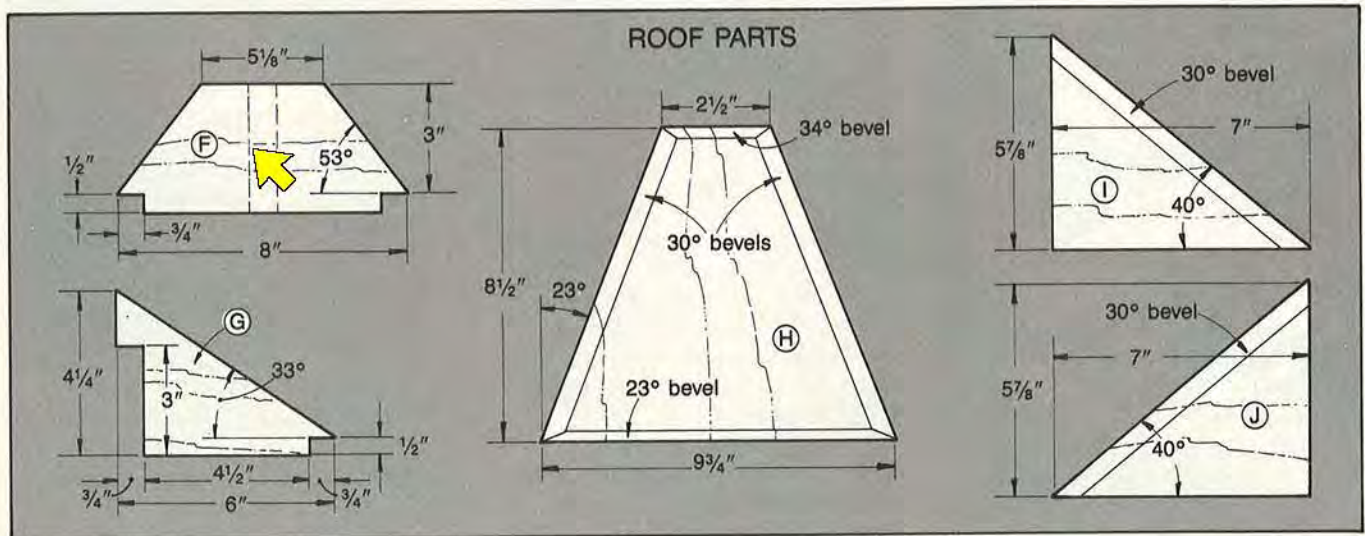

Cutting Diagram *Note: We edge joined pieces to obtain the necessary width.

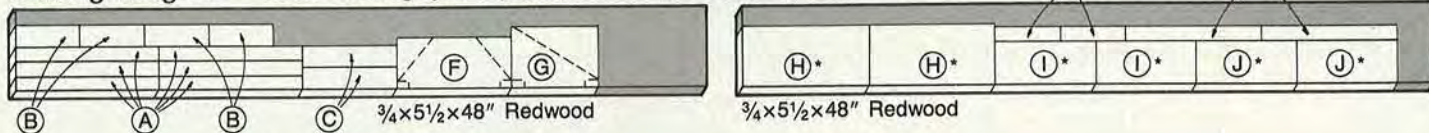

2 Glue F and G together, then glue and nail this assembly to the carcass with 1" brads. (We dulled the points of our brads to prevent them from splitting the grain when driven into place.)

3 Rip and crosscut enough stock to glue up the front roof section (H), then edge-join the pieces, and trim H to $9\frac{3}{4} \times 8\frac{1}{2}$ ". Bevel-cut the bottom of H at 23° , then bevel-cut the top at 34° , as shown in the Roof-Parts Drawing.

4 Mark the location of the two required cuts on both sides of H. Using the saw setup shown, *right*, position the miter gauge in the right-hand slot. With the already-cut end bevels facing down, cut one side of H.

Move the miter gauge to the left-hand slot and, with the end bevels facing up, cut the other side of H as indicated.

5 To form the side roof sections (I, J), rip, then crosscut a piece of redwood stock to 7×15 ". Using the saw setup shown in the drawing, *far right*, bevel-cut one I and one J.

6 Test-fit the roof assembly (H-I-J) over the lantern carcass and make adjustment cuts as necessary. Spread glue on the surfaces to be joined and hold the roof assembly together with masking tape until the glue dries. (Masking tape works well when clamping irregular surfaces and other clamps just won't do. Use wide masking tape and make sure the two surfaces to be taped are clean for good adhesion.)

7 Drill pilot holes through the roof assembly, then use 4d finishing nails and glue to attach the roof assembly to the carcass. (When drilling pilot holes for nails, cut the head off of the size nail you intend to use. Tighten the nail in the

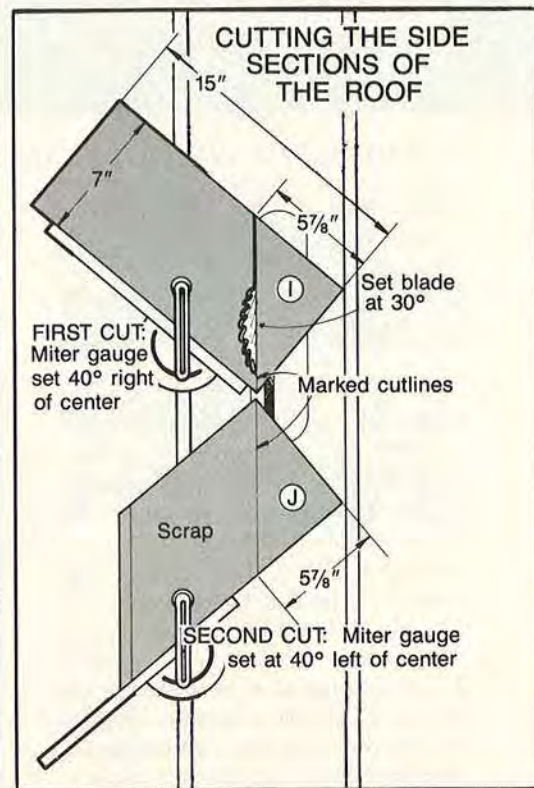

2 Bright Ideas

Nifty Light Cover-Ups from Our Shop

Bill of Materials					
Part	Finished Size*			Material	Qty.
	T	W	L		
A	3/4"	1"	10"	redwood	6
B	3/4"	1 1/2"	4 1/2"	redwood	4
C	3/4"	1 1/2"	6 1/2"	redwood	2
D	3/4"	1"	9 1/2"	redwood	2
E	3/4"	1 1/2"	4 1/2"	redwood	2
F*	3/4"	3"	8"	redwood	1
G*	3/4"	4 1/4"	6"	redwood	1
H*	3/4"	9 3/4"	8 1/2"	redwood	1
I*	3/4"	5 7/8"	7"	redwood	1
J*	3/4"	5 7/8"	7"	redwood	1
K	1/8"	4 7/16"	7 1/16"	acrylic	2
L	1/8"	6 7/16"	7 1/16"	acrylic	1

*Some parts are cut larger initially, then trimmed to finished size. Please read the instructions before cutting.

Supplies: 1/8" bronze brazing rod (4 pieces 9" long, 2 pieces 8" long, 4 pieces 6" long) from your local auto parts store or welding shop, #8x1 1/2" roundhead wood screws, 1" brads, 1 1/2" brads, glazier's push points, wood filler, finish

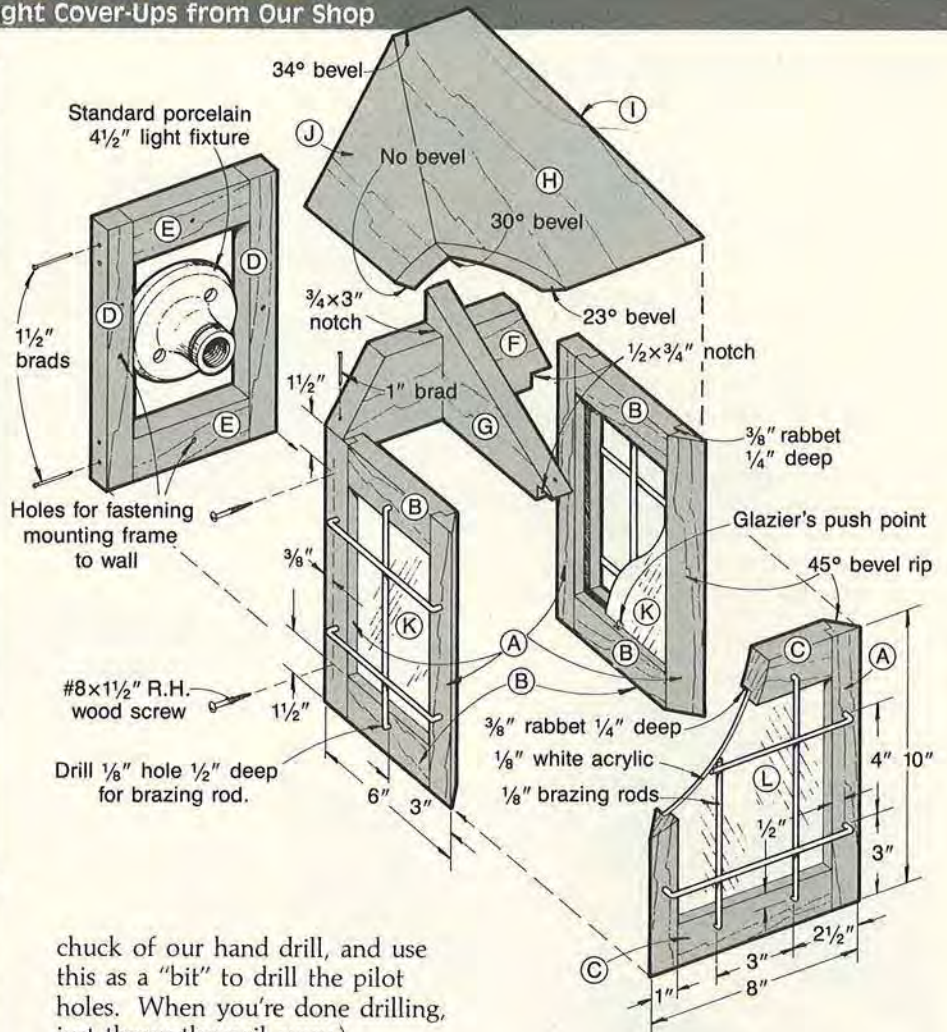

CUTTING THE FRONT SECTION OF THE ROOF

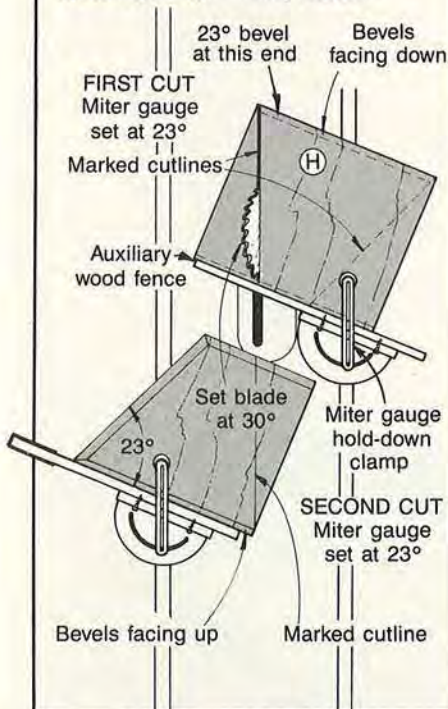

chunk of our hand drill, and use this as a "bit" to drill the pilot holes. When you're done drilling, just throw the nail away.)

FINISHING TOUCHES AND INSTALLATION

1 Set all nails and fill the holes. Sand the completed lantern. If you want to prevent the redwood from graying with age, apply an exterior finish or clear waterproofing.

2 Cut the bronze brazing rods to size, as indicated in the supplies list. With a locking-grip pliers or a metal vise, bend 1/2" of each rod end at a 90° angle. Using the bent rods as guides, mark the location of the mounting holes on the carcass (see the Exploded-View Drawing for positioning the rods). With a drill and an 1/8" bit, drill the mounting holes 1/2" deep. Put a drop of epoxy in each hole and install the rods.

3 Using the table saw and a sharp blade, preferably carbide tipped, cut the 1/8"-acrylic panels (K, L) to size. Install glazier's push points to hold the acrylic panels in the rabbets.

4 Clamp the mounting frame (D-E) inside the lantern. Drill 1/8" pilot holes through the lantern and into the mounting frame. Remove the mounting frame for the lantern. Drill 1/8" pilot holes through the frame, and attach it to the siding over the light fixture. Now, fasten the lantern to the mounting frame, switch on the lights, and step back and admire your work.

Project Design: David Ashe, Workshop Blueprint Co.

Photographs: Hopkins Associates

Illustrations: Bill Zaun; Randall Foshee

2 Bright Ideas

Nifty Light Cover-Ups from Our Shop

Walnut Ceiling Fixture

Continued from page 59

the panels to the finished size as indicated in the Bill of Materials. (Acrylic chips slightly when sawn, and a power sander tends to melt the edges. That's why we cut the panels slightly oversized and used a sanding block.)

2 Referring to the Acrylic-Side Drawing as a guide, mark the location of the screw holes that you will use to fasten the acrylic to the walnut frames. (We used a grease pencil so we wouldn't mar or stain the acrylic.) With a sharp brad-point bit, drill the $\frac{1}{8}$ " holes.

3 From $\frac{3}{4}$ " scrap, cut eight 1×13 " spacers. Lay one of the frame assemblies on a flat surface, and set four spacers on top of it. Stack the

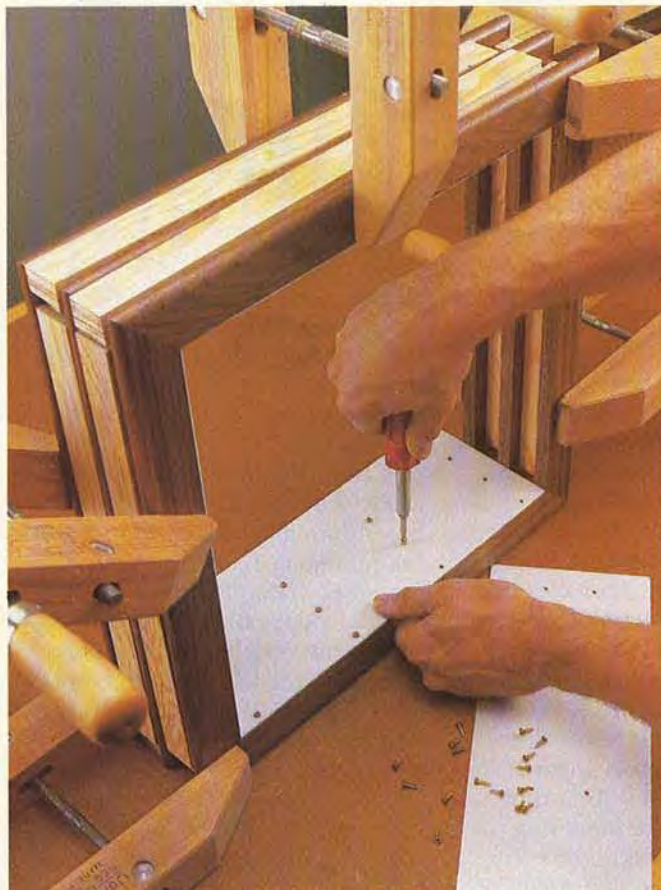
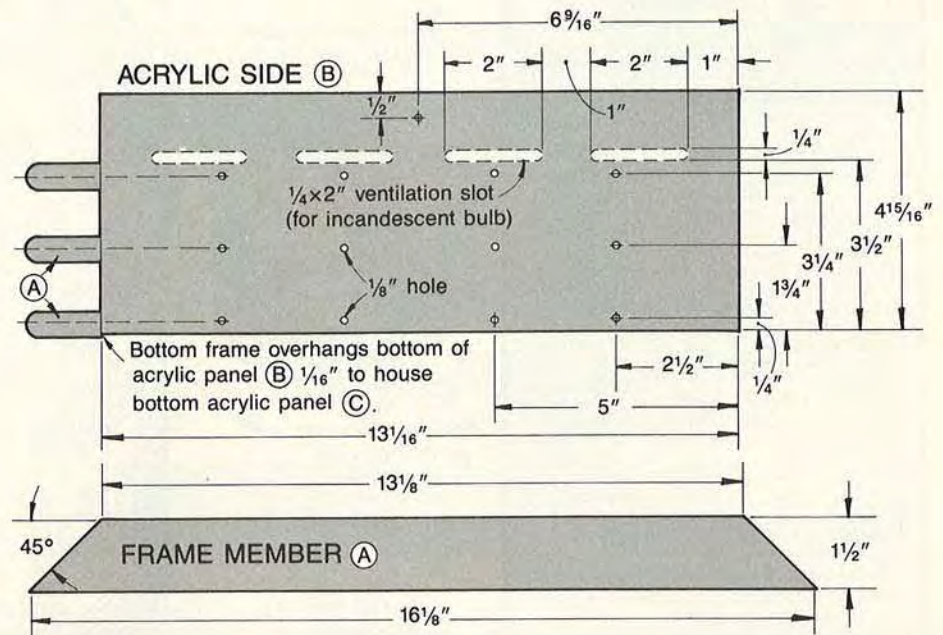

Bill of Materials

Part	Finished Size*			Material	Qty.
	T	W	L		
A*	1/2"	1 1/2"	16 1/8"	walnut	12
B*	1/16"	4 15/16"	13 1/16"	acrylic	4
C*	1/16"	13 1/8"	13 1/8"	acrylic	1
D	1/2"	1"	13"	walnut	4

*Some parts are cut larger initially, then trimmed to finished size. Please read the instructions before cutting.

Supplies: #4 x 3/8" roundhead brass wood screws, finish, solvent for cementing acrylic (available at stores selling acrylic) or epoxy, screws or toggle bolts to attach mounting frame to the ceiling

additional frames and spacers atop the first, and clamp the entire assembly together as shown in the photo, *far left*.

One at a time, position and screw the side panels (B) to the frames as shown in the photo. Position the acrylic panels to leave 1/16" of the bottom frame exposed to accommodate the bottom panel (C), as shown in the Acrylic-Side Drawing.

4 Cut the bottom acrylic panel (C) slightly oversized and hand-sand the edges for a snug fit inside the bottom frame. Once it fits correctly, use masking tape to secure it in place. Tape the entire length of all four edges of the bottom panel to the bottom frame. This will hold the pieces tightly together for fusing with the acrylic solvent in the next step and prevent the solvent from seeping through.

5 To bond the bottom panel in place, apply acrylic solvent with a syringe to the mating edges, as shown in the photo, *left*. (The solvent temporarily melts the acrylic, fusing the adjoining edges. Beware of drips, which create small depressions in the acrylic. While we used the solvent, epoxy would also work.) Wait about 15 minutes before removing the tape from the acrylic panel and walnut frame.

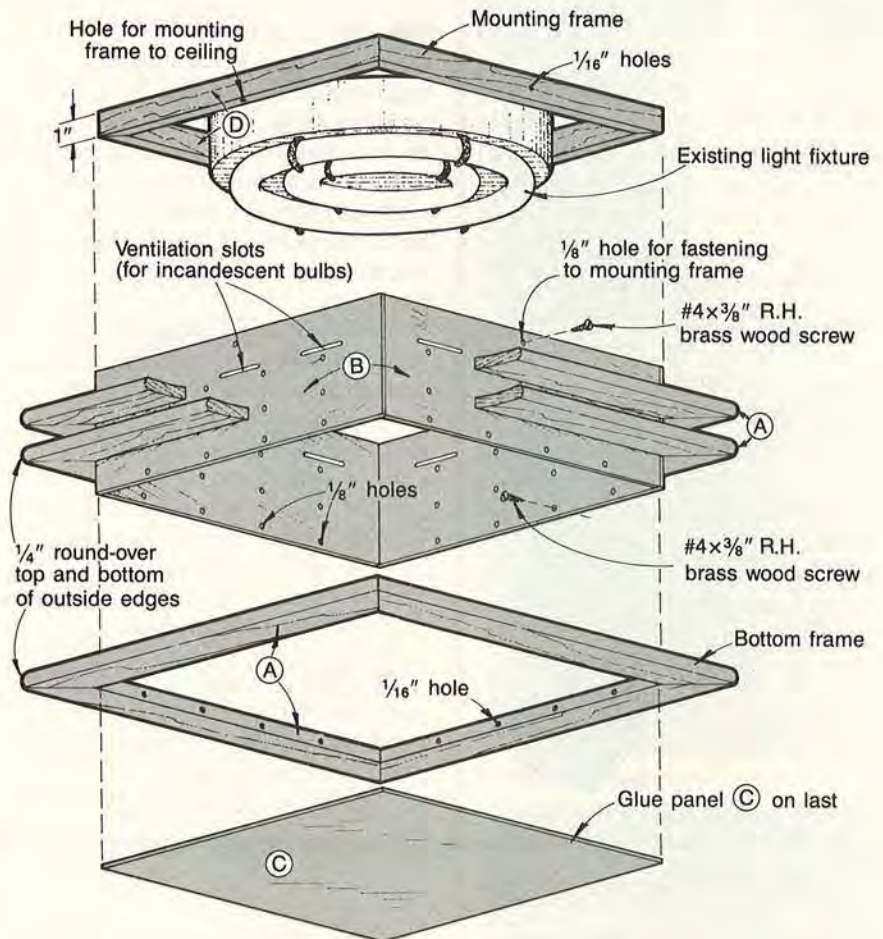

6 Rip and miter-cut the mounting-frame members (D) to size as listed in the Bill of Materials. Glue and clamp the mounting frame together, checking for square. (We again used the four miter clamps to hold the frame pieces together.)

7 Sand and, if necessary, plane the mounting-frame joints flush and check for a good fit inside the cover-up. (The mounting frame should fit inside the cover-up without forcing the acrylic apart. Our mounting frame was a bit too large to fit inside the cover-up. We set the jointer for a very shallow cut and jointed the frame to the correct size.) Mark and drill the holes for attaching the cover-up to

the mounting frame; then mark and drill the holes for fastening the mounting frame to the ceiling.

8 Using screws (if you can hit ceiling joists) or toggle bolts (for dry-wall), fasten the mounting frame to the ceiling. Attach the cover-up to the mounting frame with #4 x 3/8" roundhead wood screws. (The walnut and acrylic cover-up can be easily taken off the mounting frame by loosening both #4 screws to replace light bulbs or for cleaning.) Stand back, flip the switch, and enjoy a revitalized light that didn't cost an arm and a leg. 🌟

Project Design: James Downing
Photographs: Hopkins Associates
Illustrations: Bill Zaun; Randall Foshee

4

THE MULTI-MACHINE, PART II GREAT ACCESSORIES

 Print this article

In the February, 1986 issue of *WOOD* (p. 40), we presented the plans for our amazing multi-machine. The multi-machine's variable speeds and arbor shaft adapt to a host of workshop tasks. Add the sanding table, chuck, sharpening stones, and guards described here, and you've created your own mini-shop in one versatile homemade tool.

P.S. If you missed the article in our February issue, write us at 1716 Locust St., Des Moines, IA 50336—we'll see that you receive a copy of the multi-machine plans.



Vertical-table drum sander

Simplify sanding of concave surfaces with our variable-speed multi-machine and this detachable sanding table and drum. Mounted to the cabinet, the sanding table provides a firm base for sanding and supports the piece being sanded square (90°) with the sanding drum.

- 1 Lay out the 16"-diameter circle on a piece of particleboard to form the sanding table (A). Using the same centerpoint, mark a 3" diameter hole in the center of the circle. Cut along both marks to shape the table. Sand cut edges smooth.
- 2 Apply plastic laminate to both faces of A. Trim the edges of the laminate flush. Drill a hole through to the center hole on both sides; then trim the laminate flush.
- 3 Cut two pieces of 3/4" particleboard to 8×11". Glue and clamp them together with the edges flush. Using the dimensions in the Exploded-View Drawing, lay out

and mark the shape of the supports (B). (The radiuses match those of A, and the 12° bevels match those of the cabinet sides.) Cut B to shape.

4 Clamp the support (B) onto the sanding table. Drill pilot holes, and fasten the two together with four #8×2" wood screws.

5 Drill two 3/8" holes through the cabinet side, where dimensioned in the drawing.

6 Mount the sanding drum onto the right-hand threaded end of the shaft. Center the sanding table (A, B) over the sanding drum. From the inside of the cabinet, transfer the location of the two 3/8" holes already drilled in the cabinet side onto the sanding table. Drill the two 3/8" holes through the table.

7 Mask the laminate and paint the exposed particleboard to match the cabinet. Let the paint dry. Fasten the sanding table to the cabinet with two 3/8×3" flathead machine screws, and two 3/8" T-nuts on the inside of the cabinet.

Wet-sharpening wheel

This nifty attachment allows you to put a sharp edge on chisels, plane irons, and other cutting tools quickly—without fear of ruining the temper of the steel. Just set your multi-machine on its lowest speed, and add water to the plastic trough to keep the steel cool while the abrasive wheel is doing its work.

1 Using the Side-View Drawing as a guide, mark the shape of the main support (A). Cut the support to shape. Drill the two 1/4" holes for the tool rest supports (C) and drill the 1" hole for the arbor shaft. Cut the two supports (B) to size and glue and clamp them to the back side of the main support.

2 To make the tool rests (C), start by bevel-ripping a piece of 3/4" pine 2 1/2" wide and 10" long. Round-

over the opposite edges, and cut the two C's to length. Drill a 1/4" hole lengthwise through each. The tool rests allow you to stand in front of the cabinet and sharpen with the wheel turning towards you or stand behind it and sharpen with the wheel turning away from you.

3 Using a tin snips, cut a piece of sheet metal (D) to the size listed in the Bill of Materials. Fold over the top and bottom edges as shown in the drawings. Bend the bottom to hold and support the water tray.

4 Paint parts A, B, and C. Fasten the tool rests and sheet metal (D) to the main support, and slip this assembly (A-B-C-D) over the arbor shaft. Drill a 5/16" hole down through each B and the top of the cabinet. Attach the assembly to the cabinet with two 1/4×1 1/2" machine screws and 1/4" T-nuts.

5 Fasten the sharpening wheel to the arbor shaft, and attach the water tray to the main support. We epoxied a spacer strip (E) to the water tray to hold it level. Fill the tray, soak the stone, and you're ready to sharpen.

Bill of Materials					
Part	Finished Size			Material	Qty.
	T	W	L		
A	3/4"	3 3/4"	8"	pine	1
B	3/4"	1 1/8"	1 1/2"	pine	2
C	3/4"	1 1/2"	2 1/2"	pine	2
D	20 gauge	2"	8 1/4"	sheet metal	1
E	1/4"	3/4"	6"	pine	1

Supplies: 2—1/4×1 1/2" roundhead machine screws, 2—1/4" T-nuts, 2—1/4" wing nuts, 2—1/4" lock washers, 4—1/4" flat washers, 3—#6×1 1/2" sheet metal screws, 2—1/4×3 1/2" roundhead machine screws, 1" wide × 6" diameter sharpening wheel (fine grit)

THAT ADD VERSATILITY

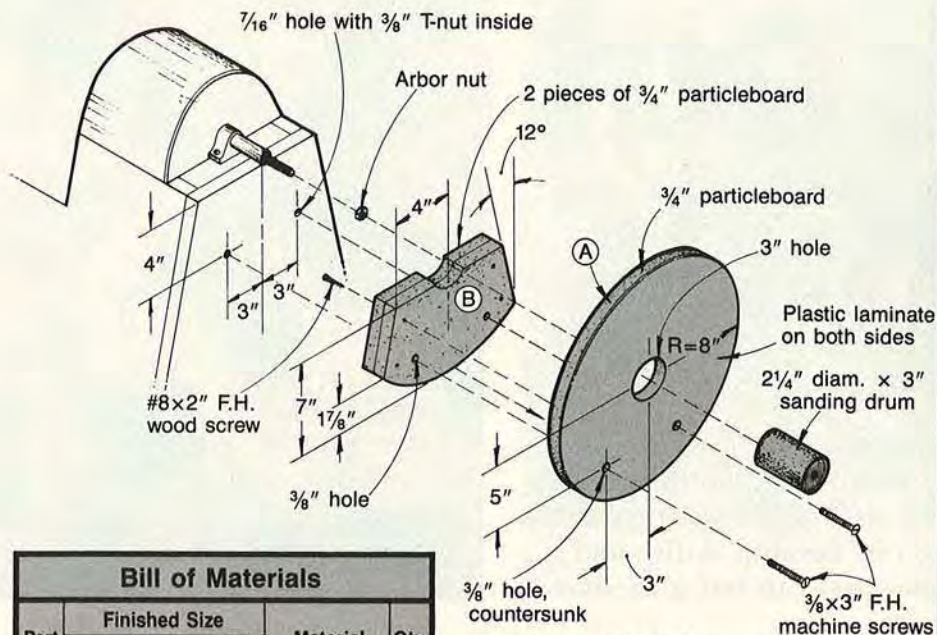

Bill of Materials

Part	Finished Size			Material	Qty.
	T	W	L		
A	3/4"	16" diam.		particleboard	1
B	3/4"	7"	10 3/8"	particleboard	2

Supplies: plastic laminate, paint, 4—#8x2" flathead wood screws, 2—3/8x3" flathead machine screws, contact cement

BUYING GUIDE

● **Sanding drum.** 2 1/4" diameter, 3" face, for 1/2-20 threaded ends. Sears catalog no. 9GT25246, \$9.49. Sanding sleeves: 9GT2522, fine grit; 9GT25222, medium grit; 9GT25223, coarse grit; \$1.29 each from Sears.



Vertical-table drum sander



Wet-sharpening wheel

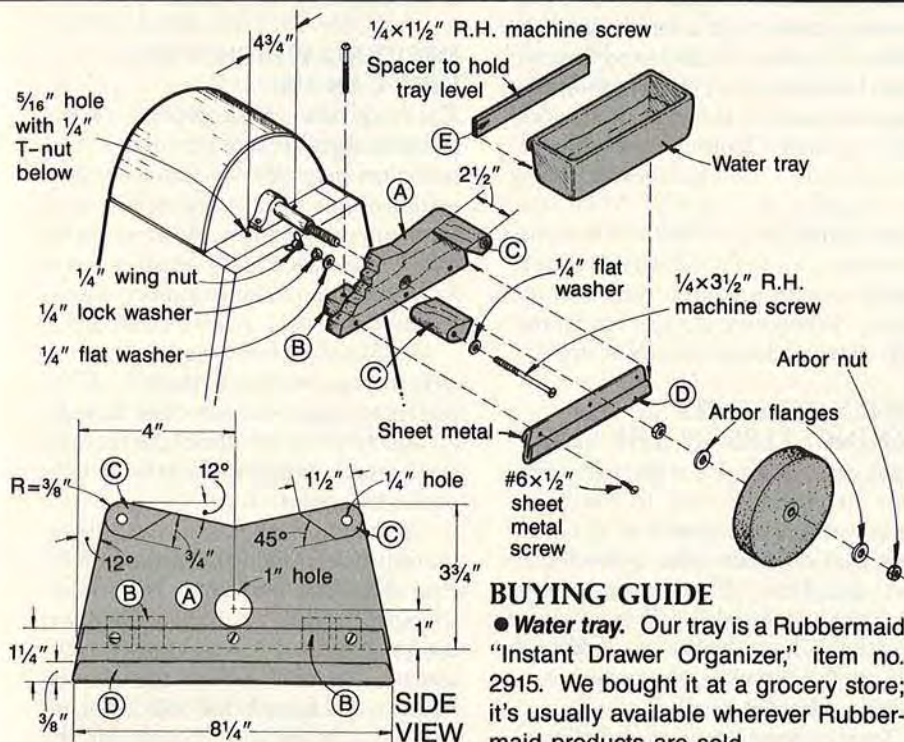

BUYING GUIDE

● **Water tray.** Our tray is a Rubbermaid "Instant Drawer Organizer," item no. 2915. We bought it at a grocery store; it's usually available wherever Rubbermaid products are sold.



Drill-chuck attachment



Grinding wheel and guard

Continued on page 80

Time Out for Kids

What do woodworkers and kids have in common? They're both crazy about building things with wood. And you know something else? With your guidance and encouragement, a youngster can develop skills—and a very special relationship with you—that can last a lifetime.

Jim Woodruff, a retired Air Force colonel living in Arvada, Colo., firmly believes in working with kids, as his grandfather did. "If it hadn't been for his interest in a darn ornery kid—letting me work in the shop—I could have ended up in trouble," Jim says. "I was orphaned and hated the world until he took me in and built up my confidence."

Because his service career kept him moving around, Jim's own kids grew up before he could set up a permanent shop. But now, Jim's six grandchildren often congregate in his double-garage workshop. They range in age from 4 to 10, and he's sold on the idea.

Other child-oriented woodworkers we talked to are just as positive as Jim regarding children in the shop. They told us about the special approaches they use, and the benefits that result.

WHAT WOODWORKING TEACHES A CHILD

Besides the confidence that comes from showing a youngster how to use his hands as well as his head, there are other advantages: nurturing their creativity, a sense of accomplishment, patience, and persistence.

"They find a whole new direction," comments Chicagoan Joe Veracka, a

national demonstrator for Black & Decker's woodworking tools. Joe has guided kids through projects for the last dozen years. "It changes their lives when they end up being excellent craftspersons instead of klutzes."

Mike McPherson, who works in Des Moines' public schools, has a woodworking business as a family sideline. Mike, his wife, his dad, and his two pre-school daughters often spend evenings and weekends in the shop working on their "Home Tweet Home" wren houses. "Our girls see us having fun together as a family," Mike says.

In Tempe, Ariz., Paul McClure has often seen his own and his foster kids' reaction to an accomplishment in the shop. "When they can say 'I did it myself' their pride just bursts forth."

WHEN TO START YOUNGSTERS IN THE SHOP

Ages 6 through 12 seem the prime time to introduce kids to the workshop, yet Jim Woodruff's most enthusiastic little woodworker is his 3-year-old grandson, Chad. And Mike McPherson's daughters Evie, 4½, and Christie, 3, have their own workbench amidst the activity where they sand wood and pound nails.

Teens present more of a challenge,

mainly because they have so many outside interests. Still, a woodworking interest fostered earlier probably will continue. Paul McClure's children—son Sean, 13, daughters Angie, 14, and Tess, 17—regularly turn out projects which include elaborate chessboards and marquetry from exotic woods.

DECIDING WHICH TOOLS KIDS CAN USE

The tools kids can use depends on the individual child's maturity level. Preschoolers may not need tools at all—water-soluble glue, wood scraps, and sandpaper will be fine. Starting about age 7, they can usually manage some hand tools, such as hammers, pliers, hand planes, and a small twist drill.

Jim Woodruff hesitates to let youngsters this age work with sharp tools; he prefers to make necessary cuts himself. At age 10 or 11 he introduces them to the portable jigsaw, which he feels is about the safest.

Graduating kids to power tools requires some individualized judgment. Paul McClure looks at the child's strength, height, and maturity. His son used the lathe at 8 years, but couldn't use a router until he was age 13. Joe Veracka has found that kids from 12 to 15 might be old enough for the

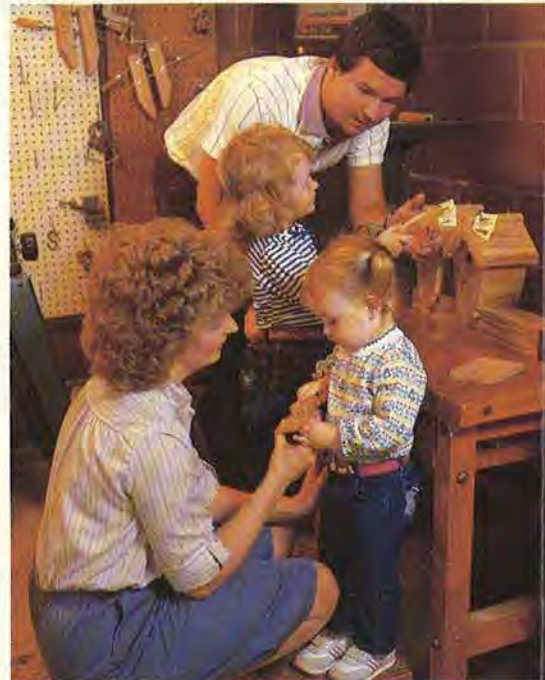



Above—Paul McClure, Tempe, Ariz.: "If my kids finish a project, I pay for materials. If not, they pay."

Left—Mike McPherson, Des Moines, Ia.: "We have a little work area just for the girls where they can watch us and we watch them."

Right—Jim Woodruff, Arvada, Colo.: "I always answer a question with a question—they learn to think."



radial-arm saw, band saw, or drill press.

"Some kids at 10 are more mature than others at 16," Joe says. "Even then, they have to be taught respect. I tell them 'These tools can bite you, and you can't bite them back!'"

SUREFIRE TIPS FOR WORKING WITH KIDS IN THE SHOP

Many youngsters have a short attention span, easily become discouraged, or rebel at being told exactly what to do. That's why it takes a special sensitivity to work with them. Our woodworkers shared these suggestions:

● **Make kids comfortable in your shop.** Paul McClure and Mike McPherson assembled pint-sized workbenches. But just a special space on your workbench will do.

● **Don't push.** Forcing kids into a project takes the fun out—fast. If kids get bored, let them take a break.

● **Encourage originality.** Should they insist on copying a design, have them alter it so it becomes their own.

● **Ask for drawings.** Drawing out what they want to build develops communication and thinking skills.

● **Let kids set the pace.** Hurrying kids turns them off. "Work with them as an equal, not just as a teacher," suggests Joe Veracka.

● **Avoid criticizing.** Help youngsters see their mistakes as learning opportunities—not as excuses for quitting. "If they say it's a table, then, by golly, it's a table," Jim Woodruff advises.

● **Make sure they complete projects.** Kids, like adults, take pride in accomplishment. That means seeing a project through to the finish, even if it's not perfectly executed. Paul McClure handles it this way: He pays for all materials in projects his kids complete; if they leave something half done, they pay for it themselves.

WOODWORKING HELPS KIDS FIND THEMSELVES

Along with the very special feeling you'll get from working with youngsters, you'll watch them develop their own aptitudes and abilities as they design and build with wood. And as kids discover what they can do, they build confidence in their own woodworking abilities.

"Kids not only feel good about themselves, they learn to appreciate others' work," Jim Woodruff observes.

If you're not yet involved with a son, daughter, grandson, granddaughter, or the kid down the street needing attention, invite them in next time! You'll both grow from the experience.

5 SAFETY RULES FOR KIDS

In the shop, kids require guidelines like these from Jim Woodruff:

1. Tools are on loan for their proper use only. "Tools aren't toys, and they don't argue over them."
2. No throwing, running, or rapid movement allowed in the shop. "Rough-housing belongs outside, but no tools go out the shop door."
3. Don't touch or turn switches. "Switches are off limits, but I show them how power tools work, their danger, and where it's safe to stand when I'm using them."
4. Follow the code words TAKE IT EASY. "If they work too fast or rough, I remind them what the code words are."
5. Don't use new tools without asking. "I have to make sure they work properly first."

Paul McClure offers some additional power-tool rules. In his shop, kids under 16 can't use power tools unless supervised. Eye protection is required, as are short sleeves and tucked-in shirttails. 🍀

Produced by Peter J. Stephano
with Gene Schnaser
Photographs: Bob Calmer; Ed Sargeant;
Steve Newnum

SIMPLY SPECIAL WREN HOUSE

Being parents ourselves, we tried to find just the right projects for this special Family Woodworking Section. For instance, you and your youngster can tackle this redwood birdhouse in just a couple of hours. Build it soon, and watch its feathered inhabitants set up housekeeping this spring.

START BY CUTTING THE PIECES

1 Form the front and rear panels (A), by ripping a redwood board to $5\frac{1}{4}$ " wide. Then, crosscut two pieces to $5\frac{1}{4}$ " long.

2 Transfer the shape of the front panel (A) onto the redwood, using the gridded Front Half-View Drawing as a guide. Using a jigsaw or band saw, cut it to shape as shown in the photo, *below*. Sand all the



Note: We chose redwood for this project, but you also could use pine or western red cedar. Do not apply paint or preservatives; wrens prefer to live in homes with no finish.

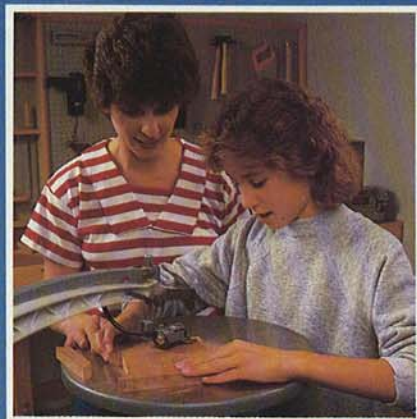

NOW, PUT THE HOUSE TOGETHER

1 Clamp the bottom panels (B, C) together as shown in the Exploded-View Drawing, and drill two $\frac{1}{8}$ " pilot holes through B and $\frac{1}{2}$ " into C. Then fasten the two pieces together with two #8 $\times 1\frac{1}{4}$ " flathead wood screws. The redwood is soft enough that the screws will countersink themselves for a flush fit. Remove the clamps.

2 Drill a $\frac{1}{4}$ " drain hole at the bottom edge of C, as shown in the Exploded-View Drawing.

3 Clamp the roof panels (D, E) together. Drill $\frac{1}{8}$ " pilot holes, and screw the parts together, as indicated in Step 1.

4 Clamp the B-C assembly between the front and rear panels, keeping the top edges of B and C flush with the edges of both A's. Drill pilot holes, and screw the

edges smooth. With the front panel as a template, trace the outline onto the rear panel, and cut it to shape.

3 Clamp the front panel firmly in a vise and bore a 1" entrance hole in it as shown in the photo, *above right*. Then drill three $\frac{1}{4}$ " ventilation holes in the rear panel. Place a scrap board beneath each panel when drilling to prevent chipout.

4 Cut the bottom panels (B, C) and roof panels (D, E) to size.

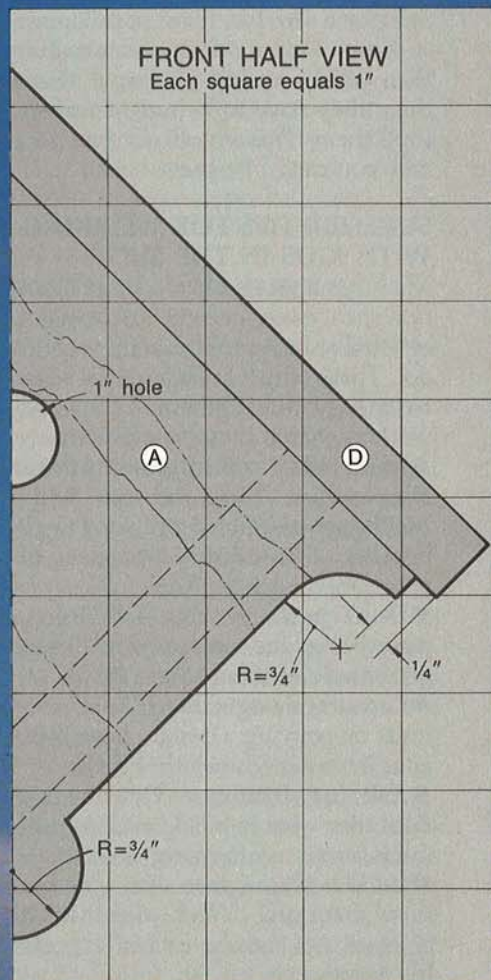

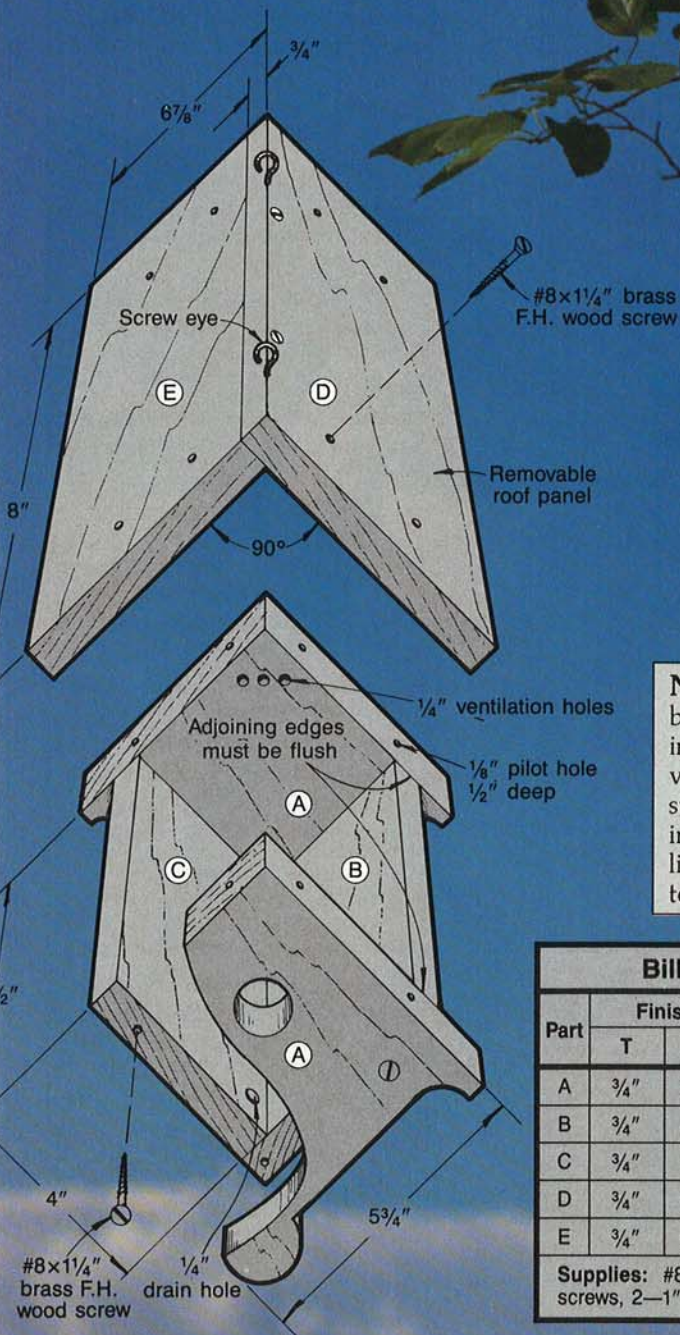

Note: Wrens prefer low branches with the opening facing away from prevailing winds. And be sure you locate the house in an area that is partially lit, yet out of the hot afternoon sun.

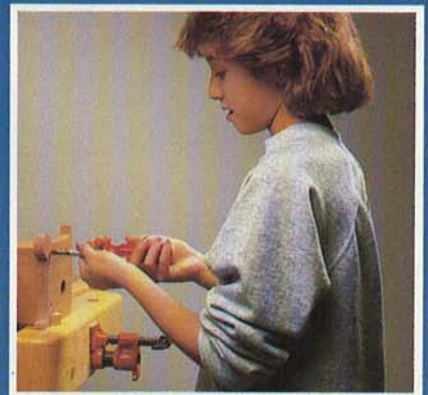

assembly together as shown in the photo, above.

5 Position and clamp the roof (D, E) to the house, making sure that it overhangs the front and back panels equally. Drill pilot holes, and screw the roof to the rest of the house. By removing the six screws from D, you can lift this piece off and clean out old nests.

6 Sand the entire wren house smooth. Install two screw eyes for hanging. Hang from a branch, and post a vacancy sign. 🌿

Bill of Materials

Part	Finished Size			Material	Qty.
	T	W	L		
A	3/4"	5 3/4"	5 3/4"	redwood	2
B	3/4"	4 3/4"	4 1/2"	redwood	1
C	3/4"	4"	4 1/2"	redwood	1
D	3/4"	6 7/8"	8"	redwood	1
E	3/4"	6 1/8"	8"	redwood	1

Supplies: #8 x 1/4" brass flathead wood screws, 2—1" screw eyes

Project Design: James Downing
Photographs: Hopkins Associates
Illustrations: Bill Zaun; Kim Downing



Happy THE RED BARON, JR.

With your supervision, a youngster probably can handle most of the layout, cutting, and assembly of this high-flyin' project—depending, of course, on his or her skill level and age.



Landings TOY AIRPLANE

FIRST YOU MAKE THE FUSELAGE, WING, AND STABILIZER

1 Rip a piece of pine to 1½" square. Measure 5¼" from one end and cut the fuselage (A) to length.

2 Using the Full-Sized Patterns on page 75 and the drawing, *below*,

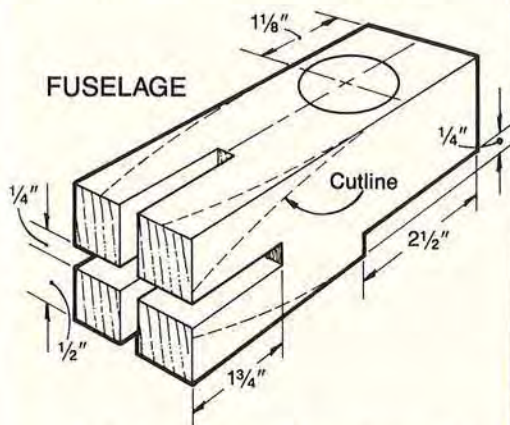

for reference, lay out and mark the notches needed to hold the elevator (B) and the rudder (C). Do the same for the rabbet that will accept the wing. Then, using a band saw or a handsaw, chisel, and mallet, cut the notches to size. And with a band saw or a dado blade mounted in your radial-arm or table saw, cut the rabbet in the underside of the fuselage.

3 Lay out the location of the cockpit, again using the drawing, *above*, as reference. Drill a 1¼" hole ⅜" deep where the two lines intersect. Now, drill a 1" hole through the center of the first hole and through the entire thickness of the fuselage, using a backer board below the piece being drilled to prevent chipout.

4 Draw diagonal lines from corner to corner on the front of the fuselage to mark the center point for the prop shaft. With a ¼" bit,

drill ½" deep into the front of the fuselage (A).

5 Using the pattern on page 75 as a guide, mark the taper on the tail end of the fuselage. Cut the taper to shape with a band saw or jigsaw. Now, round-over the square edges the length of the fuselage with a block plane or wood rasp.

6 Using tracing paper, transfer the shape of the rudder (B), elevator (C), and wing (D) onto ¼" stock. Remember to trace the notches and the strut holes. Cut the parts to shape, then cut the notches in B and C. (We resawed ¾" pine and walnut to form the ¼" thick stock.)

7 To form the strut holes, drill two ¼" holes side by side. Cut the rectangular holes to shape with a mallet and chisel as shown in the photo, *below*.



8 Sand all curves smooth, and sand a slight chamfer on any sharp edges. Test the fit of B and C into the notches in the fuselage. (Some filing and sanding may be necessary for a good fit.)

NOW YOU CUT THE PROPELLER PARTS

1 Using a circle cutter on the drill press, cut the motor (E) and nose cone (F) to shape. Sand a slight round-over on the front edge of

both. [To sand the round-over and other round parts smooth, we mounted the parts (E, F, I) on ¼" dowel stock. Then we mounted the dowel in the chuck on our drill press, turned the drill on at a low speed, and sanded the parts smooth.]

2 Using tracing paper, transfer the shape of the propeller (G) to ¼" stock, and cut to shape. Drill a ⅝" hole through the center of the prop, and ¼" holes through the center of the motor and nose cone.

3 Cut the prop shaft to length (1¼") from ¼" dowel stock.

HERE'S HOW TO GUARANTEE A SMOOTH LANDING

1 Once again using the Full-Sized Patterns, transfer the shape of both struts (H) onto ¼" stock. Cut the struts to shape, stick them together with double-faced tape, and drill a ⅝" hole through both for the axles. Check for a tight fit of the struts through the strut holes in the wings, and sand if necessary.

2 Use a small-diameter rasp or a ¼" dowel with sandpaper wrapped around it to form the groove for the guns on the top end of the struts as shown in the photo, *below*.



Continued

3 Using a circle cutter, cut the two wheels (I) to size (1 1/4" diameter). Drill a 1/4" hole in the center of each. You can also buy 1 1/4"-diameter wooden toy wheels, which also have 1/4" axle holes.

4 Cut the wheel axle to length (4 1/4") from 1/4" dowel stock. Using the same size of dowel stock, cut the two guns to length. Drill a 1/8" hole 1/4" deep centered in the front end of each gun.

TOY AIRPLANE

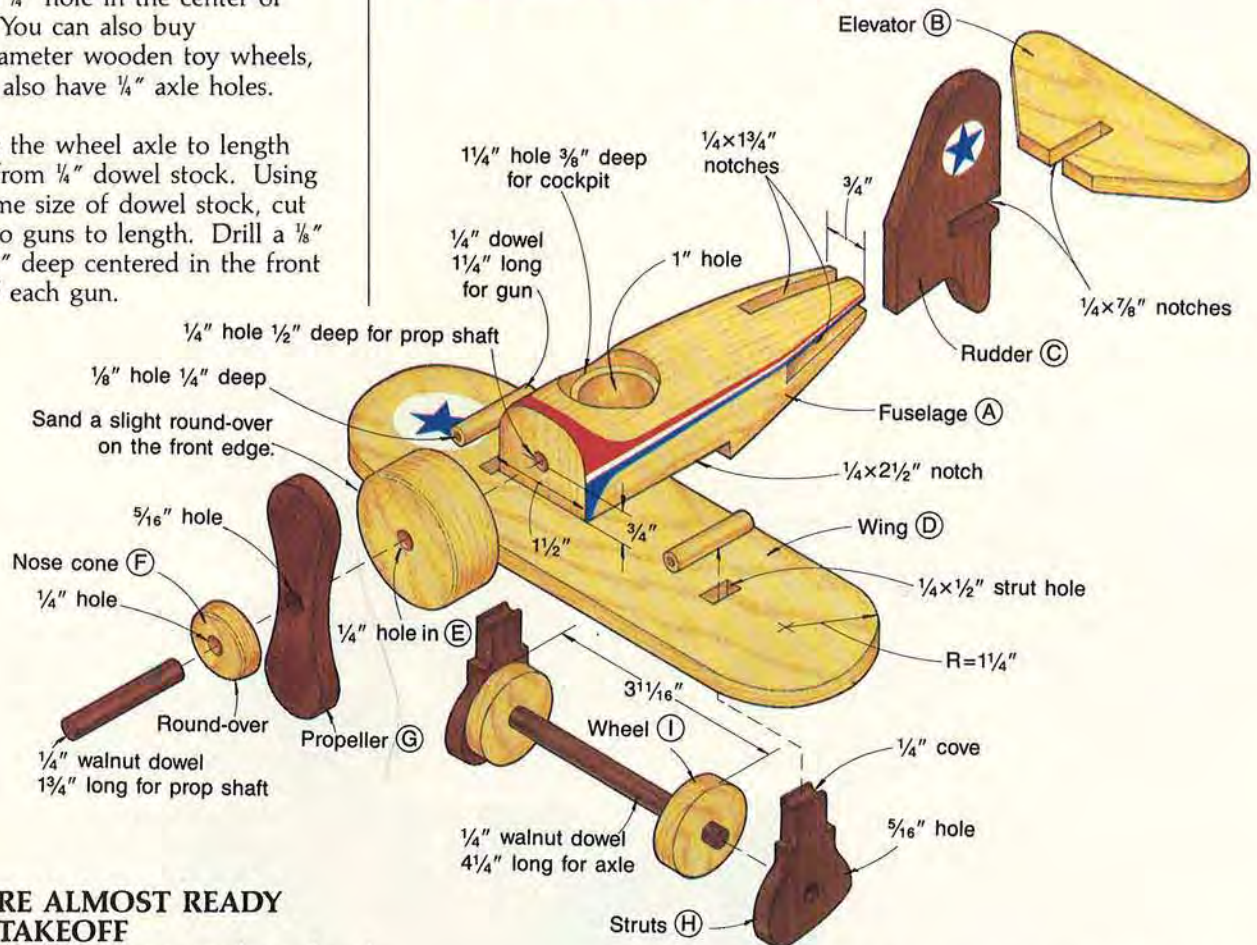

YOU'RE ALMOST READY FOR TAKEOFF

1 Sand all the parts smooth, sand all sharp edges. (While most projects are sanded after completion, it is much easier to sand this one before gluing. It takes more time to try and sand around all the parts, especially the moving ones, later.)

2 Glue the rudder, then the elevator in the tail end of the fuselage. Glue and clamp the wing to the underside of the fuselage.

3 Attach the motor (E), propeller (G), and then the nose cone (F) to the fuselage (A) with the 1/4"-walnut dowel. Glue the motor to the body, and glue the nose cone to the dowel. (Be careful not to get any glue on the prop so that it can spin freely on the 1/4" dowel.)

Bill of Materials					
Part	Finished Size			Material	Qty.
	T	W	L		
A	1 1/2"	1 1/2"	5 1/4"	pine	1
B	1/4"	1 3/4"	4 1/8"	pine	1
C	1/4"	1 3/4"	3 1/2"	walnut	1
D	1/4"	2 1/2"	8 1/2"	pine	1
E	3/4"	2"	diam.	pine	1
F	1/4"	1"	diam.	pine	1
G	1/4"	1"	3 1/2"	walnut	1
H	1/4"	1 1/2"	2"	walnut	2
I	1/4"	1 1/4"	diam.	pine	2

Supplies: 1/4" walnut dowel, 1/4" birch dowel, tung oil, pilot figure (you can use a Fisher-Price Air Pilot or order a wood "person" from most toy-part catalogs), adhesive-backed decals and colored tape

4 Glue the wheels (I) in place on the axle. After the glue dries, fit, but don't glue, the struts (H) onto the axle. Position and glue the struts in place through the wings. Finally, glue the guns into the coves on top of the struts.

5 If you want your airplane to look exactly like ours, attach colored tape and decals. (We found the colored tape at a local hardware store and decals at a hobby shop.)

6 Finish the entire airplane (we used several coats of tung oil), and you're ready to fly. 🌳

Project Design: Kim Downing
Photographs: Hopkins Associates
Illustrations: Kim Downing; Bill Zaun

Full-Size Patterns on page 75

Full Size Plans



Toddlers love riding Charlie Horse. He is 11 x 22 x 26 high & easily built of pine. Plan-335 \$4.50

Jib Crane swivels on ball bearings and has two working hand controls. Height 24" Plan-319..... \$4.00



Our great collection of five toy vehicles is easily built with hand & power tools. Trailer is 18" long & 7" tall. Plan-18004..... \$8.50 Add postage 50¢ per plan. NY Res. add tax. Catalog \$1.00—Free with plans. Phone (516) 462-6228 We accept Visa & MasterCard orders if over \$15.00

ARMOR, Dept. L, Box 445, E. Northport, NY 11731

101 GIFT & NOVELTY PATTERNS

This wonderful packet contains 101 FULL SIZE PATTERNS of Gifts, Novelties, Lawn Figures, Bird Houses, Shelves, Action Windmills, Alphabets, and many more things. Just trace and saw out. Plus "Make Money Jig Sawing". Only \$7.00 Prepaid 1st Class for this big packet.



MASTERCRAFT PLANS WEST, DEPT. 35H
P.O. Box 625, Redmond, WA 98073

30 BIRDHOUSES FULL SIZE PATTERNS



Attractive new bird houses and feeders. Expertly designed to attract Wrens, Martins, Robins, etc. Easily made. Full size patterns and directions. Only \$7.00. Prepaid 1st Class.

MASTERCRAFT PLANS WEST, DEPT. 316H
P.O. Box 625, Redmond, WA 98073

Wood-Mizer®

Portable Bandsaw Mill

One Man Operation
Capacities to 32" Dia. x 32' Long
More Lumber Per Log
Safe - Precise

Three Models Available

For catalogs on our complete product lines, send \$1.00 to:

Wood-Mizer® Products
Dept. QQ5,
8180 W. 10th St.
Indpls, IN 46224
(317) 271-1542



Find out why we sell more bandsaw mills than anyone else in the world!

WOODWORKERS

STUD SENSOR™

The Amazing New Device That Sees Through Walls Electronically



SALE \$19.95 ppd

- NOT magnetic—does not detect nails.
- Senses wall density to detect wood studs.

FREE CATALOG SUBSCRIPTION WITH PURCHASE.

CATALOG ONLY.

2 year subscription (8 issues) \$4.00. Free \$5.00 gift certificate with catalog order.

R. A. NESS & CO.

THE WOODWORKERS EMPORIUM

8888 N. MILWAUKEE AVE.

NILES, IL 60648

(312) 824-0565



Turning into a better craftsman can be as simple as turning the pages of our new catalog.

Our new 244 page catalog is filled not just with pictures of great hand and power tools, but carefully written specs, detailed illustrations and recommendations from craftsmen who've spent much of their lives making, using and testing tools.

You'll know what they look and feel like, and you'll know how they fit your needs.

We believe you're not the average craftsman. So why should we give you an average catalog?



Garrett Wade Co., Dept. 108
161 Ave. of Americas, N.Y., N.Y. 10013

Please send me your 244 page catalog of wood working tools, machinery and accessories. Enclosed \$3.00.

Name _____
Address _____
City _____
State _____ Zip _____

NEW! HIGH-PRECISION SCROLL SAW OUTPERFORMS THEM ALL!

30-DAY FREE TRIAL!

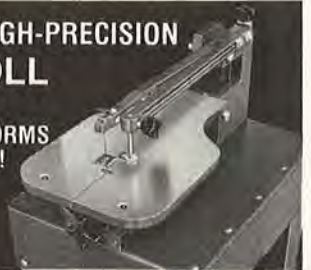

Use this high-precision saw to make hundreds of profitable, unusual items...toys, name-bars, fillgree work, clocks, holders...the list is nearly endless! Because the Model 1600 cuts so smoothly, sanding is virtually unnecessary!

BUILT FOR THE PROS!

The new Woodmaster Model 1600 gives you a big 16-in. throat capacity, 2-in. cutting depth, a generous, oversize worktable, ball-bearing drive...and much more!

30-DAY FREE TRIAL!

Send for Complete Facts! See how you can use the Model 1600 in your own shop for one full month without risk! Easy terms. MAIL COUPON TODAY!

Call Toll-Free
1(800) 251-4888

SEND FOR FREE FACTS TODAY!

SCROLL SAW FACTS

Woodmaster Tools, Inc.
Dept. CW11, 2908 Oak
Kansas City, MO 64108

YES! Please rush my FREE Information Kit and details on your 30-Day Free Trial Guarantee!

Name _____
Address _____
City _____
State _____ Zip _____

TUNG OIL with URETHANE for greater durability



Deft, Inc., Irvine, CA 92714. Alliance, OH 44601.

EDLCO

Appalachian Hardwood Specialists
Now Serving Craftsmen
Select from over 21 species
Imported And Domestic Hardwoods
Softwoods

Veneers Shorts Turnings
Kiln Dried Delivered Prices
New Catalogue \$2.00

Write today EDLCO

Box 5373 W

Asheville, N.C. 28813

Phone (704) 255-8765

Stay In The Woods With Us

EDUCATIONAL LUMBER CO., INC.

My Ebac
LD82 Dry Kiln
paid for itself in
just 3 months!



YES YOU CAN KILN DRY YOUR OWN LUMBER...

...As little as 100 BF per month for pennies a board foot!
Let EBAC, the World Leader, show you how with an...

EBAC LD82 WOOD DRYING KILN

- Simple to operate — plug it in and turn it on!
- Dry lumber — 6%-8% — when you need it!
- Increase your profits — buy green wood & dry it yourself!
- Quiet and efficient — your TV probably uses more electricity!
- Rapid payback — usually within 1-6 months!

What are you waiting for? For less than \$1,000, you could be kiln drying your own lumber and pocketing the kiln dried premium! Find out why 350 of your friends in the U.S. and Canada — most with no wood drying experience — own EBAC DRY KILNS. **GET THE FACTS — CALL EBAC,** or write, for more information and a no obligation lumber drying proposal. — **YOU'LL BE GLAD YOU DID!**



EBAC LUMBER DRYERS

8726 E. 33rd St., Dept. F., Indianapolis, IN 46226
317-897-2100 / 1-800-433-9011

— LARGER SYSTEMS AVAILABLE —

the American Woodworker

If you enjoy woodworking, *The American Woodworker* is a must for you. It contains projects on three levels: beginning, intermediate and advanced. The plans alone are worth the subscription price. Each project is well illustrated and photographed. Each issue is loaded with information showing in detail how to perform a specific woodworking operation, plus how to build time saving jigs and shop equipment that will save the woodworker hundreds of dollars. Informative articles explain how to compensate for the movement of wood, the basics of carcass construction, how to build a shop dust system for under \$300.00, etc. These are a few examples of the types of articles you can look forward to. Listed below is a summary of what to expect from *The American Woodworker*:

- Projects on 3 levels
- Large 9 x 12 size
- All different styles of furniture & projects
- In-depth instructional articles
- Woodworking techniques
- A Question & Answer column
- Supply sources, visits, reviews & much more

The American Woodworker is published quarterly in March, June, September, and December so each issue is the type of publication that you will save for years to come. The subscription price is \$12.00 per year. Outside U.S. \$17.00 per year, U.S. funds.

The American Woodworker
P.O. Box 1408, Dept. W-6
Hendersonville, TN 37077-1408

WOODWORKING MACHINES 5 in 1 Combination

- 1 • 34" LATHE
- 2 • 10" TABLE SAW
- 3 • 11 1/4" DISC SANDER
- 4 • 16 1/2" VERTICAL DRILL PRESS
- 5 • HORIZONTAL DRILL PRESS



VERY IMPORTANT

- The only machine built with
- a. ALL CAST IRON TABLES
 - b. HEAVY-DUTY DESIGN
 - c. 1 1/2 HP MOTOR DEVELOPS 3HP
 - d. BUILT AS AN INDUSTRIAL MACHINE
 - e. ONLY MACHINE WITH 5-YEAR GUARANTEE

ONE PLACE FOR ALL YOUR NEEDS...

VISA MASTERCARD FINANCE AVAILABLE

PLANT:

MASTER WOODCRAFT CO.

800 SPRUCE LAKE DRIVE • P.O. BOX 669
HARBOR CITY, CA 90710

TOLL FREE 1-800 421-2467

IN CALIFORNIA CALL COLLECT (213) 549-0761

(A Republic-Lagun Group) • Dealership Available

PRICED RIGHT! DELTA WOODWORKING PRODUCTS



DELTA SPECIAL EDITION 12" WOOD LATHE

- Comes with 8 turning tools, 2 how-to books, and the new Delta Super Chuck for face plate turning
- Suggested retail \$2771; now \$1399 while supplies last
- Big capacity, variable speed, 1/4 hp motor.



\$1399
Our Price

13" RC-33 PLANER ... '999

COMPLETE LINE DELTA DIST.

a c m e Electric

TOOL CRIB OF THE NORTH

CALL TOLL FREE FOR MIKE

1-800-358-3096

LIVOS LIVOS NON-TOXIC FINISHES, PAINTS, STAINS

LIVOS is the complete product line featuring only non-toxic and natural ingredients. One can safely use LIVOS on: salad bowls, cutting boards, butcher blocks and kitchen counters, as well as children related items: cribs, high chairs, tables and toys. The entire line of LIVOS consists of oils, waxes, shellacs, lacquers, polishes, stains, enamel and latex paints, wood preservatives, more.

**NO TOXIC FUMES, NO MINERAL SPIRITS,
NO PETROLEUM PRODUCTS.**

SAFE FOR HUMANS, ANIMALS, PLANTS.

Send \$2.00 for our Catalogue and 2 Year Subscription to: "LIVOS NEWS"; Product Updates and Brochures.

LIVOS PLANTCHEMISTRY

614 Agua Fria Dept. BH6D, Santa Fe, NM 87501
Phone (505) 988-9111

THE MAGNIFICENT MALLET



- 14-oz... \$7.50
- 18-oz... \$7.50
- 24-oz... \$7.95
- 32-oz... \$7.95

+\$2.25 Postge.

Top Quality • Extra Durable • One-Piece

Lignum Vitae Carver's Mallet

Liberal discount to Schools and Dealers.

FREE 24-P. German steel tool catalog-write:

FRANK MITTERMEIER, INC.

IMPORTERS OF FINE TOOLS SINCE 1936

Dept. WM-036, 3577 E. Tremont Avenue
Bronx, New York 10365

SEND \$.50 FOR A CATALOG

- Plans
- Patterns
- Ideas



Craftplans™

21801 Industrial Boulevard, Dept. CR15
Rogers, Minnesota, 55374-9514

Create A Classic



Full size patterns for Packard Le Baron and 1929 Chevy Truck, plus a catalog of over 100 wooden toy patterns, wooden wheels, axle pegs, people, and other hardwood turnings.

Send check or money order for \$10.00 for both patterns and catalog, or \$1.50 for catalog.

TOY DESIGNS - Dept. BW486, Box 441
Newton, Iowa 50208

TOY AIRPLANE

Continued from page 72

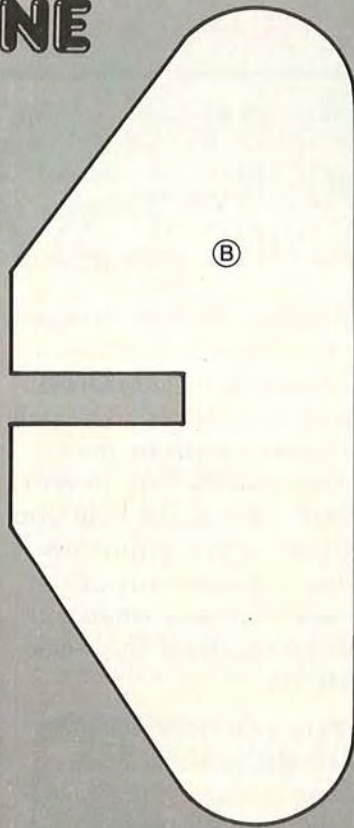
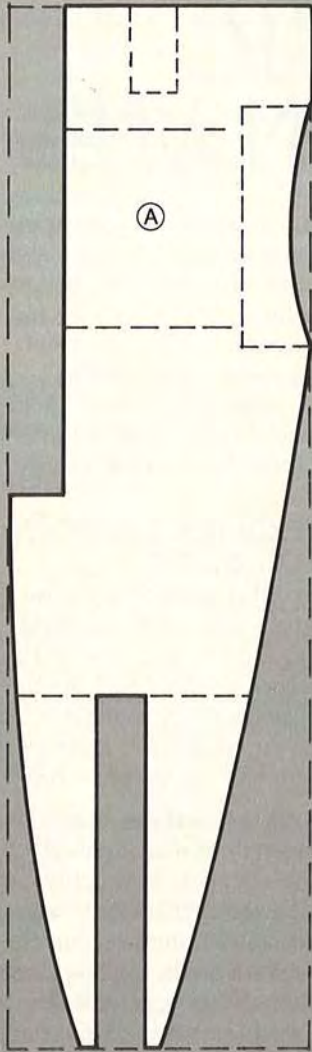

FULL-SIZED PATTERNS

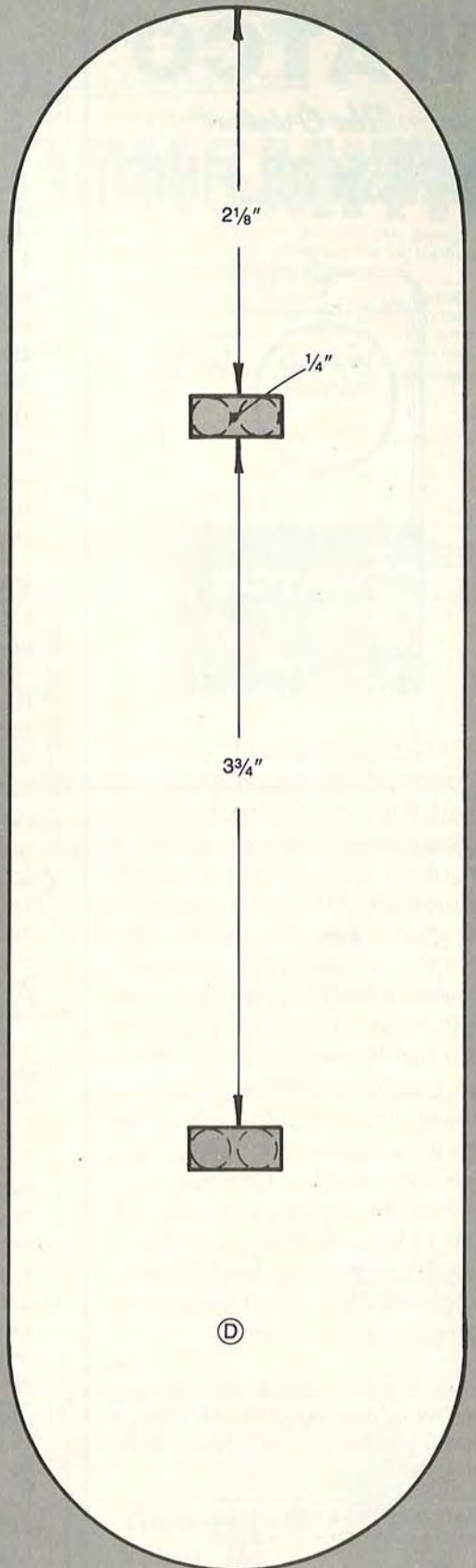
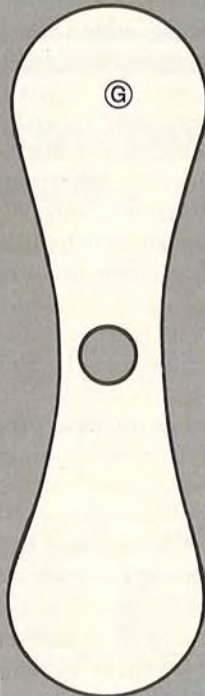
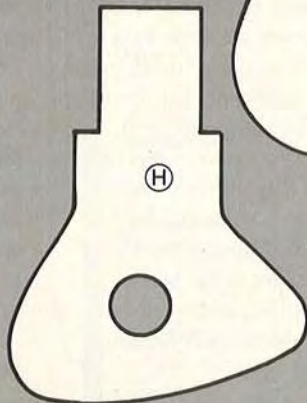
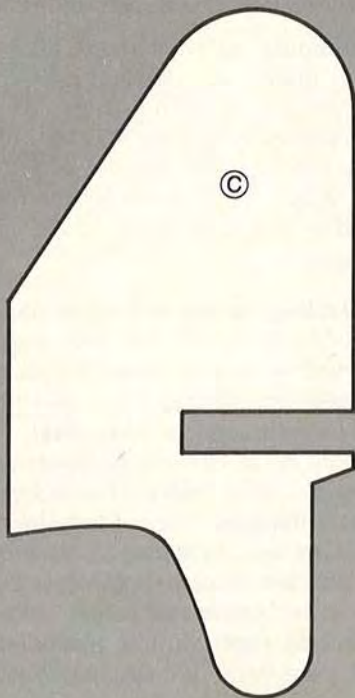

EASY WOOD FINISHING
with
WATCO®
The Original
DANISH OIL FINISH



You'll be amazed at how easy it is to finish wood beautifully with Watco Danish Oil. Watco gives wood that natural hand-rubbed look with long-lasting durability. And because Watco is **IN** the wood... not on it like temporary surface coatings... there is no finish that will wear off. Watco Danish Oil is ideal for furniture, antiques, paneling, cabinets, doors, and trim-work. It's also safe for butcher blocks, cutting boards, and children's toys. Choose from 8 beautiful finishes... Natural, and Medium, Dark, and Black Walnut shades, and Cherry, Golden Oak, Fruitwood, and English Oak colors.

Send today for "FREE" color booklet "HOW to Beautifully Finish Wood" and the name of your nearest Watco distributor.

WATCO-DENNIS CORP., 1756 22nd St.
Santa Monica, CA 90404, Dept. BH-W36

Name _____
Street _____
City _____
State _____ Zip _____

213/870-4781

TIPS ON CHOOSING & BUYING **PLASTIC LAMINATES**

Plastic laminate has changed its face for the Eighties. From pinstripes to geometrics and metal look-alikes to pastels with the color solid to the core, your choices have never been more varied. To help you through the selection process, following is a rundown of what's available and what you need to know about this versatile material.

PICK THE LOOK YOU LIKE
Despite tough-guy characteristics, plastic laminates have often trailed other materials as the choice when it came to up-to-date looks. But wait just a minute. Something new has been added to the mix.

Solid-to-the-core surfacing materials: Solid-core surfacing materials eliminate the unsightly, dark seam lines you have with standard laminates. Scratches and dents show up less, too, because the dings cut into a backing of the same color. With these solids, you can build up layers of varying colors for some spectacular design effects. Trade names include products such as Formica's Color-Core®, Wilsonart's Solicor®, and Pioneer Plastics' MelCor™.

Metal laminates: Anodized or epoxy-coated aluminum and urethane-coated copper take on the look of bronze, gold, brass, steel, and other metals. Finishing touches can produce a look as slick as a mirror or as soft as a textured brush effect. With embossing, the metals offer a variety of designs.

Better mimics: Woodworkers will be pleased that the plastics that have masqueraded as wood look more like the real thing, thanks to improvements in printing techniques. Other look-alikes—linens, leathers, canes, slate, marble, and stone look good, too.

Designer patterns and textures: Thus far, you won't find a Calvin Klein laminate. You may believe that designer names can't be far away, though, with the current array of patterns and textures—pinstripes, geometric patterns, graphs, embossed surfaces, and patterns that give a three-dimensional quality.

WHAT GRADE LAMINATE DO YOU NEED?

● **Horizontal, general-purpose laminates** stand up to the most pressure, impact, and wear with a thickness of roughly 1/16". As the name implies, these laminates make the best choice for flat surfaces such as countertops or furniture tops.

● **Vertical, general-purpose laminates** are thinner, less-costly surfacing materials at roughly 1/32" thick. They won't take the abuse of their thicker counterpart, but they work well on walls, cabinet doors, and other similar applications. Often, you can save some money by using both horizontal- and vertical-grade sheets on a project.

● **Banding, or edge strips,** give your project an edge and save you the trouble of cutting strips. Banding comes in varying widths, but one common size measures 1 7/8" x 12' long. Some banding is sold in foot-long strips; others, in long rolls.

● **Backing sheets** add dimensional stability to panels that aren't supported by another assembly such as a base. Ideally, the decorative plastic laminate and backing sheet should be as close in thickness as possible. The thicker the backing sheet, the greater the dimensional stability and resistance to cracking. In practice, most people cover the backs or bottoms of panels with "backing sheet," a thin, inexpensive laminate without a decorative face.

BUYMANSHIP BASICS

● **Cabinet liners** are less expensive than general-purpose laminates and work well inside cabinets and other casework. The liners come in limited stock colors.

● **Specialty laminates** include laminates that are fire-retardant, impervious to certain chemicals, have antistatic properties, or take more wear.

MAKING THE PURCHASE

Where to purchase: Retail outlets such as home centers and lumberyards handle only a few standard sizes and designs. But they all have samples of the various patterns, so you can order from these. The largest manufacturers have distribution centers in most states, so the shipping distance may not be far. Delivery can be as short as a day or two, though some lines may take from 10 days to two weeks. In a large city, you may be able to buy directly from the manufacturer's distribution center.

Pricing: Plastic laminates are sold by the square foot. Standard patterns and wood grains typically cost between \$1 and \$2 a square foot. Specialty items, such as metal or solid-core colors, may cost from just under \$5 to almost \$7 a square foot. Price may vary according to finish. A basic matte or satin finish generally is the least expensive; higher gloss or raised finishes may cost slightly more. And, in general, backing sheets and cabinet liners cost about half what standard patterns go for.

Sizes: Standard nominal widths include 18", 24", 30", 36", 48", and 60". Standard nominal lengths are 48", 60", 72", 96", 120", and 144". Manufacturers cut sheets slightly wider and longer than stated to allow for trimming or for cutting more than one piece from a sheet. Not all products come in all widths and lengths. More specialized products may be sold in only one size sheet. 🌲



This VET Did It - and YOU Can Do It Too!

"War injuries left me badly handicapped, but now I'm a financial success as a Locksmith, thanks to your training. Besides, the work is fascinating. If I can do it anybody can." — Glen Johnson, Larned, Kan.

Make Up to \$26.00 an Hour — even while learning!

Train FAST at Home!

Be a LOCKSMITH!

If you enjoy fixing things, you're a "natural" to make hundreds of EXTRA DOLLARS a year in the fascinating business of Locksmithing. Rising crime has increased demand for service a thousandfold. **Yet there's only one Locksmith for every 17,000 people!**

COLLECT CASH PROFITS ALMOST AT ONCE!

You're "in business" ready to make \$10 to \$26.00 an hour a few days after you begin Foley-Belsaw's shortcut training. Easy illustrated lessons complete with ALL practice equipment **PLUS**

- ALL TOOLS YOURS TO KEEP
- KEY MACHINE YOURS TO KEEP
- EXPERT PERSONAL ASSISTANCE
- BUSINESS-BUILDING HELP

enable you to get your share of this always-profitable business. Hundreds we've trained are doing it. So can YOU.

MAIL COUPON to discover how Locksmithing can keep the extra money coming in during spare time—or in your own full-time business. Ideal for retirement—good jobs, too.

FOLEY-BELSAW INSTITUTE, 10866 Field Bldg. Kansas City, Mo. 64111

N. Hunt, Wilmington, Del.—"I make \$50 a week extra."

R. Davis, St. Louis, Mo.—"I cleared \$110 last Saturday."

Ed Boyle, Pittsburgh, Pa.—"My business going at top speed. I'm moving to bigger quarters."



MAIL THIS COUPON • NO SALESMAN WILL CALL

FOLEY-BELSAW INSTITUTE, 10866 Field Bldg. Kansas City, Mo. 64111



Rush **FREE** book, "Keys to your Future."

Name _____

Address _____

City _____ State _____ Zip _____

THIS DO-ALL PRO KEY MACHINE YOURS TO KEEP!

Can add \$50 to \$100 a week to your income... and doesn't cost you a penny extra!

FREE

Planter Pets T.M.

Woodworking Patterns by

Timber Technics T.M.

These planter box woodworking patterns are a wonderful way to showoff your favorite, flowers, vegetables, ferns and other plants. And these little pets are at home inside or out! Each of these "Planter Pets" are shown in three sizes and printed in full size on 22"x32" pages. A quick one or two evening project.

North American Moose #T406

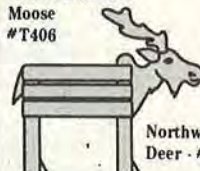

Rocky Mtn. Bear #T405



Giraffe #T402



Sierra Mtn. Goat #T403



Northwest Mule Deer #T401

Circle Order #	Price Each	Total
T401, T402, T403 T404, T405, T406	\$3.49 ea.	
Handling Charge	\$2.00	\$2.00
Total Enclosed		

California Residents add 6% Sales Tax
Canadian Orders add 30% Shipping Charge.

Timbers/Lake Tahoe, Inc.

2911 Lake Forest Rd., Dept. T3
Carnelian Bay, CA 95711-0850

For VISA or Mastercard orders
Phone 24 Hrs., 916-581-4141



ELEKTRA BECKUM



THE PERFECT
COMBINATION

HC260 JOINTER/PLANER 'and' SPA1000 DUST EXTRACTOR

- Hardened 40" tables
- Width of jointer and planer 10 1/4"
- Max. thickening depth 6 1/2"
- 63 cuts per inch
- A clean work environment
- 765 cfm suction capacity
- 4" x 98" heavy duty hose
- Use any standard trash bag
- 3/4 HP motor 110/1/60

2.4 HP, 220V **\$1250.00**
2.4 HP, 110V **\$1295.00**
4.2 HP, 220V **\$1375.00**

\$450.00

Suggested list price
FOB Somerdale, NJ



Send \$1.00 for full color catalog to:
ELEKTRA BECKUM USA DEPT HCS
PO BOX 24, SOMERDALE, NJ 08083
Call for your local dealer: 1-800-223-8600
See these machines demonstrated at:
Portland, Mar. 14-16; Atlanta, April 4-6;
Springfield, Ma, Apr. 11-13; KC, May 2-4

TALKING BACK Print this article

Continued from page 10

MAIL-ORDER SOURCE FOR GRAINGER PARTS

Several of your recent projects have included W.W. Grainger parts. Grainger is one of America's larger wholesale houses and does not sell retail, so readers may face a challenge in finding sources for these parts. *WOOD* readers who want to buy Grainger parts may do so from me, at wholesale prices (Grainger's "net cash" price). Their purchases will be shipped from their local Grainger warehouse.

Readers should send me a stamped, self-addressed, no. 10 envelope and specify the month, issue number, and page of the project they want to order the parts for. All queries should be addressed to: SBISCO, Dept. BHW, P.O. Box 479W, Hollister, CA 95024. Parts delivery normally is within 14 days of the date the order was mailed.

—Edward W. Stollery II, SBISCO, Hollister, Calif.

WHERE TO BUY BELT-BUCKLE HARDWARE

While reading "Found Wood" (October, 1985, p. 66), I wondered how many times in past years I have tripped over good wood. The spalted-maple belt buckle caught my eye in particular. I have been wanting to make my own buckles for some times. Can you help me find a source for the hardware?

—Albert Swelbar, Cadiz, Ohio

Wooden belt buckles make nifty gifts—especially when you can turn them out in a hurry. Our own Features Editor Peter Stephano made the buckle you saw in the October, 1985 issue. Buy the hardware at your local Tandy Leather store, or from their catalog. Hook and ring no. 1601 fits 1" to 1 1/4" buckles; no. 1602, 1 1/2" to 1 3/4" buckles. Cost: 79 cents each (Texas residents add 4 cents sales tax for each buckle), plus \$1.75 postage and handling per order. To order by mail, write: Tandy Leather Co., P.O. Box 2934, Dept. WM, Fort Worth, TX 76113.

OLD-TIME TOOL EXPERT NEEDED

In the December issue, the article on "The Christmas Wagon" (p. 78) mentions the felling of a tree with a one-man crosscut saw. I have somewhat restored my father's one-man crosscut saw that he used in Wisconsin until the early 1930s. It is a saw that grasps the trunk or log to be cut, applies downward pressure to the saw blade, and can be adjusted for horizontal or vertical sawing. I don't know how rare this tool is, but I would be willing to donate it to an appropriate historical society in my father's name. I would also appreciate any information your readers can supply on this unique tool.

—Kermit C. Jones, Security, Colo.

Can any of you readers help out? If so, please send your correspondence to the Letters Editor here at WOOD, and we'll pass it along to Kermit. ♣

WOODWORKERS BUYER'S GUIDE TO POWER TOOLS

INCLUDING

- STATIONARY POWER TOOLS
- HAND HELD POWER TOOLS
- MISC AND SPECIAL EQUIPMENT
- IN-DEPTH EXPERT ADVICE

1986

ANNOUNCING The New 1986 Edition

At last, a single source for the woodworker, homeowner, and builder to become well informed about the selection of all types of stationary and hand held power equipment.

OUR 1986 BUYER'S GUIDE CONTAINS:

- Thousands of photos, facts, charts, prices, and product descriptions of all types of woodworking equipment.
- Information on all stationary power tools such as table saws, planers, jointers, etc.
- Information on hand held power tools such as sanders, routers, jig saws, etc.
- Information on miscellaneous specialty equipment such as dust systems, spray equipment, moisture meters, etc.
- Expert, in-depth commentary and advice on each tool. This alone is worth more than the price of the book.
- Recommended to anyone who uses power tools, both amateur and professional, whether you are building family heirlooms or doing home repairs.
- A special section on electrical motor, starters, phases, etc.

Now you have a chance to **LOOK BEFORE YOU BUY**. There are over 35 CATEGORIES of machines from the common to the unusual. This is the best source of information available anywhere.

A \$25.00 value. Order now at the low introductory price of only \$13.50 plus \$1.50 shipping. Send check or money order, Visa or MasterCard number with signature, card number and expiration date. Return in 10 days for a full refund if not satisfied. Send to:

JM Publications, Inc.

Dept. BG-2, 13 Walton Mall, Box 1408, Hendersonville, TN 37077-1408
(615) 822-0857

AVAILABLE JANUARY 1986

—Rare—
MACASSAR EBONY

MAGNIFICENT GRAIN,
high figure or subtle.
MATCHLESS DIMENSIONS,
1" up to 9" thick, 4" up to 20" wide.
Random lengths to 9 feet. Best
selection available in the U.S.
LOWEST COST from a **DIRECT**
IMPORTER. NO MINIMUM ORDER.

A. Eisenbrand, Inc.
4100 Spencer Street, Suite E
Torrance, CA 90503
(213) 542-3576

**SHOPSMITH®
OWNERS**

Make raised panels using our 3 wing
carbide tipped shaper cutters.

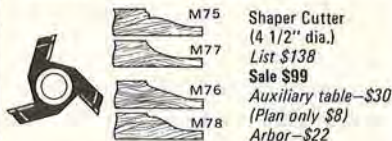

M75 Shaper Cutter
(4 1/2" dia.)
List \$138
Sale \$99
M77
M76 Auxiliary table—\$30
(Plan only \$8)
M78 Arbor—\$22

All prices post-paid to 48 states
Send check, MO; VISA, MC accepted
(C.O.D. - add \$3)

MANNY'S WOODWORKER'S PLACE
602 S. Broadway
Lexington, KY 40508
Toll Free 1-800-243-0713 In Kentucky (606) 255-5444

The Woodworkers' Store®



112 Pages
of Veneers,
Wood Parts,
Specialty
Hardware,
Tools,
Knobs,
Pulls,
Finishing
Supplies,
Books,
Kits & Plans

NEW CATALOG

See the 1985/86 Catalog
Great **NEW** Ideas & Products

Enclosed \$1.00 (3rd Class)
 \$2.00 (1st Class)

Name _____

Address _____

City/State/Zip _____

The Woodworkers' Store
21801 Industrial Blvd. Dept. J404
Rogers, MN 55374

**SCROLL SAW
OWNERS—
Lettering Layout
Guides!**

- Use our specially designed guides to layout letters & numbers to be cut from wood or other materials.
- Made from a durable plastic material.
- Several styles & sizes.

Send \$3.00 (Refundable with first order)
for descriptive brochure & prices to:

**SEYCO
SALES**

1238 Bardfield
Box 472749
Garland, Texas 75047

22 1/2° OCTAGON GAUGE

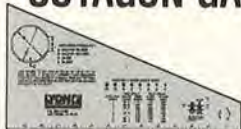

TO SET MITER TO SAW BLADE FOR
22 1/2° CUT. HARDENED ALUMINUM
GAUGE HAS OCTAGON FORMULAS
AND 14" RULER SCREENED ON. ALSO
SCREW CHECKER AND INFORMATION.

\$7.95 Plus \$2.00 Handling
and Shipping

California residents add 6% sales tax. Send check or
money order to:

**LYON ELECTRIC
COMPANY, INC.**
P.O. BOX 81303 SAN DIEGO, CA 92138

PRICED RIGHT!

PORTER+CABLE
PROFESSIONAL POWER TOOLS

**Speed-Bloc® Model 330
Finishing Sander**

List Price \$7.50

NOW \$5.95

**FREE
FREIGHT**

FULL LINE DIST. ...
FACTORY AUTHORIZED SERVICE

a c m e Electric

TOOL CRIB OF THE NORTH

CALL TOLL FREE FOR MIKE
1-800-358-3096



585 Outdoor Chair & Loveseat

UPDATED VERSION OF A CLASSIC DESIGN
DURABLE SEATING FOR DECK OR LAWN

The WORKSHOP
BLUEPRINT COMPANY
P.O. Box 65725
West Des Moines, Iowa
50265

PLAN #585\$8.95
POSTAGE & HANDLING...\$1.50
TOTAL\$.....
Iowa Res. Add Sales Tax

PEG
TEN POUNDS IN A PAIL!

by **Pitco**

Box 1328
Pittsburg, KS 66762
316-231-0000

Complete Catalog—124 Pages
\$4.00...Reimbursed on first order



**FREE
Tool
Catalog**

**Quality
Products For
Woodworkers**

Send today for your **FREE** copy of our new
colorful catalog. It's fully illustrated with
the finest quality tools, supplies, books,
components, hardware, and much more.
Satisfaction Guaranteed.
Write today for your FREE catalog.



WOODCRAFT SUPPLY CORP.
Dept. WBH36
41 Atlantic Avenue, Box 4000
Woburn, Massachusetts 01888

"Those Yellow Wheels..."
**ANTI-KICKBACK
STOCK FEEDER** A **Shop helper**
PRODUCT

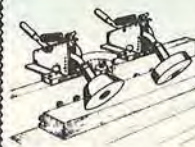

- HOLDS STOCK DOWN AND AGAINST FENCE
- MINIMIZES CHATTER
- EASILY MOVED TO TABLE SAWS, SHAPERS, RADIAL ARM SAWS, ROUTER TABLES, ETC.

Set, complete with brackets, **\$79.50**
Additional Mounting Brackets available.

Mfg. by Western Commercial Products

To order, call: 800-344-7455; CA 800-828-8833
Or write: P.O. Box 238, Tulare, CA 93275
—Dealer Inquiries Invited—

Backyard Gardeners: Don't Buy a Big Tiller... For a Small Job!



Buy a Mantis!

Big tillers weigh almost 300 lbs. Mantis weighs just 20 lbs. (women and older gardeners love it!)

Simply turning a 300-lb. tiller in a backyard garden is a challenge. Mantis starts with a flick of the wrist... turns on a dime... and weeds between narrow rows and along fence lines.

The Mantis takes the work out of growing flowers and vegetables... so you can have more time to enjoy the results!

Most big tillers were designed to just till, Mantis was designed from the beginning for a variety of useful attachments. Tiller. Weeder. Furrower. Edger. Lawn Aerator. Lawn De-Thatcher. Hedge Trimmer.

Best of all, Mantis costs a fraction of what you'll pay for a big tiller.

3-Week In-Your-Garden Trial

Mantis has a *Lifetime Warranty* on the tines (if they ever break, we'll replace them). A *Lifetime Replacement Agreement* on the engine. And a *3-Week In-Your-Garden Trial* (if you don't like it, we'll take it back and give you a full refund).

"What a pleasure to use. Never again will we have to rent a tiller, work like crazy to get it back on time, need two people to put it into and out of the car, get bounced all over and wind up with sore arms and headaches."

Ruth and Patrick Eagen
Hempstead, New York

EARLY ORDER BONUS!

Mail this coupon today.

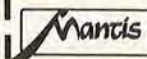

Mantis Manufacturing Co.
1458 County Line Rd., Dept. 867
Huntingdon Valley, PA 19006

Please send more information on the Mantis Tiller/Cultivator... and your 3-Week Trial!

Name _____
Address _____
City _____
State _____ Zip _____

4 GREAT ACCESSORIES

Continued from page 65

Drill-chuck attachment

Mounting a drill chuck lets you perform several more tasks on the multi-machine. (See the Buying Guide at right for a few items we used.) Be sure to wear safety goggles when using attachments!

BUYING GUIDE

● **Drill chuck.** Hardened steel, nickel-chrome alloy jaws. Holds bits with $\frac{5}{64}$ "- to $\frac{1}{2}$ "-diam. shanks. Fits $\frac{1}{2}$ -20 threaded shaft. Sears stock no. 9GT2980, \$11.

● **Pneumatic sanding drum.** 1x6", in-

Grinding wheel and guard

For general-purpose sharpening or for removing lots of steel fast, you can't beat this attachment. Set your multi-machine to the proper speed, adjust the tool rest angle, position the eye shield, and let the sparks fly.

1 Cut parts A, B, and C to the size listed in the Bill of Materials.

2 Using the Grid Patterns shown, transfer the shape of A, B, and C onto the appropriate stock (don't forget to mark hole positions). Then, cut the pieces (A, B, C) to shape. Clamp, but do not glue, the pieces together. Mount the grinding wheel to the arbor shaft, and test-fit the clamped-up guard over the wheel. With the guard positioned over the grinding wheel, mark the location of the $\frac{3}{8}$ " hole needed in A through the previously drilled hole in the cabinet side. Drill a $\frac{3}{8}$ " hole through A to match the hole in the cabinet. Remove the

Bill of Materials					
Part	Finished Size			Material	Qty.
	T	W	L		
A	$\frac{3}{4}$ "	4"	12"	plywood	1
B	$1\frac{1}{2}$ "	4"	10"	pine	1
C	$\frac{1}{8}$ "	4"	10"	plywood	1

Supplies: 1- $\frac{5}{16}$ " flat washer, 1- $\frac{3}{8}$ " x $1\frac{1}{2}$ " flathead machine screw, 1- $\frac{3}{16}$ " wing nut, 1- $\frac{3}{16}$ " x $2\frac{1}{2}$ " hex head machine screw, 1- $\frac{9}{16}$ " x 1" hex head machine screw, 1- $\frac{3}{8}$ " T-nut, 1- $\frac{5}{16}$ " T-nut, 1- $\frac{1}{8}$ "-brass pin 1" long (we bought $\frac{1}{8}$ " brass rod at a hobby shop; it's also available at welding supply shops).

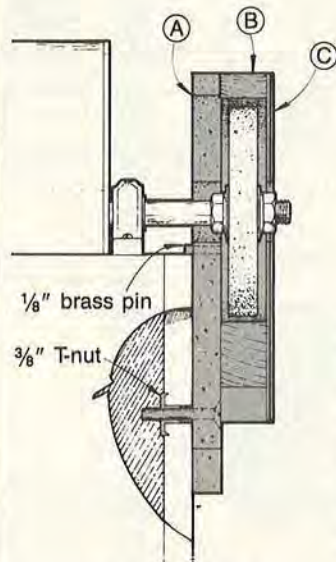

FRONT VIEW

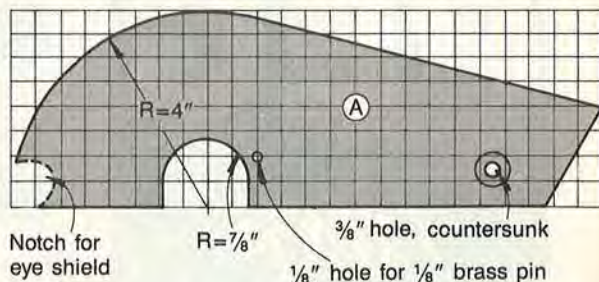
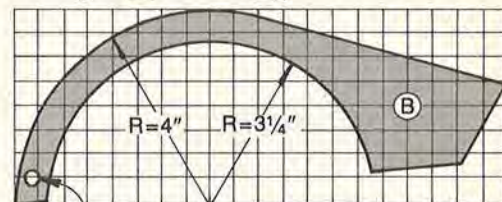
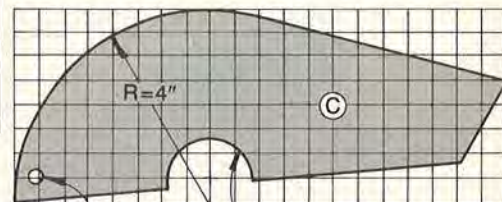

GRIDDED SIDE VIEWS Each square = $\frac{1}{2}$ "

flatable, stock no. E-Z106, \$115. Sold by North West Carving Supplies, P.O. Box 5211, Bozeman, MT 59715.

● **Heavy-duty contour sander.** Includes a wheel with a 1/2" reducer bushing, an abrasive coil, and eight brushes.

Sears stock no. 9GT64861, \$14.

● **Strip 'n Sand Mini Stripper Kit.** Kit includes five flexible wheels plus quick-change mandrel and shank. Each wheel (1x2 1/2" diam.) has dozens of abrasive flaps. Sears stock no. 9GT25246, \$17.

clamps and countersink the 3/8" hole in guard piece A.

3 Glue and clamp the pieces together. Later, sand the guard.

4 Drill a 1/8" hole through A for the brass pin. (The pin rests on top of the multi-machine's side panel as shown in the Front-View Drawing.) Cut a piece of 1/8" brass rod to 1" long, and epoxy it in the hole. (The pin should protrude at least 1/4" on the cabinet side of A and should *not* protrude on the inside of the guard where it could strike the grinding wheel when in use.)

5 Notch out areas on the front sides of the guard for mounting of the plastic eye shield. Drill a 1/4" hole through the notched area. Attach the eye shield to the guard and the guard itself to the multi-machine. (The eye shield should swing back and forth in the notch.)

6 Hold the tool rest against the cabinet as shown in the photo on p. 65; mark the location of its mounting hole. Drill the hole and

mount the tool rest. With the machine *unplugged*, spin the wheel by hand, checking that it does not touch the guard or tool rest.

7 Remove the guard from the cabinet, and remove the eye shield from the guard. Paint the guard.

8 Reattach the eye shield to the guard, and guard to the cabinet.

BUYING GUIDE

● **Aluminum-oxide grinding wheels.** 6" size fits 1/2" shaft. Fine, 100 grit, 6x1 1/2"—no. 9GT64319, \$6.19. Medium-fine, 60 grit, 6x1 1/2"—no. 9GT64209, \$6.19. Medium-coarse, 36 grit, 6x1 1/2"—no. 9GT64352, \$6.19. Sears.

● **Tool rest and arm.** Parts from a Sears Industrial Grinder. L.H. tool rest—Sears stock no. 4656, \$1.99. Tool rest arm—Sears stock no. 521935, \$2.99.

● **Eye Shield.** From a Sears Industrial Grinder. Stock no. 4971778, \$3.99. ♣

Project Designs: James Downing
Photographs: Hopkins Associates
Illustrations: Kim Downing; Bill Zaun

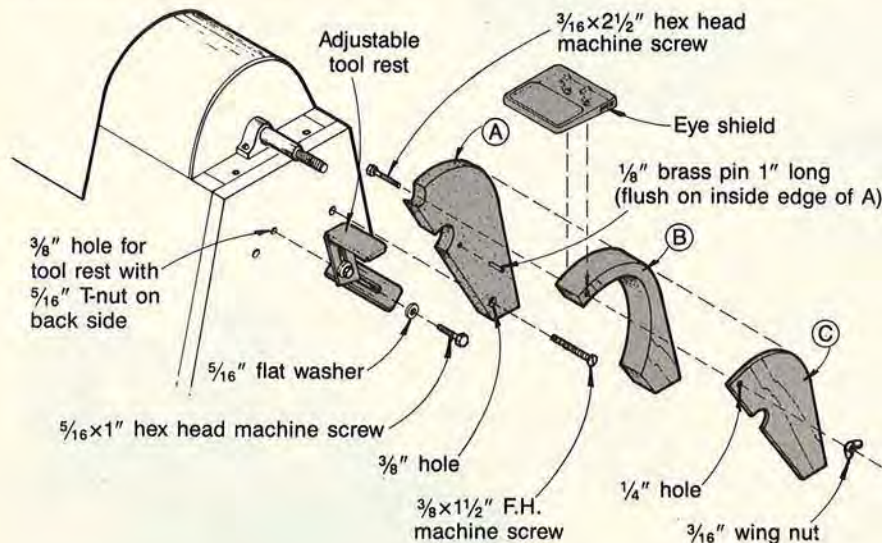

NOW! Get in on the PROFITS in

SMALL ENGINE REPAIR!



Start your own money making business!

Work part time, full time—right at home—we help you every step of the way.

No doubt about it... as a small engine pro, you can cash in on the huge demand for qualified men in one of America's fastest growing industries. You'll be able to command top hourly rates of from \$25.00 to \$30.00 per hour—and that's just for labor. A simple tune-up earns as much as \$49.95 for less than an hours work, and parts, engines and accessories will add even more to the profits.

Plenty of business waiting for qualified men.

65,000,000 Small Engines Are In Use Today! That's the official count from the Engine Service Assn., and one-million new engines are being built each month. With fully accredited Foley-Belsaw training, you can soon have the skills and knowledge to make top money servicing these engines. People will seek you out and pay you well to service their lawnmowers, tillers, edgers, power rakes, garden tractors, chain saws, minibikes, snowmobiles, generators, go-carts, paint sprayers, snowblowers... the list is almost endless.



Professional Tools and Equipment, PLUS 4 H.P. Engine ALL YOURS TO KEEP... All at No Extra Cost.

NO EXPERIENCE NECESSARY!

You don't need to be a 'born mechanic' or have any prior experience. You can master this profitable trade right at home in your sparetime. Lessons are fully illustrated... so clear you can't go wrong, and with our famous 'learn-by-doing' method you get practical 'hands-on' experience. We also show you how to get business, what to charge, where to get supplies wholesale... all the inside tricks of the trade you need to assure success right from the start.

Send for FREE Facts—Do It TODAY!

NO Obligation—NO Salesman Calls!
You risk nothing by accepting this offer to see how easily you can learn the skills you need to increase your income in a high-profit business of your own. Just fill in and mail coupon below (or send postcard with name and address) to receive full information by return mail.

RUSH COUPON TODAY

Foley-Belsaw Institute
50856 Field Building
Kansas City, MO 64111



FREE BOOKLET!

Send for your copy today!

FOLEY-BELSAW INSTITUTE
50856 FIELD BUILDING
KANSAS CITY, MO 64111



YES, please send me the FREE booklet that gives full details about starting my own business in Small Engine Repair. I understand there is No Obligation and that No Salesman will call on me.

NAME _____

ADDRESS _____

CITY _____

STATE _____

ZIP _____

Whether your woodworker's license reads "Beginner," "Intermediate," or "Expert," you're bound to have a few questions about your favorite hobby. We can help. Each issue, we'll consult our experts for answers to your most-asked questions. Send your questions to:

Ask **WOOD**
Better Homes and Gardens®
WOOD Magazine
 Locust at 17th
 Des Moines, IA 50336

Letters selected for use will be edited for publication.

THE NITTY-GRITTY OF SANDING

Q. *What's the normal progression of sandpaper to use for finishing a flat surface? I never seem to get as smooth a finish as I want.*

—Helen Clark, Ft. Lauderdale, Fla.

A. To prepare the surface for finishing, we advise you to start with a 60-grit garnet paper. Follow up with 80-grit, 100-grit, and 150- or 220-grit paper. After applying the first sealer coat, sand lightly with 220- or 320-grit. From that point—and until you're satisfied with the finish—use 320-grit between coats. This may sound like a lot of grits, but a truly fine finish requires elbow grease! There's no magic involved. Remember: From rough-sanding to final finishing, always use a sanding block or pad to prevent leaving any finger marks and streaking. You'll be much happier with the results.

STRAIGHT FACTS ABOUT WARP

Q. *The only board I have left to finish a project is badly warped. Is it possible to take the warp out of a board so I can still use it?*

—Dick Howard, San Diego, Calif.

A. Unfortunately, once a board has warped—even slightly—you rarely can restore it to its original shape. Even if you forced it "straight," say, by screwing it in place as the side of a cabinet, the pulling strength of the warp would probably cause the whole cabinet to rack. Unless you have enough margin to correct the distortion on the planer, the only solution is to replace the board.

However, all is not lost. Even a severely warped board is too valuable to toss on your scrap pile. Save what you can by cutting out smaller sections of the board for future projects.

The only thing small about this bandsaw is the price!



The new BS-3 Benchtop Bandsaw is BIG...BIG in capacity, performance, convenience and quality...yet it takes up just 1½' x 3' of bench space. Its built-in disc sander adds the BIG advantage of sanding right on the saw. BIG 15" throat. BIG 6¼" cutting depth. BIG quiet-running 3-speed motor has plenty of power for Wood, Metal or Plastic. BIG 16" x 18" worktable tilts up to 45°. This BIG 86 lb. Benchtop Bandsaw comes with a built-in vacuum hook-up, a BIG list of accessories (drum and belt sanding, and more) ...and BIG Buyer Protection. Call or write today. If you think that high quality has to mean high price ...you're in for a real surprise.

emco★**USA**™

Dept. BW36B • 2080 Fairwood Ave.
 P.O. Box 07795 • Columbus, OH 43207

1-800-521-8289

(In Ohio: 614/445-8382)

RIPSTRATE®

**The Finger Saver
 That Saves Work
 And Improves the Job**

Most safety devices require frequent adjustment. They usually wind up in a corner, not saving anything at all.

The RIPSTRATE guides the work against the fence. It requires no adjustment. No hands near the blade. No leaning over the saw table. No spoiled stock. NO KICKBACKS. No hassle. Just straight, clean cuts.

No wonder thousands of woodworkers, from amateur and professional craftsmen to large corporations, to government institutions, to colleges, to Air Force bases, now regard the RIPSTRATE as an essential part of their woodworking shops. After all, we are only born with ten fingers.

30 day money back trial. One year guarantee. \$62.50 plus \$3.50 shipping. Check, M.O., Visa or M/C. Free brochure.

Write or call our toll free number.
800 421 0256

FISHER HILL PRODUCTS
 4 Fisher Hill
 Fitzwilliam NH 03447



Dealer inquiries invited.

GETTING TO THE CENTER OF THINGS

Q. I know I should remember this from high school geometry, but how do I find the exact center of a round tabletop (or any circle)?

—R.A. Dickelman, West Des Moines, Iowa

A. Here's how it's done: From any two points (A) on the circumference of your table, use trammel points to mark equidistant points (B and C) on both sides of both starting points. Then open up the distance on your trammel points a bit, and arc from each of the second pair of points (B and C) to determine two interior points (D and E).

Use a straightedge to connect your two starting points (A) with the interior points (D and E). Now you have it: The center (F) will be the point where those two lines (A-D and A-E) meet.

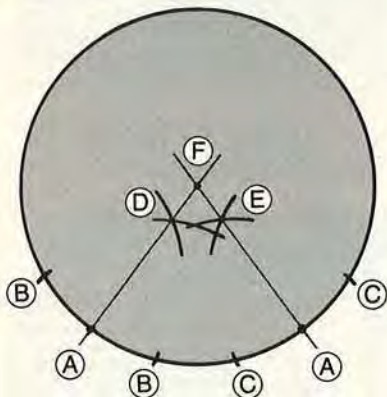

GLUE TIGHT!

Q. How much glue space should I allow for in a joint?

—Ralph Hendrickson, Geneva, Ill.

A. In a word, none. The strength of any glued joint depends on a solid mating of the surfaces forming the joint, and the glue you use. Measuring carefully before you cut is the key to a good joint. Because white glue thickness should be only about .001" (believe it or not) after clamping the joint, white glue won't even take up the slack in a cut that's just slightly off. ♣

EXCALIBUR 24 • EXCALIBUR II Make The Precision Decision

To Order Call Toll Free **1-800-387-9789**

EXCALIBUR 24" c/w 1/4 Hp Var. Speed Motor & HD Stand



Excalibur 24's are working to exacting standards in industrial and commercial settings in schools and other institutions, and in the homes of dedicated hobbyists across the country.

Excalibur Precision Scroll Saws At-A-Glance

	Excalibur 24	Excalibur II
Throat	24"	19"
Cutting Depth Maximum	2 1/2"	2"
Length of Cutting Stroke	1 1/2"	1 1/2"
Cutting Speed	6-1800*	1100 Single-Speed motor 800 speed 400 motor 6-1800 variable-speed motor*
Worktable adjustment Right	20°	45°
Left	45°	45°
Worktable Width	14"	12"
Worktable Depth	24"	17 1/2"
Overall Length	33"	37"
Overall Width	20"	12"
Overall Height	21"	14"
Weight	110 lbs	45 lbs

*Rpm (strokes/minute)

SHIPPED
FREIGHT COLLECT
\$495.
US
NO OTHER CHARGES

EXCALIBUR II Less Motor & Switch



The budget-respecting Excalibur II accepts any motor to become the true craftsman's dream with features unparalleled at its price.

SEND FOR OUR CATALOG OF OTHER FINE WOODWORKING MACHINES

J. Philip Humfrey International

3241 Kennedy Road, Unit 7
Department WM3/4
Scarborough, Ontario M1V 2J9 (416) 293-8624

I enclose \$1.00 (refundable against purchase). Please rush my catalog.

Name _____

Address _____

City _____ State _____ Zip _____

Bosch Router Bits



STRAIGHT BIT TWO FLUTE

PART #	DIA.	CUT LGTH.	SHK	LIST	SALE
85250M	1/4	7/8	1/4	11.80	8.85
85460M	1/4	7/8	1/2	14.90	11.15
85225	3/8	7/8	1/4	12.25	9.15
85241M	3/8	1	1/2	14.30	10.70
85227	1/2	7/8	1/4	12.70	9.50
85251M	1/2	2	1/2	17.40	13.00
85232	3/4	5/8	1/4	14.85	11.10



CORNER RD BIT TWO FLUTE

PART #	RAD.	CUT LGTH.	SHK	LIST	SALE
85294M	1/4	35/64	1/4	26.00	19.40
85296M	3/8	43/64	1/4	28.05	20.95
85594M	3/8	43/64	1/2	34.95	26.10
85297M	1/2	51/64	1/4	30.65	22.90
85595M	1/2	51/64	1/2	36.15	27.00

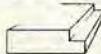

RABBETING BIT TWO FLUTE

PART #	RAB.	CUT LGTH.	SHK	LIST	SALE
85218M	3/8	1/2	1/4	24.15	18.05



ROMAN OGEE BIT TWO FLUTE

PART #	RAD.	CUT LGTH.	SHK	LIST	SALE
85270M	5/32	15/32	1/4	31.80	23.75
85271M	1/4	25/32	1/4	33.95	25.35
85592M	1/4	25/32	1/2	43.15	32.20



CHAMFER BIT TWO FLUTE

PART #	BEV.	CUT LGTH.	SHK	LIST	SALE
85298M	45°	5/8	1/4	27.70	20.70
85597M	45°	5/8	1/2	27.85	20.80



COVE BIT TWO FLUTE

PART #	DIA.	CUT LGTH.	SHK	LIST	SALE
85205M	1/4	1/2	1/4	28.95	21.60
85206M	3/8	9/16	1/4	29.05	21.70
85207M	1/2	5/8	1/4	29.95	22.35



CORE BOX BIT TWO FLUTE

PART #	DIA.	CUT LGTH.	SHK	LIST	SALE
85444M	1/4	3/8	1/4	16.20	12.10
85445M	3/8	5/16	1/4	22.45	16.75
85446M	1/2	3/8	1/4	23.05	17.20
85447M	5/8	7/16	1/4	23.05	17.20
85448M	3/4	1/2	1/4	23.70	17.70



LAMINATE TRIM BIT THREE FLUTE

PART #	DIA.	CUT LGTH.	SHK	LIST	SALE
85216	1/2	1	1/4	20.10	15.00

REPLACEMENT BALL BEARINGS

PART #	I.D.	O.D.	LIST	SALE
10010	3/8	1/2	4.30	4.10
10020	3/16	1/2	3.85	3.65

PME
WOODWORKING SUPPLIES
1525 Garcia NE
Albuquerque, NM 87112

Qty _____ Part _____ Price _____

Shipping _____ 2.95

Total _____

Name _____

Address _____

Zip _____

VISA/MASTERCARD

Exp. Date _____
Send SASE for a FREE brochure of our complete product line.

**If Your Grandfather
Didn't Leave You His...**



DELTA

**Free Ripfence
Free Worklight
\$93.50 Value**

For over 40 years now, the most popular bandsaw made.

For toymaking to furniture making, whether you're re-sawing, cutting curves or ripping, a bandsaw gives you the most flexibility.

Sturdy cast iron components make this machine stable and smooth running.

Height capacity is 6-1/4". Large 14" square table tilts 45 degrees right and 10 degrees left and is machined to accept standard Delta 3/8" x 3/4" miter gauge. Weighs 224 lbs. with motor and stand. The 28-858 flexible neck lamp uses standard appliance bulbs. The 28-845 ripfence package comes with 32" bars. Motor is 1/2 HP, ball bearing, 1725 RPM.

(Remember, we pay the freight.)

28-243 Delta 14" Bandsaw with Motor, Stand, FREE Worklight and Ripfence
List \$808.50/SALE \$599.00 delivered.

**Woodworker's
Supply**

(OF NEW MEXICO)

5604 Alameda, NE • Dept. WO
Albuquerque, NM 87113

Toll-Free: 1-800-645-9292

VISA/MC

**AND NOW
THE REALLY
BAD NEWS.**



The disaster isn't over when the emergency teams leave. For tonight these families need food, clothing, shelter. Tomorrow they'll start rebuilding their lives.

And that takes months.

The good news is that the Red Cross will help these families every step of the way.

No matter how long it takes.

If you ever need the Red Cross you can bet we'll be there.

We'll help. Will You?

American Red Cross 

Ad Council A Public Service of This Publication

**BUILD WOOD'S AMAZING
Multi-Machine the E-Z Way**
(As seen on Pg.40 Feb. issue of WOOD)
E-Z Kit AM300 includes all mechanical parts needed for WOOD'S Project

1. Mandrel 5/8" shaft 1/2"-20rh-lh threads (Bronze sleeve bearing pillow blocks)
2. 5/8" bore pillow blocks(ball bearing)2
3. 2" Pulley (2) 7.1/2"x38" pulley belt
4. 10" Pulley 8.1/2"x50" pulley belt
5. 4 step pulley (2) 9. Toggle switch
6. 5/8"x16 1/4" jackshaft \$117.50

Shipping & Handling included
E-Z Kit AM301 same as above except mandrel has heavyduty ball bearing pillow blocks. \$142.50 includes S&H.

For catalog send \$2.00(refundable) to:
North West Carving Supplies/ Box 5211
Bozeman, MT 59715

WOODWORKERS

Save on Wood - Tools - Supplies!

**OVER
4000
ITEMS**

Send for
New 1986
148 Page
Money Saving
CATALOG



**Finest Dimensioned
HARDWOODS and
Quality VENEERS**

42 Varieties 1/64" to 4" Thickness

Fast service on choice kiln dried Wood and Veneers, Moldings, Trim, Hand and Power Tools, Lamp Parts, Upholstery Supplies, Clock Movements and Kits, Hard-to-Find Hardware, Finishing Materials, Books... over 4000 items in stock! Craftsman—Woodworker's best friend.

\$3.00 Discount Coupon good on first order.

FREE with Catalog!

CRAFTSMAN WOOD SERVICE

Dept. K-46 1735 W. Cortland Ct., Addison, IL 60101
Please enclose \$1.00 to help pay postage and handling

NEW

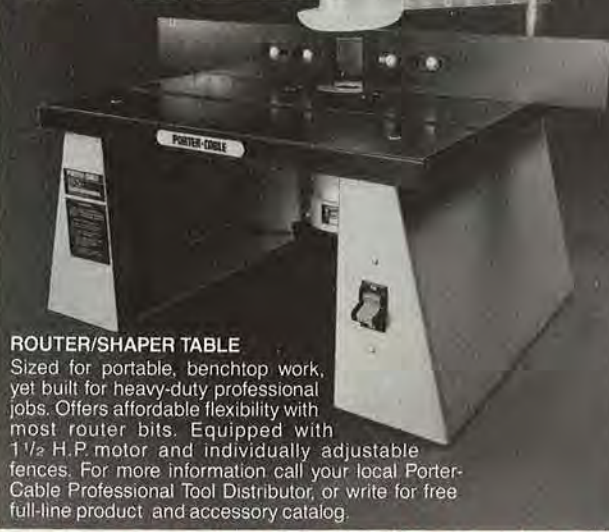

ROUTER/SHAPER TABLE

Sized for portable, benchtop work, yet built for heavy-duty professional jobs. Offers affordable flexibility with most router bits. Equipped with 1 1/2 H.P. motor and individually adjustable fences. For more information call your local Porter-Cable Professional Tool Distributor, or write for free full-line product and accessory catalog.

PORTER-CABLE

PROFESSIONAL POWER TOOLS

P.O. Box 2468 • Advertising Dept. • Jackson, TN 38302-2468

**SAVE \$100'S
ON ARMOIRE!
FULL-SIZE PLANS**



FOR 3 SIZES

Loads of storage space with 68" h x 20" d Armoire. Has 6 deep drawers and adjustable shelves, or shelves only for TV-VCR. Can use tie-bar or mirror inside doors. Plans and directions for all 3 widths: 36", 42", 48". ONLY \$11 on Money-back Guarantee. Send for FREE illustrated furniture catalog.

FLEXIPLANS, Dept. GL
48 Lowell St., Westwood, NJ 07675

**Love-Built Toys
and
The Toymaker Supply Co.**

NEW — Midwest Location!
105 Weiler Rd. T34
Arlington Hts., IL 60005

NEW — Toll Free Phones!
1-800-624-3938
(In IL 1-800-358-4208)

NEW — LOW PRICES!

For Volume Purchases of Quality Toy Parts... Write or Phone Today for Fall Catalog!





At last! A wood filler for the big jobs.

Now there's a wood filler that can rescue damaged and even rotted wood—High Performance Wood Filler by Minwax.

It won't shrink, crack, or fall out. It hardens in only 15 minutes and can be sanded, planed, drilled, carved, painted, or stained in less than half an hour. And it's weather, water, and rot resistant.

It repairs almost anything made of wood, indoors or out. From windowsills and decks to woodwork and furniture... it's the wood filler for the big jobs. Look for it at your favorite store. For more information, send in the coupon.

High Performance Wood Filler to the rescue!



Minwax Company, Inc., Dept. WO-036
P.O. Box 426, Little Falls, NJ 07424
Please send free information package.

Name _____
Address _____
City _____ State _____ Zip _____



Minwax makes wood beautiful

PRODUCTS THAT PERFORM

 Print this article



A box full of molding combinations

You can produce several different moldings by using varying combinations of the four router bits in this set. (We used three of the bits on our router table to make the molding shown in the photograph.) Two of the bits are carbide-tipped and two are steel; all have 1/4" shanks. The set also includes a plastic case for safe storage and an instruction sheet diagramming seven moldings to get you started. *Crown Molding Bit Set* (no. 21255), \$40 in the 1985/86 *Sears Tool Catalog* and at larger *Sears* stores.



Spray-on suede lining

Spray a soft touch on any project—the inside of a jewelry box, the outside of a child's toy, or the bottoms of bookends—without having to cut and paste odd-shaped pieces of felt. The starter kit includes everything necessary to cover 30 square feet of surface; brown and green fibers come with the kit, but 22 other colors are also available. An adhesive undercoat is provided. *Suede-Tex Kit* (catalog no. 115), \$46.50 postpaid. *Donjer Products Company*, 55D Alder St., Dept. W, West Babylon, NY 11704.



The story of the boards and the bees

A traditional polishing wax made from beeswax and turpentine (the latter makes application easier), this paste goes on smoothly, dries quickly, and produces a natural shine after a light buffing. According to the manufacturer, the wax is suitable for oak, pine, and any stripped or dried-out woods; our tests on dark walnut and light oak produced excellent results. *Beeswax Polish Paste*, \$5.60 postpaid. Available from *Liberon Waxes, Inc.*, P.O. Box 1750, Dept. W, Mendocino, CA 95460.

The World's Least Expensive Scroll Saw?



That's right. If you've been considering purchasing a scroll saw, you may have thought you couldn't afford a **HEGNER**. Many of our customers used to think so, too.

But they learned, some of them the hard way, that it costs more to use the wrong tool than to buy one that will do the job right and keep doing it for years and years. In the long run, the best usually costs the least!

That's why more people switch from other makes to **HEGNER** than to any other: **HEGNER** is proven to be the best!

Use the coupon below for free information today!

AMI Ltd. is your source for HEGNER Saws, Lathes and Duplicators; FELDER Woodworking Systems; FLOTT Jointer/Planers and Table Saws; and Lachappelle Workbenches.

Please send me free information on **HEGNER** Precision Scroll Saws.

Name _____
 Address _____
 City, State, Zip _____
 Phone _____



ADVANCED MACHINERY IMPORTS
 AMI, Ltd., PO Box 312, Dept. 67
 New Castle, DE 19720
 302-322-2226

PRODUCTS THAT PERFORM



Fumble-free frame clamping

One of the biggest problems with picture-frame clamps is that it takes forever to adjust them. This rig has the solution: brass thumb nuts that slide freely along the threaded rods until you lock them against the corner blocks. An extension set (with four threaded rods and four coupling nuts) is available. *Picture Frame Clamp* (catalog no. 47F01.01), \$19.50 postpaid. We ordered ours from Garrett Wade Co., 161 Avenue of the Americas, Dept. W, New York, NY 10013. In Canada, send \$21.75 (Canadian) to Lee Valley Tools Ltd., Dept. W, 2680 Queensview Drive, Ottawa, ON K2B 8H6, Canada.



Avoid pegboard fallout

Here's a real temper-saver: a rubber grommet that keeps pegboard hooks from popping out when you grab a tool. They fit $\frac{1}{8}$ " hooks in $\frac{1}{4}$ " perforated hardboard, but you can drill out the holes in $\frac{1}{8}$ " pegboard to accept them. An inserter tool is included with each bag of 10. *Peg-Lox*, \$1.25 per bag plus \$1 postage per order. Steiner Specialty Company, P.O. Box 884, Dept. WD-10, Lancaster, OH 43130.

THE DOOR SHOP™

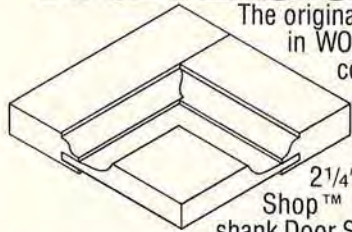

The original Ogee **DOOR SHOP™** as featured in **WOOD MAGAZINE (MAY/JUNE 85)** is complete with stile & rail, slot & panel raising bits for the 1/4" chuck router. Bits are carbide tipped & BB & will make 3/4" thru 2 1/4" thick raised panel doors. Door Shop™ & Manual \$89.50 ppd. The 1/2" shank Door Shop™ now available.

The 35 page **DOOR SHOP™ MANUAL** is clearly written and beautifully illustrated with over 156 detailed drawings covering the complete process of door building. Each section covers proper methods and exact set ups for the router, including how to recognize and correct for errors. There are sections covering Design, Lumber selection, Measuring, Panel Raising, curved & straight Rail and Stile cutting & fitting, Guides, Clamping, Gluing and Finishing. This is the most comprehensive manual out today. When purchasing the Door Shop™ manual for \$5.00 you also receive Zac's 32 page Router bit and Shaper cutter catalog free. \$5.00 rebated with purchase of our Door Shop™ or Panel Raiser™ bits.

Zac's carbide tipped **PANEL RAISER™** router bits come in 3 styles; **OGEE, COVE, & PROVINCIAL**. All 1/2" shank bits are 3 1/2" in diam., with BB & give a full 1 1/2" raised panel. \$99.50 @ ppd. All 1/4" shank bits are 2" in diam. & give a 1" or larger raised panel cut. \$65 @ ppd.

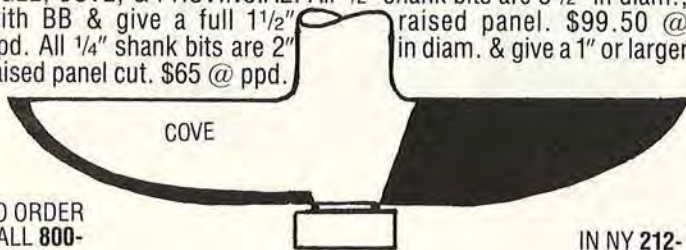

TO ORDER
CALL 800-
441-0101

IN NY 212-
947-4496

ZAC PRODUCTS INC. 533 West 34th Street NYC, NY 10001

MAKITA • PORTER CABLE • ROCKWELL • BOSCH • LION
BLACK & DECKER • MILWAUKEE • FORSTNER • JORGENSEN • 3M • W.L. FULLER
MARPLES • RECORD • WATCO • NU-LIFE • DOWEL-IT-CLESCO • GILLESPIE • FREUD



DELTA SPECIALS

	Model	Price
V.S. 18 in Scroll Saw	40-601	799.00
10 in Tilting Arbor Saw	34-429	899.00
10 in Unisaw 3 H.P.	34-763	1599.00
H.D. Wood Shaper	43-375	1769.00
8 in Joiner Long Bed	37-315	1379.00
Sawbuck	33-150	525.00
Unifeeder	34-150	249.00
13 in Planer RC-33	22-651	1199.00
14 in Band Saw Complete	28-243	549.00
6 in x 48 in Sander Complete	31-730	1199.00
1 H.P. Dust Collector	50-180	365.00
17 in Drill Press	17-900	244.95

- WE HONOR ALL FREUD NATIONALLY ADVERTISED SPECIALS
- WRITE FOR NEW FALL-WINTER CATALOG
- VISA, MASTERCARD ACCEPTED

1411 ASSEMBLY STREET, P.O. BOX 1762
COLUMBIA, S.C. 29202-1762
803-779-3131 EXT. 12

HEGNER • STANLEY • GREENLEE • HENCKELS • MERIT

IDEA PORTFOLIO

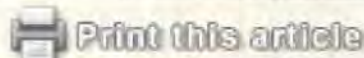

GALLERY-QUALITY PLANT PEDESTALS

All too often, greenery and other special display items go unnoticed for want of a place to show them off. You can change all that with these impressive, easy-to-build pedestals.

While they're really nothing more than basic boxes built with the simplest of all joinery techniques—butt joints—these pastel-colored pedestals will earn their keep in many a contemporary decor. We used 3/4" particleboard to frame up the cubes, all of which measure 8" square and range in height from 8" up to 36" (3/4" plywood would also work fine). Then, we covered the sides, front and back, and finally the top of each with Solicore®, a new solid-color surfacing material from Wilsonart. (Several other companies have this same product under other trade names.) The chief advantage of using a product with color all the way through is that with it you can minimize the visual impact of the seam lines.

A word to the wise when working with these new solid-color materials: Handle them with extreme care, as they are much more brittle than plastic laminate. And be sure you work them with carbide-tipped cutters when cutting on your table saw and trimming with your router. 🌿



Design: James R. Downing Photograph: Perry Struse

SLEEK AND SIMPLE END TABLE CUBE

With today's generation of designer plastic laminates, even the simplest of designs can become a feast for the eyes. The muted geometric pattern laminate used here speaks softly but distinctively of your good taste.

One of the most intriguing things about cubes is that they're so versatile. Here we built ourselves an 18"-square plywood cube that stands 18" tall. Then we covered it with Formica-brand Burgundy Maxi Graph plastic laminate. But we could have just as easily altered the dimensions of the cube and made it into a coffee table, nightstand or even a sofa table. And by adding doors and/or drawers, we could have built additional function into the unit.

When applying any of the new patterned laminates, you need to pay careful attention to alignment of the pattern. Otherwise, when you trim off the excess laminate, the pattern may run unevenly along the edges of the item you're building. A few extra minutes spent aligning will solve this problem. You also need to take special pains to square up the corners of the project when assembling the carcass. (For more information about what's available in plastic laminates, please turn to the article on page 76.)



Design: James R. Downing Photograph: Perry Struse



Don't Miss These

VANCOUVER SHOW

Hyatt Regency Vancouver
Vancouver, British Columbia
Friday, March 14, 5pm-9pm
Saturday, March 15, 10am-6pm
Sunday, March 16, 10am-5pm

NEW ENGLAND SHOW

Springfield Civic Center
Springfield, Massachusetts
Friday, April 11, 5pm-9pm
Saturday, April 12, 10am-6pm
Sunday, April 13, 10am-5pm

KANSAS CITY SHOW

Kansas City Market Center at Executive Park
Kansas City, Missouri
Friday, May 2, 5pm-9pm
Saturday, May 3, 10am-6pm
Sunday, May 4, 10am-5pm

EXHIBITS, DEMONSTRATIONS & SALES
of
EVERYTHING FOR THE WOODWORKER
FREE SEMINARS

Admission \$5

For More Information
Woodworking Association of North America
P.O. Box 706 • Plymouth, NH 03264 • (603) 536-3876

REPRODUCTION HARDWOODS

for the home craftsman

America's Source for

- Solid Lumber Panels
- Turning Squares
- Plywood
- Butcher Block Stock

All products available in widths
up to 30" and lengths to 60".
Squares up to 5" thick.

RED OAK, MAHOGANY, CHERRY,
WALNUT, HARD MAPLE, POPLAR

Stock is defect free, sized ready to use,
shipped directly to you.

Send \$1.00 for price list
and product descriptions.

Route 9, Box 214-M, Dept. B
Morganton, North Carolina 28655
(704) 433-5490



Cascade Precision Tool Co.

Box 848, Mercer Island, WA 98040

FEATURING CARBIDE TIPPED ROUTER BITS AND SHAPER CUTTERS
KNOWN WORLDWIDE FOR MORE THAN 20 YEARS AS A SYMBOL OF QUALITY



FREE 1/2" DOVETAIL WHEN YOU ORDER THIS SET OF CARBIDE-TIPPED ROUTER BITS INCLUDING 1/4" RABBET, 1/2" OSEE, 1/2" COVE, 1/2" ROUND-OVER, 1/2" AND 1/4" STRAIGHT BITS WITH EXTRA BEARING FOR BEADING.
1/4" SHANK SET \$64.95 PPD. 1/2" SHANK SET \$69.95 PPD.



CARBIDE TIPPED 3-CUTTER-3 STEP ROUTER BIT SET WITH 1/2" SHANK AND 3/2" O.D. PANEL RAISER. \$179⁹⁵

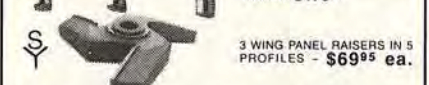

3 WING PANEL RAISERS IN 5 PROFILES - \$69⁹⁵ ea.



5" FACE CUT 15" FACE CUT CONCAVE 12" FACE & QTR RD CONVEX
4 1/4" O.D. WITH 1/4" BORE OR 5 1/4" O.D. WITH 1 1/4" BORE & 1" BUSHING

HEAVY DUTY SHAPER CUTTERS, 3/4" BORE WITH 1/2" BUSHING from \$29⁹⁵

6-PIECE CABINET SETS 3/4" BORE WITH 1/2" BUSHING from \$149

RUB COLLARS W/BUSHINGS, \$22⁹⁵

ORDER BY PHONE WITH VISA/MC OR SEND MO. CHECK, VISA/MC NUMBER, EXP. DATE, PHONE NUMBER, CATALOG \$1 — FEATURING OVER 200 CARBIDE TIPPED ROUTER BITS AND SHAPER CUTTERS.

SATISFACTION GUARANTEED

ORDER TOLL FREE

1-(800) 235-0272

IN WASHINGTON CALL 1-206-236-0272

CHARGE YOUR ORDER

10 AM-7 PM

Monday through Saturday



WOODWORKING VIDEOS

The Next Best Thing to Being There?

Superman, Darth Vader, and old movie classics have a new foe competing for home video stardom—woodworking instruction. Here's a report from *WOOD* Magazine's How-To Editor Marlen Kemmet, who previewed a score of videos for us in recent weeks.

The video boom has arrived on the home woodworking scene in a big way. Two years ago, you would have been lucky to find one evening's worth of instructional woodworking video material. Today, though, you could take a week off work, end up blurry-eyed, and still have a few videos left to watch.

For years, the home woodworker has relied heavily on books and magazines for help with techniques. But with the advent of videotapes, hobbyists can now add an important new medium to their collection of reference materials.

Expert woodworkers are sharing their secrets for all to see in an expanding variety of quality video releases. Techniques range from carving to sharpening and deck-building to bowl-turning in videos that usually last ½ to 2 hours.

Videos aren't cheap. Almost all fall into the \$40 to \$70 range. Fortunately for the cost-conscious woodworker, a few sources have adopted a mail-order rental policy.

You don't have your own videocassette recorder (VCR)? No problem! Video shops that rent both movie videos and VCRs have sprung up on many a street corner. Hooking up one of them to your television set won't take long, either. Usually, you simply fasten a wire or two to the back of the set.

Beware, though: Watching a video can be like going to a new movie you haven't heard much



about. Sometimes you really enjoy it, and sometimes you don't. Whether you buy a video or rent one, make sure you get your money's worth by learning as much as you can in advance.

WHAT TO LOOK FOR IN A WOODWORKING VIDEO

1 Level of instruction. Most videos are geared for beginning to intermediate woodworkers. Shopsmith's "Making Bowls," for instance, is aimed at the beginner, while Taunton Press' "Bowl Turning with Del Stubbs" focuses on advanced techniques.

2 Authority of the instructor. Is the instructor a professional woodworker? Anything less, and you're probably wasting your time. All the videos we viewed had top-notch woodworkers doing the teaching.

3 The approach: No-nonsense or entertaining. James Krenov and his students from the College of the Redwoods take a no-nonsense approach to building fine hand planes. Roy Underhill from the Woodwright's Shop is as entertain-

ing as he is educational when he talks about and demonstrates the use of great-granddad's tools. Decide what style suits you best.

4 Return policy. What happens if the videotape won't work or if you don't like the subject matter? You can return defective videos for a refund or new tape. But if the content fails to meet your expectations, most suppliers will charge you a rental fee, or will refund only part of your deposit.

5 VHS vs. BETA. Videos and players come in two basic types, VHS and Beta. Like eight-track tapes and cassettes, one won't work in a machine built for the other. Most rental shops carry both, but check to make sure before ordering or renting a videotape or player.

VIDEO INFORMATION GUIDE

Interested? Then use the listing below to obtain specific information about buying or renting a woodworking video.

Fine Tool Shops Inc., P.O. Box 1262, 20 Backus Ave., Danbury, CT 06810, 800-243-1037. If you're wondering how to choose the proper hand plane or how to adjust and tune it for perfect shavings, check out "How To Work With Hand Planes: The Bench Plane." The Fine Tool Shops do not have a rental policy per se, but if you are not satisfied and return a video within 30 days, you pay a \$15 rental fee and are credited the difference. Four different videos are priced at \$39.95 each.

Georgetowne, Inc. Video Productions, P.O. Box 625, Bethel Park, PA 15102, 412-854-1887. The three videos we reviewed, titled "World Championship Video Series," show award-winning decoy carver Pat Godin carving and painting a

Continued

LEARN HOW TO BE A MASTER WOODWORKER

with **Donn Fahnestock**
at home—in front of your own TV!

4 complete lessons on each 1 hour video cassette!

ONLY \$39.95 each Beta or VHS

You don't need a shop full of expensive power tools to do magnificent work!

In just a few hours in front of your own TV, you can learn how the experts do it – with a few, carefully chosen hand tools.

Discover the secrets of planing to a satin smooth finish... making perfectly fitted joints... finishing, sharpening, even carving.

If you've ever tried to learn it from a book – or follow a manufacturer's directions – you'll agree Donn's demonstrations are worth a thousand hours of reading, studying plans, and learning by trial and error!

How to Work With Hand Planes...The Bench Plane

- Choosing the right plane for smoothing, leveling, jointing and more
- 3 key adjustments for better, faster, easier planing
- How to avoid round ends and other common planing errors
- Fine tune your plane for a perfect shaving

How to Work with Hand Planes...The Specialty Planes

- How to select the right rabbet plane
- Smoothing knots and erratic grains – the scraper
- Shortcuts to fast wood removal
- 35 problems, one easy solution – the Combination Plane.

How to Make Carcase Joints with Hand Tools

- Grooving – the key to easy, accurate assembly
- Making handsome raised panels with chisel and plane
- How to shape a perfect dovetail joint
- Chisel, saw, marking gauges – all the tools you need!

How to Make Framing Joints with Hand Tools

- Using dowels for quick, professional results
- The half-lap – strength and utility, made with a saw
- A great look with little effort – the slot mortise
- The easy way to cut a perfect mortise with hand tools!

Rentals: Pay the full purchase price. When you return the tape within 30 days, we'll credit your charge card or, if you paid by check, refund your cost in full except for a rental charge of \$10.00 per 30 days or any part thereof.

ORDER TOLL FREE 1-800-243-1037

In CT, 797-0772

CLIP AND MAIL TODAY!



BUYMANSHIP BASICS

WOODWORKING VIDEOS

Continued

canvasback decoy. The three videos focus on forming the feather groups, creating the feathers, and how to paint the decoy. Videos No. 1 and 3 are \$59.95, and video No. 2 is \$39.95, or order the set for \$149.95. No rental policy.

Mahogany Masterpieces, RFD 1, Wing Rd., Suncook, NH 03275. Four videos on Japanese master toolmakers. Prices range from \$30 to \$50. The videos rent for one week at \$20-\$25, plus a \$25 deposit. (No videos were available for previewing.)

National Carvers Museum, Woodcarver Road, Monument, CO 80132. 303-481-2656. "Carve the Cowboy Head" with Claude Bolton shows how to carve both a cowboy's head and a bust for mounting. Twelve videos on carving also include "Bird in Flight" and "Fantasy Faces." Purchase price: \$39.95 each; \$20 rental fee for two weeks.

Osmose Great Plans Videos include "Great Decks," "Great Fences," and "Great Gazebos." The "Great Decks" video gives step-by-step instructions on building a deck. These videos, which sell for just \$15.95 each, are available from dealers with the Osmose point-of-purchase display in their stores. Or call 800-522-9663.

Punkin Hollow Video Library consists of a seven-videotape woodworking series. The "Mortise and Tenon/Dadoes" video represents a complete guide for anyone interested in cutting one of the strongest joints, the mortise and tenon, completely by hand. You can buy (at \$59.95 to \$69.95 each) or rent them from The Woodworker's Supply of New Mexico.

Shopsmith, Inc., 6640 Poe Ave., Dayton, OH 45414-2591. 800-543-7586. Their three videos



The Fine Tool Shops, Inc.
Dept. WMA6
20 Backus Ave., Box 1262
Danbury, CT 06810

Send to _____

Address _____

City _____ State _____ Zip _____

Check enclosed Charge my

VISA AmExpress MasterCard

Account # _____

Exp. Date _____

SAVE \$5.00
on each tape
when you order 2 or more.

Qty	Title	Type	Price ea.	Total
	How to Work With Hand Planes—The Bench Plane	— VHS 602-0001 — Beta 602-0021	\$39.95	
	How to Work With Hand Planes—The Specialty Planes	— VHS 602-0002 — Beta 602-0022	\$39.95	
	How to Make Carcase Joints with Hand Tools	— VHS 602-0004 — Beta 602-0024	\$39.95	
	How to Make Framing Joints with Hand Tools	— VHS 602-0003 — Beta 602-0023	\$39.95	
		Subtotal		
		Deduct Savings Here		
		Shipping & Handling (\$2.00 per tape)		
		CT 7½% Sales Tax		
		TOTAL enclosed		

Send your big full color catalog of fine hand and power tools FREE!

include "Making Bowls," which turned out (if you'll excuse the pun) to be a good video for the beginning turner. The video offers easy-to-understand instructions on preparing stock and use of the roundnose in the scraping process. Prices run from \$29.95 to \$49.95, with no rental policy.

Taunton Press, P.O. Box 355, Newtown, CT 06470. 800-243-7252. Taunton Press produces videos for the advanced woodworker. Four of their five programs run 110 minutes or longer, and five more videos are in the making. Their present tapes include "Dovetail a Drawer," "Wood Finishing," and "Radial Arm Saw Joinery." Del Stubbs shows how to cut (not scrape) paper-thin bowls in his two hour video, "Bowl Turning." The videos are priced from \$49.95 to \$59.95, with no rental policy.

With The Grain (WIG) Videos, Box 1329, Mendocino, CA 95460. 707-937-0660. "Wooden Planes and Cabinet Scrapers" comes from California's College of the Redwoods, directed by master craftsman James Krenov. The video, along with plan drawings, explains how to build and use a wooden plane and how to use a cabinet scraper. WIG Videos also carries 13 programs from Roy Underhill's popular PBS series "The Woodwright's Shop" on Early American woodcraft, available in a four-volume video set. The videos sell for \$59.95 each, and rent for \$20 for 30 days.

Woodworker's Supply of New Mexico, 5604 Alameda N.E., Albuquerque, NM 87113. 505-821-0500. A selection of 13 videos includes a seven-video Punkin Hollow Series, the five videos by Taunton Press, and R. J. De Cristoforo's "Table Saw Expertise." The latter explains in layman's terms how to miter, taper, kerf, and build several table-saw jigs. Videos range from \$39.95 to \$69.95, with a rental policy of \$19.90 per video for 30 days. 🌲

**NEW
POWER
FEED**

DRUM SANDER



At last! A complete power-feed Drum Sander at an affordable price! Comes ready to use including hood, stand and motor! Choose from 12" and 26" models.

FINISH SANDING...THICKNESS SANDING

Use this high-tolerance machine for light dimensioning as well as the finest finish work. Now you can add new beauty to each woodworking project...save hours of tedious hand sanding! In a matter of seconds, you can produce a satin-smooth finish impossible to duplicate with hand methods or hand-held power sanders...no more low spots, waves or cross-grain marks!

IMPROVES RESULTS!

Send for complete facts! See how the Sander can dimension and finish-sand cabinet pieces, resawn stock paneling, grandfather clocks, toys, tabletops, knees, burls, crotches, and much, much more! You'll soon find it's one of the most valuable tools in your shop! **Made in U.S.A. Easy terms.**

Call Toll-Free 1 (800) 251-4888

**SANDER
FACTS**

YES! Please rush my **FREE INFORMATION KIT** and details on your 30-Day Free Trial Guarantee. **Woodmaster Tools, Dept. RW11 2908 Oak, Kansas City, MO 64108**

NAME _____
ADDRESS _____
CITY _____
STATE _____ ZIP _____

Free 30 Day Trial!

Send for complete facts on how you can try the Woodmaster Power-Feed Drum Sander in your own shop for 30 days completely without risk!



MORE PLEASURE PROFIT PRIDE FROM WOODWORKING

The world famous **Constantine Catalog** offers over 2,000 items to help you **BUILD, RESTORE, REPAIR, REFINISH anything made of wood!**

You can ruin an otherwise perfect job if you're missing the right tool, part, wood or finish. With Constantine's 116 page catalog as your reference guide, you'll be able to choose from over 2,000 unique and hard-to-find items—items that *you need and won't find* in your local hardware store or lumber supply!

Every item is top quality, reasonably priced and backed by **CONSTANTINE'S MONEY BACK GUARANTEE!** Choose from 150 kinds of veneer, 118 carving tools and chisels, 32 upholstery tools and essentials, 39 clamps, pages of brass hardware for furniture and cabinets, 72 lamp parts, 96 how-to books, 73 picture kits, 33 styles of prefinished picture molding, 200 sizes and kinds of

cabinet lumber, professional wood finishes, hundreds of plans for furniture, cabinets, shelves, toys...**OVER 2,000 ITEMS IN ALL!**

**116 page catalog—Only \$1.00
SEND COUPON TODAY!
\$2.00 refunded on 1st order.**

CONSTANTINE Est. 1812
2054R Eastchester Road
Bronx, NY 10461

Send catalog—\$1.00 enclosed

Name _____
Address _____
City _____ State _____ Zip _____

CARVE A DECOY

HOME VIDEO INSTRUCTIONS

Beginning, Intermediate, and Advanced Carvers have enthusiastically endorsed THE VIDEO SERIES BY FOUR-TIME WORLD CHAMPION PAT GODIN

NEW

THE BEST

TAPE I - Developing a pattern and carving a basic decoy. TAPE II - Carving and detailing feathers by grinding and wood-burning. TAPE III - Painting to produce a life-like decorative decoy.

The Series includes a FREE Pattern and Painting Guide for the Hen Canvasback.

Send name and address along with check, money order or credit card information (including exp. date) to:

GEORGETOWNE INC.
BOX 625-D
BETHEL PARK, PA 15102
(412) 854-1887

BETA VHS

Tape I (60 min.) \$ 59.95
 Tape II (30 min.) \$ 39.95
 Tape III (60 min.) \$ 59.95
 Complete Series \$149.95

Postage & Handling \$ 4.00

(U.S. Funds Only)
PA. Residents Add 6% Sales Tax



"Really the BEST catalog I've ever used."

- E.F.M., Baltimore

The complete Craftwoods catalog includes fine hardwoods, woodworking tools and supplies, plus a featured section on decoy carving. It's yours for \$3—refundable on your first order.



CRAFTWOODS
10921-W York Road
Cockeysville, MD 21030
301-667-9663

BUILD A KUEMPEL HEIRLOOM CLOCK



Serving clockmakers for 65 years. Build a beautiful solid 3/4" oak, cherry or walnut clock, hand cut of carefully matched wood. Beveled glass, bronze etched dial handcrafted pendulums & handpainted moonwheels. Choose Rods or Tubular Bells. Kits or start from scratch plans in a variety of designs.

Write or Call for Catalog
1-800-328-6445
Between 8 a.m. & 4 p.m. CST
First Class - \$2

Kuempel Chime
Dept. 010
21195 Minnetonka Blvd.
Excelsior, MN 55331
The originators of clock kits.

HORTON BRASSES

Nooks Hill Road, P.O. Box 120J
Cromwell, CT 06416 (203) 635-4400

HORTON BRASSES are authentic copies of 17th, 18th, 19th & early 20th century pulls



Mfrs. of Cabinet & Furniture Hardware for Homes & Antiques.
Send \$2.00 for a Catalogue.

WHEEL-RIGHT Wheel Maker

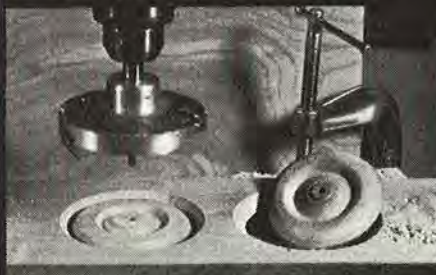

Never before possible a professional wheel maker that allows you to quickly mass produce detailed quality wooden wheels at a low low cost. Also turn out Rosettes and YoYo's. \$59.95 plus \$2.00 shipping and handling

The Tool Company
1306-G South Commercial
P.O. Box 629, Dept. BHG-8
Harrisonville, MO 64701
(816) 884-2679
Mo. Res. add 5.625% Sales Tax

Sleeveless DRUM SANDER

NO PRE-MADE SLEEVES TO BUY

ECONOMICAL - Simply cut sandpaper from standard size sheets
UNIQUE - Twist of key tightens sandpaper to drum.
SPONGE RUBBER backing insures long wear of sandpaper



1" x 3" long \$13.50
2" x 3" long \$15.50
2 1/2" x 3" long \$16.00
3" x 3" long \$17.50

1" and 2 1/2" Above \$27.00
Above 4 Drums \$55.00

3/4" x 3" long \$14.50
2 1/2" x 4 1/2" long \$21.00
3" x 4 1/2" long \$22.50
2 1/2" x 6" long \$25.50
3" x 6" long \$27.50
Add \$2.50 Per Order For Shipping

AVAILABLE WITH:

1/2" Bore with 1/2" or 3/4" shaft
1/2-20 RH Thread except 3/4" x 3"
5/8" Bore except 3/4" x 3" and 2" x 3"

USE ON:
Drill Press
Small Motor
Lathe, Combo-Tools,
Radial Saw, 1/4" Drill



Send Check or Money Order to:
SINGLEY SPECIALTY CO. INC.

P.O. BOX 50878, GREENSBORO, N.C. 27403
CALL (919) 852-8581

Wood Ship Models



Build a handsome model worthy of your time and care.

Our scale model wooden ship kits contain only the finest materials for plank-on-frame and solid hull construction. Send \$2 (refundable with purchase) for illustrated catalog of kits, fittings and supplies.

BLUEJACKET
SHIP CRAFTERS

ESTABLISHED 1905

P.O. Box 533 - BH, Shelton, CT 06484

20 to 45% OFF

step up to

Makita
CORDLESS DRIVER-DRILL KIT



• Reversible
• 2 speed
• 3/8" Chuck
• W/ 1 HR Charger

Reg. \$178

now \$99

FREE FREIGHT

6012HDW

FULL LINE DIST.

acme Electric

TOOL CRIB OF THE NORTH

CALL TOLL FREE FOR MIKE
1-800-358-3096

SIGNCARVING IS PROFITABLE!



And it's easy, if you use the Marlin Woodcarvers and accessories. You can carve signs quickly at home or at swap meets. The machines do the work, the operator has the fun and profits.

No Special Training Is Required!

SEND \$1.00 FOR OUR BROCHURE AND PRICE LIST, AND BEGIN TO PLAN YOUR FULL OR PART-TIME BUSINESS.

Fine Carving Machines Since 1971

MARLIN INDUSTRIES

1911 OBISPO AVE., DEPT. D604
LONG BEACH, CA 90804
(213) 498-0767



BUILD THIS BLANKET CHEST

(17"D x 18"H x 36"W)

Order plans for this charming reproduction

This beauty will be admired by family and friends alike—especially when they see the great storage space that you've gained for your prized quilts and blankets. The chest lid is hinged, and a pair of shallow drawers below add an authentic touch.

For complete building plans, including the know-how for duplicating the beautiful antiqued, painted finish, send \$10 ppd. (Canadian residents please remit postal money order in US funds) to:

HAMMERMARK ASSOCIATES, Box 201-W3, Floral Park, NY 11002.

Catalog available for \$1.00 (refundable). It's free with all Blanket Chest plans orders.

Information

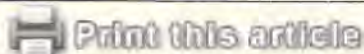

WORTH WRITING FOR

You can get useful ideas and product information by mail. Use the coupon in this section to order your choice of literature listed below.

SCROLL SAW AND LATHE INFORMATION — More than 20 pages of information, including full-color photos, on HEGNER precision scroll saws, HEGNER lathes, and HEGNER duplicators. Find out why these machines are considered state of the art, and what to look for when shopping for scroll saws or lathes. AMI, LTD. \$1.00. *Circle No. 2.*

WOODWORKING PROFESSIONALS ONLY — Now save 50% on machinery, 70% on operating costs! How? By using the world's finest production quality universal machine. Commercial durability, utmost precision, set-up in seconds. No other tool combines usable capabilities like FELDER. Thousands sold all over the world. Now available in America through AMI. Send for brochure. AMI LTD. \$1.00. *Circle No. 3.*

OVER 400 WOODWORKING DESIGNS — We now offer thirty-one packets of blueprint plans and full-size patterns with both the home and commercial craftsman in mind. Enjoy making toys, games, children's items, whirligigs, folk art, plaques, magazine racks, shelves, kitchen and household items, birdhouses, plant stands, and more. Simple enough for the beginner, fun and profitable for the pro. Send for illustrated brochure plus sample pattern. AC-CENTS IN PINE. \$2.00. *Circle No. 12.*

THE AMERICAN WOODWORKER MAGAZINE — offers projects on beginning, intermediate, and advanced levels in each issue. Also included are in-depth instructional articles on all phases of woodworking, plus general interest articles. We will offer plans for jigs and fixtures for your shop. A one year subscription is only \$10.00 (inside U.S.). Send for our brochure giving complete details plus a coupon good for 1/3 off the regular price. THE AMERICAN WOODWORKER. \$1.00. *Circle No. 45.*

TOOL CATALOG — Available from Anglo American Enterprises, the world famous Record Marples Tool Catalog featuring the finest woodcrafting tools available. Send for catalog and price list. AN-GLO AMERICAN ENTERPRISES CORP. \$2.00. *Circle No. 50.*

WOODWORKERS' PLANS AND SUPPLIES — Wood projects are simplified with the high quality plans, specialty hardware and other supplies offered by Armor Products. Over 100 plans are available for making toys, desks, clocks, pool tables, lamps, chests, and other furniture. Movements, dials, moldings, ornaments, and hardware also available. ARMOR PRODUCTS. \$1.00. *Circle No. 60.*

SHIP MODEL KITS — Fully illustrated 32-page catalog of scale ship model kits from America's oldest model ship company. Build a beautiful museum quality model ship with the simplest tools and average skills. BLUEJACKET SHIP CRAFTERS. \$2.00. *Circle No. 130.*

ABOUT COATED ABRASIVE PRODUCTS — A brochure dealing with a better understanding about the basics of coated abrasive products. Topics include: abrasive materials, grading, adhesives, coating, trade names and identification, general use, and storage. The basic information is presented clearly and simply. Lots of good useful information - both interesting and informative. BRADY SUPPLY CORP. \$1.00. *Circle No. 144.*

FREUD HAND TOOL CATALOG — An exciting new line of precision hand tools. These tools reflect the fine quality of craftsmanship, durability, and performance that you have always associated with Freud products. From choice boxwood to chrome vanadium steel, these tools exceed all ex-

pectations of precision woodworking instruments. BRADY SUPPLY CORP. \$1.00. *Circle No. 145.*

SAFETY IS PROFITABLE — The cost of accidents has rapidly escalated in the form of insurance premiums, medical costs, etc. Powermatic introduces an unprecedented safety use and productivity improving plan for the safe use of its products, and safety improving accessories at new special low prices. A program you will profit from. BRADY SUPPLY CORP. \$2.00. *Circle No. 146.*

CANE AND BASKET SUPPLIES — Every item used in caning and basketry is pictured in this new catalog for hobbyists and others interested in caning, rushing, etc., for either fun or profit. CANE & BASKET SUPPLY CO. \$1.00. *Circle No. 230.*

CARBIDE TIPPED ROUTER BITS AND SHAPER CUTTERS — Over 200 router bits and shaper cutters displayed in catalog featuring 6 piece cabinet sets, 3 piece 1/2 in. shank router bit panel raising system, and 3 wing industrial shaper cutters. Shaper cutters available in 1/2 in. through 1-1/4 in. bore with bushings. Router bits offered in 1/4 in. and 1/2 in. shank. CASCADE PRECISION TOOL CO. \$1.00. *Circle No. 245.*

WOODWORKERS TOOLS AND MATERIALS — 116-page catalog offers fine hardwoods, veneers, inlays, picture molding, wood finishes, carving blocks, cabinet hardware, and cane. Specialty woodworking tools, shop equipment, plans, instruction books. ALBERT CONSTANTINE AND SON INC. \$1.00. *Circle No. 270.*

SIMPLE SYSTEMS FOR WOOD STAINING AND FINISHING — A 24-page, 4-color booklet gives plenty of helpful tips for better results. Included are tips on how to apply a bartop finish in one day, prevent wood from yellowing, create stain colors, apply water clean up stains and finishes, and more. DEFT, INC. 50c. *Circle No. 315.*

BUILD IT YOURSELF — Why buy it when you can build it? Illustrated catalog of hundreds of interesting and fun items you can create yourself for personal use or profitable sale. Our 1986 catalog contains toys, games, plaques, puzzles, birdhouses, planters, accent furniture, and much more. All patterns are full-size blueprints — no enlarging is necessary. Simply trace and create. DESIGN GROUP. \$1.00. *Circle No. 320.*

DUBUQUE CLAMP WORKS — the company serious about producing the BEST wood clamps and kits possible. This means strength, durability, and long wear without binding. Two kits available — Metal Hardware only or Metal Hardware plus Maple Jaws and Handles. Send for literature. DUBUQUE CLAMP WORKS. 25c. *Circle No. 345.*

DO-IT-YOURSELF LUMBER DRYING — This 22-page booklet *Kiln Chamber Construction Guide and Operation Manual* is designed for the individual wishing to dry his own lumber with a minimum investment of money, time, and space. Included are principles of dehumidification lumber drying, selection of which dryer is best for you, and kiln chamber plans and construction information. Also you will receive a questionnaire you can fill out and return. Once completed and returned you will receive free a computerized evaluation of your drying needs including investment considerations, operating costs, and payback. EBAC OF AMERICA, INC. \$5.00. *Circle No. 400.*

MULTI-PURPOSE HOME WOODWORKING SYSTEM — The Emco Start-2000 is a table saw, band saw, moulding machine and disc sander and you can change operations in less than 30 seconds. One big 2 hp. motor does it all. With optional accessories you can do wood turning, mortising, horizontal drilling, and more. Send for four-color information. EMCO* USA. Free. *Circle No. 402.*

EdLco — STAY IN THE WOODS WITH US — Educational Lumber Company is pleased to offer you

our new catalog, stacked with excellent buys at delivered prices. Available to you are over 21 species of imported as well as domestic hardwoods, softwoods, turnings, shorts, veneers. All our lumber is kiln dried. As school shop suppliers for 34 years, we know our lumber. It is top-grade. Send today and receive your BONUS GIFT; 4 new furniture designs. EDUCATIONAL LUMBER CO., Inc. \$2.00. *Circle No. 420.*

MACASSAR EBONY — Professionals agree it's one of the world's hardest, rarest, and most beautiful woods. Macassar is coveted by woodworkers, artists, turners, and connoisseurs for its marbelike beauty and durability. We have the largest commercial selection of dimensional stocks in the U.S., from 1 to 8 inches thick and from 4 to 20 inches wide in random lengths to 9 ft. These are virtually unavailable elsewhere at any price. As a direct importer, we offer the lowest prices anywhere with no minimum orders. Send today for a complete description, inventory and price list (refundable with first order). ART EISENBRAND, INC. \$1.00. *Circle No. 430.*

DO-IT-YOURSELF GRANDFATHER CLOCK KITS — Direct from world's largest manufacturer of grandfather clock kits. Prices starting at under \$280 including West German Westminster chiming movement. Choose from black walnut, cherry, and oak. Other quality heirloom kits also available. Send for brochure. EMPEROR CLOCK CO. 50c. *Circle No. 450.*

JAPANESE WOODWORKING TOOLS — A fine selection, including chisels and gouges, sharpening stones, saws, marking tools, hatchets, knives and garden tools, from some of Japan's most respected small toolmakers. Send for catalog. FINE TOOL SHOPS. Free. *Circle No. 495.*

RIPSTRATE SAVES FINGERS — for table saw and radial arm saw users. Brochure describes the RIPSTRATE and shows how it gives straighter cuts, speeds, the work, prevents kickbacks, and keeps hands away from the blade. FISHER HILL PRODUCTS. 25c. *Circle No. 530.*

EXCELLENCE IN SHARPENING EQUIPMENT — This two-color, 56-page catalog from Foley-Belsaw Co. provides information on its complete line of equipment used for sharpening home, garden, and industrial shop saws and tools. Each machine is fully illustrated, complete specs and pricing information are provided. FOLEY-BELSAW CO. Free. *Circle No. 550.*

BEAT INFLATION AND HIGH LUMBERYARD PRICES — Turn trees into valuable lumber with the world-famous ONE-MAN PORTABLE SAWMILL. Goes right to the trees — turns out smooth, truecut lumber every time. No crew needed... no experience necessary. Send for booklet. FOLEY-BELSAW CO. Free. *Circle No. 551.*

FREE SUBSCRIPTION TO FOLEY-BELSAW NEWS BULLETIN — For a limited time Foley-Belsaw will be giving away a 1-year subscription to their 64-page color publication. This publication includes stories and shop tips on all types of woodworking, tool sharpening, upholstery, engine repair, and locksmithing. The magazine, which is published six times a year, includes many special offers on Foley-Belsaw equipment. FOLEY-BELSAW CO. Free. *Circle No. 552.*

CUTTING TOOLS — Freud provides the finest in handtools and carbide cutting tools. From chisels and planes to saw blades and router bits. All this and more. Send for catalog. FREUD. \$1.00. *Circle No. 560.*

FULL-SIZE FURNITURE PLANS CATALOG — Illustrates and describes over 180 plans for making furniture of quality found in museums and fine furniture stores. Plans include rollout desk, cradles, dining tables, chairs, buffets, chests, gun cabinets, poker table, children's furniture, rocking horse,

spinning wheels, and more. Bill of materials exploded drawings assist the woodworker. FURNITURE DESIGN, INC. \$2.00. *Circle No. 585.*

1985-86 MASTER CATALOG — contains 228 pages of the finest in woodworking hand tools, machinery, and finishing supplies plus over 125 books. Of particular note is the selection of Japanese tools. The format is all four-color. GARRETT WADE CO. \$3.00. *Circle No. 600.*

BEAUTIFUL WIPE-ON WOOD FINISHING — is explained in a booklet from a pioneer in wipe-on finishes since 1928. Wood finishes that produce a beautiful hand-rubbed finish without messy brushes or spraying. Specially formulated finishes that simply wipe-on with professional results every-time — guaranteed! Unlike conventional finishes these will never yellow, crack, or craze and they dry dustfree without runs. These finishes will bring out the natural beauty of the wood and never needs waxing. Send today for your wood finishing guide and products catalog. GENERAL FINISHES, 25c. *Circle No. 630.*

PEG-1000 WHOLESALE — Polyethylene glycol green wood stabilizer, 10 lbs. \$19.00 plus \$3.20 shipping. Send for additional information. GENERAL FINISHES, 25c. *Circle No. 631.*

EASY DOES IT — with HTC'S power tool accessories. Discover many unique items, designed only with you, the dedicated woodworker, in mind. Make your machinery safer, increase the working area of your shop and accomplish nearly impossible tasks easily, quickly, accurately. Full-line catalog and price list. HTC PRODUCTS, INC. Free. *Circle No. 705.*

EPOXIES FOR THE WOODWORKER AND HOBBYIST — Find out in two fact-filled pamphlets all about adhesive from the ancient blood glues to modern day epoxies and how they can help you in your woodworking projects. You will also receive a product literature package on the industrial formulators of Canada, Ltd. line of epoxies for woodworkers. HEADLAND INTERNATIONAL, INC. \$1.50. *Circle No. 720.*

BRASS FURNITURE HARDWARE — This 36-page catalog shows over 500 items of authentic reproduction hardware from the 1700's and on into this century. This fine quality hardware is a must for the furniture craftsman working on a new project, or the refinisher who needs replacement hardware. HORTON BRASSES. \$2.00. *Circle No. 750.*

IF YOU ARE INTERESTED IN FINE WOODWORKING — you will not find better machinery than that sold by J.P. Humfrey Ltd. For example, we have 10-in. general tablesaws (2 HP, magnetic switch, lever-lock fence) available at \$1,295 FOB New York. Send for brochure. J. PHILIP HUMFREY LTD. \$1.00. *Circle No. 770.*

START SMALL BUSINESS WITH NEW SCROLL SAW — The Excalibur precision scroll saw from Canada can turn your workshop into a profit center. Make toys and puzzles, do intricate marquetry work or detailed cabinet work with these "operator friendly" machines. Hundreds sold in the U.S. already. Save, buy direct, from \$495. up. Complete project patterns and plans available. Send for brochure. J. PHILIP HUMFREY LTD. \$1.00. *Circle No. 771.*

BUY YOUR SANDING BELTS DIRECT FROM THE MANUFACTURER — Industrial Abrasives is the company that gives you six free belts with every dozen ordered. But, sanding belts are not the only product we have to offer. In our catalog you will find many specialty items not readily available in your hardware store. Price of catalog refunded with first order. INDUSTRIAL ABRASIVES CO. \$1.00. *Circle No. 780.*

THE CUSHION CONTOUR SANDER — is a new concept in pneumatic drum sanding. Sanding sleeves are slid over an air bag (inflated with a hand tire pump) on an arbor to mount it between centers on a wood lathe. Drum effectively takes on profiles, curves, and bevels practically eliminating flat spots and chatter marks. INDUSTRIAL ABRASIVES CO. Free. *Circle No. 781.*

QUALITY CLOCK KITS AND PLANS — Hand-made and semi-assembled of carefully selected 3/4 in. cherry, oak, or walnut with beveled glass. Or build from "scratch" using our detailed plans and

trim pieces. Choice of quality movements. Established in 1916. KUEMPEL CHIME CLOCK WORKS. \$2.00. *Circle No. 1070.*

FREE LITERATURE — New brochure showing all moisture meters and accessories for moisture meters such as interchangeable electrodes and probes and cables for in-kiln moisture monitoring. Complete line of moisture meters include: Pocket-size Mini-Ligno with LED readout 6%-20%, Mini Ligno E 6%-36%, analog or digital display meters 4%-30%, 60% and a digital moisture meter with built-in compensation for different wood temperatures. LIGNOMAT USA, LTD. Free. *Circle No. 1130.*

PRODUCTION QUALITY CARBIDE TIPPED ROUTER BITS — MLCS Ltd. offers a full line of professional production quality carbide tipped router bits at 50-70% lower than retail prices. We sell through the mail and only direct to craftsmen. Send today for information. MLCS LTD. Free. *Circle No. 1210.*

WOODWORKING PLANS — Catalog of full-size plans printed on heavy paper for toys, gifts, novelties, action windmills, shelves, birdhouses, garden furniture, Dutch windmill, lawn ornaments, old-fashioned lawn swing, jigsaw projects for children, and more. MASTERCRAFT PLANS WEST. \$1.00. *Circle No. 1216.*

WOODWORKING BOOKS AT DISCOUNT PRICES — Most complete listing of books for woodworkers. Each book is discounted from 10 to 25% off the cover price. There is absolutely no shipping and handling charge. Woodworking, carving, turning, project books by authors such as Krenov, Frid, Spielman, Nish, Tangerman, and Hoadley are listed along with many hard-to-find titles. MANNY'S WOODWORKER'S PLACE. \$2.00. *Circle No. 1217.*

WOODWORKER'S SPECIALTIES — 48-page catalog of plans and hard-to-find hardware for the woodworker. Brass hardware, screws, cork products, wood turnings, canister liners, clock movements, picture frame supplies, lamp parts, and more. MEISEL HARDWARE SPECIALTIES. \$1.00. *Circle No. 1220.*

TIPS ON WOOD FINISHING — A comprehensive, 30-page booklet includes numerous tips that save time and trouble for do-it-yourselfers. Information ranges from small repairs to restoring the finish of a priceless antique. Also included is a chart showing the full range of colors available. The name of your nearest dealer is provided. MINWAX CO., INC. Free. *Circle No. 1240.*

WOODEN SHIP MODELS — Discover the world's hobby — building fine-quality, historic wooden ship models. Described are true-to-life scale replicas, lifelike in every detail. A 64-page color catalog introduces you to this fascinating hobby. MODEL EXPO, INC. \$1.00 (Refunded with first order). *Circle No. 1256.*

WOODWORKING SUPPLIES CATALOG — Send for new 36-page color catalog of hundreds of foreign and domestic veneers, wood craft patterns, turning squares, carving blocks, toymaking supplies, hardwood lumber (at factory-to-you prices), chair cane, books, spindles, dowels, shaker and mug pegs, candle cups, fancy inlay borders, made-to-order 1-ply and 2-ply veneers and plywoods (every specie including all burls and crotches). Also included is a colorful wood selector chart, simplified veneering instructions and introductory incentive offers and free gift offers. BOB MORGAN WOODWORKING SUPPLIES. \$1.00. *Circle No. 1257.*

WOOD CARVING — You can obtain information on learning woodcarving by sending for our literature. The offer includes sample copy of *The Mallet Magazine* and two lesson sheets on carving. NATIONAL CARVERS MUSEUM. \$1.00. *Circle No. 1300.*

KILN DRIED CABINET GRADE HARDWOOD — in 18 different varieties. Thickness 5/8 — 1 1/4". Draw stock, carving wood, turning squares, and material for paneling, flooring, and wainscoting. We ship small amounts UPS, medium loads motor freight, large loads via trailer. Comprehensive listing. NATIVE AMERICAN HARDWOODS. \$1.00. *Circle No. 1305.*

WOODWORKING TOOL CATALOGS — R.A. Ness & Co., the Woodworkers Emporium, offers a 2-year

subscription, a total of eight huge sale catalogs. Thousands of industrial quality items — machinery, hand tools, portable electric tools, and supplies — are featured at super sale prices. The fee is refundable with purchase. R. A. NESS & CO., the Woodworkers Emporium. \$4.00. *Circle No. 1310.*

CLOCK COMPONENTS — We feature battery, pendulum, and chime quartz movements of all types: Urgos, Hermle, Grandmother, Grandfather cable drive and chain drive, keywind movements of all types. 400-day clocks, music box movements, flat and benzol type dials — plus a vast assortment of weather instruments. Hundreds of clock items. Very competitive. 75-page catalog. NEWPORT ENTERPRISES. Free. *Circle No. 1320.*

WOOD WORKERS—CARVERS SUPPLIES — Catalog on hand to find items. E-Z pneumatic drum sander, Foredom tools and accessories, Detail Master woodburning unit, abrasive cartridge rolls, books, patterns, much more. NORTH WEST CARVING SUPPLIES. \$2.00. (Refundable). *Circle No. 1360.*

PERSONAL BRANDING IRONS — Brochure describes branding irons that enable you to put your name on you work quickly and easily. Made especially for branding wood, they are available with 1, 2, or 3 lines of copy or with your logo. Changeable date also available. NOVA TOOL CO. \$1.00. *Circle No. 1380.*

LUMBER DRYING — Nyle Corp., the largest manufacturer in the United States of dehumidification Dry Kiln Systems, offers *Introduction to Dehumidification Lumber Drying*. NYLE CORP. Free. *Circle No. 1390.*

BOSCH ROUTER BITS AND DELTA SHAPER CUTTERS — Send for our sale prices on Bosch router bits and jigsaw blades. Also ask for prices on Delta shaper cutters. Best prices available. PME WOODWORKING SUPPLIES. \$1.00. *Circle No. 1470.*

PEG — Turns green wood into beautiful projects as seen on page 46 of February 1986 issue of Wood. Supplies and catalogs of other items for the home woodworker. Price of catalog refundable with first order. PITSCO. \$4.00. *Circle No. 1490.*

QUARTZ CLOCK MOVEMENTS — Our 60-page catalog features a large selection of movements, hands, dials, bezels, numerals, weather instruments, prints, as well as a full-line of clock making supplies. Thousands of ultra-thin pendulum and chime movements in stock at all times. Most orders shipped within 48 hours. PRECISION MOVEMENTS. Free. *Circle No. 1555.*

THE REVOLUTIONARY PARALOK TABLE SAW FENCE — makes cutting at least seven times more accurate and much faster. Single-handed operation works on the same principle as a drafting table. fence is always parallel to blade. Adjustable at intervals of 1/64 in. Send for more information. QUINTEC MARKETING. \$1.00. *Circle No. 1585.*

A CATALOG OF DEFECT-FREE HARDWOODS — Reproduction Hardwoods provides you Red Oak, Mahogany, Cherry, Walnut, Hard Maple and Poplar in solid panels and turning squares. Plus hardwood faced plywood and butcher block stock. All defect free! Widths up to 30 in. and lengths up to 60 in., squares up to 5 in. thick. Custom sized for no waste building. Shipped UPS to your door. REPRODUCTION HARDWOODS. \$1.00. *Circle No. 1630.*

TOOLS ON SALE — A division of Seven Corners Ace Hardware Inc. offers a comprehensive catalog featuring over 190 pages of the most competitive prices in the industry. If you're looking for savings and fast delivery on over 1,800 items, request our catalog. This catalog offers one of the most complete selections of power tools available anywhere from the most respected manufacturers in the industry: Milwaukee, Makita, Porter-Cable, Black & Decker, Freud, Kobalt, Delta, and many more. SEVEN CORNERS ACE HARDWARE INC. Free. *Circle No. 1670.*

LETTER LAYOUT GUIDES — Brochure containing complete information about a new product of special interest to scroll sawers, carvers, and wood sign makers. A lettering guide to layout large letters and numbers to be cut in wood or other materials. Made from a durable plastic material for years of use. Price of brochure is refundable with first order. SEYCO SALES CO. \$3.00. *Circle No. 1710.*

LAMINATED SOUTHERN PINE TABLE TOP — Make your own woodworker's bench. Send for information. SOUTHERN PINE. Free. Circle No. 1740.

SYSTEMS IN JOINERY — New 25-page illustrated catalog featuring many uses of the joint-matic and introduction of other high quality machines, fixtures, and cutting tools that make many of the more difficult tasks in woodworking easier. STRONG TOOL DESIGN. \$2.00. Circle No. 1745.

TIMBERS COUNTRY STORE — Catalog features hundreds of woodworking supplies, toy patterns, furniture patterns, tool use and instruction books, woodworking pattern books, hardwood toy and furniture parts plus many hard to find tools and shop supplies. TIMBERS COUNTRY STORE. Free. Circle No. 1820.

ATTENTION WOODWORKERS — Learn how you can afford a quality 24 in. scroll saw that you build from a kit. Also ask how, with the WHEEL-RIGHT, you can mass-produce wooden wheels by using your drill press. THE TOOL COMPANY. \$1.00. Circle No. 1840.

TOYMAKERS SUPPLIES — Catalog of over 100 full-size wooden toy patterns — classic to contemporary designs from Packard Le Baron to Streamlined train and moon machine. Easy to follow, fully illustrated patterns which appeal to all ages. Hardwood wheels, shaker pegs, axles, etc., in stock. Accessory kits of pattern and turnings available. TOY DESIGNS. \$1.50. Circle No. 1860.

CLASSIC CARS AND TRUCKS — Flyer of seven full-size wooden toy patterns of early 1900's motor vehicles — 1912 White Gas Truck, 1929 Chrysler Imperial, 1924 Dodge Delivery Van, 1931 Packard Le Baron, 1915 Peirce Arrow, 1926 Gramham Brothers Truck, and 1929 Chevy Truck. Easy to follow instructions, pictorial assembly views and complete stock list. Two inch spoked wheels available to compliment these designs. TOY DESIGNS. 40c. Circle No. 1861.

TOYMAKER'S SUPPLY COMPANY — has your best bulk price on quality wooden toy parts and toy plans. Over 50 turnings to make your toys professional looking. Send for catalog. TOYMAKER'S SUPPLY CO. Free. Circle No. 1863.

WOOD TOY PATTERNS — Patterns for all ages including childrens' patterns and executive toys. New catalog has many new patterns to choose from including parts and wheels. Send for new catalog and receive a coupon for free wheels and axle pegs. TOYS AND JOYS. \$1.00. Circle No. 1865.

IF YOU ARE INTERESTED IN RESTORING ANTIQUES — this 112-page catalog packed with unusual, hard-to-find items is just for you. Included are hundreds of essential items for antique restoration including top quality brass reproduction hardware, oil lamps and accessories, numerous wood component repair parts and kits, caning and basketry supplies, everything needed for wood refinishing, related tools, books, and a complete line of upholstery equipment and supplies. All at wholesale prices. Send for this informative catalog. VAN DYKE' SUPPLY CO. \$1.00. Circle No. 1970.

WOODCARVING TOOLS — Whittlers and carvers — Warren Tool Co. offers a catalog for you full of whittling and carving hand/power tools, books, stones, wood, and supplies. Since 1927, the finest in woodcarvers tools. WARREN TOOL CO., INC. 60c. Circle No. 2020.

BEAUTIFUL WOOD FINISHING — with Watco Danish Oil Wood Finish. Full-color *How to Beautifully Finish Wood* booklet enables anyone to create professional finishes the first time with all types of wood. One application of Watco Wood Finish seals, primes, finishes, hardens, protects, beautifies, penetrates deeply into the wood; outlasts surface coats three to one. Eight attractive Danish Oil colors now available. Eliminates pre-staining. WATCO-DENNIS CORP. Free. Circle No. 2025.

WOODWORKERS CATALOG — More than a catalog — it's one of the best sources for quality wood-working tools. You'll find everything from bit braces to wood borers, from saws to sharpening stones. Every product is sold satisfaction guaranteed. WOODCRAFT SUPPLY CORP. Free Circle No. 2070.

POWER-FEED DRUM SANDER — Use the Woodmaster Model 1200 to dimension and finish-sand cabinet pieces, resawn stock, paneling, grandfather clocks, toys, table tops, knees, burls, crotches, and much more. Choose from 12-in. and 26-in. models complete with motor and stand. 30 day free trial... easy terms. Send for information kit. WOODMASTER TOOLS. Free. Circle No. 2080.

HIGH PRECISION SCROLL SAW — The sturdy, new Woodmaster Model 1600 gives you all the features found in more expensive machines including big, 16-in. throat capacity, 2-in. cutting depth, a generous, oversized worktable, ball-bearing drive... and much more! Send for complete facts. See how you can use the Woodmaster Model 1600 in your own shop for one full month completely without risk. Send for information kit. WOODMASTER TOOLS, INC. Free. Circle No. 2081.

GIANT 24½-IN., 3-SPEED BAND SAW — Big 24½-in. throat easily handles large scrollwork, complex curves, 4x8 sheets, 9-in. vertical cut makes it easy to resaw valuable hardwoods. Ball bearing construction, all-steel welded frame to eliminate deflection. Can be ordered complete with motor, stand, dust collector, rip fence, scroll saw table. Full instructions. Send for complete facts on how you can try this versatile saw without risk. Easy terms. WOODMASTER TOOLS, INC. Free. Circle No. 2082.

PLANER/MOLDER/JOINTER/SANDER — This variable speed, power feed tool converts low-cost lumber into valuable finished stock. Turns out perfect quarter-round, casing, base mold, tongue and groove... all popular patterns including picture frames. Joints super-true edges, squared stock, bevels and chamfers. Optional sanding attachment quickly converts unit to one of the finest drum sanders available. 30-day free trial... easy terms. Send for information kit. WOODMASTER TOOLS, INC. Free. Circle No. 2083.

NON-TOXIC FINISHES, PAINTS AND STAINS — LIVOS is the complete product line featuring only non-toxic and natural ingredients. Once can safely use LIVOS on: salad bowls, cutting boards, butcher blocks and kitchen counters as well as children-related items: cribs, high chairs, tables, and toys. The entire line of LIVOS consists of oil finishes, waxes, shellacs, lacquers, polishes, stains, enamel

and latex paints, wood preservatives, and more. Catalog and two-year subscription to "Livros News", product updates, and brochures. WOODPECKER'S. \$2.00. Circle No. 2100.

WOODWORKER SUPPLIES — Thirty-year-old company offers a very interesting line of unique supplies. Most items are hand illustrated in this 112-page, well organized, full-color catalog. Included are veneers, hardwoods, wood parts, specialty hardware, furniture trim, finishes, books, plans, etc. THE WOODWORKERS' STORE. \$1.00. Circle No. 2120.

WOODWORKERS SUPPLY — Offers high quality tools and supplies for skilled, amateur, and professional woodworkers. Our complete catalog includes machinery, hand tools, plans, router bits, shaper cutters, wood specialties, and more. For your two year subscription send to WOODWORKERS SUPPLY OF NEW MEXICO. \$2.00. Circle No. 2125.

QUALITY AMERICAN-MADE WOOD TURNINGS — such as shaker pegs, spindles, toy wheels, toy parts, craft items, and dowel rods in birch, oak, walnut, and cherry. Send for complete 32-page catalog. WOODWORKS. \$1.00. Circle No. 2130.

NEW AND ORIGINAL DESIGNS — We've been designing projects for magazines and other clients for years, so, we decided it was about time to sell our own line of plans. Send for our folder of wood-working projects designed by David Ashe for THE WORKSHOP BLUEPRINT CO. 75c. Circle No. 2150.

DOOR SHOP® MANUAL AND CATALOG — The 35-page Door Shop® manual is clearly written and beautifully illustrated with over 156 detailed drawings covering the complete process of door building. Each section covers proper methods and exact set-ups for the router table, including how to recognize and correct for errors. There are sections covering design, lumber selection, measuring, panel raising, rail and stile fitting, guides, clamping, gluing, and finishing. This is the most comprehensive manual out today. When you purchase the Door Shop® manual for \$5.00 you also receive a 32-page router bit and shaper cutter catalog free. \$5.00 rebate with purchase of our Door Shop® or Panel Raiser® bits. ZAC PRODUCTS INC. \$5.00. Circle No. 2195.

Information

WORTH WRITING FOR

Better Homes and Gardens
WOOD MAGAZINE, April, 1986 Dept.
MAW06
P.O. BOX 2051
CLINTON, IA 52732

TO ENSURE PROMPT HANDLING OF YOUR ORDER FOLLOW THESE INSTRUCTIONS:

- Circle your choice
- Enclose cash, check, money order for cost of booklets plus \$2.00 service charge (no stamps/foreign)
- Send coupon and remittance to address above
- ALLOW 4-6 WEEKS FOR DELIVERY
- Coupon expires April 18, 1987

WOOD SUBSCRIPTION

1. A 1 year WOOD subscription (6 issues) for \$15.00 — a \$6.00 savings off newstand rate. Allow 6-8 weeks for first issue. Add \$6.00 outside U.S. Be sure to include payment with total below.

FREE LITERATURE

Circle numbers below corresponding to items in this issue
Please include \$2.00 for handling charge

402	552	1210	1555	1863	2081
495	705	1240	1670	2025	2082
550	781	1320	1710	2070	2083
551	1130	1390	1820	2080	

PRICED LITERATURE

Numbers below refer to items on which there is a charge
Please include proper remittance

2 \$1.00	146 \$2.00	430 \$1.00	750 \$2.00	1257 \$1.00	1630 \$1.00	2100 \$2.00
3 \$1.00	230 \$1.00	450 50c	770 \$1.00	1300 \$1.00	1710 \$3.00	2120 \$1.00
12 \$2.00	245 \$1.00	530 25c	771 \$1.00	1305 \$1.00	1745 \$2.00	2125 \$2.00
45 \$1.00	270 \$1.00	560 \$1.00	780 \$1.00	1310 \$1.00	1840 \$1.00	2130 \$1.00
50 \$2.00	315 50c	585 \$2.00	1070 \$2.00	1260 \$2.00	1860 \$1.50	2150 75c
60 \$1.00	320 \$1.00	600 \$3.00	1216 \$1.00	1380 \$1.00	1861 10c	2195 \$5.00
130 \$2.00	345 25c	630 25c	1217 \$2.00	1470 \$1.00	1865 \$1.00	
144 \$1.00	400 \$5.00	631 25c	1220 \$1.00	1490 \$4.00	1970 \$1.00	
145 \$1.00	420 \$2.00	720 \$1.50	1256 \$1.00	1585 \$1.00	2020 60c	

Name (please print) _____

Address _____

City _____

State _____ Zip Code _____

I AM ENCLOSING:

\$_____ for priced items

\$ 2.00 for handling

\$_____ total remittance*

ROY UNDERHILL: MASTER CRAFTSMAN OF THE OLD HAND WAYS

He's the author of *WOOD* Magazine's "Old Hand Ways" column, several books, and star of the Public Broadcasting System's national television series, *The Woodwright's Shop*. At age 35, Roy Underhill may already have spent more time working wood with traditional hand methods than many a woodwright did back in the 1700s.

A hands-on historian of technology, Roy daily displays his multitude of skills as Master Housewright at Colonial Williamsburg in Virginia. An admiring public continually marvels at how things were done centuries ago.

Roy probably came by his skills naturally. In 1597, his ancestor, a joiner named William Underhill, sold William Shakespeare a house at Stratford on Avon, England. Another forebear, a wheelwright, was one of the first settlers on the Virginia Colony's York River in 1690.

Roy inherited an inclination toward the old hand ways, but he



FACTS, FACES & FABLES OF INTEREST TO HOME WOODWORKERS

learned their application during graduate study at Duke University. From there, Roy applied his skills to museum restoration projects, until he was hired for a rebuilding pro-



Roy Underhill and daughter Rachel

gram that was under way at Colonial Williamsburg.

To Roy, the public's growing interest in handcraftsmanship is a response to our complex, technological society. "We're so 'high tech' we need more 'high touch,' and traditional woodworking provides that," says Roy. "The process is simple, using materials organic and infinitely different, and it produces a tangible product that comes from our hands."

Communicating that handcrafting process has become Roy's priority. Soon, he'll be sharing his knowledge of those techniques in a new television series, but from behind the camera this time rather than in front of it. He's directing several stories about the trades of Colonial Williamsburg.

When Roy goes home to his wife, Jane, and daughters Rachel, 7, and Eleanor, 4, you might expect him to relax by building a Windsor chair with hand tools. Instead, he leaves the old hand ways in the past. Says Roy, "When I get home I don't want to see anything old. I want to sit in front of my computer."

START A WOOD COLLECTION—BY MAIL

Members of the International Wood Collectors Society collect wood—from all over the world and often in staggering amounts. One member, Alan B. Curtis, of Eugene, Oreg., has collected enough samples collected that he sells spares.

Alan, a professional forester and

botanist, set out years ago to personally find, identify, and collect samples of all 680 native American woods. In this ongoing process, he has also managed to gather an assortment from far-off lands. Now, for lack of storage, he has to part with some.

For as little as 35 cents you can buy a 1/2 x 3 x 6" piece of incense cedar or sassafras. For a sale list of Alan's samples and their origins, send a stamped, self-addressed, business-sized envelope to Alan B. Curtis, 2370 Douglas Dr. #1132, Eugene, OR 97405.



Grant Goltz's great gray owl was an impressive entry in the 1985 World Carving Championship Competition.

CHAMPION CARVERS CONVERGE

For the past 15 years, Ocean City, Md., has been the place for carvers to be at the end of April. There, in Convention Hall, top wildfowl carvers from all over the U.S. and many foreign countries converge for the Ward Foundation's World Championship Wildfowl Carving Competition.

In 1985, 217 professionals, 219 amateurs, and 361 novice carvers competed for nearly \$90,000 in prize money and purchase awards, ribbons, and recognition. More than 20,000 people paid to view

the entries in the 3-day event, and participate in the auction of world-class decorative decoys.

Competition is tough. Minor anatomical flaws detected by experienced judges can drop months of work from the top of the class. The great gray owl with prey at left failed to capture a world-class ribbon because the mouse in its beak appeared too stiff.

This year's competition is April 25-27. For more information, write: Knute Bartrag, 707 Eastern Shore Dr., Salisbury, MD 21801. 🌲

RYOBI SANDERS... THE ONLY THING THEY DON'T TAKE OFF IS WORKDAYS.



Twenty-five hours a day, eight days a week, Ryobi sanders will be takin' it on and takin' it off with toughness and professional features you won't find with just any sander.

For example, motors are all

ball-bearing construction. Platens are extra-wide to give you flush-sanding capability and more work in less time. And speeds range from 1,500 S.F.M. for our biggest belt sander to 10,000 o.p.m. for orbital sanders.

Made for more than weekends.



1158 Tower Lane
Bensenville, IL 60106

Every Woodworking Project Starts With A Saw

SPECIAL FEATURES ON ALL FREUD SAWS:

BODY PLATE: 42 to 44 Rockwell "C" scale. Heat treated.
EXPANSION SLOTS: Allows blade to expand without distorting.
ARBOR HOLES: Machined and ground to perfect tolerances.
MAX RUN OUT TOLERANCES: ±.003.
MAX RPM'S: On a 10" diameter is 7000.

freud
 LUB4M - 480 Ø 10" Z 60 HM
 N. MAX 7000

freud
 LM72M - 441 Ø 10 Z 24 HM
 N. MAX 7000

Save On The World's Best Carbide Tipped Sawblades Through April 30, 1986.

Premium Quality

Premium Quality



LU84M
 Hook angle 7°
 Carbide Used: C4

While this type of blade is a compromise of the following blades, it will give you the results you expect in your shop. No one blade will do it all, however this is the one that comes closest. Most woodworkers we know have one of them. They are practical and inexpensive.

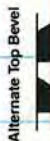

LU85M
 Hook angle 7°
 Carbide Used: C4

This is the world's best production made carbide sawblade. You can be sure of one thing that we are out to prove: You can spend as much as twice the price of our LU85M blade, but you will not find a better one!! We guarantee it! The use of this blade should be limited to super fine finish work only. The primary and secondary bevels and the teflon coating make this unique sawblade so very precise that the cut seems effortless in all kinds of materials.



LM72M
 Hook angle 20°
 Carbide Used: C2

This blade is designed for fast ripping along the grain of the wood. Excellent finish is obtained when ripping. The advantage of using a C2 grade carbide is to allow us to use an aggressive 20° hook for fast ripping and yet go through occasional knots without fracturing the tips.

STOCK #	DESCRIPTION	LIST	SALE
LM72M008	8 x 24 x 5/8 Flat Top	\$ 56.98	\$39.99
LM72M010	10 x 24 x 5/8 Flat Top	64.85	43.99
LM72M012	12 x 30 x 1 Flat Top	86.57	49.99
LU84M008	8 x 40 x 5/8 Comb.	71.53	43.99
LU84M009	9 x 40 x 5/8 Comb.	70.99	43.99
LU84M011	10 x 50 x 5/8 Comb.	74.51	43.99
LU84M012	12 x 60 x 1 Comb.	112.60	63.99
LU85M008	8 x 64 x 5/8 ATB	93.27	59.99
LU85M009	9 x 72 x 5/8 ATB	101.98	63.99
LU85M010	10 x 80 x 5/8 ATB	110.88	72.99
LU85M012	12 x 96 x 1 ATB	134.30	83.99

freud[®]

218 Feld Ave., High Point, NC 27264 • (919) 434-3171
 1570 Corporate Dr., Suite G, Costa Mesa, CA 92626 • (714) 751-8866
 In Canada 1(800) 387-7415

In California
 Call Toll Free
 1-800-824-0141

If You Live
 In This Area
 Call Toll Free
 1-800-824-8045

If You Live
 In This Area
 Call Toll Free
 (Outside NC)
 1-800-334-4107



Call us for the name of your nearest Freud distributor.