

Better Homes and Gardens®

WOOD

31
PAGES
OF PROJECTS

THE MAGAZINE FOR HOME WOODWORKERS

\$3.50

DECEMBER 1986 • ISSUE NO. 14
Display until December 17

FACEPLATE TURNING

Our tested techniques
take you step-by-step

POLYMERIZED TUNG OIL

Secrets for a
super-tough finish

BUILD THESE SPECIAL PROJECTS:

Rocking horse
Child's train set
Oak magazine rack
Laminated bowl
6 old-time folk toys
Candy caddy
Sweatheart stickpin
Laminated earrings
Sanding block

JUST IN TIME FOR THE HOLIDAYS

14 great gifts
you can build

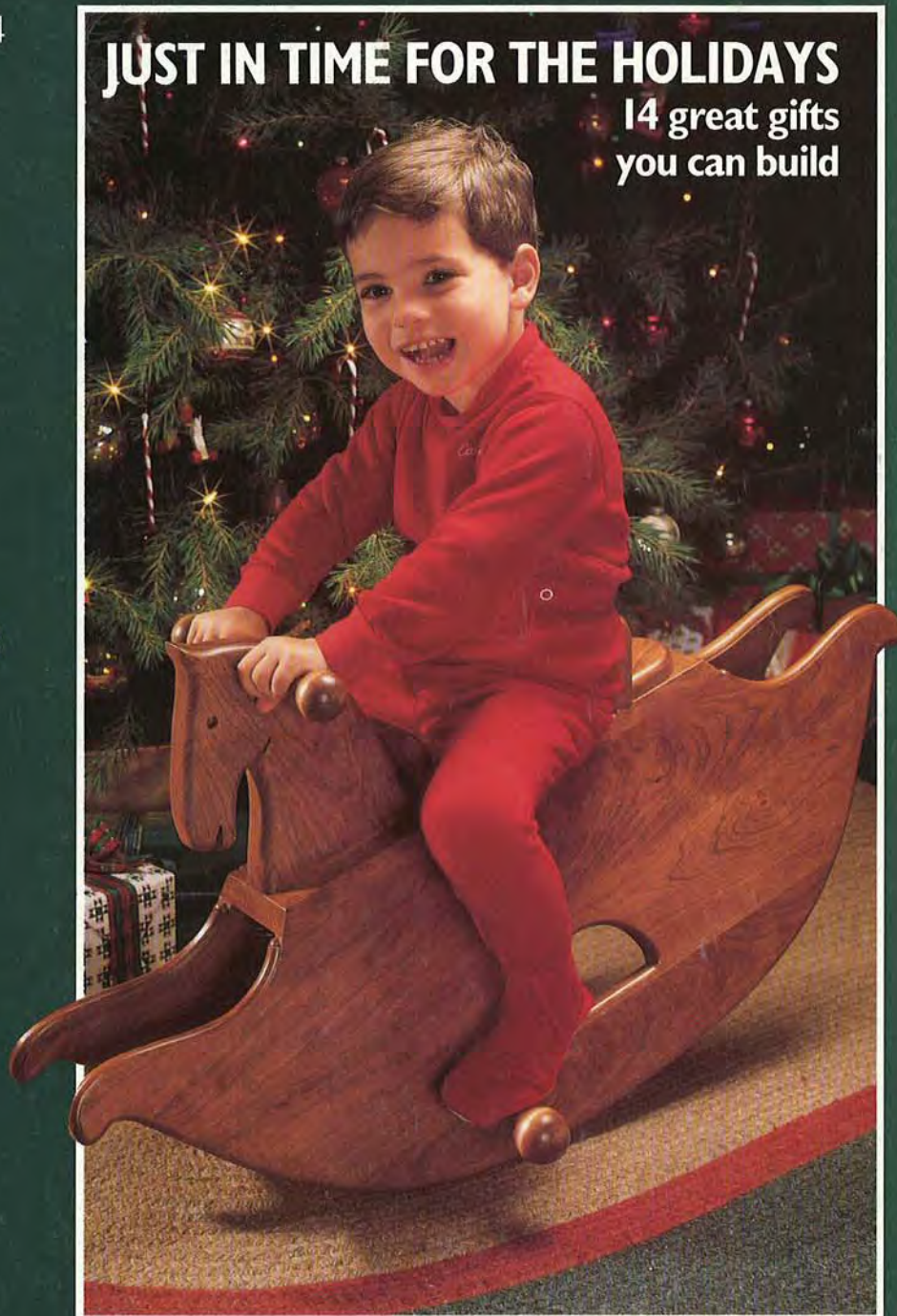

At \$1117, our electronic scroll saw was almost perfect.



At \$699, it is.

To anyone who thought our variable speed, digital readout scroll saw was perfect *except* for its price, we have this to say.

\$699 for a limited time.

Now, for anyone without a calculator, that's \$418 off our suggested retail price, now through December. (And that includes a matching stand and 96 assorted blades.)

So if you liked the Delta 18" Scroll Saw before, you're going to love it now.

You'll love it every time you take a curve *anywhere* from 100 to 2000 CS/M. Every time you lock in the speed with your eye on the readout. Every time you work in areas as tight as 1/64" diameter, or as big as 2" thick.

You'll love it every time you look at your cuts and realize you won't need that sander after all.

And, you'll love it every time you look in your wallet.

Call toll-free for the name of your participating Delta distributor: Delta International Machinery Corp., 800/438-2486 (in PA, 800/438-2487).

DELTA
Building On Tradition

Offer good only on sales in the continental U.S., Alaska and Hawaii, from September 1 to December 31, 1986.



Total Shop®

The Shape of Pride

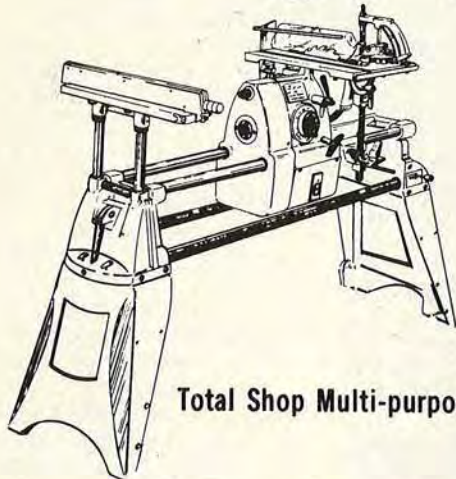

Total Shop Multi-purpose Tool

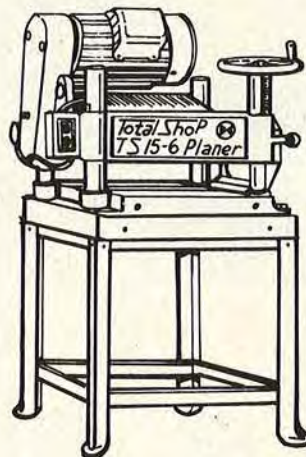

TS 15-6 Planer

What can compare to the sense of pride you feel when you carefully shape a piece of wood into a timeless treasure? Total Shop understands that feeling because we're proud too, and we have the shape to prove it. Our Total Shop multi-purpose tool and TS 15-6 planer are machines with solid power, versatility and stamina.

Compare Total Shop with Shopsmith® and see for yourself. The Total Shop motor produces nearly 40% more power than the Shopsmith® machine and can be altered by the owner to 220V, this is unavailable with Shopsmith®. And in more than 85% of

the comparisons, the Shopsmith® machine was priced higher than the Total Shop machine.

Don't overlook the TS 15-6 planer, a rugged machine convertible to 220V by the owner, optional stand and dust collector available, available with 2HP or 5HP motor, and a full 15" x 6" board capacity. A proud addition to any shop.

Our 30 minute video demonstration tape (available in VHS or Beta) gives you a look at our products in action before you buy. Send for it now (with a \$20.00 refundable deposit) and you'll see what we've been boasting about.

Now available for ALL multi-tool owners! (Total Shop, Shopsmith®, etc.) **An informative 2½ hr. instructional video.** No matter what multi-purpose tool you own, you'll learn more about its set-up, care, and operation.

Order today for only **\$49.95** (available in VHS or Beta).

Experience the Shape of Pride. Call

1-800-845-9356
(or in S.C. 288-4174)

and we'll send you 11 additional reasons why Total Shop is a better buy than Shopsmith® plus our free information pride packet.

YES! Please send me your free information pride packet, with 15 reasons Total Shop is the better buy.

- Multi-purpose tool
 TS 15-6 Planer

YES! Please send me the 30 min. demonstration video, I have enclosed a \$20.00 refundable deposit.

- VHS
 Beta

YES! I have enclosed \$49.95 plus \$2.00 shp. & hdl. for the 2½ hr. instructional video on the set-up, care, and operation of my multi-purpose tool.

- VHS
 Beta

Total Shop®

Dept. Q
P.O. Box 16297/Greenville, SC 29606

Name _____

Address _____

City _____

State/Zip _____

Phone _____

Call
Toll Free

1-800-845-9356

or in S.C.
288-4174

**NEW
POWER
FEED**

DRUM SANDER



At last! A complete power-feed Drum Sander at an affordable price! Comes ready to use including hood, stand and motor! Choose from 12" and 26" models.

FINISH SANDING...THICKNESS SANDING

Use this high-tolerance machine for light dimensioning as well as the finest finish work. Now you can add new beauty to each woodworking project...save hours of tedious hand sanding! In a matter of seconds, you can produce a satin-smooth finish impossible to duplicate with hand methods or hand-held power sanders...no more low spots, waves or cross-grain marks!

IMPROVES RESULTS!

Send for complete facts! See how the Sander can dimension and finish-sand cabinet pieces, resawn stock paneling, grandfather clocks, toys, tabletops, knees, burls, crotches, and much, much more! You'll soon find it's one of the most valuable tools in your shop! **Made in U.S.A. Easy terms.**

Call Toll-Free 1(800) 538-4200, ext. 2415

**SANDER
FACTS**

YES! Please rush my **FREE INFORMATION KIT** and details on your 30-Day Free Trial Guarantee.

Woodmaster Tools, Dept. RW15
2908 Oak, Kansas City, MO 64108

NAME _____

ADDRESS _____

CITY _____

STATE _____

ZIP _____

Free 30 Day Trial!

Send for complete facts on how you can try the Woodmaster Power-Feed Drum Sander in your own shop for 30 days completely without risk!

MAKE YOUR SAW A BETTER SAW.



The Biesemeyer T-Square® saw fence.

Sure, your table saw came with a fence. But you don't know what you're missing until you try the Biesemeyer T-square saw fence. It sets up and squares off in a flash. That saves you time. It's much more accurate. That saves you material and money. In fact, it makes you a better craftsman.

Try the precision saw fence that professionals have chosen for years. There's even a 30-day money back guarantee.

Call toll-free
1-800-782-1831 today.

BIESEMEYER.

Better Homes and Gardens®

WOOD

THE MAGAZINE FOR HOME WOODWORKERS

December 1986 • Vol. 3, No. 6 • Issue No. 14

Editorial/Art Staff

Editor **LARRY CLAYTON**
Managing Editor **CHARLES E. SOMMERS**
Art Director **C. L. GATZKE**
Design Editor **JAMES R. DOWNING**
Features Editor **PETER J. STEPHANO**
How-To Editor **MARLEN KEMMET**
Buymanship/Techniques Editor **JIM BARRETT**
Project Builder **JAMES E. BOELLING**
Graphic Designer **PERRY A. McFARLIN**
Administrative Assistant **DARLENE REYNOLDS**

Technical Consultants: **GEORGE GRANSETH** Product Testing; **VERNON U. WARD** Collectible Tools; **PAUL L. McCLURE** Wood Technology

Editorial Director **DORIS M. EBY**
Publishing Director **ADOLPH AUERBACHER**

Editorial Services

Executive Director **DUANE L. GREGG**
Director, Editorial Research **C. RAY DEATON**
Administrative Editor **ROSE ANDERSON**

Publisher **JERRY KAPLAN**
New York Advertising Manager **MARK S. HART**
Promotion/Research Director **THOMAS R. TROLAND**
Circulation Director **WILLIAM HUMMEL**
Production Director **DALE SCHENKELBERG**

Magazine Group Officers

Group President **JAMES A. AUTRY**
Group Vice Presidents
Editorial Director **DORIS M. EBY**
Publishing Director **ADOLPH AUERBACHER**

Corporate Officers

Chairman of the Board **E. T. MEREDITH III**
President **ROBERT A. BURNETT**
Executive Vice President—Corporate Services
JACK D. REHM
Group Presidents: Magazine **JAMES A. AUTRY**; Broadcasting **W. C. McREYNOLDS**; Real Estate **ALLEN L. SABBAG**; Book **FRED STINES**
Vice Presidents: Corporate Relations **DONALD L. ARNOLD**; General Counsel and Assistant Secretary **THOMAS G. FISHER**; Product Development **NEIL KUEHNL**; Corporate Planning **HERB SCHULTE**; Finance **WILLIAM H. STRAW**; Administrative Services **GERALD D. THORNTON**
Secretary **BETTY CAMPBELL MADDEN**
Treasurer **MICHAEL A. SELL**
Controller **LARRY D. HARTSOCK**

Better Homes and Gardens® WOOD – the magazine for home woodworkers (ISSN-0743-894X) is published bimonthly in February, April, June, August, October, and December by Meredith Corporation, 1716 Locust Street, Des Moines, IA 50336. Second-class postage paid at Des Moines, Iowa. Trademark registered in Canada and Australia. Marca Registrada en Mexico. **SUBSCRIPTION PRICES:** One year \$18 in the United States and its possessions. Canada and other countries add \$6 per year. **POSTMASTER:** Send address changes to WOOD, 1716 Locust Street, Des Moines, IA 50336. December 1986, Vol. 3, No. 6, Issue No. 14. **CUSTOMER SERVICE:** For service on your magazine subscriptions, including change of address, write to Customer Service Manager **ROBERT AUSTIN**, P.O. Box 10628, Des Moines, IA 50336. Please enclose a recent address label.
© COPYRIGHT MEREDITH CORPORATION 1986. ALL RIGHTS RESERVED. PRINTED IN U.S.A.

LEAVE THE COMPETITION IN THE DUST

with
PowerStars

Model 26 Shaper
\$1299 (2 HP)



Model 100 Planer
\$1499 (2 HP)

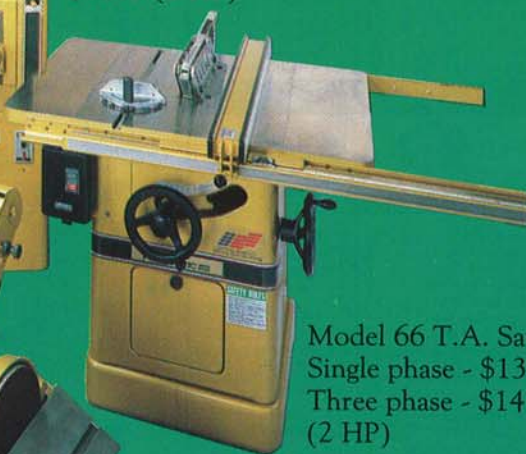

Model 66 T.A. Saw
Single phase - \$1399
Three phase - \$1474
(2 HP)

Model 30B Sander
\$844 (less stand)
(1½ HP)



Caught in the quandry of quality vs. price? Home and professional hobbyists, start-up users, and serious craftsmen have had limited choice in outfitting their workshops. That is...until now! Powermatic changes "just gazing at the best" to affordable reality with our new line of **PowerStars**.

Unlike the cheap imports, **PowerStars** maintain the rugged dependability, precision machining, and strict quality standards synonymous with Powermatic's industrial line.

PowerStars assure you of superior quality, excellent service and easy-to-get parts. And all at prices that give your expanding business the opportunity to own the best in woodworking machinery.

On all planes, quite frankly, **PowerStars** leave the competition in the dust! Call us today — 1-800-624-7056.

**POWERMATIC
FOR THE EIGHTIES™**

POWERMATIC 

POWERMATIC
McMINNVILLE, TN 37110

WOODWORKS

SHAKER PEGS			
		Qty.	Total
3 1/2" Maple Shaker Pegs	\$20.00/100	_____	_____
2 1/2" Medium Shaker Peg	15.00/100	_____	_____
1-3/4" Mini Shaker Pegs	7.00/100	_____	_____
3-3/8" Kitchen Mug Pegs	20.00/100	_____	_____
2-7/16" Tie Rack Pegs	7.00/100	_____	_____
Bean Pot Candle Cup	17.00/100	_____	_____

LOW PRICES

					
Maple Toy Wheels with 1/4 holes					
1 x 3/8 Maple Toy Wheels	\$6.50/100	_____	_____	_____	_____
1-1/4 x 7/16	8.50/100	_____	_____	_____	_____
1-1/2 x 1/2	10.00/100	_____	_____	_____	_____
1-3/4 x 9/16	14.00/100	_____	_____	_____	_____
2 x 5/8	17.50/100	_____	_____	_____	_____
Axle Pegs For Above	4.50/100	_____	_____	_____	_____

TOY PARTS ASSORTMENT	
25 Items - 519 Parts	39.95/Each

HIGH QUALITY

				
3/4" Full Round Balls	\$8.00/100	_____	_____	_____
1" Full Round Balls	10.00/100	_____	_____	_____
Nutcracker - White Birch	3.00/Each	_____	_____	_____
Apples	1.50/Each	_____	_____	_____
Large Egg 1-7/8"x2-1/2"	35.00/100	_____	_____	_____
Small Eggs 1-3/8" x 2"	25.00/100	_____	_____	_____

FAST SERVICE

			
3/8" Maple Buttons	\$2.15/100	_____	_____
1/2" Maple Buttons	2.25/100	_____	_____
3/8" x 2" Dowel Pins	2.20/100	_____	_____
1-1/2" Maple Spindles	9.00/100	_____	_____
1-1/2" Oak Spindles	12.00/100	_____	_____
2-1/8" Maple Spindle	14.00/100	_____	_____
2-1/8" Oak Spindle	18.00/100	_____	_____

LARGE SELECTION

	
1/4" x 36" Birch Dowels	\$4.25/25
3/8" x 36" Birch Dowels	6.50/25
1/2" x 36" Birch Dowels	10.50/25

QTY. PRICES AVAILABLE

9" x 11" ALUMINUM OXIDE-SANDPAPER	
220 Grit	\$16.00/100
180 Grit	16.00/100
150 Grit	16.00/100
120 Grit	16.00/100
100 Grit	16.00/100

BONUS OFFER

CHECK THIS BOX, AND AS A BONUS WITH ANY ORDER FOR WOOD PARTS, WE WILL SEND YOU A COMPLIMENTARY 8 OZ. BOTTLE OF FRANKLIN TITEBOND WOOD GLUE.

\$2.25 VALUE #B11 CHECK HERE



ORDER NOW

TOTAL FOR GOODS	
TEXANS ONLY ADD 5% SALES TAX HANDLING AND INSURANCE	\$3.00
FINAL TOTAL	

CATALOG \$1.00
(Free With Order)

MC OR VISA CHECK ENCLOSED

ACCOUNT # _____

EXPIRES _____ PHONE _____

NAME _____

SHIP TO _____

CITY/STATE/ZIP _____

817/281-4447



WOODWORKS

4013-A CLAY AVE. • FT. WORTH, TX 76117

Better Homes and Gardens®

WOOD

DECEMBER 1986

ISSUE NO. 14

WOOD PROFILE

HOLLY: THE SNOW-WHITE WOOD OF WINTER 33

Deck the halls with the fairest of them all! The whitest wood known, holly makes an interesting feature accent.



CRAFTSMAN CLOSE-UP

CABINETS BY HARGIS 34

Three generations of the Hargis family keep building cabinets the way their quality-conscious forefathers did and share with you some of their woodworking wisdom.



SHOP-TESTED TECHNIQUES

FACEPLATE TURNING 38

It doesn't take long to get hooked on the joy of seeing a beautiful bowl shape up on your lathe. Follow our step-by-step guide and you'll soon be turning out faceplate projects every chance you get.



NOW YOU CAN BUILD IT

STACK 'EM UP LAMINATED BOWL 44

Stack laminating goes a step beyond bowl-turning basics. This striking example features stacked-up squares of African padouk and oak veneer.



A CLASSY COVERED CANDY CADDY 46

Or how about topping off a faceplate project with a tight-fitting lid? You'll find this one a lot easier to turn than it is to say.



FOLK TOYS 48

Whimmydiddle, Flapjack, See Saw, Climbing Bear, Spindle Top, and Chickens Pecking... plans and patterns for six playthings from America's past. Each of these easy-to-make stocking stuffers has its own story to tell.

**POLYMERIZED TUNG OIL:
THE LOOKING-GLASS FINISH THAT LASTS AND LASTS** 52

Bill Lovelace, of Phoenix, Arizona, lets us in on the right way to apply his favorite finishing material.



PRACTICAL SHOP GEOMETRY 54

Circles, ellipses and polygons — perplexing shop layout problems with surprisingly easy solutions. Work them out as you read along.

BOWL BLANKS AND BURLS 56

Thinking about turning a bowl from manzanita burl, spalted maple, wild lilac, or some other exotic species? Here's where to get it.



TOOL BUYMANSHIP

TURNING TOOLS: WHAT YOU SHOULD KNOW BEFORE YOU BUY 58

Which cutting instruments does a novice turner really need and which are just nice-to-haves? *WOOD* recommends a starter set.

HOLIDAY SPECIALS FROM THE SHOP

THOROUGHbred ROCKING HORSE 62

Hitch this spirited mount under your tree this Christmas.



OAK MAGAZINE RACK 66

This project throws you just enough curves to make it interesting.



SANDING BLOCK 70

A smoothie you can make for every woodworker on your gift list.



STYLISH EARRINGS 72

Wooden jewelry for the ladies in your life.



PLAYTIME EXPRESS 74

All aboard for a project toddlers — and even their parents — just can't resist.



SWEETHEART STICKPIN 80

More laminated-wood jewelry that's a sweetheart to make.



SHORT-SUBJECT FEATURES

Editor's Angle	6	Holiday Firestarters	26
Talking Back	8	Yesterday's Tools	28
Shop Tips	14	Ask <i>WOOD</i>	98
Products that Perform	21	Lathe Chucks	103
Sound Advice	24	Bulletin Board	112

NOW! REDUCE THE RISK AT YOUR TABLE SAW



folds down neatly

WITH THE NEW MOBILE™ SAWING CENTER

- OUTFEED ROLLERS**
- safe, accurate sawing
 - handle panels with ease
 - available in 15" and 37" widths
 - dual-position table

AND INCREASE FLOOR SPACE

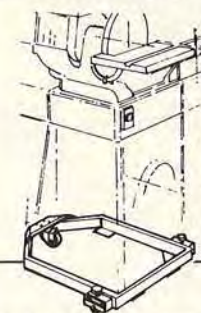

- MOBILE MACHINE BASES**
- increase shop working area
 - maximize usable floor space
 - 3 point base will not rock
 - locking wheels
 - makes machine so easy to use and store
 - over 80 standard models

PLANER STAND WITH ROLLERS

- raises planer to proper working height
- provides machine mobility
- five-fold increase in workpiece support
- storage is a snap



NEW



- ROLLERTABLE Rock Solid Support**
- adjustable
 - portable
 - use at any machine

Discover HTC's many unique products designed only with you, the dedicated woodworker in mind. Find out how you can make your machining safer, increase working area of your shop and accomplish nearly impossible tasks easily, quickly and accurately - **all by yourself!**

CALL TODAY!
 HTC PRODUCTS, INC.
 120 E. HUDSON S-B
 ROYAL OAK, MI 48067
 (313) 399-6185
1-800-624-2027 ext. 112

Cascade Precision Tool Co.
Box 848, Mercer Island, WA 98040

PREMIUM QUALITY  **GRAND** CARBIDE TIPPED ROUTER BITS AND SHAPER CUTTERS
 — CUSTOM WORK A SPECIALTY.

FALL SPECIAL!!

15% DISCOUNT ON OUR ALREADY LOW PRICES WHEN YOU PURCHASE THIS
 4 PC. 1/2" SHANK CARBIDE TIPPED ROUTER BIT COMPLETE CABINET DOOR SET.



REGULARLY \$229⁹⁵
NOW ONLY \$195⁰⁰

- Big 3 1/2" O.D. PANEL RAISER (choice of 5 profiles) Reg. \$59⁹⁵
- RAIL/STILE CUTTER
- RAIL END CUTTER (choice of 4 profiles) Both Reg. \$129⁹⁵
- DOOR LIP CUTTER (choice of 2 profiles) Reg. \$39⁹⁵

NEW ROUTER BITS!!

- DRAWER GLUE JOINT \$39⁹⁵
- CORNER LOCK MITRE 3 3/4" O.D. \$49⁹⁵ For up to 1" material



FREE 1/2" DOVETAIL WHEN YOU ORDER A SET OF CARBIDE-TIPPED ROUTER BITS INCLUDING 3/4" RABBIT, 5/8" OGEE, 1/2" COVE, 1/2" ROUND-OVER, 1/2" AND 1/4" STRAIGHT BITS WITH EXTRA BEARING FOR BEADING. 1/4" SHANK SET \$64⁹⁵ PPD. 1/2" SHANK SET \$69⁹⁵ PPD.



CARBIDE TIPPED SHAPER CUTTER PANEL RAISER—

- 3 WING, 5 PROFILES, 3MM THICK CARBIDE
- 4 5/8" O.D. with 3/4" BORE (1/2" BUSHING) \$69⁹⁵ ea.
- 5 1/2" O.D. with 1 1/4" BORE (1" BUSHING)



CARBIDE TIPPED SHAPER CUTTERS

- | | | |
|---------------------------|---------------------------|--------------------------|
| 1 1/4" BORE W/1" BUSHING | 3/4" BORE W/1/2" BUSHING | 1/2" BORE |
| • 4 WING | • 3 WING | • 3 WING |
| • 3 mm OR 4 mm CARBIDE | • 3 mm CARBIDE | • 2 mm |
| • CUSTOM MANUFACTURED | • 60 STOCK PROFILES | • 20 STOCK PROFILES |
| • FROM \$45 ⁰⁰ | • FROM \$29 ⁹⁵ | • \$22 ⁹⁵ EA. |

6 PC. CARBIDE TIPPED CABINET SETS

- 3mm CARBIDE
- 3/4" BORE W/1/2" BUSHING
- 13 STOCK PROFILES
- \$149⁹⁵ TO \$179⁹⁵



ORDER BY PHONE WITH VISA/MC OR SEND MO. CHECK, VISA/MC NUMBER, EXP. DATE, PHONE NUMBER.
 CATALOG \$1 — FEATURING OVER 200 CARBIDE TIPPED ROUTER BITS AND SHAPER CUTTERS.

ORDER TOLL FREE: 1-(800)-235-0272
 IN WASHINGTON STATE CALL 1-206-236-0272
 10 AM - 7 PM — Monday through Saturday



THE EDITOR'S ANGLE

**All Work and No Play
 Makes WOOD a Dull
 Magazine**  Print this article



Photograph: Terry Lichtenberger

Legend has it that Sir Isaac Newton developed the theory of gravity after being bonked on the head by a falling apple. And more recently, 3M Company's Art Fry came up with the idea for the Post-it Brand Note Pad (those adhesive-backed notes we like to stick on everything) while singing from his hymnal at church one Sunday. Let's face it! These two guys were terribly lucky. One was taking a break on a nice autumn day when his idea hit. And the other just wanted a good way to mark the location of the current day's selection of hymns.

It's a lot like that in the magazine business. You never know where or when you're going to think of something you're sure the readers will love. Sometimes, the office just isn't the best place to get creative. Sometimes, it's Kansas City, Missouri, as the WOOD staff found out this past summer. For two days and two nights, we locked ourselves away in a hotel conference room trying to decide what articles, projects, and techniques to include in upcoming issues. And you know something, it worked! We've got almost everything mapped out through the February, 1988 issue. I'm biased, I know, but I think you've got some great material coming your way.

In case you're wondering how we had time to take a cruise on the Missouri River Queen with our spouses if we were so busy, please reread the headline at the beginning of this article. 🍀

**Have a Happy
 Holiday Season!**

Larry Clayton

**IF YOU VALUE YOUR FINGERS....
 YOU NEED A RIPSTRATE®**

The RIPSTRATE holds the work tight against the fence with no hands near the blade. Makes perfect, straight cuts. Wheels lock to prevent kickbacks. *Requires no adjustment for stock width or thickness.*

Over 20,000 now in use in amateur, professional, school, government, military, and corporate maintenance shops.

One year guarantee, 30 day money back trial. \$69 prepaid. Check, M.O., Visa or M.C. Free Brochure.

Write or call our toll free number: 800-421-0256.

Fisher Hill Products 4 Fisher Hill Fitzwilliam, NH 03447
 Dealer inquiries invited.



Affordable Quality

in Carbide Dado & Saws from **freud**[®]

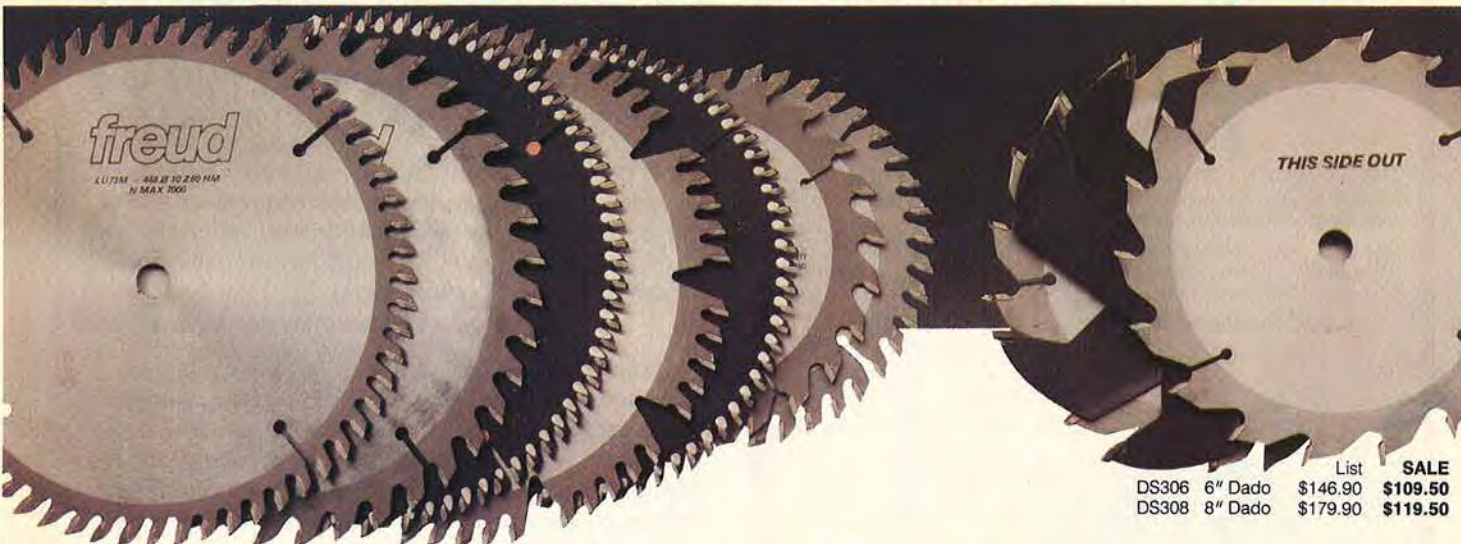

List **SALE**
 DS306 6" Dado \$146.90 **\$109.50**
 DS308 8" Dado \$179.90 **\$119.50**

Three Important Features in a Carbide Circular Saw Blade

The Tips: These are made of carbide tungsten and are available in different grades and thickness. Small, softer tips are used by many manufacturers of blades. But Freud uses the hardest grade available, induction brazes it to the saw shoulder and then applies a "glass" edge with a 400 grit diamond wheel. The larger, more durable tips, mean more blade sharpenings and greater blade life for you.

The Plate Body: Milled tool steel will be found in the plate body of the premium blades. At Freud, after the tool steel is milled, it is heat treated and surface ground on both sides. It is then hammered to provide the proper tensioning and then hand checked for trueness. This will ensure that the blade will stretch evenly when run at high speeds.

The Price: Value is a relationship between quality and cost. At Freud, we provide both in an industrial grade product at an affordable price.

Offer Expires December 31, 1986

	Item No.	Glue Joint Ripping	Rip Plywood	Cross Cutting	Plastic Laminated	General Purpose	Diam.	Teeth	List	Your Cost
Straight Line Ripping Hard & Soft Wood	LM72M 008	E	G	F	NR	F	8	24	56.98	39.99
	LM72M 010						10	24	64.85	43.80
	LM72M 012						12	30	86.57	49.99
General Cross Cutting	LU73M 008	NR	G	G	F	G	8	48	71.65	51.99
	LU73M 009						9	54	79.65	53.99
	LU73M 010						10	60	79.65	44.90
Chip Free Cutting Plastic Laminated	LU78M 008	NR	NR	G	E	F	8	64	93.67	84.99
	LU78M 010						10	80	117.02	82.90
	LU78M 012						12	96	140.87	115.99
	LU78M 014						14	108	166.27	141.99
Aluminum Cutting	LU80M 008	For Aluminum Cutting Only					8	64	93.67	65.90
	LU80M 010						10	80	117.19	82.99
	LU80M 012						12	96	143.49	106.99
	LU80M 014						14	108	170.04	135.50
Precision Cross Cutting For Wood and Veneers	LU82M 008	NR	G	G	G	G	8	48	78.34	55.99
	LU82M 009						9	54	86.40	60.99
	LU82M 010						10	60	86.40	47.80
	LU82M 012						12	72	123.36	86.99
Combination Blade. 4 ATB Teeth & 1 Square Tooth.	LU84M 008	G	G	G	F	G	8	40	71.53	43.99
	LU84M 009						9	40	70.99	43.99
	LU84M 011						10	50	74.51	44.50
	LU84M 012						12	60	112.60	63.99
Super Precision Cut Off	LU85M 008	NR	NR	E	E	F	8	64	93.27	59.99
	LU85M 009						9	72	101.98	63.99
	LU85M 010						10	80	110.88	73.50
	LU85M 012						12	96	134.30	83.99
	LU85M 014						14	108	149.00	107.50

E = Excellent G = Good F = Fair NR = Not Recommended

8", 9" and 10" have 5/8" Bore. 12" and 14" saws have 1" Bore.

Call Us Toll Free!

FOR THE NAME OF YOUR LOCAL DISTRIBUTOR:

- In California Call Toll Free: 1-800-824-0141
- If You Live In This Area: 1-800-824-8045
- If You Live In This Area Call Toll Free (Outside NC): 1-800-334-4107

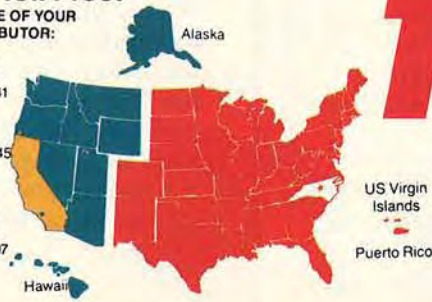

freud[®]

218 Feld Ave.
 High Point, NC 27264
 (919) 434-3171
 1570 Corporate Dr., Suite G
 Costa Mesa, CA 92626
 (714) 751-8866

15" PLANER



SPECIAL SALE!

This high quality planer is the most sought-after machine in the country today. This is the machine that your neighbors (on both sides) probably already own!

Powerful 2 H.P. single phase motor, large 15 x 6" capacity, all ball-bearing 3 blade cutter-head, precision ground cast-iron bed and all around heavy duty construction — weighs 500 lbs.

Regularly priced at \$795.00 + \$100.00 shipping

NOW delivered anywhere in U.S.A.

For Only \$825.00

(except Hawaii & Alaska) (Stand is optional \$49.95)

A SPECTACULAR BUY!!

We use past customers as references. Get a first-hand un-biased report from a user and you will be 100% convinced of our quality & service.



GRIZZLY IMPORTS INC.

P.O. BOX 2069, BELLINGHAM, WA 98227 • PHONE (206) 647-0801



TALKING BACK

Print this article

We welcome comments, criticisms, suggestions ... even an occasional compliment. The volume of mail we receive makes it impossible to answer every letter, but we promise to do our level best. Send your correspondence to: Letters Editor, Better Homes and Gardens® WOOD Magazine, Locust at 17th, Des Moines, IA 50336.

"POP!" GOES THE WOOD JOINT, PART TWO

In your August, 1986 issue (p. 23), you answered Howard Bushnell's question about why his wood joints come loose on tabletops. All your suggestions were just fine, but you neglected to mention the things that will help the most: dowels. In one week I doweled seven tabletops and I have repaired many others. They never come apart.

— H. R. Bockmeier, El Cajon, Calif.

It's hard to argue with success, but we stick with what we told Howard. Dowels add extra strength, but a properly glued joint will hold just fine without them — provided you're mating edge grain to edge grain, that is. End grain joints are a different matter. By all means reinforce them with dowels, splines, or tongues and grooves.

SMOOTH SANDING IN TIGHT SPOTS

With a 1/2" clearance there are several solutions, depending on finish and squareness required.

My first choice is a drill and a carbide burr. The minimum diameter I have found is 1/8" and go up to 3/4". Cost: About \$14. Using a drill press solves the squareness problem.

Second choice is by hand, using carbide sandpaper. It comes in three grades; coarse, medium and fine. The sheets have steel backing which keeps it stiff yet follows any contour. Cost: About \$3 for a 4x11" sheet.

I get my 1/8" carbide burrs from Wood Carvers Supply, Inc., P.O. Box 8928, Norfolk, VA 23503. Carbide sandpaper can be obtained from Sears. They also carry some carbide burrs but not as small as 1/8".

— Fiske C. Saunders, Avalon, Calif.

There you have it folks, tips for sanding in those tough, tight places, and suggested sources for the materials. Many thanks, Fiske, for sending them along for WOOD readers.

BALANCING ACT

WOOD heard from several readers who were unfamiliar with the "balance sheet" called for in the Bill of Materials for our "Double-Duty Table-Saw Extensions" project (August, 1986 issue, p. 64). Guess we goofed in not explaining what a balance sheet is and why you need one, so here goes:

As you probably know, any unsupported panel, such as a cabinet door or tabletop, could absorb

Continued on page 10

PORTER-CABLE

PROFESSIONAL POWER TOOLS

for the best quality at the best prices



Mortise & Tenon Jig

With your bench vise and router, you can create single or multiple mortise & tenon joints at any angle, with exact fit, in just 2 to 4 minutes each! (model 5009)

LIST \$49.95 **SALE \$39.00**



Limited Edition "American Classic" Router **NEW!**

This solid die-cast aluminum housed 7/8HP anniversary issue router honors the tradition of excellence found in all Porter-Cable tools.

SALE \$135.00

Order No.	Description	LIST	SALE	690	1 1/2 hp router	194	132
7548	Top-Handle jig saw	199	136	691	1 1/2 hp D-handle router	218	153
7648	Barrel-Grip jigsaw	199	139		3 hp router	460	314
315-1	13 amp saw	166	108	520	Top-Handle jig saw	199	136
360	3x24 belt sander dustless	280	196	7548	Barrel-Grip jigsaw	199	139
361	3x24 belt sander	260	182	9118	Porta-Plane kit	299	204
362	4x24 belt sander dustless	295	201	319	Laminate trimmer	215	145
363	4x24 belt sander	280	196	309	Laminate trimmer	130	91
330	Finish sander	87	54	312	Laminate trimmer	190	133
505	Finish sander	175	113	7514	1/2" drill	205	143
630	1 hp router	150	105	7511	3/8" pistol drill	169	115
						164	112



Call TOLL-FREE 1-800-638-6405



W.S. JENKS & Son



1933 Montana Ave. NE Washington DC 20002

Build This Beautiful Wooden Ship Model

Wouldn't you love to build this historic ship model? It's a true-to-scale, 21" replica of the 2-masted schooner *Swift*, a Virginia pilot boat of 1805. Well, now you can! And you don't have to be a skilled craftsman to do so.

It really isn't hard

Even if you've never built a model before, you can experience the relaxing pleasure and pride of accomplishment that is offered by this fascinating hobby. You can build the *Swift*. The secret's in our kit, designed especially for the first time modeler, with pre-cut parts that make assembly easy. Clear, large scale plans and instructions that virtually take you by the hand and guide you every step of the way through hours of the most relaxing fun you'll ever have. And when completed - a museum quality model you'll display with pride, with gleaming brass fittings, walnut planked hull, delicate rigging - lifelike in every detail.

Quality you can see and feel

The materials in our kit may be better than those used in the original *Swift*. The keel section and frames are pre-cut plywood, ready for quick assembly. The *Swift's* hull is planked twice; once with thick, flexible limewood for strength, then overlaid with planks of African walnut for lasting beauty.

You don't have to make the fittings - we've done that for you. Our kit contains ready-to-use blocks and deadeyes of rare, yellow boxwood. We include eyelets, bracers and belaying pins - over 70 parts of solid brass! Even the cabin door hinges are brass, as are the 250 miniature nails you'll use to fasten the planking to the hull and deck. And, since the original wooden *Swift* had no plastic parts, our kit doesn't either - anywhere!

Once completed, you can proudly mount your *Swift* on a wooden display pedestal - it's included free with the kit.

Creative? And how! Overwhelming? Not a bit! But be prepared for hours of the most challenging, engrossing, relaxing fun you've ever had.

Order Now & Get A Free Book



Order your *Swift* now and you'll receive a copy of *Ship Models from Kits*, a 110 page beginner's guide which normally retails for \$7.95. This clearly illustrated handbook gives step-by-step instructions for building the perfect ship model. And it's yours FREE when you buy the *Swift* kit at a special low price of \$24.95.

Special Offer On All The Tools You'll Need

You don't need a whole workshop full of tools to build the *Swift* - just the basics. To get you started, we've put together a tool package with all the tools you'll need - at a special low price. You'll get: hobby knife, mini-hammer, pliers, 2 files, ruler, 3 drill bits, 3 blades, razor saw blade, tweezers, sandpaper, glue and Swedish wood oil - a \$34.95 value, but now only \$19.95 when you purchase the *Swift*. You'll even get a tool box 10" long, 4 1/2" wide and 2 1/2" deep to store everything. It's perfect for the beginner!



64 page full color ship model catalog sent FREE with your order.

Model Expo, Inc.

23 Just Road, Fairfield, N.J. 07007

Visit our stores!

2758 W. Sepulveda Blvd. Torrance, CA 90505 • 25 Just Rd. Fairfield, NJ 07007



No. AL100B

FREE BONUS! Miniature Cannon Kit

Set of two solid brass cannon on walnut carriages to be mounted amidship. \$4.00 value, sent FREE with your order.



Credit card holders order toll-free. Call 800-228-2028, ext. 68, 24 hours a day. In Nebraska, call 800-642-8300. Or use coupon below to send check or money order. Order kit No. AL100B.

©Model Expo, Inc. 1986

MODEL EXPO, INC. 23 Just Road, Fairfield, N.J. 07007

BHW-116

YES! Please send me _____ *Swift* kits No. AL100B for only \$24.95 each, along with my FREE handbook, FREE cannon miniatures, and 64 page ship model kit catalog.

Please send me _____ Tool Package Kits No. MXT100B, a \$34.95 value, now only \$19.95 with my purchase of the *Swift*.

Check or money order enclosed. (Add 10% for shipping & insured delivery. N.J. residents must add 6% sales tax.)

Charge my credit card:
 MasterCard Visa American Express

Account No. _____ Exp. Date _____

Signature _____

Name _____











Address _____

City _____ State _____ Zip _____

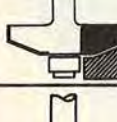
If not more than delighted, you may return your purchase within 30 days for a full refund.

**CARBIDE TIPPED ROUTER BITS
PROFESSIONAL PRODUCTION QUALITY
SPECIAL WINTER \$2.00 OFF SALE—SEE BELOW**

1000's SOLD TO READERS OF FINE WOODWORKING

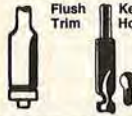
BEST CUT BEST PRICE	ITEM NO.	DESCRIPTION	RADIUS	LARGE DIAM.	CUTTING LENGTH	PRICE
	COVE					
	#01	1/4" R	1/4"	1"	1/2"	\$13.00
	#02	3/8" R	3/8"	1 1/4"	9/16"	14.00
	#03	1/2" R	1/2"	1 1/2"	5/8"	15.00
	ROUND OVER					
	#04	1/4" R	1/4"	1"	1/2"	15.00
	#05	3/8" R	3/8"	1 1/4"	5/8"	16.00
	#06	1/2" R	1/2"	1 1/2"	3/4"	19.00
	ROMAN OGEE					
	#07	5/32" R	5/32"	1 1/4"	15/32"	18.00
	#08	1/4" R	1/4"	1 1/2"	3/4"	20.00
	#11	3/8" RABBETING	Deep 3/8"	1 1/4"	1/2"	14.00
	#09	1/8" (KERF) SLOT CUTTER		1 1/4"	1/8"	14.00
	#10	1/4" (KERF) SLOT CUTTER		1 1/4"	1/4"	14.00
	#12	45° CHAMFER	45° Angle	1 1/2"	5/8"	15.00
	#15	RAISED PANEL	20° Angle	1-5/8"	1/2"	25.00
	#35	1/4" V Groove 90°		1/4"	1/4"	8.00
	#36	3/8" V Groove 90°		3/8"	3/8"	9.00
	#37	1/2" V Groove 90°		1/2"	1/2"	11.00
	#16	3/8" Dovetail 9°		3/8"	3/8"	7.50
	#17	1/2" Dovetail 14°		1/2"	1/2"	8.50
	#18	3/4" Dovetail 14°		3/4"	7/8"	10.50
	CORE BOX (ROUND NOSE)					
	#19	3/8" Core Box	3/16"	3/8"	3/8"	11.00
	#20	1/2" Core Box	1/4"	1/2"	11/32"	14.00
	#21	3/4" Core Box	3/8"	3/4"	5/8"	18.00
	GROOVE FORMING OGEE					
	#22	1/2" Grooving Ogee		1/2"	3/8"	16.50
	#23	3/4" Grooving Ogee		3/4"	7/16"	21.00
	#24	1/4" Straight Bit		1/4"	3/4"	7.00
	#25	5/16" Straight Bit		5/16"	1"	7.00
	#26	3/8" Straight Bit		3/8"	1"	7.00
	#27	1/2" Straight Bit		1/2"	1"	7.00
	#28	3/4" Straight Bit		3/4"	1"	10.50
	#13	1/2" FLUSH TRIM		1/2"	1"	8.50
	#14	3/8" KEY HOLE (This Bit only HSS)	CUTS 3/8" KEY HOLE FOR FLUSH MOUNTING PICTURE FRAMES, ETC.			8.50

**WHEN ORDERING ANY THREE OR MORE, DEDUCT \$2.00 EACH
ALL PRICES POSTAGE PAID**

- Professional Production Quality
- 1/2" Ball Bearing Pilot
- 1/4" Diameter Shanks x 1 1/4" Long
- One Piece Construction
- Two Flute Thick High Quality Tungsten Carbide Tips

**To order by Master Charge or Visa Toll Free
7 Day — 24 Hour Order Service Call
1-800-523-2445 Ext. 56 (In PA 1-800-346-7511 Ext. 56)
or send check to:**

MLCS, P.O. Box 53D, Rydal, PA 19046

TALKING BACK

Continued from page 8

moisture at an uneven rate and warp if you don't seal both sides of the panel. If you're applying finish, you should coat both sides of the panel. Same goes for plastic laminate, but why waste costly colored laminate on a surface that will rarely if ever be seen?

Brown in color and much thinner than ordinary laminates, balance sheet costs only about half as much. Some plastic laminate dealers stock it; with others you may have to special order.

WHAT POWER TOOLS TO BUY: TWO READERS WRITE

Last issue, we responded to WOOD subscriber Ray Amon's question about what power tools to buy for his narrow shop. We asked you readers for your opinions on the subject, and here are two of the letters we received:

No. 1 would be either a table or radial-arm saw.

No. 2 would be a jointer. How many projects can you make where it isn't necessary to joint and edge-glue boards together?

No. 3 is a portable belt sander. It is possible to use a portable belt sander as a stationary sander; however, it is very tough to use a stationary sander as a portable.

No. 4 depends on what your plans are concerning projects. If you plan to use projects that don't use standard 3/4" stock, or if you plan to make projects that will consume 400-500 board feet of lumber (which isn't really all that much), the next choice is a planer. Black walnut and cherry sell for about \$3 per board foot at a lumberyard in my area. At a sawmill, it can be purchased for \$1.25 per board foot. That's quite a savings if you have a planer.

Next comes **No. 5**, a band saw for resawing and cutting curved pieces. If plans include anything with round legs or turnings, next choose **No. 6**, a lathe, and then **No. 7**, the drill press. After this, add a router and bits, **No. 8**.

— David Miller, Annville, Pa.

I recommend a multipurpose power tool such as a Shopsmith. Like Ray, I have limited shop space, so I purchased a Shopsmith Mark V a few years ago. This machine requires about as much space as a bicycle and has adequately met nearly all of my woodworking requirements.

Thanks for producing a top-notch magazine. Please keep up the good work!

— Paul Webber, Amarillo, Tex.

Thanks for your thoughts, guys. Incidentally, Paul, we're planning a report on multipurpose tools for an upcoming issue. One WOOD staff member swears by his Shopsmith, too.

NEW FROM **freud** FOR...

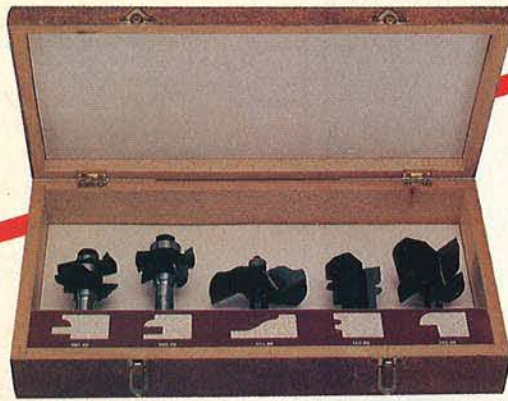

ROUTING

Freud's new 5 piece router bit door system allows you to produce raised panel cabinet doors with your 1/2" chuck router. Each bit is made with the finest carbide available and sharpened with a 600 grit diamond wheel.

The bit profiles are: rail and stile , raised panel door lip , glue joint . The bits come in a wooden, box jointed case for ease of storage. As a set, the 94-100 list for **\$248⁰⁰** Sale Price **\$199⁰⁰**



SHAPING

Freud's new 5 piece cabinet set for the 3/4" - 1/2" shaper comes with rail and stile, raised panel, door lip and glue joint cutters. A box jointed, wooden case is included for ease of storage and prevention of damage.

The cutter profiles are: rail and stile , raised panel door lip , glue joint . The cutters are made with the highest of manufacturing standards and materials. If purchased individually, they would cost \$510.00. As a set, the EC-900 list for **\$449⁰⁰** Sale Price **\$349⁰⁰**



BORING

Freud's new 16 piece Forstner bit set comes in a box jointed, wooden storage case. These bits, guided by their rim, will create a clean flat bottom hole in wood. A special heat treated steel is used in their production to assure long lasting edges.

The 16 bits range in size from 1/4" to 2 1/8" in 1/8" increments. These bits will fit any stationary or portable drill using a 3/8" or larger chuck. The FB-100 Forstner bit set list for **\$249⁰⁰** Sale Price **\$199⁰⁰**

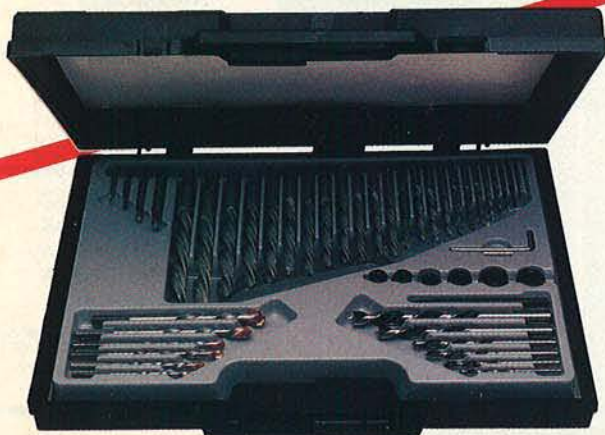

DRILLING

Freud's new 50 piece drill bit set comes with a heavy duty carrying case for ease of storage and protection. This set consists of: A) 25 high speed steel bits (1/16 - 1/2 in 1/16 increments) B) 4 high speed steel bits for use in sheet metal (1/4, 3/16, 1/8, 3/32) C) 6 chrome vanadium steel brad point bits for use in wood (1/8, 5/32, 3/16, 1/4, 5/16, 3/8) D) 6 carbide tipped masonry bits with hex shanks (5/32, 3/16, 1/8, 1/4, 5/16, 3/8) E) 1 center punch, 2 Allen keys and 6 depth stops to set bits at pre-determined depths.

These bits will fit any stationary or portable drill using a 3/8" or larger chuck. The DB-050 drill bit set list for **\$89⁰⁰** Sale Price **\$69⁰⁰**

For The Name Of Your Local Distributor:
Call Toll Free (outside N.C.) 1-800-334-4107
In North Carolina Call 1-919-434-3171

Limited Edition "American Classic" Available At These Fine Porter-Cable Distributors

ALASKA

Alaska Industrial Hardware
Anchorage, Fairbanks, Kenai,
Wasilla and Eagle River
(907) 276-7201

ARIZONA

Clyde Hardware Co.
4808 N. 15th Street
Phoenix, AZ 85014
(602) 264-2106

Kaner Company
Phoenix, AZ
(602) 272-2678

ARKANSAS

DuoFast
Little Rock, AR
(501) 455-2247

CALIFORNIA

AAA Wholesale Tool & Supply
17309 Roscoe Blvd.
Northridge, CA 91325
(818) 996-1800

Abbey Machinery
616 N. Brookhurst St.
Anaheim, CA
Toll Free USA 1-800-225-6321
Toll Free CA 1-800-252-2221

AI's Tool Mart
Ventura, CA 93003
(805) 658-8665

E. M. Allen Woodworking
131 So. 9th Ave.
La Puente, CA 91746
(818) 330-1681

Battels Hardware
13238 Whittier Blvd.
Whittier, CA 90607
(213) 696-3218

Buena Tool Co.
Santa Barbara, CA 93101
(805) 963-3885

C. B. Tool & Supply Inc.
San Jose, Hayward, Fresno,
Sacramento, Monterey, CA
(408) 435-8810

D & D Saw & Supply
6162 Mission Gorge Road
San Diego, CA 92120
(619) 280-9320

Diamond Tool & Supply Co.
7307 Canoga Ave.
Canoga Park, CA 91303
(818) 346-2850

Golden West Tool & Supply
Huntington Beach, CA
(714) 848-2274

Jackson's Hardware
Sales & Rental
San Rafael, CA 94912
(415) 454-3740

Jackson Saw Works
369 So. Rosemead Blvd.
Pasadena, CA 91107
(818) 793-8066

Kaner Co.
Los Angeles, CA
(213) 746-5940

Newport Tool Co.
Costa Mesa
Palm Desert
(714) 642-8791

Orange Tool Mart
Orange, CA (714) 633-4211
Riverside, CA (714) 785-1666
Westminster, CA (714) 891-1355

Pacific Hardware & Steel
950 North Seventh St.
San Jose, CA 95112
(408) 298-3111

Pro Tool Inc.
1218 E. Katella Ave.
Anaheim, CA 92805
1-800-445-8665 USA
1-800-842-8665 CA

Rodman Co.
1827 So. Hope St.
Los Angeles, CA 90015
1-800-228-1806 USA
1-800-428-3809 CA

Sacramento Machinery Co., Inc.
3412A Auburn Blvd.
Sacramento, CA 95821
(916) 483-8513

San Lorenzo Lbr. & Tool
2435 41st Ave.
Santa Cruz, CA 95063
(408) 475-6100

Star Tool & Supply Co.
San Diego, CA (619) 275-2500
Santa Ana, CA (714) 972-1926

T. O. Tools
1507 Thousand Oaks Blvd.
Thousand Oaks, CA 91360
(805) 497-1610

Western Hardware & Tool
1947 Carroll Ave.
San Francisco, CA 94124
(415) 468-4530

Westwood Power Tools
4824 S. Sepulveda Blvd.
Culver City, CA 90230
(213) 873-1231

Whole Earth Access
Berkeley, San Francisco,
San Rafael, CA (415) 845-3000
Outside CA 1-800-845-2000

Yaeger & Kirk Lumber/Hardware
Santa Rosa (707) 545-3883
 Ukiah (707) 462-2411
 Sonoma (707) 938-2692

COLORADO

Schlosser Tool & Machinery Co.
301 Bryant
Denver, CO 80219
(303) 922-8244

CONNECTICUT

The Fine Tool Shops, Inc.
20 Backus Avenue
Danbury, CT 06810
Toll Free USA 1-800-243-1037

The Power Tool Center
135 Kinney Street
Torrington, CT 06790
(203) 482-7273

Tools of the Trade
100 Federal Road
Danbury, CT 06810
(203) 748-8134
1-800-422-0062

DELAWARE

Holloway Bros. Tools, Inc.
P.O. Box 3055, Basin Road
Wilmington, DE 19804
(302) 322-5441 DE
1-800-346-7801 USA

DISTRICT OF COLUMBIA

W. S. Jenks & Son
1933 Montana Ave.
Wash. D.C. 20002
Toll Free USA 1-800-638-6405

FLORIDA

IMA Tool Dist
2800 NW 72 Ave.
Miami, FL 33122
Toll Free FL 1-800-432-1206
Toll Free USA 1-800-647-8005

HAWAII

Slim's Power Tools, Inc.
1626 Republican St.
Honolulu, HI 96819
(808) 841-0902

ILLINOIS

R. A. Ness & Co.
The Woodworker's Emporium
Niles, IL
(312) 824-0565

INDIANA

Edward B. Mueller Co.
Woodworking Machinery & Supplies
Indianapolis, IN
(317) 783-2040

Merrick Evans, Inc.
2116 W. Coliseum Blvd.
Fort Wayne, IN 46808
(219) 482-4822

The Wood-Craftsman's Store
2116 W. Coliseum Blvd.
Fort Wayne, IN 46808
(219) 482-4822

IOWA

C. W. Crossen Machinery Co.
706 E. River Drive
Davenport, IA 52803
(319) 324-9365 or (319) 324-9351

Puckett Tools & Fasteners
Tool Specialist of Iowa
1011 Keo Way, Des Moines, IA
(515) 244-4189 IA
1-800-532-1267 USA

KANSAS

Duofast
Wichita, KS
(316) 942-7118

KENTUCKY

Bailey Tools & Supply Inc.
1418 So. Shelby St.
Louisville, KY 40217
(502) 635-6348

LOUISIANA

E. R. Kiper Hardware and Supply
703 N. Fifth St.
Monroe, LA 71201
(318) 322-4412

MAINE

Maine Hdwe. Biddeford 284-4553
Maine Hdwe. Brunswick 729-3356
Maine Hdwe. Westbrook 854-2571
Maine Hdwe. Portland 773-5604

MASSACHUSETTS

Burns Power Tools
Fall River, MA
Toll Free USA 1-800-341-2200
In MA (617) 675-0381

Danvers Hardware, Inc.
Danvers, MA
(617) 777-3718

Robi Tool Sales
160 Broadway
Somerville, MA 02145
(617) 776-1234 MA
1-800-446-1189 USA

Service Sales Corp.
442 Cambridge St., Allston
For Location Nearest You
Call (617) 254-2444

Star Sale and Dist.
29 Commerce Way
Woburn, MA
(617) 933-8830

Toolhaz Corp.
50 Brook Rd.
Needham, MA 02194
(617) 449-4756

Town Paint and Supply
All Stores

Trend Lines
375 Beacham St., Chelsea
Toll Free USA 1-800-343-3248
Toll Free MA 1-800-322-6100

Winer Bros. Hardware
Salem, MA (617) 744-0780
Beverly, MA (617) 921-0509

MICHIGAN

B-Line Machinery & Supply Co.
21760 Coolidge Highway
Oak Park, MI 48237
(313) 541-0145

Fasteners, Inc.
2909 Buchanan S. W.
Grand Rapids, MI 49508
(616) 241-3448

Glenn Wing Power Tools, Inc.
1437 S. Woodward Ave.
Birmingham, MI 48011
1-800-821-5177 USA
1-800-448-1572 MI

Marsh Power Tools, Inc.
20579 Middlebelt Road
Livonia, MI 48152
(313) 476-7744

Waterston's Machinery & Sup. Co.
960 West 8 Mile Road
Ferndale, MI 48220
(313) 545-1500
(313) 545-2490

MINNESOTA

Art Betterley Enterprises, Inc.
Laminate & Woodworking Tools
11160 Central Ave. N. E.
Blaine, MN 55434
(612) 755-3425

Capitol Carbide
1000 University Ave.
St. Paul, MN 55104
1-800-328-8152 USA
(612) 644-9629 MN

Gardner Hardware Co.
515 Washington Ave. N.
Minneapolis, MN 55401
(612) 333-3393 Est. 1884

Hallmark Building Supplies Inc.
Minneapolis, MN 55344
1-800-642-2246

Tools On Sale™
Division-Seven Corners Ace Hdw.
216 W. 7 St.
St. Paul, MN 55102
Toll Free USA 1-800-328-0457

MISSOURI

Pyramid Tool & Machinery
1200 Erie Street
No. Kansas City, MO 64116
1-800-821-3704 USA
1-800-892-3816 MO

MONTANA

Willow Creek Tool Sales
Main St., Willow Creek, MT 59760
Toll Free MT 1-800-592-8500
Toll Free USA 1-800-592-8501

NEBRASKA

Kel-Welco Distributing, Inc.
8222 H Street
Omaha, NE 68127
(402) 592-1250 NE
1-800-228-2484 USA

NEVADA

Kaner Company
Las Vegas, NV
(702) 732-3177

NEW HAMPSHIRE

Hammar Industrial Supply
Nashua, Portsmouth, Manchester
882-5161, 431-1111, 622-4425
1-800-572-1889 NH
1-800-343-4555 NE

The Tool Warehouse
2 Park Ave.
Hudson, NH 03051
(603) 889-9035

NEW JERSEY

Force Machinery Co.
2271 Route 22
Union, NJ 07083
(201) 688-8270

Monmouth Cabinet & Tool Supply
907 Bangs Ave.
Asbury Park, NJ
(201) 775-2287

Tool Town Hardware
155 Route 17
Paramus, NJ 07652
(201) 262-6337

Warren-Balderston Co.
1321 Princeton Ave.
Trenton, NJ
Toll Free NJ 1-800-792-9736
Toll Free USA 1-800-257-9077

Woodworkers Supply
5604 Alameda N.E.
Albuquerque, NM 87113
Toll Free USA 1-800-645-9292

NEW MEXICO

Woodworkers Supply
5604 Alameda N.E.
Albuquerque, NM 87113
Toll Free USA 1-800-645-9292

NEW YORK

Allied Hardware
76-10 Main St.
Flushing, NY 11367
Write for Literature and Price

Dynamite Tool Company
221 Selden Plaza
Selden, NY 11784
(516) 732-1020

Fowler & Keith Supply Co.
104 Smith Ave.
Kingston, NY 12401
(914) 331-0004

H. T. Sales Company, Inc.
718 Tenth Avenue
New York, NY 10019
(212) 265-0747

Jackson Saw & Knife Co., Inc.
517 State Street
Rochester, NY 14608
(716) 546-7485
Ask for Jim

McKiligan Supply Corp.
Complete Wood Tool Supplier
Johnson City, NY 13790
Mail Order Phone (607) 729-6511

Pelham Tool Co., Inc.
21 Abendroth Ave.
Portchester, NY 10573
(914) 937-1771
(212) 829-8744

Philipps Bros. Supply, Inc.
2525 Kensington Ave.
Amherst, NY 14226-4930
(716) 839-4800

Riverhead Tool Corporation
1407 Pulaski St.
Riverhead, NY 11901
(516) 727-5510

The Tool Warehouse™
Willow Park Center
Farmingdale, NY 11735
(516) 420-1420 NY
1-800-645-9166 USA

The Tool Warehouse™
1080F Old Country Road (Rt. 58)
Riverhead, NY 11727
(516) 727-TOOL
(516) 727-8665

NORTH CAROLINA

Blume Supply, Inc.
3316 South Blvd.
Charlotte, NC 28209
Call Collect (704) 523-7811

Citizens Home Center
841 Merrimon Ave.
Asheville, NC 28804
(704) 254-7244

NORTH DAKOTA

Acme Electric - Since 1948
Tool Crib of the North
Grand Forks, North Dakota
1-800-358-3096 Ask for Mike

OHIO

Edward B. Mueller Co.
Cincinnati, OH
(513) 761-6777

Viking Machinery & Tool Supply
Clev. 587-3331 Akron 753-1063
OH WATS 1-800-362-0585
VISA & M/C WATS 1-800-223-3487

OKLAHOMA

Duofast
Tulsa, OK
(918) 836-4601
Oklahoma City, OK (405) 787-6533
Whitton Supply Co.
1419 W. Reno
Oklahoma City, OK 73126
OK WATS 1-800-522-4419
236-5561

OREGON

Cascade Wholesale Hardware
Portland, OR (503) 645-6441
Toll Free OR 1-800-545-5522
Toll Free USA 1-800-635-6511

Jerry's Building Materials Ctr.
Your Complete Tool Store
2600 Hwy. 99 N. P.O. Box 2611
Eugene, OR 97402
(503) 689-1911

PENNSYLVANIA

H. K. McJunkin, Inc.
7724 Edgewood Avenue
Pittsburgh, PA 15218
(412) 271-5400

National Industrial Hdw., Inc.
462 North Fourth Street
Phila., PA 19123
(215) 627-1091
NY, NJ, CT, DE, & MD
1-800-334-9582

Servistar & American Hardware Stores
Available at participating stores

Woodworker's World
715 Fountain Ave.
Lancaster, PA 17601
(717) 299-5264

RHODE ISLAND

JT's Home & Builders Centers
Rhode Island Locations
Bristol, Warwick, Wakefield
Providence, Middletown

A Work of Art You Won't Keep On A Pedestal

SOUTH CAROLINA

Hiller Hardware Co.
P.O. Box 1762
Columbia, SC 29202
(803) 779-3131

TENNESSEE

Tennessee Machinery Co., Inc.
P.O. Box 18
Nashville, TN 37211
(615) 244-8150

TEXAS

D & R Saw & Tool, Inc.
11060 Harry Hines Blvd.
Dallas, TX 75229
(214) 243-7701
Metro 988-8687

Fort Worth Bolt & Tool Co.
2822 Bledsoe St.
Fort Worth, TX 76107
(817) 335-3361
Metro 429-1711

Mason Machinery Company, Inc.
1908 W. Erwin
Tyler, TX 75702
(214) 592-6581

Otto Dukes Machinery Co.
600 San Pedro
San Antonio, TX
2508 Morgan
Corpus Christi, TX
1-800-221-2063

Pasadena Industrial Supply
222 W. 225 Fwy.
Pasadena, TX 77506
In Houston Area (713) 472-5588
In TX 1-800-392-5289

UTAH

Electric Motor & Supply
1773 South 300 West
Salt Lake City, UT 84115
(801) 486-7564

VIRGINIA

Marco Supply
Hampton (804) 826-0368
Vinton (703) 344-6211
Richmond (804) 745-6350

Pleasants Hardware Co.
2024 W. Broad St.
Richmond, VA
(804) 359-9381

The Source
7305 Boudinot Drive
Springfield, VA 22150
1-800-452-9999

WASHINGTON

Aronson Industrial Supply, Inc.
5300 Demer So.
Seattle, WA 98108
Local (206) 762-0700
1-800-562-8375 WA 1-800-824-4256 WA

Cascade Contractors Supply, Inc.
13131 Northrup Way, Bellevue, WA
2715 6th Ave. S., Seattle, WA
(206) 453-0760 Or 467-6718

Faber Industrial Supply
Moses Lake, WA
(509) 765-8666

Inland Tool & Supply
Pasco, WA
(509) 547-0533

WISCONSIN

Blain Supply, Inc.
And All Farm & Fleet Locations
Janesville, WI 53547
(608) 754-2821

Hallmark Building Supplies, Inc.
Milwaukee, WI 53218
1-800-242-7081

Neu's Supply Line, Inc.
N. 95 W. 16915 Richfield Way
Menomonee Falls, WI 53051
(414) 251-6550

Each "American Classic" router comes with its own specially designed metal presentation case.

For other stocking distributors in your area call Porter-Cable 1-800-321-9443.



This limited edition "American Classic" router is much more than a showpiece.

This 7/8 HP router would rather show its stuff. Because it performs in the time-honored tradition of a long line of Porter-Cable professional power tools. Produced with the quality and durability that brand it "Made in America." Manufactured to exacting standards that professionals demand. Proven on the job for over twenty-five years.

If your work demands the professional touch, get your hands on this "American Classic." With the confident feel of solid die cast aluminum encasing all the power and precision that a Porter-Cable professional tool promises, your work will never be the same.

So if you can appreciate an "American Classic," see the limited edition masterpiece today at your local Porter-Cable distributor.

PORTER-CABLE

AMERICAN CLASSIC

P.O. Box 2468 • Jackson, TN 38302



In woodworking, as in life, no one knows it all. But through experience, we all discover — or stumble onto — better, safer, faster, or easier ways to do things. When we devise interesting tips or techniques, we'll share them with you in this column. And when you send us your favorites, we'll pay you \$25 for each submission we publish. No shop tips can be returned. Mail your tips to:

Shop Tips
Better Homes and Gardens®
WOOD Magazine
Locust at 17th
Des Moines, IA 50336

ON THE LEVEL

When using a hand-held electric drill, it's difficult to determine if your bit is perpendicular to the surface.

TIP: Here's an easy aid if you're drilling parallel to the floor with spade bits. Before inserting the bit into the chuck, slip a large washer over the shaft. If the bit is parallel to the floor, the washer will neither climb up nor walk down the shank.

— Robert A. Grace,
 St. Joseph, Mich.

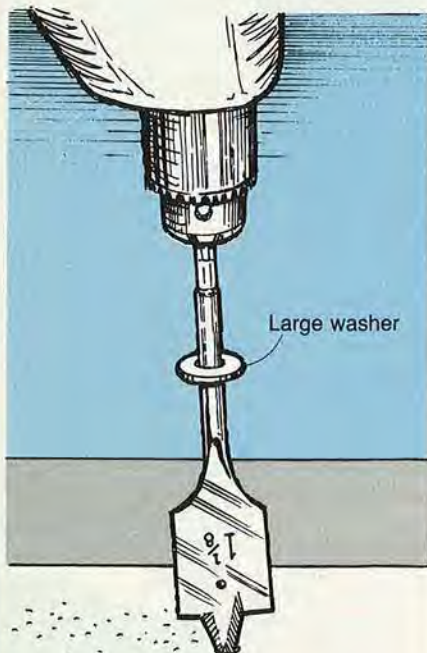
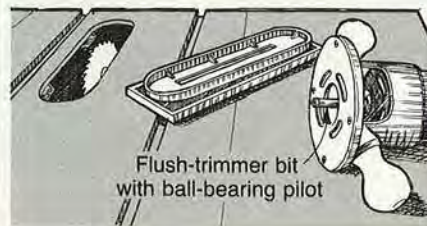

TABLE INSERTS A SNAP TO MAKE

Despite the accuracy of dado and shaper blades, distorted cuts can occur when the workpiece is not supported by the table insert.

TIP: You can make several table inserts with a router and thin plywood scraps. With double-faced tape, join the metal dado insert with a rough-sawn plywood blank. Cut the plywood to the exact size with a laminate flush trimmer in your router. Keep several blanks on hand for a variety of tasks. The zero-clearance cutting increases operator safety, too.

— Michael Cosgrove,
 Goose Creek, S.C.



PICTURE THIS: BETTER CABINETS

One person can struggle untold times trying to align and assemble a box or cabinet.

TIP: No matter what type of joints you've cut, a picture-frame clamp works like another pair of hands in the workshop. Position two adjoining sides and tighten a corner clamp over the joint. Repeat the procedure with an adjoining joint. Now loosen a clamp, reposition the pieces for an accurate fit and tighten. Join the pieces with screws or nails and repeat the procedure with the other joints.

— David W. Schweizer,
 Fellsmore, Fla.

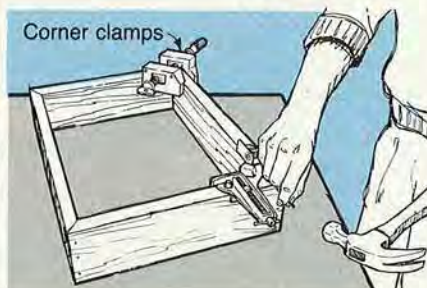

GET A GRIP ON SLIPPERY NAILS

It takes the leverage of a claw hammer to remove difficult nails, but some nails slip right through the claw. If you try a different angle to grab the nail, you could mar or dent the wood.

TIP: Clamp locking pliers over the nail shank, slide the claw under the pliers jaws, and remove the nail with ease.

— Don Butler,
 Waterford, Pa.

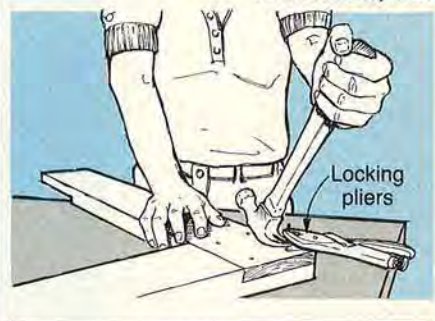

KEEPING BLADES IN APPLE-PIE ORDER

Table-saw blades pose fascinating dangers to curious children exploring in the workshop.

TIP: Plastic containers for keeping and transporting pies safely store saw blades, too. Separate the blades with cardboard spacers. The lids form a tight seal on the 12-inch containers; they also seal out moisture.

— Shauna Beintema,
 San Diego, Calif.

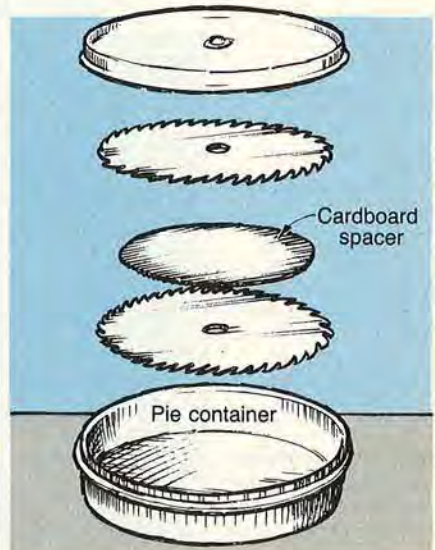

Continued on page 16

Your home workshop can PAY OFF BIG!



This One Low-Cost Power Tool—
SAWS to desired Width...
PLANES to desired Thickness...
MOLDS all popular Patterns...

—All at once or separately. . . All By Power Feed!

The Only Complete Workshop Tool Of Its Kind In The World!

From the Day It Arrives . . . the Planer will make and save you money. With shortages and inflation driving lumber prices sky-high, this versatile power tool quickly pays for itself by easily converting low cost rough lumber into high value finished stock. In just one pass turn out your own quarter-round, door and window stop, casing, tongue-and-groove . . . all popular patterns. Other operators are making cases for grandfather clocks, furniture, picture frames, bee hives, bed slats, surveying stakes . . . all kinds of millwork.

Built For Pros . . . Priced For Home Craftsmen . . . it is engineered and built to industrial standards, but factory-direct selling keeps the price low. Handles tough oak and walnut as easily as pine, and so simple to operate even beginners with no experience can use it.

**Start
Your Own
Business!
Earn Extra
Income
Right At
Home.**

With just this one low cost power-feed machine in a corner of your garage or basement, you're set up to supply lumberyards, cabinetmakers, carpenters, remodelers, contractors and hobbyists in your area with custom-planed lumber, trim, molding . . . ALL of their millwork requirements. You can supply picture molding to art shops, hardware and department stores, or sell direct to framing shops. All standard patterns are available from stock, or we'll custom grind a knife to your own special design or sample.

Does The Foley-Belsaw Pay? YOU BET!

READ WHAT OWNERS SAY:

A Good Investment • Robert Sawyer, Roseburg, Oregon: "I believe that the Foley-Belsaw is the best investment I ever made. I've been a planer man for years and am now retired. The Foley-Belsaw has earned me \$60,000 extra income in the past eleven years."

Pays For Itself • R.S. Clark, Springfield, Ohio: "I bought a batch of walnut in the rough, and after planing it on the Foley-Belsaw I figured up the money I saved. It was enough to pay for two-thirds the cost of the Planer. It really does a good job!"

More Than Expected • Stephen Schultz, Orangeville, Penna.: "This machine pays for itself by making money out of scrap boards. It is a very well built machine and I confess it is more than I really expected for the price. It does everything you say it will!"

... And Foley-Belsaw Is The Choice Of Professionals:
"I recommend Foley-Belsaw Planer-Molder-Saw as the most useful shop tool any craftsman could own. We use one every day in the Workbench model shop, and couldn't get along without it."

JAY HEDDEN — Editor WORKBENCH Magazine

Try The
Foley-Belsaw In Your
Own Shop On Our
**30-DAY FREE
TRIAL OFFER**
Mail Coupon Below
For Complete
Details!

You Take NO RISK! The Planer/Molder/ Saw Is Backed by Our Exclusive 100% Guarantee of Satisfaction:

• "Try the Foley-Belsaw in your shop for a full 30-Days and put it to work for you. Give it a thorough test and make it prove that it can do everything we say it will . . . use it just as much as you want. Then if you are not completely satisfied, just send it back and we'll return every penny you sent. And YOU are the sole judge! There are no questions asked . . . there are no fine print 'use' charges. Our flat guarantee is that YOU must be 100% satisfied or you get your money back."

**FREE
BOOKLET!**

Get FREE Book with facts and full details . . . RUSH COUPON TODAY!



**Just Mail Coupon . . .
NO OBLIGATION and
NO SALESMAN Calls!**

**ACT NOW!
Coupon
Brings
Full Details!**

If coupon has been removed, just send postcard with name and address to:

FOLEY-BELSAW CO.
90911 FIELD BLDG.
KANSAS CITY, MO 64111



FOLEY-BELSAW CO.
90911 FIELD BLDG.
KANSAS CITY, MO 64111

YES, please send me the FREE Booklet that gives me complete facts about your Planer-Molder-Saw and full details on how I can qualify for a 30-Day Free Trial right in my own shop. I understand there is No Obligation and that No Salesman will call.



NAME _____

ADDRESS _____

CITY _____ STATE _____ ZIP _____

THE ONION THAT'S
SWEET ENOUGH TO
EAT LIKE AN APPLE!

WALLA WALLA SWEET ONION

**FREE
CATALOG**

It's almost too good to cook! Eat it raw to really enjoy its wonderful taste. The extra-large slices are perfect for sandwiches. It's the best-tasting and biggest onion we've ever come across. And it's one of more than 4,000 items in Gurney's new spring catalog.



25¢
Pkt.

GURNEY'S™

Seed & Nursery Co.
Yankton, SD 57079



Gurney's, Dept. 83-3350 Page St., Yankton, SD 57079

Here's my 25¢. Please send my onion seed and Gurney's FREE catalog.

Name _____

Street _____

P.O. Box _____ Rt. _____ Box _____

City _____

State _____ ZIP _____

Clip coupon or use extra paper. ZIP speeds delivery.

LIMIT ONE OFFER PER FAMILY.



ANDREU

FREE DELIVERY

FREE DELIVERY

PLANERS:	
AWP-15-15" x 6" 3HP	\$875
AWP-16-16" x 8" 3HP	\$975
AWP-20-20" x 7" 3HP	\$1895
AWP-24-24" x 7" 5HP	\$2795
AM-314-14" 3-SIDED MOULDER	\$5750
TABLE SAWS:	
ATS-10-10" TILTING ARBOR SAW 3HP	\$1095
ATS-14-14" TILTING ARBOR SAW 7.5HP	\$2295
ATSC-10-10" CONTRACTORS TABLE SAW 2.5HP	\$450
JOINTERS:	
AJ-6-6" x 45" JOINTER 1HP	\$325
AJ-8-8" x 67" JOINTER 2HP	\$750
AJ-12-12" x 72" JOINTER 3HP	\$1795
AJ-16-16" WOOD JOINTER 3HP, 5HP	\$2995
SHAPERS:	
AWS-5-1/2" SHAPER 1HP	\$325
AWS-1-1" SHAPER 3HP	\$1095
ATWS-1-1" TILTING SPINDLE SHAPER 3HP	\$1650
AWS-CSR-1 1/4" SHAPER 3HP, 5HP	\$2195
** POWER FEEDER - 4 ROLLERS 1/2HP	\$750
BANDSAWS:	
ABS-20-20" BANDSAW 3HP	\$1295
ABS-18-18" BANDSAW 2HP	\$695
ABS-14-14" BANDSAW 3/4 HP	\$325
ABS-36-36" BANDSAW 5HP, 10HP	\$4495
WIDE BELT SANDERS:	
AWBS-25-25" with platen head 10 15HP	\$2995
AWBS-37-37" with platen head 15 20HP	\$5595
SANDERS:	
AEBS-89-6" x 89" EDGE BELT SANDER - 2HP	\$450
ASG-12-6" x 48" SANDER GRINDER - 1HP	\$375
DUST COLLECTORS:	
ADC-2-2 BAG, 2HP	\$395
ADC-4-4 BAG, 3HP	\$525
COMBINATION MACHINES:	
ACJPB7-8.7" JOINTER/PLANER COMBINATION	\$1195
ACE-JOINTER/PLANER/SHAPER/MORTISER/SAW/SADDLE	\$1650
ACSS121-12" TABLE SAW/1" SHAPER with sliding table.	\$2295
OTHER:	
WOOD COPY LATHE - 40" 1HP	\$375
APR-2-OVERHEAD PIN ROUTER 2HP with spindle foot control	\$1095

CALL FOR POWERMATIC & FREUD PRICES!

— PLUS MUCH, MUCH MORE —
1 YR. GUARANTEE ON ALL MACHINERY
Send \$2.00 for Catalog — Refundable
Financing Available - Can Earn You Tax Credits
VISIT OUR SHOWROOM

ANDREU INDUSTRIES, INC.

22-69 23rd STREET ASTORIA, NEW YORK 11105

(718) 278-9528

MC / VISA

24 HOURS /

7 DAYS A WEEK

FREE DELIVERY!!

FREE DELIVERY!!

TIPS FROM YOUR SHOP (AND OURS)

Continued from page 14

DOUBLE-FACED TAPE TO THE RESCUE

No matter how hard you try, hinges seem to move slightly when you mark for stock removal.

TIP: Double-faced tape provides an excellent opportunity to accurately position new hinges. Use a sharp knife and mark out the hinge outline and screw holes. Drill the holes and then remove the stock.

— From the WOOD shop

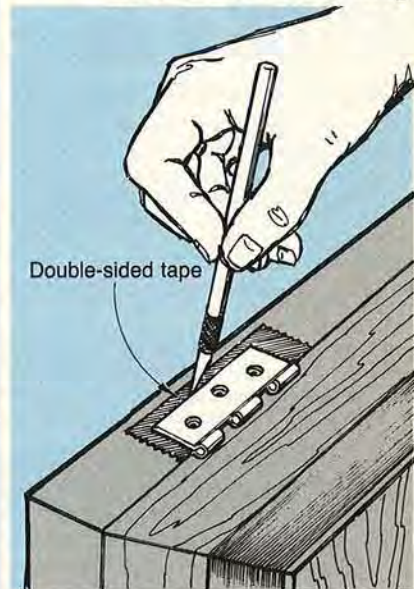

LOW AND INSIDE PLANER

Many woodworkers don't have extra work surface to keep a thickness planer set up.

TIP: The space you need for a thickness planer may be located beneath your workbench. There is plenty of room under many workbenches for compact planers, such as the Ryobi AP-10.

— Larry Naumann,
St. Louis, Mo.

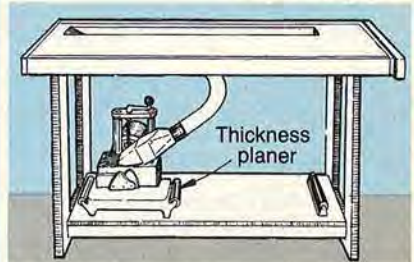

A Shophelper PRODUCT

"Those Yellow Wheels..."

ANTI-KICKBACK STOCK FEEDER

NEW
IMPROVED!

FOR USE ON:
TABLE OR RADIAL SAWS,
SHAPERS, JOINTERS,
ROUTER TABLES, ETC.

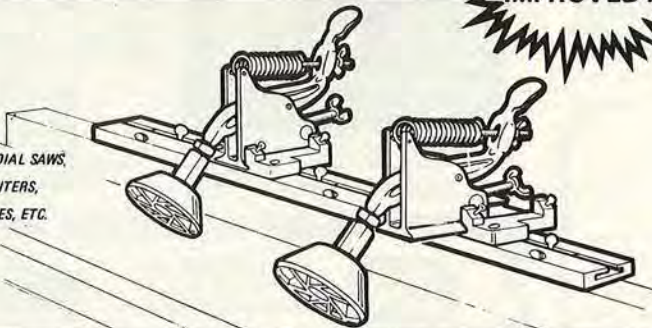

- HOLDS STOCK DOWN AND AGAINST FENCE
- MINIMIZE BINDING, CHATTER AND KICKBACK
- QUICKLY AND EASILY MOVED FROM MACHINE TO MACHINE
- ENSURE OPERATOR SAFETY
- WHEELS INTERCHANGEABLE BETWEEN MODELS
- NEW CONTINUOUS HEIGHT ADJUSTMENT FOR IMPROVED PRECISION
- NEW WHEEL DESIGN
- NEW SLOTTED TRACK FOR HORIZONTAL ADJUSTMENT
- NEW HEAVY DUTY SPRING LOADED ARM
- NEW DOVETAIL BRACKET FOR SMOOTHER ADJUSTMENT

Set complete with brackets \$79.50 (Additional mounting
24" track, 2 gibs, hardware \$29.95 brackets available.)
12" track, 1 gib, hardware \$16.95

Mfg. by Western Commercial Products

For nearest dealer or to order, call: 800-344-7455; CA 800-828-8833 Or write: P.O. Box 238, Tulare, CA 93275

DEALER INQUIRIES INVITED

SAND THE HOLE THING

Hole cutters are great for their intended use, but sanding the inside of the circle is a pain.

TIP: Use the waste plug from the hole to build a custom drum sander. Cut a 1/32"-wide slot about 3/8" deep into the side of the plug. Cut a piece of sandpaper the thickness of the plug by the circumference plus 3/4". Slip a bolt through the plug's hole, and tighten a nut on the back side. Mount this sander in your drill chuck and sand to the desired smoothness.

— Rusty McKnight,
Gadsden, Tenn.

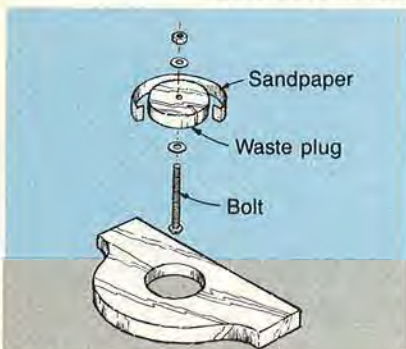

BENT ON SUCCESS

Well-used hinges have a tendency to loosen with age. If the problem goes unchecked, some doors won't close properly.

TIP: A bent hinge pin makes a lot of difference in how an old hinge operates. Tap the pin slightly in the center to create a bend. The hinge should open and close with a smoother action.

— From the WOOD shop

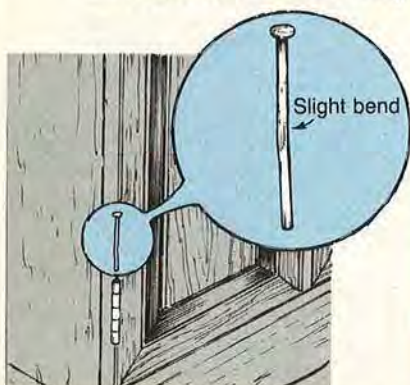

Continued on page 19

WHAT DO YOU SCORE ON THIS WOODWORKER'S TEST?

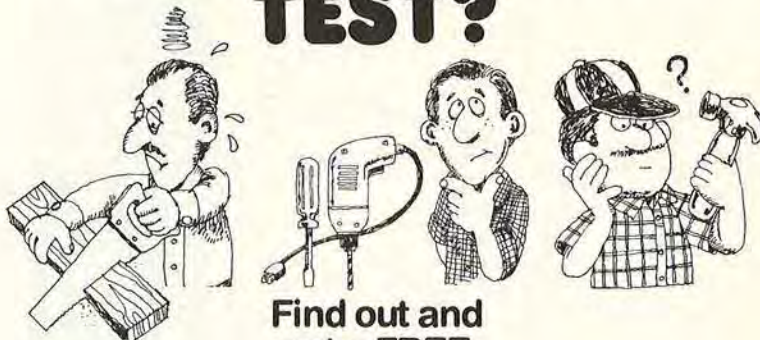

Find out and get a FREE MARK V Information Kit!

The test takes only a minute! Just answer each question, total your score, then fill out the coupon and send it to Shopsmith. We'll send you a FREE MARK V Information Kit. So grab a pen or pencil and get started!

5 Which best describes you?
(A) I do some home repairs and maintenance
(B) I do some woodworking and a variety of home repairs
(C) I'm primarily interested in fine craftsmanship woodworking

Circle A, B or C for each question:

1 How much experience have you had in woodworking, home repair and maintenance?
(A) Little or no experience
(B) Some experience
(C) Quite a bit of experience

2 Which phrase best describes your workshop?
(A) A selection of hand and portable power tools
(B) A table or radial arm saw, hand and portable power tools
(C) A good selection of stationary and portable power tools

3 How involved do you want to become with woodworking, home repair and maintenance?
(A) Not very involved
(B) Moderately involved
(C) Heavily involved

4 What's the likelihood that you'll buy a woodworking tool within the next year?
(A) Not likely
(B) Somewhat likely
(C) Highly likely

How to find your score:

Simple! Count nine points for each (A), six for each (B), three for each (C). Then enter your total on the coupon, fill in your answer for Question #5, include your name and address and mail to Shopsmith!

We'll send you your FREE Information Kit on the Shopsmith MARK V, the complete home workshop that combines the five power tools needed most in one economical unit! *It's the tool to start with... the system you grow with!*

Mail the coupon today!

Quality Woodworking Tools Made in U.S.A.



Shopsmith Inc.

For better woodworkers
And those who want to be
6640 Poe Ave.
Dayton, Ohio 45414

© Shopsmith, Inc. 1986

My Test Score is _____.

On Question #5, I answered _____. Please send me my FREE Shopsmith MARK V Information Kit. I understand I am under no obligation.

Name _____

Address _____

City _____

State _____ Zip _____

Send to:



Shopsmith Inc.

For better woodworkers
And those who want to be
6640 Poe Ave.
Dayton, Ohio 45414

Dept. 380M

RYOBI TOOLS

S500A	3x5 1/2 Finish Sander	70	41
SU6200	Finishing Sand. 1/2 Sheet	142	88
B7075	3x21" dustless Belt Sand.	179	116
B7100	3x24" dustless Belt Sand.	208	140
B7200A	4x24" dustless Belt Sand.	269	165
D100VR	3/8" VSR 0-1200 rpm drill.	91	49
W640	7/16" 13 amp circular saw	158	99
W740	8 1/4" 13 amp circular saw	171	109
JS60	Jig Saw-Single Speed	172	99
JS600	Jig Saw-Electronic w/Speed	198	123
R150	1 H.P. Plunge Router	138	86
R300	2 H.P. Router	220	138
R530	3 H.P. Router	265	163
E3800	Drywall screwdriver 0-4000	126	79
L120R	3/8" Planer	142	89
BD1020R	3/8" 2-sp Cordless Drill w/reel hoister-Xtra special buy	148	95
TS2510	10" Mitre Box	300	169
SG150C	4 1/2" H.D. Mini-Grinder	99	59

YOUR ATTENTION PLEASE!
All Above RYOBI TOOL Prices
Take Additional 10% OFF Sale Prices

MILWAUKEE TOOLS

0224-1	3/8" drill 4.5A magnum	173	109
0234-1	1/2" drill 4.5A magnum	173	112
0244-1	1/2" drill 4.5A magnum	173	115
0222-1	3/8" drill 3.3A 0-100 rpm	159	99
0228-1	3/8" drill 3.3A 0-1000 rpm	139	92
0375-1	3/8" close quarter drill — NEW — 3.5 amp	191	118
0210-1	3/8" cordless drill — NEW — 2 speed	189	95
6539-1	cordless screwdriver — NEW — 190 RPM	99	59
1007-1	1/2" drill 4.5A D-Hdle	217	145
1107-1	1/2" drill 4.5A D-Hdle	222	145
3300-1	magnum rt angle drive kit	271	170
3102-1	Pinbrs rt angle drill kit	287	180
1676-1	HD Hole Hawg w/cse 2 sp	363	235
6385	3/8" sgle sp hammer drill kit	203	150
5397	3/8" vsp sp hammer drill kit	208	155
5371-1	HD mag hammer drill 1/2"	313	207
5373	HD mag ham drill 3/8"	262	175
6511	2 speed Sawzall w/case	187	122
0226	port band saw 2 sp w/case	416	280
6234	TSC band saw port w/case	416	280
9405	8 1/4" circ. saw 13 amp	191	127
6460	10 1/4" 15 amp w/case	380	245
6165	1/2" Chop saw 15 amp 4200 R.P.M.	311	189
6255	w/sp Jig Saw 3.8 amp	217	140
6245	sgle sp Jig Saw 3.8 amp	191	125
6014	1 1/2 sheet HD Orb. sander	173	118
6016	1 1/2 sheet HD orb. sander	184	112
5680	1 1/2 HP router 10 amp	289	175
5680	2 HP router 12 amp	342	220

DRYWALL SHOOTERS

6753-1	3.5 amp 0-4000 rpm new	125	79
6747-1	4.5 amp 2500 rpm	157	100
6750-1	4.5 amp 0-4000 rpm	141	90

NEW FROM RYOBI

MODEL AP-10 — 10" Surface Planer
WEIGHS ONLY 58 LBS.
LIST \$69.00 — SALE \$375.00

MILWAUKEE Super Specials!

BRAND NEW **
Model 0212-1 Cordless
Variable Speed 3/8" Drill
LIST... \$209.00 SALE... \$125.00

Model 6145 — 4 1/2" Sander-Grinder
LIST... \$149.00 SPECIAL SALE... \$85.00

Go Cordless with MILWAUKEE

#6305 — 6 1/4" Cordless Circular Saw
12 volt — 1 Hour Charge
Cuts (80) 2x4's (Pine)
List Price \$229.00 * SALE PRICE \$119.00

FREUD SAW BLADES

Univ. Bore — Professional Series CARBIDE TIPPED SAWBLADES

Item No.	Description	Diam.	Teeth	List Sale
LU72M010	Gen'l Purp.	10"	40	68.58 34
LU81M010	Gen'l Purp.	10"	40	69.30 35
LU73M010	Cut-OH	10"	60	79.65 36
LU82M010	Cut-OH	10"	60	86.40 44
LU84M010	Combination	10"	40	70.99 36
LU84M011	Combination	10"	50	74.51 37
LU85M010	Super Cut-OH	10"	80	110.88 62
LM72M010	Ripping	10"	24	64.85 34
DS 306	6" Dado			139.00 92
DS 308	8" Dado			170.00 105
TR 100	3 blades & Dado set			399.00 255

MAKITA CORDLESS FESTIVAL OF VALUES

Model	List Sale
43000W	Jig Saw 158 99
50810D	3 3/8" Saw Kit 174 99
56000W	6 1/4" Circular Saw 224 125
90350D	Finishing Sander 128 73
60100DK	3/8" Cordless Drill Kit 152 88
60100SD	3/8" Cordless Drill 84 45
84000W	3/8" Hammer Drill 188 105
DA30000W	3/8" Angle Drill 176 98
60100DL	3/8" Drill w/Flashlight 162 89
6012HDW	3/8" 2 spd Driver Drill w/Bat & Metal Case 178 98
DK1002	3/8" Drill w/Furust Kit 164 90
67100W	Cordless Screwdrvr Kit 148 84

LEIGH DOVETAIL JIGS

Model	List Sale
TD514	149 125
TD514L	219 195
D1258-12	299 245
D1258-24	359 275

MAKITA BRAND NEW X-TRA SPECIAL

Model	List Sale
5007NBA	7 1/4" Saw w/Elec. Brake 186 115
5008NBA	8 1/4" Saw w/Elec. Brake 212 130

MAKITA TOOLS

Model	List Sale
904510	Sander 86 43
90400S	3"x 21" belt sander 218 119
9924B	3"x 24" belt sander 208 130
9924DB	3"x 24" b/sander, w/bag 234 130
9035	1/3 sheet finish sander 88 48
9045B	1/2 sheet finish sander 184 90
9045H	1/4 sht fin. sand, w/bag 184 105
4200B	4 3/8 circ. saw 7.5 amp 168 93
5008NB	8 1/4 circ. saw 13 amp 198 105
5201A	10 1/4 circ. saw 12 amp 398 215
4300BW	v/sp jig saw 3.5 amp 218 120
4301BV	orb/vsp jig saw 3.5 amp 230 125
JR3000WL	2 sp recip saw w/case 188 120
JR3000V	vs recip saw w/case 198 120

**** MAKITA TOOLS ** SPECIAL PROMOTION**

LS1000	New 10" Mitre Box	368	198
792210-7A	Carbide Bld for above	49	31
9820-2	Blade Sharpener	268	159
741074-9	60 (coarse) Grdg Whl	33	23
741070-7	1000 (med) Grdg Whl	31	22
741071-5	6000 (fine) Grdg Whl	43	30

19008V	3 1/4" planer w/case	178	92
11090H	3 1/4" planer w/case	312	160
36088K	3/4 hp router w/case	132	85
3601B	1 1/8 hp router	198	115
3709B	1/2 hp trimmer 28,000 rpm	148	82
804500	6" Round Sander	90	48
843000	3/8" angle drill	188	105
HP4700	1/2" vsp w/rev 4.8 amp	172	92
D9103W	3/8 v.s.r. hammer drill w/case	158	98
6300LR	1/2" angle drill w/rev	268	152
841988-2W	3" s.p. hammer drill w/case	268	150
6V5000	Disc Sander	98	53
80000B	2500 rpm 3.5 amp	134	79
80000BV	0-2500 rpm 3.5 amp	144	89
68010B	4000 rpm 3.5 amp	134	79
68010BV	0-4000 rpm 3.5	144	89
2030-	12" planer/jointer	2360	1475
2040	15 1/8" planer	1930	1195
1805B	6 1/8" planer kit w/case	466	265
JV1200	var. speed jig saw	162	89
JV1600	var. speed orb. jig saw	188	100
5005BA	5 1/2" circular saw 8 amp, with brake	176	98

DELTA #34-410 — 10" CONTRACTORS SAW

w/Stand & 1 1/2 H.P. Motor
SPECIAL PRICE \$79.00
FACTORY REBATE: 100.00
FREE DELIVERY TO 48 STATES

9207SPC	7" var/speed electronic sander/polisher	238	130
9303BH	4 1/2" sander-grinder kit	146	95
4014V	var-speed blower	138	79

DELTA — BRAND NEW

Model	List Sale
34-080	10" Mitre Box w/rotary table 279 179
Repeat of a Sellout	
DELTA — SUPER SPECIAL	
40-601	18" Electronic v/sp scroll saw — complete 1117 679

buying from Seven Corners Hdw. . . . is a good Rule to follow.

Model	STANLEY	List Sale
33-116	PL-316 3/4" x 16" Rule	15.95 7.50
33-320	PL-320 3/4" x 20C Rule	16.95 7.95
33-425	PL-425 1" x 25" Rule	18.95 8.95
33-430	PL-430 1" x 30" Rule	20.95 9.95

1986 TOOL CATALOG AVAILABLE
Call Toll-Free 1-800-328-0457 — In Minnesota Call (612) 224-4859
4 WAYS TO BUY: CHECK — MONEY ORDER — VISA — MASTERCARD
SEVEN CORNERS ACE HDW., INC.
216 West 7th St. - St. Paul, MN 55102 - Est. 1933

SAW-ATHON by PORTER-CABLE

#314	4 1/2" Trim Saw	List 180 Sale 109
#346-1	6 1/2" Top Hdle	List 161 Sale 100
#617	1 1/4" Push Hdle	List 166 Sale 96
#587	7 1/4" Speedtronic	List 199 Sale 125
#315-1	7 1/4" Top Hdle	List 166 Sale 96
#368-1	8 1/4" Top Hdle	List 176 Sale 110

BELT SANDERS by PORTER-CABLE

#363	4" x 24" w/o Bag	List - 280 Sale - 185
#362	4" x 24" w/Bag	List - 295 Sale - 198
#503	3" x 24" w/Bag	List - 510 Sale - 350

DELTA #34-410 — 10" CONTRACTORS SAW

w/Stand & 1 1/2 H.P. Motor
SPECIAL PRICE \$79.00
FACTORY REBATE: 100.00
FREE DELIVERY TO 48 STATES

TOOLS ON SALE AMERICA'S LOWEST PRICED TOOLS

PLUS — FREE FREIGHT ON EVERY ITEM

SUPER CORDLESS SPECIALS from BLACK & DECKER

Model	List Sale
1930	3/8" revhi speed 165 110
1950	3/8" High Torque 165 110
5930	Reversible Hammer 179 120
1970	3/8 revhi torque screwdriver 179 120
1980	Rev/adj. clutch Scrdrill 179 120

BRAND NEW! SUPER SPECIALS from MILWAUKEE

0214-1	3/8" c/less drive/drill	189 109
8975	H.D. Heat Gun, 11.6A Low 570°F - High 1000°F	81 49
5920	belt sander 3x24 w/o bag	315 199
5925	belt sander 3x24 w/bag	315 215
5930	belt sander 4x24 w/o bag	326 209
5935	belt sander 4x24 w/bag	348 214

PORTER-CABLE = NEW ITEMS +

Model	List Sale
655	Drywall Driver 0-4000 Rev 115 85
367	3 1/4" Plane 6.5A 170 115
5009	Mortise & Tenon Jig 50 34
351	3" x 21" Belt Sander 189 125
352	3" x 21" Belt Sndr w/bag 199 135
9810	Cordless Screwdrvr kit 175 115
320	Abrasive Plane 3A 129 91

*** ROUTER RIOT * by PORTER-CABLE**

Model	List Sale
100	7/7 H.P. 6.5 amp 141 98
630	1 H.P. 6.8 amp 150 100
690	1 1/2 H.P. 8 amp 194 130
691	1 1/2 H.P. D-Hdle 8 amp 218 145
536	1 1/2 H.P. Speedmatic Double Handle 300 190
537	1 1/2 H.P. Speedmatic Double Handle 315 215
520	3 H.P. Production 460 270
518	3 H.P. Microcompressor 5-sp 490 345

*** X-TRA SPECIALS ***

MAKITA TOOLS

Model	List Sale
10010L	C/less Drill w/flashlight-charger & case 174 90
DP3720	3/8 drill Rev. 0-1800 rpm 98 47
6510LVR	3/8 drill Rev. 0-1500 rpm 138 67
6013BR	1/2" Drill rev. 6 amp 198 100
5402A	16" Circular Saw-12 amp 518 315
2414	1 1/4" Cut Off Saw-13 amp 308 169
3612BR	3 HP Plunge Router 318 175
9401	4x24 belt Sander w/bag 268 160

PORTER-CABLE

Model	List Sale
696	H.D. Shaper Table 150 105
695	H.D. 1 1/2 hp Router/Shaper 278 190
399	Drywall Cut-Out Unit 100 70
736	V/Speed Speedtronic Band Saw 450 330
7564	1/2" X.H.D. Drill 8 amp 205 145

BOSCH TOOLS

Model	List Sale
1581VS	Top Handle Jig Saw 225 126
1582VS	Barrel Grip Jig Saw 126 118
1604	1 1/4 H.P. Router 199 118
1942	Heat Gun 650°-900° 99 85
1272	3x24" Belt Sander 259 159
1273	3x24" Belt Sander w/bag 274 169
1274	4x24" Belt Sander 274 169
1273D	4x24 Belt Sander w/bag 289 179

DELTA Motorized Mitre-Box

Model	List Sale
34-010	Motorized Mitre-Box 231 149

*** NEW LOW PRICES * PONY CLAMP FIXTURES**

Model	List Sale	Of 12
#50	for 3/4" Black Pipe	11.23 7.15 79.00
#52	for 1/2" Black Pipe	9.36 6.10 67.50

JORGENSEN HAND SCREWS

Model	Jaw Length	Open Cap.	List Sale	Box of 6
#5/0	4"	2"	11.59 7.25	39.15
#4/0	5"	2 1/2"	12.45 8.10	43.75
#3/0	6"	3"	13.36 8.50	45.95
#2/0	7"	3 1/2"	14.36 8.95	48.35
#0	8"	4 1/2"	15.97 9.95	53.75
#1	10"	6"	18.25 11.35	61.25
#2	12"	8 1/2"	20.94 13.60	72.95
#3	14"	10"	26.56 16.75	91.35
#4	16"	12"	34.55 23.75	128.25

JORGENSEN BAR CLAMPS

Model	Jaw Length	List Sale	Of 6
#3#3706	6"	7.88 5.50	29.70
#3#712	12"	8.73 5.95	32.13
#3#718	18"	9.64 6.95	37.53
#3#724	24"	10.54 7.35	39.69
#3#730	30"	11.76 8.25	44.55
#3#736	36"	12.85 8.95	48.33

Who Has The Saws That Cut It Across The Board?

BLACK & DECKER of course!!!

Model	WORM DRIVE SAWS	List Sale
3050	6 1/2" 12 amp - 4600 rpm	247 169
3051	7 1/4" 13 amp - 4300 rpm	232 149
30		

Continued from page 17

A TIP GOES "FULL CYCLE"

Ouch! Extended use of a hammer or screwdriver locates hand muscles you never knew you had.

TIP: To cushion your hand from aches and blisters, wear bicycling gloves. The padded palm cushions blows. Because the gloves are fingerless, it's still easy to pick up and hold hardware, nails and tools.

— David Williams,
Cheraw, S.C.



STIR UP A SUPER WOOD FILLER

Because wood putty never seems to exactly match the wood, patches stick out like a sore thumb.

TIP: For an exact color match, there's nothing closer than the actual wood. Gather fresh sawdust — the finer the better — from your belt sander or workbench. On waxed paper, stir epoxy cement with the sawdust, fill holes, cracks and mistakes. ♣

— From the **WOOD** shop



WOODWORKER'S CATALOG

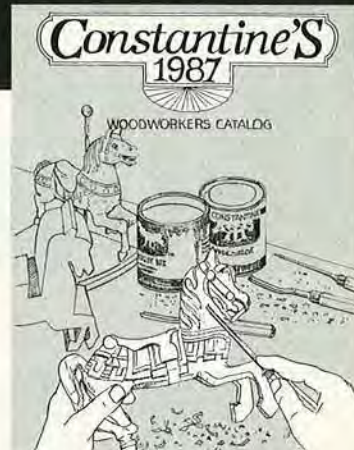

There are over 3,000 money saving reasons why woodworkers rely on Constantine.

3,000 woodwork items—to help you Build-Restore-Repair-Refinish! Over 200 different woods... 150 veneers... 500 plans... cabinet hardware... 96 How-To Books... 118 carving tools and chisels... 76 inlay designs... and lots more for One-Stop, Right-Price Shopping without leaving home!

CONSTANTINE Est. 1812

2054N Eastchester Road
Bronx, NY 10461

Enclosed is \$1.00. Rush my 116 page, full color catalog.

Name _____
Address _____
City _____ State _____ Zip _____
 VISA MC AMEX. Exp. Date _____
Signature _____

OUR HEAVYWEIGHT LATHE IS BUILT TO LAST. THAT'S WHY IT'S WARRANTED FOR 10 YEARS.

That's right, 10 years. And the warranty protects you against breakdown or failure under normal use, as well as against defective parts and workmanship.

Go ahead—compare ours with any foreign or domestic 12" power lathe. Then you'll agree with other serious woodworkers—the Williams & Hussey Heavyweight delivers top value.

Get complete specs and price (it's low!). **Call toll-free 1-800-258-1380** (In NH; 673-3446) or return the coupon.



Here's why the warranty is so strong:

Massive cast iron headstock and tailstock mounted on machined steel bed. No rattle. No sag.

Machined steel and cast iron throughout. No flimsy plastics or stampings to shake and break.

Here's what you can do with The Heavyweight:

Turn 12" diameter stock that's 46" long.

Sand, buff, grind and drill both outboard and inboard, thanks to threadless, precision-ground, .750" headstock spindle.

BUILT TO GO THE DISTANCE



Williams & Hussey Machine Co.
Elm St., Dept. 236KL, Milford, NH 03055

Name _____
Address _____
City/State/Zip _____

30 Day No Risk Trial

TREES HAVE NIGHTMARES ABOUT THIS BLADE.

It's ferociously efficient.
Flawlessly engineered.

IT'S THE PIRANHA® CARBIDE-TOOTH SAW BLADE. FROM BLACK & DECKER.

The Piranha® carbide saw blade lasts up to fifty times longer than conventional steel blades. And outperforms both conventional carbide and steel blades alike.

CUTS FASTER, SMOOTHER THAN CONVENTIONAL CARBIDE BLADES.

Carbide-tipped blades last longer than steel blades. But they tend to cut slower. Rougher. They're harder on the saw, and require more work of the operator.

To solve this problem, Black & Decker has engineered three major breakthroughs in carbide blade technology.

CURVED CARBIDE TOOTH "SLICES" THROUGH WOOD.

Most conventional carbide blades feature a somewhat clumsy block-shaped tooth (see diagram) which "chops" through wood, resulting in a slow, difficult cut.

The Piranha carbide tooth saw blade features an exclusive "curved carbide tooth," which literally slices through wood. Resulting in a faster, smoother cut than conventional carbide blades every time.

Also, by sharpening the tooth through an advanced process,

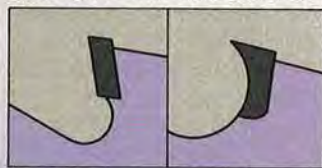

ORDINARY
"BLOCK-SHAPED"
CARBIDE TOOTH

PIRANHA® CURVED
CARBIDE
TOOTH

Black & Decker has achieved an edge considerably sharper than that of conventional carbide blades.

The Piranha carbide tooth blade is even resharpenable, for extended life.

EXTREMELY FAST CHIP REMOVAL.

Another reason for the Piranha blade's ravenous appetite is its exclusive "fishhook gullet" design—a continuous curved surface with no break between the carbide tip and the steel body.

This continuous curved surface prevents wood from wedging beneath the carbide tip, reduces drag, and assures faster more efficient chip removal than conventional carbide blades.

THE RESULT:

A CARBIDE-TIPPED FEEDING FRENZY.

Piranha carbide tooth saw blades are available now in a wide range of sizes, from 5½" to 10", 16 to 60 teeth, for all brands of circular, table, miter, and radial-arm saws. It's no wonder more and more professional job sites across the country are making PIRANHA the carbide blade of choice.

For detailed technical information, write, Black & Decker, 10 North Park Drive, P.O. Box 210-798, Hunt Valley, MD 21030.

The Piranha carbide tooth saw blade from Black & Decker. It may give trees nightmares. But to professional craftsmen, it's a dream come true.



BLACK & DECKER



Carbide Tooth Saw Blade



IF YOU WANT TO BUILD LASTING MEMORIES, ELMER'S WILL SEND YOU THE PLANS.

Build a saltbox doll house. A child's table. Or winged-back chair

Elmer's® has some special plans for that someone special. With easy-to-follow instructions for a child's doll house, table, and chair in authentic colonial designs. And because they're made with Elmer's® Carpenter's Wood Glue, you know you'll get profes-

sional results every time. Just send the UPC code number from either Elmer's Carpenter's Wood Glue or Elmer's Carpenter's Wood Filler, and we'll send you the plans for \$3.00 each. So for years of

lasting memories, go with the lasting name in glue. Elmer's.

Please specify plans (doll house, table, chair) and send check or money order and UPC code number to: Elmer's Plans Offer, P.O. Box 2383, Van Nuys, CA 91409-2383.



(20" x 19" x 32")



(31" x 14" x 14")

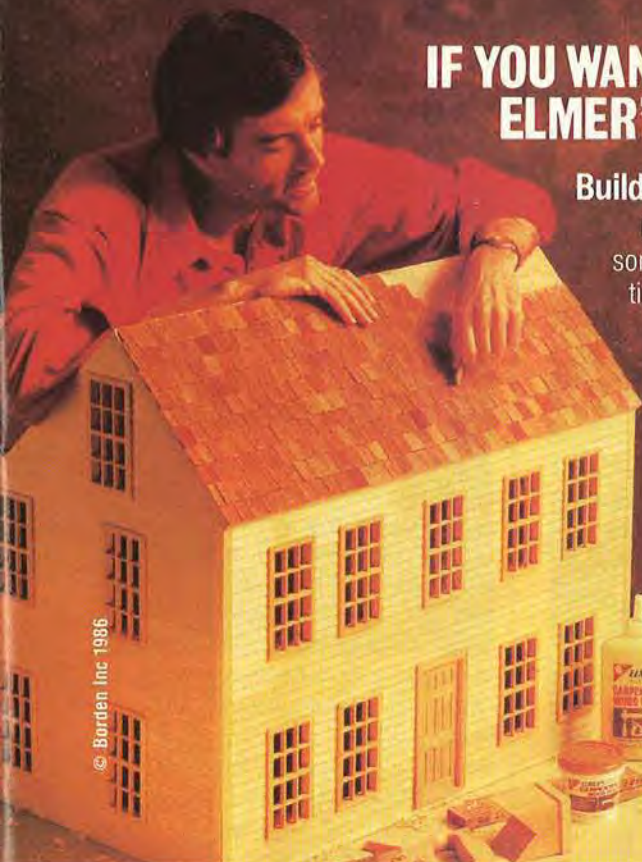

© Borden Inc 1986

PRODUCTS THAT PERFORM

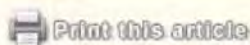

Little shavers



You're probably familiar with Stanley's Surform tools as workhorses that can remove a lot of wood in a hurry. These two little guys are no exception, but they can get into some spots that the big ones can't, including the pocket of your shop

apron. Use them to do close, precision work, such as rounding edges, smoothing nicks, and sculpting irregular shapes.

The Stanley Shaver *at left* operates on the pull stroke; the one-piece molded handle gives you positive control over the blade. The curved, clip-on blade allows you to work on inside curves.

The one-handed Stanley Pocket Plane *at right* has a diecast body and comes with a replaceable 5½" flat blade — just the ticket for working short pieces. You also can fit it with a 46- or 80-grit carbide sanding blade (Stanley product nos. 21-339 and 21-443, respectively) to make it a long-lasting sanding block. *Stanley Surform Shaver* (product no. 21-115), about \$4.00; *Stanley Pocket Plane* (product no. 21-399), about \$5.00. Available in hardware, discount, and department stores nationwide.

A turn for the better



You'll get hooked on turning with this 24-mm turning hook. Designed for use at slow speeds, this "hook" is actually a gouge with the cutting edge oriented 90° to the length of the tool. The hook works best on green wood, and — with a little practice — you can use it to remove large areas of wood quickly. *Turning Hook* (no. 71N03.02), \$37.55 postpaid. We ordered ours from Garrett Wade Co., 161 Avenue of the Americas, Dept. W, New York, NY 10013.

Continued

1,028 good reasons why you should use DML cutting tools...plus 3

A broad line

DML saws, router bits, and shaper cutters. An astounding line of different cutting tools, each engineered for a specific task. Crosscutting. Ripping. Trimming. Routing. Shaping. Molding. And more.

To cut solid wood. Plywood. Hardboard. Asbestos wallboard. Plastics. Nonferrous metals. And much more. Carbide tipped or high speed steel. Virtually any cutting tool you could need.



Industrial quality

The best in American workmanship. Each DML tool is crafted with the utmost care — and with the most current equipment — from top grade tool steel. Precision balanced, and finished to industrial standards. DML doesn't settle for less. Neither should you.



3 more reasons

And DML has just introduced a new line of high speed steel woodturning tools. Available in three kits — one set of eight and two different sets of four — they are meticulously designed for edge retention, easy control, and precision cutting in all varieties of wood. Each kit is packaged in an elegant wooden box fitted with a metal clasp and hinges.

Custom tools

DML can also design and manufacture custom tooling to meet your specific needs.

For immense selection, industrial quality, new tools, and custom-tool capabilities... DML. The only reasonable choice.



For the location of your nearest DML distributor call toll free...

800-233-7297 (SAWS)

DML

America's quality tool maker

DML, Inc.
1350 S. 15th Street
Louisville, KY 40210

A SUBSIDIARY OF VERMONT AMERICAN CORPORATION

PRODUCTS THAT PERFORM

Continued from page 21

Hitting a perfect cord



This line of tough-but-flexible abrasive cords and tapes works well for sanding in tight places. Impregnated with aluminum oxide, the cloth cords and tapes won't tear like sandpaper; both varieties are available in 25-yard dispensers. *Mitchell's Abrasive Cords and Tapes*: no. AC 151 (3/32", 120-grit cord) — \$7.45; no. AC 152 (3/32", 150-grit cord) — \$7.30; no. AC 154 (1/16", 200-grit cord) — \$7.25; no. AC 157 (1/8", 180-grit tape) — \$7.80; and no. AC 158 (1/4", 150-grit tape) — \$8.35. (Add \$2.50 per order for postage.) *Craft Supplies USA*, 1644 S. State St., Provo, UT 84601.

Help for homeless bits



If you're always "losing" drill bits, here's the answer: an inexpensive plastic drill stand that will hold 24 bits ranging from 1/16" to 1/2" (by 64ths). To help you sort sizes, the stand includes a heavy-gauge hardened-steel drill index with permanently etched hole sizes (with decimal equivalents). *General Drill Stand* (no. 57), about \$2.50; *Drill Gauge* (no. 14), about \$7.50. Available in hardware stores nationwide.

Makita

1-800-792-3505 ext. 233
• FREE FREIGHT •

Makita has refined the 10" Miter Saw even further

SUGGESTED LIST PRICE \$348.00

LS 1000 Special Price **\$196**



Model 3612BR 3 HP Router
14 AMP hi-Tech motor
2 1/2" plunge depth capacity

Special Price **\$173**

Model 2708W 8 1/4" Table Saw
with Carbide Blade
powerful 12 AMP
Makita motor and
4500 RPM

\$207



Model 6012HDW Cordless Driver
Drill Kit, 2-Speed Reversible
SUGGESTED LIST PRICE \$178

Special Price **\$95**

WORKBENCH TOOL CO.

2833 Perry St., Madison, WI 53713

Be Your Own Boss and Make \$18.00 to \$30.00 AN HOUR!

One tough tomato



Having built literally hundreds of cutting boards and finishing them with various types of nontoxic oil finishes — cooking oil, mineral oil, and others — our how-to editor Marlen Kemmet says Behlen's Salad Bowl Finish beats them all.

Oil finishes require constant reapplication to seal the board against stains from meat and vegetable juices. But this one dries to a hard, durable surface that will withstand many months of heavy use before a touch-up coat is needed. A typical cutting board will require two or three initial coats. The moisture-resistant finish also helps keep the board from warping and cracking.

Although this finish contains toxic solvents while in liquid form, it is nontoxic when dry and meets FDA approval for use on objects that come in contact with food. This makes it excellent as a tough, glossy finish on kitchen utensils and kid's toys. *Behlen's Salad Bowl Finish.* Write to H. Behlen Bros., Route 30 North, Amsterdam, NY 12010 for list of suppliers in your area. We ordered ours from Wood Finishing Supply Co., Inc., 1267 Mary Drive, Macedon, NY 14502. Cost: \$5.74 pint, \$9.32 quart, \$25.83 gallon. \$2.00 shipping and handling charge on all orders. ♣

**Find out how by...
... sending now for your Free Lifetime Security Fact Kit!**



Your FREE Lifetime Security Fact Kit tells you how to make \$18.00 to \$30.00 an hour in your own Foley-Belsaw Full-Service Saw and Tool Sharpening Business. Your FREE Fact Kit explains how you can:

- be your own BOSS!
- work full time or part time, right at home.
- do work you enjoy and take pride in.
- operate a CASH business where 90¢ of every dollar you take in is clear cash profit.

And it is *so easy* to learn. Foley-Belsaw gives you all the facts and instructions. No previous experience or special training necessary. All you need is the desire and ambition to be your own boss. Foley-Belsaw tells you everything you need to know to be successful.

There's plenty of business where you live to keep you busy. It doesn't matter whether you live in a big city, small town or a small farm community.

Earn While You Learn

You'll quickly be able to develop the skills necessary to earn a steady income. You'll be able to sharpen all types of saws, garden and shop tools for home, farm and industry.

Profits from your Foley-Belsaw Full-Service Sharpening Business can provide...

- ... CASH for future security or supplemental income
- ... CASH for travel, vaca-

tions, fishing trips
... CASH for the things you've always wanted!

And you'll be able to set your own hours and not have to worry about layoffs and strikes. There are no franchise fees. Best of all—age or physical condition is no barrier—any age person can succeed.

You can be like Steve Taylor of Brookville, Ohio, who told us: "... the first year I grossed \$21,000.00."

Or James B. Jones, of Albuquerque, NM who reported: "This past summer my sales and service amounted to almost \$6,000.00 a month."

But you've got to get the FACTS before you can get started. So WRITE NOW for your FREE Lifetime Security Fact Kit. It's yours to keep with NO OBLIGATION.



The Foley-Belsaw Co.
20339 Field Bldg.
Kansas City, MO 64111

FREE Lifetime Security
FACT KIT



FOLEY-BELSAW CO.
20339 FIELD BLDG.
KANSAS CITY, MO 64111

YES, I want to know more! Please rush my FREE Lifetime Security Fact Kit. No obligation and no salesman will call.

Name _____
Address _____
City _____ State _____ Zip _____
(_____) Phone _____

ELEKTRA BECKUM



THE PERFECT
COMBINATION

HC260 JOINTER/PLANER 'and' SPA1000 DUST EXTRACTOR

- Hardened 40" tables
- A clean work environment
- Width of jointer and planer 10 1/4"
- 765 cfm suction capacity
- Max. thickening depth 6 1/2"
- 4" x 98" heavy duty hose
- 63 cuts per inch
- Use any standard trash bag
- 3/4 HP motor 110/1/60

2.4 HP, 220V **\$1250.00**
2.4 HP, 110V **\$1295.00**
4.2 HP, 220V **\$1375.00**

\$450.00

Suggested list price
FOB Somerdale, NJ



Send \$1.00 for full color catalog to:
ELEKTRA BECKUM USA DEPT HCS
PO BOX 24, SOMERDALE, NJ 08083
Call for your local dealer: 1-800-223-8600
See these machines demonstrated at:
Chicago, Oct. 17-19; Atlanta, Nov. 7-9;
Charlotte, Nov. 21-23; Anaheim, Dec. 5-7.

SOUND ADVICE

How to Band Saw A Carving Blank

Print this article

To cut accurately on a band saw, you should always maintain one flat side on your stock so that it rides the table steady and smooth. But that's particularly difficult when you're sawing a carving to shape by following a pattern traced on adjacent sides of the carving block. If you cut the front view side first, you eliminate the flat side of the block you need for support to saw the profile! Some carvers spot-glue it back together, but there's a better way.

Experienced carvers use this technique to maintain solid support on the saw:

Step 1. Start with a piece of block-shaped carving stock on which the two sides not showing the pattern form a 90° angle. The other two sides don't necessarily have to be square.

Step 2. With a 1/8" blade on the band saw, cut along one side of the pattern from bottom to nearly top center, circle in a teardrop shape, and come back down the same line.

Step 3. Repeat the sawing on the other side of the front view, being sure to leave about a 1/4" connecting area of the block intact, as shown in the first photograph.

Step 4. Turn the block to the side on which you've traced the profile and saw one half the pattern, as in the second photograph. On your last cut, saw through the connecting wood at top center to free your carving from the block.

You now have an accurately cut-out "rough" to begin your carving. ♣

Photographs: Craig Anderson



DELTA LOWEST PRICES EVER!

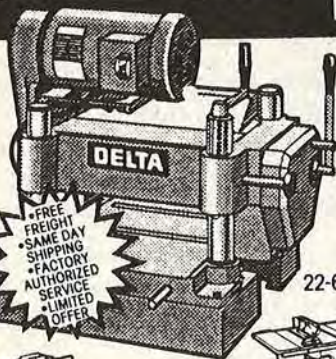

13" PLANER

High Performance, Big Capacity and at Surprisingly Low Cost!

- Completely portable • Cast iron construction • Capacity - 13" x 5.9"
- Large 19 3/4" x 13" table • Spiral, serrated in-feed roll • Twin bed rolls
- Oil-bath lubricated feed/gear box • Feed roll control for fast feed disengagement • 2 HP

22-651

NOW JUST **\$899**



43-375F
WOOD SHAPER
3 HP, 1 PH

\$1499

With Free Cutter



34-783
UNISAW
3 HP

\$1499
50% OFF
CUTTERS &
BLADES
WITH PURCHASE



34-410A
TABLESAW
10"

List \$1,073
After Rebate

\$579



46-541S
12" LATHE
3/4 HP, Accessories

\$1389



40-601
SCROLL SAW
18" Variable Spd.
List \$1,117

\$699

a c m e Electric

TOOL CRIB OF THE NORTH SINCE 1948

CALL TOLL FREE FOR MIKE
1-800-358-3096



E · Z CABINET MAKER

Get ALL the cabinet PARTS & SIZES



at the turn of a SIMPLE DIAL



send \$9⁹⁵ pp

E · Z
p.o. box 292421
ft. laud., fla. 33329

BUILD ANY SIZE EUROPEAN KITCHEN

POWERMATIC

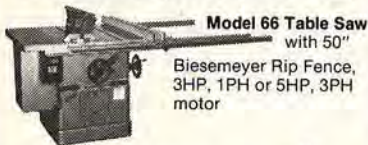

Model 66 Table Saw
with 50"
Biesemeyer Rip Fence,
3HP, 1PH or 5HP, 3PH
motor

Model 26 Spindle Shaper
½" and ¾" interchangeable
spindles 3HP,
1PH or 5HP, 3PH motor
Reversing Switch



CALL FOR OUR LOW PRICES!

We carry the Powermatic line at very attractive prices. Please call for our prices on these and other Powermatic machines. You'll be glad you did!
FOB McMinnville, TN



AP-10
Thickness planer

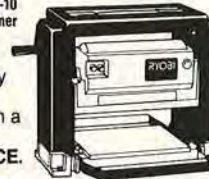

WE DIDN'T BELIEVE IT until we actually used it. This tool works really well — as well as any planer we've used, except on a smaller scale. 10" width of cut, 13 amp. motor powerfeed. **CALL FOR OUR PRICE.**

RYOBI SPECIALS

Model	Description	List	Sell
AH115	Jointer-Planer	\$1299	\$1225
BS360NR	Resaw Bandsaw	2099	1149
RA2500	Radial Arm Saw	619	369
R501	3HP Router	299	159
R151	1HP Router	169	89
TR30U	Trimmer	134	74
BD1025	Cordless Clutch Drill	179	99

Prepaid Prices on Ryobi

THE XYLOPHILE'S COMPANY

138 E. Loudon Ave. • Lexington, Ky. 40505

(800) 354-9083

M/C VISA

FREUD SPECIALS

WC-106	6 Pc. Chisel Set	27.00
WC-110	10 Pc. Chisel Set	47.00
TT-108	8 Pc. Turning Tool Set	47.00
90-100	15 Pc. Router Bit Set	134.00
92-100	26 Pc. Router Bit Set	284.00
94-100	5 Pc. Router Cabinet Set	179.00
FB-100	16 Pc. Forstner Bit Set	159.00
EC-900	5 Pc. Shaper Cabinet Set	289.00
EC-209-213	Raised Panel Cutters	77.00
EC-260	¾" Cabinet Door Set	157.00

Sawblades

LM72M	10", 24T, Rip Blade	34.00
LU73M	10", 60T, ATB Cutoff	34.00
LU84M	10", 50T, Combination	36.00
Set of Three Above		99.00
LU82M	10", 60T, Triple Chip	42.00
LU85M	10", 80T, Super Blade	59.00
DS306	6" Dado	90.00
DS308	8" Dado	99.00

We carry the entire line of Freud shaper cutters and router bits at discounts up to 30%. Please call for prices on these items.

Freud Orders over \$35 are prepaid.

Toolhauz

CORPORATION™ MC • VISA • COD
P.O. Box 821, Needham Hgts, MA 02194 617-449-4756

***Add \$2 shipping to all orders

METABO

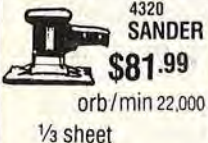

4320
SANDER
\$81.99

orb/min 22,000

1/3 sheet

VIRUTEX

JOINING MACHINE
made in Spain
using slots &
wood splines.

\$250
with case



Brazilian PLANES

#4 smooth- \$12.99

Hand Screw Kits

Jaws not included

8"-4.95 10"-5.25 14"-8.45 16"-10.95
2 ea. handles, threaded rods, nuts & pins.

BAND SAW BLADE SPECIALISTS

SPECIAL OFFER

Buy Six Blades, Get One Free.

Band saw blades cut and welded to your exact specifications

WIDTH	TEETH	PRICE/INCH
1/8" thru 3/4"	3 thru 32	\$.04

Price=inch length x price per inch+1.75 weld charge
NO MINIMUM ORDER

Speedy Delivery
Add \$2.50 for shipping & handling
S.C. residents add 5% sales tax
Send payment with order — write or call

ROBERTS HARDWARE
P.O. Box 1276 • Taylors, SC 29687
803/879-2470

PEG-1000 WHOLESALE

GREEN WOOD STABILIZER
10 lbs. \$22.20 FREIGHT FREE

For Orders Only Call:

1-800-262-1050

with M.C. or VISA

FREE wood finishing products catalog from
GENERAL FINISHES
P.O. Box 14363G, West Allis, WI 53214
For information call: 1-414-774-1050

TURNCRAFT CLOCK CO.

For the **MASTER CRAFTSMAN**
OUR FRIEBURG PLAN #160
51" H. 16½" W. 9¼" D.

Advanced woodworkers will enjoy building this beautiful Vienna Regulator. See our general catalog for choice of 3 movements and dials, turnings, eagle as well as many other clock plans.

ORDER TODAY!

7912 Olson Hwy 55
Dept. BH-988
Golden Valley, MN 55427

To Order Call 1-800-544-1711 **Plan #160**
1986-1987 Catalog \$3.00 refundable. **\$6.50 Plus \$1.00**
Shipping and Handling



SHOP SHAPE-UP with CONCEPT 2001

For years recognized by the European woodworker

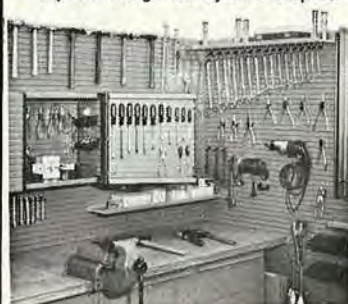

Bins, brackets, hooks and shelves all fit into the grooved wall panels and cabinets of our German-designed modular storage system. You can buy one cabinet or panel of foamed PVC or outfit the whole shop.

To introduce you to this innovative organizer system, we offer **CABINET 301** at ½ PRICE.

CALL IN YOUR ORDER NOW:
(305) 979-5802 or
SEND ORDER COUPON TO:

CONCEPT 2001 Inc.
1321 N.W. 65th Place
Ft. Lauderdale, FL 33309

Check or Money Order Visa MC Qty _____
Card No. _____ Exp. Date _____
Name _____
Address _____
City, State, Zip _____
Signature _____

Quality that will last!!



TOOL CABINET 301
(27½ x 19 x 7) orange color - grey trim,
with 44 absolutely stay-put Tool Hooks.
Completely adjustable.

ONLY \$45.00

(+ \$6.75 ea. shipping & handling)



Why Settle for a "Deal"...

Right now, you can buy some scroll saws at their lowest prices ever (so far). In fact, one brand is now worth 35% less than when it was first introduced! We're not surprised — history shows that cheaper products find their true value in the market over time.

Over the last decade, only one scroll saw has consistently increased in price and value — HEGNER. Even at our incredibly low Holiday Promotion Price, a HEGNER Multimax-2 is now worth 33% more than when it was first introduced!

Why be bothered with trouble-prone electronics and wasteful gimmicks you'll never need with a properly designed machine? Why accept less than the best for your hard-earned dollars?

Stumped when it comes to a quick, inexpensive gift for neighbors and acquaintances? Try brightly wrapped firestarters you make from shop sawdust!

What woodworker doesn't occasionally have mounds of sawdust to dispose of? This practical gift idea puts sawdust to good use.

As their name implies, firestarters get a fireplace fire going, like kindling. They burn long, strong, and bright, and replace the old reliable, wadded up newspaper.

For materials, you'll need:

- white, green, and red tissue paper
- paraffin
- gift ribbon
- sawdust

Quantities, of course, depend on how many firestarters you intend to make. A grocery sack full of sawdust and a pound of paraffin, for instance, will produce three or four dozen.

Before you start assembling your firestarters, heat the paraffin to melting in a saucepan on the stove. Once it's melted, turn down the heat enough to keep it that way. Place a large cookie sheet nearby.

Then, cut the tissue paper into as many 10 x 10" squares as you'll need, and keep them handy next to your sawdust.

Ladle about ½ cup of sawdust into the center of each tissue square. Wrap the tissue tightly around the sawdust and twist the ends together, as if you were making a popcorn ball. Tie a piece of ribbon around the twist.

Dip each wrapped ball of sawdust into the melted paraffin for about 30 seconds to saturate it, then set it on the cookie sheet to "dry." This doesn't take long — the paraffin sets up quickly.

A dozen firestarters in mixed colors, assembled in a wicker bun basket, makes an attractive gift to place on the hearth. From then on, you won't have to worry about what to do with shop sawdust! ♣

Illustration: Jim Stevenson

Holiday Firestarters

 Print this article



YOU TAKE THE HIGH ROAD

 Print this article

Two approaches to Christmas gift making



Woodworkers' methods differ as much as our machines and projects, but we all work for that moment when we can put away the chisels and stains, sit back, and admire our handiwork.

Preparing for this Christmas issue of *WOOD* gave me a good view of two very different approaches to that final moment. Jim Downing, our Design Editor, and I both tackled the same project here in the *WOOD* shop. Although we decided to make the same items, our methods couldn't have differed more. You see, Jim is a perfectionist, which I think shows up in the designs he creates for the magazine. Not me! I'm a production man. Crank them out — one, two, three.

We set out to make the wooden earrings project featured on page 72. I immediately thought of all the ladies who might appreciate a pair of handmade earrings — my wife, my mom, our secretaries, our baby-sitter, and on and on. Jim, on the other hand, decided to make just a couple of pairs for his wife.

I immediately started laminating thin stock and veneers together in long sections; after all, why cut one pair when you can cut 20 or 30? Jim, of course, had to make a few drawings first to see what looked the best on paper. When he finally got started, the size of his lamination didn't leave much room for error.

While I was busy mass-cutting earrings to shape on the bandsaw, as shown in the photo *above*, Jim

cut two pairs and spent what seemed to me an excruciatingly long time sanding them to shape by hand. Once done cutting, I gathered my multitude into a small box and headed for the drill press to begin some production sanding. Jim, meanwhile, was dutifully applying the finish. It would take me several more lunch hours to finish all mine.

We both enjoyed making the wooden earrings, and most of all, giving them as gifts. This goes to show, I guess, that it really doesn't matter if you make one or a hundred items; the satisfaction of woodworking is out in the shop and in seeing others delight in our handcrafts. ♣

Produced by Marlen Kemmet
Photographs: Hopkins Associates

...when you could be getting a Great Deal More?

■ Unlike all others, HEGNER saws offer you a unique, patented design that improves virtually every aspect of your work.

A HEGNER Saw does more for you, and it does it better. That's why it's worth more, and why it always will be.

Get a HEGNER this Holiday Season, and you will get a Great Deal! But instead of just a deal today, you'll enjoy unmatched value and satisfaction for years to come.

Choose a HEGNER from AMI, and get a whole lot more than just a great deal!

Contact your local AMI Distributor or call to order TODAY!
If you don't have enough information, call or write for free literature!

BONUS: Order a HEGNER before December 15, 1986, and SAVE!

Hobymax	Reg. \$495	Now Only \$395	You Save \$100!
Multimax-2	Reg. \$995	Now Only \$795	You Save \$200!
Multimax-3	Reg. \$1695	Now Only \$1395	You Save \$300!
Polymax-3	Reg. \$2145	Now Only \$1745	You Save \$400!

Note: Quantities are limited at these prices, so don't delay.

AMI — because you never regret quality!

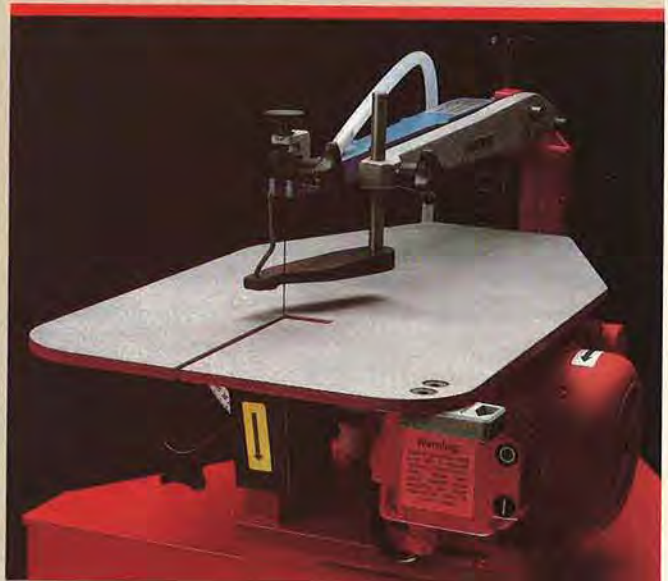

ADVANCED
MACHINERY
IMPORTS, LTD.

P.O. Box 312, Dept. 102
New Castle, DE 19720
302 • 322 • 2226

WOODWORKERS HARDWARE

WHOLESALE ORDER FORM

Pt. No. Price Pt. No. Price Pt. No. Price

<p>WOOD WHEELS</p> <p>W07500 3/4" \$3.50/100 W08700 7/8" \$4.70/100 W10000 1" \$6.00/100 W12500 1 1/4" \$8.00/100 W15000 1 1/2" \$11.00/100 W17500 1 3/4" \$15.60/100 W20000 2" \$19.50/100 W22520 2 1/4" \$7.30/20 W25020 2 1/2" \$8.80/20 W27520 2 3/4" \$10.20/20</p> <p>WHEEL PEGS</p> <p>AP1 fits 1"-2" \$4.10/100 AP5 fits 2 1/4"-2 3/4" \$1.98/20</p> <p>4" PLASTIC SPOKE WHEEL</p> <p>1741 \$.90/ea LITTLE PEOPLE 2-3/8" Birch LP3 Men \$2.46/10 LP4 Women \$2.46/10</p> <p>TOY CARGO</p> <p>433 Pickle Barrel \$2.31/10 434 Oil Drum \$2.31/10 435 Milk Can \$2.15/10</p> <p>JIGGLE EYES</p> <p>88060 1/4" \$1.40/100 88010 3/8" \$1.70/100 88120 1/2" \$2.10/100 88200 4/5" \$4.35/100</p> <p>BIRCH PEGS</p> <p>MGP1 \$.27/ea. 3-3/8" \$25.00/100 SKP1 3/2" \$26.00/100 1770 \$.18/ea. 3-3/8" \$13.00/100 1771 \$.17/ea. 2 1/2" \$14.40/100</p> <p>MINI PEG</p> <p>SKP1M \$.11/ea. 1 3/4" \$7.60/100 SKP2 \$.30/ea. Oak 3 1/2" \$28.00/100</p> <p>BIRCH SPINDLES</p> <p>S6 5/4" \$.42/ea. S85 9" \$.72/ea. S110 11" \$.17/ea.</p> <p>GALLEY SPINDLES</p> <p>S1 Birch \$.10/ea. S10ak \$.12/ea. S1 1 1/8" \$.17/ea. S4 1 1/2" \$.17/ea. S40ak \$.24/ea.</p> <p>DOWEL PIN</p> <p>Birch 1142 \$1.90/100 1/4" x 2" \$8.75/500 1382 \$2.00/100 3/8" x 2" \$9.25/500</p> <p>GAME PEGS</p> <p>316N \$1.10/100 \$9.95/1000</p>	<p>SCREW HOLE BUTTONS</p> <p>1432 3/8" \$1.76/100 Birch \$7.50/500 1434 1/2" \$1.76/100 Birch \$8.00/500 1452 3/8" \$3.70/100 Oak \$15.50/500 1454 1/2" \$3.80/100 Oak \$16.00/500</p> <p>WOOD CANDLE CC1</p> <p>BIRCH CUP \$.31/ea. 1 1/2" \$18.00/100</p> <p>BRASS PLATED 718</p> <p>CANDLE CUP \$18.00/100 1-13/16"</p> <p>BRASS B78</p> <p>EAGLES 2" \$2.16/10</p> <p>CLOCK MOVEMENT W/HANDS</p> <p>Q-82 1-4 \$6.48/ea. 5-9 \$5.10/ea. 10-24 \$4.55/ea. 25+ \$3.95/ea.</p> <p>CLOCK DIAL 1772</p> <p>PLASTIC 5" \$1.80/ea.</p> <p>CORD SETS</p> <p>CS6 6" \$1.00/ea. CS8 8" \$1.10/ea.</p> <p>PUSH-THRU LAMP SOCKET 940</p> <p>\$1.49/ea.</p> <p>LAZY SUSAN BEARINGS</p> <p>LC3 3" \$.69/ea. LC4 4" \$1.00/ea. LC6 6" \$2.05/ea. 12C 12" \$5.99/ea.</p> <p>CLIPBOARD CLIPS</p> <p>L5 3" \$.55/ea. ST6 6" \$.75/ea.</p> <p>MAGNETIC STRIP 120A 120"x1/2"</p> <p>\$4.40/Roll</p> <p>CORK SHEETS</p> <p>C31 8 1/2"x11" \$.60/ea.</p> <p>PLASTIC GLASS</p> <p>357 5"x7" \$.35/ea. 380 8"x10" \$.65/ea. 314 11"x14" \$1.20/ea.</p> <p>SHELF PINS</p> <p>517 \$5.40/100</p> <p>RING HANGER 1612</p> <p>\$2.15/10 \$19.20/100</p> <p>BRASS PLATED PICTURE HANGER S23</p> <p>\$4.70/100</p> <p>TRIANGLE HANGERS</p> <p>6290 1/2" \$3.25/100 6291 3/4" \$3.45/100 6292 1" \$4.55/100</p>	<p>SAW TOOTH PICTURE HANGERS</p> <p>S59 1-5/8" \$4.17/100 S60 2 1/4" \$4.50/100 406 Self Fastening \$4.77/100</p> <p>PRONG HANGER 6288</p> <p>\$2.75/100</p> <p>SOLID BRASS CUP HOOKS</p> <p>812 1/2" \$6.70/100 858 5/8" \$7.60/100 834 3/4" \$8.60/100 835 7/8" \$8.70/100 836 1" \$10.60/100</p> <p>6" BRASS & PORCELAIN HOOKS</p> <p>6417 Three Prong \$5.85/ea. 6416 Two Prong \$2.97/ea.</p> <p>BLACK HAMMER HINGE W/SCREWS 1730</p> <p>\$1.62/2 \$7.17/10</p> <p>BRASS PLATED HINGES</p> <p>910 1" \$1.30/10 928 1 1/2" \$2.25/10</p> <p>Screws for Above F124</p> <p>\$2.40/100</p> <p>PRODUCTION SCREWS</p> <p>6277 1 1/4"x #6 \$1.70/100 6278 1-5/8"x #6 \$1.90/100 6279 2"x #6 \$2.50/100 6282 3"x #8 \$4.75/100</p> <p>CARPENTERS GLUE E705</p> <p>\$11.37/Gal.</p> <p>SAND PAPER SHEETS 9"x11"</p> <p>81220 220gr. \$16.75/100 81150 150gr. \$16.80/100 81120 120gr. \$16.90/100 81100 100gr. \$17.20/100 81080 80gr. \$11.50/50 81060 60gr. \$11.60/50 81050 50gr. \$11.70/50 81234 Assort. \$16.50/70</p>
---	---	---

YESTERDAY'S TOOLS

Print this article

THE STANLEY NO. 45

Workhorse of a Simpler Era

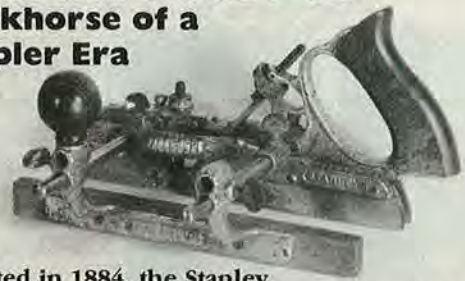

Patented in 1884, the Stanley no. 45 was a multipurpose plow and beading plane.

Like most woodworkers, you no doubt have at one time or another admired a fine piece of furniture from the past. If you've ever come across an antique table that had multiple reeds running lengthwise down its legs, you know that no lathe or electric-powered router created them. But what did?

It's highly likely the talented tool that made those reeds was the Stanley no. 45, a hand-powered workhorse from the Industrial Revolution era. This tool is the earliest example of the refined workmanship that makes combination planes admired, collected, and used, even today.

The king of all-purpose metal planes

In that bygone era there was considerable interest in metal planes. The first ones, from Leonard Bailey, made their appearance in 1867. Over the next 25 or 30 years other metal planes — combination planes and multiplanes — made their way into woodworkers' hands. With the patenting of the Stanley no. 45 in 1884, however, the king of all-purpose planes had arrived.

Looking at the Stanley no. 45, you wonder as much about the tool itself as the work it could produce. It's a complex array of screws, wing nuts, rods, and accessories.

You can fit the Stanley no. 45 with as many as 40 different blades or cutters, and use it to plow, rabbet, dado, make beads, tongues and grooves, sashes, hollows, rounds, and moldings — all with equal ease and precision. Combining the cutters for various effects makes your imagination the only limit.

This plane's reputation for precision proves to be well-earned, too. The screw adjustment for advancing the cutter is so precise that it beats the adjustments on today's bench planes for refinement.

An investment in craftsmanship

You can buy modern descendants of the Stanley no. 45, though current reproductions lack the original's nostalgic appeal. Whether antiques — which are relatively easy to find — or reproductions, one of these planes will cost you about \$175. You really have to enjoy the slower pace of a past era to use one. But to many woodworkers, that's the charm.

Photograph: David Donnelly

ORDER TOLL FREE 1-800-441-9870 MN 1-612-472-5544
 7 AM - 6 PM Central

Send \$1.00 for Catalog or \$5.00 for Catalog plus Best Selling plan package (\$10.00 value) or order directly from this ad by phone or mail. HOW TO ORDER: State quantity, part number, item, price, and total of order. Send check, money order, or Visa or M.C. number and Exp. date. Shipping: \$25.00 to \$49.99 add \$3.50, \$50.00 to \$99.99 add \$4.50, Over \$100.00 add \$5.00. MN. Res. add 6% tax. Minimum order \$25.00.

Please send me: Catalog \$1.00 Catalog and Plan Package \$5.00

Print Name _____ Phone # () _____

Address _____

City _____ State _____ Zip _____

MEISEL HARDWARE SPECIALTIES

Box 258 W12
 Mound, MN 55364

VIKING

SOLID WOOD CLOCK KITS
FAMOUS FOR QUALITY THE WORLD OVER

Holiday
SALE



21 1/4 x 13 1/4 x 5 1/2 inches
7 lbs.

Eli Terry **Save \$20**

SOLID WOOD KIT WITH MOVEMENT

This museum quality replica has modern quartz pendulum movement. Case is easy to assemble. Glass has beautiful ornate design of gold, black & red. Includes: Solid wood parts, silk screened glass, solid brass hardware, quartz movement and pendulum.

Regular price \$149

COMPLETE KIT SALE \$129

The Odyssey

SOLID CHERRY WOOD KIT WITH MOVEMENT

Save \$105
OFF JEWELRY STORE PRICE

Our most beautiful mantel clock. Pennsylvania cherry wood parts, heavy beveled glass for front & sides, mirror back. Contains only 6 wood parts for easy assembly. West German quartz movement with working moving moon dial. Runs for 400 days on a single "AA" battery.

Compare at \$224.

COMPLETE KIT SALE \$119



11 1/2 x 9 x 6 inches
8 lbs.

PLACE YOUR ORDERS TOLL FREE 1-800-321-1089

ALL MAJOR CREDIT CARDS ACCEPTED. Want to receive our FREE color catalog mailings? Send name & address to:

VIKING CLOCK CO.
Box 490, Dept. WD106, Foley, AL 36536

Incredible Savings on Top Quality Products that Work for YOU!

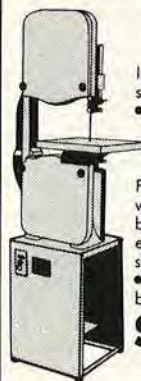

2 Speed 14" Band Saw

Ideal for straight cutting & cutting intricate shapes. Cuts wood up to 6 1/4" H x 13 1/4" W. • Dependable, 3/4 HP motor. • Cast iron, 14" x 14" table tilts up to 45° rt. & 10° left for bevel cuts. • 3/4" x 3/4" groove in table for miter gauge (incl.). • Two speeds: 750 FPM & 2967 FPM. • Capacitor start motor with push button start. • Lubricated ball bearings. • Calibrated scale and pointer for easy-to-set angles. • Blade guide bracket assembly is adjustable for movement control. • 20" L x 25" W x 65" H. • Wt.: 190 lbs. • 93" blade included. **Compare at \$799.00**

\$279 Order No. C8240-3139 Shipped Frt. Collect



10" Contractor's Saw

Built for professional & home workshop applications. Makes wood cuts 3 1/4" at 90° or 2-3/16" at 45°. 1 1/2 HP high torque motor for sure power - 3400 RPM. Heavy cast iron table measures 23 1/4" x 15". 15" aluminum extension wings extend table to 30".

Features: • Aluminum extension wings are die cast. • Dado insert plate included. • Self-aligning positive grip, rip fence included. • Miter gauge included. • Steel blade guard has viewing hole. • Uses 10" blade (not incl.). • 190 lbs.

\$248 Compare at \$599.00 Order No. C8240-2347 Shipped Frt. Collect



12 gallon capacity Wet/Dry Vacuum

Remove anything from workshop floors... sawdust, dirt, even water! Big 12 gallon capacity for dry dirt or 7 1/2 gallon for liquid. Strong, high impact polystyrene never rusts or dents. Powerful 1 HP range with by-pass motor. Ball/sleeve bearings. Easy movement on 5 large casters. 1 year guarantee from manufacturer. **Includes:** 1 1/4" x 6 ft. flexible hose, bent wand, 2 extension wands, carpet tool, squeegee plate, upholstery nozzle, crevice tool, 1 wet & 5 dry filters.

Order No. C8240-5030 Shipping & Handling: \$8.00

49⁹⁹

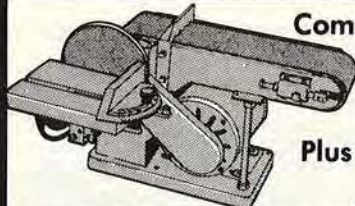

Combination Sander

4" Belt Plus 6" Disc!

Sturdily Built! Gives professional results! • Rough and smooth sands. • 4" x 36" belt. • 6" disc. • 5" x 8" table. • 1/3 HP motor. • Table tilts 0° - 45° and is interchangeable for belt or disc use. • Adjustable belt tension. • Weight: 44 lbs.

\$75 Compare at \$129.00 Order No. C8240-2693 Shipping & Handling: \$15.00

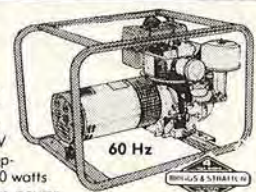

Electric Start 6000 Watt Generator

Never be without electrical power again! • 8 HP Briggs & Stratton engine with electric start. • 1-120V duplex & 1-240V duplex receptacles, 36.7/18.3 amps. • 6000 watts surge, 4400 watts continuous power. • 29 1/2" L x 20 3/4" W x 19 1/2" H. • Wt.: 138 lbs. • 1 yr. FREE parts replacement warranty!

\$499 Compare at \$1200.00 Order No. C8240-1034 Shipped Frt. Collect
2500 Watt Generator..... \$368
Electric Start 8000 Watt Generator..... \$999

TO PLACE AN ORDER please type or print clearly (on sheet of clean paper) the name & order number of the item along with your name & address. Enclose a check or money order payable to **Wholesale America, Inc.** (be sure to add ship./hand. charges). You can also charge to MasterCard or VISA. Print the acct. no. & expiration date and sign your name. Allow at least 7 days for UPS delivery. Add 2-3 wks. for clearing of personal checks and/or freight collect items.

Send your orders to:

Wholesale America, INC.

4777 Menard Drive, Eau Claire, WI 54703

For credit card orders or more information call:

MasterCard 1-715-874-5000
-or-
VISA 1-800-826-3403

Send \$1.00 for the latest Money-Saving Catalog from Wholesale America!

Includes Power Tools, Hardware & Housewares at unbelievably LOW, LOW Prices!

10 DAY NO HASSLE GUARANTEE
If you're not completely satisfied with your purchase, return it (prepaid) within 10 days for a FULL CASH REFUND (less shipping & handling). Returned product must be in original box and original condition.

FREE!

**Stainless Steel
Pocket Knife**
when you order
3 or more items

ONLY \$9.95 EACH...

Set of 3

**Flush
Mounting
BENCH STOPS**

Easy to install, easy to use. Just raise the jaw and press your workpiece against the teeth. Especially useful when positioned opposite a shoulder vise with built-in "dog". #300-0004

**Our
Indispensable
HONING
GUIDE**

Maintains the proper angle for accurately honing any chisel or plane blade up to 3" wide. Complete instructions included. #103-0140



Chamfering JOINTER PLANE

Built-in angles on either side of the 3/4" sole will put a 30° or 60° angle on any edge, accurately joint 3/4" boards. Uses readily available, replaceable breakaway blades (10 extras included). #109-0410

**LIMITED
QUANTITY**

**25
Reciprocating
SAW BLADES**

25 assorted blades with 1/2" shanks, for cutting wood, plastics, metal. Made by Stanley to fit all reciprocating saws except WEN. Save 50% to 80% off regular retail. **LESS THAN 40¢ A BLADE!** #117-1960

**Self-
Centering**

HINGE & BUTT DRILLS

For perfectly centered holes for hinges. 1/4" shanks. Set of 2, for #6, #8, #9 and #10 screws. #200-2601

Set of 3

HALF ROUND WOOD RASPS

1 each Smooth, Medium and Coarse cut. An extraordinary value from China. #106-0124

**CUT 1/3!
10" Blade
DRAWKNIFE**

Has a heavy straight blade for continuous use. Comfortable maple handles with steel caps and ferrules. Our regular \$14.95. #109-0120

**Set of 3
INDESTRUCTIBLE
PHILLIPS
SCREWDRIVERS**

Companions to the 4 piece set. 6", 8" and 10" overall. #1, #2, #3 Phillips. #102-0045



**45 Assorted
1/4" SHANK SABRE SAW BLADES**

For cutting wood, metal, plastic. 60 assorted first quality blades, made in Switzerland and the U.S. Fit all popular sabre and jig saws. #117-1999

LIMITED QUANTITY

**SAVE
\$3.00!**



Magnet

BRAD DRIVING PLIERS

Set brads into picture frames and moldings up to 3 5/8" wide, 1 3/4" deep. Cushioned slide prevents marring. #106-0010

PAIR FORGED PLIERS

British made: Comfort Grips 6" heavy duty Diagonal Cutter 8" Lineman's #117-2056

Set of 2

**SCREW
HOLDING
SCREWDRIVERS**

Reach where your hand can't. 7 3/4" aluminum shaft has a magnet on one end, a spring loaded screw holder on the other. For all Phillips and slotted screws. #300-0015

**Set of 4
INDESTRUCTIBLE
SCREWDRIVERS**



The blade and handle are a single forging, with a smooth, oval shaped hardwood grip riveted to each side of the handle for comfort. So tough you can hammer them like cold chisels. Set of 4: 6", 8", 10" and 12" long overall. #102-0049

SAVE UP TO 50%! MINIMUM ORDER: TWO ITEMS



SAVE 1/3!

22 Piece PILOT DRILL SET

21 bits, to countersink, counterbore screws sizes 4 to 14. A depth stop is included so you can prevent countersinking if preferred on all but the smallest bits. Less than 70¢ a bit! You get bits for:

- #4 & #5 screws 1/2", 5/8", 3/4", 1" long
- #6 & #7 screws 5/8", 3/4", 1", 1 1/4" long
- #8 & #9 screws 3/4", 1", 1 1/4", 1 1/2", 2" long
- #10 screws 1", 1 1/4", 1 1/2", 2" long
- #12 & #14 screws 1", 1 1/4", 1 1/2", 2" long

#200-0125



RATCHET TAP WRENCH

All inner mechanisms, ratchet and chuck are correctly heat treated and tempered. Chrome plated. Two jaw. Capacity 1/8" - 3/8". #300-0025

FACTORY OVERRUN!



6-Piece FILE SET

Made to sell for far more. 10" Double Ended Saw File, 8" Cross Cut File (wedge shape, round back), 8" Mill Bastard File with 2 round edges, 7" X-Slim Taper, 8" x 3/16" Fine Cut Parallel Round File and a 4-in-1 10" Shoe Rasp (combination file and rasp). #117-1160



FREE! 7 Stop Collars 14-PIECE DRILL & COLLAR SET

You get 7 drills, 7 stop collars for the price of the drills alone. Brad point bits for straight, accurate holes in wood with no skipping, no skating, no dancing. 1/8", 3/16", 1/4", 5/16", 3/8", 7/16" and 1/2" sizes. #200-0060



Pair Black and Decker 6" WIRE WHEELS

Double thick; 1/2" bores; Coarse and fine. Industrial quality. #117-0799



MADE TO SELL FOR \$50!

Lightweight, Unbreakable 4" LOCKJAW VISE

Made of a virtually unbreakable space age alloy, with a patented, rear tilt jaw for holding irregularly shaped work. Specially configured 4" magnesium jaws. 3" jaw opening. #300-0745

LIMITED QUANTITY



Set of 6 DENTAL INSTRUMENTS

First quality, stainless steel instruments. For modeling, probing, sculpturing and other delicate work. #106-0007

MINIMUM ORDER: TWO ITEMS

SATISFACTION GUARANTEED!



The Fine Tool Shops, Inc., Dept. WMD6
20 Backus Avenue, P.O. Box 1262, Danbury, CT 06813

Ship to _____

Address _____

City _____ State _____ Zip _____

I've ordered three or more items. Include my FREE Stainless Steel Pocket Knife.

Fill in names, quantities and product numbers of items you are ordering.

Qty.	Item	Prod. #	Price ea.	Total
1	Stainless Steel Pocket Knife			FREE! when you order 3 items or more
Subtotal				
Shipping/Handling				\$ 3.50
CT 7 1/2% Sales Tax				
TOTAL ENCLOSED				

CALL TOLL FREE
1-800-243-1037

In Connecticut
797-0772



Send your Full Color Tool Catalog - **FREE!**

Check Enclosed
 Charge my Amer Express
 VISA MasterCard
Account # _____
Exp. Date _____

THIS YEAR CHRISTMAS ENDS ON DEC.15.

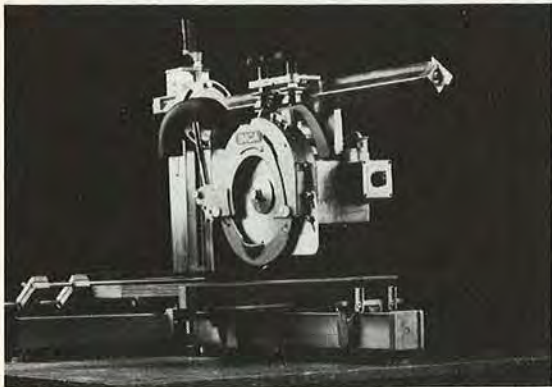

Inca's revolutionary 9" Radial Arm Saw. Uniquely precise and completely portable. Crosscuts 28" at 90° and 18" at 45° (using optional Extension Set). Optional Stand. Reg. Price \$595.00.

precision of Inca, just imagine the quality-crafted gifts you could make this year. And for years to come.

But there's not much time to get these two gifts for yourself. For the name of the Inca dealer nearest you, call 1-800-221-2942. Ask for our free color brochure fully describing all the remarkable Inca stationary power tools.

And when you visit your Inca dealer, be sure to bring a very large stocking.

You only have till December 15th to save an extraordinary amount of money on two extraordinary Inca stationary power tools.

Save a hefty \$97.00 on our Model 810 9" Radial Arm Saw on sale for \$498.00. And save a whopping \$197.00 on our Model 340 10½" Bandsaw which we are also giving away for \$498.00. Both feature our 5-year limited warranty, and over 50 years of experience.

With the Swiss

Inca's famous 10½" Bandsaw. Blade capacity ½" (with optional Scroll Guides) to ½." Resaws 6" thick. Built-in motor. Optional stand. Reg. Price \$695.00.

INCA

Injecta Machinery Corp., 10 Vandam St., New York, NY 10013

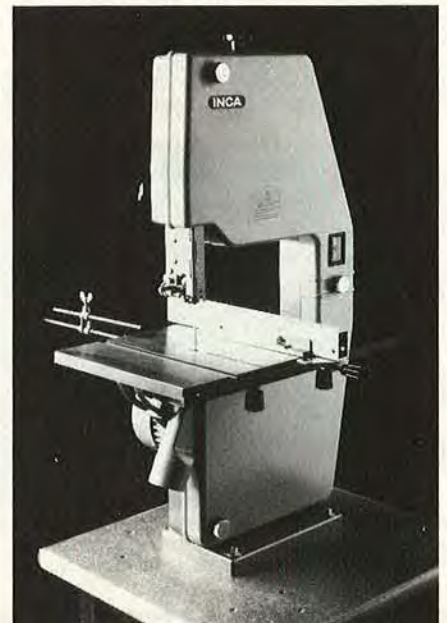

Traditionally, decking the halls with boughs of holly marked the beginning of yuletide. The ancient Romans probably started this tradition — they used holly to decorate for *Saturnalia*, their celebration of the winter solstice. Today, the gathering of holly's thick, green, spiky leaves with bright red berries has become a seasonal industry along our southeastern seaboard.

Holly's connotation was not always joyful, however. Before there were laws to prevent such practices, purveyors of live songbirds as pets caught their pretty prey with the help of the holly tree. They mashed its bark to obtain a sticky, glue-like substance called birdlime, which was spread on tree branches. When the precious songsters alighted, they became stuck and were easily captured for market.

More favorably, holly leaves and berries have been touted in folklore as a cure for smallpox, a speedy mender of broken bones, and an all-around lucky charm.

The wood has quite a reputation. As the whitest wood known, holly provides inlay for expensive furniture, the bodies of fine brushes, and even imitation ivory piano keys.

Wood identification

You can find 175 species of holly growing practically around the world, with the largest number in Brazil and Guiana. Thirteen species grow in the U.S. alone, but commercial loggers har-

HOLLY

the snow-white wood of winter



Holly heartwood

vest only the largest of these, *Ilex opaca*.

In a range that extends south from Massachusetts to Florida and west to the Missouri River, holly varies in size from a bush to a tree of 50' or more in height. Northern winters keep holly small, but it thrives in Arkansas and east Texas. There, holly trees develop a dense, pyramidal shape with many short, horizontal branches. The broad, leatherlike leaves feature sharp prickles — nature's way of fending off animal browsers. By midwinter, red or yellow berries develop on female trees where blossoms

once brightly flowered.

The bark of holly tends to be patternless, rough-textured, and medium gray, often with a tinge of olive. Older trees feature wartlike outgrowths.

Weighing in at about 36 lbs. per cubic foot dry, holly rates as moderately heavy and hard, but not strong. With indistinct, fine grain, the wood of holly displays no figure.

Color ranges from an almost pure white sapwood to heartwood with a creamy tone, and the two can be indistinguishable. To prevent a permanent discoloration called "blue stain," loggers cut holly only in the winter months, then process it quickly.

Working properties

Holly's hardness makes it difficult to work with hand tools. It does glue easily, however, and it resists splitting from screws and nails if you use pilot holes. Due to holly's extremely fine grain, it sands to ultimate smoothness.

Holly also accepts stain admirably — so much so that it was once called "dye wood."

Uses in woodworking

You won't find many projects made entirely of holly, but it does make a striking accent when combined with darker woods. In marquetry, holly contributes its natural whiteness, or it can be colored as needed.

Because of its unusually tight grain, holly often becomes the choice of carvers and woodblock engravers. It also turns exceptionally well.

Cost and availability

Holly grows singly rather than in stands, and loggers harvest it along with other hardwoods. In the South, for example, where it reaches a large size, holly can be found mixed in and sold with soft maple, and you might have to find your holly by sorting through a soft-maple pile. Otherwise, holly normally will be available from dealers specializing in hardwoods. You can buy holly veneers from marquetry supply houses. If you live far from its source, holly can cost as much as \$5 per board foot. 🌲

Photographs: Hopkins Associates
Illustration: Steve Schindler

CABINETS BY HARGIS

Print this article



Clarence Hargis, 82, his son, Melvin, 54, and Melvin's son, David, 25, all pictured *right*, cherish old tools as much as cabinetmaking. In fact, we first met the Hargises at a Mid-West Tool Collectors show. That's when they invited us down to Seminole, Oklahoma, for a visit. What we found, besides a collector's treasure in old tools, was a reputation for quality that goes back over 60 years!

Clarence was born in Paul's Valley, Indian Territory, in 1905. His cabinetmaker father taught him the trade, which at times, even included building coffins. Melvin, the only one of six Hargis children to follow the craft, grew up in the shop. David began at 8 years old, sweeping sawdust. They work side by side daily, practicing skills passed down through generations with pride.



IN OKLAHOMA, FOLKS WHO WANT QUALITY IN THEIR KITCHEN CALL ON A HARGIS HERITAGE – FOUR GENERATIONS STRONG

Seminole, Oklahoma, once boomed with oil, and paychecks filled pockets as fast as drilling rigs filled barrels. If a man set his mind to it, he could make a good life there. He started a family, built a home, and put down roots. When the roots were deep enough, and the finances sound enough, the family bought custom kitchen cabinets by Hargis.

Little has changed today in Seminole. Oil is not as big as it once was, but folks from town and the county, from Tulsa and Oklahoma City, and sometimes even from other states still want Hargis cabinets. That's because down in their shop on West Strothers Street, Clarence, Melvin, and David keep building cabinets the way they've always been built.

The making of a reputation

Clarence's dad bought the present shop in 1924 from an oil company. With a little remodeling, the former theater and dance hall offered

plenty of room for cabinets.

Under his dad's guidance, Clarence learned to make cabinets the Hargis way: mortise-and-tenon joints in the carcass and door frames; frame-and-panel hardwood doors that match front and back; drawer fronts, sides, and bottoms dadoed and joined for strength; and backs as strong and sound as fronts. They took no shortcuts then, and they don't now.

"I used to make tenons for the joints with a handsaw just like that Disston on the wall," recalls Clarence. "For mortises, I had to use a chisel, first cutting into the wood from one way till I was about half done, then turning it around and going at it from the other way. That's because no one can chisel straight down — you always pull toward you and turning it around evens it out."

By hand, it took Clarence and his dad three weeks to make an 8' bank of cabinets. With power equipment, the Hargises can make 8' in a day.

Left: Clear-finished, solid walnut cabinets with raised panel doors carry the "wrinkle" molding at the soffit that marks them as made by Hargis.

Below: The Hargises like to work with "fresh" lumber, so they buy it rough and plane it as needed. Melvin can adjust the speed of their 40-year-old Crescent planer.

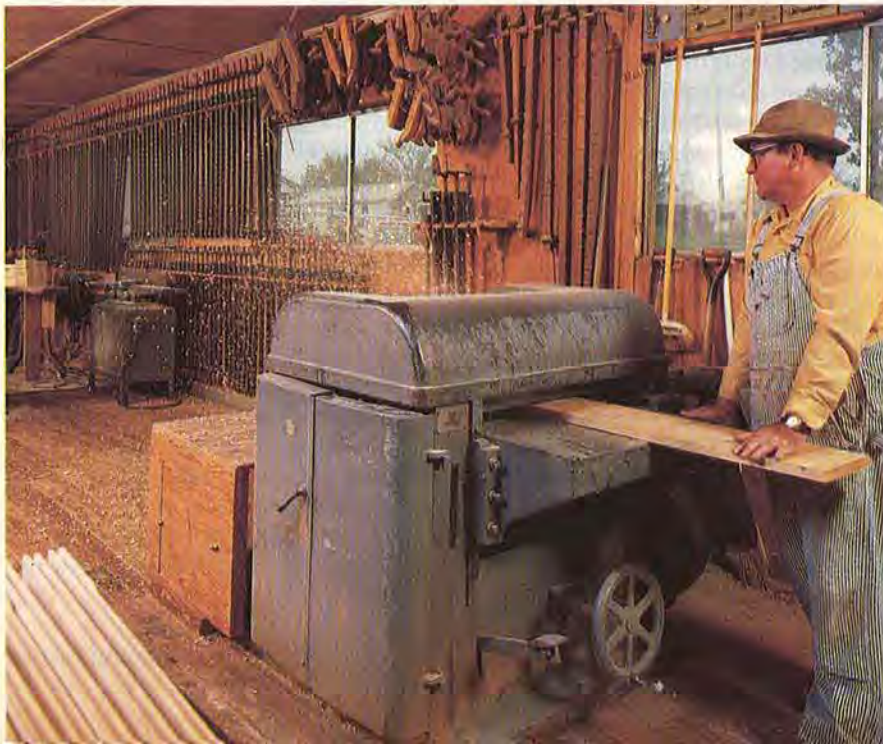

From planning to hanging, count on Hargis

From the time a customer calls, the Hargises practically become family. "We try to work with them and their budget," says Melvin, who fields most calls and does what paperwork there is to do. "We can go from flat, hardwood-plywood doors to edge-joined stock with raised panels — anything they want."

Clarence or Melvin, or both, will drop by their customer's house to draw up their needs. Besides the basics, they'll suggest extra storage here or the convenience of a lazy-Susan there (the Hargises had machinists make rotating shafts with ball bearings before ready-made units were available). The units and their dimensions go down on a storyboard of plywood scrap (never paper) so it won't blow around.

Back at the shop, Clarence lays out the project and runs the panels through the saw. The Hargises never keep stock parts on hand, preferring to use "fresh stuff" — either newly purchased hardwood plywood or lumber from the stockpile they plane themselves.

David bores the mortises on a 50-year-old J.D. Wallace mortising machine, and cuts the tenons on a 1940s Crescent tenoning saw. Melvin saws the dadoes and assembles the carcasses and doors. Then, it's up to David and Melvin to sand the assemblies, while Clarence crafts the Hargis cabinet trademark.

Hargis cabinets have always been topped by a special, rococo molding Clarence makes on the shaper. Many would like to add what the Hargises call their "wrinkle" molding to their cabinets, so as to pass them off as Hargis-built, but the technique is a guarded one. "Somebody once asked me how it was done," remarks Clarence. "I told him to mark off the wrinkles on a stick, then wrap sandpaper around a Coke bottle and sand them off."

Continued

CABINETS BY HARGIS



Clarence now makes tenons by machine. When he worked for his dad, he cut them with a hand saw.

He came back awhile later and told me 'It's pretty, but sure not worth the trouble!'"

There are quite a few versions of the wrinkle design, yet Clarence makes them all the same way. Each design requires its own 1½" shaper knife, ground to shape by Clarence. Using bump-outs on either side of the shaper's throat to force the 1x2" strip in and out against the blade, he slides the wood along the fence to produce the pattern (see photo, *above right*).

The molding completed, the cabinets await hanging. There's no finishing done in the Hargis cabinet shop: "Too much fuss about government regulations," Melvin bemoans.

It's the Hargis tradition, however, to handle the installation, a job that typically takes three days. They won't trust the job to anyone else.

The Hargises set the base cabinets and screw the wall cabinets to studs *before* they hang the doors. "Then, you can adjust them to a wall that's maybe out of plumb or has any bumps in it," young David comments. "When we get done, the doors hang right."

Last of all, the wrinkle trim goes up. And they recommend a finisher if the buyers can't do it themselves. "It should be a natural finish, no stain," advises Clarence. "You can touch up a natural finish with no



Unlike his granddad, David bores mortises on an old, but reliable mortising machine. Clarence once had to do it all with a chisel.

trouble. Clear lacquer is best; some folks like oil. But you've got to get it done soon as possible, so the wood doesn't pick up grease or fingerprints."

Materials change, value doesn't

Back when Clarence's dad was showing him how to make cabinets, they didn't use plywood because it wasn't available. Now, when the price of lumber would overstretch a buyer's budget, they'll work it into cabinets. "We only use lumber-core plywood," cautions Clarence. "The glue in particle-core messes up the tools."

He runs his hand over a nicely colored piece of red oak, and continues: "If we use lumber, we never join pieces more than 4" wide so the panel won't warp." Over the years, cabinets by Hargis have been available in birch, mahogany, maple, elm, cedar, white oak, red oak, cherry, ash, walnut, and pecan. They've even used cottonwood.



Sure hands, a jig, and a sharp shaper blade produce the Hargises' famed wrinkle molding to top the cabinets."

Clarence remembers, too, when all their lumber was air-dried. Today, they buy kiln-dried wood. "Air-dried is better working, but it really doesn't make any difference in the cabinets."

In the old days, the only kind of glue to use was made of animal hide. You can find a dented and dirtied glue pot in the Hargises' shop. "We still heat up some hide crystals for furniture repair and laying veneer," Melvin points out. "But mostly we use urea formaldehyde. It's real permanent."

In Clarence's eye, there have been lots of changes since he started cabinetmaking — in materials, equipment, and regulations. About the only thing that remains constant is the value of Hargis cabinets.

Any real estate agent around Seminole will tell you matter-of-factly that Hargis cabinets are a major selling point, and add \$10,000 to the value of a home, over and above their cost. And some folks have valued their Hargis cabinets so much they wouldn't leave them behind.

"We knew a couple here who we made cabinets for a few years back," explains Clarence as he snuggles his thumbs behind the straps of his bib overalls. "They took them right out of the house and shipped them when they moved to D.C."



CLARENCE'S TOOL COLLECTION

A Labor of Love, a Love of Labor

Clarence's "walk-in" tools blanket his home. On the two shelves above the rolltop desk stand his "White House" planes, which he's preserving for the people of Seminole.

Walls in most homes have pictures breaking up blank expanses. Clarence's living room walls don't have any blank expanses — they're hung with tools, each in its place, from ceiling to floor. Tools also cover the floor, windowsills, and occupy the china cabinet. Ditto for his spare bedroom. Tools, not guests, stay there.

Clarence probably has 1,200 planes in his collection: plain planes and work-of-art planes of ebony, ivory, rosewood, and brass. All in his house. Then there are wooden braces, ancient hammers, and one-of-a-kind tools. Name a tool, and you'll find it at home with Clarence.

Ask him about a specific tool, and you'll hear history. "That takes the bark off like this," he says as he demonstrates with the bark splitter he pulls from the wall. "That was important back in

that day and time."

Clarence doesn't collect tools to show them off or make a profit from them. In fact, Clarence *never* sells his tools.

For him, tool collecting is a labor of love born of a love of labor. No matter what he paid, each tool is inherently valuable because of the work it once performed. Each tool is a monument to the labor of days gone by and the craftsman who used it.

Walk-in tools find a home

As Clarence explains it, "some tools just walked in the door." More than one person has brought him a prize from their attics because they know he cares!

A very special part of his collection "walked in" that way. "One Saturday morning, the fellow called me up and said 'Come get these tools,'" relates Clarence. He'd never met the Oklahoma City man, but as a collector, he'd heard of his set of planes. They had belonged

to the caller's great-great-grandfather, a craftsman who helped rebuild the White House after the War of 1812.

"I told him he had the wrong guy because I didn't have the money to pay him what he'd been offered," Clarence continues. The man went on to say, "The money ain't it. They're yours."

Pressed, Clarence tells more. The man needed a good home for the planes, and he knew Clarence would care for them and keep them together as a set.

Representatives from the Smithsonian museum dropped by to ask Clarence for the tools. He wasn't persuaded. After all, folks in Seminole wouldn't be likely to go by there to see them.

Note: This spring, Clarence intends to pour the foundation for a museum to house all his tools right next to his shop. By winter, there may be a building. Clarence won't charge admission. And his stories are free.

TRADITIONAL WOODWORKING WISDOM FROM HARGIS

● *How to tell when the surface of something you're turning between centers is smooth:*

Lay the steel back side of your turning tool on the spinning wood. It'll ride smooth when the wood is.

● *On keeping veneers from cupping:* Put glue on your substrate, then damp-rag the top side of the veneer before laying it down. Water in the glue swells the bottom; water on top equalizes the moisture so it won't cup.

● *Joining the edges of porous wood:* Apply glue evenly to all edges and let dry. Then, coat with more glue and join. Wood absorbs

the first coat and seals it so coat number two does the "sticking."

● *Preventing cracks in panels:*

Oozing glue from frame corners can get onto panel edges in frame and panel construction so that the panels won't move when they contract or swell. The result: cracks. Rub on paraffin wax along the panel edges first, then they won't join and can move freely.

● *Sawing a straight line with a hand saw:* When the reflection of the board on the side of the saw makes a 90° angle with the saw teeth, you'll be cutting straight.

AND SOME "DO'S" FROM EXPERIENCE

Do always test boards for moisture of recommended 11 percent or below. One project gone awry makes a moisture meter sound real inexpensive.

Do use only garnet sandpaper. *Do* use a good urea-formaldehyde resin glue for cabinets. Heat it like beans — hot but not boiling. Try the Hargis endurance test: after 10 days in a bucket of water, the joint should still hold. ♣

Produced by Peter J. Stephano
with Emily Freeman Pinkston
Photographs: Bob Hawks

FACEPLATE TURNING

AN ENJOYABLE TECHNIQUE THAT OFFERS REWARDS (AND CHALLENGES) AT EVERY TURN

It won't take long; we promise you that! Some people get hooked on faceplate turning the very first time they see a beautifully crafted bowl quickly take shape under the skillful handling of their turning tools. For others, the clincher comes when they experience the thrill of giving a one-of-a-kind project to someone as a gift.

And you know something? We've yet to meet a woodturner who can find enough time to do all the faceplate work he'd like to do. That says something. If you haven't had the pleasure of spending some time with turning tool in hand, you

don't know what you're missing. There's no time like the present to develop this great new habit.

Note: This is the second in our series of technique articles on basic woodturning. Refer to WOOD August, 1985, Issue 6, pages 35-39, for more information on turning between centers. In that same issue, beginning on page 68, we also presented a 5-page article on lathe buyman-ship. And for those of you who need to know more about lathe tools, we've included a three-page article in this issue (pages 58-60).



TOOLS OF THE FACEPLATE TURNING TRADE

No matter what the technique, things always go more smoothly when you have the right tool. And faceplate work is no exception. You could easily spend several hundred dollars laying in all the "right" tools, but we show a set of six in the photo at right, that will get you off to a good start.

You should have three *gouges* — two *spindle gouges* (a $\frac{3}{4}$ " one and a $\frac{1}{2}$ " version) and a *bowl gouge*. The spindle gouges make quick work of rounding down the project as well as shaping the outside of it. The flute of the bowl gouge is much deeper than the relatively shallow spindle gouges. This shape allows you to remove material from the inside of a project without the tool's edges catching and tearing the wood.

You'll also need a *parting tool*, a *round-nose scraper*, and a *skew* in your arsenal. We've found the parting tool quite helpful for truing up the face of blanks, roughing out the inside of end grain projects,

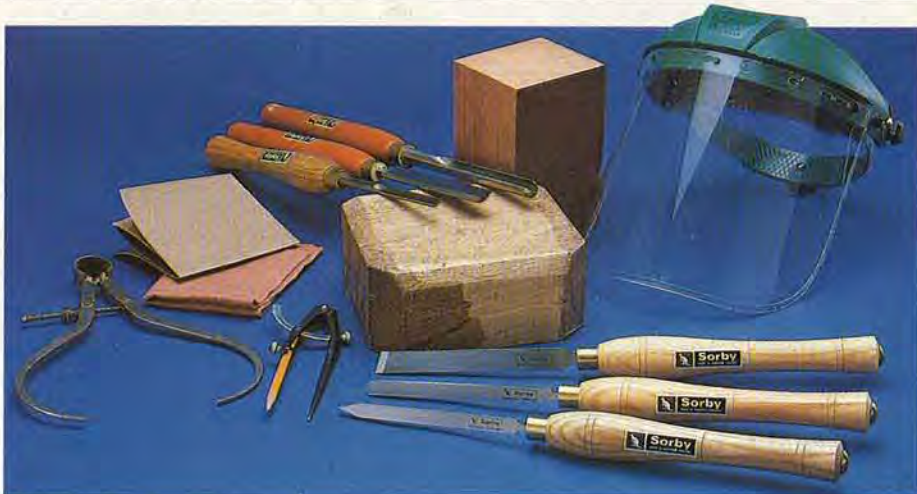

and in its normal role of parting projects from the lathe. The round-nose comes in handy in a variety of situations, and we use the skew primarily for flattening the inside bottom of bowls and other flat-bottomed projects.

With a *compass* you can find the approximate center of a blank and establish the largest diameter of the project. And a pair of *outside calipers* allows you to check on the progress of your turning from time to time.

Sandpaper (80-, 120-, 150-, and 220-grit), a *face shield* to protect against flying shavings and dust, and a *dust mask* and *respirator* (not shown) for use while sanding and applying finishes round out the collection of necessities. Note the felt fabric beneath the sandpaper. We use it between the sandpaper and our fingers while sanding to prevent getting burned by the heat that results from the friction. Felt also allows the sandpaper to "fit" the contours of the turned shape.

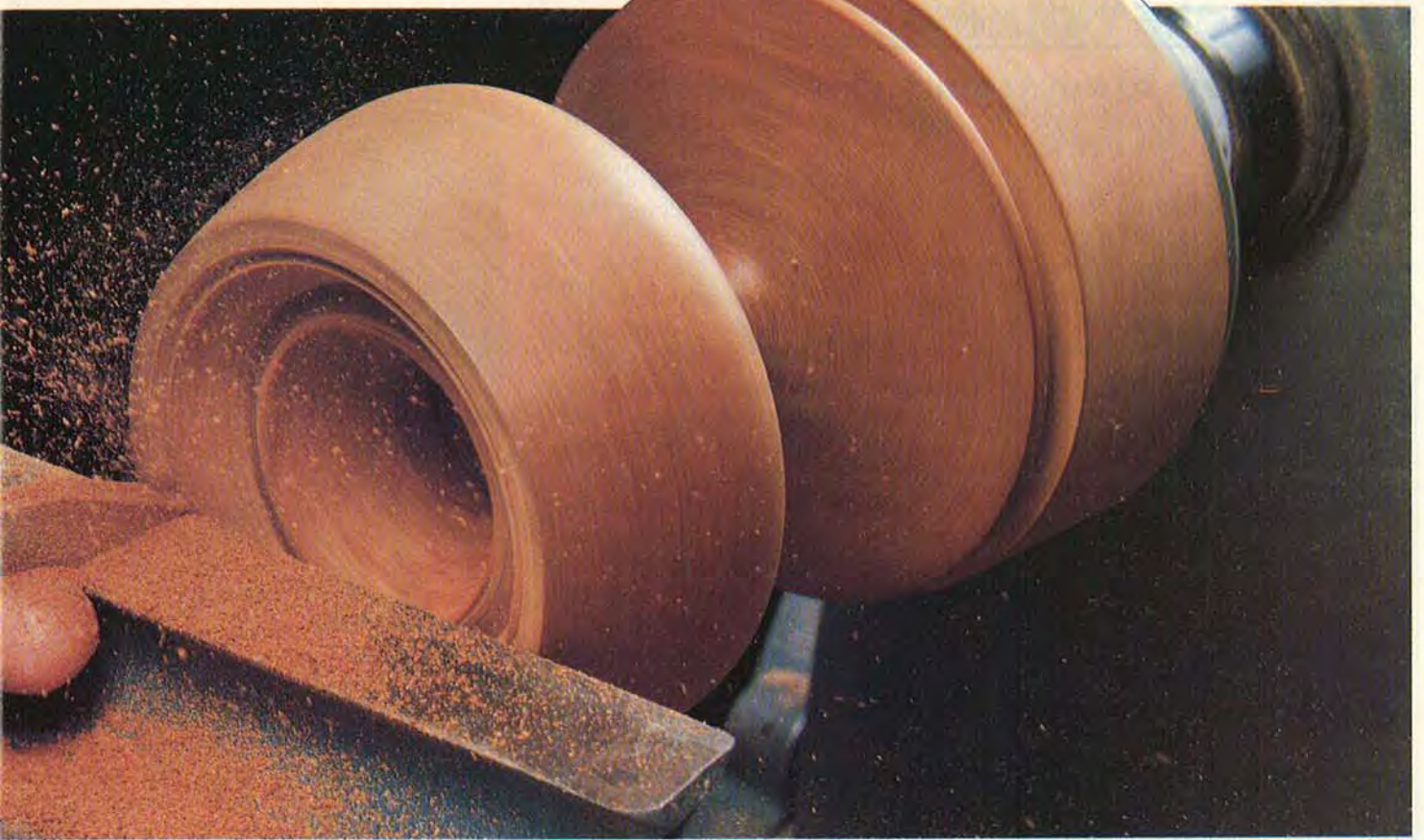

LAYING OUT YOUR PROJECT

Most of us need to visualize the end product before we begin turning to ensure successful results. Here's our four-step strategy for deciding on the shape of the project and then transferring that shape to a template.

Step 1: On a piece of tracing paper, draw a full-sized side view of the turning stock. Then, draw a perpendicular centerline through the side view. Now draw a trial shape on one side of the center line. If you don't like what you see, erase and repeat the procedure until you arrive at a pleasing shape. Allow space on all sides for getting the stock into round.

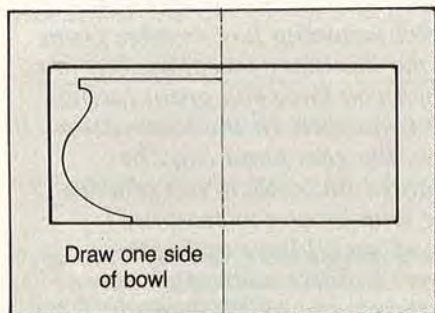

Step 2: Fold the tracing paper on the centerline, and then trace the profile onto the other side of the line. Doing this will yield a symmetrical shape.

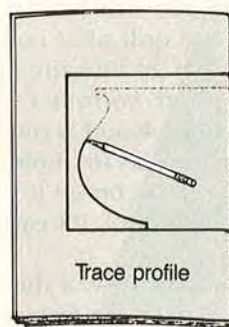

Step 3: Unfold the tracing paper to view your handiwork. (We usually end up repeating the above process several times before we're satisfied.) Select the design that suits you best, then measure and mark the project's diameter at several high and low spots on your design. Doing this allows you to easily check your progress with calipers as you shape the project.

To make your template, glue card stock onto the back side of the tracing paper up to the centerline as shown.

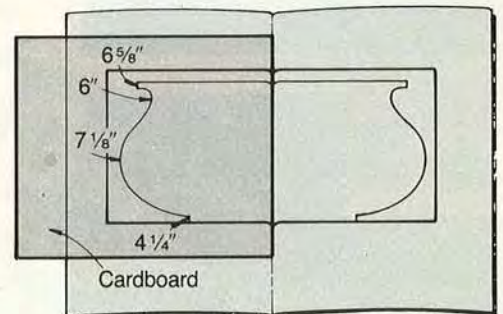

Step 4: Finally, cut away the right-hand portion of the tracing paper pattern and cut out the project's profile.

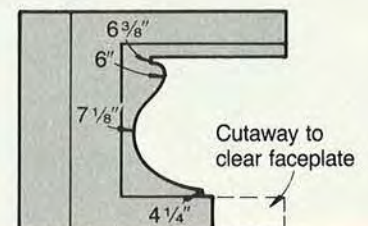

Continued

FACEPLATE TURNING

TWO GOOD WAYS TO MOUNT STOCK ON A LATHE

Rather than confuse you by reciting the many ways to prepare the stock for turning, we've decided to show you two easy options, neither of which requires a commercial chuck. For more information about various chuck options, see our article on page 103.



The Direct Connect Method

To reduce the possibility of the project breaking loose during turning, it's always best to secure the faceplate directly to the stock. Whether you can go this route, though, depends on whether or not there is enough extra material to accommodate the screws that must be driven into the stock.

Assuming that you do have sufficient material, start by finding the center of the blank by drawing diagonals from corner to corner at each end of the stock. Then, mark the largest diameter needed for the project with a compass as shown in the photo *at left, top*.

Now, plane or cut off the excess material at each corner of the blank. Doing this not only speeds the rounding-down process, but also, by removing off-center material, prevents the severe pounding a gouge takes when it repeatedly meets unfaceted corners. Swinging large amounts of off-center material exerts additional pressure on the bearings of your lathe, too. And when the bearings wear, the headstock typically exhibits some movement (or play), making it difficult for you to do quality work.

Center the faceplate over the center point that will face the headstock, and drill pilot holes for the screws that go into the blank see photo *at left, bottom*. (We use 1" flathead brass wood screws as large in diameter as the holes in the faceplate. Why brass? If you hit one with a lathe tool, it's easier on the tool.)

Once you have driven the screws home, you can fasten the blank to the lathe.

The Auxiliary Faceplate Method

When you just don't have enough material to allow you to screw the faceplate directly to the blank, you'll have to fashion an auxiliary faceplate and glue the stock to it. If you're working with a rough bowl blank, first smooth the surface that will contact the faceplate with a

hand plane or a belt sander. This will ensure adequate adhesion between the auxiliary faceplate and the blank.

On the surface that will face the tailstock of the lathe (generally the open end of a project), mark the center point of the blank with a compass and scribe the largest desired diameter. Then, cut away the excess material, using the circumference line as a guide as shown in photo A. Doing this gets rid of most off-center material before you mount the turning.

To make your auxiliary faceplate (it should be a bit larger than the base of the finished turning), start by screwing the faceplate to a plywood or solid-wood scrap. Then, with a scrap of the correct size, scribe the circumference of the auxiliary faceplate as shown in photo B. This automatically centers the faceplate on the auxiliary one.

Cut the excess material from the auxiliary faceplate, then screw the faceplate to the headstock of the lathe. Next, apply glue to the auxiliary faceplate as shown in photo C, and adhere a piece of scrap notebook paper to it. This paper makes separating the finished project from the faceplate a snap.

Apply glue to the paper, move the tailstock up close to the headstock, and with the center point of the blank in contact with the tailstock center, move the blank into contact with the auxiliary faceplate. "Clamp" the stock to the faceplate as shown in photo D. This procedure self-centers the blank, which in turn, decreases off-center weight.

Note: This method works well when fastening face or edge grain to the auxiliary faceplate, but not when you have end grain facing the headstock. In the latter situation, the glue bond can't be counted on. Also, if you're working with green (unseasoned) wood, you'll have to use the direct-connect method or one of the chucks on the market.

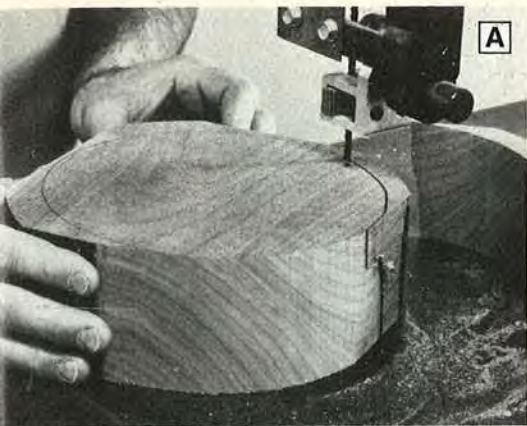

SHAPING THE PROJECT

While no two faceplate turnings ever turn out the same way, they all begin with the rounding-down process. You do this to transform your out-of-round stock to a piece that's concentric to the drive shaft, which takes the stress off the machine. For the same reason, and for safety's sake, we've found it good practice to support the turning at both the head- and tailstock ends until we've completely shaped the outside of the project.

In the photo immediately *below*, we've attempted to point out several things about rounding-down. First, notice the position of the tool rest. You want it as close to the blank as possible without actually touching it. Also note that it's a bit above the center of the project, though this can vary with the

bevel angle of the tool you're using. And finally, take a look at the angle of the cutting edge to the blank. In actual practice, you position the bevel flat against the spinning stock, then raise the heel slightly so the cutting edge can do its job.

After rounding-down the blank, which we do at slow speed (400-600 rpm), true up the face of the project as shown in the photo *at the bottom of the page*. We have had good results attacking the face from the side and pushing straight across the face with a parting tool.

If you've had lots of experience turning projects, you can probably pull out your gouge and begin shaping the outside of the project, only occasionally referring to your template for direction. But we've

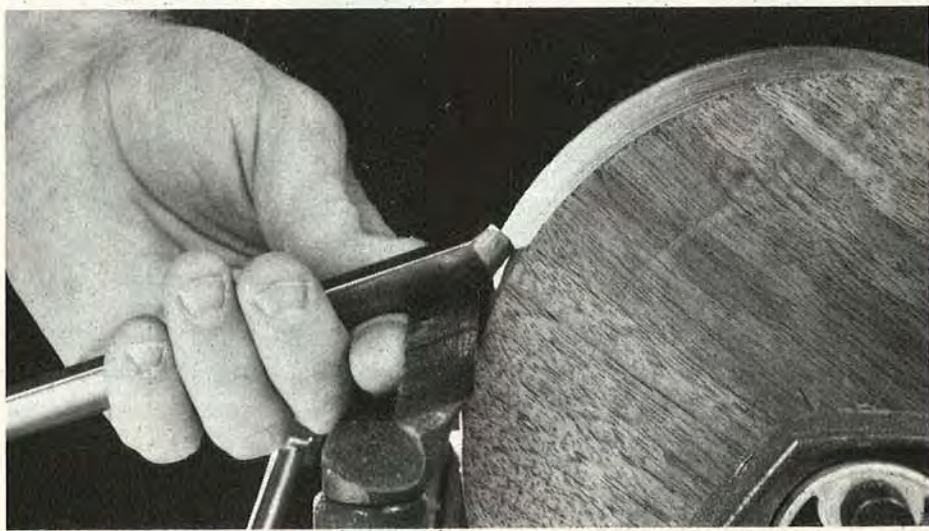

FACEPLATE TURNING

found it helpful to lay the template on the blank as shown in photo A, and transfer the marks on the template to the blank. Then we turn on the lathe (at medium speed 800-1,000 rpm), and use the parting tool to remove material at those points to the desired diameter. You'll want to check your progress occasionally with a pair of outside calipers as shown in photo B. These incisions serve as reference points as you continue to shape the project.

As your project begins to take shape, check it often with the template as shown in photo C. Hold the template perpendicular to the turning, and make marks at all points where the template and the blank make contact. Remove excess material where marked; don't do anything to areas you can see daylight between.

You can do most of the shaping work with the gouges, with some help from the bullnose and the parting tool. When you're satisfied with the outside shape, you may want to sand the project smooth. We go this route because the project still has full support at this point. We sand with a progression of garnet papers — 80-, 120-, 150-, and 220-grit. Be sure to wear a dust mask or respirator while sanding, and keep the paper moving.

Shaping the inside of the project calls for a different set of tools and a few new procedures. Before hollowing out the project on the lathe, we remove the work from the headstock and drill a 1" hole in its center to the approximate depth we want the project's bottom to be. Use a drill-press setup like the one shown in photo D. This hole not only serves as a reference point, but also seems to make the roughing-out process easier.

How you rough out the inside of the project depends on whether it's a face grain project or an end grain one. With the former, we use the deep-fluted bowl gouge as shown in photo E. Notice that we work from the outside toward the center of the project. Note also the

position of the gouge. It starts out on edge (with the toe doing the cutting), then as you work inward, you slowly rotate the gouge to a more horizontal position. It may take a while to get the feel.

With end-grain projects, we rough out with a parting tool, again

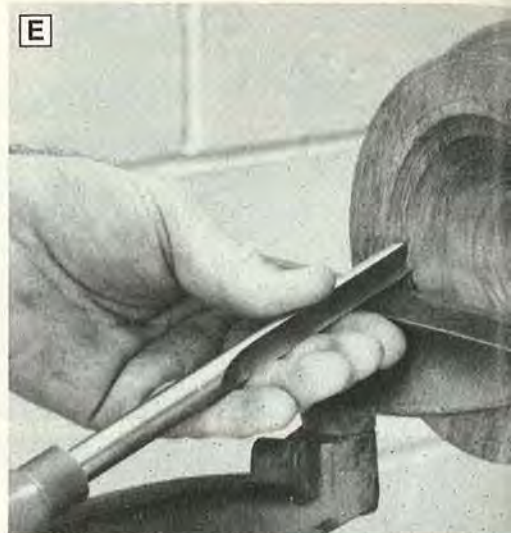
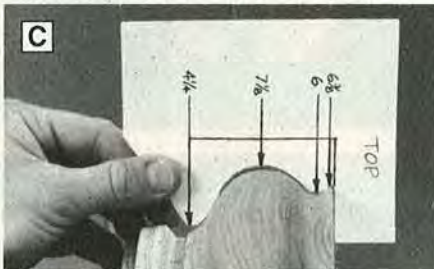
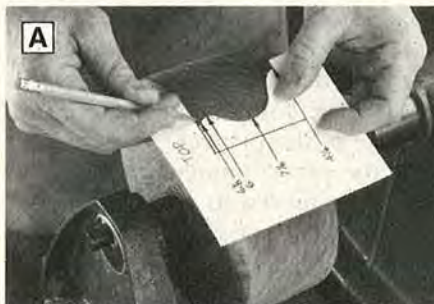

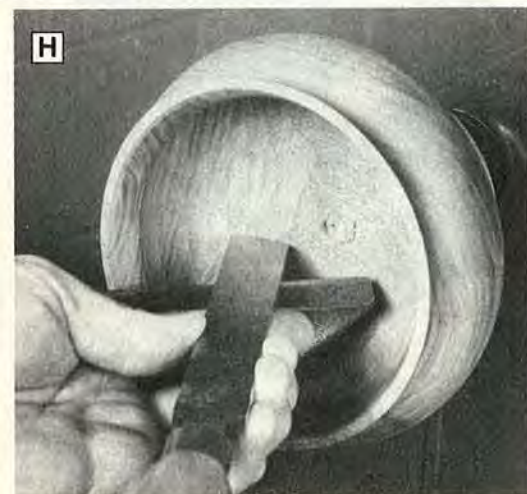

working toward the center hole — see photo F. Note that we're working at a slight angle to the workpiece.

The nearer you get to the outside edge of the project, the greater the tendency for the tool to want to "jump" to the outside. This could require reshaping the lip, so we make starter cuts as shown in photo G with a parting tool. This forms a ledge against which you can start the gouge.

You also can use the parting tool to establish the wall thickness. The wall thickness of bowls, goblets, and other projects should remain constant (we usually shoot for 1/4" as a minimum). Periodically check your progress with the calipers.

To flatten the inside bottom of projects, we go with a skew or a roundnose. We "redesigned" the skew shown in photo H, rounding its cutting profile so that it won't catch the wood at the point where the walls and bottom meet.

Note: As you work the inside of your project, you may find it helpful to have a light source trained on the area being worked. Otherwise, the dust and shavings can quickly obstruct your vision.

FINISHING UP THE PROJECT

One of the things most woodworkers like about lathe work is that they can rough out, shape, and finish a project while it's still on the lathe. We usually spend plenty of time sanding the project inside and out before finishing; when we hurry we regret it.

While sanding the project, you may notice some impossible-to-eradicate rough areas on the surface. If this happens, you may be time and effort ahead if you backtrack and very carefully cut away a bit more material, then resand. A properly sanded surface should almost shine.

When applying the finish, be sure you first protect the lathe bed and all nearby surroundings with newspapers. Otherwise, the spinning object can quickly make a mess of your shop.

In the two photos *below*, we show you how to separate the finished project from the lathe. If you employed the auxiliary faceplate method, first remove the faceplate from the auxiliary one. Then carefully tap a wood chisel, with the beveled edge facing the auxiliary faceplate, into the paper joint line separating the project from the auxiliary faceplate until the bowl falls away. Then, sand the bottom smooth, and finish.



For those projects turned using the direct-connect mounting method, use your parting tool, with the lathe going at low speed (400-600 rpm) to separate the project from the remainder of the stock. Be sure to hold one hand beneath the project so you can catch it when the separation is complete.

If desired, you can sand and finish the bowl's bottom, and maybe carve your initials there, too.

Produced with James R. Downing and James E. Boelling
Written by Larry Clayton
Photographs: Bob Calmer

STACK 'EM UP LAMINATED BOWL



Very often in woodworking, it's the little touches that set apart certain projects from the rest. Here, we laminated squares of African padauk and oak veneer to make this simple bowl, one that will stand out no matter where you display it. For more information about faceplate turning technique, see the previous article.

 Print this article

FORMING THE STACK LAMINATION

1 Cut three pieces of $\frac{3}{4}$ " padauk and two pieces of oak veneer to $7\frac{1}{4} \times 7\frac{1}{4}$ ".

2 Stack the pieces as shown in the drawing at *right* (be sure to alternate the grain of the three padauk pieces). Spread a thin, even coat of glue on all mating surfaces (we used a playing card to spread the glue out). With the edges of the pieces flush, clamp them together with several handscrews. Wait for the glue to dry, and remove the handscrews.

3 Draw diagonals from corner to corner to find its center. Using a compass, mark a $3\frac{5}{8}$ " radius on the lamination, and cut the piece to shape with a band saw, cutting on the *outside* of the marked circle.

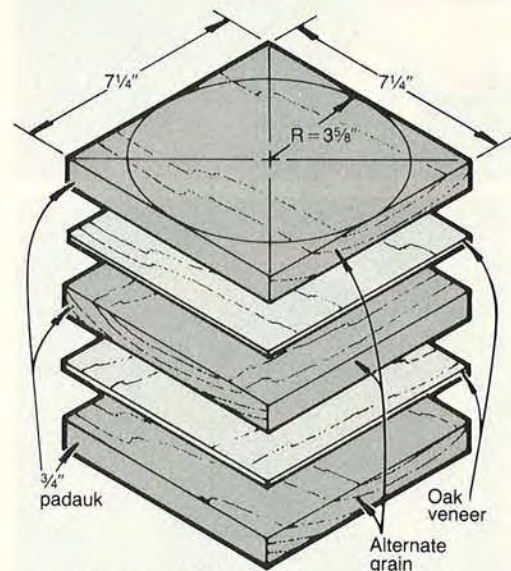

STACK LAMINATION SEQUENCE

FULL-SIZED TEMPLATE

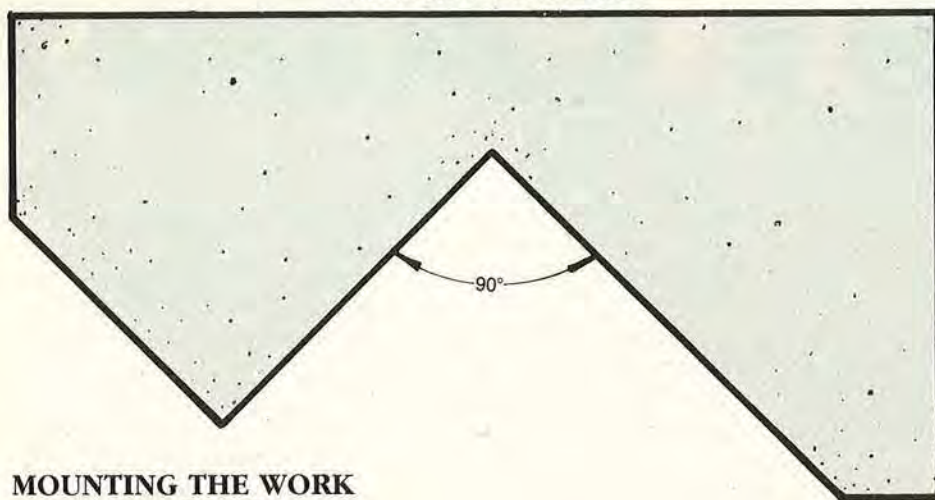

MOUNTING THE WORK ONTO THE LATHE

1 Screw a piece of scrap $\frac{3}{4}$ " plywood that's at least 6" square to your faceplate. Now, using another scrap piece of wood cut to the correct size, scribe the circumference ($4\frac{3}{4}$ ") of the finished bowl base on the headstock side of the plywood (refer to photo B and the description on page 40 of the techniques article for details about how to do this).

2 Unscrew the plywood faceplate from the headstock. Cut around the marked perimeter of the plywood. Mount the faceplate assembly back to your lathe.

3 Spread an even coat of glue on the exposed face of the plywood mounted on the faceplate. Quickly place a piece of paper on it. Now, before the glue sets, spread another even coat of glue on the exposed face of the paper. Position the tailstock center against the marked center on the top face of the lamination. Then, slide the tailstock/lamination firmly against the faceplate assembly. Lock the tailstock to the lathe bed; then tighten the tailstock spindle to "clamp" the lamination against the faceplate. Let the glue dry overnight.

FIRST THE OUTSIDE, THEN THE INSIDE

1 Position the tool rest slightly above center and along the outside edge of the laminated blank. Set the lathe at a slow speed (400-

600 rpm), use a spindle gouge to remove any "out-of-round" stock. Once you round-down the lamination, vibration will decrease and you can speed up to 800-1,000 rpm and reposition the tool rest.

2 Place a piece of carbon paper and a piece of cardboard under the full-sized template drawing accompanying the Side-Section Drawing above. Trace the shape of the template onto the cardboard. Now, cut the template to shape. Shape the outside of the bowl with a skew, stopping periodically to check the shape with the template.

3 To turn the inside, reposition the tool rest across the front of the bowl. Using a bowl gouge, clean out the inside of the bowl, being careful not to make the wall too thin at the top edge. Also make sure you don't cut through the bottom oak veneer layer. (We made extremely shallow cuts when we got close to the oak veneer to ensure that we wouldn't cut through it.)

SANDING AND FINISHING THE BOWL

1 Remove the tool rest, and sand the inside and outside surfaces. (We wrapped sandpaper around a piece of felt and kept moving the sandpaper to prevent burning both the bowl and our fingers. We started with 100-grit, progressed

SIDE SECTION

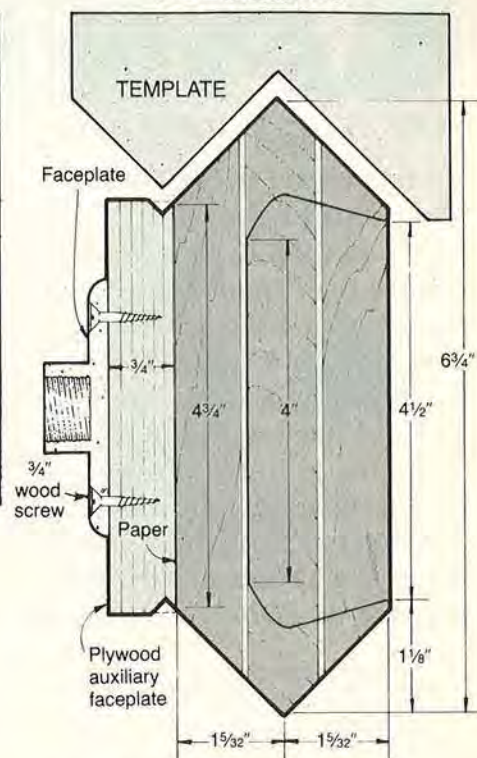

through 150-220 grit and finally 320-grit sandpaper using a lathe speed of about 1,000 rpm).

2 Using a chisel and a mallet, work your way around the perimeter of the bowl, tapping gently at the paper line to wedge the bowl away from the plywood. (We positioned the flat edge of the chisel against the bowl's bottom to prevent denting the padauk.) Be careful not to mar the padauk by driving the chisel too far in, or rocking the chisel back and forth to remove it. The laminated bowl should break cleanly from the plywood at the paper line.

3 Sand the bowl bottom smooth, being careful to keep it perfectly flat (we used a stationary belt sander for this operation).

4 Apply the finish. (To slow the darkening of the padauk, a common frustration with this exotic wood, we used Pratt and Lambert Vitalite UVA Spar Varnish. The ultraviolet absorbers filter out most of the sun's destructive rays.)

Project Design: James R. Downing
Photograph: Bob Calmer

A CLASSY COVERED

CANDY CADDY

(SAY THAT THREE TIMES QUICKLY, IF YOU CAN)

We know one thing for sure about this project — it's a lot easier to turn than it is to pronounce. Made from Honduras mahogany, which we vouch for as a wonderful turning wood, this container with lid has enough design elements to make it interesting, and it's useful to boot. For more information about the basics of faceplate turning, see the article on page 38.



PREPARING THE STOCK

1 Crosscut a piece of 4x4" mahogany stock to 6" long. Draw diagonal lines on one end to locate the center.

2 Carefully center and mount the marked end of the stock to the faceplate. (We used #10x1" brass flathead wood screws.)

3 Slide the tailstock to the other end of the mahogany stock, and lock it in position. The tailstock helps support the workpiece and reduces vibration when you round-down the square stock.

LET'S START TURNING!

1 With the lathe running at a low speed (400-600 rpm), round-down the mahogany square stock with a spindle gouge.

2 Using the Container-Layout Drawing as a guide, lay out the location of the top and bottom points of the container and lid on your workpiece. Make shallow parting cuts at each of these points.

3 Use carbon paper to transfer the full-sized lid template (shown on the opposite page) to a piece of

cardboard. Cut the cardboard template to shape. Now, increase the lathe speed to 800-1,000 rpm, and use a small skew chisel, gouge, and parting tool to form the lid and finial. After shaping the lid, slide the tailstock away.

4 Sand the lid exterior smooth. Then, with the lathe speed at about 500 rpm and using a parting tool as shown in the photo *below*, cut the lid apart from the workpiece. Be sure to keep one hand below the lid so you can catch it as it falls free. (Note: We caught ours in our right hand to prevent the lid from spinning off the lathe and getting marred or dented.)

TURNING THE CONTAINER

1 Again using the Container-Layout Drawing as a guide and, a parting tool, cut away all excess material from the top of the container. Then, hollow out the inside of the container, being careful not to go too deep or get the wall thickness too thin. Continually check the fit of the lid against the opening of the container, and turn the opening to within $\frac{1}{16}$ " of the diameter of the lid's lip. Then, sand the



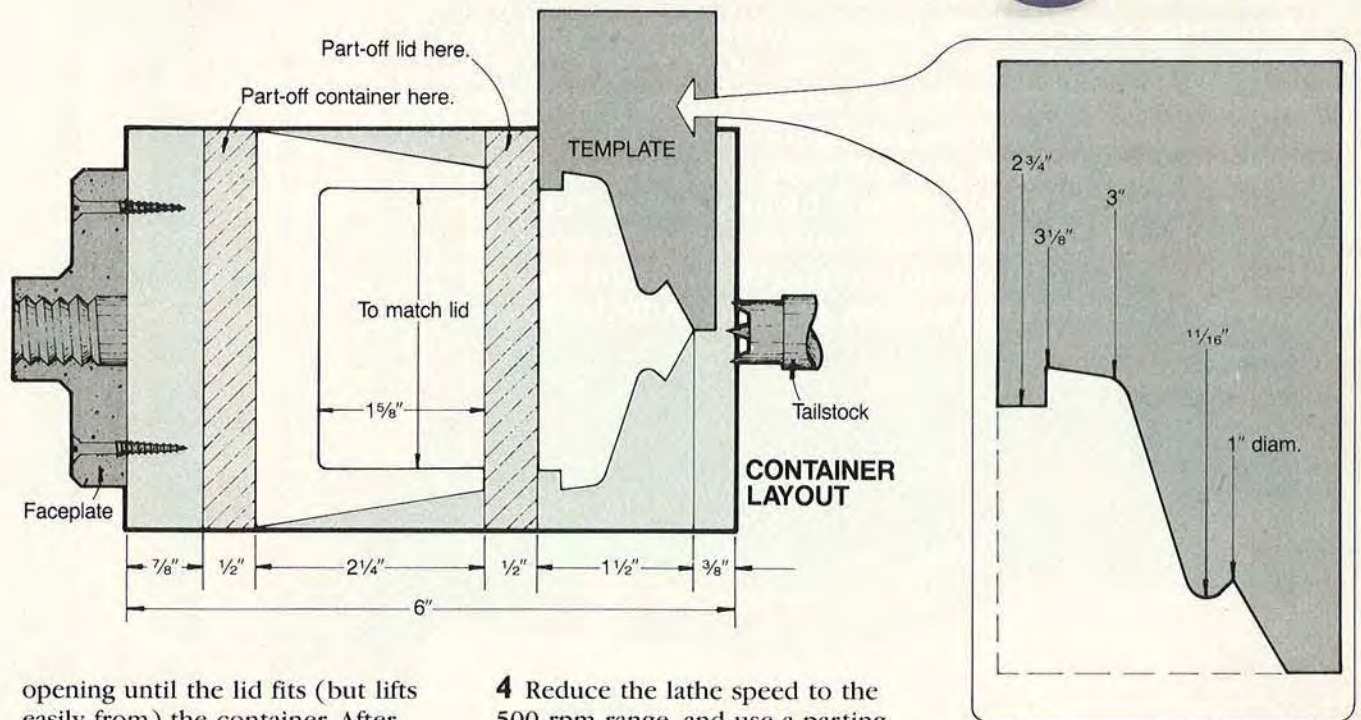
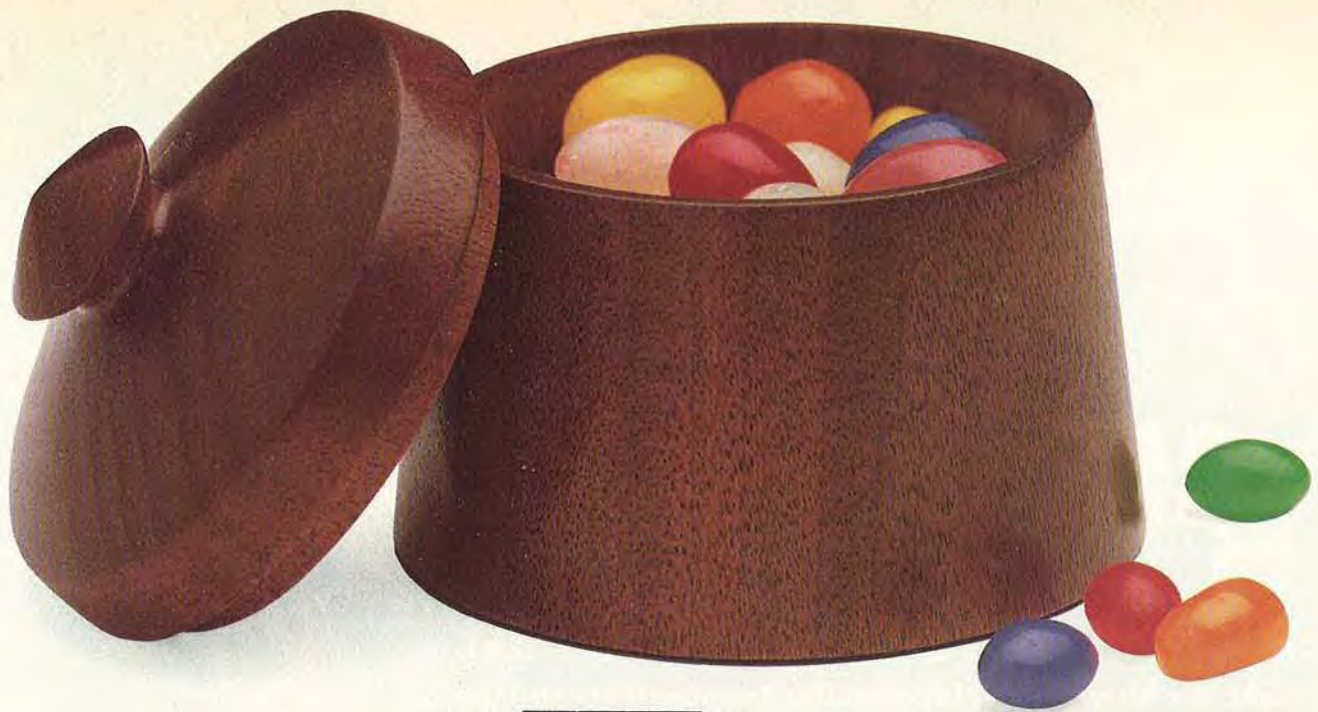

opening until the lid fits (but lifts easily from) the container. After turning several containers with lids, you will get such a perfect fit that you can hear and feel a slight vacuum when pulling the lid off.

2 Turn the outside of the container to shape so that the taper of its sidewalls matches that of the lid.

3 Sand the outside of the container smooth at about 1,000 rpm. Turn the lathe off, and do the final sanding *with the grain*.

4 Reduce the lathe speed to the 500 rpm range, and use a parting tool to separate the container from the remaining portion of the mahogany. Finally, sand the bottom of the container smooth and flat to avoid rocking (we sanded ours on a stationary belt sander).

5 Use a tack rag to wipe off any sawdust, and spray or brush on a clear finish. (With the lathe running, we sprayed on several light coats of lacquer, steel-wooling between coats with #0000 steel wool.)

FULL-SIZED TEMPLATE

BUYING GUIDE

● **Mahogany turning square.** 4x4x12", \$8.75. Constantine, 2050 Eastchester Rd., Bronx, NY 10461. Call 1-800/223-8087 to order (in New York call 212/792-1600). ♣

Project Design: James R. Downing
Photograph: Craig Anderson



FOLK TOYS

Playthings from America's Past

Like the blue-green ridges of the Appalachians and the wandering valleys of the Great Smokies where many of them originated, folk toys seem as if they've been around forever. Made from common sticks and scrap-wood, make-do fasteners, and minimum finishes, these primitive mechanical marvels have been re-created so many times that much of their history is lost. Yet, folk toys continue to beguile and entertain, just as they did before the turn of the century. You'll find them fun and easy-to-make stocking stuffers, perfect for the holidays.

Spindle Top
see page 84 for details

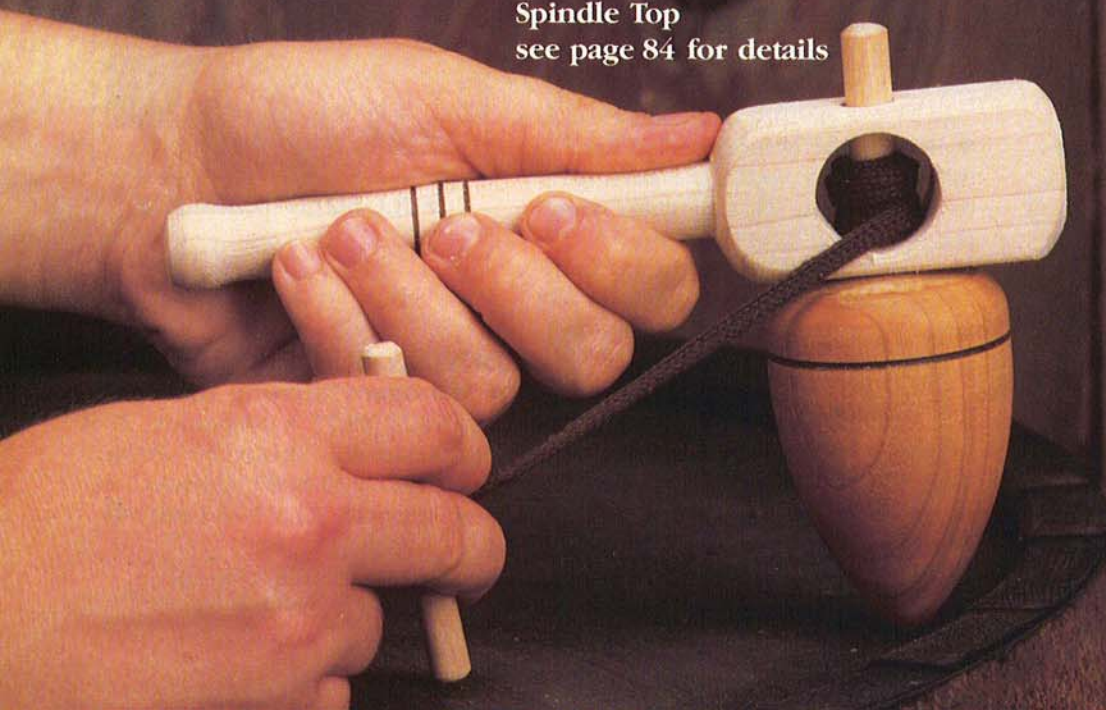

WHIMMYDIDDLE

Even adults enjoy the mystery of this toy. Rub a stick across its row of notches and the propeller begins spinning — sometimes. An accomplished whimmydiddler will have the prop spinning forward, then backward, and can control speeds from very slow to blurringly fast. Lore has it that this folk toy, also called a hooley stick or gee-haw, is a lie detector. Those who can't make it perform shouldn't be believed!

Since all whimmydiddles we've seen use tree branches, your stock should cost you nothing. Select a green hardwood branch 7-9" long, without a pithy center, for the body. (It's easier to carve green and will harden as it dries.) Make your rubbing stick, about 4" long, from the same material. Use a $\frac{3}{16}$ "-diameter twig for the $1\frac{1}{2}$ "-long rotor.

Space the notches evenly when you carve them. Test the whimmy-

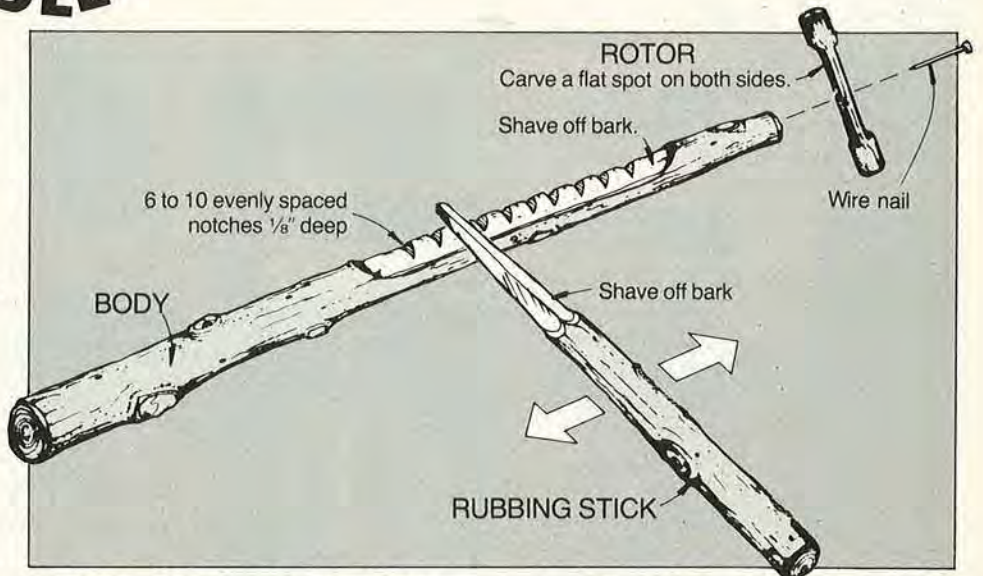

diddle by rubbing the stick briskly along the notches. If it's slow to respond, carve down the body diameter or deepen the notches.

While the whimmydiddle actually does operate on a complex set of physical principles, the operator

does control it, and that's the trick! (One sure way to get it going is to keep your thumbnail lightly rubbing against the body as you run the stick across the notches. Experiment for backward and varying speed.)

FLAP JACK

The first version of this animated trapeze artist was probably created from the indelible impressions of a high-wire act in a traveling circus. In real life, the daring act lasted but a few minutes, but at home the man of wood could fly through the air with the greatest of ease on a child's whim.

We used yellow poplar for our folk toy, but almost any scrapwood will do, as long as it doesn't split easily. Use a heavy, braided nylon fishing line of about 20 lbs. test to string the arms and uprights together; coated bell wire joins the arms and body.

Paint as much, or as little, detail on the trapeze artist as you wish. Don't worry about a finishing coat — folk toys were traditionally left unfinished after sanding smooth because they weren't expected to last.

Just squeeze the bottoms of Flap Jack's uprights together to make him bounce, twirl, and vault through the air.

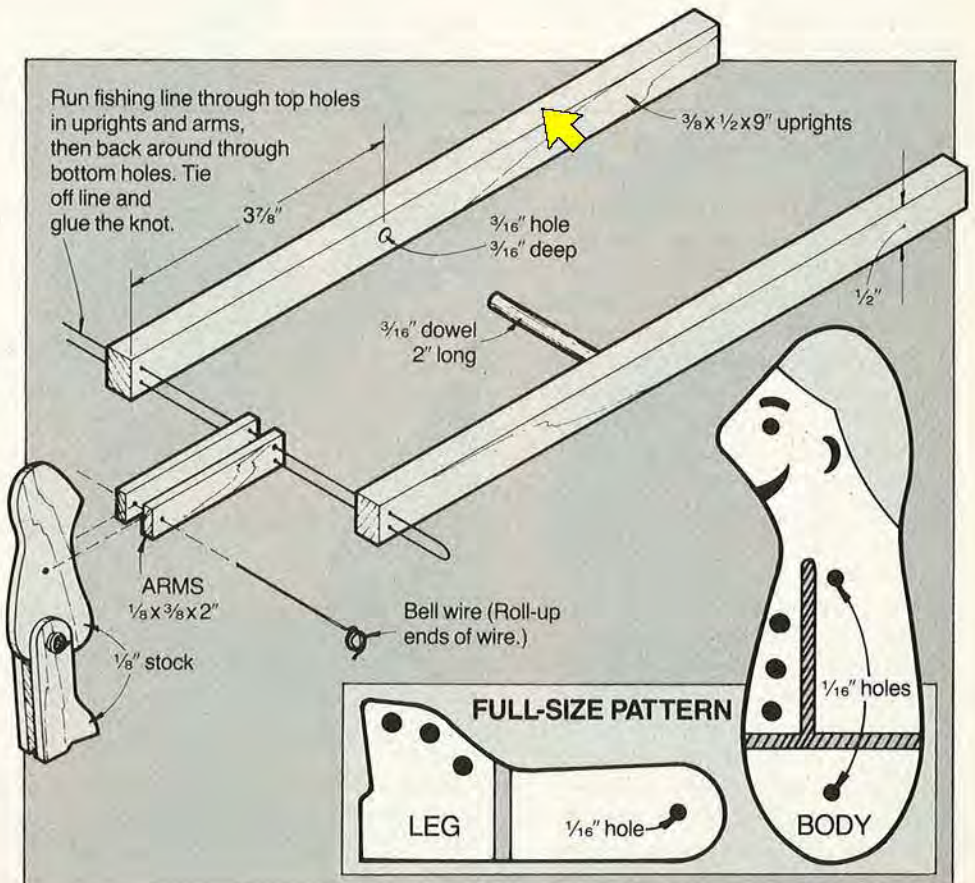

Continued

FOLK TOYS

SEE SAW

Many folk toys depict the work, tools, and activities of the adult world, not unlike some of today's toys. See Saw imitates a common rural scene many years before the invention of the chain saw, when the only way to quickly saw up firewood was with a two-man saw. The sawyers here buck (cross-cut) their log as you push and pull on the rails which connect them. But, like a dog chasing its tail, they never seem to get the job done — they're just fun to watch!

Be sure you run the grain of your wood up and down the length of the sawyers' bodies, and with the length of their arms, so it won't split in action. Use glue only to fasten the miniature log, made out of a section of tree branch, to the top rail of $\frac{1}{8}$ " stock. Friction fit all the $\frac{1}{8}$ "-diameter hardwood dowels into their holes in the sawyers so that nothing binds during operation.

Paint on eyes and other features in bright colors or work clothes, or leave them blank. Plain or painted, the action's the same.

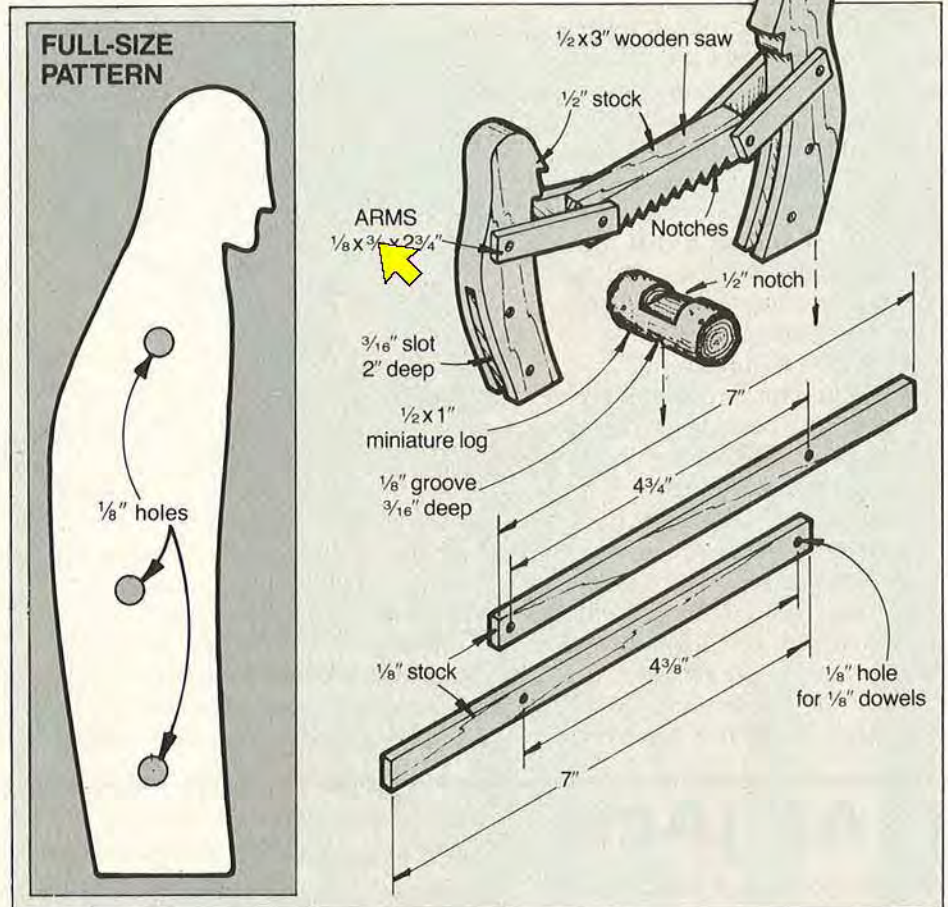

CLIMBING BEAR

Wild bears roamed about freely in our nation's backcountry during the 1800s and were often a cute nuisance to rural settlers. Climbing bear, however, was no doubt made to imitate the trained variety seen at a circus or carnival, which performed all sorts of tricks on command. This bear will climb the cords as you make alternating jerks. When bear reaches the top, let go of the cords and he slides back down.

Make the body of a hardwood such as birch or maple because you'll need its weight to pull bear down after each climb. The cord hanger-loop is meant to be fastened to a wall or other vertical surface. We think bear's cuddly as shown, but you might want to deck him out in jacket and pants.

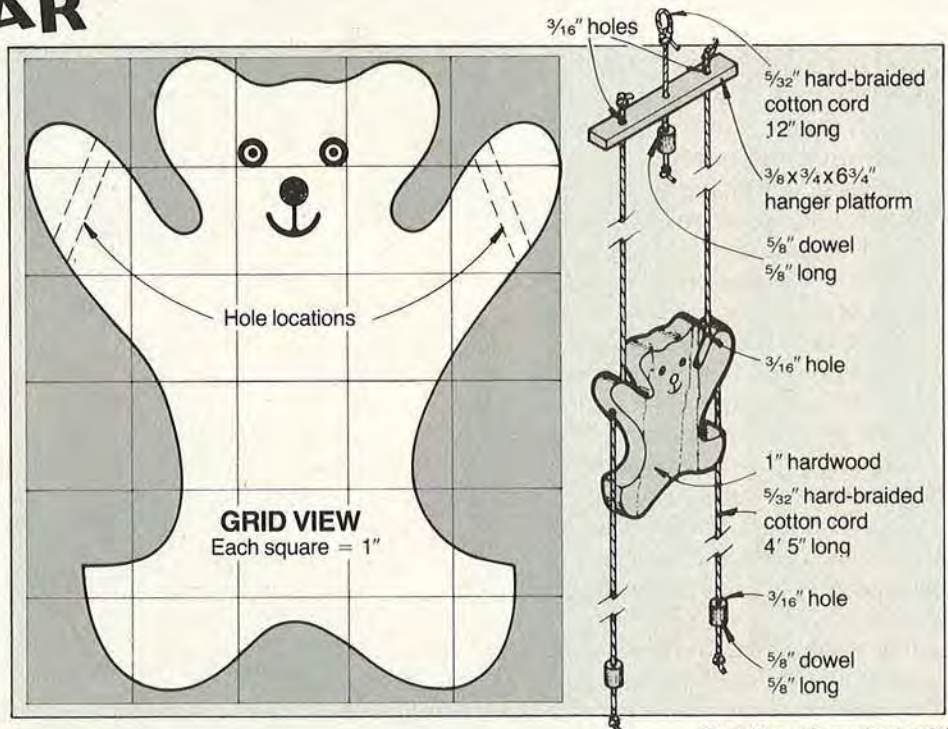

Continued on page 84



Chickens Pecking
see page 85 for details

All folk toys designed by Dick Schnacke, author and expert on American folk toys, and owner of Mountain Craft Shop, New Martinsville, West Virginia.



POLYMERIZED TUNG OIL

Ever had the feeling that other woodworkers know a thing or two about finishing their projects that you don't? We certainly have! Some projects simply "radiate" quality, and more often than not, it's the finish that attracts your attention.

Bill Lovelace, a woodworker from Phoenix, Arizona, shared some of his finishing wisdom with us, and we think you'll agree with us that the results shown above speak for themselves. Bill finishes his Southwest-inspired stack-laminated bowls with lacquer-type sanding sealer and polymerized tung oil, and he swears that if he can get good results, the rest of us can, too. Here's how he goes about it.

Note: Not all tung oils have been polymerized. This heating process combines tung oil with selected other ingredients to create a controlled, faster dry rate. This produces a harder, more durable, and more chemically resistant finish than non-polymerized tung oil.

BRING ON THE ABRASIVES

Bill sells a lot of his bowls, some for as much as \$750. And he knows that people willing to plunk down that kind of money for a decorative bowl know the difference between quality workmanship and an inferior product. That's why he spends an hour or more sanding his bowls after turning the project.

While he could do all of the sanding by hand, Bill prefers to speed the process along by running the lathe at medium speed and chucking up a series of flap sanders — coarse, medium, and fine — in a $\frac{3}{8}$ " reversible drill to sand both the outside and inside of the bowl (see photo A). And to smooth the bottom, he changes to a flexible sanding disk, again using several grits of abrasive (photo B).

For best results, Bill advises that you blow off the dust created by one grit before moving on to the next one. Otherwise, he says, "you end up simply moving the same dust around rather than removing more material."

Lots of woodworkers would be satisfied with the results they'd achieve with the flap sander and sanding disk, but not Bill. He also

sands all surfaces by hand with a succession of B-weight garnet abrasives (120-, 150-, 180-, and 220-grit).

SANDING SEALER: THE GREAT TIME-SAVER

Once satisfied that the surface is ready, Bill pops the lid off one of his favorite finishing products, Parks Lacquer-Type Sanding Sealer. Like most woodworkers who have found success with a product, Bill swears by this sealer. "I apply one *thin* coat with the grain with a disposable brush, and I'm always on the lookout for drips; they take lots of elbow grease to remove." (Photo C shows how he applies it.)

Bill doesn't know specifically what's in the product that makes it dry so quickly (usually 30 minutes or less), but he appreciates that characteristic.

After allowing the sealer to dry to the touch, Bill then turns on the lathe (at medium speed) and sands all surfaces with 0000 steel wool (as shown in Photo D). He prefers steel wool over coated abrasives because he feels he has better control with it. Bill advises to apply a good amount of pressure, but "be careful when working around





corners. It's easy to sand too deeply".

How does this craftsman know when the

bowl is ready for the tung oil? "I depend a lot on feel, and also visually check the surface with the bright light. The light makes spotting rough areas pretty easy."

POLYMERIZED TUNG OIL — THE FINISHING TOUCH

The second part of Bill Lovelace's one-two finishing punch is a product called Jasco Tung Oil. (See the

● Dust can play havoc with this finish because of its lengthy drying time. So make sure, especially on the last coat, that there's not any airborne dust floating around in the shop.

● This same finish also works well on all kinds of projects. "I just finished a grandfather clock with this tung oil, and it turned out beautifully," says Bill.

● If the project loses some of its luster after a time, you can restore the shine with lemon oil.

● To fix mistakes, sand the area with 120-grit abrasive, then apply more sanding sealer and tung oil.

THE LOOKING-GLASS FINISH THAT LASTS AND LASTS



Buying Guide for more information on this and the sanding sealer.) Here again, he could go on the road as a promotion man for this product, claiming that, "I've tried several other brands of tung oil, but I like Jasco the best."

What's his secret to success with this product? "Don't follow the directions too closely. Don't rub it in; just lay it on and leave it alone." Rotating the bowl by hand, he applies a *thin* coat of tung oil with an absorbent towel or a lint-free cloth and tries to avoid overlapping the finish (see photo E).

Twenty-four hours after applying the first coat of tung oil, Bill sands all surfaces with 0000 steel wool. "I usually put on four or five thin coats and steel-wool between each. But after the final coat, I don't do anything except allow the finish to dry. It self-levels and dries to a deep luster."

MORE TIPS FROM BILL ON USING POLYMERIZED TUNG OIL

● Make sure the temperature is at least 70° when applying the finish. Lower temperatures slow drying time and make application more difficult. They also may cause the finish to fog.

BUYING GUIDE

● **Parks Lacquer-Type Sanding Sealer.** Available in quart containers through Ace Hardware and Sherwin-Williams stores. They may have to order it. We paid \$5.99 per quart locally.

● **Jasco Tung Oil.** Contact Jasco at (415) 968-6005 for availability in your area. Available in pints, quarts, and gallons. Expect to pay about \$4.26 per pint, \$7.49 a quart.

HELP WANTED: We sure would like to make contact with more woodworkers like Bill Lovelace, people who are willing to share their finishing secrets with us and with you. If you know of any such woodworkers, please have them drop a line to "In Search of the Perfect Finish," WOOD Magazine, 1716 Locust Street, Des Moines, IA 50336. And don't be bashful if you've got a technique of your own to share! We may visit them — or you — in the shop to do an on-location interview and photo. Thanks for your help! 🍀

Produced by Larry Clayton
Photographs: Reddie Henderson

PRACTICAL SHOP GEOMETRY

CIRCLE SAVVY, ELLIPSE INSIGHTS, PROPER POLYGONS

Just as important as layout tools and measuring devices is the know-how woodworkers call “shop geometry.”

Unlike the theoretical problems in mathematics class, the solutions to shop layout problems often determine the success or failure of your woodworking projects. Here, we show you how to find the center of circles, lay out ellipses for ovals, and draw polygons — perplexing problems with surprisingly easy solutions. For fun, work out our methods on paper as you read along.

FINDING THE CENTER OF A CIRCLE

Without a center finder or a compass to help out, finding the center of a circle can be an elusive, trial-and-error task. Learn and practice these two methods, however, and you'll always be on target.

Arcs for Large Circles. Try this procedure, shown opposite, *top*, for even extremely large projects, such as finding the location for the umbrella hole in a big, round picnic table.

Step 1. Draw line *AB* anywhere across the circle and extending past the circumference.

Step 2. Place trammel points where *AB* crosses the circumference at *point A* and swing arc 1. Then swing arc 2 from *point B*. Draw line *CD* through the points where the arcs intersect. You have now found the centerline of the circle.

Step 3. Find the center by dividing line *CD* in half. Or, double-check by erasing all marks except line *CD*, and swing arc 3 from *point C*

and arc 4 from *point D*. Draw line *EF* through the points where these arcs intersect. The center is the intersection of lines *CD* and *EF*.

The 90° Angle for Small Circles

Use a framing square, a piece of scrapwood with at least one square corner, or even a business card, as your “rule” in this technique, shown opposite, *center*. It's perfect for finding the center of round stock.

Step 1. Place the 90° corner of your marking device anywhere on the circle's circumference — *point A* — so that the legs cross the circumference at *points B* and *C*. Put a mark at these points.

Step 2. Connect your two marks with line *BC*, which then denotes the diameter of your circle.

Step 3. Divide line *BC* in half and you have found the center!

LAYING OUT ELLIPSES

You can draw a small ellipse, for the leaves of a drop-leaf table, for instance, by using a framing square and a straightedge of scrapwood, shown opposite, *left*.

Drawing Small Ellipses

Step 1. Draw a line the length of your project as *AB* and mark its midpoint *C*.

Step 2. Draw the perpendicular line *CD* through the midpoint to your project's width.

Step 3. Make a straightedge to use as a kind of compass from a piece of scrapwood longer than half the length of your ellipse. Near one end of the scrapwood, mark *point E*, and drill a hole sized to grip a pencil tightly. From *E*, measure down the wood exactly half the length of your ellipse and mark *point G*. Drive a small nail through the wood at *G* and let the tip protrude. Again from *E*, measure down the scrapwood half the width of your ellipse and mark *point F*

Drive a nail through the wood at *F*.
Step 4. Position a framing square as shown, and lay the scrapwood across it so the nails at *G* and *F* touch the framing square.

Step 5. Swing an arc with your scrapwood “compass” for one-quarter of our ellipse by sliding the nails along the square's edges. Reverse the framing square to draw the other quarter. To draw a complete oval, repeat the drawing steps on the other side of line *AB*.

Make a Pattern for Large Ellipses

You're faced with constructing a large oval tabletop from a 4x8' sheet of plywood — how do you arrive at the gently curved corner shape? Simple. You make a template that you can use on each corner, as shown opposite, *right*. Here's how it's drawn:

Step 1. Divide the length and width of your stock by two, and draw those measurements as perpendicular lines on pattern paper.

Step 2. Mark any number of equal spaces along the half-length line, then lay out the *same* number of spaces on the half-width line.

(Note: Spaces on the half-width line may have to be smaller and closer together than on the half-length line. That's OK, just keep the *number* of spaces equal.)

Number all the marks: on the half-length line top to bottom and on the half-width line left to right.

Step 3. Connect all marks with lines in numerical order, that is, 1-1, 2-2, 3-3, 4-4, and so on.

You now have an ellipse to fit. 🌲

Turn to page 97 to find out how to draw hexagons, octagons, and other polygons.

Produced by Peter J. Stephano and James R. Downing with Paul McClure
Illustrations: Bill Zaun

ARCS FOR LARGE CIRCLES

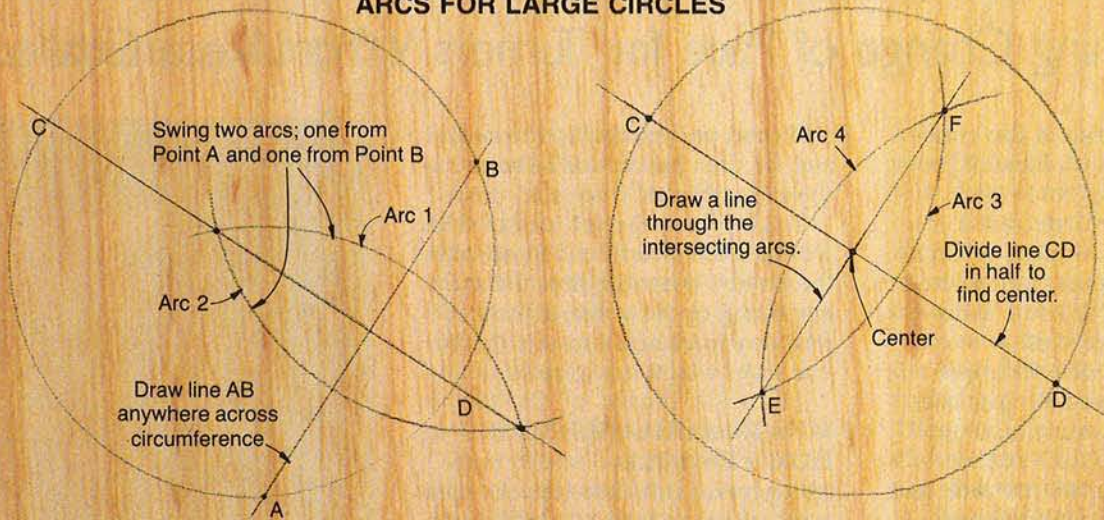

SMALL ELLIPSES

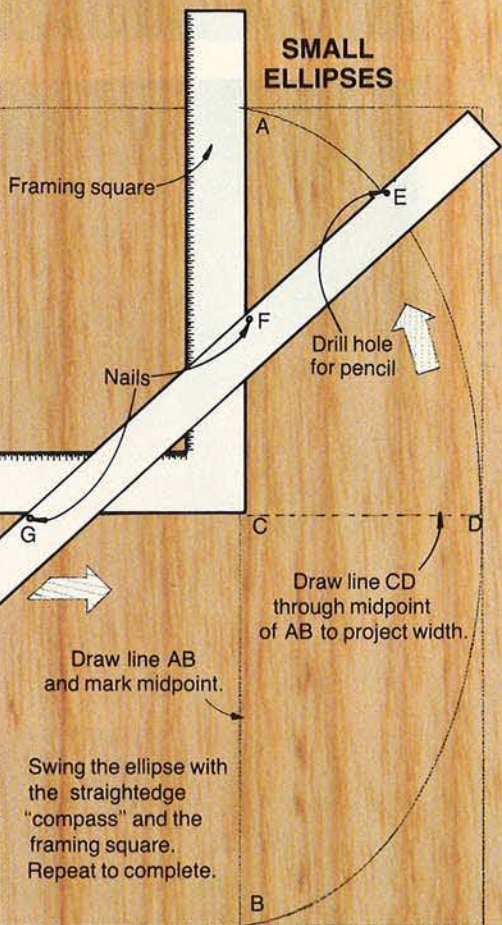

THE 90° ANGLE FOR SMALL CIRCLES

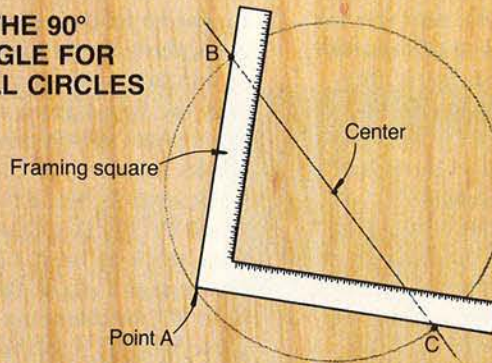

LARGE ELLIPSES

Draw lines half the length and width of your stock perpendicular to each other. Number equal spaces on both lines, then connect in numerical order.

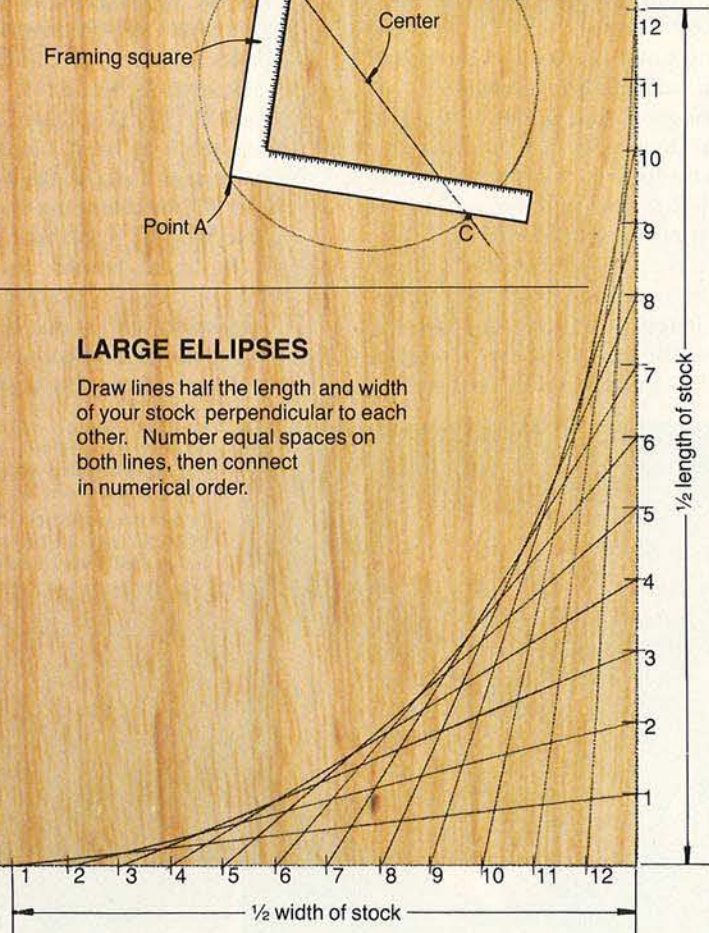

BOWL BLANKS

A Refreshing Change of Pace for Turners Who Like a Challenge

In our travels around the country, we see lots of unusual (but beautiful) turnings. And often when we ask the turner what wood the project is made from, he will tell us manzanita burl, spalted maple, wild lilac, or some other exotic-sounding species.

Finally, we couldn't stand the suspense any longer. We just had to try our hand at turning some of these beauties. Little did we realize when we made the first few calls to our regular lumber suppliers that only a handful of companies around the country market bowl blanks and burls. And we were choosy about the companies we used. Selling thick stock, like many lumber companies do, wasn't enough. Properly cutting and preparing bowl blanks and burls had to be one of their specialties. Although it took some digging, a lot of digging in fact, we found the results well worth the effort needed to locate these companies and their unusual stock.

We then ordered several bowl blanks and burls from the companies listed at the end of this article. When the pieces started coming in, we divided the spoils among the

staff (and one local woodturner) and we then proceeded to turn these "sow's ears" into "silk purses."

To give you a better idea of what we started with and ended up with, the photos show the finished project sitting on or beside a blank or burl nearly identical in size to the one from which it was turned.

WHAT'S AVAILABLE AND HOW IT'S SOLD

As a general rule, bowl blanks measure anywhere from 2" to 6" thick and arrive cut in squares ranging from 4" to 12" or so across. And in almost all instances, the supplier coats the end grain with paraffin, or another waxy product to prevent the wood from checking. Companies specializing in bowl blanks sell them as dimensioned stock such as 4x12x12". Johnson Wood Products prepare and sell their stock as bowl blanks. The pieces run 1" to 4" thick and 4" to 15" in diameter. Burls — those woody, tumorlike growths on the limbs, trunks, and even roots of trees — usually come rough sized and marked by the pound. Some companies do cut the larger burls into smaller-sized

 [Print this article](#)

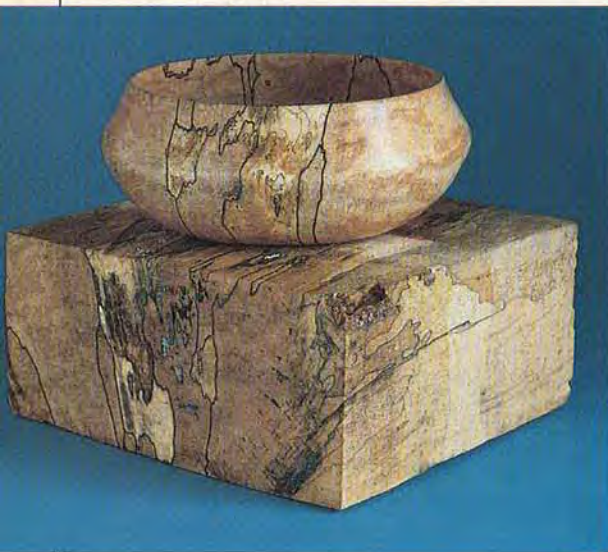
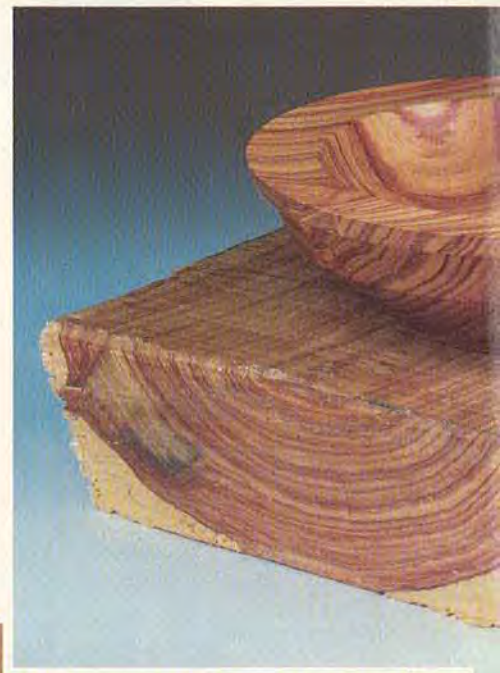

Spalted beech (left), sold by Native American Hardwoods, requires a sharp gouge and minimal pressure for a clean cut.

Cottonwood burl (below), sold by Cal Oak Lumber Company, turns easily and sands up quickly.



AND BURLS



(and Spectacular Results)



blanks providing for a far more economical purchase.

Craft Supplies USA of Provo, Utah, states that, as a rule of thumb, 1 board foot of their burl stock will weigh from 3 to 5 lbs. That means that a piece of box elder burl approximately 3x12x12" would weigh from 9 to 15 lbs. and would sell for around \$13 to \$23 at \$1.50 per lb. Others, such as Gilmer Wood Company of Portland, Oregon, will sell a burl in the rough for 40 cents per lb., but the price jumps to \$1.50 to \$2.00 per lb. if you want it milled.

Prices for burls can be as low as \$1 per pound for osage orange, but

soar as high as \$20 per lb. for pink ivory. Cal Oak Lumber Company sells their cottonwood and oak burls strictly by the piece, with a 2"-thick piece 24" or less in diameter selling for \$10, and up to \$40 for a 3-4" piece 48" in diameter.

Some of these rarities, such as the spalted woods, can go fast and cannot always be restocked quickly. There's also some competition for choice burls, which clockmakers and veneer cutters prize highly. Don't let this discourage you, though; almost all the stock we inquired about was sent out immediately, and we got on relatively short waiting lists for the rest.



Highly figured myrtlewood burl (top center), from Gilmer Wood Company, turns much the same as koa or butternut.

Tulipwood, hard and dense, comes from the state of Bahia in Brazil via Arroyo Hardwoods.

This piece of mazur birch was imported from Finland by Berea Hardwoods. New to American turners, mazur birch resembles spalted wood but turns much more easily.

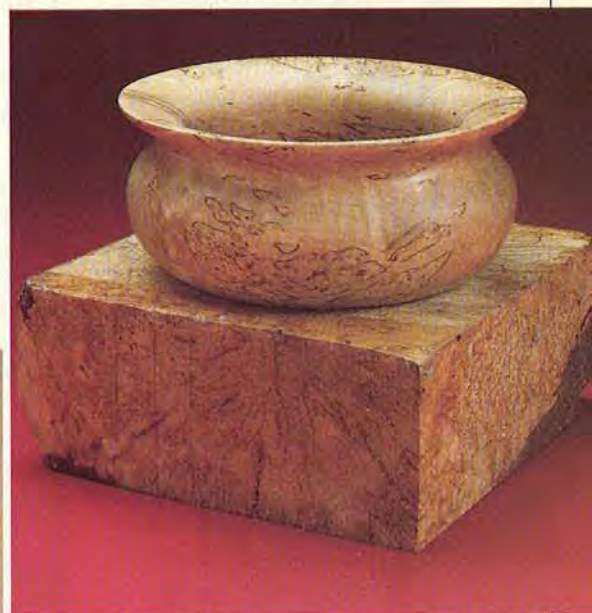

Cherry burl (far upper right corner), harvested from the Green Mountains of Vermont by Weird Wood, turns best when mounted between centers.

Manzanita burl (right), from southern California and the Baja, comes from Shir-Lee Manzanita Ranch. This wood turns best slowly with a heavy scraper.

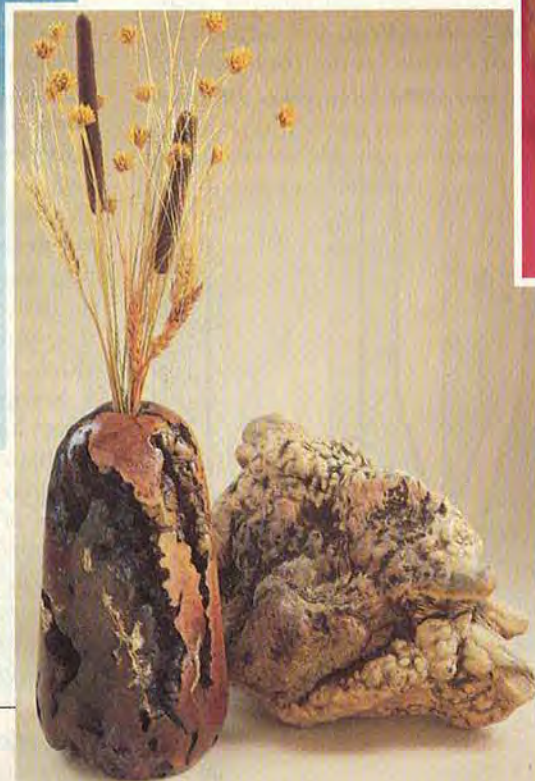

THE SOURCES WE'VE LOCATED

Hopefully we've "turned you on" to the idea of working some of these rarities on your lathe. If so, contact the companies on page 86 for further information on their stock, prices, and shipping. If you're looking for a certain size or type of wood, *let them know*: they've all proved helpful! 🌲

Produced by Marlen Kemmet
Photographs: Bob Calmer

TURNING

Scrapers and cutters, carbon steel, high-speed steel, bevels and flutes — today's array of turning tools seems to offer more choices than you can shake a skew at! Which of these tools does a beginning turner really need? Actually, once you learn turning tool terminology and understand just what each tool does, you can easily assemble a basic starter set for less than \$100. So before you spend a bundle on tools you might not need, study the guidelines in this article. We've also included our suggestions for a starter set you can round out as your turning skills develop.

does the cutting. Besides being beveled, tools known as gouges are also *fluted* with a concave center that helps throw off shavings.

The other end of the tool has a wood handle, with a *ferrule* that keeps the handle from splitting. Some tool makers offer tools without handles (though you can buy them separately) because some experienced turners prefer to turn their own. Ferrules usually are brass or steel. Steel is somewhat stronger, but the choice here is basically decorative.

THE BIG FOUR TURNING TOOL TYPES

Though they come in a multiplicity of sizes, with lots of variations, turning tools fall into just four different classifications, illustrated *lower left*. Each type does best at a particular task, and some do several jobs well. Let's summarize their principal use:

- **Gouges** are fluted workhorses that remove lots of material in a hurry, such as when you shape square stock into a cylinder or remove material from the inside of a bowl.
- **Skew chisels** — so-called because the bevel is skewed at a 20-25° angle to the side of the blade — do general shaping and finish cutting on spindle turning and on the outside surfaces of faceplate projects.
- **Parting tools** make narrow recesses or grooves. The tool gets its name because you can also use it to cut all the way through the stock, leaving it in two "parts."
- **Scrapers** have a very shallow bevel and come in a wide variety of shapes. The flat bevel sets scrapers apart from the other three types of turning tools, because scrapers perform an entirely different role. To determine how many scrapers you should buy — if any — you need to know just what scraping tools can and can't do.

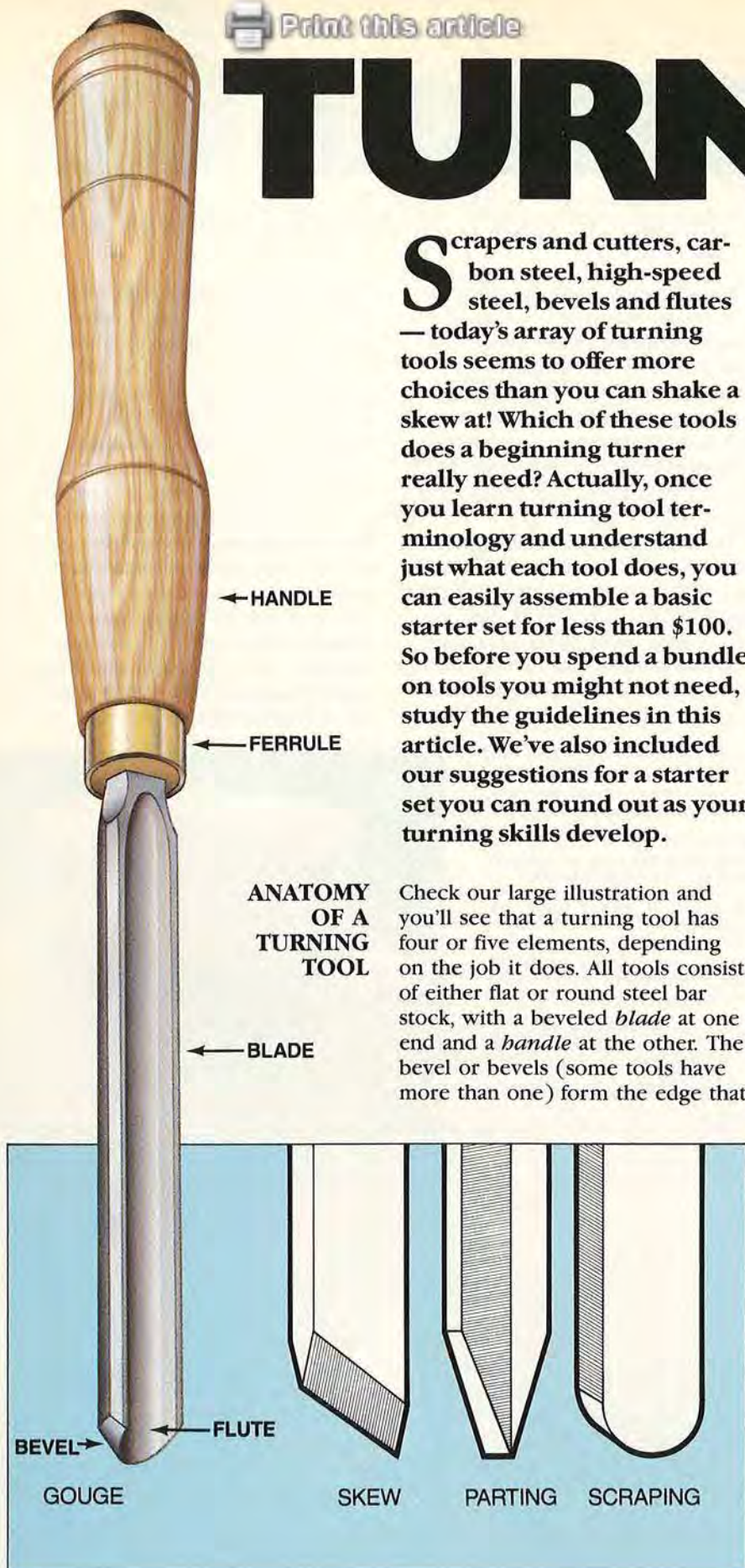

Check our large illustration and you'll see that a turning tool has four or five elements, depending on the job it does. All tools consist of either flat or round steel bar stock, with a beveled *blade* at one end and a *handle* at the other. The bevel or bevels (some tools have more than one) form the edge that

TOOLS WHAT TO KNOW BEFORE YOU BUY

SCRAPING TOOLS AND CUTTING TOOLS — WHAT'S THE DIFFERENCE?

What exactly happens when you press a turning tool into a spinning piece of wood? Depending on the tool you choose and the angle at which you hold it, you'll either *cut* the wood or you'll *scrape* it.

To cut (also known as shearing), you hold the tool at an angle to the rotating stock, fairly high above its centerline, with the handle slightly down, as shown in the drawing, *lower left*. The tool's edge — beveled 25 to 45 degrees from the end of the blade — shears away wood. You'll know you're cutting properly when curly shavings begin to pile up on the bed of your lathe.

To scrape, you hold the tool almost perpendicular to the stock, with the handle always slightly *up*, as shown in the drawing, *lower right*. Rather than shearing the wood, scraping wears it away, making dust, not shavings. Tools designed strictly for scraping have shallower, 15- to 20-degree bevels and a burr purposely left on after the edge is ground to provide the abrasion.

If you use it in the way just described, any cutting tool will also scrape, but because of the shallow bevel and burr, scrapers

won't cut. So why buy scrapers at all? Actually, if your lathe work will be limited to turning between centers, you needn't invest in scrapers. If, however, you'd like to try your hand at faceplate turning, you'll find that scrapers are much better than cutters for some tasks, such as removing ridges from surfaces and finishing the inside bottom of a bowl where a gouge can't make a clean cut.

Many beginning turners start out by scraping their first projects, regardless of whether they're using a cutting or a scraping tool. Though easier than cutting, scraping takes more time and leaves a rougher surface that requires lots of sanding. We strongly recommend that you tip a cutting tool's handle down right from the start and master the cutting technique. Once you learn how to cut, quality turnings take shape in a hurry.

TOOL STEEL — TODAY, YOU HAVE SEVERAL OPTIONS

As if you don't already have enough decisions to make about which turning tools to buy, manufacturers also offer a choice of tool steels. Once again, you have four options:

- **Carbon steel** was the norm for years, and it costs the least. It also

comes in the widest variety of shapes and sizes. You can quickly sharpen carbon steel, but it dulls more readily than other steels, turning blue in the process. Careless grinding — something we are all occasionally prone to — can also cause "bluing" and ruin the edge.

- **High-speed steel (HSS)** holds an edge much longer than carbon steel, even at the 1,000-degree-plus temperatures generated by turning. However, HSS is also more difficult to sharpen, and costs about a third more than carbon steel.

- **Laminated steel tools** utilize a forging process that bonds an extremely hard high-carbon steel cutting edge to a softer, more resilient steel backing. The result is a tool that holds a cutting edge almost as long as HSS, and can be honed to a much sharper edge. Laminated steel tools cost about twice as much as HSS versions and don't come in as wide a range of sizes and types.

- **Carbide-tipped** turning tools are relative newcomers to the scene. Like carbide-tipped saw blades, they feature a durable carbide cutting edge brazed to a steel blade. We ordered a set of carbide-tipped turning tools from Sears and found they performed very well in our shop. However, carbide-tipped tools cost more than twice as much as carbon steel tools. And though you can touch them up with a special whetstone Sears includes with the set, you have to either take them to a professional sharpening service for regrinding or invest in a costly diamond grinding wheel.

For a starter set, we feel you're best off sticking with either carbon steel or HSS. Besides its lower price, carbon steel offers another advantage for beginners: Because it turns blue when you overwork it, it tells when you are doing a heavy-handed job much sooner than HSS.

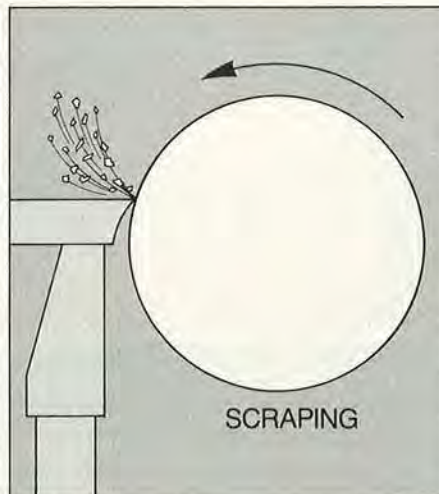
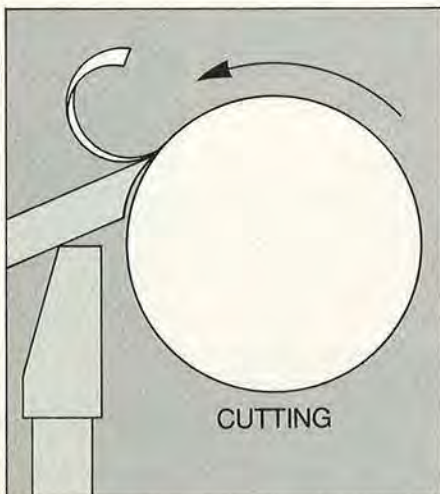

TURNING TOOLS

"LONG AND STRONG" VS. STANDARD-SIZED TOOLS

Standard tools all have 6" to 7" blades with 10" handles. These are big enough to handle most cutting needs, but don't try to extend the blade of a standard tool more than 4" beyond the tool rest. This puts a great deal of stress on the blade and handle, and could damage the tool or, worse yet, tear it out of your hands.

Some jobs, such as faceplate turning when you need to reach more than 4" deep into a bowl or vase, require a tool that has more length and heft than standard versions, so manufacturers have developed "long and strong" tools that are just that. Long and strong tools typically have 12" to 17" handles; the steel in these tools is longer, thicker, and wider than standard tool blades. Long and strong tools offer lots of rigidity and control for big projects, especially when you're turning green wood, but their size doesn't permit detail work.

Speaking of detail work, you can also buy miniature tools that are about 8" long for small jobs.

THE COST OF FINE TURNING

Sets of six or eight carbon steel tools usually cost \$75 to \$100; individual tools run \$10-\$20. As noted earlier, HSS adds about a third to the price tag of a carbon steel tool or set. Laminated steel tools come at a premium: \$30 to \$40 each. Carbide-tipped tools cost about \$18 each, \$65 for a set of five.

For long and strong tools, expect to pay \$10 to \$30 apiece for them, or about \$120 for a set of six. Miniatures run \$5 to \$10 each, about \$30 for a set of eight.

SHOULD YOU BUY A SET OR INDIVIDUAL TOOLS?

As we've noted, some companies offer sets of up to eight turning tools. These come with matching handles and are often packaged in a handsome box. Do sets make sense for a beginning turner?

On the plus side, sets can save you 10 to 15 percent over the cost of buying the tools individually, and most sets include at least one size of all of the "big four" types listed earlier.

Trouble is, depending on the turning jobs you want to do, the set may include some tools you'll never use, and lack others you need. This particularly applies if you're mainly interested in faceplate turning. Most sets consist of nothing but spindle turning tools, though a few manufacturers have put together sets for bowl turners, too.

Whether you elect to invest in a set or buy individual tools, we think your first purchases should include the turning tools shown and discussed in the chart below.

Turn to page 83 for a listing of sources for wood turning tools.









Produced with George Granseth
Illustrations: Greg Roberts,
Jim Stevenson.

WOOD PICKS THE BASIC STARTER SET

With just six lathe turning tools you can handle most spindle work. Add a bowl gouge and a

scraper or two and you can turn bowls as well. Make the tools shown here the first you buy. As

your skills improve you'll undoubtedly want to add other sizes and types.

TOOL	OUR CHOICES	BEVEL	USES AND COMMENTS
GOUGE 	3/4" AND 1/2" SPINDLE 1/2" BOWL	 30-45°	You'll probably use these first and most often. Bigger gouges do roughing work; smaller ones handle details and fine cuts. Deep-fluted and short-beveled, bowl gouges remove stock quickly in faceplate work.
SKEW CHISEL 	1/2" AND 1"	 20-25°	After you've rounded down stock with a gouge, you use a skew to smooth it out and shape it. A skew can make V-cuts, beads, and shoulders. The cutting edge is skewed 30-35° from the tool's end; the bevel measures twice as long as the tool is thick.
PARTING TOOL 	3/4" WITH A 1/8" DIAMOND POINT TIP	 25°	Parting tools do best at detail work. They also come in handy for "parting" tasks such as separating a small part from the main body of stock. The thickness of the tool's tip — 1/8" or 1/4" — determines the width of the cut.
SCRAPER 	1/2" ROUND-NOSE	 15-20°	The round-nose scraper, a good general-purpose tool for faceplate work, also makes coves and grooves on spindles. If you decide to buy a second scraper, get a 1" flat-nose. Other popular scrapers have hooklike blades specially shaped for turning inside bowls.

H · O · L · I · D · A · Y

SPECIALS

FROM · THE · SHOP



A 15-page treasure trove of well-designed projects sure to delight several special folks on your shopping list. Six projects in all...every one a winner.

Thoroughbred Rocking Horse

From Merry
Olde England

H·O·L·I·D·A·Y
SPECIALS
FROM THE SHOP

If you want to see a little tyke's eyes light up, put a rocking horse like this under the tree. It's lightweight, yet sturdy — and very huggable.

Like the Seventeenth-Century original in the Museum of London, our version is made safer by the curved projections at the front and rear of each rocker. The "stops" prevent energetic riders from tipping too far forward or backward while they whoop it up in the saddle. Finish your horse with stain and polyurethane or do it fancy (we had the horse on this page decorated by a tole-painting expert).

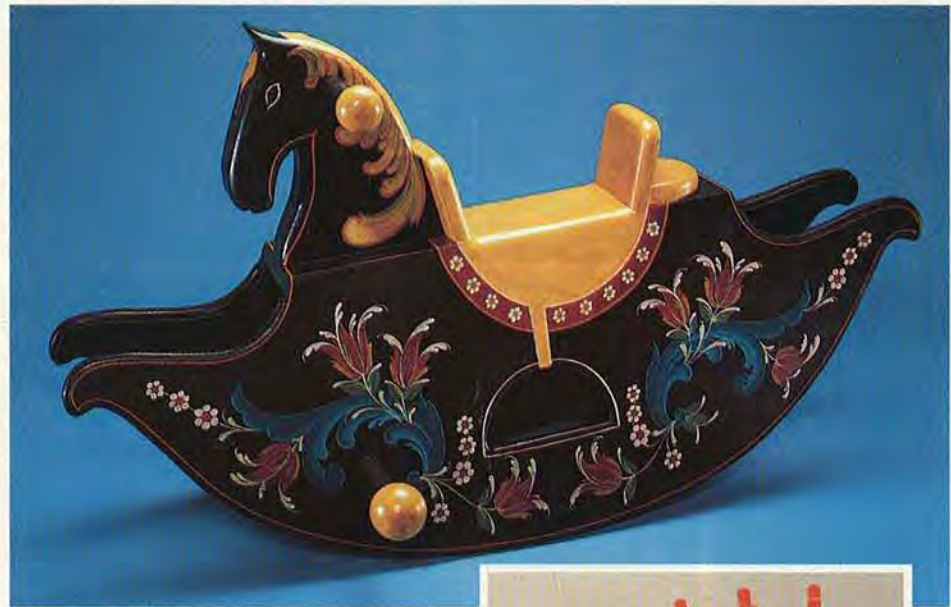

READY THE ROCKERS

- 1 From $\frac{3}{4}$ " cherry, rip three pieces $4\frac{1}{4}$ x 76". Edge-join the pieces together, clamping scrap stock across the pieces to keep them flat. Scrape off the excess glue once a tough skin has formed.
- 2 Crosscut the lamination in half to form the blanks for the rockers (A). With a table saw, bevel-rip the top edge of each rocker piece at 15° . Then, use double-faced tape to stick the two rockers together with the high edges (points) of the bevels together and flush.
- 3 With a ruler and straightedge, lay out 1" squares on a large piece of paper to form a grid pattern measuring 13 x 36". Use spray adhesive on the back of the grid paper to attach it to the taped-together rocker pieces.
- 4 Using the Rocker-Grid Drawing as a guide, mark the points where the rocker outline crosses each grid line to lay out the front and rear stops and top 3" of the rocker. Connect the points to transfer the



- shape of the rocker stops onto the grid paper. Mark the location of the stirrup opening as well as the footrest hole and screw holes (for part C) where shown on the drawing. To form the rocker bottom, drive 1" brads into the grid where shown on the drawing. Clamp a flexible strip of wood to the brads and trace along the inside edge of the strip as shown in the photo above.
- 5 With the rockers still taped together, cut them to shape. Drill a $\frac{1}{2}$ " blade access hole through the marked stirrup opening; then cut the opening to shape with a jigsaw or scroll saw.
 - 6 Drill three $\frac{5}{32}$ " holes through both rockers for later mounting

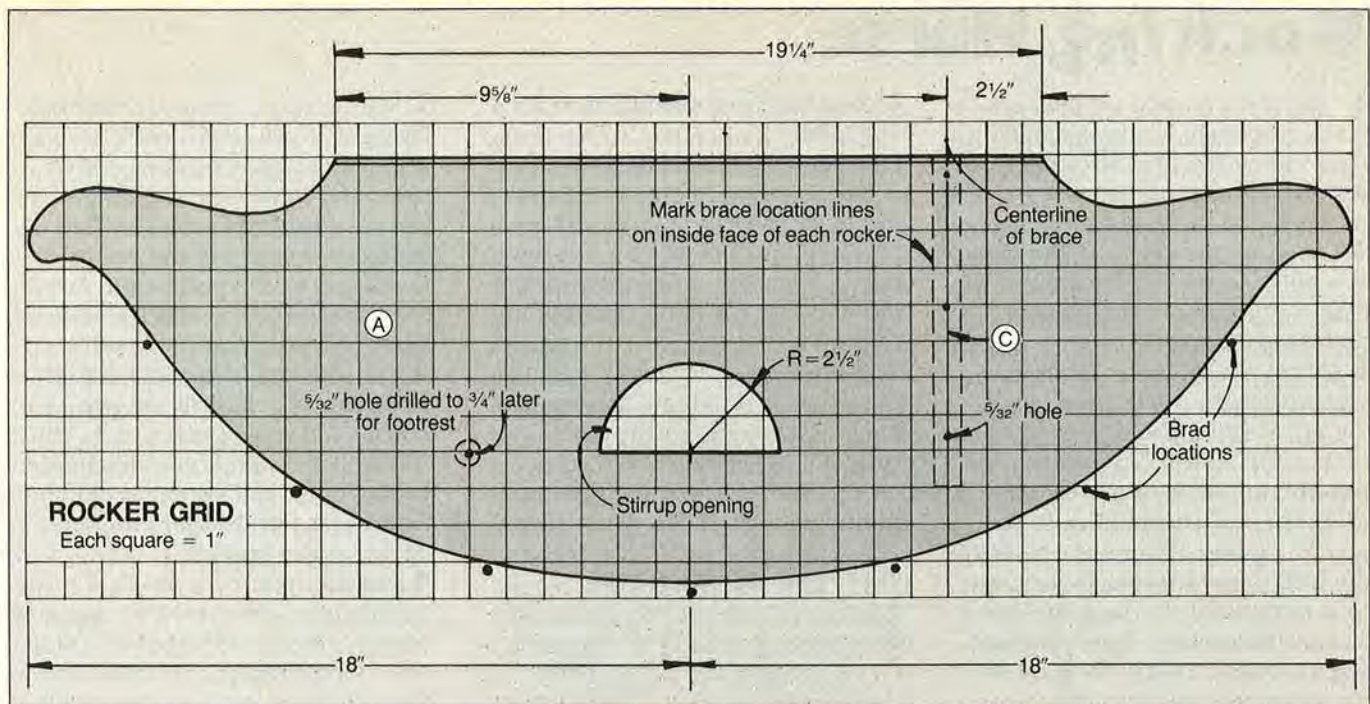

of the brace (C). Then, drill a $\frac{5}{32}$ " hole for the footrest (see the Rocker-Grid Drawing for locations). By drilling through both rockers, you've assured precise alignment of the $\frac{3}{4}$ " footrest dowel later.

7 Sand the edges of the rockers (we belt-sanded the bottom of the rockers and drum-sanded the harder-to-get-at areas around the stops). Wrap sandpaper around a strip of thin stock, and use it to sand the edges of the stirrup openings. Separate the two rockers, remove the grid paper, and sand off any sticky residue.

8 To make a jig for drilling the angled footrest holes through each rocker, start by ripping a 12" length of 2x4 in half. Set one of the pieces aside, and drill a $\frac{3}{4}$ " hole $3\frac{1}{2}$ " deep centered into either end of the other piece. Miter-cut the scrap at 15° so that the saw cut intersects the $\frac{3}{4}$ " hole. Then, draw a centerline along the longest face of the jig.

9 Use a framing square to mark a line centered through the $\frac{5}{32}$ " pilot hole perpendicular with the beveled-top edge of each rocker. Clamp the jig in place parallel with the beveled top edge of the rocker and centered on the line drawn through the $\frac{5}{32}$ " hole as shown in



the photo above. Drill the $\frac{3}{4}$ " footrest-dowel hole through the rocker. Repeat with the other rocker.

10 Using a $\frac{1}{4}$ " round-over bit, rout both edges of the stirrup opening in each rocker. Readjust the $\frac{1}{4}$ " roundover bit to leave a $\frac{3}{32}$ " shoulder. Rout the edges of each rocker to form a bead (see the Bead Detail that accompanies the Exploded-View Drawing.) Don't rout the top edge. Round off the end of the bead (where it meets the top-beveled edge) with a chisel, then sand it to finished shape.

BUILD AND ASSEMBLE THE BODY

1 First, cut the seat (B) oversize, then bevel-rip both edges at 15° to a $4\frac{3}{8}$ " width. Bevel-cut both ends at the same angle to a $18\frac{3}{4}$ "

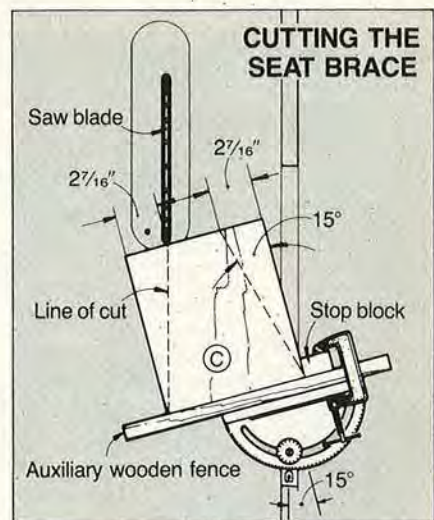

length. Mark the location of the six rocker mounting screw holes on the top of the seat. Then, drill $\frac{3}{8}$ " holes $\frac{1}{4}$ " deep at these points. Switch to a $\frac{5}{32}$ " bit and drill the screw-shank holes centered in the $\frac{3}{8}$ " hole you just drilled (see the Screw-Hole Detail on the Exploded-View Drawing).

2 From $\frac{3}{4}$ " stock, rip and crosscut a piece $7\frac{3}{4} \times 9$ " for the seat brace (C). Set your table saw miter gauge to 15° left of center, and attach an auxiliary wooden fence and stop as shown in the drawing above. Rip the seat brace, flip the brace over, and rip the other side.

Continued

Rocking Horse

3 Lay out the radii on the seat brace where shown in the Brace Drawing on the opposite page. Cut the bottom edge of the seat brace to shape and drum-sand it.

4 Using the Rocker-Grid Drawing as a guide, mark the location of the brace (C) on the inside face of each of the rockers.

5 Clamp one of the rockers in a vise with its beveled top edge facing up. Position the seat on the rocker. Then, drill $\frac{7}{64}$ " pilot holes into the top edge of the rocker, using the $\frac{5}{32}$ " shank holes in the seat as a guide. (Be careful to keep the drill perpendicular to the seat to avoid drilling through the inside face of the rocker.) Now, glue and screw the seat to the rocker. Use the same procedure to attach the seat to the other rocker.

6 Remove the assembly from the vise. Slide the brace (C) into position between the rockers, centered between the lines drawn on the inside faces. Drill $\frac{7}{64}$ " pilot holes $\frac{3}{4}$ " deep into the brace centered in the $\frac{5}{32}$ " shank holes drilled earlier in the rockers. Glue and screw the rockers to the brace.

7 Plane a scrap of cherry $\frac{5}{16}$ " thick. Use a $\frac{3}{8}$ " plug cutter to cut plugs $\frac{5}{16}$ " long from the scrap. Glue the plugs over the screws, taking care to match the direction of the grain. Sand the plugs flush.

TOPPING THINGS OFF

1 Rip and crosscut two pieces of $\frac{3}{4}$ " cherry to 9x10" for the head (D). Glue and clamp the pieces together face-to-face. When dry, trim the bottom for a square edge.

2 With a ruler and a straightedge, lay out 1" squares to form a 10x11" grid pattern on a piece of paper. Using the Head-Grid Drawing as a guide, transfer the shape of the head (as well as the eye and rein locations) to the grid paper. Attach the pattern to your stock with spray adhesive. Cut the head to shape, and sand the edges smooth.

3 With a $\frac{1}{4}$ " bit, drill the eye holes $\frac{1}{8}$ " deep. Switch to a $\frac{3}{4}$ " bit, and drill the rein hole, backing the head with scrap to prevent chip-out. Remove the grid paper and sand off any sticky residue.

4 Cut the saddle pieces (E, F) to finished size, bevel-cutting one end of each piece at 15°. Mark the radii where indicated in the Exploded-View Drawing, and cut the saddle pieces to shape. Sand the radiused

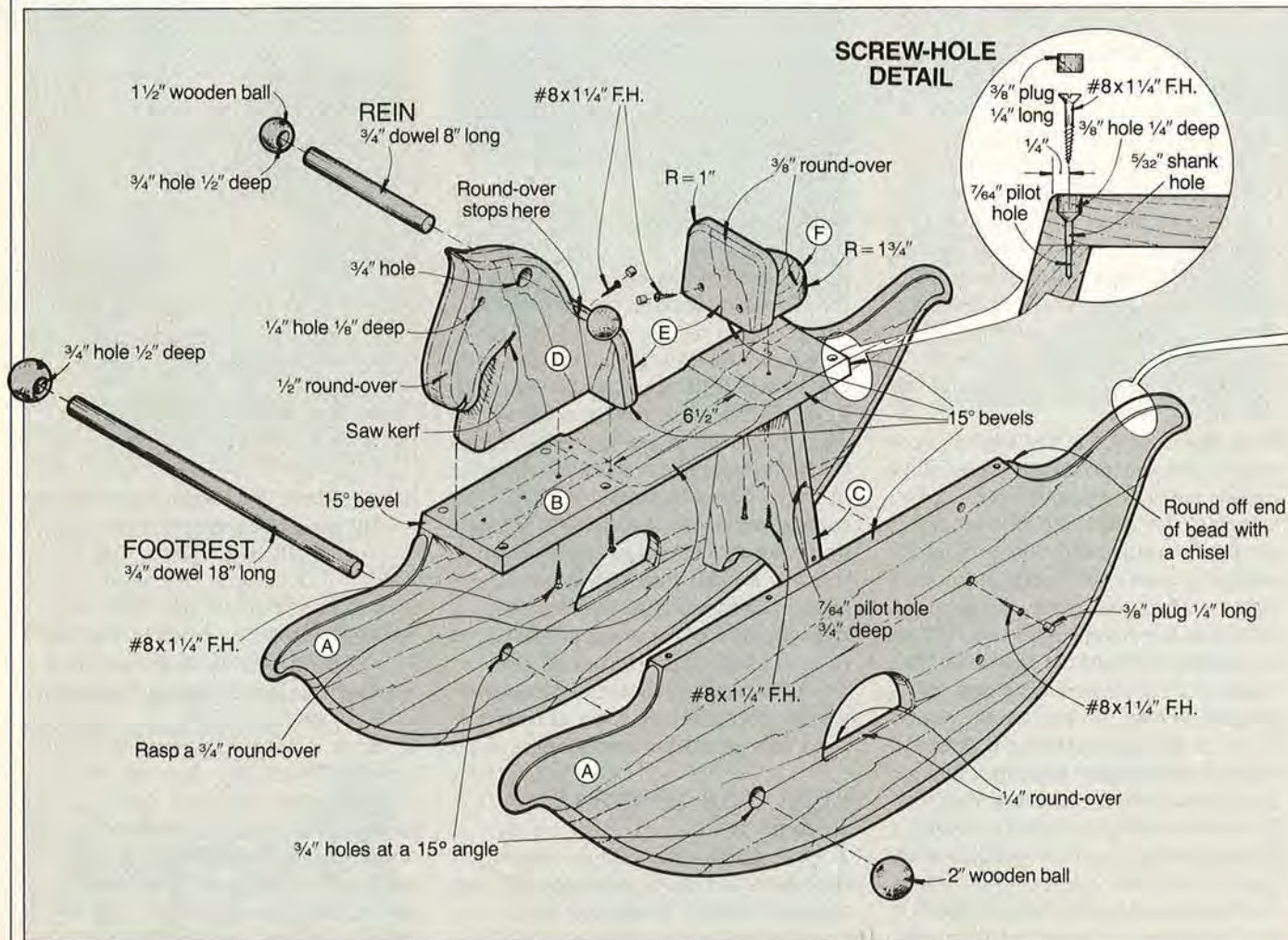

edges smooth. Using a table-mounted router with a $\frac{3}{8}$ " round-over bit, rout the top and side edges of the saddle pieces that will face the rider. (To make sure we routed the correct edges, we held the pieces in place on the body and marked the edges to be routed.)

5 Dry-clip the front saddle piece to the horse's head, with the bottom edges flush. Make a mark on the head where the top edge of the saddle intersects it. Drill three mounting holes through the saddle piece and into the head to the sizes shown in the Screw-Hole Detail. Separate the pieces and rout the edges of the head using a $\frac{1}{2}$ " round-over bit where shown in the Exploded-View Drawing. Use a chisel to complete the round-over where the jaw meets the neck.

6 Glue and screw the front saddle piece to the head, then dry-clip the head assembly to the body. Using the same bit combination used earlier, drill and counterbore three screw holes through the seat and into the head. Glue and screw the head assembly in place.

7 Drill the mounting holes, then glue and screw the remaining saddle piece (E) to (F). Now, glue and screw this assembly to the seat leaving $6\frac{1}{2}$ " between it and the front saddle piece.

8 Drill a $\frac{3}{4}$ " hole $\frac{1}{2}$ " deep in each of the four wooden balls to accept the footrest and rein dowels. (To hold the balls steady while drilling, we bored a 1" hole through a piece of $\frac{3}{4}$ " scrap. Then, we set each ball, end grain up, in the hole, and clamped it in a handscrew. Finally,

we clamped the assembly to our drill press table as shown in the photo below.

9 Cut the $\frac{3}{4}$ " footrest and rein dowels to length (18" and 8" respectively). Then, insert the dowels to within $\frac{3}{4}$ " of their final centered position. Spread glue all the way around the dowel and push each dowel into position. Glue the 2" wooden balls onto the ends of the footrest dowel and the $1\frac{1}{2}$ " balls onto the ends of the rein.

10 Rasp a $\frac{3}{4}$ " round-over on the seat edges between the saddle pieces (E). Sand both of the round-overs smooth.

11 Finish-sand the entire horse, paying particular attention to the contours of the head. Apply several coats of finish, rubbing lightly with steel wool between coats.

BEAD DETAIL

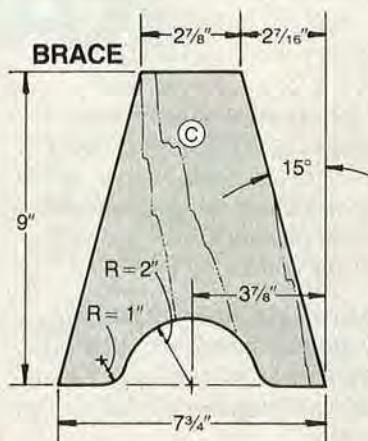
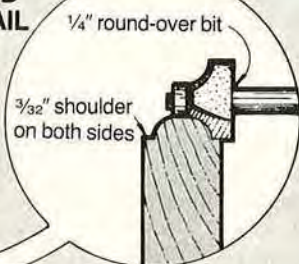

Bill of Materials

Part	Finished Size*			Material	Qty.
	T	W	L		
A*	$\frac{3}{4}$ "	$11\frac{1}{2}$ "	36"	cherry (edge joined)	2
B*	$\frac{3}{4}$ "	$4\frac{5}{8}$ "	$18\frac{3}{4}$ "	cherry	1
C*	$\frac{3}{4}$ "	$7\frac{3}{4}$ "	9"	cherry	1
D*	$1\frac{1}{2}$ "	8"	9"	cherry (laminated)	1
E	$\frac{3}{4}$ "	4"	$3\frac{1}{4}$ "	cherry	2
F	$\frac{3}{4}$ "	$3\frac{1}{2}$ "	3"	cherry	1

*Parts marked with an * are cut larger initially, then trimmed to finished size. Please read the instructions before cutting.

Supplies: double-faced tape, #8x $1\frac{1}{4}$ " flathead wood screws, 1" brads, paper for drawing grids, $\frac{3}{4}$ " birch dowel, spray adhesive, finish, #0000 steel wool

HEAD GRID Each square = 1"

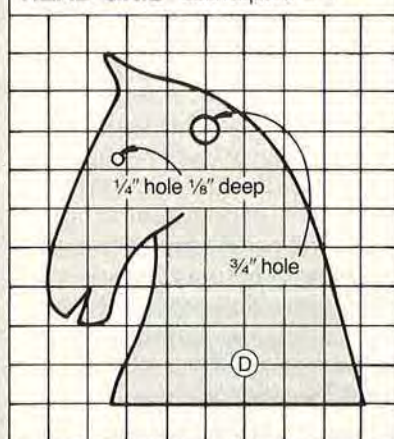

BUYING GUIDE

• **Wooden balls.** $1\frac{1}{2}$ " birch balls, catalog no. 46, \$.60 each. 2" birch balls, catalog no. 48, \$1.20 each. Plus \$1.95 shipping. Cherry Tree Toys, Inc., Box 369-9, Belmont, OH 43718, or call 614/484-4363. ♣

Project Design: Kim Downing
Photographs: Hopkins Associates;
Craig Anderson



OAK MAGAZINE RACK WITH A TWIST



Looking for a project to test your skills in joinery? This magazine rack features a center-lap joint that not only crosses at an oblique angle, but is tapered to boot! It begs to be cut by hand, and we'll show you how.



Note: You'll need some 1/2" oak for this project. You can either resaw or plane thicker stock to the correct thickness or special-order it. See the Buying Guide on page 69 for our source.

FORMING THE END PANELS

1 Cut the end panels (A) to a rectangular size of 10x12". (We edge-joined three boards for each end.)

2 Using double-faced tape, stick the two end panels together, with the best faces facing out and the edges flush.

3 Draw a 1" grid pattern measuring 10x12" on a piece of paper. Using the right half of the End-Panel Half Grid as a guide, mark the points where the end-panel outline crosses each grid line to lay out the end panel on the gridded paper. Fold the paper in half and cut it to shape. Unfold the paper and lay out the screw-hole locations.

4 Apply spray adhesive to the back of the gridded paper, and stick it to

the face of one of the end panels. Cut slightly outside the marked outline with a band saw, then belt-sand the edges of both end panels to the line for the finished shape.

5 With the ends still taped together, drill 5/64" shank holes where marked, drilling completely through both end panels. (We placed a scrap board under the ends to keep chip-out at a minimum.)

6 Using the 5/64" shank holes as guides, counterbore 3/8" holes 1/4" deep for the plugs on each end panel (see the Screw-Hole Detail on the Exploded-View Drawing). Now, separate the end panels, and remove the double-faced tape. Then, rout a 3/16" round-over on all edges of both end panels.

CUTTING THE HANDLE, DIVIDER, BOTTOM, AND LOWER RAILS

Note: Parts B, C, D, E, and F are joined to the end panels using

Text continued on page 68

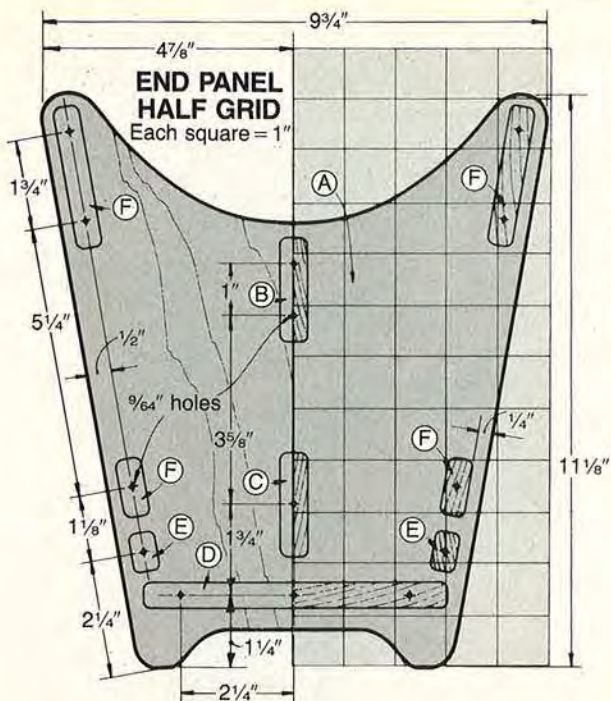

Cutting Diagram

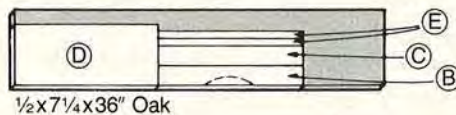

Bill of Materials					
Part	Finished Size*			Material	Qty.
	T	W	L		
A*	3/4"	9 3/4"	11 1/8"	oak	2
B	1/2"	2"	14"	oak	1
C	1/2"	2"	14"	oak	1
D	1/2"	6"	14"	oak	1
E	1/2"	3/4"	14"	oak	2
F*	1/2"	see grid drawing		oak	4

*Parts marked with an * are cut larger initially, then trimmed to finished size. Please read the instructions before cutting.

Supplies: paper for drawing grid, #6x1 1/4" flathead wood screws, double-faced tape, spray adhesive, stain, finish

SCREW-HOLE DETAIL

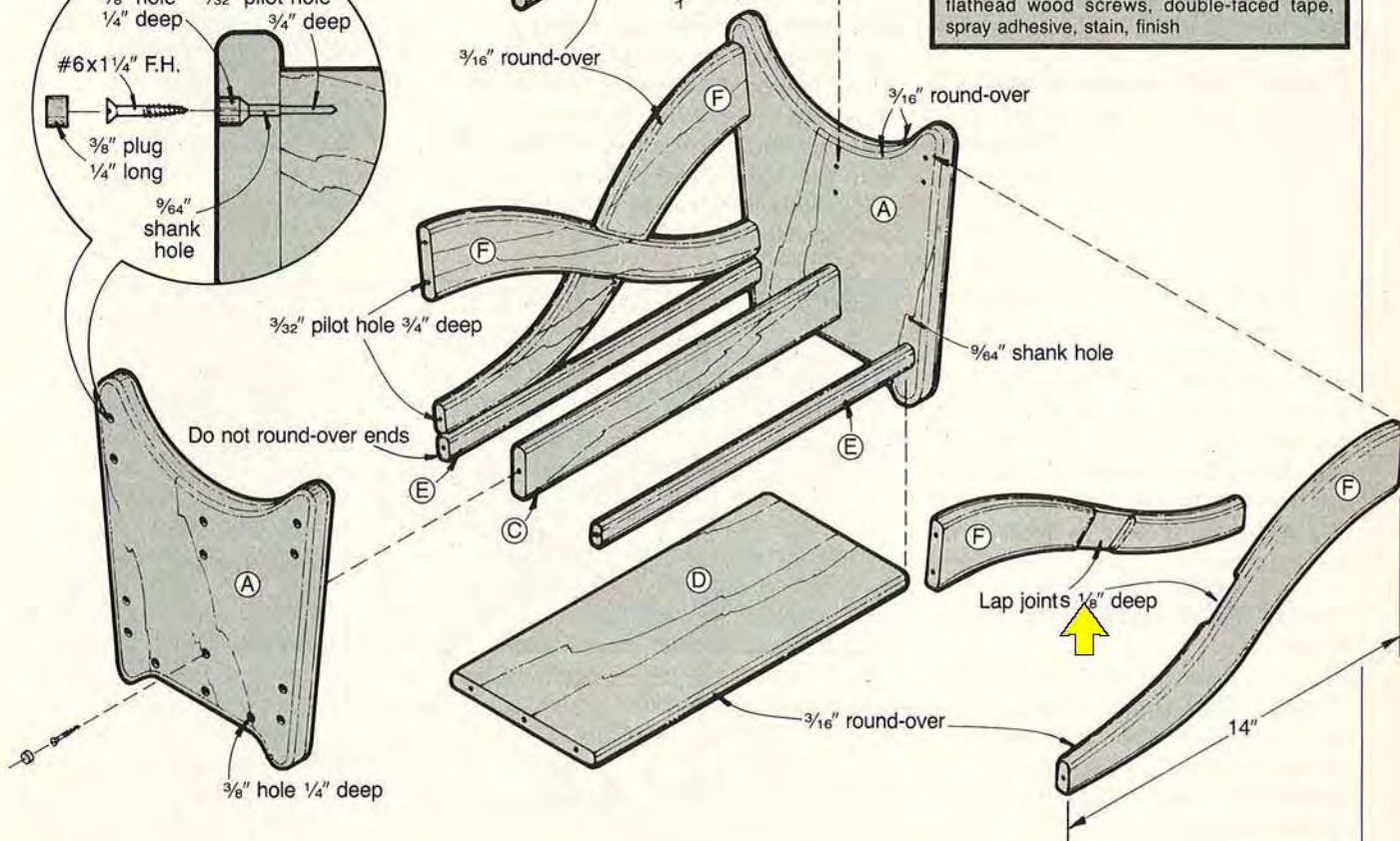
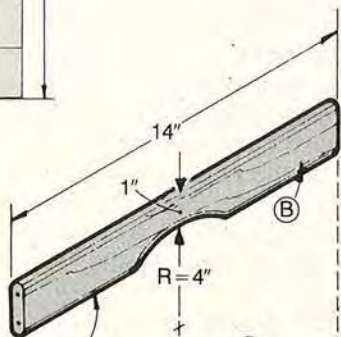
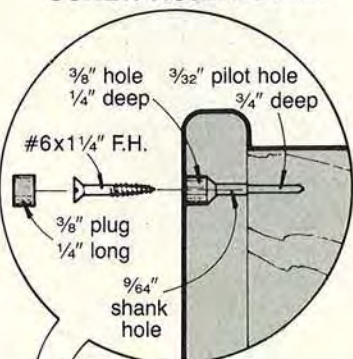

Continued

OAK MAGAZINE RACK

glued butt joints reinforced with wood screws. For a proper fit, make sure you cut all these parts to the same length.

1 Cut the handle (B), divider (C), bottom (D), and lower rails (E) to the sizes listed in the Bill of Materials from $\frac{1}{2}$ " oak. (We ripped all the pieces first. Then, we set a stop 14" from the blade of our radial arm saw to ensure a consistent length.) Cut the center-radiused hand grip in the handle where shown on the Exploded-View Drawing on the previous page.

2 Locate the center of each end of the divider, bottom, and both lower rails, then drill a $\frac{3}{32}$ " pilot hole $\frac{3}{4}$ " deep in each. Locate and drill *one* $\frac{3}{32}$ " hole in each end of the handle (the second hole on each end of the handle will be drilled later).

3 Route a $\frac{3}{16}$ " round-over along the edges, but *not* the ends, of the handle, divider, bottom, and both lower rails.

4 Make a trial assembly of the parts by screwing the handle, divider, bottom, and both lower rails between the end panels. Do *not* use glue.

5 Using a straightedge, align the handle with the divider. Using the $\frac{5}{64}$ " shank holes previously drilled in the end panels as guides, drill the second set of $\frac{3}{32}$ " holes in the handle ends. Square the bottom piece with the divider and handle, and drill the second set of holes in the bottom. Set the assembly aside. You will need it later to determine the length of the curved rails (F).

FASHIONING THE CURVED RAILS

1 Cut four pieces of $\frac{1}{2}$ " oak 4x17". With a ruler and straightedge, lay out 1" squares to form a pattern measuring 4x17". Using the Curved-Rail Grid as a guide, mark the points where the curved-rail outline crosses each grid line. Use

a thin flexible scrap of wood to connect the points to form the curved lines. Use spray adhesive on the back of the pattern to attach it to one of the curved-rail blanks (F).

2 With the edges and ends flush, stick the four curved-rail pieces together with double-faced tape.

3 Set your radial arm or table saw to cut 22° right of center, and trim the ends of the taped-together boards. Cut the curved rails to shape. Now, sand the edges of the rails (but not ends) smooth. Remove the gridded paper.

4 Clamp the taped-together rails in a woodworker's vise with the narrow ends up and level. Drill a $\frac{3}{32}$ " pilot hole $\frac{3}{4}$ " deep, centered into the narrow end of each curved rail. Pull the rails apart and remove the tape. Then, rout a $\frac{3}{16}$ " round-over along the edges, but *not* the ends of each curved rail.

5 To lay out the lap joint on the rails, start by clamping a framing square in your woodworker's vise. Then, position the paired rails as shown in the drawing *below* so that one end of each pair is *flush* with the square, and opposite ends are exactly 14" apart. (Trim the curved rails at 22° if they are a

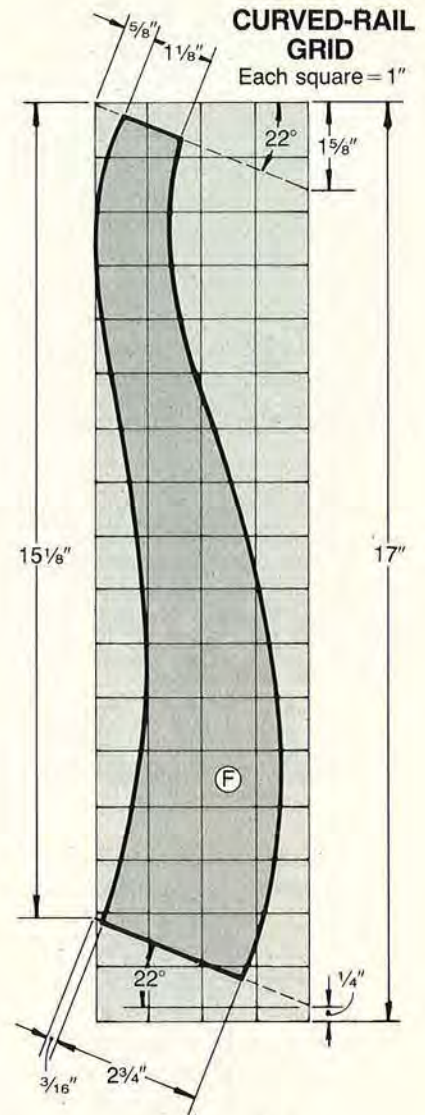

LAYING OUT THE LAP JOINTS

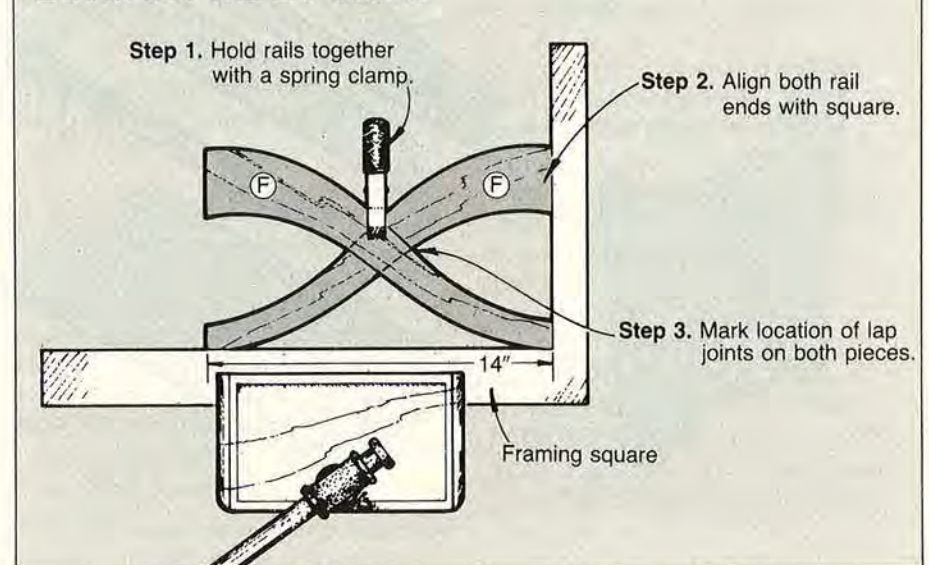



bit too long. If they are too short, trim B, C, D, and E.) Use a spring clamp to hold the paired rails together when you have them properly aligned.

6 Use a sharp pencil to mark both curved rails where they overlap. Then, separate the rails, and repeat for the other pair, keeping the paired rails together. To mark the depth of cut needed for each lap joint, measure and mark a line $\frac{1}{8}$ " from the face on each curved rail (we used a combination square and sharp pencil for this).

7 As shown in the photo *above*, make the first two cuts $\frac{1}{8}$ " deep on the *inside* of the marked lap-joint lines. Then, cut several more kerfs between the first two (the closer the kerfs, the easier the waste is to chisel out in the next step).

8 Chisel the waste between the lap lines, as shown in the photo in the upper right-hand corner. (You could also use a router fitted with a straight bit to make the recess.) Finish by taking finer cuts with the chisel, and touch up with a rasp if necessary. Test-fit the pieces.

9 Glue both pairs of curved rails together, again using the framing square to align the ends of the rail pairs. Now, before the glue on the curved rails sets, clamp them in position, centering the bottom ends over the $\frac{9}{64}$ " shank holes drilled earlier in the end panels. Screw the bottom end of each curved rail to the end panel, using spring clamps to hold them together at the lap joints. Using the shank holes in the end panels as guides, drill a pair of $\frac{3}{32}$ " holes in the upper ends of each curved rail.

FINAL ASSEMBLY

1 Disassemble the rack by removing the screws. Sand all the pieces smooth: It's too difficult to finish-sand all the pieces when the rack is assembled.

2 Glue and screw all the parts to one end panel. (We applied a coat of glue to the end grain, waited a minute and added a bit more). When one end of the assembly is completed, attach the opposite end panel in the same manner. Scrape off all excess glue once a tough skin has formed, being careful not to mar the sanded surfaces.

3 With a $\frac{3}{8}$ " plug cutter, cut $\frac{5}{16}$ "-long oak plugs. (We planed down a scrap piece of the $\frac{1}{2}$ " oak to $\frac{5}{16}$ ". Then, we chucked the plug cutter in our drill press and clamped the scrap to the table and proceeded to cut the plugs.) Glue the plugs in place with the grain of the plugs running the same direction as the grain of the end panels. Sand the plugs flush.

4 Sand all surfaces smooth. Apply the stain and finish of your choice to the magazine rack.

BUYING GUIDE

- **$\frac{1}{2}$ " oak.** $\frac{1}{2}$ x $7\frac{1}{4}$ x48" oak (1 piece needed), catalog no. 5LU275, \$17. $\frac{1}{2}$ x $7\frac{1}{4}$ x72" oak (1 piece needed), catalog no. 5LU276, \$25.50. Constantine, 2050 Eastchester Rd., Bronx, NY 10461, or phone 212/792-1600.
- **$\frac{3}{16}$ " round-over bit.** Router bit with ball-bearing guide, $\frac{1}{4}$ " shank. Catalog no. RO4316, \$19.97. Woodcraft Tools USA, P.O. Box 60906, Sacramento, CA 95860, or call 916/363-9428. ♣

Project Design: Jay Taylor
Photographs: Hopkins Associates; Bob Calmer
Illustrations: Kim Downing; Bill Zaun

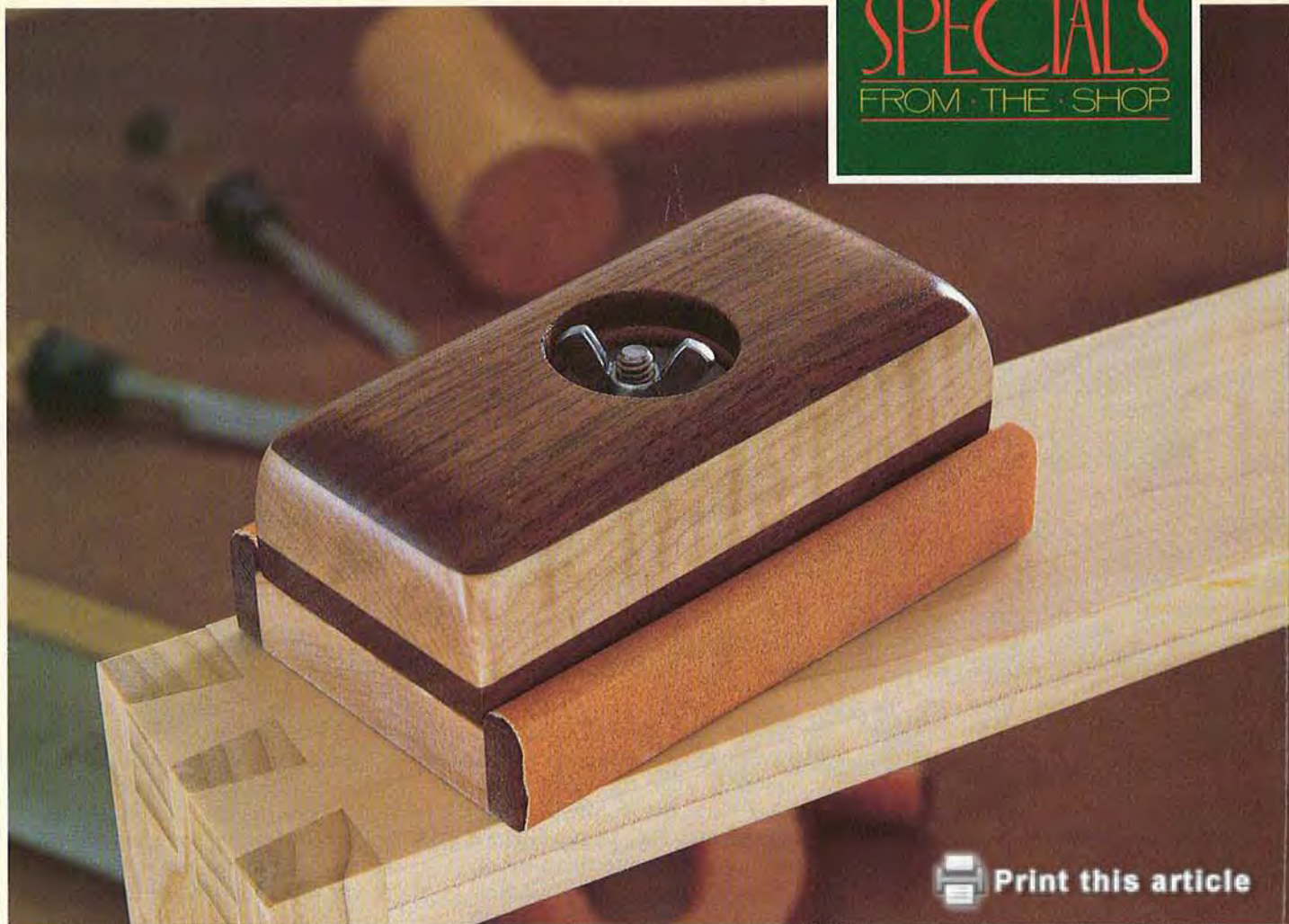

Print this article

**Collector's Edition*

SANDING BLOCK

The idea comes from **WOOD** subscriber M. C. "Morrie" Patten of Mesa, Arizona, who makes his laminations long enough to yield at least two sanding blocks at a time. That way, they're easier to machine, and he has several to present to his woodworking buddies. We were so impressed with Morrie's idea, we decided to make a couple of these beauties for our own shop and share his idea with you.

MAKING THE SANDING BLOCK BASES

1 Rip and crosscut a piece of $\frac{3}{4}$ " maple to $2\frac{1}{4}$ x 10" long, enough for two bases (A). Now, joint, resaw, or hand-plane the maple to $\frac{5}{8}$ " thickness.

2 Rip two strips of walnut $\frac{1}{4}$ " wide from the edge of a piece of $\frac{3}{4}$ " stock. Crosscut each to 10" for the sides (B).

3 Glue and clamp one walnut strip to each edge of the maple, with the *bottom* edges flush. Scrape off any glue squeeze-out.

4 Crosscut two $4\frac{1}{2}$ "-long bases from the lamination.

THE PALM GRIPS COME NEXT

1 Start by cutting one piece of $\frac{3}{4}$ " maple (C) and one piece of $\frac{3}{4}$ " walnut (D) to $2\frac{1}{4}$ x 10" long. Using a band saw or table saw, resaw the walnut into two pieces just under $\frac{3}{8}$ " thick each.

2 Glue and clamp the maple between the two pieces of walnut, sandwich-fashion, making sure that all edges align exactly.

3 Remove the clamps and scrape off any excess glue. Then, joint or plane the walnut top and bottom pieces to a finished thickness of $\frac{1}{4}$ " each. Now, joint or plane the edges until the palm grip fits snugly

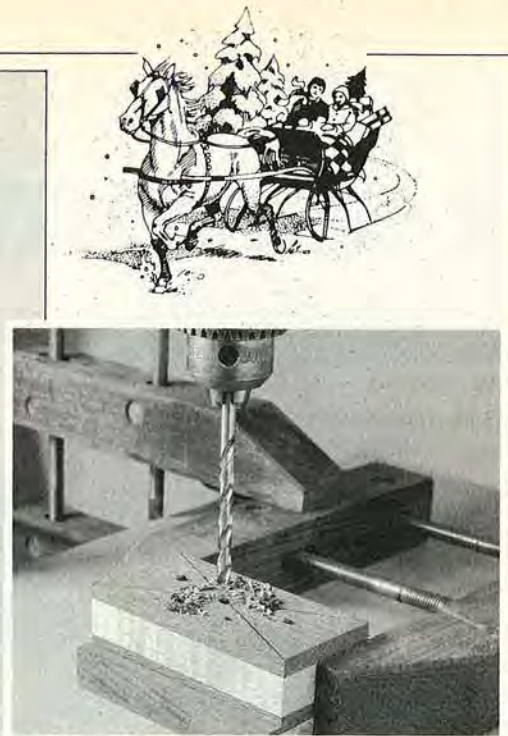
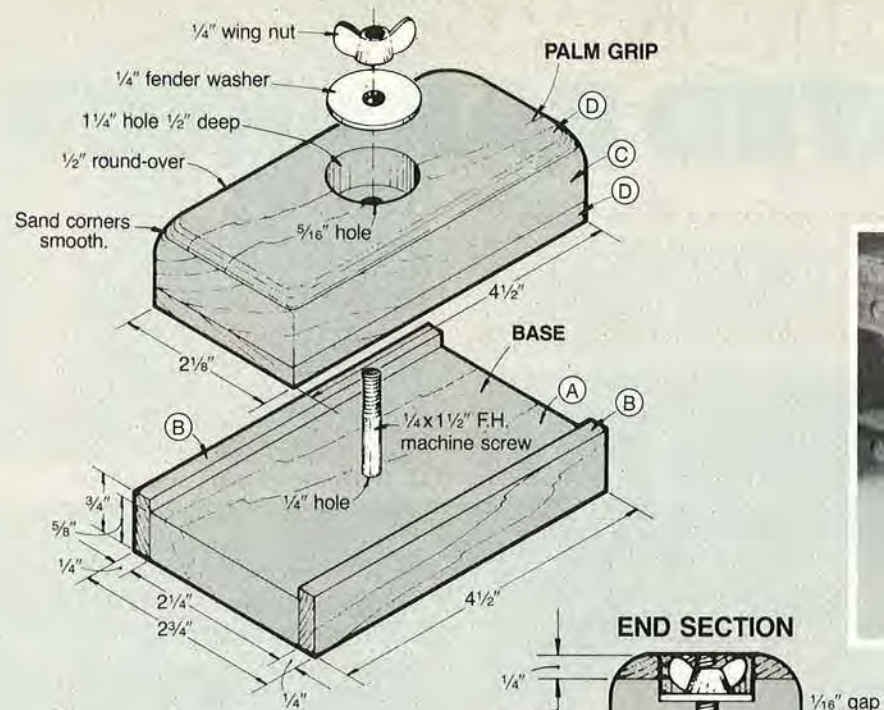

Bill of Materials					
Part	Finished Size* For One Sanding Block			Material	Qty.
	T	W	L		
A*	5/8"	2 1/4"	4 1/2"	maple	1
B*	3/4"	1/4"	4 1/2"	walnut	2
C*	3/4"	2 1/8"	4 1/2"	maple	1
D*	1/4"	2 1/8"	4 1/2"	walnut	2

*Parts marked with an * are cut larger initially, then trimmed to finished size. Please read the instructions before cutting.

Supplies: 1/4 x 1 1/2" flathead machine screw with fender washer and wing nut, epoxy, felt (optional), finish

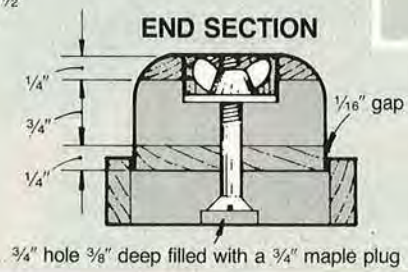

between the protruding walnut sides of the base (you'll sand the palm grip to finished width later).

4 Crosscut the palm-grip lamination into two 4 1/2" lengths.

DRILLING THE BOLT AND WING NUT HOLES

1 Mark diagonals on the top of each palm grip to locate its center, position the palm grip in the base with the ends flush. Clamp the palm grip and base to your drill-press table, and drill a 1/8" guide hole through both pieces as shown in the photo, upper right. (For this and the following steps, we

machined both sanding block pieces at once.)

2 Separate the two pieces, and, using a flat-bottomed bit, drill a 1 1/4" hole 1/2" deep into the top of the palm grip, centered over the guide hole (see drawings for hole size details). Then, drill and countersink a 3/4" hole 3/8" deep centered over the guide hole on the bottom side of the base.

3 Drill a 1/4" hole through the base and a 5/16" hole through the palm grip, centering both holes on the guide hole. Countersink the 1/4" hole on the bottom side of the base.

4 Hand-plane or sand 1/16" off each side (not the ends) of the palm grip for a 2 1/8" finished width.

5 Clamp the base, bottom up, in a woodworker's vise. Thread a 1/4 x 1 1/2" machine screw through the hole and tighten the palm grip to the base with a wing nut. Epoxy the screw in the hole in the base.

Cut a 3/4" maple plug, and epoxy it over the head of the screw.

6 Detach the base from the palm grip, and sand the plug flush with the base. Sand the base smooth.

7 Fit your table-mounted router with a 1/2" round-over bit, and rout the top edges of the palm grip. Finally, sand the palm grip to fit comfortably in your hand.

8 You may want to cut and glue a piece of felt to the bottom of one or all of the sanding blocks for sanding pieces with slight contours. Trim the edges of the felt flush with the base.

FINAL ASSEMBLY AND FINISHING

1 Fit a fender washer in the hole in the palm grip. Then, apply the finish of your choice to the base and palm grip.

2 To use, slip the palm grip over the bolt on the base, and just start the wing nut. Quarter a standard sheet of sandpaper, and tuck the sides under the palm grip. Now, tighten the wing nut to hold the sandpaper firmly in position. 🐿

Project Design: M. C. "Morrie" Patten
Photographs: Bob Calmer
Illustration: Bill Zaun

HIGH FASHION LAMINATED EARRINGS



Print this article

Here's your chance to be creative and to impress that special lady at the same time. You can make any number of interesting designs from one laminated blank. If you like small-scale, quick-to-make projects, you're gonna love this one.

Note: You'll need some thin stock for this project. You can either resaw or plane thicker stock to the correct thickness or special-order it. See the Buying Guide on the opposite page for our source of thin stock and other supplies and tools.

MAKING UP THE LAMINATED BLANK

1 Crosscut $\frac{1}{8}$ "-thick pieces of walnut (A), maple (B), and bubinga (C) — or any combination of woods you choose — to 6" long each. Rip the walnut to 1", the maple to $\frac{1}{2}$ ", and the bubinga to $\frac{3}{8}$ ". (We ripped ours on the band saw.)

2 To clamp the pieces together, start by drawing a straight line across a piece of $\frac{3}{4}$ " plywood. Cover the plywood with waxed paper, and drive several small 1" nails about $\frac{1}{2}$ " deep along the marked pencil line.

3 With one edge of the walnut against the nails, glue the maple to

the walnut. Pinch the two pieces together, and drive nails along the edge of the maple to "clamp" the pieces as shown in the photo below. After the glue dries, pull the



nails, and scrape off any excess glue. Rip the maple to finished width ($\frac{1}{16}$ "); plane the edge, if necessary. (We ripped ours to $\frac{1}{8}$ " on the band saw, and hand-planed it down to $\frac{1}{16}$ ".) Glue the bubinga to the maple using the same clamping technique as before.

4 Remove the nails, lamination, and waxed paper from the plywood. Place several strips of double-faced tape on the plywood to hold the thin strips stationary. Now, stick the lamination to the tape, and sand both surfaces smooth.

SHAPING AND FINISHING THE EARRINGS

1 Using carbon paper, transfer the shape of the full-sized earring pattern(s) shown below to cardboard. Cut the template(s) to shape.

2 Cut the lamination into two 3"-long pieces, and use double-faced tape to stick the two pieces together, one on top of the other. Now, using the template(s), trace the earring pattern(s) onto the stock. Cut the earrings to shape using a scroll saw or a band saw.

3 With the earring still taped together, sand the edges flush.

4 As shown in the photo below, clamp the taped earring pairs in a small handscrew, and secure a #64



Bill of Materials					
Part	For One Earring Blank			Material	Qty.
	T	W	L		
A	$\frac{1}{8}$ "	1"	6"	walnut	1
B	$\frac{1}{8}$ "	$\frac{1}{16}$ "	6"	maple	1
C	$\frac{1}{8}$ "	$\frac{3}{8}$ "	6"	bubinga	1

Supplies: waxed paper, 1" nails, epoxy, double-faced tape, #0000 steel wool, finish, paste wax

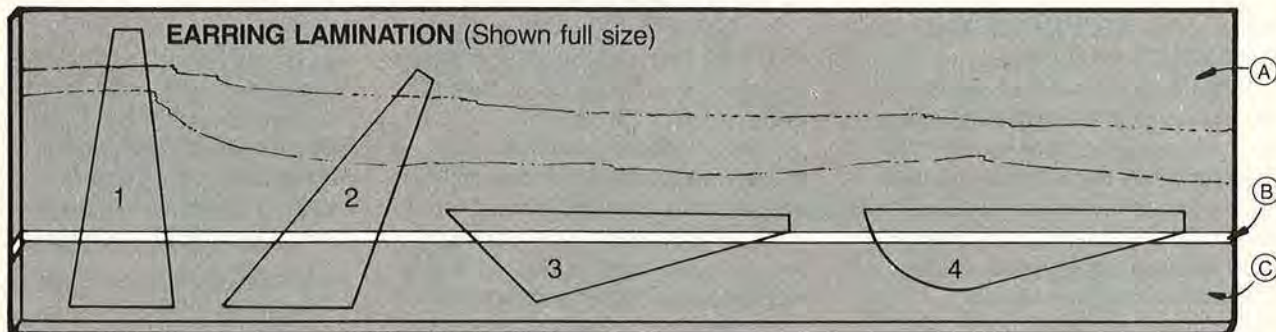

(.036") wire size drill bit (see Buying Guide) in a miniature chuck. Now, mount the miniature chuck and bit into your drill-press chuck, and drill the eye-pin holes 1/2" deep in the earrings. Caution: *Drill the holes carefully.* The bits bend easily and can break.

5 Remove the earrings from the handscrew, and separate them. Carefully peel off the tape, and then finish-sand each earring.

6 Before gluing the shafts of the eye pins into the earrings, determine which way the opening of each eye pin should face. For the earring to hang correctly, the fish hook or post may require that the loop of the eye pin (as shown in the drawing *below*) be parallel with the flat surface of the earring.



7 Use a wire cutter to cut the eye-pin shafts to length (the shaft of the eye pin should slide far enough into the hole so that the loop is just next to the top of the earring). Mix the epoxy, and dip the shaft of the eye pin into it. Insert the eye-pin shaft into the hole in the earring. Immediately, wipe off any excess epoxy.

8 Spray or wipe on the finish. Rub gently between coats with steel wool.

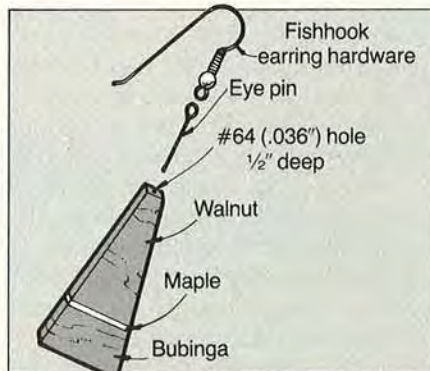

9 Hold a pair of earrings side by side (see the Pair-of-Earrings Drawing) to determine which way the fishhook hardware or posts should be attached (this applies to designs 2, 3, and 4). Use small needle-nose pliers to open the loop of each eye pin. Thread the opened loop through the loop of each fishhook or post. Squeeze the eye-pin loop closed.

BUYING GUIDE

● **Thin stock.** 1/8" bird's-eye maple, catalog no. W9102, order one square foot for \$2.95. 1/8" bubinga, catalog no. W9041, order one square foot for \$3.50. 1/8" walnut, 5 1/2 x 18", catalog no. W4601, order one piece for \$3.36. Include \$2.95 for shipping and handling. Craftsman Wood Service Company, 1735 W. Cortland Ct., Addison, IL 60101, or call 312/629-3100.

● **Drill bits and chuck.** Six #64 (.036") drill bits, catalog no. 15170, \$5.95. Miniature adapter chuck for your drill chuck, catalog no. 26107, \$5.95. Micro-Mark, Box 5112-272, Clinton, NJ 08809, or call 800/225-1066 to order.

● **Miniature pliers.** Extra fine needle nose with serrated jaws. 4 7/8" long. Catalog no. 29103, \$12.95. Micro-Mark, address above.

● **Epoxy.** Two-part epoxy, sets in 8 minutes. Two 3-fl.-oz. tubes, catalog no. 15202, \$8.95. Micro-Mark, address above.

● **Earring parts.** 3/4" eye pins, gold finish, catalog no. 455-11, 30 pieces, 59 cents. Fishhook earring hardware, gold finish, catalog no. 455-78, four pieces, 89 cents. Gold-filled posts, one pair, catalog no. 451-91, 89 cents. Mangelsen's, 3457 South 84th St., Omaha, NE 68124, or call 402/391-6225. 🌲

Project Design: James R. Downing
 Photographs: Hopkins Associates;
 Bob Calmer





all Aboard

 [Print this article](#)

PLAYTIME EXPRESS

Looking for just the right gift for a favorite youngster? If so, you've just struck it rich because this pint-sized plaything will soon be one of that child's favorite possessions. We scaled down the size of the locomotive and cars so that even toddlers can maneuver them easily. And because young "engineers" can sometimes get overly energetic when operating trains, we designed the project to stand up to plenty of playful abuse.



Note: You'll need some thin stock for this project. You can either resaw or plane thicker stock to the correct thickness or special-order it. See the Buying Guide on page 79 for our source.

START WITH THE LOCOMOTIVE

1 To make the locomotive chassis (A), cut $\frac{3}{4}$ " maple to the size listed in the Bill of Materials. Then, drill a $\frac{3}{32}$ " pilot hole $\frac{1}{4}$ " deep and $\frac{1}{4}$ " from one end for the coupler screw where shown in the Locomotive Exploded-View Drawing.

2 To form the boiler (B), cut two pieces of $\frac{3}{4}$ " maple to $1\frac{1}{2} \times 12$ ". Glue and clamp them face to face, with the edges flush. Later, sand the block smooth, and use your router table to rout a $\frac{3}{8}$ " round-over along the first 3" of the top two edges. Cut a $2\frac{5}{8}$ " piece from the rounded-over portion of the block, and set aside the remainder for the passenger car and caboose. Now, glue and clamp the boiler flush with the front of the chassis and centered from side to side.

3 Cut the boiler front plate (C) to $2 \times 2\frac{1}{2}$ " from $\frac{1}{2}$ " maple stock. Cut $\frac{1}{2}$ " radii on the top two corners. Sand the boiler front plate smooth,

and glue it to the front of the chassis and boiler.

4 Using $\frac{3}{8}$ " maple, cut the two sides (D), the front (E), and the bottom (F) of the cab to size. Drill a $1\frac{1}{4}$ " "window" in each side where shown in the Side-View Drawing. Then, glue all the cab pieces together as shown in the locomotive Exploded-View Drawing. Sand the edges smooth, and glue the cab to the chassis, directly behind the boiler.

5 Drill a $\frac{3}{8}$ " hole $\frac{1}{2}$ " deep 1" back from the front end of the boiler for the smokestack dowel. Next, mark the location of the three axle holes with a center punch or a 6d nail (see the Side-View Drawing for placement). Then, *carefully* drill a $\frac{9}{32}$ " hole all the way through the chassis (the indentation will help prevent the bit from wandering when you start the hole).

6 Cut a piece of $\frac{1}{2}$ " walnut to $2\frac{1}{2} \times 10$ " for the roof (G). Then, cut a 45° bevel along one end, and cut the roof to finished length ($3\frac{1}{4}$ "). Glue the roof to the top of the cab (it should overlap the front by $\frac{1}{4}$ " and each side by $\frac{3}{8}$ ").

7 To form the cowcatcher (H), start by cutting ten pieces of $\frac{1}{4}$ "-thick maple to $2\frac{1}{4} \times 10$ ". Laminate them face to face, removing any squeeze-

H·O·L·I·D·A·Y
SPECIALS
 FROM THE SHOP

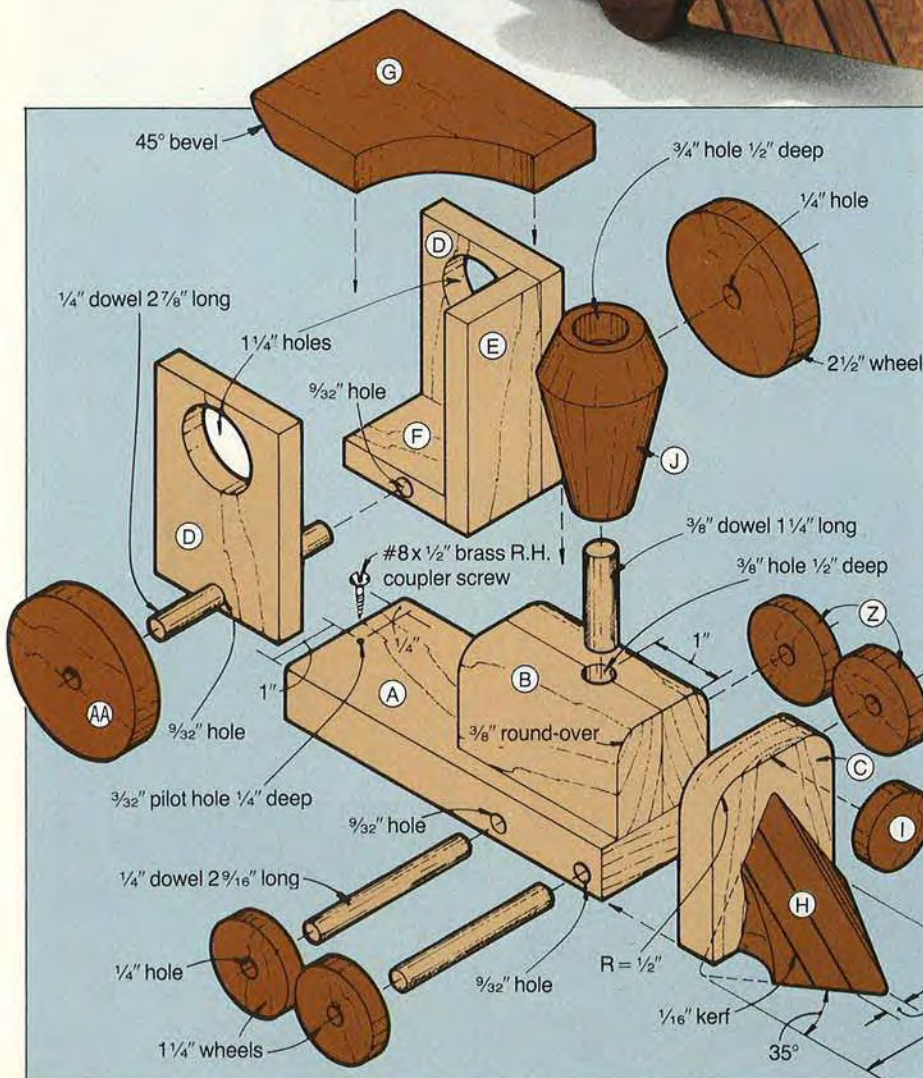

Bill of Materials

Part	Finished Size*			Material	Qty.
	T	W	L		
Locomotive					
A	3/4"	2"	5 1/4"	maple	1
B*	1 1/2"	1 1/2"	2 5/8"	maple (laminated)	1
C	1/2"	2"	2 1/2"	maple	1
D	3/8"	2"	3"	maple	2
E	3/8"	1 1/4"	3"	maple	1
F	3/8"	1 1/4"	1 5/8"	maple	1
G*	1/2"	2 1/2"	3 1/4"	walnut	1
H*	2"	2 1/2"	2"	maple (laminated)	1
I	1/4"	1" diameter		walnut	1
J*	1 1/2" diameter	2"		walnut (laminated)	1

*Parts marked with an * are cut larger initially, then trimmed to finished size. Please read the instructions before cutting.

Supplies: masking tape, double-faced tape, tracing paper, #8 x 1/2" roundhead brass wood screws, 3/16" brass flat washers, 1/4" dowel, 3/8" dowel, nontoxic finish, 1/2 x 36" strip of tooling leather

Continued

PLAYTIME EXPRESS

out after it forms a tough skin. Plane or sand the edges smooth.

8 Referring to the three-step drawing below, follow steps 1 and 2 to shape the front of the cowcatcher.

Next, clamp the stock in a vise, with the beveled end up, and sand the beveled surfaces smooth. Cut $\frac{1}{16}$ "-deep accent kerfs with a fine-toothed handsaw along the glue joints on the front of the cowcatcher. Then, follow step 3 to cut the part to its 2" finished length.

Glue the cowcatcher in place, centered on the boiler front plate and flush with the bottom of the chassis.

9 Make the headlight (I) by cutting a 1"-diameter plug from $\frac{1}{4}$ " walnut scrap. If you don't have a plug cutter, rough-cut the part with a band saw or scroll saw, and sand the edges smooth. Glue the headlight to the boiler plate, centered over the cowcatcher and extending $\frac{1}{2}$ " above the top edge of the boiler plate.

THE SMOKESTACK COMES NEXT

1 To make the smokestack (J), start by laminating two $\frac{3}{4}$ " x $1\frac{1}{2}$ " x 6" pieces of walnut. Trim the ends square, and draw diagonals on one end to find the center. Now, draw

a $1\frac{1}{2}$ "-diameter circle with a compass on this same end, and clamp the block in your vise. Using the circle as a guide, hand-plane the block to a rough cylinder shape.

2 Crosscut a piece 2" long from this block to make the turning stock for the smokestack. Use a handscrew to secure the block, and bore a $\frac{3}{4}$ " hole $\frac{1}{2}$ " deep in one end (where shown in the

Side-View Drawing). Replace the $\frac{3}{4}$ " bit with a $\frac{3}{8}$ " bit and drill the hole entirely through the block.

3 Pass a $\frac{3}{8}$ " x 3" bolt through the block, with its head inside the $\frac{3}{4}$ " hole, and secure the bolt with a nut. Chuck the protruding end of the bolt in your drill press. (The smokestack will be upside down.)

4 With the drill press running at a medium speed (800-1,000 rpm)

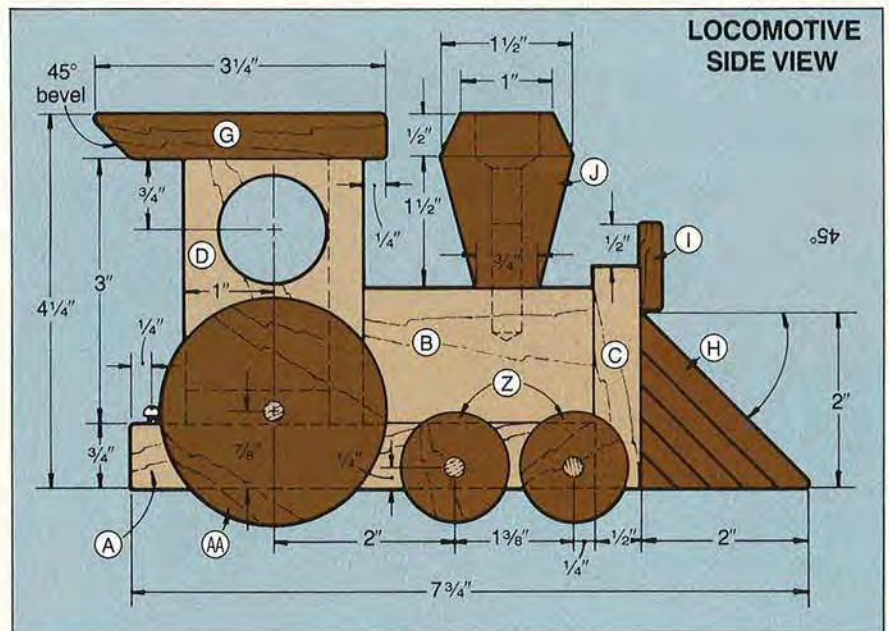

CUTTING THE COWCATCHER

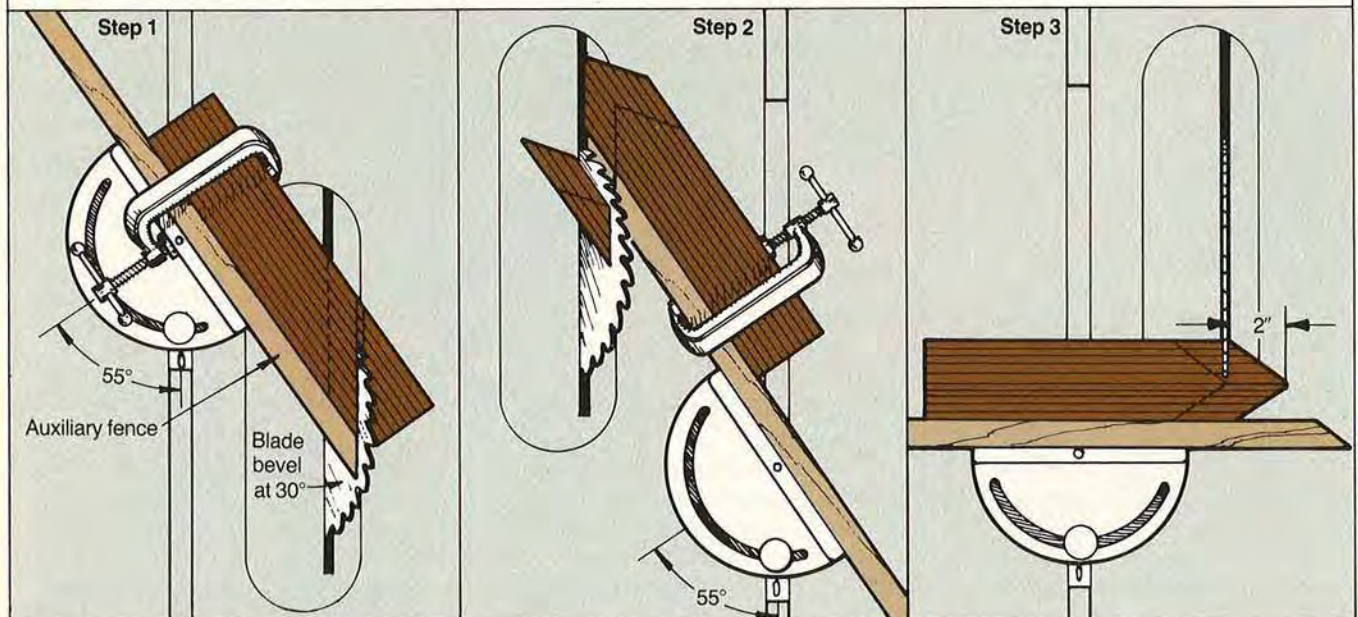

“turn” the wood to shape, using a Surform Plane or wood rasp. Work the tool against the spinning wood as shown in the photo *right*. Shape the smokestack to the dimensions indicated in the Side-View Drawing, and sand it smooth.

5 Remove the smokestack from the drill press. Remove the nut and bolt, and glue the smokestack in place with a $\frac{3}{8} \times 1\frac{1}{4}$ " dowel.



AND NOW FOR THE RAILCARS

1 Rip and crosscut a piece of $\frac{1}{2}$ " maple to $2\frac{1}{2} \times 21$ " for the floors of the coal car, flat car, passenger car, and the caboose. Then, crosscut two pieces (K) to $4\frac{1}{2}$ " and two pieces (L) to 5" from the strip.

2 Attach a piece of masking tape to all floor parts and label them “coal car,” “flat car,” etc. Drill $\frac{3}{32}$ " pilot holes $\frac{1}{4}$ " deep and $\frac{1}{4}$ " from both ends for the coupler screws in the floors (K, L) where shown in the drawings. *Notice* that the front hole for the coupler in the coal car is drilled from the *underside* of the floor.

3 To make the chassis for each car, start by cutting two pieces of $\frac{3}{4}$ " maple to 1×15 " and one piece of $\frac{1}{2}$ " maple to 1×15 ". Glue and clamp the three pieces together face to face with the $\frac{1}{2}$ " strip sandwiched between the $\frac{3}{4}$ " strips. Scrape off the excess glue, and sand or plane the top and bottom surfaces of the lamination smooth. Cut two pieces (M) 3 " long and two pieces (N) $3\frac{1}{2}$ " long from the lamination.

4 Drill a $\frac{3}{32}$ " hole for the wheel axles in each chassis after marking the location of each hole with a center punch.

5 Center each floor over its corresponding chassis (part K to M and part L to N), then glue and clamp the parts together.

6 To construct the coal car, cut the sides (O) and back (P) to the sizes listed in the Bill of Materials. Stick the two sides together face to face using double-faced tape. Use carbon paper to transfer the full-sized side pattern shown *left*, onto the top walnut piece. Cut the

sides to shape, sand the contoured edges, and separate, remove the tape. Glue the sides and back together. Next, center and glue this assembly onto the coal car floor (K).

COAL CAR

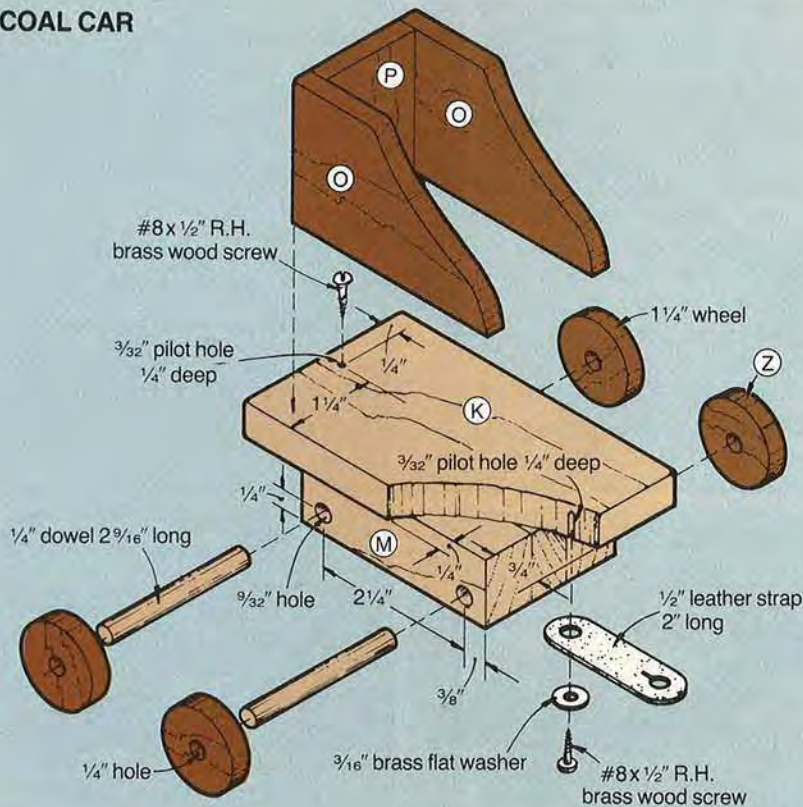

Bill of Materials

Part	Finished Size*			Material	Qty.
	T	W	L		
Coal Car					
K*	$\frac{1}{2}$ "	$2\frac{1}{2}$ "	$4\frac{1}{2}$ "	maple	1
M*	1"	2"	3"	maple (laminated)	1
O	$\frac{1}{4}$ "	2"	$3\frac{1}{2}$ "	walnut	2
P	$\frac{1}{4}$ "	$1\frac{1}{2}$ "	2"	walnut	1

*Parts marked with an * are cut larger initially, then trimmed to finished size. Please read the instructions before cutting.

Supplies: same as locomotive on page 75

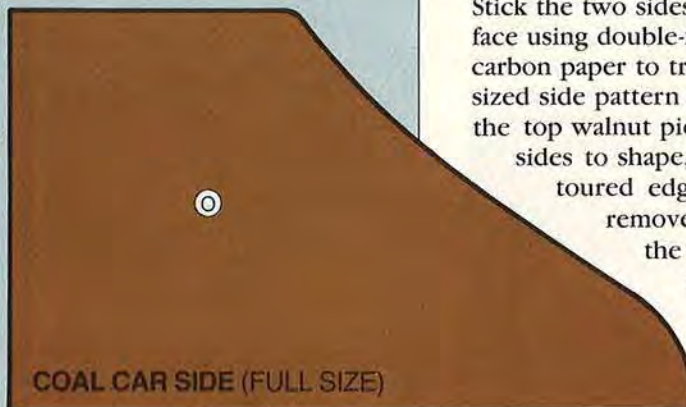

COAL CAR SIDE (FULL SIZE)

PLAYTIME EXPRESS

7 Cut the sides (Q) and end (R) to size for the flat car shown at *right*. Cut the front end of each side to shape, and sand smooth. Center the sides and end over the floor of the car, and glue and clamp them in position.

8 To fashion the passenger car, first cut a $3\frac{3}{4}$ "-long car body (S) from the lamination you made earlier for the boiler. Next, drill the three 1" window holes in it (refer to the Passenger-Car Drawing for correct positioning). Cut the roof (T) to size from $\frac{1}{2}$ " walnut. Cut the cupola (U) to size from $\frac{1}{2}$ " maple. Fit a $\frac{1}{2}$ " beading bit in your table-mounted router, and rout a bead along the top edge of the cupola, using a hand-screw to hold the stock as shown in the photo *below*. Center the car body, roof, and cupola over the floor of the car, and glue and clamp the parts together.

9 For the caboose, cut the car body (V) to size from the remainder of the boiler/passenger car body lamination. Then, drill $\frac{7}{8}$ " "windows" where shown in the Caboose Drawing, *far right*. Cut the parts for the roof (W) and the cupola (X, Y) to the sizes listed in the Bill of Materials. Center, then glue and clamp the car body to the floor. Attach the roof to the body the same way. Then, glue and clamp the cupola to the roof in the position shown in the Caboose Drawing.

10 You'll need to make twenty $1\frac{1}{4}$ " wheels (Z), and two $2\frac{1}{2}$ " wheels (AA) to get this train rolling. If you use a circle cutter like we did (see the Buying Guide at the end of the article for details), first rotate the blade of the circle cutter to make



FLAT CAR

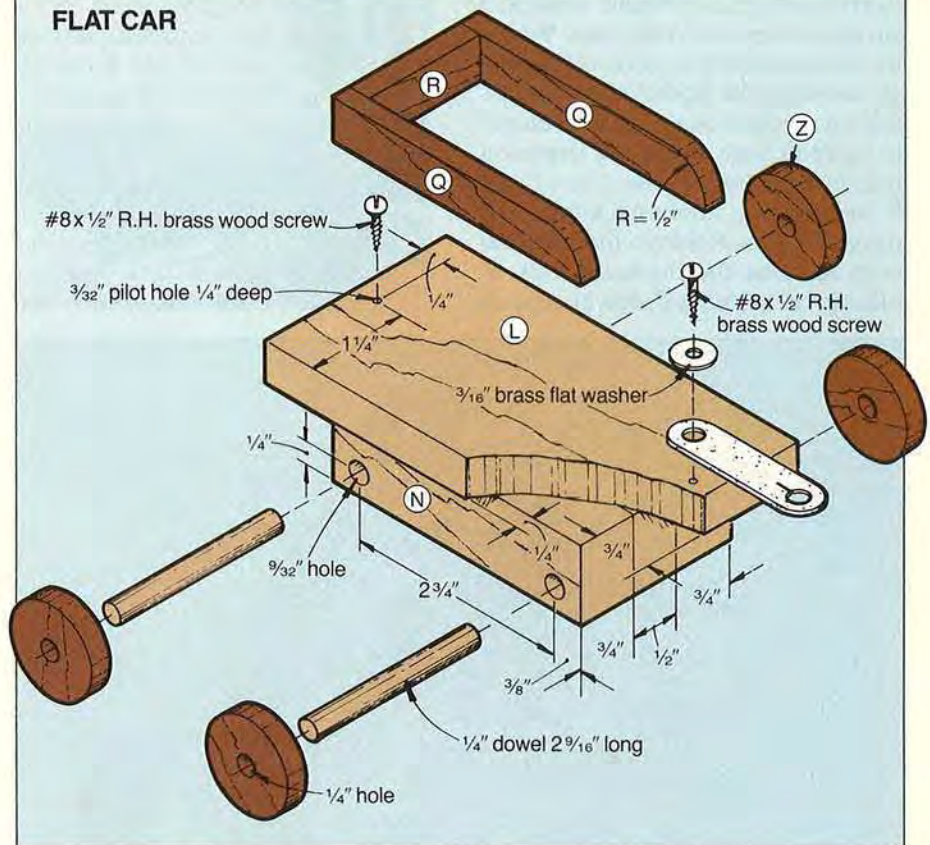

PASSENGER CAR

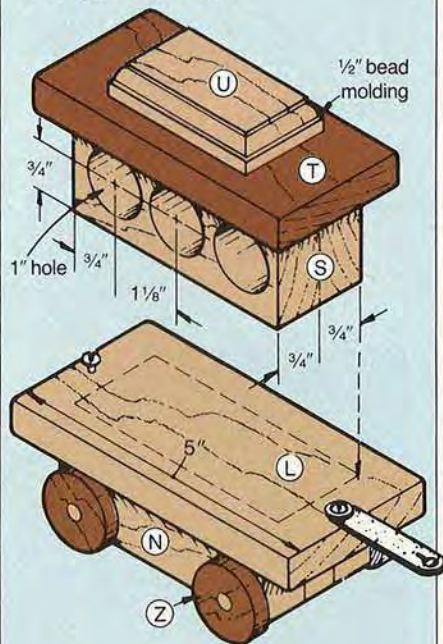

Note: The Passenger Car uses the same chassis as the Flat Car.

CABOOSE

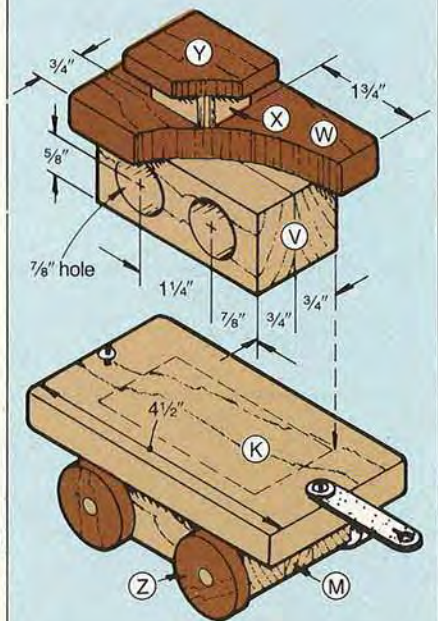

Note: The Caboose uses the same chassis as the Coal Car.

Bill of Materials

Part	Finished Size*			Material	Qty.
	T	W	L		
Flat Car					
L*	1/2"	2 1/2"	5"	maple	1
N*	1"	2"	3 1/2"	maple (laminated)	1
Q	1/4"	1/2"	3 1/2"	walnut	2
R	1/4"	1/2"	1 1/2"	walnut	1
Passenger Car					
L*	1/2"	2 1/2"	5"	maple	1
N*	1"	2"	3 1/2"	maple (laminated)	1
S*	1 1/2"	1 1/2"	3 3/4"	maple (laminated)	1
T	1/2"	2 1/4"	4 1/2"	walnut	1
U	1/2"	1 1/2"	2 1/2"	maple	1
Caboose					
K*	1/2"	2 1/2"	4 1/2"	maple	1
M*	1"	2"	3"	maple (laminated)	1
V*	1 1/2"	1 1/4"	3"	maple (laminated)	1
W	1/2"	2 1/4"	3 3/4"	walnut	1
X	1/2"	3/4"	1"	maple	1
Y	1/4"	1 1/4"	1 1/2"	walnut	1
Wheels					
Z	1/4"	1 1/4" diameter		walnut	20
AA	3/8"	2 1/2" diameter		walnut	2

*Parts marked with an * are cut larger initially, then trimmed to finished size. Please read the instructions before cutting.

Supplies: same as locomotive on page 75

an inside cut as shown in the drawing and photo *below*. Then, cut the wheels to size.

11 Cut the axles to length (10 at 2 9/16" and one at 2 7/8") from 1/4" dowel stock. *Do not* glue the wheels to the axles yet.

FINISHING AND FINAL ASSEMBLY

1 Finish-sand all surfaces of the train. Sand a slight round-over on all edges and corners for safe, smooth handling.

2 Apply two or more coats of a nontoxic clear finish. (We used salad bowl finish; see the Buying Guide for ordering details.)

3 Glue one wheel on each axle. Wipe off any excess glue, and insert the axles through the holes in the various cars. Being careful not to glue the axle or wheel to the chassis, glue the other wheels onto the other end of each axle. Allow 1/16" play for clearance.

4 Cut the leather couplers to size (see the full-size drawing *below*). Then, punch or drill 1/4" holes

spaced where shown. If you don't have a punch, cut a 2" length of 1/4" thin-walled brass tubing (available at local hobby stores) and file a sharp bevel around the outside rim of one end. Mount the tube in your drill press and "drill" out the holes. Or, use a 1/4" brad point bit (be sure to hold the leather firmly while drilling — it has a tendency to rotate with the bit. Cut a 1/4"-long slit next to one of the holes in each coupler. Then, cut each end to shape with a utility knife.

5 Fasten a coupler to the front of each car with a #8x 1/2" brass wood screw and a flat washer. Then, drive a screw of the same size into the pilot holes at the rear of each car.

BUYING GUIDE

• **Circle cutter.** Adjustable 7/8-4". Catalog no. H3511, \$8.95.

Craftsman Wood Service Co., 1735 W. Cortland Ct., Addison, IL 60101. Or, order by phone: 312/629-3100.

• **Thin stock.** 1/4" walnut, catalog no. W9724, \$3.30 per square foot, (2 square feet needed). 1/2" walnut, catalog no. W9726, \$5.75 per square foot, (1 square foot needed). 1/4" maple, catalog no. W9112, \$3.95 per square foot, (2 square feet needed). 3/8" maple, catalog no. W9708, \$2.12 per square foot, (1 square foot needed). 1/2" maple, catalog no. W9709, \$2.59 per square foot, (1 square foot needed). Craftsman (address above).

• **Salad bowl finish.** Nontoxic clear finish, catalog no. H5414, \$7.25 per quart. Craftsman (address above).

• **Leather strip.** 1/2x 36", Tandy catalog no. 4568, \$1.99. Call 800/433-5546, or write Tandy Leather Company, P.O. Box 2934, Fort Worth, TX 76113, for the store nearest you. 🌲

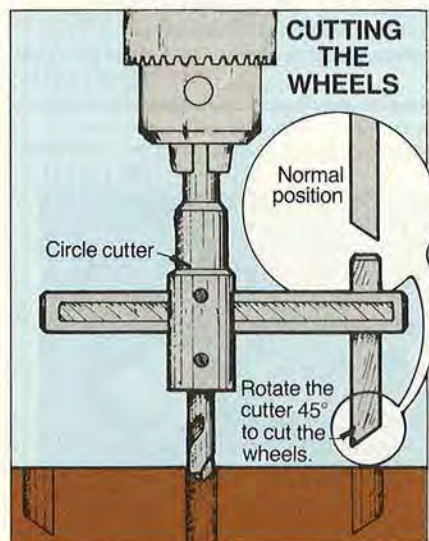
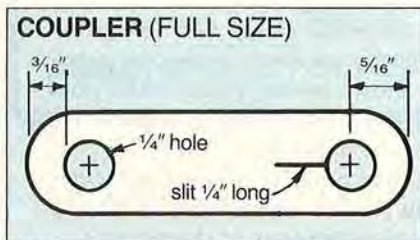

Produced by Marlen Kemmet;
Yosh Sugiyama
Project Design and Illustrations:
Kim Downing; Bill Zaun
Photographs: Hopkins Associates;
Jim Kascoutas

SWEETHEART STICKPIN

H·O·L·I·D·A·Y
SPECIALS
FROM THE SHOP



Out-of-the-ordinary jewelry always makes a welcome gift. This pin, laminated with woods from your scrap box, is a sweetheart to make, too — once you know how.

1 Rip $\frac{1}{8}$ "-wide strips from the edges of $\frac{3}{4}$ "-thick boards 8" long to acquire the number and types of wood listed in the Bill of Materials, or choose your own combination. Glue and clamp the strips together, alternating the wood types, as shown in step one of the photo below. Scrape off the excess glue.

2 Fit your band saw with a miter gauge set at 45° from center and a $\frac{1}{4}$ " or larger blade having eight or more teeth per inch. Then, cut eight $\frac{1}{8}$ "-thick slices (see one slice in step two of the photo below). Tape a piece of 80-grit sandpaper to a flat surface, and hand-sand both sides of each slice.

3 Glue and clamp two $\frac{1}{8}$ " slices together to form a chevron pattern as shown in step three of the photo. Repeat this process to make a total of four patterns.

4 Glue and clamp the four chevron patterns together to form the block (step four of the photo). Later, sand the top and bottom faces of the block smooth.

5 Position the fence on your band saw $\frac{1}{4}$ " from the blade. Using a push block, cut $\frac{1}{4}$ "-thick slabs from the laminated block. Then,

as shown in step five of the photo, make a template, and draw a heart outline on each slab (use the full-sized Front View in the lower left-hand corner, to make the template). **6** Carefully cut the hearts to shape with a scroll saw or band saw.

7 Round-over the top edge with a small rasp or sandpaper. As an option, use a power tool, such as a Dremel fitted with a $\frac{3}{8}$ " sanding drum. Finish-sand each heart.

8 Glue the pad of the stickpin to the back of the heart with epoxy. Rub in several coats of a penetrating oil finish, and wipe off the excess.

Bill of Materials					
Part	Initial Size of Strips			Material	Qty.
	T	W	L		
A	$\frac{3}{4}$ "	$\frac{1}{8}$ "	8"	walnut	4
B	$\frac{3}{4}$ "	$\frac{1}{8}$ "	8"	maple	2
C	$\frac{3}{4}$ "	$\frac{1}{8}$ "	8"	oak	1

Supplies: masking tape, epoxy, finish

STICK PIN (Shown full size)

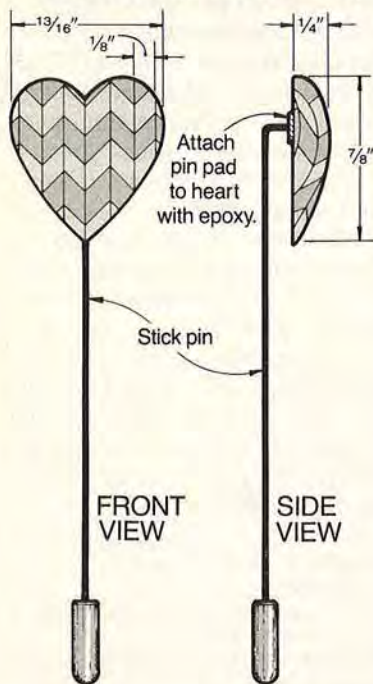

BUYING GUIDE

● **Stickpins.** Hamilton gold finish, $2\frac{3}{4}$ " long with bullet type clutch. Try your local hobby store, or order them for 89 cents per half dozen, plus 75 cents shipping from Mangelsen's, 3457 South 84th St., Omaha, NE 68124, or call 800/391-6225.

Project Design: Paul Franzmeier
Photographs: Jim Kascoutas
Illustration: Yosh Sugiyama

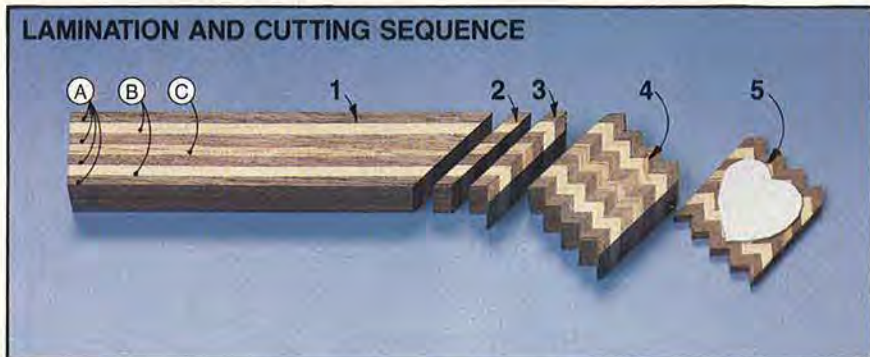

 Small bevel-edge shaper collars fit Sears and Rockwell 1/2" Shapers \$49.95
Patterns custom ground to your specifications \$19.95 & up.
Custom kitchen cabinets style, rail and vertical panel cutters available
WDR SALES
9604 Belmont, Kansas City, MO 64134
(816) 763-3029

 **Ryobi 10" Radial Arm Saw**
Round out your shop with affordable precision!
FREE INFORMATION!
WDR SALES
9604 Belmont
Kansas City, MO 64134
(816) 763-3029

National Carvers Museum

LEARN WOODCARVING AT HOME

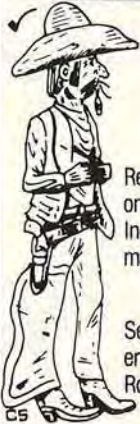
 Receive sample instructional pack on whittling and woodcarving. Includes copy of *Mallet* monthly magazine.

Send \$1.00 to The National Carvers Museum, 14960 Woodcarver Rd., Monument, CO 80132.
(303) 481-4737

POWER TOOLS **SAVE \$50 TO \$500**

METAL PARTS KITS AT LOW FACTORY DISCOUNT PRICES FOR \$500 per Plan

- 12-IN. BAND SAW
- 18-IN. BAND SAW
- WOOD SHAPER
- 6-IN. BELT SANDER
- 10-IN. TILT/ARBOR SAW
- LATHE/DRILL PRESS COMB.

KITS FROM \$34.99 TO \$189.99
Easy to follow step-by-step plans. Photos. No machining, no welding. Build your own sturdy frame. Full scale patterns. 98,000 kits sold. Send \$6 for plans, brochure and prices or \$1 for brochure and prices. Order kits on Visa or MasterCard.

GILLIOM MFG., INC. MONEY BACK GUARANTEE
1700 Scherer Pkwy. Dept. BHW611
St. Charles, Mo. 63303 Phone (314) 724-1812

INSTRUCTIONS, IDEAS AND INSPIRATION

 SEND \$50 FOR A CATALOG TODAY

You'll find a wide selection of plans, patterns and ideas for woodworkers of all skill levels. Everything from simple to challenging.

Craftplans™
21801 Industrial Boulevard, Dept. 945
Rogers, Minnesota, 55374-9514

BUILD THIS EXQUISITE HARP FROM A KIT!



Send \$1.00 for complete catalog of the finest musical instrument kits:

- HARPS
- GUITARS
- HAMMERED DULCIMERS
- BANJOS
- HARPSICHORD
- BOWED PSALTERIES
- HURDY GURDY
- BAGPIPES

and much more!

ST. CROIX KITS
423-B South Main
Stillwater, MN 55082
(612) 439-9120

Sleeveless DRUM SANDER
NO PRE-MADE SLEEVES TO BUY



ECONOMICAL — Simply cut sandpaper from standard size sheets
UNIQUE — Twist of key tightens sandpaper to drum.
SPONGE RUBBER backing insures long wear of sandpaper

1" x 3" long	\$13.50
2" x 3" long	\$15.50
2 1/2" x 3" long	\$16.00
3" x 3" long	\$17.50
1" and 2 1/2" Above \$27.00	
Above 4 Drums \$55.00	
3/4" x 3" long	\$14.50
2 1/2" x 4 1/2" long	\$21.00
3" x 4 1/2" long	\$22.50
2 1/2" x 6" long	\$25.50
3" x 6" long	\$27.50
Add \$2.50 Per Order For Shipping	

AVAILABLE WITH:
1/2" Bore with 1/2" or 1/4" shaft
1/2-20 RH Thread except 3/4" x 3"
5/8" Bore except 3/4" x 3" and 2" x 3"

USE ON:
Drill Press
Small Motor
Lathe, Combo-Tools,
Radial Saw, 1/4" Drill

MONEY BACK GUARANTEE

Send Check or Money Order to:
SINGLEY SPECIALTY CO. INC.
P.O. BOX 50876, GREENSBORO, N.C. 27403
CALL: (919) 852-8881

A subscription to WOOD magazine is an appropriate gift for those who enjoy the pleasure of woodworking.

MAKE TOYS AND WHIRLIGIGS

100's of plans, parts, kits, books, finishes & supplies for toys, whirligigs, classic autos, swing sets, doll houses, crafts & furniture. Also toy, craft, game & furniture parts in maple, oak, walnut & cherry. Bulk prices available.

LIMO KITS Color catalog subscription \$1.
\$24.00 Precut: just sand & assemble (614) 484-4363
\$18.50 Uncut: just cut, sand & assemble
Size: 14" long



Cherry Tree Toys, Box 369-9, Belmont, OH 43718

FACTORY DIRECT GRANDFATHER CLOCKS

Do-It-Yourself Clock Kits

Prices Starting Under **\$300**
(including movement and dial)
OR
Completely Assembled and Finished

- Solid 3/4" hardwoods: black walnut, cherry, oak
- Heirloom quality
- Solid brass West German chiming movements and dials
- Easy to assemble kits or completely assembled and finished
- Money back guarantee

SEND \$1 FOR 32-PAGE FULL COLOR CATALOG



EMPEROR® CLOCK COMPANY
WORLD'S LARGEST MANUFACTURER OF GRANDFATHER CLOCKS
Dept. 2106, Emperor Industrial Park
Fairhope, Alabama 36532 • Phone 1-205-928-2316
I am interested in Do-It-Yourself Kits
 Finished Clocks

Name _____
Street _____
City _____
State _____ Zip _____
(please print)



ASHMAN TECHNICAL LTD.
Machinery • Tools
• Shop Equipment •
351 Nash Rd, N.,
Hamilton, Ont., Can. L8H 7P4
(416) 560-2400

CALL TOLL FREE **1-800-263-4507**

DUTY CHARGES INCLUDED IN ALL PRICES

DELTA or GENERAL (UNISAW)



3 H.P. — 10" TILTING ARBOR SAW **\$1140.00**
UNIFENCE OR BIESEMEYER MODELS **\$1340.00**
3 H.P. Single Phase — 230 V 60 cycle with Magnetic Starter

13" Delta planer RC33 2HP with stand \$ 999.
20" Delta planer RC51 5HP \$3490.
8" Jointer with Stand — General \$1030.
6" Jointer with Stand — General - 1 H.P. \$ 585.
15" Woodcutting Bandsaw with Stand \$ 595.
12" Wood Lathe with Stand — General \$ 688.

U.S. FUNDS — FREIGHT COLLECT — CALL FOR QUOTATION —

BOSCH Power Tools

Jig saws
only \$125.00

Model 1581VS



NO.	TOOL	SALE
1582VS	Orbit. Action Mob Hdle Jig Saw	\$118.00
3238VS	Unv. Shank Mult. Orbit. Jig Saw	83.00
1601	1 hp Router	89.00
1602	1½ hp Router	129.00
1604	1¾ hp Router	118.00
1606	D-Handle, 1¾ hp Router	163.00
90300	Fixed Base Router, 3¾ hp	350.00
90303	Plunge Base Router, 3½ hp	472.50
90085	¾ hp Router	91.00
32700	3x21 Dustless Belt Sander	119.00
1272	3"x24" Belt Sander	159.00
1272D	3"x24" Belt Sander w/Dust Collector	169.00
1273	4"x24" Belt Sander	169.00
1273D	4"x24" Belt Sander w/Dust Collector	179.00
1921VSRK 3/8"	Var. Spd. Screwdriver	115.00
1920VSRK 3/8"	Cordless Reversing Drill	99.00
1920RK	3/8" Cordless Reversing Drill	85.00
3268	Heat Gun	48.00
1158VSR	3/8" Var. Spd. Rev. Drill	54.00
1651	New Bosch 7¼" Cir. Saw, 13 amp	99.00

MAKITA-HITACHI

F1000A	Planer Jointer	1275.00
2030N	Planer Jointer	1420.00
8600A	Bandsaw	1400.00

CALL TOLL FREE
1-800-525-0750

VISA and MASTERCARD ACCEPTED

AVIATION/INDUSTRIAL SUPPLY

P.O. Box 39159 • Denver, CO 80238

TOOLS FREIGHT PAID

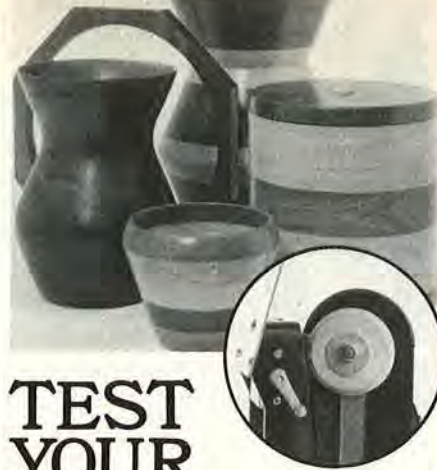

TEST YOUR IMAGINATION

Create any Hollow Cylindrical Shape up to 12" dia. Cut flat wood into straight or angle rings, stack rings, glue, sand, & finish, All on your Ring Master.

ORDER YOUR FREE BROCHURE TODAY

1-800-854-9815

In Florida 305/859-2664

24-page project notebook—\$2.
Video tape demo VHS \$20,
refund on return.

P.O. Box 8527A, Orlando, FL 32856

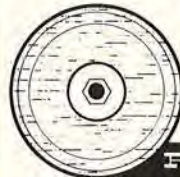

RING MASTER



BUILD AN HEIRLOOM CLOCK

Finest Quality Available
Kits, Movements and
Plans

Write or Call for
Catalog \$2
1-800-328-6445
Kuempel Chime
Clockworks

Dept. 011
21195 Minnetonka Blvd.
Excelsior, MN 55331
Serving clockmakers for 65 years

101 GIFT & NOVELTY PATTERNS

This wonderful packet contains 101 FULL SIZE PATTERNS of Gifts, Novelties, Lawn Figures, Bird Houses, Shelves, Action Windmills, Alphabets, and many more things. Just trace and saw out. Plus "Make Money Jig Sawing" Only \$7.00 Prepaid 1st Class for this big packet.

MASTERCRAFT PLANS WEST, DEPT. 115H
PO Box 625, Redmond, WA 98073



100 THINGS A KID CAN MAKE PLANS • FULL SIZE PATTERNS

Easily made toys, games, gifts, bird houses, windmills, playthings, etc. A wonderful gift for your child, also splendid help for scout and youth leaders. "Fun With Tools," which also tells how to make things, is also included. All for \$7 Prepaid 1st Class.

MASTERCRAFT PLANS, 1110H
PO Box 625, Redmond, WA 98073



MITER/BEVEL GAUGE SET

FOR A PRECISE SETTING OF BLADE,
MITER OR BEVEL ON RADIAL ARM SAWS.
ELIMINATE TRIAL AND ERROR.



Six Angles, 15°—18°—22.5°—30°—45°—60°, included in set. Each angle attaches to bar. You will find many uses in the shop or home. Patent Pending. Rush order today—

Miter/Bevel Gauge set **ONLY \$29.95**

Please send payment with order. Shipping/handling included.

ROBERT S. SMITH INC. Dept. WD 86
P.O. Box 17330, Phoenix, Arizona 85014

Watch for other new products from: Robert S. Smith Inc.
an Innovation Company, Dealer Inquiries Invited.

Send For New 68 Page Woodworkers Catalog!



783 handtools, supplies, patterns, accessories, veneers, doweling, hardwoods, toymaking, carving, turning supplies. Record-Marples, Kunz, Vt. Amer., Blum, Accuride, Schlagring, Solginen, U.S. Safety, General, Hempe, Boyne, Brinks-Cotton, Smit Whetstone, DMT, Freud Tools, 20% Off. Walnut, Cherry, Maple, Basswood turning and carving blocks. Solid Maple and spoked wheels, toy parts, pegs, etc. 101 popular veneers, burls, crotches, large flexibles, glue sheets, fancy faces, custom made veneers. Hurry! Send \$1.00 today for your new 68 page color catalog and FREE gift offers!

Morgan Woodworking Supplies, Dept. W06M17
1123 Bardstown Rd., Louisville, Ky. 40204

Clamp Onto Low PRICES!

We'll Pay The Freight!

8" KIT - 6.95
10" KIT - 7.95
12" KIT - 8.95
14" KIT - 9.95

2-Wood Handles - \$1.00
Send Check, Money Order,
Visa or MasterCard Number

KIT INCLUDES: Heavy steel ferrule with spiral pins...
2-1/8" ACME, double lead, threaded rods... 4-5/8" pins...
Complete layout with instructions.

DUBUQUE Clamp Works
527 Garfield • Dubuque, IA 52001



LOW PRICES • HIGH QUALITY
Toll Free Phones! • 1-800-624-3938
In Ill. 1-800-358-4208

Love - Built Toys

The Toymaker Supply Co.

105 Weiler Rd. T34
Arlington Hts., IL 60005

For Volume Purchases of Quality
Toy Parts... Write or Phone Today
For Free Catalog!



Brand Your Work



Personalize your wood and leather products or handicrafts with the easy to use Craftmark® Branding Tool. Choose from four branding marks: Logo • Maker's • Owner's • Custom

For more information write:
Wall Lenk Corporation Dept. W116
P.O. Box 3349, Kinston, North Carolina 28502-3349

WOOD REPAIR

Durham's Rock Hard Water Putty makes lasting repairs in wood. Won't shrink or fall out. Sets quickly, holds tight and can easily be painted. Economical, easy to use. Available at lumber, paint and hardware stores.



DONALD DURHAM COMPANY
Box 804-W, Des Moines, IA 50304

TURNING TOOLS BUYING GUIDE

See related article on page 60

For further information on lathe tools write to the following companies:

Anglo-American Enterprises Corporation
P.O. Box 24
Somerdale, NJ 08083
Tools: Marples, Sorby, Mifer
Catalog: Free

Buck Bros.
P.O. Box 192
Millbury, MA 01527
Tools: Buck
Catalog: Free

Craft Supplies USA
1644 S. State Street
Provo, UT 84601
Tools: Henry Taylor (Diamic), Sorby (unhandled)
Catalog: \$2 (refundable with order)

The Fine Tool Shops, Inc.
20 Backus Avenue
Box 1262
Danbury, CT 06810
Tools: Sorby
Catalog: Free

Freud Inc.
P.O. Box 7187
218 Feld Avenue
High Point, NC 27264
Tools: Freud
Catalog: Free

Garrett Wade Company
161 Avenue of the Americas
New York, NY 10013
Tools: Henry Taylor (Diamic), Sorby, Japanese (laminated), Luna
Catalog: \$4

Robert Larson Co.
82 Dorman Avenue
San Francisco, CA 94124
Tools: Hirsch, Sorby
Referrals to local dealers

Lee Valley Tools, Ltd.
2680 Queensview Drive
Ottawa, Ontario
K2B8H6 Canada
Tools: Sorby
Catalog and Mailing List \$5

Mifer Tools USA, Inc.
P.O. Box 5515
Clark, NJ 07066
Tools: Mifer
Catalog: Free

Frank Paxton Lumber Co.
9229 Ward Parkway, Suite 350
Kansas City, MO 64114
Tools: Hirsch, Lemco, Sorby, Buck

Treen Heritage, Ltd.
P.O. 280
Merrickville, Ontario
K0G1N0 Canada
Tools: Henry Taylor (Diamic)
Catalog: \$1

Woodcraft Supply Corp.
41 Atlantic Avenue
P.O. Box 4000
Woburn, MA 01888
Tools: Henry Taylor (Diamic), Sorby, Woodcraft
Catalog: Free
Compiled by: George Granseth

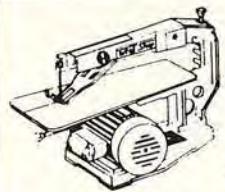

15" Scroll Saw

- Comparable to Hegner or Delta
- Fully adjustable table
- 2" depth of cut/3/4" stroke
- 110V
(Shipping and handling \$20.00)

\$199⁰⁰

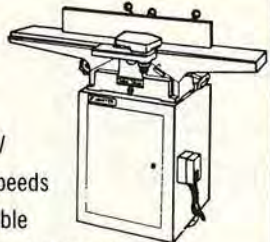

6" Heavy Duty Jointer

- 3/4HP, 110V
- Adjustable speeds
- Fully adjustable
- 190 lbs. (ships freight collect)

Reg. \$499⁰⁰ **\$299⁰⁰**



8" Industrial Quality Jointer

- 1 1/2HP, 220V
- 65" length
- 397 lbs. (ships freight collect)

Reg. \$795⁰⁰ **\$575⁰⁰**

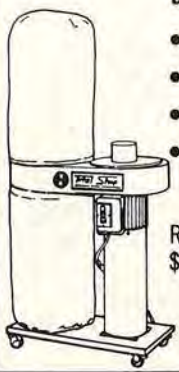

Dust Collector

- 1HP, 110V
- 4" inlet
- Industrial quality
- Compact size
(Shipping and Handling \$30.00)

Reg. \$398⁰⁰ **\$199⁰⁰**

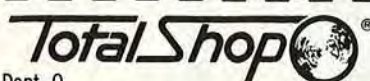

Dept. Q
P.O. Box 16297/Greenville, SC 29606

Name _____

Address _____

City _____

State/Zip _____

Phone _____

30-Day Money Back Guarantee
1-Year Warranty

Call _____ or in S.C.
Toll Free 1-800-845-9356 288-4174

TOTAL AIRE Air Compressor

- 1/2HP with 3.3 cu.ft. of air per min.
- 150 PSI capacity
- Wheels and handle for easy moving
- Can be used with air tools for spray painting, pumping tires, cleaning shop, etc.

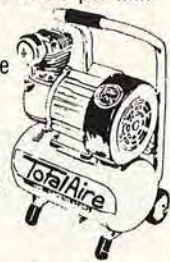

(Shipping and handling \$20.00)

Reg. \$419⁰⁰ **\$199⁰⁰**

SPINDLE TOP

Sometimes called mountain tops, spindle tops represent an improvement on a simpler design. The guide on its handle steadies the top as it begins to spin, then, it's lifted when the top takes off. It makes even big and otherwise unwieldy tops easier to spin, but it's best to stick with the size shown for your first one. After that, you can experiment.

Use any hardwood, or even pine, for the handle and guide. The top itself should be of hard maple to withstand abuse. You can turn the top on a lathe or shape it on a drill press. Either way, make sure that the hole for the spindle lines up exactly on the centerline of the body or the top will be out of balance and won't spin. Decorate the top with a colorful stripe or two for a rotating design that adds flash and excitement as the top spins.

Photograph and related article on page 48

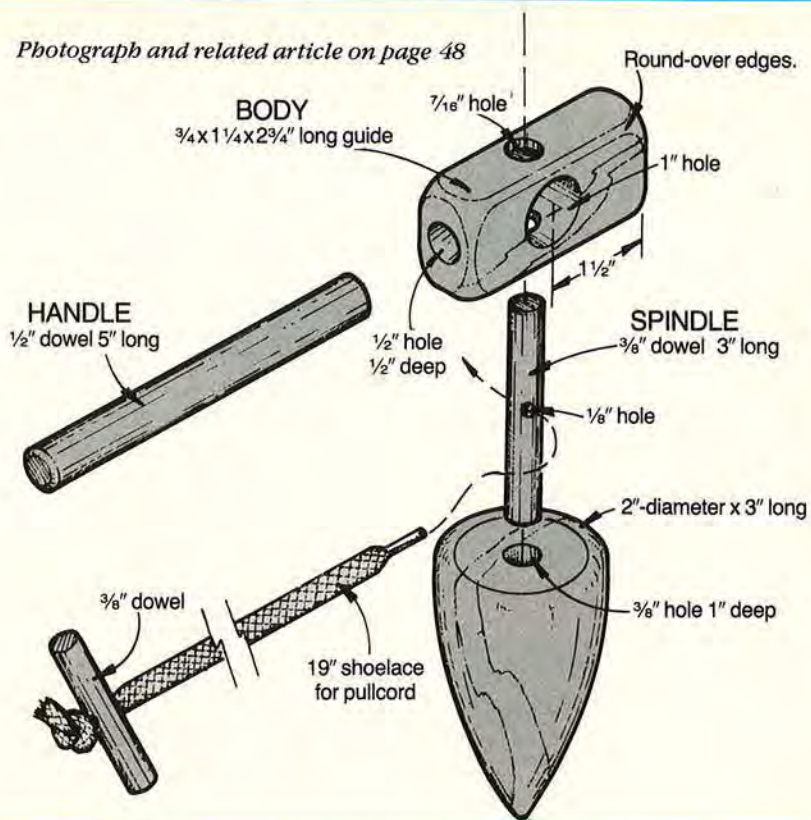

It planes, joints, dimensions, shapes, mortises, miters, saws...and saves you money!

The steel constructed REX-2000 offers extraordinary precision at an unbeatable low cost.

This 10 1/4" capacity machine is powered by a 2 1/2 hp motor, and delivers the muscle you need with the finesse required for fine woodworking.

If you're a craftsman that demands perfection, you owe it to yourself to look at the REX-2000. It's the finest Jointer-Planer-Thickener available today. Table saw, slot mortising and moulding attachments optional.



Jointing/Planing Capacity: 10" wide
Power Thicknessing Capacity: 10" x 6"

emco USA

Dept. BWA6R • 2080 Fairwood Avenue
P.O. Box 07795 • Columbus, Ohio 43207

1-800-521-8289

(In Ohio: 614-445-8382)



SLOT MORTISER



MOLDER/SHAPER

MAKE BEAUTIFUL RAISED PANEL DOORS . . . WITH YOUR ROUTER!

Professional production quality bit makes it quick and easy to produce matching rails and stiles — the panel raising bit with ball bearing guide makes the raised panel perfect every time.

Regular value over \$180.00

SALE PRICE **\$79.95** FOR COMPLETE SET

ORDER ITEM #154 (Includes all bits shown)

SAVE 55%

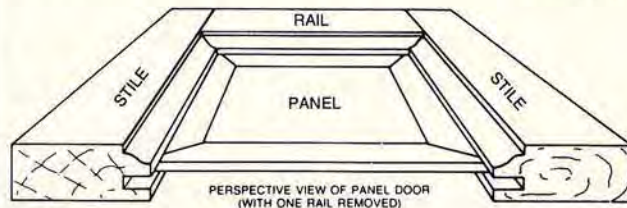

RAISED PANEL BIT
SUPPLIED WITH BALL BEARING
1/2" SHANK
3-1/4" Large Diameter



REVERSIBLE COMBINATION RAIL and STILE BIT

(For making matching rails and stiles in raised panel doors, etc.)
Works with stock from 1 1/16" to 7/8" thick



CARBIDE TIPPED — TWO FLUTE
1/2" SHANK
supplied with Ball Bearing

To order by Master Charge or Visa Toll Free
7 Day — 24 Hour Order Service, Call
1-800-523-2445, Ext. 56 (in PA 1-800-346-7511, Ext. 56)
or send check to **MLCS, Ltd.**, P.O. Box 53D, Rydal, PA 19046

CHICKENS PECKING

Photograph and related article on page 51

This toy was popular in some middle European countries before it was brought to America. In Europe, the chickens were brightly painted. Here, however, they were always made quite plain, reflecting simpler tastes, and quite possibly, lack of bright paint.

You can dictate these chickens' pecking order by changing the weight's rotation direction —

clockwise, counterclockwise, back and forth. It's clever engineering that keeps children and adults amused.

In assembly, glue the thread to the back of each chicken's neck *before* inserting it into the body and fastening in place with a finishing nail. And make sure you don't glue down the seeds or kernels where the pecking chickens can hit them!

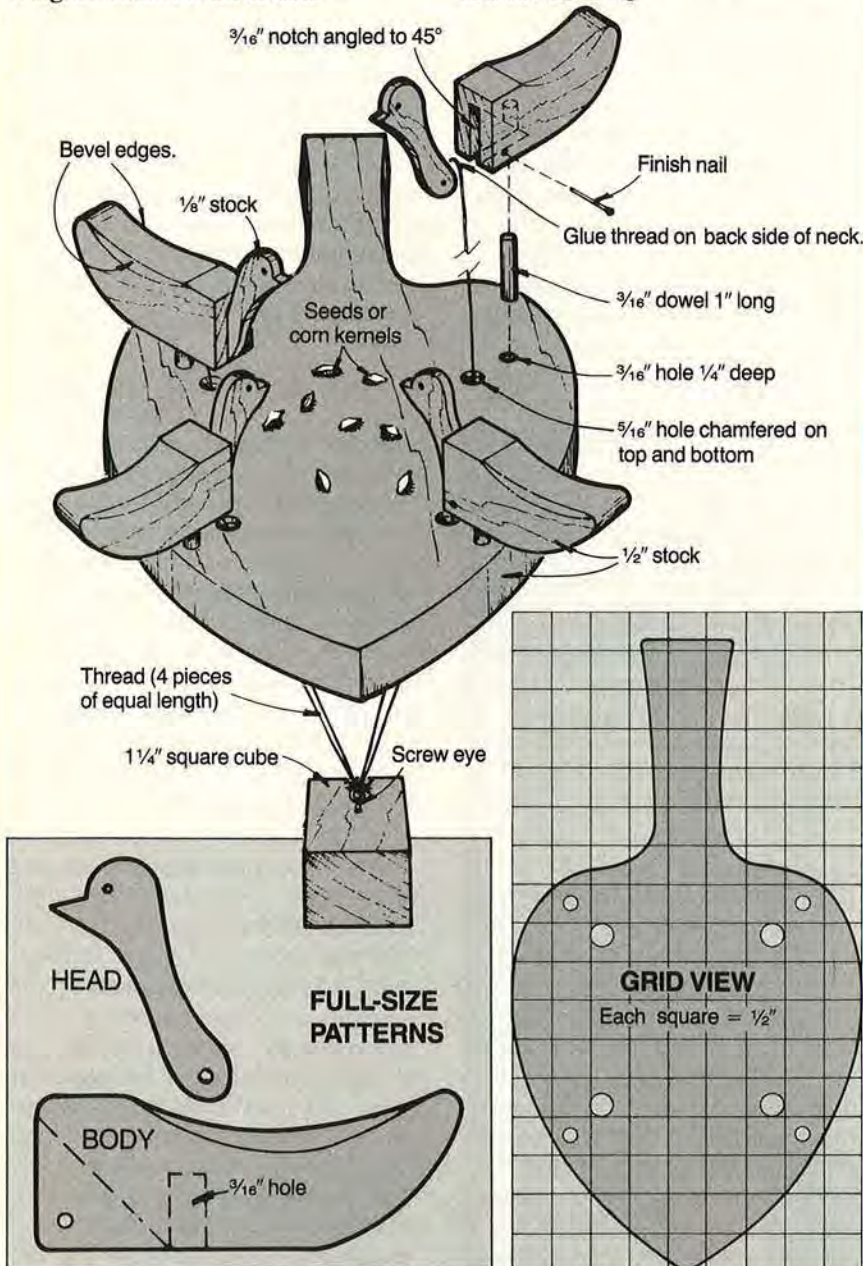

Photographs: Craig Anderson

Illustrations: Bill Zaun

NOW! Get in on the PROFITS in

SMALL ENGINE REPAIR!



Start your own money making business!

Work part time, full time — right at home — we help you every step of the way.

No doubt about it... as a small engine pro, you can cash in on the huge demand for qualified men in one of America's fastest growing industries. You'll be able to command top hourly rates of from \$25.00 to \$30.00 per hour — and that's just for labor. A simple tune-up earns as much as \$49.95 for less than an hours work, and parts, engines and accessories will add even more to the profits.

Plenty of business waiting for qualified men. 65,000,000 Small Engines Are In Use Today!

That's the official count from the Engine Service Assn., and one-million new engines are being built each month. With fully accredited Foley-Belsaw training, you can soon have the skills and knowledge to make top money servicing these engines. People will seek you out and pay you well to service their lawnmowers, tillers, edgers, power rakes, garden tractors, chain saws, minibikes, snowmobiles, generators, go-carts, paint sprayers, snowblowers... the list is almost endless.



Professional Tools and Equipment, PLUS 4 H.P. Engine ALL YOURS TO KEEP... All at No Extra Cost. NO EXPERIENCE NECESSARY!

You don't need to be a 'born mechanic' or have any prior experience. You can master this profitable trade right at home in your sparetime. Lessons are fully illustrated... so clear you can't go wrong, and with our famous 'learn-by-doing' method you get practical 'hands-on' experience. We also show you how to get business, what to charge, where to get supplies wholesale... all the inside tricks of the trade you need to assure success right from the start.

Send for FREE Facts — Do it TODAY!

NO Obligation — NO Salesman Calls!

You risk nothing by accepting this offer to see how easily you can learn the skills you need to increase your income in a high-profit business of your own. Just fill in and mail coupon below (or send postcard with name and address) to receive full information by return mail.

RUSH COUPON TODAY

Foley-Belsaw Institute
51013 Field Building
Kansas City, MO 64111



FREE BOOKLET!
Send for your copy today!

FOLEY-BELSAW INSTITUTE
51013 FIELD BUILDING
KANSAS CITY, MO 64111



YES, please send me the FREE booklet that gives full details about starting my own business in Small Engine Repair. I understand there is No Obligation and that No Salesman will call on me.

NAME _____

ADDRESS _____

CITY _____

STATE _____ ZIP _____

Make Clocks Easily!

Self-Adhesive Acrylic Dials



6" Bass Dial
740-043
Gold Numerals
Blue, Green & White Center
\$3.75 each

6" Owl Dial
740-042
Gold Numerals & Silver Glitter Owl
\$3.75 each



5" Starburst Dial 740-041
Gold Glitter Numerals
\$3.75 each

M88 Movement
2-3/16" Square
5/8" Thick
Uses AA Cell
\$6.50 each
Includes Hands



COMPLETE KITS SAVE 33%

Your Choice
of Above Dials \$3.75
M88 Movement 6.50
Catalog 1.00
Regular Price \$11.25

Special \$7.50

Add \$2.00 per order for postage and handling.

Quartz Clock Movements



Movements, Hands, Numerals, Dials, Accessories, Tools & More!
Cas-Ker Co.

Catalog 786 — \$1.50 pages of clock movements, dials, accessories, hands, tools, and more!



\$25 minimum charge card sale.

Cas-Ker Co.

BOX 14069-R CINTI., OH 45214
PHONE (513) 241-7073

Bowl Blanks and Burls

Source Listing *See related article on page 57*

Arroyo Hardwoods

2585 Nina St.
Pasadena, CA 91107
818/304-0021
Cocobolo, tulipwood, lilac burl, pink ivory, and vera wood are but a few of the bowl blanks this company handles. Arroyo Hardwoods has a full line of domestic and imported woods for the turner to choose from.

Berea Hardwoods Co.

125 Jacqueline Dr.
Berea, OH 44017
216/243-4452
Berea Hardwoods carries black swamp stumps, which resemble ostrich leather, and she oak, which resembles quartered oak with prominent red rays. They also carry bloodwood from Brazil and jarrah burls from Australia. James Heusinger, the owner, states that he actively seeks out extremely unusual turning woods in addition to his inventory of the more common species.

Cal Oak Lumber Co.

1000 Cal Oak Rd.
P.O. Box 689
Oroville, CA 95965
916/534-1426
This outfit, which prepares over 3 million board feet of regular lumber yearly, also sells oak and cottonwood burls up to 40" in diameter and from 3" to 4" thick.

Craft Supplies USA

1644 South State St.
Provo, Utah 84601
801/373-0917
A few of the types of turning stock sold by Craft Supplies includes wild lilac, myrtlewood burl, box elder, and claro walnut. The owner stocks burls from the size of a grapefruit to several feet across. If you're in the area, take a stroll behind the Craft Supplies store; it is a virtual burl supermarket. In addition, Craft Supplies specializes in woodturning tools and lathe accessories.

Gilmer Wood Co.

2211 NW St. Helens Rd.
Portland, OR 97210
503/274-1271
Gilmer Wood Company has a list of turning stock that includes alpine birch burl logs, bubinga, myrtle wood and madrone burls, padauk, and pearwood to name just a few. Myles Gilmer, owner, reports that he has 70,000-80,000 lbs. of burl on hand.

Joshua's Trees

113 North Seventh
Brooklyn, NY 11211
718/387-9016
Wood dealer Joshua Hoffman, travels from Vermont to Nigeria to select his woods. Joshua's Trees list includes spalted sycamore and beech, along with bird's-eye maple and several exotics.

Johnson Wood Products

Route 1
Strawberry Point, IA 52076
319/933-4930 or 319/933-6504
Johnson Wood Products has a large variety of bowl blanks in various sizes, with prices ranging from \$.60 to \$23 per blank. Fancy-figured walnut and spalted maple blanks run double the regular price. You can purchase butternut, hackberry, oak, red elm, honey locust, cherry, and occasional quantities of spalted maple through this family-run business.

Native American Hardwoods Ltd.

Box 6484
West Valley, NY 14171
716/942-6631
This company carries small, medium, and large blocks of spalted maple and beech. The blocks contain lots of variegated color and spalt lines. Peter Sieling, General Manager, recommends rough turning the stock to a 3/4-1" wall thickness, coating the bowl with paraffin, letting it sit for 6-8 weeks, and finally remounting the stock and finish-turning the piece.

Paradise Farm Wood Prod.

Wesley, ME 04686
207/255-3711

Greg Kaminsky of Paradise Farm travels yearly to an area near the mouth of the Amazon to select trees for his inventory. Paradise Farm stocks Amazon rosewood, leopard wood, and pernambuco.

Reliance Ind. Inc.

P.O. Box 129
Richland, IA 52585
319/456-6030

Reliance Industries specializes in osage orange, also called "hedge apple" in many parts of the country. The heartwood, often saffron and gold streaked, will be enclosed in white sapwood. The color slowly mellows with age.

Shir-Lee Manzanita Ranch

P.O. Box 6
Potrero, CA 92063
619/478-5706

Manzanita burl, part of the intricate root system of the manzanita bush, comprises the sole stock of this company. Manzanita grows in clusters at elevations of 4,000 to 6,000 feet in southern California and Baja Peninsula.

Tropical Timber Corp.

3125 Van Water
Portland, OR 97222
503/654-5349

The list of exotics carried by Tropical Timber includes cocobolo and lignum vitae. You'll want your tools sharp when cutting lignum vitae, the hardest and heaviest wood known with a density almost equal to that of iron.

Weird Wood

P.O. Box 190
Chester, VT 05143
802/875-3535

Weird Wood lives up to its name with wormy butternut and cherry burls. The cherry burls, dried up to 3 years, come in a variety of sizes. 🌲

Have a problem with your subscription?

We want to solve it to your complete satisfaction, and we want to do it fast. Please write to: Robert Austin, *Better Homes and Gardens*® WOOD, P.O. Box 10628, Des Moines, Iowa 50336.

You can help us by attaching your magazine label here, or copy your name and address as it appears on your label. Send this along with your correspondence.

Name	
Address	Apt. #
City	State Zip

Moving? Simply attach the mailing label from this magazine and write in your new address below. (Please allow 4-8 weeks.)

Your New Address Goes Here

Name	
Address	Apt. #
City	State Zip

Subscription Rate:

6 issues — 1 year — \$18. Add \$6 for Canadian or foreign postage.

Renewal New Order

For Fast Service...

... it is better to write us concerning your problem and include the magazine label. Also, address changes are handled more efficiently by mail. However, should you need to reach us quickly the following toll-free number is available:

800-247-2504

Better Homes and Gardens®

WOOD

P.O. Box 10628 • Des Moines, Iowa 50336

DISCOUNT TOOLS
WE OFFER DISCOUNTS UP TO 50% AND MORE ON AMERICA'S BEST NAME BRAND POWER TOOLS
BE WISE — COMPARE

Porter Cable Tools

MOD#	DESCRIPTION	List	Sell
100	Router	141	89
126	Plane	265	169
312	Laminate Trimmer	190	124
330	Block Sander	205	134
361	3x24" Bit Sander	87.50	54
363	4x24" Bit Sander	260	169
690	Router 1 1/2" HP	280	183
690	Router 1 1/2" HP	194	126
9118	Porta Plane Kit	299	199
59381	Hinge Template	199	139

Milwaukee Tools

0222-1	3/8" VSR Drill	146	98
0234-1	1/2" VSR Drill	159	109
0566-1	Drain Cleaner	249	173
1610-1	1/2" Spade Hndl Drill	189	132
1670-1	1/2" Hole Hawg	275	199
3002-1	Rt angl Electricians Drill	253	169
3300-1	Rt angl Magnum Drill	249	169
5399-1	1/2" Hammer Drill	261	179
6377	7 1/4" worm Drive Saw	259	143
6511	2 Spd Sawzall, case	181	119
6539	Cordless Screwdriver	84	59
6543-1	0-1000 rpm Screwdriver	199	138

Senco Nail Guns In Stock
Call For Discount Prices

Freud Carbide
Blades and Cutters

LU72M010	10"x40T Gen Purp	68.58	34
LU85M010	10x80 T Fine Cutoff	110.88	59
DS308	8" Dado Set	179.90	99
90-100	15pc Router Bit Set	229.00	129
94-100	5pc Router Bit Set	248.00	159

Selected Blades — Cutters by Freud up to 50% off Suggested List Price

Makita Tools

1900BW	3 1/4" Planer Kit	178	89
2401BW	10" Miter Saw	329	189
2708	8 1/4" Table Saw	348	199
3601B	Router D Handle	198	118
3612BR	3HP Plunge Router	318	179
4200N	4 3/8" Trim Saw	168	99
5081DW	Cordless Circ. Saw	192	102
5402A	16" Beam Saw	518	299
6012Hdw	3/8" Cordl Scruddrill	188	94
6510Lvr	3/8" VSR Drill	136	76
6800Dbv	0-2500 rpm Screwdr	144	79
6905B	1/2" Impact Wrench	252	135
6906	3/4" Impact Wrench	528	299
9924B	3x24" Belt Sander	208	124
BD4510	Block Sander	86	45
JR3000V	Var Spd Recipro Saw	198	114

Black and Decker Tools

1179	3/8" Drill O-1200	122	69
1990	Cordl Dr. w Clutch	184	99
3051	7 1/4" Worm Dr Saw	246	135
3103	2 Spd Cutsaw	191	89
4010-10	Palm Sander	88	46
6513-09	1/2" Elect. Imp. Wr	179	109

Ryobi Tools

TS251U	10" Miter Saw	329	159
W200S	16 1/4" Beam Saw	499	279
RJ100V	Var Spd Recipro Saw	189	99
E3810	0-2500 Drywall Dr.	119	79
TR30	Laminate Trimmer	119	65
AP10	Planer	689	359

Bostitch Nail Guns
up to 50% off Suggested List Price

PREPAID FREIGHT TO 48 STATES
ANY ITEM THIS PAGE

Bosch Power Tools

1581VS	Jig Saw Orb. Action	230	129
1604	Router 1 3/4 H.P.	209	115
1921vsr	Cordless Drill 3/8"	189	99
90-300	3 1/4 HP Router	500	295
1942	Heat Gun	99	59

Delta Carbide

Blades and Cutters	List	Sell	
35-600	9"x80T TC&F	97.70	58
35-625	10"x80T TC&F	123.05	76
35-604	9"x64T ATB	88.00	49
35-623	10"x80T ATB	116.00	69
35-677	14"x108T ATB	158.85	89
35-647	12"x72T ATB	145.10	79
35-626	10"x60T ATB	83.65	49
35-560	8" Carb Dado Set	190.00	99

Selected DELTA Shaper Cutters up to 50% off Suggested List Price

Hitachi Power Tools

DIOV	3/8" VSR Drill	118	69
D13	1/2" Spade Hndl Drill	178	99
DRC10	3/8" Cordl Scruddrill	159	74
F20A	3 1/4" Planer	154	69
TR6	Laminate Trimmer	138	83
TR12	3HP Router	299	163
C75A	7 1/4" Circular Saw	105	65
W6VA	0-2500 Screwdriver	133	79
CRIOV	Var Spd Recipro Saw	179	107

Skill Tools

651	5 1/2" Circular Saw	99	72
77	7 1/4" Worm Dr Saw	240	129
471	1/2" Impact Wrench disc	139	99
448	3x24" HD Belt Sndr disc	259	99
597	3/8" VSR Drill	96	59
2016-2	3/8" cordl vsr Drill	199	95
1400	4x21 3/4" Belt Sndr	225	157

ABBAY TOOLS

A DIVISION OF ABBAY MACHINERY

616 NORTH BROOKHURST STREET • ANAHEIM, CALIFORNIA 92801
ORDER BY PHONE — WE ACCEPT VISA, MASTER CARD, CHECK, MONEY ORDER

Toll Free 1-800-225-6321 Calif. 1-800-252-2221

Orange County (714) 772-7222

PRICES SUBJECT TO CHANGE WITHOUT NOTICE

Wood-Mizer®

Portable Bandsaw Mills



Prices from
\$3,995.00

EFFICIENT

less horsepower produces more lumber per log

CUTTING CAPACITIES

up to 33' long by 32" diameter

PRECISE

smooth surfaces and accurate dimensions

SAFE

guarded bandsaw blade

Buy direct from the Worlds Largest
Manufacturer of Portable Bandsaw
Mills at any of our three factory locations



For catalogs on our complete product lines, send \$1.00 to:

Wood-Mizer® Products Dept. QQ8

A Division of Laskowski Ent. Inc.

8180 W. 10th St. Indpls, IN 46214 (317) 271-1542

BRANDING IRON

Call toll free
anytime to order
your BrandMark

(orders only)

1-800-237-8400 ext. 720

in Florida **1-800-282-1469 ext. 720**

Mention this Advertisement
and receive \$3.00 off the regular price.

Your Satisfaction Guaranteed

- Convenient torch heating
- Solid Brass—lasts years
- 1st line as shown
- 2nd line—18 letters/
spaces max.
- 1/4" letters
- distinctive border
- \$31.00 ppd
- OH res. add \$1.71 tx



Order by mail from



BrandMark

462 Carthage Dr. • Dept W • Beavercreek, OH 45385
513-426-6843

For families who
enjoy and take pride
in their homes, there
is no more appropriate gift
than a subscription
to WOOD magazine.

Full Size Plans



Build these two great **Fords**. The Model A
is 11", The Pickup is 12". Two plans per set.
Plan No. 18008...\$8.50. Catalog \$1.00 or
free with order. Visa/MC (516) 462-6228.

ARMOR, Dept. L, Box 445, E. Northport, NY 11731

WOODWORKERS! Sand like professionals, quickly and beautifully



• #B-12 Brush Head sands mouldings
and intricate carvings without losing
detail or shape of the part.



Model #DD-63
Gives quick and excellent
results on contoured-
shaped parts.

Everything we sell is industrial quality. Buy the
complete unit or just the Brush Head and/or
Pneumatic Drum and build your own.

*Professional results in no time at all.
Write or use IWWF for free information.*

Sand-Rite 1611 N. Sheffield Ave.
Chicago, IL 60614
MANUFACTURING CO. 312-642-7287

EDGE JOINING CLAMP

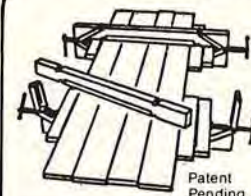

Patent
Pending

"DUO-CLAMP"

**PROHIBITS
BOWING**

- FAST •
- EASY •

**BUTCHER
BLOCKS TOO!**

Holds boards flat while squeezing out excess glue.
A perfect mate every time.

- NO DOWELING • NO PLANNING
- 30 DAY MONEY BACK GUARANTEE**

16" Capacity \$34.50

26" Capacity \$37.50

36" Capacity \$40.50

MASTER CARD/VISA
FREE U.P.S.

Send for **FREE** info:

MARK PRODUCTS

Box 46143

Dept. W8

Bedford, Ohio 44146

SPECIAL NET PRICES ON NEW POWER STAR MACHINES BY POWERMATIC

Model No. 26 POWER STAR
Shaper from \$1,195

Model #66 POWER STAR Table Saw
with Biesemeyer Fence from \$1325

Model #30 POWER STAR Belt
& Disc Sander with Stand from \$810

Miss. residents add 6% tax.

Call us for your special prices on other Freud
and Delta blades and cutters.

Call 800-821-2750 (In Miss. call
800-321-8107) Ask for Tool Department

Addkison
HARDWARE CO. INC.

126 E. Amite St., P.O. Box 102, Jackson, MS 39205

Wood Moisture Meter

- Avoid Moisture Problems
- Protect your Masterpiece

Mini-Ligno
\$110 only

Pocket-Size: 1"x2 1/4"x5 1/4"
Incl. Case, Batteries, and Pins for
3/8" and 1/2" Measuring Depth.

also from Lignomat:

Mini-Ligno E

Range: 6, 7, ...36%

Easy to use, sturdy
instrument for the
professional woodworker
or serious hobbyist. Great for
lumber, veneer, fiberbrds. Ask
for free catalog on all moisture
meters and accessories for kiln
drying. Don't waste money, time on
wet wood, order a moisture meter now.



Lignomat USA Ltd.

503-257-8957 800-227-2105

P.O. Box 30145 bh
Portland, OR 97230

NEW AND UNUSUAL TOOL CATALOG

Over 100 pages of lat-
est books and quality
hand tools at **NEW**
LOW PRICES.
Send for **FREE**
FROG CATALOG
today.

FROG TOOL CO. Ltd.
P.O. Box 8325 Dept. WM7
CHICAGO, IL 60680
Store: 700 W. Jackson
(312) 648-1270

For information about placing
an advertisement in
Better Homes and Gardens® WOOD write:

Mark Hart

WOOD Magazine
750 Third Avenue
New York, New York 10017

Or call collect 212-551-7130



Print this article

WOOD

Holiday Gift List

Just check the items you want, tear out this section and casually leave it where your family can find it. They'll get the hint!



The all new Shopsmith Mark V Model 510 expands your home shop capabilities. The same five functions, with a superior saw table that handles much wider and longer stock. Write DEPT. 513K, SHOPSMITH, INC., 6640 Poe Ave., Dayton, OH 45414 for details.

SUPER 15" SCROLL SAW

Only \$139.95 shipped complete, ready to run. Comparable value over \$500. This versatile machine makes cutting intricate wood patterns easy. Thousands have been used in Europe for many years. PENN STATE INDUSTRIES-W, 2850 Comly Rd., Philadelphia, PA 19154. 1-215-676-7609, ext. 15.



Wooden toy patterns, hardwood turnings, complete kits; also patterns plus turnings kits and woodworking books. Seven full-sized patterns \$5 each; four or more for only \$4 each. Package of eight spoked wheels \$5.95. Catalog free with order. Catalog alone \$1.50. TOY DESIGNS, Box 441, Newton, IA 50208.



Simply cut sandpaper from standard sheets for these sleeveless drum sanders. Holiday special-1" x 3" and 2 1/2" x 3" set, \$27.00 + \$2.50 s/h. Many other sizes available. Money back guarantee. Send check to SINGLEY SPECIALTY CO. INC, P.O. Box 5087B, Greensboro, NC 27403.



Miniature Antique Transport Plans. Designed for the serious scale woodworker. 1849 Concord Coach can be built in 1" scale using our full-size cutting patterns, photos, exploded assembly and instructions. Other vehicles. Catalog brochure \$1. CRISS-CROSS CREATIONS, Box 324, Wayne, NJ 07470.

HARDWOODS OF ILLINOIS

Thin hardwood priced right. Clear, kiln-dried, two sides surfaced. 3" to 10" widths, 3' to 5' lengths. 20 sq. ft. packs, random widths and lengths. 1/2" red oak \$32 pkg.; 1/2" walnut \$40 pkg.; 1/2" pecan \$25 pkg. 1/4" and 3/8" also available at same price. Prices include UPS delivery. Send check or MO with order. HARDWOODS OF ILLINOIS, RR4, Box 618, Mt. Vernon, IL 62864.



Solid 1 3/8" hard maple hearts in several thicknesses for craft, decor, and art work. 100 hearts 1/4" thick @ \$14.00 ppd. Also dowels, pegs, plugs. MIDWEST DOWEL WORKS, 4631 Hutchinson Rd., Cincinnati, OH 45248.



15-piece Freud carbide router bit set and 1 HP router from Ryobi make an excellent gift for the holidays. Total list value for the pair is \$479. Now available from participating Freud dealers on sale at \$259. Call 800-334-4107 for your local distributor.

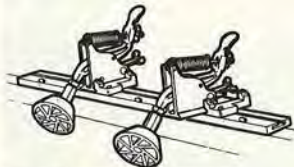

The new, improved Shophelper Anti-Kickback stock feeder holds stock down and minimizes binding better than ever. New features include slotted track for horizontal adjustment, dovetail bracket for smoother adjustment and much, much more! Set complete with brackets \$79.50. 24" trak, 2 gibs, hardware \$29.95. 12" trak, 1 gib, hardware \$16.95. Call 800-344-7455, CA 800-828-8833.



Brand your wood or leather work with your name or logo with the Craftmark™ electric branding tool. Crisp, clear brands are easily made with this self-heating, U.L. listed tool. For more information contact: WALL LENK CORPORATION, Dept. WFD, P.O. Box 3349, Kinston, NC 28501.



100 things a kid can make. This interesting collection was prepared for kids 10-15. No special skill is required because full size patterns are so complete that it is only necessary to follow the simple directions. Included are windmills, weathervanes, birdhouses, toys, shelves, doll furniture, gifts, plus many other things. \$7. MASTERCRAFT PLANS WEST, Dept. 10, P.O. Box 625, Redmond, WA 98073.

WOOD

Holiday Gift List



Free! \$18.95 hardwood parts organizer with the purchase of our woodworking or toymaking parts selections. To receive hundreds of the most needed woodworking or toymaking parts, send \$47.95 ppd. and receive the \$18.95 organizer free! Parts in both organizers are below prices in our catalog. Please specify toy or wood parts selections. CHERRY TREE TOYS, INC., P.O. Box 369-309, Belmont, OH 43718. Catalog #1.



Ring Master cuts concentric rings from flat wood, up to 12" in diameter. These rings can be cut at any angle or straight and will stack to create any hollow cylindrical shape. After the project is glued, it is returned to the Ring Master for final sanding and finishing. The newly patented machine, which is absolutely safe, can create an infinite variety of hollow shapes. RING MASTER, INC., P.O. Box 8527-A, Orlando, FL 32856, 305-859-2664.



Sand like a professional, quickly and beautifully. The B-12 brush head top sands mouldings and intricate carvings without losing detail or shape of the part. Model # DD-63 (bottom) gives quick and excellent results on contoured-shaped parts. Both industrial quality. SAND-RITE MANUFACTURING CO., 1611 N. Sheffield Ave., Chicago, IL 60614. 312-642-7287.



Bandsaw owners! A new tool is now available that enables craftsmen to make or repair any length band saw blade in minutes! Our splicer is available in two models: 1C-001 for 1/4" to 3/4" blades and 1C-002 for 1/8" to 3/8" blades each \$49.95 ppd. The tool comes complete with detailed instructions and supplies for approximately 100 splices. NEW MILFORD SPECIALTIES CO., Dept. BHG, 24A South Main St., New Milford, CT 06776. 203-426-4276.



Woodcraft Supply Corp. has combined the beauty and reliability of rosewood and brass in this classic marking set every woodworker will be proud to own. Set includes 6" try square, 9" bevel, and adjusting pull slide marking gauge. Best of all it is value priced at only \$32.50 postage paid. Write WOODCRAFT SUPPLY CORP., Box 4000, Woburn, MA 01888 or call 800-225-1153.



Like a third hand. Provides that extra support so often needed. Its rugged, heavy duty, all-steel construction makes it a tool you'll depend on for years. Roller is 13" long, galvanized and ball bearing. Adjusts in height from 25 3/4" to 45". When you're done, it folds flat. #HPR-13 \$39.95 + UPS. HTC PRODUCTS, INC., toll free 1-800-624-2027; (in Mich.) 313-399-6185.



Ryobi's top of the line Cordless Driver/Drill 9.6 Volts. 2 speed with clutch, mechanical gear reduction and speed control. Only \$99. You can pay more, but you can't buy better! THE SOURCE, 7305 Boudinot Drive, Springfield, VA 22150. Call toll-free: US 800-452-9999, VA 800-468-1778. Send \$3.00 for the most complete catalog of fine hand tools and cabinet-maker supplies.



Personalize your wood items quickly and easily with this brass branding iron. First line: HAND CRAFTED BY; second line—your choice up to 20 characters including spaces. Compact size. \$26.00 ppd. Guaranteed. Order toll-free: 1-800-826-7606 (Nebr. residents call 402-464-0511) or by mail from NOVA TOOL CO., P.O. Box 29341, Dept BGL, Lincoln, NE 68529. Shipped within 1 week.



Timbers' Woodproject Directory is your guide to hundreds of free woodworking projects. Illustrated guide to 768 projects published in national magazines, patterns or books. How to order patterns, books & how to get free photocopies. \$21.95 includes free notebook; catalog free. TIMBERS/LAKE TAHOE, INC. 2911 Lake Forest Rd., Carnelian Bay, CA 95711-0850. 916-581-4141.



Cut the most intricate patterns in wood, plastics, light metals, etc. Just add your own 1/4 hp electric motor to an Excalibur II, and start cutting! \$495 US. Includes 72 blades, wrenches, and manual. Try it for 30 days. You must be satisfied, or purchase price refunded. In the U.S., call toll-free 1-800-387-9789, in Canada call collect 416-293-8624. J. PHILIP HUMFREY INTERNATIONAL, 3241 Kennedy Road, Unit 7 Scarborough, Ontario, M1V2J9.



Eli Terry mantle clock is a museum-quality reproduction. Easy to assemble, door glass beautifully silk-screened in gold, black and red. Quartz pendulum movement is accurate + or - 15 seconds a month. Kit includes precision cut wood parts, silk-screened glass, solid brass hardware, quartz movement and brass and wood pendulum. Regularly \$149, now \$119. Phone orders, 1-800-321-1089 or 205-943-5081. MC, Visa, AE. VIKING CLOCKS, P.O. Box 490, Foley, AL 36536.



Video tape! Most tablesaw owners reach the maximum knowledge of their saws within a few weeks. Now you can get professional and instructional guidance from master craftsman Jon Eakes, "Mr. Chips" on T.V. This is a 60-minute, high budget production! Only \$29.95 prepaid to you! Model G1626 VHS or G1627 Beta. GRIZZLY IMPORTS INC., P.O. Box 2069, Bellingham, WA, 98227. 206-647-0801.



This limited edition "American Classic" router is a special anniversary model from Porter-Cable. It features 3/4 HP and a solid die-cast aluminum housing. Special introductory price: \$135.00. W.S. JENKS & SON, 1933 Montana Ave. NE, Washington, DC 20002. 1-800-638-6405.



If you value your fingers, you need a RIPSTRATE®. It holds the work tight against the fence with no hands near the blade. Makes perfect, straight cuts. Wheels lock to prevent kickbacks. Requires no adjustment for stock width or thickness. Over 15,000 now in use. One-year guarantee, 30-day money back trial. \$69 prepaid. Check, M.O., Visa or MC. Free brochure. FISHER HILL PRODUCTS, 4 Fisher Hill, Fitzwilliam, NH 03447. 800-421-0256.



These dinosaur kits make great gifts for young and old alike. Die-cut of gum plywood, they assemble like a jig-saw puzzle. They are packaged in colorful cartons which describe these prehistoric giants. The spinosaurus (shown) is 20" long. Price is \$8.50 post-paid. Buy three all different for \$22.50 postpaid. ARMOR PRODUCTS, Box 445, East Northport, NY 11731. 516-462-6228.



Roto/Carve, a wood contour shaper, is an attachment for a table saw. Coordinated rotary motion of pattern and workpiece rapidly copies irregular shapes such as duck decoys or gunstocks. ROTO/CARVE, 6509 Indian Hills Road, Minneapolis, MN 55435. 612-944-5150; WATS 800-533-8988.



Special Christmas Sale—50% off all Forrest Woodworker saw blades. Super smooth cuts! Woodworker I radial saw 60T 8"-10" sizes all 50% off! Now \$75-\$81. Woodworker II table saw blades 40T and 30T 7"-10" sizes 50% off! Now \$49-\$78. Also: Dado 24 T only \$299, B/16 set now \$209, 4"-6" dampers now only \$20-\$23. Phone toll-free 1-800-526-7852 (in NJ: 201-473-5236). FORREST MANUFACTURING COMPANY INC., 250 Delawanna Ave., Clifton, NJ 07014.



Seven-piece brad point woodbit set, \$10.00 ppd. German made chrome vanadium "no walk" woodbits keep your drill on target. Razor sharp—they cut crisp, accurate holes for doweling and precision work. Set includes 1/8", 3/16", 1/4", 5/16", 3/8", 7/16" and 1/2" sizes. 3/8" shanks. In a plastic pouch. Order your seven-piece woodbit set from BOB MORGAN WOODWORKING SUPPLIES, Dept. W06M18, 1123 Bardstown Road, Louisville, KY 40204. \$10.00 ppd.



DMLs 10" Radi-All is the best and safest blade for radial arm saws. The specially engineered angle virtually eliminates overfeed and makes extremely smooth cuts through all woods. 5/8" bore, C-4 carbide. Save \$20.00 through Christmas. #D1060R, only \$59.95. WOODWORKS, 4013-A Clay Ave., Fort Worth, TX 76117. 817-281-4447. Visa/MC accepted.



Innovative, German-designed, wall-hung tool cabinet with 44 snap-on/stay-put hooks and brackets included; safely stores your hand and power tools. Opens to 54" wide, puts all tools within easy reach, arranged the way you want them. Made from high strength, corrosion-proof PVC in attractive orange color with grey side panels, 27 1/2" w x 19" h x 7" d. Only \$45.00 plus \$6.75 s/h. Order from CONCEPT 2001, INC., 1321 N.W. 65th Place, Ft. Lauderdale, FL 33309. 305-979-5802. Visa and MC accepted.

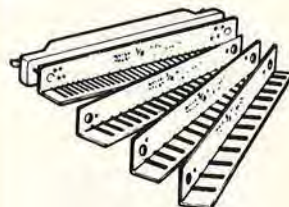

New! The ideal Christmas gift. Accujoint—make precision finger joints on your table saw! Just set your blade and Accujoint will index your work exactly. Perfect every time. Now—make fine joints with ease! Only \$39.95—money-back guarantee. MORSE DESIGNS, INC., P.O. Box 195, Boston, MA 02123. Call 1-800-222-8011. Mass. 617-262-8436.



Professionally designed project plans. Cutting boards, table lamps, furniture items and more. Send \$2.00 for this idea-filled catalog and get \$2.00 off your first order. THE WORKSHOP BLUEPRINT CO., P.O. Box 65725, West Des Moines, IA 50265.

WOOD

Holiday Gift List

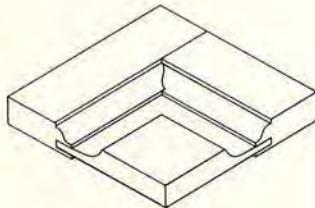

The original Ogee Door Shop™ as featured in Wood Magazine May/June 85, is complete with style and rail, slot and panel raising bits for the 1/4" chuck router. Bits are carbide tipped and BB and will make 3/4"-2 1/4" thick raised panel doors. Comes with 37-page illustrated manual. \$89.50 ppd. ZAC PRODUCTS INC., 34 Renwick Street, NY, NY 10013. Call 800-441-0101. In NY 212-947-4496.



Personalize your finished projects with BrandMark's solid brass, torch-heated branding iron. Easy to use, lasts for years, satisfaction guaranteed. Makes an ideal gift. Custom irons available. Standard "Handcrafted By" and your name (18 letters) \$31.00 ppd. Check, Visa and MC accepted. Order from: BRANDMARK by F&K, Dept. W, 462 Carthage Dr., Beavercreek, OH 45385. 1-800-237-8400, ext. 720 or 513-426-6843.



Carving tool kit: Give dad a quality American-made Warren Tool Kit #KBL3-W. Includes a walnut and brass interchangeable handle and three high carbon steel blades honed ready for use. Send \$20.40 ppd. for the kit or 60¢ for a complete catalog and let dad choose one of over 500 items offered with a money-back guarantee. WARREN TOOL CO., INC., Rt. 1, Box 14-A, Rhinebeck, NY 12572, UPS/COD call 914-876-7817.



Portable sawmill system—you can harvest your own wood with the Sperber Sawmill. No need for heavy equipment. Cut lumber to size where it falls. Many of our customers have paid off their mill with one weekend's cutting—or less. Send \$1.00 today for brochure package and start milling your own wood. SPERBER TOOL WORKS, Box 1224, West Caldwell, NJ 07007. 201-744-6110.



High performance, large capacity planer! Unbeatable price! The Delta 13" Planer is a must for home and school shops with rugged design, tough enough for industrial use, as well. ACME ELECTRIC-TOOL CRIB OF THE NORTH. 1-800-358-3096, ask for Mike, MC/Visa.



An outstanding value. Jet's JBS-14 woodworker bandsaw, 6"x 14" capacity, 3/4 HP motor, table tilts 45°. Includes stand and miter gauge \$398.00 FOB: regional warehouse. ROBERTS HARDWARE, P.O. Box 1276, Taylors, SC 29687. Call today for Christmas delivery 803-879-2470.



Moisture related problems such as shrinking, warping, cracking can ruin the most beautiful wooden pieces ever built. Avoid wood moisture problems by checking the wood with a moisture meter! The pocket-size Mini-Ligno moisture meter is for the serious hobbyist and professional woodworker. For more information contact: LIGNOMAT, P.O. Box 30145, Portland, OR 97230. 800-227-2105, 503-257-8957.



Highest quality brass tack tenon saw. Pax mirror buffed solid brass back for cutting straight cuts. Electric furnace steel blade, red Beech handle. Hand sharpened, set, and straightened. A perfect gift. 832B8-blade length 8" teeth/inch 14. \$24.95 ppd., regularly \$36.75 ppd. FROG TOOL CO. LTD., 700 W. Jackson Blvd., Chicago, IL 60606. (312) 648-1270.



A fine gift for the wood aficionado is the book *Know Your Woods*, by Albert Constantine, Jr. A complete up-to-date guide to wood identification. An encyclopedia of over 1400 wood names and characteristics. Over 100 magnificent wood grains illustrated. Hard cover. Postpaid price \$22.00. CONSTANTINE, 2050 W. Eastchester Rd., Bronx NY 10461.



A great shaper at a sensational price! CMP-2 features a 2 HP, two-speed (9,000/12,000RPM), reversible, 3/4" and 1/2" spindles, router bit collet, four hold down clamps, 19 3/4" x 19 3/4" cast iron table, dovetailed mitre, 2 1/2" verticle spindle travel, 254 lbs. net, 220 volts—single or three phase. Order today! \$795, freight included. CASCADE PRECISION TOOL CO., Box 848, Mercer Island, WA 98040. 800-235-0272; in WA 206-236-0272. Visa/MC.



Now better than ever! The Hegner Multimax-2, with a 60% larger table than last year, is available at special prices this Holiday season! Still the most popular saw of its type, the Multimax-2 offers your special woodworker abilities not given with any other tool. Send for free information, and save on your Hegner now! ADVANCED MACHINERY IMPORTS LTD., P.O. Box 312, New Castle, DE 19720. Call 302-322-2226.



Recane for fun and profit. Recane or re-rush heirloom chairs—for yourself or for others as a profitable hobby—with our full line of materials and instruction books. Illustrated catalog with complete how-to-do-it information, prices, order form: \$1 (refundable). CANE & BASKET SUPPLY CO., 1283 S. Cochran, Dept. W, Los Angeles, CA 90019.



Introducing "Merle", the adjustable corner clamp. This unique clamp forces your project into square. Fully adjustable from 2 5/8" x 2 5/8" to 36" x 36". Perfect for clamping picture frames, cabinets or anything which requires 90 degree corner clamping. "Merle" is cast aluminum and steel construction, a true industrial quality tool. The "Merle" clamp is quick and easy to use. \$18.95. MLCS LTD., P.O. Box 53-D, Rydal, PA 19046 or call toll-free 1-800-523-2445, ext. 56. (In PA 1-800-346-7511, ext. 56.) Visa/MC.



Jorgensen Aluminum Bar Clamp has a great strength/weight ratio and doesn't react with glue or water to cause unsightly stains. It's ideal for fine woodworking, delicate assembling, and whenever lightness and strength are required—just the right clamp for light duty. Available through your favorite hardware store, home center or local distributor. AJUSTABLE CLAMP COMPANY, 410 N. Ashland Avenue, Chicago, IL 60622. 312-666-0640.



Perfect edge-joining every time! Throw away your drill jigs and all other tools! This new "Duo-Clamp" for the serious woodworker solves alignment problems, squeezes out excess glue and eliminates bowing. Made of sturdy maple. 16" capacity \$34.50, 26" capacity \$37.50, 36" capacity \$40.50. Free UPS, free information. MARK PRODUCTS, P.O. Box 46143, Bedford, OH 44146.



The ideal gift—inflatable drum sanders. Depending on how much air you pump in, the air cushioned drum can be soft and flexible for curved surfaces; or, hard and rigid for working flat surfaces. Stock removal, with either surface, is rather fast, but controllable. An ordinary bicycle pump will fill the drum. One abrasive sleeve included. Six sizes from 1 1/2" x 4" x 3/8" shank—only \$29.95. Up to 4" x 5 1/2" x 5/8"-11 internal thread—only \$34.95. THE FINE TOOL SHOPS, 20-28 Backus Ave., Danbury, CT 06810. Call toll-free 1-800-243-1037. (In CT 797-0772.)



Drum Sander attachment for radial arm saws \$179.95. This space-saving attachment quickly converts any radial arm saw to a surface thickness sander for quick, even surfacing and finish sanding up to 44" wide. The Performax Sander also allows precise dimensioning of boards and parallel edge jointing. PERFORMAX PRODUCTS CO., 17065 Judicial Rd., Dept. WS12, Lakeville, MN 55044. 1-800-328-5727, ext. 114; in MN 1-800-742-5685, ext. 114.



Edlco is offering a bundle for the holidays. 10 board feet of 3/8" shorts, 3" and wider, 18"-36" long in cherry, oak or walnut. Bargain priced bundle includes a "How To" project book and top-grade lumber catalog! Only \$39.95 delivered. Offer good through Dec. 15th only. Specify species and send check or money order to EDUCATIONAL LUMBER COMPANY, Box 5373 W, Asheville, NC 28813.



The new Delta Universal Wet/Dry Grinder is a dual purpose tool that handles any sharpening job in the home workshop. 10" wet wheel keeps hardened cutting tools cool when grinding to protect temper; 5" dry wheel grinds almost anything that requires a precision-honed edge. Built to deliver long-lasting, smooth performance, the unit is backed by a two-year limited warranty on machine, parts and accessories. DELTA INTERNATIONAL MACHINERY CORP. For additional information call toll-free: 800-438-2486. In PA, 800-438-2487.



Colonial pendulum clock kit, \$34.95 ppd. Styled after the colonial period in fine furniture. Made of solid select oak. Kit comes complete, unfinished, finely sanded, 8 5/8" x 20 1/2". Order #CS665, call toll-free: 1-800-843-3320. Free catalog with order. VAN DYKE's, P.O. Box 278, Woonsocket, SD 57385.



The perfect sanding-grinding machine. Uses standard 1"x 42" sanding belts and comes complete with 8" disc grinder. The disc and belt sander tables tilt from 0° to 45°. Sand, grind, deburr, sharpen or polish any material. 1" belt sander with 8" disc (catalog #01301), \$119.95, shipped free in continental USA. INDUSTRIAL ABRASIVES CO., P.O. Box 8611, Dept. B, 642 N. Eighth St., Reading, PA 19603.



\$49.00 lumber sale. We offer surfaced (3/4"), UPS-delivered packages of the following species (in parentheses are the number of sq. ft. per package): walnut (14), birdseye maple (12), mahogany (14), cherry (14), African padouk (9), 1/2" quartered oak (22), 1/2" walnut (22) and a random mixture (15). Indicate species desired and include a check, or phone and use MasterCard/Visa. (Destinations west of Denver add \$7.00/pkg.) Our latest catalog included, listing dozens of other species of lumber and veneer. WYNDHAM WOODS, PO Box 506, Ellettsville, IN 47429. 812-334-7735.

WOOD

Holiday Gift List



Buy this superb wooden block plane for about the same price that you pay for a high quality steel plane. Made in Germany, it has a lightweight hornbeam body and super-tough lignum vitae soleplate. Craftsmen use one for fine planing, shaving end grains, etc. \$40.00 ppd. Catalog containing our full line of furniture plans and wood-working items, \$1.00, refunded with 1st order. HAMMERMARK ASSOCIATES, Box 201-GL, Floral Park, NY 11002.

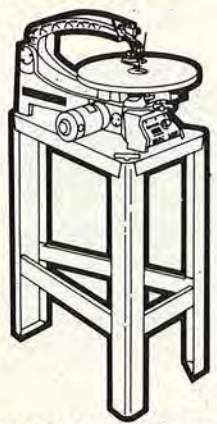

Holiday special for you. Delta's 18" electronic variable speed scroll saw. Lets you dial the exact speed you need. 2" thick capacity. Includes steel stand, solid state 115v motor and 96 assorted blades. List \$1117.00 Sale \$699.00 fob HILLER HARDWARE, 1411 Assembly St., P.O. Box 1762 Columbia, SC 29202. Call 803-779-3131. Major credit cards accepted.



Protect his eyes. Large 66mm, scratch, fog, chemical & ultra violet resistant lenses. Ratchet hinged front insures perfect fit. 2 sizes: normal male size plus smaller female size. We offer many more quality personal protective products. Just call or write us for free "Head to Toe" safety catalog. KENCO SAFETY PRODUCTS, PO. Box 385, 78 Glasco Turnpike, Woodstock, NY 12498. In New York State call 914-679-5246. All others, 800-341-4103.

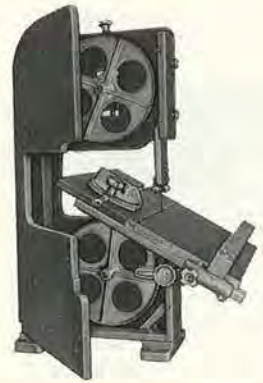

Power tools for woodworkers—12" band saw, 18" band saw, 6" belt sander, wood shaper, lathe and circular saws. Plans and kits of metal parts to build your own. Plans only \$5 each plus \$1 postage. Kits \$34.99 to \$189.99. Great gift for the hobbyist. GILLIOM MFG., INC., 1700 Scherer Pkwy., St. Charles, MO. 63303. 314-724-1812.



Router bit special. Freud Model 94-100 5-piece router bit door system allows you to produce raised panel cabinet doors with your 1/2" router. The profiles are: stile, rail, raised panel, door lip and glue joint. Bits come in wooden box. Sale \$179.95 ppd! R.A. NESS & CO., The Woodworkers Emporium, 8888 N. Milwaukee Ave., Niles, IL 60648. 312-824-0565.



Is this the world's best joiner-planer? We think so and invite you to take a closer look! MiniMax's new FS-35 joiner-planer combines industrial quality with an affordable price that will appeal to professionals and amateurs alike. THE XYLOPHILES CO., 138 E. Loudon Ave., Lexington, KY 40505. 800-354-9083.



TF-65 Shaper. The EMCO moulder/shaper is for curved profile workpieces, tongue and groove joints and for sanding straight and curved edges. Big 2.5 HP motor, 3/4" spindle and cutter speeds 5400/7200/9600 rpm. \$635 list. Ask for your nearest dealer. EMCO USA, P.O. Box 07795, Columbus, OH 43207.



The Total Shop multi-purpose tool. It's a 10" table saw, 34" lathe, 16 1/2" drill press, horizontal boring machine and disc sander—5 tools in 1 quality machine. 1 1/2 HP motor develops nearly 3 HP! Send for our 30-minute video demonstration tape (VHS or Beta). Include \$20.00 refundable deposit. TOTAL SHOP, Dept. Q1, P.O. Box 16297, Greenville, SC 29606.



Executive wood toys! Now you can create this 1929 Ford show piece and many others like it from our detailed and easy-to-read patterns. We offer you a complete line of patterns, parts, and wheels. Make this holiday season a time to remember with one of our executive wood toys! Send \$1.00 for catalog to: TOYS AND JOYS, Box 628 GL, Lynden, WA 98264.

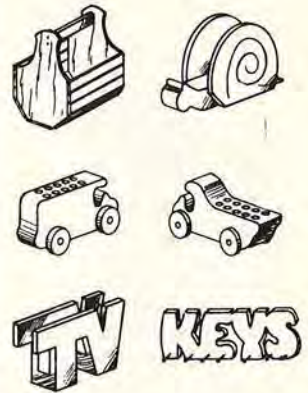

Over 125 full size patterns! Create wooden gifts, toys, household accessories... more! These trace and cut designs are simple enough for the beginner, fun and profitable for the pro. Blueprint patterns plus "Shop Secrets" and brochure only \$7.00. ACCENTS (GA-116), Box 262, Danvers, MA 01923.



Precision Movements

features
"CUT-OUT" CLOCK KITS

Everything You Need To Make A Clock
... In One Package!

Each "Cut-Out" Clock Kit Includes:

- QUARTZ MOVEMENT - N" SHAFT
- HOUR, MINUTE AND SECOND HANDS
- ADHESIVE BACKED CLOCK FACE
- SAW TOOTH HANGER
- SOLID PINE CLOCK BLANK
- ILLUSTRATED INSTRUCTIONS

YOUR CHOICE ...

ONLY \$10.95 EACH*
Suggested Retail Value \$17.95 EACH

UNICORN
7 1/2" x 8 1/2" Part# Y3UNICMP
DEER
7 1/2" x 11 1/4" Part# Y3DEERMP
*Add \$2.50 Shipping & Handling,
7% Residents Please Add 6% Sales Tax



FALL 1986 CLOCK CATALOG \$1.00

Presenting Our Fall Line Of
Clock Movements, Supplies & Accessories
IN FULL COLOR

Phone or Write For Your Copy Today!
215-967-3156

P.O. BOX 689 • DEPT. G • EMMAUS, PA 18049

Make Signs?

If you make or are interested in wood signs, you'll want SignCraft — the magazine for the sign artist. You'll see creative wood signs in every issue — carved, routed and sandblasted — plus how to's, pricing, technical help and more! Your satisfaction is guaranteed.

- 1 yr. (6 issues) . . . \$21
- 1 yr. Outside U.S. (U.S. funds) \$27

SignCraft Magazine
P.O. Box 06031-W, Ft. Myers, FL 33906

BUILD IT YOURSELF

TOYS • PUZZLES • PLAQUES • PLANTERS
FURNITURE • LAWN ITEMS • BIRD HOUSES
ROCKING & RIDING HORSES • PLAY SETS



BLUEPRINTS

CREATE HUNDREDS OF ITEMS ILLUSTRATED
WITH SAME SIZE PATTERNS CATALOG \$1
PLUS WHEELS AND BOOKS

Design Group, Box 514-Z, Miller Place, N.Y. 11764



Love At First Sight

Scale woodworkers will fall in love with this 1" scale miniature of an 1849 CONCORD STAGE COACH. FULL SIZE CUTTING PATTERNS, (NOT A KIT!), PHOTOS, ASSEMBLY VIEWS and CONSTRUCTION HINTS FOR EASY BUILDING... \$1495. • Conestoga Covered Wagon/ 1893 Duryea Motor Car - the first gas auto. 1" scale. \$1495 each. "Making Model Horse Drawn Vehicles" by John Thompson ppbk, 94 pages w/plans and techniques for miniatures. \$15.95. With this ad- 2 patterns \$25 • 3 patterns \$36.95 • All 4 items \$49.95. Please add \$2 hdlg/insur. NJ res. add 6% tax. Visa/Mastercard \$20 minimum. Tel. orders: (201) 835-9339. CRISS-CROSS BOX 324BA WAYNE, N.J. 07470

SWINGING CRADLE

EASY TO MAKE WITH

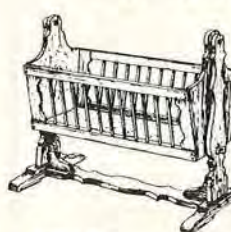

Full-Size Plan

Authentic spindle design straight out of Colonial America. Plans show alternate construction with panel sides. Perfect for baby or use for magazines. Size: 20" x 39" x 30" high. Order plan #166 . . . \$9.00

CATALOG
180 diff., full-size prof. furniture plans—\$2.00 (catalog free with order)

FURNITURE DESIGNS, Dept. BP-116
1827 Elmdale Ave., Glenview, IL 60025

Van Dyke's

Presents a
Catalog

with supplies for upholstery, antique restoration, wood working, caning, brass hardware, carvings and many related trades!



36 Years in Creative Arts & Trades

Many Hard-To-Find Items!

SEND \$1.00 FOR CATALOG TO:
Van Dyke's Restorers
Dept. D55 - Woonsocket, SD 57385

DOWELS - PLUGS - PEGS

Manufacturer Direct
Largest & finest selection Oak, Walnut, Hickory, Maple, Cherry, Mahogany, Teak, even Treated Dowels. Quantity discounts.

MIDWEST DOWEL WORKS, INC.
4631 Hutchinson Road
Cincinnati, Ohio 45248
(513) 574-8488



DOWELS
1/4" - 2" Diameter

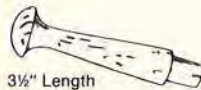

SHAKER PEGS
Hard Maple
Poplar
Oak, Red or White
Walnut
Also Mini-Pegs

DUTCH WALL PEG
Hard Maple
Oak
Walnut



4" Length

Catalogue on Request

WOODWORKERS

Save on Wood - Tools - Supplies!

OVER 4000 ITEMS

Finest Dimensioned
HARDWOODS and
Quality VENEERS

42 Varieties 1/64" to 4" Thickness
Fast service on choice kiln dried Wood and Veneers, Moldings, Trim, Hand and Power Tools, Lamp Parts, Upholstery Supplies, Clock Movements and Kits, Hard-to-Find Hardware, Finishing Materials, Books . . . over 4000 items in stock! Craftsman — Woodworker's best friend.

Send for New 1987 148 Page Money Saving CATALOG



FREE with Catalog
-\$3.00 Discount Coupon
Good on First Order

CRAFTSMAN WOOD SERVICE

Dept. K-126, 1735 W. Cortland Ct., Addison, IL 60101
Please enclose \$1.00 to help pay postage and handling.

BAND SAW BLADES

WELDED TO YOUR EXACT LENGTH

WIDTHS	TEETH	PRICE/INCH
1/8" thru 5/8"	3 thru 32	\$.05

COMPLETE BAND SAW BLADE LINE
INCLUDING SAW MILL BLADES

TO FIGURE PRICE:

Inch Length x Price/Inch + \$1.85 Weld Charge

MINIMUM ORDER \$10.00 Add \$2.50 per order for packing and shipping. MasterCard and VISA accepted.

TO ORDER Phone or write to:
BUCKEYE SAW COMPANY
P.O. Box 14794, Cinti., OH 45214
1-800-543-8664 (Except Ohio)
1-513-621-2159 (In Ohio)

NEW! THE IDEAL CHRISTMAS GIFT



Just set your blade, accujoint will index your work exactly! PERFECT EVERY TIME

MONEY BACK GUARANTEE

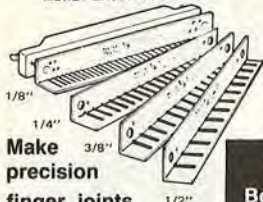

Only \$39.95

PLUS \$2 (in U.S.)
Shipping & Handling
Mass. residents add 5% tax

Morse Design
P.O. Box 195
Boston, MA 02123

TO ORDER — INFO

CALL 1-800-222-8011
Mass. (617) 262-8436

BUILD A CLASSIC

2 Full Size Patterns for
Chrysler Sedan & Graham
Bros. Truck - Plus Catalog
- \$10.00



10 Spoke Wheels - Plus
Catalog - \$7.50
Catalog Alone - \$1.50.



TOY DESIGNS

DEPT. BW1286 • BOX 441
NEWTON, IOWA 50208

22 1/2° OCTAGON GAUGE

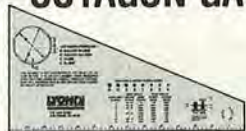

TO SET MITER TO SAW BLADE FOR 22 1/2° CUT. HARDENED ALUMINUM GAUGE HAS OCTAGON FORMULAS AND 14" RULER SCREENED ON. ALSO SCREW CHECKER AND INFORMATION.

\$7.95

Plus \$2.00 Handling and Shipping

California residents add 6% sales tax. Send check or money order to:

LYON

ELECTRIC COMPANY, INC.
SAN DIEGO, CA 92138

VISA/MC

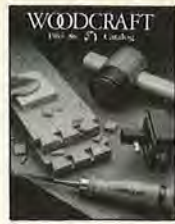

FREE Tool Catalog

Quality Products For Woodworkers

Send today for your FREE copy of our new colorful catalog. It's fully illustrated with the finest quality tools, supplies, books, components, hardware, and much more. Satisfaction Guaranteed. Write today for your FREE catalog.



WOODCRAFT SUPPLY CORP.
Dept. WBE116
41 Atlantic Avenue, Box 4000
Woburn, Massachusetts 01888



CAROLINA SHOW

Charlotte Civic Center
Charlotte, N.C.

NOV. 21, NOON - 6 PM
NOV. 22, 10 AM - 6 PM
NOV. 23, 10 AM - 5 PM

**EXHIBITS & SALES
FREE SEMINARS**

ADMISSION \$5
Workshop With Liam O'Neill
World Famous Bowl Turner
FOR MORE INFO:
W.A.N.A.

P.O. Box 706, Plymouth, NH
03264
(603) 536-3876



BUILD THIS COLONIAL SLANT TOP DESK

You can order plans for this fabulous reproduction

The original is crafted in pine but you can build yours of hardwood if you prefer. Clever use of moldings and easy building techniques make this beauty surprisingly easy to build.

To order, specify DESK 837. Send check or money order for \$10.00 (Canadian residents remit postal money order in US funds) to: HAMMERMARK ASSOCIATES, Box 201-N, Floral Park, NY 11002. Allow four weeks. NY residents add sales tax. Catalog \$1.00, free with all desk plans orders.



Kid's Kitchen Appliances

Little cooks will love these! Send for clear concise plans to build all of the above items.

PLAN #582-W \$ 8.95
OUR NEW CATALOG ... \$ 2.00
POST & HANDLING ... \$ 1.50
TOTAL \$ 12.45
Catalog price is refundable with next order. Iowa residents add sales tax.



P.O. BOX 65725, WEST DES MOINES, IA 50265



RECAVE for fun and profit

Recave or re-rush heirloom chairs — for yourself or for others as a profitable hobby — with our full line of materials & instruction books.

Since 1934 America's largest selection of caning & basketry materials & supplies —

- Superior quality weaving cane & machine woven cane
- Flat oval & round reeds
- Fibre & genuine rush
- Danish seat cord
- Raffia, rattan, seagrass
- Hoops & handles

Illustrated catalog with complete how-to-do-it information, prices, order form: \$1 (refundable with 1st order)

CANE & BASKET SUPPLY CO.

1283 S. Cochran, Dept. W, Los Angeles, CA 90019

MAKE WHIRLIGIGS Wood TOYS

100's of plans, parts, kits, books, finishes & supplies for toys, whirligigs, classic autos, swing sets, doll houses, crafts & furniture. Also toy, craft, game & furniture parts in maple, oak, walnut



DUCK KITS
\$19.00 Precut Kit
just assemble & paint
\$15.00 Uncut Kit
just cut, assemble & paint

& cherry. Bulk prices available. Color catalog subscription \$1. (614) 484-4363
Cherry Tree Toys, Box 369-409, Belmont, OH 43718

FULL SIZE WOODWORKING PATTERNS

SIMPLE TO MAKE - FUN - PROFITABLE

Check the packets of Interest to YOU!

- 75 pattern packet plus "Shop Secrets"
- Over 50 "Folk Art" patterns
- 8 "Wind-Action" whirligigs packet
- 40 craft plaques plus projects
- 27 toy cars, trucks, train, ferry & more!
- 6 decorative magazine racks

Send \$7.00 per blueprint packet or choose any 3 FOR ONLY \$14.00.

ACCENTS, Dept. MA116, Box 262, Danvers, MA 01923

Brochure of 500 designs \$2.00 (Free with order)

HORTON BRASSES
Nooks Hill Road, P.O. Box 120J
Cromwell, CT 06416 (203) 635-4400
HORTON BRASSES are authentic copies of 17th, 18th, 19th & early 20th century pulls



Mfrs. of Cabinet & Furniture Hardware for Homes & Antiques.
Send \$2.00 for a Catalogue.

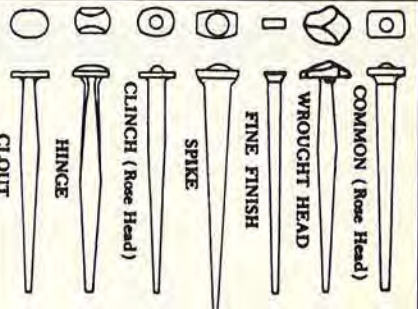

Old-Fashioned Cut Nails. The Tremont Nail Co. makes 20 varieties of cut nails using the old patterns, including rosehead, oval bung, and wrought-head. Sample kit containing one of each of the 20 patterns, a history of nails in America, and a price list is \$3.75 ppd. Tremont Nail Co., Dept. W106, Box 111, Wareham, Mass. 02571.

SPECIAL OFFER

BRANDING IRON

For hard and soft wood

HAND CRAFTED BY YOUR NAME HERE

\$2400

Plus \$2.00 for shipping and handling
Nbr. residents add correct sales tax

SATISFACTION GUARANTEED or your money back

- Shipped in 1 week
- Solid brass head — deep cut letters
- First Line: HAND CRAFTED BY — as above
- 2nd line: Your choice — 20 characters/spaces max.
- Compact size
- As above but with 3rd line — \$37.00 + \$2.00

ORDER TOLL FREE 1-800-826-7606 (except Nebraska)
In Nebraska 1-402-464-0511

Brochure/info on other models, write or call (402) 464-0511

Order by mail from: **NOVA TOOL CO.**
4533 Colfax Circle, Dept. BHC86
P.O. Box 29341, Lincoln, NE 68529

FUN WOOD

Crafts & Toys

Woodworking Plans & Patterns

Large 24" Dump Truck
Order #Ty-Ph-102
\$9.00

Doll Cradle
22" Long
Order #Ty-CR-103
\$8.00

Wood Truck
Order #Ty-TR-103
\$8.00

Both Plans \$15.00
Brochure only \$1.00

SHOP GEOMETRY Continued from page 54

DRAWING POLYGONS

A polygon has more than four equal sides. Pentagons, hexagons, and octagons all belong in the polygon family. And, while you can learn specific ways to draw hexagons and octagons, this universal method allows you to draw them all.

Step 1. Draw a circle large enough to enclose the size polygon you want. Then divide the diameter

into as many equal spaces as your polygon will have sides, *below*. Our circle's diameter is $3\frac{1}{2}"$ and we wanted seven sides, so we made a mark every $\frac{1}{2}"$ ($\frac{1}{2} \times 7 = 3\frac{1}{2}$).

Step 2. Set the legs of a compass or the distance between trammel points to the circle's diameter. Swing intersecting arcs from A and B, as shown, *below*.

Step 3. From the intersection of the arcs draw line CD through the

second of your divisions along the circle's diameter.

Step 4. Where CD intersects the circumference near C, draw a line to A. This will be the length of each of your polygon's sides. Reset your compass or trammel points to match this length, and walk off and mark the divisions around the circumference.

Step 5. Now connect all marks with straight lines. 🐘

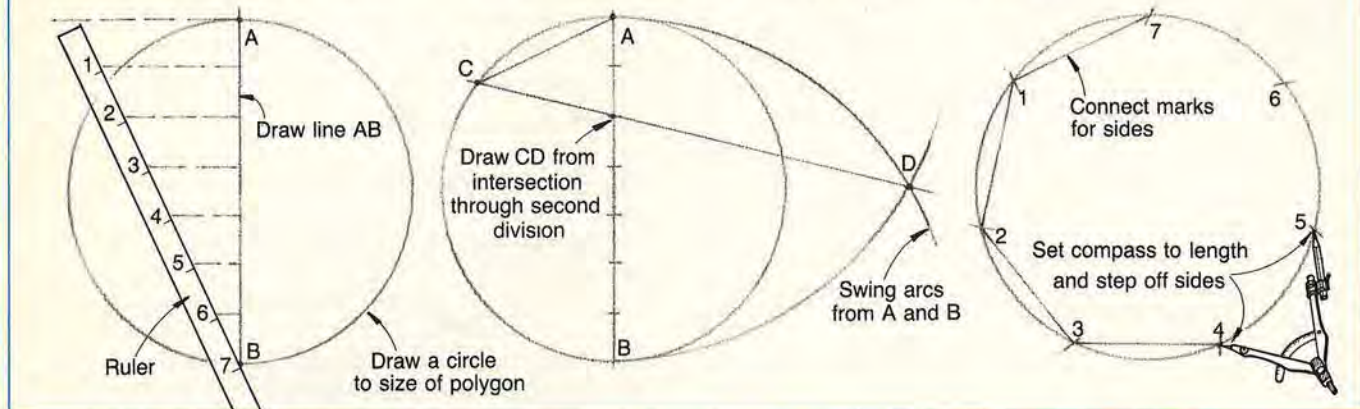

GUARANTEED FOR... A LIFETIME!

Since 1926, this old tool maker has made Quality products Affordable for the home-craftsman. We are proud to continue in this tradition with the introduction of our new line of woodworking Power Tools... Guaranteed To Last A Lifetime! You'll find the same heavy-duty construction and precision engineering throughout these American Made products that you've come to know and expect from Foley-Belsaw. We invite you to compare the quality and features of our new line of Power Tools with those costing hundreds of dollars more. We're confident you'll appreciate the quality and workmanship we've combined to provide a lifetime of performance in a Power Tool you can afford to enjoy using in your own home workshop.

MODEL 480 14" BANDSAW

The Model 480 Bandsaw gives you the outstanding performance required for every type of bandsawing operations. Contour cutting, straight cutting, resawing, or stack sawing... are all easily handled by the Model 480. Its large $13\frac{3}{4} \times 13\frac{3}{4}$ inch solid cast iron table offers a side take-out slot that allows us to use a set of solid double trunions located directly under the work load. A $\frac{1}{2}$ HP motor lets you effortlessly make cuts in up to 6" thick material using the standard rip fence.



MODEL 435 20" SCROLL SAW

Unlock your creativity with our new Model 435. Features like an extra large 20" throat and 2" depth of cut, combined with a chuck that allows the blade to rotate a full 360°, a $12" \times 12"$ cast iron work table that tilts from 0° to 45° left or right, a variable speed control for the motor that adjusts cutting speed from 600 to 2,000 strokes per minute, and your creative genius becomes almost endless.



**MODEL 490
10" TABLE SAW**

At Foley-Belsaw the only corners we cut are perfect 90's each and every time with the new Model 490 10" Table Saw. That's because of our exclusive new Accu-Fence design that provides four-way adjustability. Assures square cuts by providing both toe-in and toe-out adjustments as well as those for perfect squareness of the fence face to the table. And you'll find an exclusive new Poly V-Belt drive that delivers ultra smooth transmission from the $\frac{1}{2}$ HP motor that lets you easily cut up to a depth of $3\frac{1}{2}$ inches in hardwoods as easily as pine.

FREE 30-DAY TRIAL

When you buy from Foley-Belsaw, you're buying direct from the factory. This provides you with the lowest possible prices for quality, American made Power Tools... guaranteed to last a lifetime! Backed with our 30-Day FREE Trial Money Back Guarantee... you'll get to use these fine Power Tools in your own home workshop for a full thirty days. If you're not 100% satisfied we simply refund your deposits upon return of the equipment. So if you'd like to get all the facts on Foley-Belsaw Power Tools, just clip the coupon and mail it off today! We'll rush you full details along with our "Tailored To Fit Any Budget" payment plans.



Foley-Belsaw Company
42007 Field Bldg.
Kansas City, MO 64111

YES, please send me information on your complete line of Power Tools and full details on how I can qualify for a 30-Day Trial right in my own shop. I understand there is no obligation.

NAME _____
ADDRESS _____
CITY _____
STATE _____ ZIP _____

TOOL CITY

CALL TOLL FREE

INSIDE CALIF 1-800-826-7819

OUTSIDE CALIF 1-800-423-7899

•BEATS ANY AD PRICE THIS ISSUE!

PHONE NOW AND SAVE UP TO 60% ON:

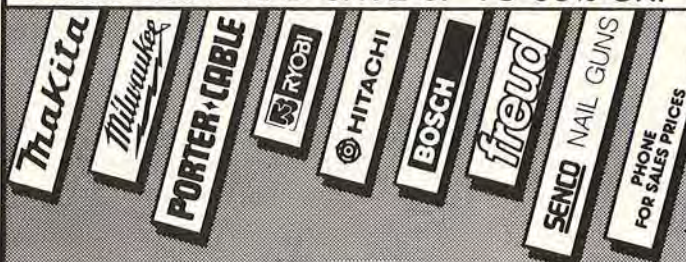

FREUD TOOLS SETS WITH CASE
CHISEL SETS
MDL * REG. SALE

6 pc WC106 43.90 **26.95**
10 pc WC110 73.60 **46.95**
TURNING SET
8 pc TT108 74.70 **46.95**
CARVING SETS
6 pc CS106 82.40 **54.95**
12 pc CS112 153.90 **98.95**
ROSEWOOD MALLET
MALLET T 24.95 14.95



FORSTNER BIT SET
REG.\$249.00
SALE **\$159.00**

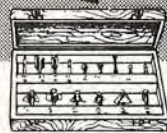

FREUD CARBIDE ROUTER BIT SET
with wooden case
90-100 List Sale
15pc set 299.00 129.00



CABINET MAKERS FREUD CABINET ROUTER BIT SET
1 Door Lip 1 Reversible Glue Joint
1 Raised Panel 2 Reversible Spline & Rail
LIST \$342.00
94-100 SALE PRICE **\$159.00**

FREUD SAW BLADE SPECIALS

FREUD CARBIDE-TIPPED SAW BLADES

No.	size	teeth	use	list	sale
LU72m10	10"	40	general	58.58	34.50
LU73m10	10"	60	cut-off	79.65	34.50
LU82m10	10"	60	cut-off	86.40	42.00
LU84m10	10"	50	comb.	74.51	35.00
LU85m10	10"	80	cut-off	110.88	55.00
LM72m10	10"	24	ripping	68.58	34.00

ALL OTHER FREUD SAW BLADES
PHONE FOR SALES PRICES

FREUD CARBIDE DADO'S				
6"	Dado	139.00	89.00	
8"	Dado	179.00	99.00	
8"	Adj. Dado	95.00	44.00	

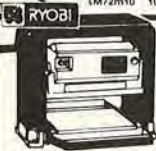

10" PLANER
13 amps power feed
LIST \$689
SALE PRICE **\$359.00**
Set. 4 Extra Blades \$29.95



Limited Edition "American Classic" Router **NEW!**
This solid die-cast aluminum housed 7 1/2 HP anniversary issue router honors the tradition of excellence found in all Porter-Cable tools. **SALE LIMITED SUPPLY \$129.**

TOOL CITY CATALOG 400 PAGES! \$2.50

or free with order over \$50.
WE HAVE EVERY TOOL YOU NEED



BIESEMEYER
BIESEMEYER RIP FENCES

28" Homeshop 195.00 52" Commercial 285.00
40" Homeshop 199.00 62" Commercial 322.00
52" Homeshop 238.00 98" Commercial 399.00

CALL FOR OTHER BIESEMEYER PRODUCTS
Paralock Saw Fence 389.00

HEAVY DUTY DUST COLLECTORS

DC101 2 HP 2 Bags 1182 CFM

List \$450 SALE - \$299.

DC102 1 Bag 1684 CFM

Available in Single or Three phase.
List \$625 SALE - \$499.

FOR SFS, CA - CALL FOR DISCOUNT RATES



\$319. ERMACO Nail-Gun
Compressor, 1 hp
145 PSI, 4-5 CFM 2 1/2 gallon tank Only weighs 52 lbs



MODEL S 500 A
1/8th Sheet
PAD SANDER
1.5 AMP
12,000 rpm
LIST \$79
SALE PRICE **\$29.95**



FREIGHT PREPAID (USA) ON ORDERS \$50 OR MORE

TOOL CITY

14136 E. FIRESTONE BLVD.
SANTA FE SPRINGS, CA. 90670
(213) 802-1236 OPEN MON - SAT
8 AM - 9:30 PM

CALL TOLL FREE

INSIDE CALIF 1-800-826-7819

FREE WITH \$50.00 ORDER - TOOL CITY CATALOG

PERSONAL CHECK

OUTSIDE CALIF 1-800-423-7899

WE HAVE EVERY TOOL YOU NEED

ASK WOOD

Print this article

Whether your woodworker's license reads "Beginner," "Intermediate," or "Expert," you're bound to have a few questions about your favorite hobby. We can help. Each issue, we'll consult our experts for answers to your most-asked questions. Send your questions to:

Ask WOOD
Better Homes and Gardens.
WOOD Magazine
Locust at 17th
Des Moines, IA 50336

Due to the volume of mail, we can't promise to answer all questions. But we try! Letters selected for use will be edited for publication.

ROUTING BACKWARD

Q. On my last project I ruined half again as much zebra wood as it took to complete the project. Do you have any suggestions for routing zebra wood?

— Carl Ragsdale, Houston, Tex.

A. Some woods just naturally split or chip when routed; other woods are hard to work when they're extremely dry. In both cases, one solution is "climb cutting": passing the router bit across the wood backward.

This isn't a technique you'll want to use all the time, because the bit will have a tendency to climb up the workpiece surface and pull the router out of control. However, once you know how your router will react to your operating it backward, you can stay on top of the situation.

NORMAL ROUTER METHOD

Bit has tendency to lift and split wood

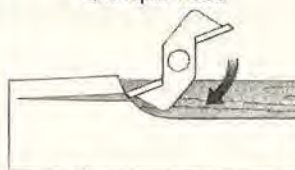

Router moves in this direction

"CLIMB CUTTING" METHOD

Bit shears wood cleanly

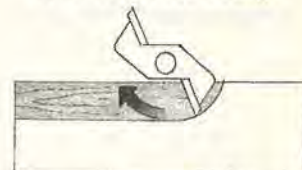

Router moves in this direction

To start climb cutting, make sure you have the workpiece securely clamped. With a firm grip on your router, run the bit across the edge in several light passes, until the cut is complete. For profiles that permit, start with a shallow cut — say one-third of the full depth — lowering the bit after each pass.



SPECIAL

40-601 Scroll Saw

\$699.00 PPD.

43-371 Shaper

\$1499.00 PPD.

Call today to place order for delivery. September-December, 1986.

Payment Must Be Made With Order.

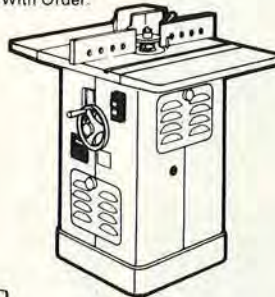
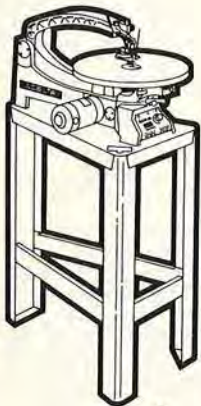

- WRITE FOR NEW 1986 CATALOG
- VISA, MASTERCARD ACCEPTED

HEGNER • STANLEY • GREENLEE • HENCKELS • MERIT

MARPLES • RECORD • WATCO • NU-LIFE • DOWEL-IT-CLESCO • GILLESPIE • FREUD

BLACK & DECKER • MILWAUKEE • FORSTNER • JORGENSEN • 3M • W.L. FULLER

SQUARE IT™

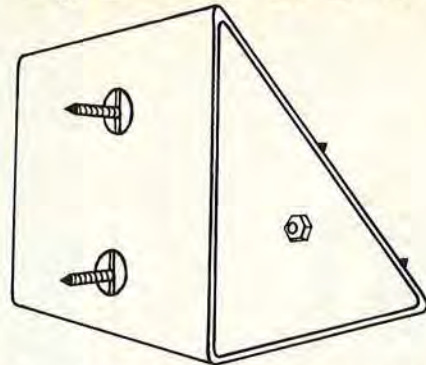

Square it™ is a newly patented electronic precision square with a guaranteed accuracy of 5/10,000 of an inch. Designed, engineered & made in America, **Square it™** is a rugged 3/4 pound precision instrument that's totally portable & built to last. **Square it™** is preset at exactly 90° & 45°. **Square it™** fulfills a universal need of woodworkers to square any tool easily & with great accuracy. There is never a guess or a question of accuracy with **Square it™**, when the light goes on you know its precisely 90° or 45°. **Square it™** will perfectly square the following tools: Table saw, Radial arm saw, Jointer, Bandsaw, Drill Press, Shaper, Disk Sander, Belt Sander, Router, or any stationary machine or hand held tool where a 90° or 45° relationship should occur. The introductory special of **Square it™** comes complete with: accuracy documentation papers, 18 page manual, Krypton bulb, Alkaline batteries and a 100% warrantee, \$76.50 ppd. The **Square it™** manual is fully illustrated with detailed drawings & easy to follow step by step instructions for a quick & accurate squaring up of your shop tools. (Example, squaring up for a table saw 10-15 seconds, Jointer 30-45 sec., Radial arm saw 35-60 sec.) For manual alone please send in \$5 check. For both **Door Shop™** & **Square it™** manuals send in \$8.50 check. Dealer inquires are invited.

The only thing small about this bandsaw is the price!



The new BS-3 Benchtop Bandsaw is BIG...BIG in capacity, performance, convenience and quality...yet it takes up just 1 1/2' x 3' of bench space. Its built-in disc sander adds the BIG advantage of sanding right on the saw. BIG 15" throat. BIG 6 1/4" cutting depth. BIG quiet-running 3-speed motor has plenty of power for Wood, Metal or Plastic. BIG 16" x 18" worktable tilts up to 45°. This BIG 86 lb. Benchtop Bandsaw comes with a built-in vacuum hook-up,

a BIG list of accessories (drum and belt sanding, and more) ...and BIG Buyer Protection. Call or write today.

If you think that high quality has to mean high price ...you're in for a real surprise.

emco USA

Dept. BWA6B • 2080 Fairwood Ave.
P.O. Box 07795 • Columbus, OH 43207

1-800-521-8289

(In Ohio: 614/445-8382)

THE DOOR SHOP™

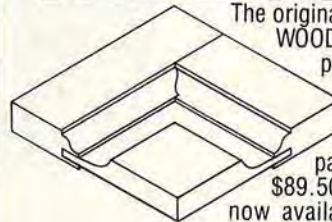

The original Ogee **DOOR SHOP™** as featured in WOOD MAGAZINE (MAY/JUNE 85) is complete with stile & rail, slot & panel raising bits for the 1/4" chuck router. Bits are carbide tipped & BB & will make 3/4" thru 2 1/4" thick raised panel doors. Door Shop™ & Manual \$89.50 ppd. The 1/2" shank Door Shop™ now available. Call about our 5 piece Door Shop™ special.

The 37 page **DOOR SHOP™ MANUAL** is clearly written and beautifully illustrated with over 156 detailed drawings covering the complete process of door building. Each section covers proper methods and exact set ups for the router, including how to recognize and correct for errors. There are sections covering Design, Lumber selection, Measuring, Panel Raising, curved & straight Rail and Stile cutting & fitting, Guides, Clamping, Gluing and Finishing. This is the most comprehensive manual out today. When purchasing the Door Shop™ manual for \$5.00 you also receive Zac's 26 page Router bit and Shaper cutter catalog free.

Zac's carbide tipped **PANEL RAISER™** router bits come in 3 styles; OGEE, COVE, & PROVINCIAL. All 1/2" shank bits are 3 1/2" in diam., with BB & give a full 1 1/2" raised panel \$90 @ or all 3 bits for \$235 ppd. All 1/4" shank bits larger raised panel cut. \$65 @ or all 3 bits for \$150 ppd.



TO ORDER
CALL 800-441-0101

IN NY 212-645-9494

ZAC PRODUCTS INC. 34 Renwick Street NYC, NY 10013

THE RBI HAWK LINE OF PRECISION SCROLL SAWS

Let the RBI Hawk line of Precision Scroll Saws unlock the creativity in you and let you become the woodworker you want to be. Use your Hawk to cut out in almost any material, names, wooden toys, cut-outs for tole painting, silhouettes, inlays, trivet baskets, the list is limitless! We built the quality into the Hawk that the pro's demand, yet kept it simple enough for a beginner to use. There is a Hawk suited to your needs from the 12" to the 26" with financing available. Try it in your shop for 30 days without risk and see how enjoyable and profitable scroll sawing can be for you.



SEND TODAY FOR YOUR FREE INFORMATION KIT



1801 VINE ST., P.O. BOX 369
HARRISONVILLE, MO 64701
1-800-535-8665

YES, TELL ME MORE ABOUT THE RBI HAWK LINE OF PRECISION SCROLL SAWS PLUS THE 30 DAY MONEY BACK GUARANTEE

NAME _____

STREET _____

CITY _____

STATE _____ ZIP _____

© 1986 RBI, INC. (PLEASE PRINT) CODE W11

FROM CURVES TO CORNERS THE KUSTER SPINDLE SANDER GETS YOUR WORK INTO SHAPE.

With exclusive straight shank spindles and independent spindle oscillation and rotation motors.

Includes choice of 2 spindles with matching throat plates.

Professional features & industrial quality at an affordable price.

Free illustrated brochure.

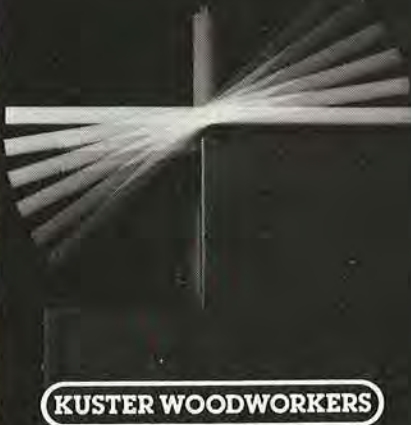

KUSTER WOODWORKERS

P.O. Box 34-SB
Skillman, NJ 08558
201-359-4680

WOOD TOY

- ★ Patterns
- ★ Parts
- ★ Wheels
- ★ Many New Patterns to Choose from.
- ★ Executive toys

SEND \$1.00 FOR NEW CATALOG & RECEIVE COUPON FOR FREE WHEELS & AXLE PEGS.



toys and joys

Box 628W Lynden, Wash. 98264

PORTABLE SAWMILLS

Write for Free Literature

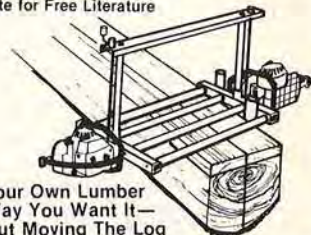

Cut Your Own Lumber The Way You Want It— Without Moving The Log

INFORMATION HOTLINE (201) 744-6110



SPERBER TOOL WORKS

Box 1224W • W. Caldwell • N.J. • 07007

Everything for the Woodturner!

- bowl stock
- bowl gouges
- square stock
- turning tool
- lathes
- lathe duplicators
- chucks



Everything from hardwood bowl stock, spindle stock, carving stock to the finest in lathes, duplicators, tools and many specialty items for the turner.

FREE CATALOG

send to:



Box 19 Whitesville, N.Y. 14897

Name _____

Address _____

City _____

State _____

Zip _____

Lathe model _____

1515

PRICE SHOCK!



GENERAL

Machine Only	AS LOW AS
#350-1 10" Table Saw	\$920.00
#160-2 Variable Speed Lathe	825.00
#260-1 Variable Speed Lathe	1725.00
#1180-1 6" Jointer & Stand	535.00
#480-1 8" Jointer & Stand	1075.00
#490-1 15" Bandsaw & Stand	605.00
#130-1 14" Thickness Planer	1935.00

The Humfrey Catalog brings you concise descriptions & detailed, large-format photographs of machines representing a tradition of solid craftsmanship... all at factory-direct prices. Send for your copy now.

J. Philip Humfrey Ltd.

3241 Kennedy Road, Unit 7
Scarborough, Ontario M1V 2J9
(416) 293-8624

SCROLL SAW OWNERS



Lettering Layout Guides!

- Use our specially designed guides to layout letters & numbers to be cut from wood or other materials.
 - Made from a durable plastic material.
 - Several styles & sizes.
- Send \$3.00 (Refundable with first order) for descriptive brochure & prices to:

SEYCO SALES

2107 So. Garland Ave.
Box 472749
Garland, Texas 75047

PROTECT YOUR EYES



- Large 66mm polycarbonate lenses now have exclusive "4-C" scratch, chemical, static, and fog resistant finish.
- Ratchet hinge front angles in or out to assure comfortable, goggle-like fit. One size fits all. Ventilated side protection.

Write or call us for a free Head-to-Toe Safety Catalog

Money back guarantee. You must be pleased. Check, Money Order, MasterCard, Visa.

Order style 9180-W

\$9.95 Delivered



KENCO SAFETY PRODUCTS DIV.

78 Glasco Turnpike P.O. Box 385 Woodstock, N.Y. 12498

IN NY STATE (914) 679-5246

OUT OF STATE 1-800-341-4103

WOODWORKING-CARBIDE TOOLS

BUY DIRECT FROM THE SOURCE-AND SAVE!

REVERSIBLE RAIL & STILE BIT

\$69.90ea.

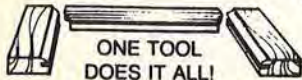

ONE TOOL DOES IT ALL!

Instructions Included

MAKE YOUR OWN CABINET-DOORS, PANELS, FRAMES
ALL YOU NEED IS A ROUTER!

2 5/8" RAISED PANEL BIT

\$64.90ea.

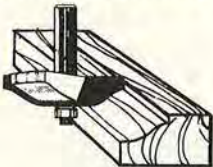

CARBIDE TIPPED PLANER KNIVES:
4" TO 25" - \$3.90 PER 1" LENGTH
Please Specify Width & Thickness Required

SEND CHQ. M.O. VISA OR M.C. ADD \$4 FOR RUSH DELV.

SHARPCO CANADA

960 ALNESS ST. #2, DOWNSVIEW, ONT. M3J 2S1
(416) 736-0333

"LOOK WHAT WE FOUND FOR YOU"



2 bag, mobile stand,
(4 casters),
1ph 2hp
110/230v,
1182cfm,
ALL STEEL,
5in main opening with
"Y" with (2)
4in openings,
wt. 140 lbs.

List—\$430

BMS502

Dust Collector
SALE \$399 Freight Paid

Warranty—12 Months/1200 Hours

BRATTON
INTERNATIONAL MACHINERY

1015 Commercial St. ■ Box 20408AW
Tallahassee, FL 32316 ■ 904/222-4842
NAT'L WATS 1-800-874-8160
FLORIDA WATS 1-800-342-2641

VISA/MasterCard (subject to 3% surcharge)

Catalog & added to mailing list
"FREE" with purchase or send \$3.

My Ebac
LD82 Dry Kiln
paid for itself in
just 3 months!



YES YOU CAN KILN DRY YOUR OWN LUMBER...

...As little as 100 BF per month for pennies a board foot!
Let EBAC, the World Leader, show you how with an...

EBAC LD82 WOOD DRYING KILN

- Simple to operate — plug it in and turn it on!
- Dry lumber — 6%—8% — when you need it!
- Increase your profits — buy green wood & dry it yourself!
- Quiet and efficient — your TV probably uses more electricity!
- Rapid payback — usually within 1-6 months!

What are you waiting for? For less than \$1400, you could be kiln drying your own lumber and pocketing the kiln dried premium! Find out why 600 of your friends in the U.S. and Canada—most with no wood drying experience—own EBAC DRY KILNS. GET THE FACTS—CALL EBAC or write for more information and a no obligation lumber drying proposal. — YOU'LL BE GLAD YOU DID!



EBAC LUMBER DRYERS

8726 E. 33rd St., Dept. W., Indianapolis, IN 46226
317-897-2100/1-800-433-9011

— LARGER SYSTEMS AVAILABLE —

NOW A SURFACE/THICKNESS SANDER AT A NEVER BEFORE PRICE



\$179.95

Vacuum Dust Collector
Cut-Away View

The **PERFORMAX SANDER** attachment clamps onto your radial arm saw column instantly. Powered by the saw motor and with the drum height controlled by the saw adjustment mechanism, this space saving attachment will make a useful, inexpensive addition to your wood-working tools.

- A open end design allows you to sand boards from 1" to 44" wide.
- A new slide fastener eliminates the need for special paper adhesives and makes changing papers a snap!
- You will be able to finish sand to uniform thickness with remarkable speed.
- Makes edge sanding for parallel edge jointing easy.
- Your **PERFORMAX SANDER** requires minimum storage space when not in use.
- Moneyback Guarantee

For additional Information Write:

PERFORMAX PRODUCTS

17065 Judicial Rd., Dept. W126, Lakeville, MN 55044

or call **TOLL FREE**

•1-800-328-5727 Ext. 114 •1-800-742-5685 Ext. 114 (In MN)

NEW! High-Precision SCROLL SAW AT A SENSIBLE PRICE!

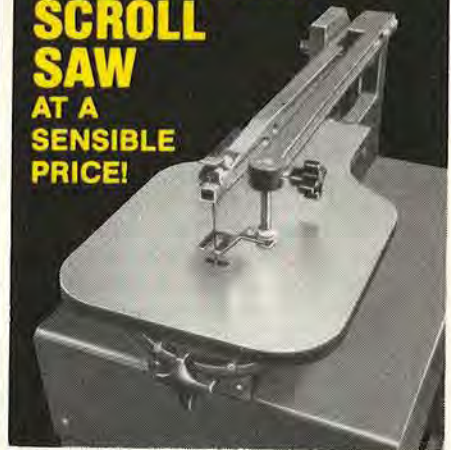

30-DAY FREE TRIAL!

Use this high-precision saw to make hundreds of profitable, unusual items... toys, name-bars, filigree work, clocks, holders... the list is nearly endless! Because the Model 1600 cuts so smoothly, sanding is virtually unnecessary!

The new Woodmaster Model 1600 gives you a big 16-in. throat capacity, 2-in. cutting depth, a generous, oversize worktable, ball-bearing drive... and much more! Made in U.S.A. **Easy Terms.**

Send today for free information kit!

Phone Toll Free 1(800) 538-4200, ext. 2515

Woodmaster Tools, Dept. CW15
2908 Oak, Kansas City, MO 64108

Name _____

Address _____

City/State _____

Zip _____



THE SOURCE

\$99

16 1/4"
14 1/4"

BOTH for \$429 \$359 Delivered

\$49.95

\$72-

\$179-

\$215-
\$279-

SPLINES
Sm-Md-Lg
1,000 per CTN.
\$27.50

Send \$3.00 for the most COMPLETE catalog of fine hand tools & cabinet makers supplies!!!!

WE BEAT ANY PRICE THIS ISSUE!

US 800-452-9999 VA 800-468-1778
7305 BOUDINOT DRIVE
SPRINGFIELD, VIRGINIA 22150

The advertisers whose ads appear below offer the following advice to help you in ordering their lumber products:

- Select a wood species that's compatible with the project you're planning to build (there are several good reference books that list various species' characteristics and preferred uses).
- If you're planning to build several projects in the near future, consider ordering what you need for all of them at one time. That way, you'll have the stock you need when you're ready to build.
- Figure your lumber needs, then add 15% for waste. As you do this, think in terms of the number of boards of a certain size it will take to yield the parts for your project. Make a cutting diagram showing how you plan to cut each of the boards.

MAIL ORDER LUMBER YARD

- Send along a copy of the cutting diagram with your order, and explain the type of project you're planning to build. Both of these things help us in filling your order.
- If you or someone you know has a planer, and if you are willing to surface your own lumber, you can save money by ordering stock that's undressed (rough sawn).
- Send for our product brochures, and keep them on file in your shop. That way, when you need a particular type of stock, you'll have ready reference.
- Buying in bulk lowers the cost per board foot. Consider going together with some of your woodworking friends, and take advantage of the savings. Some of us have minimum orders.
- Be aware of shipping costs. Is the price quoted a shipped price? How will it be sent? UPS? Trucking firm? Etc.? Ask.
- Upon receipt of your order, please inspect it and report any damaged material to the carrier immediately.

EDLCO

Appalachian Hardwood Specialists
21 species
Domestic Hardwoods
Softwoods

Kiln Dried Delivered Prices
Catalogue \$2.00

Write Today EDLCO
Box 5373 W
Asheville, N.C. 28813
Phone (704) 255-8765

We Know Our Lumber

EDUCATIONAL LUMBER CO., INC.



HARDWOODS IMPORTED AND DOMESTIC

Boat Lumber • Cabinet Lumber
Red Oak • White Oak • Ash • Birch • Birdseye • Teak
Mahoganies • Cherry • Walnut • Maple • Poplar
Basswood • Bubinga • Pearwood • Osage • Pines
Padouk • Ramin • Rosewood • Wenge • Zebrawood
Bocote • Cocobolo • Che Chen • Zircote
Oak Mouldings • Dowels • Hardwood Plywoods
Planing • Rippling • Millwork
Send \$1.00 for price list.

No Minimum • Shipments Worldwide
30 Yr. Member National Hardwood Lumber Assoc.
Direct Importers of Foreign Hardwoods

United States Mahogany Corp.
746 Lloyd Road, Matawan, NJ 07747
(201) 583-6300
Open Monday thru Saturday

THIN HARDWOOD PRICED RIGHT

Clear • Kiln-dried • 2 Sides Surfaced
3" to 10" Widths • 3' to 5' Lengths
20 sq. ft. Packs, Random Widths & Lengths



1/2" red oak...\$36.00 pkg.
1/2" walnut.....\$44.00 pkg.
1/2" pecan.....\$29.00 pkg.
1/4" & 3/8" also available at same price.

Price includes UPS delivery.
Send Check or M.O. with order.

HARDWOODS OF ILLINOIS

RR4, Box 618, Mt. Vernon, IL 62864

EXTENSIVE EXOTIC & DOMESTIC INVENTORY

DOUSSIE	FLITCH-CUT LUMBER OUR SPECIALTY
AFRORMOSIA	
ZEBRAWOOD	
AMAZAKOUE	
PURPLEHEART	GONCALO ALVES
MORADO	ANDIROBA
BUBINGA	IMBUYA
PADOUK	PALDAO
WENGE	SAPELE
RED OAK	WHITE OAK
CHERRY	
POPLAR	THIN WOOD FOR SMALL PROJECTS
WALNUT	

WYNDHAM WOODS

THICK VENEERS FOR BENDING THIN WOOD FOR SMALL PROJECTS

ARCHITECTURAL QUALITY EXOTIC & DOMESTIC VENEERS

For the World's Finest Lumber & Veneer at Reasonable Prices send \$1.00 for Brochure & Price List to:
WYNDHAM WOODS, P.O. Box 506
Ellettsville, IN 47429 / PH. 812-334-7735

ATTENTION FLORIDA WOODWORKERS

We have Florida's largest and most unbelievable selection of exotic imported and native hard and soft woods, table slabs, veneers, etc. We also stock Ashley Isles carving tools. Send self-addressed stamped envelope for list.



HENEGAN'S WOOD SHED
7760 Southern Boulevard
West Palm Beach, FL 33411
Call (305) 793-1557
Open Tues.-Sat. 9:00-5:30

—Rare—

MACASSAR EBONY

MAGNIFICENT GRAIN, high figure or subtle.

MATCHLESS DIMENSIONS, 1" up to 9" thick, 4" up to 20" wide. Random lengths to 9 feet. Best selection available in the U.S.

LOWEST COST from a DIRECT IMPORTER. NO MINIMUM ORDER.

A. Eisenbrand, Inc.
4100 Spencer Street, Suite EW4
Torrance, CA 90503
(213) 542-3576

Cal Oak Lumber Co.

featuring
WESTERN HARDWOODS

California's exclusive hardwood producer. Warm and exceptional native woods. Quality lumber, unique and exotic available only at Cal Oak Lumber, paneling, flooring, dimension stock.

Including...

- BLACK OAK: Expressive, tightly grained red oak
- TAN OAK: The "Golden Oak"
- PACIFIC MADRONE: Reddish, "California Cherry"
- BLACK WALNUT: Deep, rich texture

No broker fees, no middleman!
Direct mill sales on any volume



Cal Oak Lumber Co.
1000 Cal Oak Road
P.O. Box 689
Oroville, CA 95965
(916) 534-1426

RARE, EXOTIC HARDWOODS

in person or by mail!

Over 200 different sizes and kinds of woods...plus 3,000 woodwork items at your fingertips!



CONSTANTINE Est. 1812
2054N Eastchester Road
Bronx, NY 10461
116 page catalog—Only \$1.00



NATIVE AMERICAN HARDWOODS

WALNUT, BUTTERNUT, CHERRY
CURLY & BIRD'S-EYE MAPLE
Most Other Domestic Woods

- EXTRA WIDE/EXTRA THICK STOCK
- TURNING SQUARES/BLOCKS
- QUARTERSAWN/BOOKMATCHED LUMBER
- SPALTED LUMBER/BLOCKS
- THIN STOCK
- FLOORING/PANELING

NO MINIMUM WHOLESALE & RETAIL

Comprehensive Listing—One Dollar (Refundable)

NATIVE AMERICAN HARDWOODS LTD.
B1, W. VALLEY, N.Y. 14171 • (716) 942-6631

Quality Exotic Wood

» TURNERS «

Thick Planks for Bowls/Squares

» CABINET MAKERS «

Individually Selected Lumber
for
Furniture/Boxes/Inlays

Over 70 Species

All Inquiries Welcome... Call or Write

TheBereaHardWoods.co

125 Jacqueline Drive Box 10
Berea Ohio 44017

(216) 243-4452

"It's a matter of pride for both
of us"...

SHAKER PEGS CANDLE CUPS MUG PEGS

\$17.95 per 100, prepaid.
Wide selection of other
wood products.

Catalog \$2.00 or free with order.

Benny's Woodworks

P.O. Box 656, Dept. WD2
Antioch, TN 37013
(615) 331-8384

Shaker Peg



Mug Peg



EXOTIC

BRAZILIAN HARDWOODS

*Amazon Rosewood, Freijo, Jatoba,
Pau Amarelo, Pau Brazil,
Purpleheart, Blackheart,
Leopardwood*

Write or call for our free brochure
on these and other hardwoods.
or send \$7.50 for a sample package.

Custom Cutting • Turning Stock

Wholesale & Retail



Visa

MasterCard



Check or Money Order

Paradise Farm Wood Products

Wesley, Maine 04686

(207) 255-3711

BUYMANSHIP BASICS

LATHE CHUCKS WHICH IS BEST FOR YOU?

In our faceplate techniques article that begins on page 38, we show and discuss two good ways to mount stock on a lathe — the direct connect method and the auxiliary faceplate method. These have served woodturners well for countless years. But today, manufacturers offer you yet another mounting option — the lathe chuck.

Should you add one of these costly devices to your turning tool kit? Will a lathe chuck make you a better turner? Which one should you buy?

For answers, we talked to some of the folks who sell and use lathe chucks. Here's what we found out.

WHAT ADVANTAGES DO LATHE CHUCKS OFFER?

Have you ever examined the bottom of a bowl made by an experienced turner and wondered how the heck he or she got it so thin? Most likely the turner first shaped the outside of the bowl between centers or with an inexpensive (under \$30) pin chuck, then switched to a lathe chuck for the inside work. Systems vary, but lathe chucks offer a way to turn thin-bottomed bowls with no faceplate screw holes.

We investigated three popular models — the Three-Jaw Chuck, the Sorby Precision Combination Chuck, and the Delta Super Chuck.

THREE-JAW CHUCK

Darrell Nish, president of Craft Supplies U.S.A., grew up with wood shavings in his pants cuffs. His father, Dale, is one of the country's best-known woodturning teachers and author of several turning books.

Darrell especially likes the Three-Jaw Chuck shown *top right*, on this page. It's a heavy beast (nearly 9 pounds), made in China, and

expensive (list \$189.98). Nevertheless, you'll find a Three-Jaw Chuck in many shops.



Experienced turners love the Three-Jaw Chuck's speedy mounting system, but it's not for beginners.

To use a Three-Jaw Chuck you turn a round tenon or plug on the outside bottom of the bowl, demount the bowl, and lock the chuck onto the lathe's headstock. The self-centering jaws grip any plug up to 4½" in diameter.

"It's the most versatile chuck there is," Nish says. "Professional turners like the Three-Jaw Chuck for its speed, but it's not for beginners. You need a lot of finesse."

For the average turner, Darrell recommends the Sorby Precision



The Precision Combination Chuck precisely holds the workpiece in a multitude of ways.

Combination Chuck shown *above*. Because this one is cylindrical in shape, a slip needn't result in disaster.

FREE SANDING BELTS

DIRECT FROM THE MANUFACTURER

GET SIX FREE BELTS FOR EACH DOZEN ORDERED. All belts are aluminum oxide first quality. Our electronic presses make smooth bump-free splices.

Check your size and how many dozen. We will ship assorted grits unless otherwise specified.

<input type="checkbox"/> 1" x 30"	— \$12.70/doz.
<input type="checkbox"/> 1" x 42"	— 12.75/doz.
<input type="checkbox"/> 1" x 44"	— 12.80/doz.
<input type="checkbox"/> 3" x 18"	— 13.75/doz.
<input type="checkbox"/> 3" x 21"	— 14.25/doz.
<input type="checkbox"/> 3" x 23¼"	— 14.70/doz.
<input type="checkbox"/> 3" x 24"	— 14.75/doz.
<input type="checkbox"/> 3" x 27"	— 15.25/doz.
<input type="checkbox"/> 4" x 21¼"	— 16.75/doz.
<input type="checkbox"/> 4" x 24"	— 17.25/doz.
<input type="checkbox"/> 4" x 36"	— 20.95/doz.
<input type="checkbox"/> 6" x 48"	— 26.95/½ doz. (3 FREE)

Other size belts on request.

9" x 11" Paper Sheets

A/O Cabinet Paper		No Load Finishing Paper			
	50/pk.	100/pk.			
40-D	<input type="checkbox"/> \$17/pk.	<input type="checkbox"/> \$31/pk.	180-A	<input type="checkbox"/> \$11/pk.	<input type="checkbox"/> \$19/pk.
50-D	<input type="checkbox"/> 16/pk.	<input type="checkbox"/> 28/pk.	220-A	<input type="checkbox"/> 11/pk.	<input type="checkbox"/> 19/pk.
60-D	<input type="checkbox"/> 15/pk.	<input type="checkbox"/> 26/pk.	280-A	<input type="checkbox"/> 11/pk.	<input type="checkbox"/> 19/pk.
80-D	<input type="checkbox"/> 14/pk.	<input type="checkbox"/> 24/pk.	320-A	<input type="checkbox"/> 11/pk.	<input type="checkbox"/> 19/pk.
100-C	<input type="checkbox"/> 13/pk.	<input type="checkbox"/> 22/pk.	400-A	<input type="checkbox"/> 11/pk.	<input type="checkbox"/> 19/pk.
120-C	<input type="checkbox"/> 13/pk.	<input type="checkbox"/> 22/pk.			
150-C	<input type="checkbox"/> 13/pk.	<input type="checkbox"/> 22/pk.			

NEW ITEM!

BELT CLEANING STICK - \$6.95

Wet or Dry S/C Paper

	50/pk.	100/pk.
220-A	<input type="checkbox"/> \$15/pk.	<input type="checkbox"/> \$25/pk.
320-A	<input type="checkbox"/> 15/pk.	<input type="checkbox"/> 25/pk.
400-A	<input type="checkbox"/> 15/pk.	<input type="checkbox"/> 25/pk.
600-A	<input type="checkbox"/> 15/pk.	<input type="checkbox"/> 25/pk.

Prompt delivery from stock.
MONEY-BACK GUARANTEE

Shipping Charges - Under \$35 add \$2.50; \$35 or more add \$4.00—PA residents add 6% sales tax.

Check or Money Order.
 MasterCard VISA Exp. Date _____

Acct. # _____

Name _____

Address _____

City, State & Zip _____

CALL TOLL FREE
1-800-428-2222

PA Only - 1-800-222-2292

INDUSTRIAL ABRASIVES CO.

643 North Eighth Street
Reading, PA 19603

BUYMANSHIP BASICS

LATHE CHUCKS

Continued from page 103

PRECISION COMBINATION CHUCK

Made by the Sorby house in England, this chuck is an improved model of an older design, the six-in-one chuck. Nish believes the Precision Combination Chuck out-performs the six-in-one version in critical alignment capabilities. Computer designed and manufactured, the improved chuck sells for around \$100.

As its name implies, the Precision Combination Chuck system offers several mounting methods — expanding collet chuck, split ring chuck, screw chuck, cup chuck, pin chuck, and ring chuck. Add to this the accessories available, and you can use the Precision Combination Chuck 30 different ways.

Most turners give the expanding collet (internal grip) a heavy workout. The collet spreads to grasp a shallow dovetail recess in the bottom of the bowl. You'll especially appreciate the expanding collet when you need to quickly rechunk pieces without worrying about losing center — a blessing when you work green woods.

Be warned, though, that the shallow dovetail recess — just 3/16" deep — must be accurately turned. Otherwise, you could find yourself looking around for your lathe's faceplate.

And more words of caution: The expanding collet works like a mini wood splitter that can rip apart the bases of blanks, especially softwood and smaller blanks.

We rang up Tony Walker, a Sorby marketing manager in Sheffield, England. "Accuracy is its greatest virtue," he says, "and flexibility is another important selling point. I can't think of any work the Precision Combination Chuck couldn't hold efficiently by one means or another. It's very

Continued on page 106

NEW from Penn State Industries... a supplier of quality products for over 40 years

Precision Super 15" Scroll Saw

Comparable value over \$500

Only \$139.95 shipped complete ready to run



This versatile machine makes cutting intricate wood patterns easy. A smooth cutting action virtually eliminates sanding. The blade is driven on both up and down stroke, and a parallel rocker arm system and pivoting blade clamp absorbs stress to avoid blade breakage. The blade moves slightly back from the wood on the up stroke and forward into work on the down stroke to speed cutting. Great for making toys, jewelry, puzzles, fretwork, etc. Thousands of these machines used in Europe for many years.

SPECIFICATIONS:

- 100% Cast iron construction
- Throat depth — 15"
- Max depth of cut — 2"
- Cuts per minute — 1725
- Weight — 43 lbs
- Motor — Heavy duty totally enclosed fan cooled 110V - 120V UL listed, ball bearing — induction motor
- Use standard 5" blades
- Stroke length — 3/4"
- Table tilt — 0 - 45°
- Table size — 8" x 17"

To Order, Call or Write:

PENN STATE INDUSTRIES-W
2850 Comly Road • Philadelphia, PA 19154
1-215-676-7609 (Ext. 15)

Visa, Master Card, Check or Money Order Accepted
Add \$10.00 for shipping • Pennsylvania residents add 6% sales tax

FREE 12 blades and extra blade holder with purchase



Send for hundreds of useful low-cost booklets and ideas, especially prepared to help you by the nation's leading manufacturers.

Complete the coupon on page 111 and send with your remittance to our Better Homes and Gardens® WOOD processing center.

Special section starts on page 108.

MAIL YOUR ORDER TODAY!

WOODWORKERS

- PORTER-CABLE -

PROFESSIONAL POWER TOOLS

Speed-Bloc® Finishing Sander



Model No. 330

SALE!
\$55.00 ppd

FREE CATALOG SUBSCRIPTION
WITH PURCHASE.

CATALOG ONLY.

2 year subscription (8 issues) \$4.00.
Free \$5.00 gift certificate with catalog order.

R. A. NESS & CO.

THE WOODWORKERS EMPORIUM

8888 N. MILWAUKEE AVE.

NILES, IL 60648

(312) 824-0565



VIDEO TAPE!

"TABLESAW TRICKS & JIGS"

WITH JON EAKES



This high quality production has 60 mins. of action featuring Tricks & Jigs on Tablesaws that even experts find informative.

Most tablesaw owners reach the maximum knowledge of their saws within a few weeks and never realize how much more there is to learn. Now you can get professional and instructional guidance from master craftsman Jon Eakes who is well known for his TV show "MR. CHIPS."

This is a high budget production!

INTRODUCTORY SPECIAL
Only \$29.95 PREPAID TO YOU!

MODEL G1626 VHS or G1627 BETA
CALL YOUR ORDER IN & CHARGE IT!



GRIZZLY IMPORTS INC.

P.O. BOX 2069, BELLINGHAM,
WA 98227 (206) 647-0801

Makita

MODEL 2040
PLANER
2 HP, 1 PH, 115V

\$1149

FULL LINE DISTRIBUTOR

2020, 8" Longbed Jointer \$849
2030, 12" Planer/Jointer, 2 HP, 1 PH, 115V \$1149
2030N, 12" Planer/Jointer, 2 HP, 7000 RPM \$1339
SAME DAY SHIPPING • FREE FREIGHT
• FACTORY AUTHORIZED SERVICE



a c m e Electric

TOOL CRIB OF THE NORTH SINCE 1948

CALL TOLL FREE FOR MIKE

1-800-358-3096



BAND SAW OWNERS!

A NEW TOOL is now available so you can make or repair any length Band Saw Blade in minutes!

This patented tool was developed for use in our own shop and has proven itself with thousands of high quality, true running splices.

Our splicer enables any craftsman to make up any length blade from economical coil blade stock QUICKLY and EASILY. The resulting silver brazed joint normally outlasts the service life of the blade.

Three models are currently available:

1C-001 ¼" to ¾" Blades \$ 49.95 ppd
1C-002 ½" to ¾" Blades 49.95 ppd
1C-003 ¾" to 1½" Blades 150.00 ppd

The tool comes complete with detailed instructions and supplies for approximately 100 splices.

We also carry additional supplies and OLSON band saw stock at reasonable prices.

Send L.S.A.S.E. for FREE information to:

NEW MILFORD SPECIALTIES CO.

Dept. BH, 24A South Main Street

New Milford, CT 06776

(203) 426-4276

CLOCK COMPONENTS

QUARTZ CLOCK MOVEMENTS

WE FEATURE BATTERY, PENDULUM, CHIME QUARTZ MOVEMENTS OF ALL TYPES. URGOS, HERMLE, GRANDMOTHER, GRANDFATHER CABLE DRIVE AND CHAIN DRIVE, KEY WIND MOVEMENTS OF ALL TYPES, 400 DAY CLOCKS, MUSIC BOX MOVEMENTS, FLAT AND BEZEL TYPE DIALS—PLUS A VAST ASSORTMENT OF WEATHER INSTRUMENTS. HUNDREDS OF CLOCK ITEMS. VERY COMPETITIVE PRICES. WRITE OR CALL FOR FREE 75 PAGE CATALOG. \$2 FOR AIR MAIL.

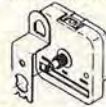

THE QUARTZ FITUP

THE MINI QUARTZ

Send To:

NEWPORT ENTERPRISES INC.
2313 W. Burbank Blvd.
Burbank, CA 91506
818-845-0555

Queen Anne Leg

by

Adams Wood Products, Inc.

Prompt delivery
Any quantity
Different styles & sizes
Various woods

FREE BROCHURE

974 Forest Dr., Dept. Q
Morristown, TN 37814

615/587-2942



A Complete New Combination Kit for Whittling and Carving By WARREN TOOL CO., INC.

BASIC WOODCARVING



Basic Woodcarving lesson book, prepared by the National Carvers Museum, teaches and illustrates proper carving techniques through clear instructions and simple projects.

#COMBI-TCE \$79.95 + \$2.25 p&h
OUR FINEST COMBINATION WHITTLERS AND CARVERS KIT
Contents: 1 Redwood Box, 1-#CWH-R Rosewood handle, 1 #L-Palm Walnut handle, (one each) #PTV-1, #LBG, #SBG, #PTV-2, #STC, #STG, #SFTG, #SKU, Gouges, 1-#LD2 (Large Blade), #6SBL (6-Small Blades), 1-Leather Strop Block, 1-Abrasive Paper Block, 1-Instruction Booklet. All blades and gouges sold in their own plastic storage tubes to avoid damage to these honed ready-to-use tools.

WARREN TOOL CO., INC.

Rt. 1, Box 14A-W, Rhinebeck, NY 12572

Catalog 60¢ FREE with order • (914) 876-7817

N.Y. residents add 5.25% sales tax • Foreign shipping: "all foreign orders (including Canada) send MO in US funds plus additional \$1.75 for P&H.



Develop a profitable second income in your spare time making small, unique bandsaw boxes. This unpublicized, little-known technique allows you to turn common inexpensive lumber and scraps into valuable utility boxes for the home and office. High demand in gift shops, stationery stores and craft fairs. Fully illustrated instruction booklet of 15 original and profitable designs. Satisfaction absolutely guaranteed. Send \$10.00 to **Box-Art, Dept. P, Box 8069, Woodridge, IL 60517.**

Timbers' Woodproject Directory™



Your Guide to HUNDREDS of FREE Woodworking Projects.

Want to make a Curio Cabinet, End Table, Bedroom Set, Wooden Toys, Lawn Furniture or another wood project?

No doubt someone has built the woodworking project you want to make. And, it is published with all the dimensions or full size drawings you'll need to cut hours off building time. But: Published WHERE? . . . in Workbench, Popular Mechanics, Wood Magazine, Woodsmith, Woodworkers Journal, Home Mechanix, or in a popular woodworking pattern or book.

Timbers' Woodproject Directory is a series of woodworkers' guides to projects and patterns. Each guide is organized by project, like tables, wooden toys and children's furniture, shelves, whirligigs, household furniture, homemade tools, etc. Everything can be made in your own workshop. Each guide lists and illustrates 64 projects. More than half of the projects are found in one or more of the magazines listed above. The rest are found in books or woodworking patterns. Find these books or magazines in your local library, or, we show you how to order the magazine back issues, books, and patterns. Plus, many project photocopies are available. **FREE!**

Perhaps you would like to build a desk for your den. Order Timbers' Woodproject Directory, "Desks." 64 desk projects and illustrations are shown. Listed is an "Oak Raised Panel Library Table," June, 1985, Wood Magazine, page 50. Find Wood Magazine at your local library OR the guide tells how to get a project photocopy, **FREE.**

Each guide in "Timbers' Woodproject Directory" is only \$2.25. Order all 12 volumes (listing 768 projects) for only \$19.95 and you will receive Timbers' Woodproject Directory Notebook absolutely **FREE** (an \$8.95 value). This special offer saves you nearly \$16!

Timbers Catalog, **FREE** with order. \$1 alone

See **FREE** Notebook offer

Order

11. Curio Tables, End Tables, and Dining Room Tables
12. Wooden Toys and Children's Furniture
13. Desks
14. Whirligigs, Yard Furniture, Planters and Outdoor Projects
15. Gifts
16. Kitchen Projects
17. Shelves
18. Cabinets and Cupboards
19. Chests and Bedroom Furniture
20. Household Furniture I
21. Household Furniture II
22. Homemade Tools, Workbenches and Jigs.

Timbers/ Lake Tahoe, Inc.

2911 Lake Forest Rd.
Dept. T11
Carnelian Bay CA 95711-0850

CIRCLE ORDER #	TOTAL
11, 12, 13, 14, 15, 16, 17, 18, 19, 20, 21, 22	\$2.25 each
All 12 Guides (includes free Timbers' Woodproject Directory Notebook)	\$19.95
CA residents add 6% sales tax	
Mail order processing fee	\$2.00
TOTAL INCLUDED	

Mastercard/VISA orders, please include card # & expiration date. Telephone order 24 hrs/day 916-581-4141.

Name _____

Address _____

City _____

State _____ Zip _____

Phone _____

BUYMANSHIP BASICS

LATHE CHUCKS

Continued from page 104

difficult to figure out how this product could be improved."

DELTA SUPER CHUCK



The Delta Super Chuck system includes two chucks, two cutters, a backing plate, and wrenches.

We also checked out the Delta Super Chuck shown above, an Australian-made expanding collet system that lists for about \$120.

Unlike the Three-Jaw or Precision Combination Chuck, you don't have to mess around with a pin chuck or turning the outside of the blank between centers first.

What's more, the recess for holding the stock is a snap to drill with the Delta system. With a drill press you bore a 5/16"-deep recess into the base of the bowl blank, using either a 50-mm (2-inch) or 75-mm (3-inch) bit (both of which are included with the Delta system). Then, you thread the matching collet to the back plate, tighten the assembled parts, and away you go! The system is fast and clean, and especially good with green lumber.

Chett Ray, product manager of Woodworker's Supply of New Mexico, likes nothing better than to turn four or five blanks on a Sunday morning, and the chuck he favors is the Delta Super Chuck.

"I don't think you can ever outgrow that chuck," he says. "The more you use it, the more you appreciate it." 🌲

Photographs: Hopkins Associates;
Jim Kascoutas

NOW! Woodmaster lets you **PLANE, MOLD & SAND** with the Precision Control of **Infinitely Variable Power-Feed!**



**FREE
30-DAY
TRIAL!**

Made in
U.S.A

**FREE
INFORMATION
KIT**

Just a twist of the dial gives you from 70 to over 1000 cuts per inch... you can sail through even the toughest oak at higher speeds, or slow down to surface stock that is virtually impossible on any other machine. Slower speeds turn out glass smooth molding... no sanding needed!

Now choose from two powerful models! Woodmaster introduces the first 18 1/2" Planer/Molder... The "BIG 18"... with all the features that have made the 12-in. model the most versatile Planer/Molder on the market. Whether you choose the 18" or 12" model... you'll find Woodmaster delivers!



Woodmaster's Quick-Change Molding Head lets you create custom moldings from any stock at a fraction of the price charged by custom shops... better quality, too!



Power-fed sanding speeds production and improves the quality of your work. No more waves or cross-grain scratches. Separate Sanding head installs in just minutes.



MADE IN AMERICA

Find out how you can try out this machine in your shop for a full 30 days... Call or write for your FREE Information Kit today!



WOODMASTER TOOLS, INC., DEPT. PW15
2908 Oak Street • KANSAS CITY, MO 64108
Or Phone: 1-800-538-4200 Ext. 2315

YES! Please rush me your FREE Information Kit plus details on your 30-DAY FREE TRIAL GUARANTEE!

NAME _____
ADDRESS _____
CITY _____
STATE _____ ZIP _____

▲ DELTA HEAVY DUTY SHAPER

Because it has two speeds - 7,000 and 10,000 RPM - it will handle just about any shaping operation. Single phase, 230V, 3 HP motor reverses. Table size is a large 28" x 27". Spindle travel is 3". Capacity under the nut is 2-1/2" for the 1/2" spindle and 3-1/4" for the 3/4". Includes fence guard assembly, 3/4" and 1/2" spindles, 4 1/2" Safe Guard II" spindle guard, one table extension, table inserts, starting pin, two speed pulley and all wrenches.

Delta 2-Speed Heavy Duty Shaper (424 lbs.) with Router Chuck (worth \$69.00).

List SALE

43-375 \$2195.00 **\$1499.00** delivered

▲ DELTA SCROLL SAW

Big 2" capacity for large jobs. Infinitely variable speed from 40 to 2000 cutting strokes per minute, an easy-to-read LED digital speed read-out, the quickest changing chucks in the industry. 16" round cast iron table that rotates 90° and tilts 30° left, 45° right, 15° up and 30° down, special balancers for vibration-free cutting. The solid "C" arm and constant blade tension keep blade breakage low. You also get an assortment of 96 blades free.

18" Electronic Variable Speed Scroll Saw with stand, single phase 115V solid state electronic controlled, permanent magnet motor, 96 assorted blades and all blade changing tools with FREE 9" worklight (worth \$24.00).

List SALE

40-601 \$1117.00 **\$699.00** delivered

**Woodworker's
Supply**

OF NEW MEXICO

5604 Alameda, NE • Dept., Wood
Albuquerque, NM 87113

Toll-Free: 1-800-645-9292 VISA/MC

STONE MOUNTAIN

POWER TOOL CORPORATION

Post Office Box 2825

Norcross, GA 30091

404-446-8390

Call for current prices on any item

RYOBI POWER TOOLS

AP-10

10" Portable planer

Delivered **\$355.00**

EXTRA BLADES

\$20.00 per set



JSE 60

Jig Saw Electronic

Variable Speed

3.5 Amps

1,000-2,700 SPM

\$69.00 Delivered

R500

2 1/4 HP Plunge Router

13 Amps

22,000 RPM

\$135.00 Delivered



BD1025R \$89.00

EXTRA BATTERY

\$39.00

3/8" Cordless

Drill

9.6V.

Visa / MasterCard, Check or Money order.

"Jorgensen" AND "Pony"

CLAMPS

Dependable extra hands for all types of clamping and work-holding jobs: woodworking projects, home maintenance, and furniture repair.

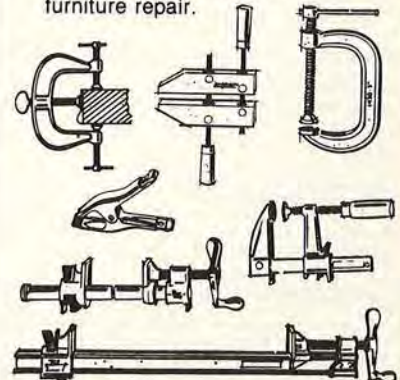

Write for FREE LITERATURE. For big 32-page "how-to-clip-it" catalog, send \$1.00.

ASK YOUR DEALER

ADJUSTABLE CLAMP COMPANY

THE CLAMP FOLKS

410 N. Ashland Ave./Chicago, IL 60622

Information



Print this article

WORTH WRITING FOR

You can get useful ideas and product information by mail. Use the coupon in this section to order your choice of literature listed below.

POWER TOOLS

SCROLL SAW AND LATHE INFORMATION — More than 20 pages of information, including full-color photos, on HEGNER precision scroll saws, HEGNER lathes, and HEGNER duplicators. Find out why these machines are considered state of the art, and what to look for when shopping for scroll saws or lathes. AMI, LTD. \$1.00. *Circle No. 3.*

WOODWORKING PROFESSIONALS ONLY — Now save 50% on machinery, 70% on operating costs! How? By using the world's finest production quality universal machine. Commercial durability, utmost precision, set-up in seconds. No other tool combines usable capabilities like FELDER. Thousands sold all over the world. Now available in America through AMI. Send for brochure. AMI LTD. \$1.00. *Circle No. 4.*

THE FIRST LINE IN JIG SAW — BOSCH — Bosch gives professionals a selection of top-of-the-line jig saws as well as an impressive selection of blades. Wholesale prices. Send for literature. AVIATION INDUSTRIAL SUPPLY. 50¢. *Circle No. 12.*

BUILD IT! FROM BLACK & DECKER — A new, easy-to-read consumer publication from Black & Decker offers valuable tips to do-it-yourselfers. BUILD IT! gives step-by-step instructions for tackling numerous woodworking projects. Each "how to" article is illustrated with close-up shots of the various construction steps and is accompanied by a list of suggested materials and tools. BLACK & DECKER. \$2.50. *Circle No. 15.*

INDUSTRIAL QUALITY CUTTING TOOLS — Three large, colorful wall posters keep DML's huge line of carbide-tipped cutting tools close at hand for easy reference. Separate posters for saw blades, shaper heads (with diagrams of each cut), and router bits. Each features graphic displays of the tools, capabilities, and sizes. DML, INC. \$3.00. *Circle No. 30.*

MULTI-PURPOSE HOME WOODWORKING SYSTEM — The Emco Start-2000 is a table saw, band saw, moulding machine and disc sander and you can change operations in less than 30 seconds. One big 2 hp. motor does it all. With optional accessories you can do wood turning, mortising, horizontal drilling, and more. Send for four-color information. EMCO® USA. Free. *Circle No. 36.*

STATIONARY POWER MACHINES — Available from Elektra Beckum U.S.A. Corp. — advanced technology woodworking stationary power machines with the unique Unimex Motor interchangeable concept. For complete information on Jointer/Planer, Bandsaw, Dust Extractor, Spindle/Moulder, Lathe and Combi Saw send for our catalog. ELEKTRA BECKUM U.S.A. CORP. \$1.00. *Circle No. 39.*

EXCELLENCE IN SHARPENING EQUIPMENT — This two-color, 56-page catalog from Foley-Belsaw Co. provides information on its complete line of equipment used for sharpening home, garden, and industrial shop saws and tools. Each machine is fully illustrated, complete specs and pricing information are provided. FOLEY-BELSAW CO. Free. *Circle No. 41.*

BEAT INFLATION AND HIGH LUMBERYARD PRICES — Turn trees into valuable lumber with the world-famous ONE-MAN PORTABLE SAWMILL. Goes right to the trees — turns out smooth, truecut lumber every time. No crew needed... no experience necessary. Send for booklet. FOLEY-BELSAW CO. Free. *Circle No. 22.*

FREE SUBSCRIPTION TO FOLEY-BELSAW NEWS BULLETIN — For a limited time Foley-Belsaw will be giving away a 1-year subscription to their 64-page color publication. This publication includes stories and shop tips on all types of woodworking, tool sharpening, upholstery, engine repair, and locksmithing. The magazine, which is published six times a year, includes many special offers on Foley-Belsaw equipment. FOLEY-BELSAW CO. Free. *Circle No. 43.*

CUTTING TOOLS — Freud provides the finest in handtools and carbide cutting tools. From chisels and planes to saw blades and router bits. All this and more. Send for catalog. FREUD. \$1.00. *Circle No. 45.*

WOODWORKERS — SAVE \$500 ON TOOLS — Instead of buying expensive power tools, purchase kits that include the parts, nuts, bolts, and full-sized patterns, with replacement parts always available. GIL-BILT kits with 5-year guar-

antee for everything from bandsaws to belt sanders. Send for our catalog today. GILLIOM MFG. \$1.00. *Circle No. 47.*

IF YOU ARE INTERESTED IN FINE WOODWORKING — you will not find better machinery than that sold by J.P. Humfrey Ltd. For example, we have 10-in. general tablesaws (2 HP, magnetic switch, lever-lock fence) available at \$1,295 FOB New York. Send for brochure. J. PHILIP HUMFREY LTD. \$1.00. *Circle No. 51.*

AFFORDABLE INDUSTRIAL QUALITY SANDING MACHINERY — Conveyor-fed single and dual-drum thickness sanders available in four sizes, 12, 18, 24, and 36 inches. Virtually eliminates hand sanding and improves quality, precision, and finish of your work at the same time. Plus many other products to make you more productive. Illustrated catalog and brochures. KUSTER WOODWORKERS, INC. 50¢. *Circle No. 55.*

AMERICAN-MADE WOODWORKING EQUIPMENT — The RBI Hawk line of precision scroll saws in models from 12 to 26 inches. Unique patent pending cam tensioning system allows quick resetting of blades when doing inside cuts. RBI line of woodplaners, models 408 and 612; over 50 years experience in building wood thickness planers coupled with patented quick change cutterhead, to allow fast and easy changeover to molder or sander, make the RBI the best value on the market today. 30-day In-Shop Guarantee of Satisfaction. RB INDUSTRIES, INC. Free. *Circle No. 65.*

HAND TOOLS

WOODWORKING TOOL CATALOG — Complete 108-page catalog of hard-to-find hand woodworking tools. We have a stock of over 300 book titles and carry the Myford English wood-turning lathe. Also inventoried are wood finishes of all possible descriptions and carving tools unequaled anywhere in the United States. Send today for your ticket to woodworker's heaven. You too, can be turning out quality woodwork. FROG TOOL CO., LTD. \$1.00. *Circle No. 120.*

PERSONAL BRANDING IRONS — Brochure describes branding irons that enable you to put your name on your work quickly and easily. Made especially for branding wood, they are available with 1, 2, or 3 lines of copy or with your logo. Changeable data also available. NOVA TOOL CO. \$1.00. *Circle No. 160.*

STAINS/FINISHES

BEAUTIFUL WIPE-ON WOOD FINISHING — is explained in a booklet from a pioneer in wipe-on finishes since 1928. Wood finishes that produce a beautiful hand-rubbed finish without messy brushes or spraying. Specially formulated finishes that simply wipe-on with professional results every time — guaranteed! Unlike conventional finishes these will never yellow, crack, or craze and they dry dustfree without runs. These finishes will bring out the natural beauty of the wood and never needs waxing. Send today for your wood finishing guide and products catalog. GENERAL FINISHES. 25¢. *Circle No. 225.*

BEAUTIFUL WOOD FINISHING — with Watco Danish Oil Wood Finish. Full-color *How to Beautifully Finish Wood* booklet enables anyone to create professional finishes the first time with all types of wood. One application of Watco Wood Finish seals, primes, finishes, hardens, protects, beautifies, penetrates deeply into the wood; outlasts surface coats three to one. Eight attractive Danish Oil colors now available. Eliminates pre-staining. WATCO-DENNIS CORP. Free. *Circle No. 270.*

PLANS

OVER 500 WOODWORKING DESIGNS — We now offer thirty-nine packets of blueprint plans and full-size patterns with both the home and commercial craftsman in mind. Enjoy making toys, games, children's items, whirligigs, folk art, plaques, magazine racks, shelves, kitchen and household items, birdhouses, plant stands, and more. Simple enough for the beginner, fun and profitable for the pro. Send for illustrated brochure plus sample pattern. ACCENTS IN PINE. \$2.00. *Circle No. 310.*

WOODWORKERS' PLANS AND SUPPLIES — Wood projects are simplified with the high quality plans, specialty hardware and other supplies offered by Armor Products. Over 100 plans are available for making toys, desks, clocks, pool tables, lamps, chests, and other furniture. Movements, dials, moldings, ornaments, and hardware also available. ARMOR PRODUCTS. \$1.00. *Circle No. 315.*

CATALOG OF PLANS AND KITS — A selection of functional projects, unique gifts, and decorative pieces for home or office. Included are a sandpile scooper, super bunk beds, miniature two-story outhouse, birthday calendar, and many more. See our ad elsewhere in this issue. BALLART DESIGN. \$1.00. (Refundable) *Circle No. 320.*

PLANS AND PATTERNS — This large selection of plans includes furniture designs, loom, spinning wheel, clocks, doll houses and furniture, cradles, toys, alphabets, bird houses, weathervanes, cedar chest, and much more. CRAFTPLANS CO. 50¢. *Circle No. 325.*

BUILD IT YOURSELF — Why buy it when you can build it? Illustrated catalog of hundreds of interesting and fun items you can create yourself for personal use or profitable sale. Our 1986 catalog contains toys, games, plaques, puzzles, birdhouses, planters, accent furniture, and much more. All patterns are full-size blueprints — no enlarging is necessary. Simply trace and create. DESIGN GROUP. \$1.00. *Circle No. 340.*

PLANS AND PATTERNS FOR WOODWORKERS — New unique woodworking plans and patterns. Select Patterns for wooden toys or novelty decorations. The plans are fully illustrated with step-by-step instructions and photos. Send for a brochure today. FUNWOOD CRAFTS & TOYS. \$1.00. *Circle No. 343.*

FULL-SIZE FURNITURE PLANS CATALOG — Illustrates and describes over 180 plans for making furniture of quality found in museums and fine furniture stores. Plans include rolltop desk, cradles, dining tables, chairs, buffets, chests, gun cabinets, poker table, children's furniture, rocking horse, spinning wheels, and more. Bill of materials exploded drawings assist the woodworker. FURNITURE DESIGNS, INC. \$2.00. *Circle No. 345.*

COUNTRY FURNITURE PLANS — Our catalog features 14 designs — from country pie safe to mini-barn. Also included are various products for the home workshop. Send for our latest catalog. Price of catalog deducted from your first order. HAMMERMARK ASSOCIATES. \$1.00. *Circle No. 370.*

WOODWORKING PLANS — Catalog of full-size plans printed on heavy paper for toys, gifts, novelties, action windmills, shelves, birdhouses, garden furniture, Dutch windmill, lawn ornaments, old-fashioned lawn swing, jigsaw projects for children, and more. MASTERCRAFT PLANS WEST. \$1.00. *Circle No. 390.*

LAMINATED SOUTHERN PINE TABLE TOP — Make your own woodworker's bench. Send for information. SOUTHERN PINE. Free. *Circle No. 450.*

CLASSIC CARS AND TRUCKS — Flyer of seven full-size wooden toy patterns of early 1900's motor vehicles — 1912 White Gas Truck, 1929 Chrysler Imperial, 1924 Dodge Delivery Van, 1931 Packard Le Baron, 1915 Peirce Arrow, 1926 Gramham Brothers Truck, and 1929 Chevy Truck. Easy to follow instructions, pictorial assembly views and complete stock list. Two inch spoked wheels available to compliment these designs. TOY DESIGNS. 40¢. *Circle No. 466.*

PROJECT PLANS FOR WOODWORKERS — Professionally designed projects include furniture, playthings, and accessories, to more complex projects such as storage sheds and gazebos. These plans are designed using readily available materials, keeping in mind standard sizes of lumber. Instructions are clear and concise, and occasionally include tips that will make your job easier. Some plans have a cut-out materials list to take with you to the lumber yard. All plans are current, and we are constantly adding to our line. Order our catalog now and get started! THE WORKSHOP BLUEPRINT CO. \$2.00. *Circle No. 485.*

LUMBER

BEAUTIFUL WESTERN HARDWOODS — Cal Oak is California's exclusive hardwood lumber producer with direct mill sales regardless of value. No broker's fees, no middle-man! Indigenous, unique & exotic woods — Black Oak, Pacific Madrone, Ten Oak, Calif. Black Walnut, Freemont Cottonwood. Rough and surfaced lumber, paneling, flooring, dimension stock. Full quality hardwood at great prices. Send for our buyer's kit with brochure, information of Western hardwoods, and price list. CAL OAK LUMBER. \$1.00. *Circle No. 517.*

WOODWORKERS! HELP CELEBRATE OUR 55TH YEAR OF SERVICE — Send for our new 148-page Craftsman 1985 catalog. 42 varieties of choice hardwoods 1/4"-in. to 4"-in. thickness. Fine hardwood veneers, tools, moldings, trim, marquetry inlays, upholstery and lamp supplies, finishes, clock kits, and hard-to-find hardware. 4,000-plus items for your projects. CRAFTSMAN WOOD SERVICE CO. \$1.00. *Circle No. 520.*

DO-IT-YOURSELF LUMBER DRYING — This 22-page booklet *Kiln Chamber Construction Guide and Operation Manual* is designed for the individual wishing to dry his own lumber with a minimum investment of money, time, and space. Included are principles of dehumidification lumber drying, selection of which dryer is best for you, and kiln chamber plans and construction information. Also you will receive a questionnaire you can fill out and return. Once completed and returned you will receive free a computerized evaluation of your drying needs including investment considerations, operating costs, and payback. EBAC OF AMERICA, INC. \$5.00. *Circle No. 525.*

EdLco — WE KNOW OUR LUMBER — Educational Lumber Company is pleased to offer you our new catalog, stacked with excellent buys at delivered prices. Available to you are over 21 species of imported as well as domestic hardwoods, softwoods, turnings, shorts, veneers. All our lumber is kiln dried. As school shop suppliers for 35 years, we know our lumber. It is top-grade. Send today and receive your BONUS GIFT: 4 new furniture designs. EDUCATIONAL LUMBER CO., Inc. \$2.00. *Circle No. 530.*

MACASSAR EBONY — Professionals agree it's one of the world's hardest, rarest, and most beautiful woods. Macassar is coveted by woodworkers, artists, turners, and connoisseurs for its marbelike beauty and durability. We have the largest commercial selection of dimensional stocks in the U.S., from 1 to 8 inches thick and from 4 to 20 inches wide in random lengths to 9 ft. These are virtually unavailable elsewhere at any price. As a direct importer, we offer the lowest prices anywhere with no minimum orders. Send today for a complete description, inventory and price list (refundable with first order). ART EISENBRAND, INC. \$1.00. *Circle No. 535.*

THIN LUMBER — Approximately 20 species of thin lumber, widths vary up to 3/4-in. Kiln dried. Turning squares. Send for price list. HARDWOODS OF ILLINOIS. 50¢. *Circle No. 545.*

KILN DRIED CABINET GRADE HARDWOOD — In 18 different varieties. Thickness 3/4 — 1 1/4. Drawer stock, carving wood, turning squares, and material for paneling, flooring, and wainscoting. We ship small amounts UPS, medium loads motor freight, large loads via trailer. Comprehensive listing. NATIVE AMERICAN HARDWOODS. \$1.00. *Circle No. 560.*

PORTABLE SAWMILL SYSTEM — You can harvest your own wood with the Sperber Sawmill. No need for heavy equipment. Cut lumber to size where it falls. Many of our customers have paid-off their mill with one weekend's cutting — or less. Send today for brochure package and start milling your own wood. SPERBER TOOL WORKS. \$1.00. *Circle No. 580.*

EXOTIC HARDWOODS — Wyndham Woods offers the finest exotic hardwoods, precision cut and dried to our specifications at a modern European mill. As a direct importer we can offer substantial savings on such fine woods as padouk, mahogany, shedua, doussie, zebra wood, and many others, as well as domestic species and veneers. For the best wood at the best prices, send for our catalog. WYNDHAM WOODS, INC. \$1.00 (Refundable with order). *Circle No. 595.*

GENERAL WOODWORKING CATALOGS

EVERYTHING FOR THE WOODWORKER — Makita, Hitachi, and Black and Decker power tools at well below list prices. Plus a wide selection of woodworking supplies, including candle cups and shaker pegs. Price of catalog is refundable with order. BENNY'S WOODWORKS. \$2.00. *Circle No. 810.*

WOODWORKERS TOOLS AND MATERIALS — 116-page catalog offers fine hardwoods, veneers, inlays, picture molding, wood finishes, carving blocks, cabinet hardware, and cane. Specialty woodworking tools, shop equipment, plans, instruction books. ALBERT CONSTANTINE AND SON INC. \$1.00. *Circle No. 820.*

WOOD TURNING — Complete selection of round, square, and bowl stock for the wood turner — walnut, cherry, maple, and other domestic hardwoods. Large selection of traditional and contemporary turning tools. Each catalog contains complete details for various turning projects. New this year — kits and kit supplies. CRYDER CREEK WOOD SHOPPE. \$1.00. *Circle No. 840.*

JAPANESE WOODWORKING TOOLS — A fine selection, including chisels and gouges, sharpening stones, saws, marking tools, hatchets, knives and garden tools, from some of Japan's most respected small toolmakers. Send for catalog. FINE TOOL SHOPS. Free. *Circle No. 850.*

1985-86 MASTER CATALOG — contains 228 pages of the finest in woodworking hand tools, machinery, and finishing supplies plus over 125 books. Of particular note is the selection of Japanese tools. The format is all four-color. GARRETT WADE CO. \$3.00. *Circle No. 855.*

WOODWORKING MACHINERY CATALOG — Just arrived — 1985 full-color catalog of quality imported machinery and tools at low prices. GRIZZLY IMPORTS, INC. \$3.00. *Circle No. 860.*

PLANERS — Heavy duty 15x6 in. planers with 2 hp. single-phase motors. Other woodworking equipment at low, low prices. Send for 1985 color catalog. GRIZZLY IMPORTS, INC. \$3.00. *Circle No. 861.*

DUST COLLECTORS — for the small/medium size shop. Capable of handling from 1 to 3 machines at the same time.



This VET Did It — and YOU Can Do It Too!

"War injuries left me badly handicapped, but now I'm a financial success as a Locksmith, thanks to your training. Besides, the work is fascinating, if I can do it anybody can." — Glen Johnson, Larned, Kan.

Make Up to \$26.00 an Hour — even while learning!

Train FAST at Home!

Be a LOCKSMITH!

If you enjoy fixing things, you're a "natural" to make hundreds of EXTRA DOLLARS a year in the fascinating business of Locksmithing. Rising crime has increased demand for service a thousandfold. Yet there's only one Locksmith for every 17,000 people!

COLLECT CASH PROFITS ALMOST AT ONCE!

You're "in business" ready to make \$10 to \$26.00 an hour a few days after you begin Foley-Belsaw's shortcut training. Easy illustrated lessons complete with ALL practice equipment PLUS

- ALL TOOLS YOURS TO KEEP
- KEY MACHINE YOURS TO KEEP
- EXPERT PERSONAL ASSISTANCE
- BUSINESS-BUILDING HELP

enable you to get your share of this always-profitable business. Hundreds we've trained are doing it. So can YOU.

MAIL COUPON to discover how Locksmithing can keep the extra money coming in during spare time — or in your own full-time business. Ideal for retirement—good jobs, too.

FOLEY-BELSAW INSTITUTE, 11016 Field Bldg. Kansas City, Mo. 64111

N. Hunt, Wilmington, Del.—"I make \$50 a week extra."

R. Davis, St. Louis, Mo.—"I cleared \$110 last Saturday."

Ed Boyle, Pittsburgh, Pa.—"My business going at top speed. I'm moving to bigger quarters."



MAIL THIS COUPON • NO SALESMAN WILL CALL

FOLEY-BELSAW INSTITUTE, 11016 Field Bldg. Kansas City, Mo. 64111



Rush FREE book, "Keys to your Future."

Name _____

Address _____

City _____ State _____ Zip _____

THIS DO-ALL PRO KEY MACHINE YOURS TO KEEP!

Can add \$50 to \$100 a week to your income... and doesn't cost you a penny extra!

FREE

The workbench companion

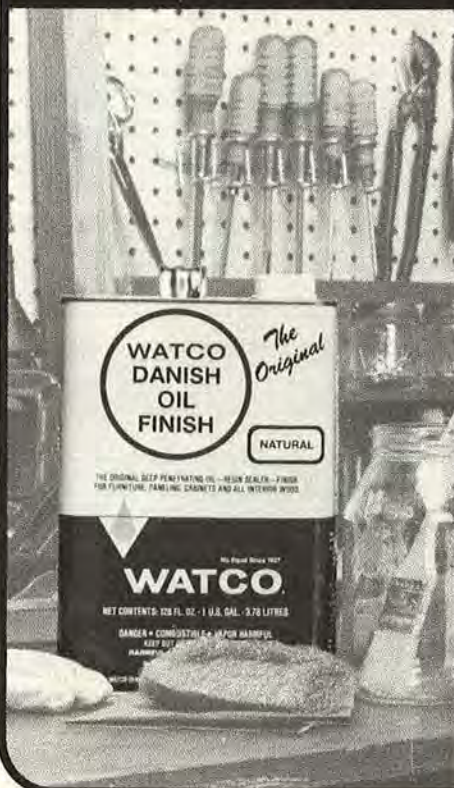

WATCO®

The Original and Still the Best

DANISH OIL FINISH

Watco Danish Oil Finish can be your ideal workbench companion for all those wood finishing projects around the house. You'll be amazed at how easy it is to finish wood beautifully with Watco, "The Original Danish Oil". Watco gives wood that natural, hand-rubbed look with long-lasting durability. And because Watco is **IN** the wood... not on it like temporary surface coatings... there is no finish that will wear off. Watco Danish Oil is ideal for furniture, paneling, cabinets, doors, trim-work and even antiques. It's also safe for use on butcher blocks, cutting boards, and children's toys after Watco dries and cures in the wood. Choose from 8 beautiful finishes... Natural and Medium, Dark, and Black Walnut shades, and Cherry, Golden Oak, Fruitwood, and English Oak colors.

Send today for "Free" color booklet "How to Finish Wood Beautifully and Easily" and the name of your nearest Watco distributor.

WATCO-DENNIS CORP., 1756-22nd St. Santa Monica, CA 90404, Dept. BH-W126

Name _____

Street _____

City _____

State _____ Zip _____

Another Winner from America's Favorite Woodwright



THE WOODWRIGHT'S WORKBOOK

Further Explorations in Traditional Woodcraft

ROY UNDERHILL

Roy Underhill returns to PBS this fall with a new thirteen-week series, and we are back with his third book. *The Woodwright's Workbook* features step-by-step instructions for the most popular projects from past shows and a great selection of items from shows to be introduced during 1986-87. Included are plans for tool chests, workbenches, lathes, a six-board chest, rustic chairs, and the Rittenhouse hygrometer. Roy also explores building barns, forges, and boats. All projects are illustrated with photographs and measured drawings.

225 pp., 290 illus., \$12.95 paper, \$19.95 cloth

Also by Roy Underhill:

The Woodwright's Shop

A Practical Guide to Traditional Woodcraft
221 pp., 327 illus., \$12.95 paper

The Woodwright's Companion

Exploring Traditional Woodcraft
203 pp., 262 illus., \$12.95 paper, \$19.95 cloth

Watch Roy in his sixth new season of "The Woodwright's Shop" on PBS beginning late October. Call your local station for scheduling.

Available at your favorite bookstore or

The University of North Carolina Press

PO Box 2288, Chapel Hill, NC 27514

Priced within the home shop budget, yet capable of handling cabinet shopwork. Other woodworking machinery and tools — low prices. Send for catalog. GRIZZLY IMPORTS, INC. \$3.00. Circle No. 862.

WOODWORKING SUPPLIES CATALOG — Send for new 36-page color catalog of hundreds of foreign and domestic veneers, wood craft patterns, turning squares, carving blocks, toymaking supplies, hardwood lumber (at factory-to-you prices), chair cane, books, spindles, dowels, shaker and mug pegs, candle cups, fancy inlay borders, made-to-order 1-ply and 2-ply veneers and plywoods (every specie including all burls and crotches). Also included is a colorful wood selector chart, simplified veneering instructions and introductory incentive offers and free gift offers. BOB MORGAN WOODWORKING SUPPLIES. \$1.00. Circle No. 890.

WOODWORKING TOOL CATALOGS — R.A. Ness & Co., the Woodworkers Emporium, offers a 2-year subscription, a total of eight huge sale catalogs. Thousands of industrial quality items — machinery, hand tools, portable electric tools, and supplies — are featured at super sale prices. The fee is refundable with purchase. R. A. NESS & CO., the Woodworkers Emporium. \$4.00. Circle No. 890.

TOOLS ON SALE — A division of Seven Corners Ace Hardware Inc. offers a comprehensive catalog featuring over 190 pages of the most competitive prices in the industry. If you're looking for savings and fast delivery on over 1,800 items, request our catalog. This catalog offers one of the most complete selections of power tools available anywhere from the most respected manufacturers in the industry: Milwaukee, Makita, Porter-Cable, Black & Decker, Freud, Bosch, Delta, and many more. SEVEN CORNERS ACE HARDWARE INC. Free. Circle No. 930.

CABINET MAKERS' TOOLS AND SUPPLIES — New 224-page catalog of fine hand and power tools for cabinet makers or serious woodworkers. Also featured are three sections on hardware, supplies, and cutting tools. This catalog takes the mystery out of using European hardware. A must reference for the woodworker. THE SOURCE. \$3.00. Circle No. 935.

WOODWORKERS CATALOG — More than a catalog — it's one of the best sources for quality woodworking tools. You'll find everything from bit braces to wood borers, from saws to sharpening stones. Every product is sold satisfaction guaranteed. WOODCRAFT SUPPLY CORP. Free Circle No. 955.

WOODWORKERS SUPPLY — Offers high quality tools and supplies for skilled, amateur, and professional woodworkers. Our complete catalog includes machinery, hand tools, plans, router bits, shaper cutters, wood specialties, and more. For your two year subscription send to WOODWORKERS SUPPLY OF NEW MEXICO. \$2.00. Circle No. 975.

WOODWORKING MACHINERY CATALOG — Workbench Tool Co. is now offering the Powermatic 26 spindle shaper, 3 hp., 1 ph., ½ to ¾ in. spindles, reversing switch for only \$1625 FOB. Send for catalog. WORKBENCH TOOL CO. \$2.00. Circle No. 985.

IS THIS THE WORLD'S BEST JOINER-PLANNER? — We think so and invite you to take a closer look! MiniMax's new FS-35 joiner-planer combines industrial quality with an affordable price that will appeal to professionals and amateurs alike. THE XYLOPHILES CO. \$1.00. Circle No. 994.

KITS

ANTIQUÉ REPRODUCTION WOODEN TELEPHONES — Dakota Woodworks is the country's largest manufacturer of antique reproduction wooden telephones. Kits available in two skill levels, one with plans and hardware, one with pre-cut oak cabinetry and hardware. All hardware is solid brass. Both kits include complete solid-state electronics package and detailed instructions. Send for four-color 12-page catalog. DAKOTA WOODWORKS. \$2.00. Circle No. 1020.

DO-IT-YOURSELF GRANDFATHER CLOCK KITS — Direct from world's largest manufacturer of grandfather clock kits. Prices starting at under \$280 including West German Westminster chiming movement. Choose from black walnut, cherry, and oak. Other quality heirloom kits also available. Send for brochure. EMPEROR CLOCK CO. 50¢. Circle No. 1030.

QUALITY CLOCK KITS AND PLANS — Handmade and semi-assembled of carefully selected ¾ in. cherry, oak, or walnut with beveled glass. Or build from "scratch" using our detailed plans and trim pieces. Choice of quality movements. Established in 1916. KUEMPEL CHIME CLOCK WORKS. \$2.00. Circle No. 1050.

WOODEN SHIP MODELS — Discover the world's hobby — building fine-quality, historic wooden ship models. Described are true-to-life scale replicas, lifelike in every detail. A 64-page color catalog introduces you to this fascinating hobby. MODEL EXPO, INC. \$1.00 (Refunded with first order). Circle No. 1060.

CLOCK COMPONENTS — We feature battery, pendulum, and chime quartz movements of all types: Urgos, Hermle, Grandmother, Grandfather cable drive and chain drive, keywind movements of all types, 400-day clocks, music box movements, flat and benzol type dials — plus a vast assortment of weather instruments. Hundreds of clock items. Very competitive. 75-page catalog. NEWPORT ENTERPRISES. Free. Circle No. 1065.

CLOCK BUILDERS — New 1986-87 catalog with everything you will need for building that family heirloom. Products include: 40 clock plans, mechanical and quartz clock

movements from nine tube Grandfather to four melody quartz battery movements, dials, hardware, and all component parts related to clock building. Quantity prices available. Price of catalog refunded with first \$25.00 order. TURN CRAFT CLOCK CO. \$3.00. Circle No. 1085.

SOLID WOOD CLOCK KITS — Full-color catalog of beautiful, easy-to-make clocks. Grandfather, mantel, and wall clocks. All solid wood with solid brass pre-assembled movements. All parts hand-cut for perfect assembly even by beginners. VIKING CLOCK CO. 50¢. Circle No. 1090.

PUBLICATIONS

THE WOODWRIGHT'S WORKBOOK — The latest book by America's favorite woodwright, Roy Underhill. Includes illustrated plans for projects from his 1986-87 TV series plus popular projects from past shows. Roy returns to PBS this Oct. with a new 13-wk. series of "The Woodwright Shop." Write for information on his new book & 2 previous books. UNIV. OF NO. CAROLINA PRESS. Free. Circle No. 1165.

SHOP ACCESSORIES

MAKE WOODEN TOYS — Whirligigs, doll houses, swing sets, classic autos, furniture and crafts with our plans, kits, parts, and supplies. For all skill levels. Also parts (toy, craft, game, and furniture) and dimensional lumber in maple, oak, walnut, and cherry along with specialty brass parts, tools, books, organizers and finishes. Send for color catalog subscription. CHERRY TREE TOYS, INC. \$1.00. Circle No. 1220.

UNIQUE, VERSATILE TOOL AND PARTS STORAGE SYSTEM — features tool panels, cabinets, and workbench attachments to safely store and organize your valuable hand and power tools and small parts. This very functional system offers inter-changeable tool hooks, bins, and shelves to let you custom-tailor your work area. Ideal for woodworking and hobby applications. CONCEPT 2001, INC. Free. Circle No. 1225.

RIPSTRATE SAVES FINGERS — for table saw and radial arm saw users. Brochure describes the RIPSTRATE and shows how it gives straighter cuts, speeds, the work, prevents kickbacks, and keeps hands away from the blade. FISHER HILL PRODUCTS. 25¢. Circle No. 1235.

EASY DOES IT — with HTC'S power tool accessories. Discover many unique items, designed only with you, the dedicated woodworker, in mind. Make your machinery safer, increase the working area of your shop and accomplish nearly impossible tasks easily, quickly, accurately. Full-line catalog and price list. HTC PRODUCTS, INC. Free. Circle No. 1245.

DRUM SURFACE/THICKNESS SANDER — Now a radial arm saw accessory providing inexpensive, space saving surface/thickness sanding capability. Product features include: instant attachments to all radial saws, 44 in. sanding width, sanding drum with sandpaper fasteners, and vacuum dust collection. Send for information. PERFORMAX PRODUCTS. \$1.00. Circle No. 1253.

PROFESSIONAL SANDING EQUIPMENT — Sand-Rite's Brush Head sands mouldings and intricate carvings without losing detail or shape of the part. Pneumatic drum gives quick and excellent results on contoured shaped parts. Everything we sell is industrial quality. Send for brochure. SAND-RITE. Free. Circle No. 1275.

THE PERFECT SET-UP — Set of six large angles — 15°, 18°, 22.5°, 30°, 45°, and 60°, with attaching bar for setting miter & bevel on radial arm saws. A precision cut every time. Many uses in the shop or home. Constructed of durable plastic; will not damage blade. A must for every shop. Patent pending. Send for literature. ROBERT S. SMITH, INC. \$1.00. Circle No. 1279.

FREE: HOW TO SAVE TIME AND MATERIAL — Work with confidence and control. SHOPHELPER Safety Guides provide stability, to help eliminate binding, chatter, and kickback. With an extra pair of hands from SHOPHELPER you can hold work firmly on table and radial saws, shapers, band saws, and others. Complete information from WESTERN COMMERCIAL PRODUCTS. Free. Circle No. 1290.

ROUTER BITS AND SAWBLADES

CARBIDE TIPPED ROUTER BITS AND SHAPER CUTTERS — Over 200 router bits and shaper cutters displayed in catalog featuring 6 piece cabinet sets, 3 piece ½ in. shank router bit panel raising system, and 3 wing industrial shaper cutters. Shaper cutters available in ½ in. through 1-¼ in. bore with bushings. Router bits offered in ¼ in. and ½ in. shank. CASCADE PRECISION TOOL CO. \$1.00. Circle No. 1315.

HARDWARE/WOOD PARTS

MODERN HARDWARE FOR CRAFTSMEN — European concealed hinges for wood and glass doors are our specialty. No-bore glass door hinges plus everything else for your

stereo cabinet from casters to lid hinges. Make your kitchen cabinets more functional with wire shelves, baskets, and slides. Build a computer cabinet using our TV extension slides. No minimum order requirements and our prices are low. ALLEN SPECIALTY HARDWARE. \$1.00. *Circle No. 1405.*

BRASS FURNITURE HARDWARE — This 36-page catalog shows over 500 items of authentic reproduction hardware from the 1700's and on into this century. This fine quality hardware is a must for the furniture craftsman working on a new project, or the refinisher who needs replacement hardware. HORTON BRASSES. \$2.00. *Circle No. 1430.*

WOODWORKER'S SPECIALTIES — 48-page catalog of plans and hard-to-find hardware for the woodworker. Brass hardware, screws, cork products, wood turnings, canister liners, clock movements, picture frame supplies, lamp parts, and more. MEISEL HARDWARE SPECIALTIES. \$1.00. *Circle No. 1455.*

TIMBERS COUNTRY STORE — Catalog features hundreds of woodworking supplies, toy patterns, furniture patterns, tool use and instruction books, woodworking pattern books, hardwood toy and furniture parts plus many hard to find tools and shop supplies. TIMBERS COUNTRY STORE. Free. *Circle No. 1470.*

TOYMAKER'S SUPPLY COMPANY — has your best bulk price on quality wooden toy parts and toy plans. Over 50 turnings to make your toys professional looking. Send for catalog. TOYMAKER'S SUPPLY CO. Free. *Circle No. 1475.*

WOOD TOY PATTERNS — Patterns for all ages including children's patterns and executive toys. New catalog has many new patterns to choose from including parts and wheels. Send for new catalog and receive a coupon for free wheels and axle pegs. TOYS AND JOYS. \$1.00. *Circle No. 1480.*

IF YOU ARE INTERESTED IN RESTORING ANTIQUES — this 112-page catalog packed with unusual, hard-to-find items is just for you. Included are hundreds of essential items for antique restoration including top quality brass reproduction hardware, oil lamps and accessories, numerous wood component repair parts and kits, caning and basketry supplies, everything needed for wood refinishing, related tools, books, and a complete line of upholstery equipment and supplies. All at wholesale prices. Send for this informative catalog. VAN DYKE' SUPPLY CO. \$1.00. *Circle No. 1485.*

QUALITY AMERICAN-MADE WOOD TURNINGS — such as shaker pegs, spindles, toy wheels, toy parts, craft items, and dowel rods in birch, oak, walnut, and cherry. Send for complete 32-page catalog. WOODWORKS. \$1.00. *Circle No. 1490.*

INCOME OPPORTUNITIES

LETTER LAYOUT GUIDES — Brochure containing complete information about a new product of special interest to scroll sawers, carvers, and wood sign makers. A lettering guide to layout large letters and numbers to be cut in wood or other materials. Made from a durable plastic material for years of use. Price of brochure is refundable with first order. SEYCO SALES CO. \$3.00. *Circle No. 1670.*

MISCELLANEOUS

PERSONALIZED BRANDING IRON — Personalize your finished projects with BrandMark's solid brass branding iron. Easy to use, lasts for years, satisfaction guaranteed. Makes an ideal gift. See ad elsewhere in this issue or send for brochure. BRANDMARK. 25¢. *Circle No. 1905.*

CANE AND BASKET SUPPLIES — Every item used in caning and basketry is pictured in this new catalog for hobbyists and others interested in caning, rushing, etc., for either fun or profit. CANE & BASKET SUPPLY CO. \$1.00. *Circle No. 1912.*

CLOCK MOVEMENTS CATALOG — The 55-page catalog contains over fifteen different quartz clock movements, including pendulum, strike, and chime movements. Also shown are dials, hands, numerals, and accessories. It features movements made in Japan by the world's largest producer of quartz timepieces. CAS-KER CO. \$1.00. *Circle No. 1915.*

LOOKING FOR PIERCED TIN? COME TO THE SOURCE! — A 96 + page catalog plus color brochure introduces you to a treasury of pierced metal panels ready to install in kitchen cabinets, cupboards, pie safes, and other projects. Available in a large variety of sizes, 16 different finishes, over 150 patterns — or all the materials you need to create-it-yourself. Tin, zinc, copper, brass, kits, lanterns, furniture plans, and more! Artistry in pierced tin. COUNTRY ACCENTS. \$3.00. *Circle No. 1923.*

INDUSTRIAL QUALITY CUTTING TOOLS — DML offers 1,002 different cutting tools, each engineered for a specific task, all made in America. Four information-filled brochures detail carbide-tipped saw blades, bits, and cutters: concise copy explains applications, photos show tool configurations, and charts list sizes. DML, INC. \$1.00. *Circle No. 1935.*

DUBUQUE CLAMP WORKS — The company serious about producing the BEST wood clamps and wood clamp kits. DCW clamps offer strength, durability, and reliability. Two

kits available — Metal Hardware only or Metal Hardware Plus Maple Jaws and Handles. Send for literature. DUBUQUE CLAMP WORKS. \$1.00. *Circle No. 1949.*

BUY YOUR SANDING BELTS DIRECT FROM THE MANUFACTURER — Industrial Abrasives is the company that gives you six free belts with every dozen ordered. But, sanding belts are not the only product we have to offer. In our catalog you will find many specialty items not readily available in your hardware store. Price of catalog refunded with first order. INDUSTRIAL ABRASIVES CO. \$1.00. *Circle No. 1975.*

THE CUSHION CONTOUR SANDER — is a new concept in pneumatic drum sanding. Sanding sleeves are slid over an air bag (inflated with a hand tire pump) on an arbor to mount it between centers on a wood lathe. Drum effectively takes on profiles, curves, and bevels practically eliminating flat spots and chatter marks. INDUSTRIAL ABRASIVES CO. Free. *Circle No. 1976.*

PROFESSIONAL SAFETY PRODUCTS — A complete catalog of personal protective devices and work clothing available at discounted prices. Products include eye and ear protection, gloves, boots, hats, aprons, work clothing, and more. Every product is sold satisfaction guaranteed. KENCO SAFETY PRODUCTS. 25¢. *Circle No. 1989.*

FREE LITERATURE — New brochure showing all moisture meters and accessories for moisture meters such as interchangeable electrodes and probes and cables for in-kiln moisture monitoring. Complete line of moisture meters include: Pocket-size Mini-Ligno with LED readout 6%-20%, Mini Ligno E 6%-36%, analog or digital display meters 4%-30%, 60% and a digital moisture meter with built-in compensation for different wood temperatures. LIGNOMAT USA, LTD. Free. *Circle No. 1999.*

PRODUCTION QUALITY CARBIDE TIPPED ROUTER BITS — MLCS Ltd. offers a full line of professional production quality carbide tipped router bits at 50-70% lower than retail prices. We sell through the mail and only direct to craftsmen. Send today for information. MLCS LTD. Free. *Circle No. 2005.*

PERFECT EDGE-JOINING EVERYTIME — "Duo-Clamp" holds your boards flat while applying uniform yet firm pressure to squeeze out excess glue. Bowing totally impossible. The need for a surface planer is eliminated; a light belt sander finishes your job. Patent applied for. Easily assembled and unconditionally guaranteed. Made of sturdy maple. Send for information. MARK PRODUCTS. 25¢. *Circle No. 2009.*

WOOD CARVING — You can obtain information on learning woodcarving by sending for our literature. The offer in-

cludes sample copy of *The Mallet Magazine* and two lesson sheets on carving. NATIONAL CARVERS MUSEUM. \$1.00. *Circle No. 2021.*

BANDSAW OWNERS — A new tool is now available so you can make or repair any length bandsaw blade in minutes. Our splicer enables craftsmen to make up any length blade from economical coil blade stock quickly and easily. Three models are currently available to accommodate blade widths from 1/8 to 1 1/2 in. The tool comes complete with detailed instructions and supplies. We also carry OLSON bandsaw stock at reasonable prices. Send for literature. NEW MILFORD SPECIALTIES CO. 50¢. *Circle No. 2025.*

OUR FOUR COLOR CATALOG — features a large selection of movements, hands, dials, bezels, numerals, weather instruments, prints as well as a full-line of clock making supplies. Thousands of ultra-thin pendulum and chime movements in stock at all times. Most orders shipped within 48 hours. PRECISION MOVEMENTS. \$1.00. *Circle No. 2045.*

WOODWORKING ASSOCIATION OF NORTH AMERICA — First international association for woodworkers. Benefits include our quarterly magazine *International Woodworking*, specials from selected manufacturers, group health and life insurance, access to the woodworking network. WOODWORKING ASSOC. OF NORTH AMERICA. 50¢. *Circle No. 2092.*

DOOR SHOP® MANUAL AND CATALOG — The 37-page Door Shop® manual is clearly written and beautifully illustrated with over 156 detailed drawings covering the complete process of door building. Each section covers proper methods and exact set-ups for the router, including how to recognize and correct for errors. There are sections covering design, lumber selection, measuring, panel raising, rail and stile fitting, guides, clamping, gluing, and finishing. This is the most comprehensive manual out today. When you purchase the Door Shop® manual for \$5.00 you also receive Zac's 26-page router bit and shaper cutter catalog free. And as an extra bonus you receive a hardwood door corner sample with your catalog order. \$5.00 rebated with purchase. ZAC PRODUCTS INC. \$5.00. *Circle No. 2098.*

CARVING SUPPLIES

WOODCARVING TOOLS — Whittlers and carvers — Warren Tool Co. offers a catalog for you full of whittling and carving hand/power tools, books, stones, wood, and supplies. Since 1927, the finest in woodcarvers tools. WARREN TOOL CO., INC. 60¢. *Circle No. 2185.*

Information

WORTH WRITING FOR

TO ENSURE PROMPT HANDLING OF YOUR ORDER FOLLOW THESE INSTRUCTIONS:

- Circle your choice
- Enclose cash, check, money order for cost of booklets plus \$2.00 service charge (no stamps/foreign)
- Send coupon and remittance to address above
- ALLOW 4-6 WEEKS FOR DELIVERY
- Coupon expires December 14, 1987

WOOD SUBSCRIPTION

1. A 1 year WOOD subscription (6 issues) for \$18.00 — a \$3.00 savings off newstand rate. Allow 6-8 weeks for first issue. Add \$6.00 outside U.S. Be sure to include payment with total below.

FREE LITERATURE

Circle numbers below corresponding to items in this issue. Please include \$2.00 for handling charge

36	43	450	955	1225	1290	1976
41	85	850	1065	1245	1470	1999
42	270	930	1165	1275	1475	2005

PRICED LITERATURE

Numbers below refer to items on which there is a charge. Please include proper remittance.

3 ... \$1.00	225 25¢	517 \$1.00	855 \$3.00	1050 \$2.00	1480 \$1.00	2009 25¢
4 \$1.00	310 \$2.00	520 \$1.00	860 \$3.00	1060 \$1.00	1485 \$1.00	2021 \$1.00
12 50¢	315 \$1.00	525 \$5.00	861 \$3.00	1085 \$3.00	1490 \$1.00	2025 50¢
15 \$2.50	320 \$1.00	530 \$2.00	862 \$3.00	1090 50¢	1670 \$3.00	2045 \$1.00
30 \$3.00	325 50¢	535 \$1.00	890 \$1.00	1220 \$1.00	1905 25¢	2092 50¢
39 \$1.00	340 \$1.00	545 50¢	900 \$4.00	1235 25¢	1912 \$1.00	2098 \$5.00
45 \$1.00	343 \$1.00	560 \$1.00	935 \$3.00	1253 \$1.00	1915 \$1.00	2185 60¢
47 \$1.00	345 \$2.00	580 \$1.00	975 \$2.00	1279 \$1.00	1923 \$3.00	
51 \$1.00	370 \$1.00	595 \$1.00	985 \$2.00	1315 \$1.00	1935 \$1.00	
55 50¢	390 \$1.00	810 \$2.00	994 \$1.00	1405 \$1.00	1949 1.00	
120 \$1.00	466 40¢	820 \$1.00	1020 \$2.00	1430 \$2.00	1975 \$1.00	
160 \$1.00	485 \$2.00	840 \$1.00	1030 50¢	1455 \$1.00	1989 25¢	

Name (please print) _____
 Address _____
 City _____
 State _____ Zip Code _____

I AM ENCLOSING:

\$_____ for priced items
 \$ 2.00 for handling
 \$_____ total remittance



FACTS, FACES & FABLES
OF INTEREST TO HOME WOODWORKERS

"IN PURSUIT OF BEAUTY"



This finely crafted, highly detailed rosewood library table was designed by the Herter Brothers in 1882 for William Vanderbilt. From now until January 11, you can see it and other fine pieces from the 1870s and 1880s at an exhibition titled "In Pursuit of Beauty: Americans and the Aesthetic Movement," in the American Wing of New York's Metropolitan Museum of Art.

Sponsored by Meredith Corporation, publisher of *Better Homes and Gardens*® WOOD magazine, and the National Endowment for the Humanities, the exhibition examines the post-Civil War trends that brought art into everyday life.

ON THE LEVEL: THE STORY OF THE STANLEYS

Finding a person with the last name of Stanley in New Britain, Connecticut, before the Civil War was as easy as finding acorns under oak trees. And, if there had been telephones and directories back then, all the Stanleys would have been listed in the Yellow Pages under "tools" or "hardware."

Frederick T. Stanley and his brother William founded The Stanley Bolt Manufactory there in 1843 to make bolts, hasps, handles, and other hardware items. Two cousins, Augustus and Gad Stanley, established A. Stanley and Company in 1850 and began manufacturing rules.

Seven years later, in 1857, Henry Stanley, yet another cousin, merged with Augustus and Gad and a local New Britain level-and-plumb manufacturing business to form the Stanley Rule and Level Company. Meanwhile, Frederick and William's enterprise had

WHERE YOU'LL FIND THE WOOD

Of the nearly 1,200 species of forest trees found in this country, the southeastern states of Alabama, Florida, Georgia, Kentucky, Mississippi, North Carolina, South Carolina, Tennessee, and Virginia have the most variety. You'll find at least half of all species growing there.

When it comes to hardwoods, however, the northern states (above the old Mason-Dixon line) grow more than half. The South accounts for 41 percent, and the West — the Pacific Coast in particular — has the rest.

grown to become The Stanley Works, and added hinges.

Through the late 1800s and the turn of the century, both companies evolved into leading manufacturers in their respective fields — The Stanley Works in hardware and the Stanley Rule and Level Company in hand tools. The companies even sold their products internationally.

In 1920, all the Stanleys decided to get together — business-wise. The two companies merged, with Stanley Rule and Level becoming the present Stanley Tools Division of The Stanley Works. United, the companies paved the road for growth.

Today, 143 years after the first Stanley business was born, no direct descendants of the Stanley family plot the company's course. But the name has earned a worldwide recognition with consumer, builder, and industrial products.

AROUND THE NATION

16th Annual Midwestern Wood Carvers Show, Nov. 1-2

Belle-Clair Exposition Hall, Belleville, Ill. Over 140 wood-carvers. Sales of tools and supplies. Sponsored by the Belleville Wood Carvers Club. Contact Don Lougeay at 618/233-5970 for more information.

Last Chance Woodworker's Show, Nov. 8-9.

Palmer Auditorium, Austin, Texas. 1st annual show and sale of original, hand-crafted pieces. Exhibitors expected to total 200. Sponsored by the Austin Woodworkers Guild. For details, call French Smith, 512/472-4864.

20th Annual Foothills Craft Guild Fall Show, Nov. 14-16.

The Civic Center, Oak Ridge, Tenn. Show of traditional and contemporary crafts, demonstrations, and music played on handmade instruments. Celebrates state's craft heritage. Sponsored by Foothills Craft Guild, Inc. Call Dorothy Senn, 615/483-0587.

Woodworking World Show Nov. 21-23.

Charlotte Civic Center, Charlotte, N.C. Exhibits, sales, and demonstrations of machinery, tools, and supplies. Seminars for woodworkers. For more information, call 603/536-3768.

Northern California Woodworking Show, Nov. 21-23.

San Jose Convention and Cultural Center, San Jose, Calif. Features machinery, power and hand tools, supplies, demonstrations, and free workshops. For details, call 213/477-8521.

Artistry in Wood, Nov. 29-30.

Marymount College, Arlington, Va. 11th annual wood-carving show, includes exhibits of work, sales, and demonstrations. Sponsored by Northern Virginia Carvers. Contact Charles Schafer, 703/256-2779.

Working With Wood Show, Dec. 5-7

Disney Land Hotel, Anaheim, Calif. Tool and technique demonstrations, hands-on product testing, and sale of woodworking supplies and equipment. Area craftsmen exhibiting. For complete information, call 408/973-0447.

SCHOOL BOARDS

In colonial times, school blackboards were actually made of wide pine boards painted a dull black. The name stuck even when blackboards were made of slate, and remains with us today, no matter what materials are used. 🍷

A CLASSIC FIGURE WILL IMPROVE THE LOOKS OF YOUR COLLECTION.



Your stamp collection will look four times better when you carve out a place in it for these beautifully crafted figures of American folk art.

There's the graceful ship figure-head that a century ago adorned the bow of sailing vessels.

And the colorful cigar store figure that once stood in storefronts across America.

A handsomely crafted mariner with sextant and a highlander round out this issue.

Get your hands on these stamps and become a crafty collector.

Whether you're a serious collector or just a beginner, when you look into stamps, you discover yourself.

U.S. Postal Service

© 1986 USPS



There's only one saw that compares to a new Delta 14" Band Saw.



An old Delta 14" Band Saw.

If you want to own a band saw with Delta quality, you have two choices.

You can buy a new Delta band saw from a dealer.

Or you can buy an old Delta band saw from an old-timer.

But you may have a heckuva time convincing him to part with it.

Because Delta owners are kind of attached to their machines.

They're spoiled by a band saw that doesn't vibrate. (And makes so little noise, they can practically hear the sawdust hit the floor.)

They're loyal to the micrometer adjustment blade guide system. To those precision balanced alu-

minum wheels with replaceable tires.

That's why we haven't changed it much over the years.

Recently, we did restyle it. With a sleeker finish and streamlined trim. But we still make it in America. And we still make it like we used to.

So when you buy a *new* Delta Wood or Metal Cutting 14" Band Saw, you're buying the same kind of quality you find in our old band saws.

And you won't have to twist our arm to sell you one.

The Delta 14" Band Saw. We keep building on our tradition. So

you can, too. Call toll-free for the name of your Delta distributor: Delta International Machinery Corp., 800/438-2486 (in PA, 800/438-2487).



DELTA
Building On Tradition