

Better Homes and Gardens®

WOOD®

THE MAGAZINE FOR HOME WOODWORKERS

\$3.95

FEBRUARY 1988 • ISSUE NO. 21
Display Until February 16

CONSIDERING A PLUNGE ROUTER?

Read our advice on how
to select the right one

BOOKCASES AND SHELVES

Construction methods,
materials to use, and
planning pointers
(see page 58)

MAKE-'EM-YOURSELF MOLDINGS

6 patterns to try
your hand at

TERRIFIC PROJECTS

Picture frame
Laminated letter opener
Band-sawn boxes
Decorative spice jars

BUILD THIS CLASSIC BARRISTER'S BOOKCASE...

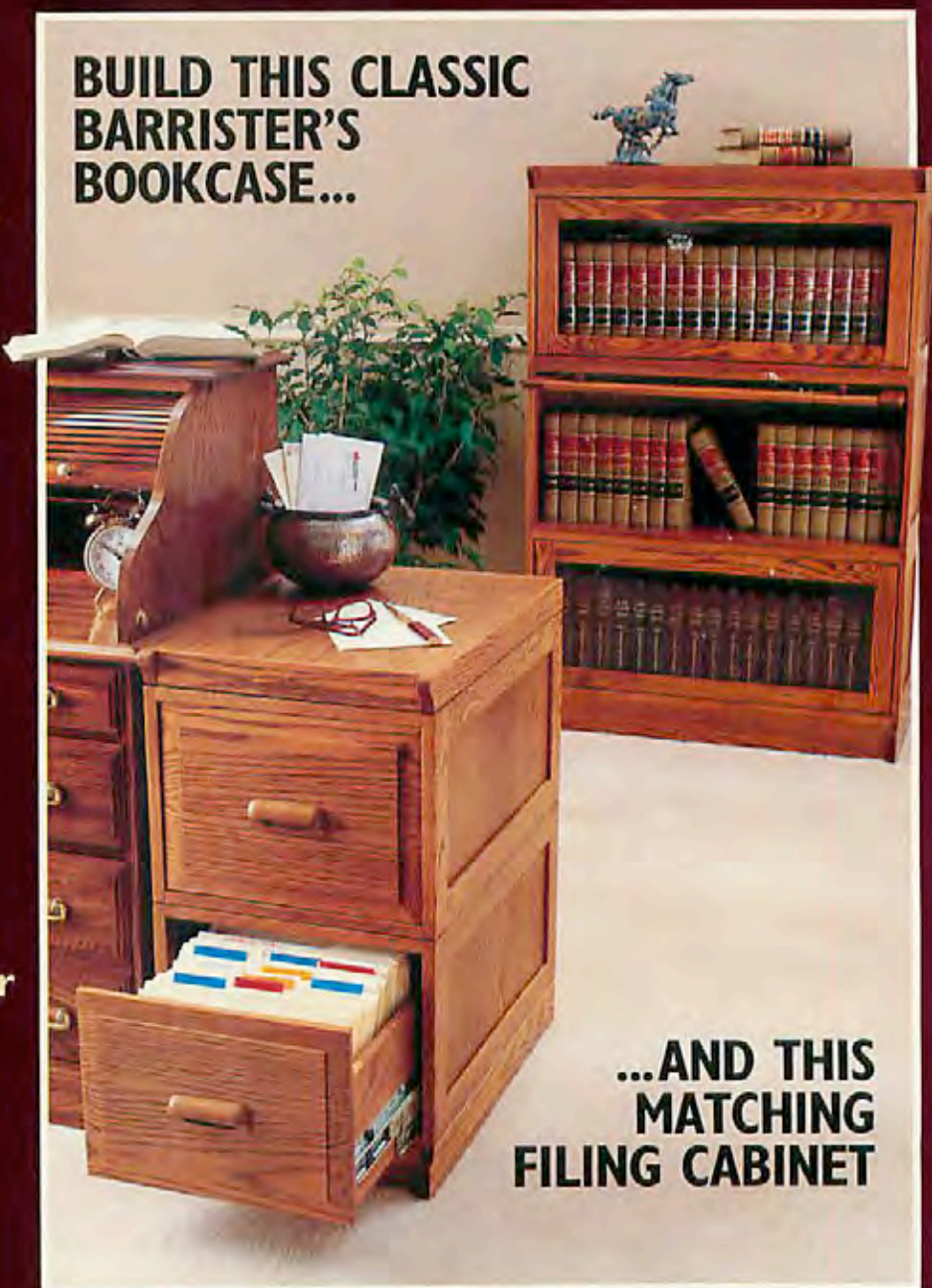

...AND THIS
MATCHING
FILING CABINET



Better Homes and Gardens®
WOOD
 THE MAGAZINE FOR HOME WOODWORKERS

February 1988 • Vol. 5, No. 1 • Issue No. 21

Editorial/Art Staff

Editor **LARRY CLAYTON**
 Managing Editor **CHARLES E. SOMMERS**
 Art Director **C. L. GATZKE**
 Design Editor **JAMES R. DOWNING**
 Features Editor **PETER J. STEPHANO**
 How-To Editor **MARLEN KEMMET**
 Buymanship/Techniques Editor **JIM BARRETT**
 Project Builder **JAMES E. BOELLING**
 Graphic Designer **PERRY A. McFARLIN**
 Administrative Assistant **DARLENE REYNOLDS**
 Business Office Clerk **JODI KOEPEL**

Technical Consultants: **GEORGE GRANSETH** Product
 Testing; **PAUL L. McCLURE** Wood Technology

Publisher **JERRY KAPLAN**
 National Advertising Manager **MARK S. HART**
 Advertising Representatives **JOHN BELLUARDO,**
ANTHONY IMPERATO

Marketing Services Manager **NANCY DALY**
 Promotion/Research Director **THOMAS R. TROLAND**
 Circulation Director **WILLIAM HUMMEL**
 Circulation Manager **BILL REED**
 Production Director **DALE SCHENKELBERG**
 Editorial Research Director **C. RAY DEATON**

Magazine Group Officers

Group President **JAMES A. AUTRY**
 Group Vice Presidents
 Publishing Directors **ADOLPH AUERBACHER,**
BURTON H. BOERSMA
 Editorial Director **DORIS M. EBY**
 Operations **CHRISTOPHER M. LEHMAN**

Corporate Officers

Chairman of the Board **E. T. MEREDITH III**
 President **ROBERT A. BURNETT**
 Executive Vice President—Corporate Services
JACK D. REHM
 Group Presidents: Magazine **JAMES A. AUTRY**; Broad-
 casting **W. C. McREYNOLDS**; Real Estate **ALLEN L.**
SABBAG; Book **FRED STINES**
 Vice Presidents: Corporate Relations **DONALD L.**
ARNOLD; General Counsel and Assistant Secretary
THOMAS G. FISHER; Product Development **NEIL**
KUEHNEL; Corporate Planning **HERB SCHULTE**;
 Finance **WILLIAM H. STRAW**; Administrative Ser-
 vices **GERALD D. THORNTON**
 Secretary **BETTY CAMPBELL MADDEN**
 Treasurer **MICHAEL A. SELL**
 Controller **LARRY D. HARTSOOK**

Better Homes and Gardens® WOOD - the magazine for home
 woodworkers (ISSN-0743-894X) is published bi-monthly in February,
 April, June, August, October, and December by Meredith Corporation,
 1716 Locust Street, Des Moines, IA 50316. Second-class postage paid
 at Des Moines, Iowa. Trademark registered in Canada and Australia.
 Marca Registrada en Mexico. **SUBSCRIPTION PRICES:** One year \$18
 in the United States and its possessions. Canada and other countries
 add \$6 per year. **POSTMASTER:** Send address changes to WOOD, 1716
 Locust Street, Des Moines, IA 50316. February 1988, Vol. 5, No. 1, Issue
 No. 21. **CUSTOMER SERVICE:** For service on your magazine subscrip-
 tions, including change of address, write to Customer Service Manager
 ROBERT AUSTIN, P.O. Box 10628, Des Moines, IA 50336. Please
 enclose your address label from a recent issue. If you wish to phone, call
 toll free 1-800-678-2666.
 © COPYRIGHT MEREDITH CORPORATION 1987. ALL RIGHTS
 RESERVED. PRINTED IN USA

Own this classic
"Roll Top" OAK DESK
 from our pre-cut partially assembled Kit.



Here's the turn-of-the-century "Roll-Top" you've always wanted. A full size oak desk (oak and oak-veneers) now yours at extraordinary savings... because you put it together yourself from pre-cut Kit parts. No special tools needed. When finished, you'll possess a magnificent showpiece for your home or office — worth at least twice what you paid for the Kit! Send for details without obligation.

FREE FULL COLOR CATALOG
 gives you all the facts

Please send my free Craftsman's Corner color catalog featuring the Classic Roll Top Desk and many other quality hardwood kits. I understand I am under no obligation.

Print Name _____
 Address _____ Apt. _____
 City _____ State _____ Zip _____

Craftsman's Corner Dept. 3GC • 4012 N.E. 14th Street • Box AP • Des Moines, IA 50302



The First REAL Universal Woodworking
 Machine Built:

THE SUPERWOODBUILDER®

19 EXCLUSIVE FEATURES:

- All Cast Iron Tables (as an industrial machine)
- Heavy Industrial Motor, develops 3HP
- A Dual Voltage 110/220 (as an industrial machine)
- A Spindle Lock
- Speed Override over 4200 RPM
- An E-Z Riser (a torsion spring loaded built-in helps to up-right the machine)
- Rear mounting area to bolt accessories
- Front mounting area to bolt accessories
- Heavy duty upper guard
- Wide open lower guard
- Saddle slide with 21-slot
- Heavy gauge steel legs with openings to use support shelf
- Industrial On-Off Switch
- Heavy Duty Caster*
- Saddle Longitudinal chain feed mechanism*
- Tool Tray*
- Router mount angle plate*
- Straight cylindrical turning tool holder*
- Table micrometer stop*

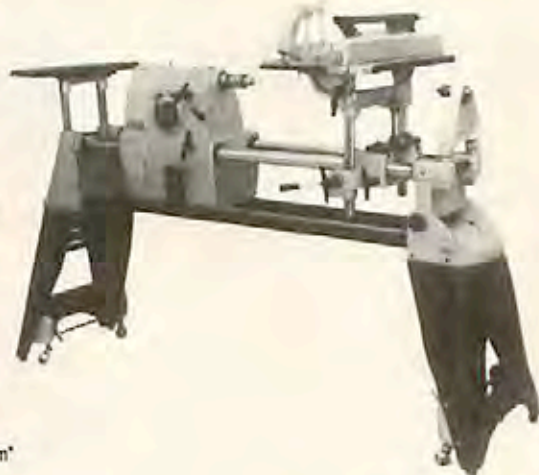

* 5 years WARRANTY ON MOTOR

YES! Please rush me the information packet today!

Name _____
 Address _____
 City _____ State _____ Zip _____
 Tel. No. _____

* OPTIONAL

CALL NOW 1 (800) 421-2467
 Calif. Res.: (213) 549-0761

MASTER WOODCRAFT & MACHINE CO.
 800 SPRUCE LAKE DR., P. O. BOX 669
 HARBOR CITY, CA 90710

**NOW!
REDUCE THE
RISK AT YOUR
TABLE SAW**



foldes down neatly

WITH THE **MOBILE SAWING CENTER**

OUTFEED ROLLERS

- safe, accurate sawing
- available in 15" and 37" widths
- handle panels with ease
- dual-position table

AND INCREASE FLOOR SPACE

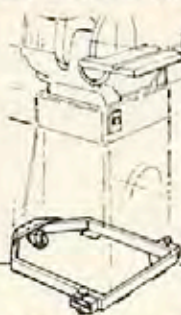

MOBILE MACHINE BASES

- increase shop working area
- maximize usable floor space
- 3 point base will not rock
- locking wheels
- makes machine so easy to use and store
- over 80 standard models

PLANER STAND WITH ROLLERS

- raises planer to proper working height
- provides machine mobility
- five-fold increase in workpiece support
- storage is a snap



NEW



ROLLERTABLE Rock Solid Support

- adjustable
- portable
- use at any machine

PEDESTAL ROLLER

Discover HTC's many unique products designed only with you, the dedicated woodworker in mind. Find out how you can make your machining safer, increase working area of your shop and accomplish nearly impossible tasks easily, quickly and accurately - **all by yourself!**

CALL TODAY!

HTC PRODUCTS, INC.
120 E. HUDSON S-8
ROYAL OAK, MI 48067
(313) 399-6185



1-800-624-2027 ext. 112

Better Homes and Gardens®

WOOD®

This issue's cover wood grain: Bird's-eye maple

FEBRUARY 1988

ISSUE NO. 21

WOOD PROFILE

RED ALDER: THE WEST COAST'S WEED TREE GOES TO MARKET 33

Once considered a nuisance, this prolific hardwood has earned the respect of many woodworkers as a low-cost, easy-to-work wood.



TOOL BUYMANSHIP

PLUNGE ROUTERS — GET DOWN TO WORK WITH ONE OF THESE NEW-BREED TOOLS 34

Even if you already own a router, there may be a place for one of these versatile tools in your shop. Our tool experts discuss the features to look for, and we've included a handy buyman-ship chart.



ONE MAN'S ONE-MAN SAWMILL 40

An Illinois woodworker lives out a dream many home craftsmen share — sawing his own lumber on his own backyard sawmill.



SHOP-TESTED TECHNIQUES

MAKE-'EM-YOURSELF MOLDINGS 44

You can transform plain stock into decorative moldings with a router and a handful of router bits. It's easy with our multipass technique.



NOW YOU CAN BUILD IT

PORTRAIT-PERFECT PICTURE FRAME 48

Want to make a family portrait, a special photograph, or a fine print even more impressive? You can—by fashioning a dramatic frame like this one. We show you how, step-by-step.



LAMINATED LETTER OPENER 54

This inexpensive project proves once again that a little imagination plus some wood from your scrap bin can equal impressive results.

WOODWORKERS' STANDARDS

BOOKCASES AND SHELVES 58

Designing new storage shelves can be tricky. We answer your questions about construction methods, materials, sizes, hardware, and more.



BAND-SAWN SCALLOP BOXES 62

We'll guarantee you one thing. If you build one of these great-looking treasure chests, you're going to get requests for lots more.



THE BARRISTER'S BOOKCASE 66

Few furniture designs have stood the test of time as well as the barrister's bookcase. Our rendition continues the fine tradition of providing attractive, yet practical book storage in a minimum amount of space.



STACKABLE FILE CABINET 72

The perfect companion for the barrister's bookcase on page 66, this modular unit, which can expand as your filing needs grow, makes quick work of organizing your important records and other paperwork.



CRAFTSMAN CLOSE-UP

A WISCONSIN FISH STORY 76

Rick Beyer's carvings make big splashes at major competitions. We show and tell why his underwater close-ups bring home the ribbons.



TURNING PATTERN

WALNUT SPICE JARS 80

Meet turning expert Phil Brennon, and learn how he creates these uniquely shaped vessels.



SHORT-SUBJECT FEATURES

Editor's Angle	7	Ask WOOD	26
Talking Back	10	Wood Anecdote	30
Tips From Your Shop		Old Hand Ways	82
(And Ours)	16	Shop Sense	91
Products That Perform	20	Wood Quiz	94
Bulletin Board	112		



ELIMINATE YOUR JOINING HASSLES

with the latest in plate jointers priced for your budget

Porter-Cable 555 features vertical handle with trigger switch, SUPER TORQUE PD Belt drive, rotating depth adjustment, front fence for easy vertical adjustment, miter fence for precise matching of miter joints, dust ejector and carbide tipped blade.

\$169.95

Virutex 0-81 Sliding fence adjusts for 45° and 90° joints, and registers from the top of the workpiece. A rotating adjuster quickly selects groove depth for three different plate sizes. Includes carbide-tipped blade and carrying case.

\$249.00

Kaiser MINI 3D This top-of-the-line joiner is imported exclusively by W.S. Jenks. The powerful AEG 600 watt motor with spindle key drives the HM groove blade. Non-slip rubber faceplate eliminates machine movement for perfect joints every time. Guide sets plates at 90° or 45°, and up to 12" from work edge. Comes in steel carrying case.

\$499.00

Compressed Beechwood Biscuits...\$19.95

Pack of 1000. Sizes 0, 10 or 20.

Laminate Rollers

333	Extension wall roller	\$19.95
346	"1" roller	\$6.95

Send \$2.00 for our complete woodworking catalog
(Refundable with first order)

W.S. JENKS & Son



1933 Montana Ave. NE Washington DC 20002
TOLL-FREE 1-800-638-6405

THE EDITOR'S ANGLE

**SOMETHING NEW
HAS BEEN ADDED...**



...AND ARE WE EXCITED!

Over the past three years, the staff and I have met and talked with literally thousands of you loyal readers. We've seen you at woodworking shows and crafts fairs. We have corresponded with lots of you by letter, telephone, and reader questionnaires. And several hundred of you have even come to Des Moines to take a tour of our shop. So by now, we feel we're getting to know you pretty well.

We know, for example, that you view woodworking as a fun, rewarding hobby, that you wish you had more time to spend in your shop, and that many of you like to build projects that you can complete in a weekend or in a few evenings. It's this last bit of information that triggered our decision to begin work on a brand-new publication we call **WEEKEND WOODWORKING PROJECTS**. No, it's not a substitute for **WOOD** magazine, but rather a companion periodical that's brimming with well-designed, practical, shop-tested projects. In fact, it's all projects.

In each issue of this bimonthly 24-page publication, we will feature 6 to 7 of the best-looking projects we can find—that's 36 to 42 projects a year. And to ensure the accuracy of our presentation, we will build every project step-by-step in our own shop.

If you're one of the many woodworkers we know who would like to have even more project ideas to choose from, this is the publication you've been waiting for. For information on how to order **WEEKEND WOODWORKING PROJECTS**, see the inside back cover. Why not give it a try—I think you'll be impressed.

Larry Clayton

ALS Tool Supply Inc

Alca Tool Supply, Inc. 28235 U.S. 33 West

ELKHART, IN 46516

INDIANA WATS 1-800-552-7604 USA WATS 1-800-437-2911

While Quantities Last

MAKITA

2711	10" Table Saw	698	454
3620	1 1/4" HP Router	166	100
4302C	Jig Saw	286	154
5007NB	7 1/4" Circ. Saw	194	116
5077B	7 1/4" Saw	250	150
6002DWK	3/8" Cordless Drill Kit	178	94
6010DWK	3/8" Cordless Drill-driver	174	100
6012HDW	3/8" Cordless Driver-drill	210	121
6013BR	1/2" Drill	208	137
6070DW	3/8" Cordless Driver	108	59
6092DW	3/8" Cordless Driver Kit	208	123
6093DW	3/8" Cordless Driver Kit	224	133
6800DBV	Drywall Screwdriver	156	78
6802BV	Screwdriver	192	94
B04510	4 3/8 x 4 Sander	92	54
B04550	4 3/8 x 4 Sander	92	48
DP3720	3/8" Drill	99	53
JR3000V	Recip. Saw	208	125
JV2000	Jigsaw	198	111
LS1000	10" Mitesaw	396	181
9207SPB	7" Sander Polisher	234	137



BOSCH

1604	1 3/4 HP Router	219	123
1608	Router Trimmer	129	84
1851	Saw	169	100
7551-100	Air Jigsaw	359	249
7561-101	Air Shear	625	365
7561-102	Air Nibber	500	323
7595-100	Air Foam Cutter	700	486
1600L	Laminator Trimmer	135	94.50
1609	Offset Basin Trimmer	180	132
1809V	Installers Kit	269	177
1801	Router 1 HP	159	91.50
1602	Router 1 1/2HP	195	136
1606	"D" Handie Router 1 3/4 HP	243	163
90300	Fixed Base Router 3 1/4 HP	500	350



BOSCH
Orbital Action Jig Saw,
Pneumatic Model 7551 100

BLACK & DECKER
Professional



BLACK & DECKER

1042	1/8 Holgun	163	98
1046	1/4 Holgun	163	98
2600	Holgun	125	79
1311	Holgun	183	110
1321	1/2 Rev. Drill	232	147
1703	10" Mini Box	313	159
2620	3/8 Rev. Drill	174	115
1941	3/8 Rev. Drill	135	89
2038	Drywall Sorgan	160	92
2048	Screwgun	209	101
6513	Impact Wrench	199	131
6520	3/8 Ratchet	89	62
6539	3/8" Air Imp	109	72
6558	1/2" Air Imp	89	53
6590	1/2" Impact	149	72
7224	1/2" Rev. Drill	90	53
7294	1/2" Drill	90	54
2750	4 1/4" Grader	115	67
5014	3/4" R. Hammer	209	170
6116	R. Angle Sander	195	114
6118	Air Sander	195	114
6152	5" Disc Sander	56	33
3027-09	7 1/4 Saw Cat	119	79
3102	Cutsaw	163	98
3153	Jigsaw	194	128
3157	Jigsaw	201	127
3159	Jigsaw	201	133
2720	1 1/2HP Router	219	121
3328	3 HP Router	500	350

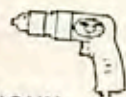

SIOUX

1450HP	1/4" Air Drill	145	96
1454HP	3/8" Air Drill	145	96
02303	Air Driver	317	231
2P2603AQ	1/2" Screwdriver	262	162
2P2603	1/2" Screwdriver	272	167
2P2607	1/2" Screwdriver	241	139

MASTER POWER

1442	1/4" Air Drill	215	127
1488	1/4" Air Drill	179	90
2296	1/2" sq. Dr. Impact	165	99
2461	Pos. Clutch Screwdriver	320	163
4415	Orbital Sander	190	114
5111	3/8" Drill	190	118
5130	1/2" Drill	200	128



Write For Free Catalog



I ♥ MY JOB



SPONSORED BY ABE THE EDITOR (March 1988)

CONTROL THE SPEED OF YOUR ROUTER

ROUTE AT THE SPEED THAT GIVES THE BEST RESULTS WITH THE WOOD AND BIT YOU ARE USING!

- LESS TEAR OUT
- STOPS BURNING
- FEED AT COMFORTABLE RATE
- BETTER, SAFER RESULTS WITH LARGE DIAMETER PANEL-RAISING BITS
- LESS WEAR ON BITS
- LESS NOISE AND SOFTER STARTS AT LOWER SPEEDS

INTRODUCTORY PRICE
\$39.95
REGULAR PRICE
VALUE OVER \$100.00

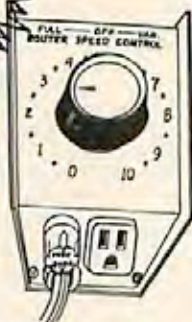

FEATURES:

- SPEED ADJUSTABLE FROM FULL SPEED TO 0 RPM
- FULL HORSEPOWER AND TORQUE AT ALL SPEEDS
- GO BACK AND FORTH FROM ANY PRE-SET SPEED TO FULL SPEED AT THE FLIP OF A SWITCH
- WORKS WITH ALL ROUTERS 3 HP OR LESS
- 120V 15 AMP
- GIVES YOUR ROUTER A FEATURE ONLY AVAILABLE ON ROUTERS THAT COST OVER \$500.00

EASY TO USE — SIMPLY PLUG IN SPEED CONTROL AND PLUG YOUR ROUTER INTO THE SPEED CONTROL — TURN DIAL FOR BEST RESULTS. (SPEED CONTROL HAS A CLIP THAT CAN BE WORN ON YOUR BELT OR HUNG ON WALL OR LEFT LOOSE.)

- REDUCES SPEED ELECTRONICALLY WITHOUT REDUCING TORQUE; ELECTRONIC FEED-BACK MAINTAINS SPEED BY INCREASING VOLTAGE TO MOTOR AS LOAD INCREASES.

To order by Master Charge or Visa Toll Free
7 Day — 24 Hour Order Service, Call

1-800-533-9298 (In PA 1-800-346-7511, Ext. 56)

or send check to MLCS, Ltd., P.O. Box 53DS, Rydal, PA 19046

MULTI-FORM MOLDING MAKER #159

MAKES BEAUTIFUL LARGE AND SMALL MOLDINGS

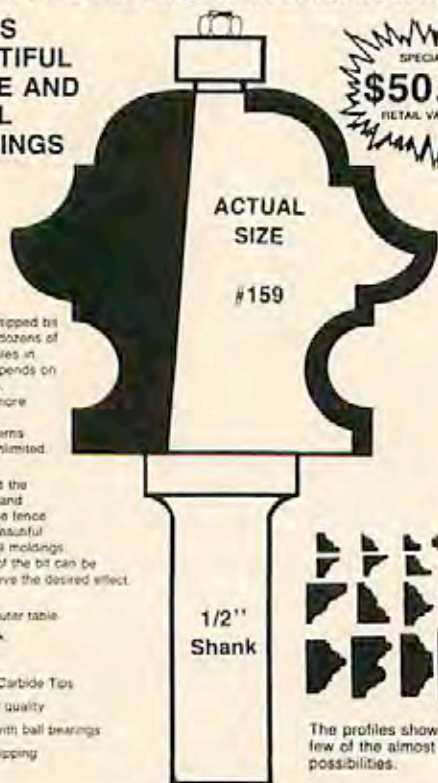

SPECIAL OFFER
\$50.
POSTAGE PAID
RETAIL VALUE \$100.00

ACTUAL SIZE

#159

1/2" Shank



The profiles shown are just a few of the almost unlimited possibilities.

This carbide tipped bit will produce dozens of different profiles in one pass (depends on size of stock). With two or more passes, the possible patterns are almost unlimited.

Simply adjust the depth of cut and position of the fence and create beautiful large or small moldings. Any portion of the bit can be used to achieve the desired effect.

For use in router table

- 1/2" Shank
- Two flutes
- Tungsten Carbide Tip
- Production quality
- Supplied with ball bearings
- We pay shipping

To order by Mastercard or Visa Toll Free
7 Day—24 Hour Order Service, Call

1-800-533-9298 (In PA 1-800-346-7511, Ext. 56)

or send check to MLCS, Ltd., P.O. Box 53DM, Rydal, PA 19046

TALKING BACK

We welcome comments, criticism, suggestions . . . even an occasional compliment. The volume of mail we receive makes it impossible to answer every letter, but we promise to do our level best. Send your correspondence to: Letters Editor, Better Homes and Gardens® WOOD® Magazine, Locust at 17th, Des Moines, IA 50336.

FINDING NEW DRAGSTER "SLICKS"

We searched high and low for rubber bands to fit the rear wheels of the dragster ("Rubber Band-Powered Dragster," April, 1987, pg. 84) and couldn't find the proper size. So, we decided to try bike inner tubes cut into cross sections 3/8" wide. We slipped them over the rear wheels and they worked perfectly, provided a very interesting look, and were so inexpensive we were able to add colored tape as a racing flag with the pennies saved.

—Joan & Ed Burger, Lenhartsville, Pa.

I found locating rubber bands for the dragsters quite easy. I asked a local restaurant to save the rubber bands from lobster claws. In one week I had more than enough for my projects.

—Mark Barthowisk, Warrenville, Ill.

TWO APPLES FOR THE PRICE OF ONE

I have built several of your apple banks from issue No. 15 (February 1987, pgs. 48-49). While painting them, my wife noticed that the inside cutout I removed also looked like an apple. So, she painted them red like an apple, with a green and brown stem. On some she's bored 3/8" holes in the sides to hold pencils.

We have sold several of these "small" apple cut-outs and intend to make more for our shows.

—Richard Hallyburton, Easley, S.C.

RIGHT WAY TO REPLACE BROKEN SCREWS

In your October 1987 issue "Tips" column on page 14, you showed how to remove a broken screw. Then you plugged the hole with a dowel and

appeared to use a new screw the same length as the dowel. It seems to me that for greater strength, the new screw should be longer than the dowel to give it bite into wood beyond the dowel.

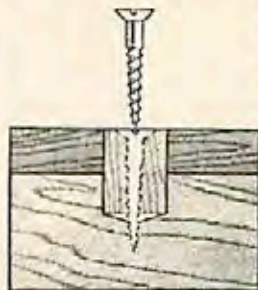

—Loren R. King,
Sterling Heights, Mich.

Right, Loren. When possible, use a replacement screw longer than the dowel insert so it extends into the workpiece beyond the glued dowel.

Continued on page 12

ABBEY TOOLS

WE OFFER DISCOUNTS UP TO 50% AND MORE
BE WISE - COMPARE

PORTER+CABLE
PROFESSIONAL POWER TOOLS

MOD #	DESCRIPTION	Sell
100	7/8 H.P. Router	92
126	Porta Plane	169
310	Laminate Trimmer	129
312	Crits' Plane, Trim	134
330	Speed Bloc Sander	52
314	4 1/2" Trim Saw	124
361	3x24 Belt Sander	174
363	4x24 Belt Sander	189
504	3x24 Belt Sander	335
505	H D Finish Sander	109
518	3 HP S Spd Router	335
536	1 1/2 HP H D Router	195
666	3/8" H D VSR Drill	117
690	1 1/2 H P Router	129
7514	1 1/2" VSR Drill	119
7533	Adj. Clutch Driver	149
7548	Vs Jig Saw	139
9100	Classic (100) Router	119
9118	Porta Plane Kit	189
9552	Versa Plane Kit	295
59381	Hinge Temp Kit	149
59829	Hinge Temp Acc. Kit	89
304	7" Prof. Disc Sander	129
305	7" Prof. Polisher	129
315-1	7 1/4" Cut Saw	124
43263	Carbide Cutter for 126 or 9118 Planes	49

NEW! FROM PORTER+CABLE

555	Biscuit Joinder	189
-----	-----------------	-----

Model 555 \$189

1000 Biscuits - 0, 10, 20 - 27.50
1000 Mixed - 27.50

SAW BOSS \$99

Bostitch Nail Guns

N16CT	Framing Nailer 6d-16d	417
N80C	Framing Nail fd-16d	395
T36-50	1 1/2" Crown Stapler	282
T35-6	1" Crown Stapling Spst	222
T35-40	16 Ga Brads 1 1/4" 3/4"	282
T31-1	5/8" 1 1/4" Brads	128

TR12 3HP Router \$169

Hitachi Power Tools

D10V	3/8" VSR Drill	69
D13	1/2" Spade Hndrl Drill	99
DR10	3/8" Cordl Scrudrill	89
TR6	Laminate Trimmer	83
TR12	3HP Router	169
CTS-A	7 1/4" Circular Saw	79
WV-A	0-2500 Screwdriver	79
CR10V	Var Spd Recipro Saw	109
CS-A	6 1/4" Cordl Circ Saw	124
DH30YA	1 1/2" Roto Hammer	299
CT10FA	10" Miter Saw	269

Milwaukee Tools

HEAVY DUTY SAWZALL 2500

Model 1581VS \$119

6511 2 Spd

freud Carbide

Blades and Cutters

LM72M10	10x24T RIP	33
LU73M10	10x60T ATB	29
LU82M10	10x60T Tr Chip	38
LU84M11	10x50T Combo	38
LU84M12	12x60T Combo	69

DB308 8" Dado Set 109
FB100 16 Pc Fastener Bit Set 138
DB050 50 Piece Drill Bit Set 59
90-100 15Pc Router Bit Set 139

\$145

94-100 5Pc Router Bit Set 145
99-210 thru Rashed panel 138
99-213 Router bit - each 58
SC001 Blade Stabilizer 5/8" bore 17
TT108 8Pc Lathe Turning Set 55
EC210 10 to 213 Rashed Panel 89
EC280 3/4 Strip-Rail Sptr Bit 65

\$265

EC900 Shaper Door System Set

NEW! From Freud

Biscuit Joining Machine comes with carbide blade, assortment of biscuits, instructions & case

J.S.-100 Our Price \$178.50
0-10-20 BISCUITS 1000 29.50

RYOBI POWER TOOLS

Model 1634 \$169

MOD #	DESCRIPTION	PRICE
AP10	10" Surface Planer	345
E3800	0-4000 Drywall Dr	79
E3810	0-2500 Drywall Dr	79
JSE60	Jig Saw Var Spd	119
PL100VK	VSR Recipro Saw	109
S5024	Bloc Sander	37
SP180GA	7" Sander Polisher	109
TR30U	Laminate Trimmer	79
TS251U	10" Miter Saw	169
TS380	14" Miter Saw	329
W2000S	16 1/4" Beam Saw	319
HA200	8" Portable Rad Arm Saw	247
BD101R	3/8" Cordl Drill	47
RS01	Plunge Router	169
BT100	3x24 Belt Sander	129
AP10	Planer Blades:	25

Skill Tools

77	7 1/4" Worm Dr Saw	134
471-2	1 1/2" Impact Wrench W/Case	159
492	Vs Jig Saw	49
542	Spade Hndrl Drill	109
551	5 1/2" Circular Saw	79
597	3/8" VSR Drill	59
598	1 1/2" VSR Drill	69
756	Palm Sander	39
2016-2	3/8" cordl var Drill	95

Model AP10 \$345

ABBEY TOOLS

A DIVISION OF ABBEY MACHINERY

516 NORTH BROOKHURST STREET • ANAHEIM, CALIFORNIA 92801

ORDER BY PHONE - WE ACCEPT VISA, MASTER CARD, CHECK, MONEY ORDER.

Toll Free 1-800-225-6321 Calif. 1-800-252-2221

Orange County (714) 772-7222

PRICES SUBJECT TO CHANGE WITHOUT NOTICE

Calif. Residents Add 6% Sales Tax

Makita Power Tools

Model #M1210DW \$109

1100	3 1/4" Planer wcase	179
1900BW	3 1/4" Planer Kit	119
2708	6 1/4" Table Saw	219
3601B	1 3/8" HP Router	129
3612BR	3HP Plunge Router	169
4200N	4 3/4" Trim Saw	109
5077B	HP D Handl Dr Saw	149
5081DW	3 3/8" Cordless Saw	119
5402A	16 3/16" Beam Saw	329
5600DW	Cordl. Circ Saw 6 1/4"	169
9924B	5x24" Belt Sander	129
6012HDW	3/8" Cordl Scrudrill	109
6301LR	1 1/2" D Handle Drill	129
6510Lvr	3/8" VSR Drill	76
6801DBV	0-4000 Drywall Scraper	89
6905B	1 1/2" Impact Wrench	159
6906	3/4" Impact Wrench	319
6419B2W	3 1/4" Hammer	159
9030	1" Belt Sander	139
9207SPB	7" Polisher 2 Spd	145
9100BK	4" Min Grinder	69
9820-2	Blade Sharpener	169
9924B	5x24" Belt Sander	129
904550	Bloc Sander w/Bag	49
DP4700	1 1/2" VSR Drill	107
HP1020	3/8" Hammer Drill	69
HP1030W	3/8" Hmr Drill/case	99
JR3000V	Var Spd Recipro Saw	119
	Carbide Planer Blade for MAKITA 1100 & 1900	29

Makita Battery Pack Special

3.6 VOLT	29.50
7.2 VOLT	27.50

Engle Compressors

3/4 H.P. 115 Volt 125 PSI	
AM38-HC2	1.5 Gal. Single Tank 259
AM39-HC4	3.8 Gal. Twin Tank 279
AM39-HCV	3.8 Gal. Twin Tank 279

1.5 H.P. 115 Volt 125 PSI
AM77-HC2 1.5 Gal. Single Tank 275
AM77-HC4 3.8 Gal. Twin Tank 299
AM77-HCV 3.8 Gal. Twin Tank 299
Hand Carry - 41 to 54 Pounds
All Models come with Pr. switch, on/off sw. pressure gauge, tank drain and regulator/shutoff valve.

BLACK & DECKER

Model 3051 \$119

3310	1 1/2 HP Router	119
1179	3/8" Drill 0-1200	79
1960	3/8" Cordl Drill w/Clutch	89
3051	7 1/4" Worm Dr Saw	119
3103	2 Spd Cut Saw	89
4010-10	Palm Sander	39
1703	10" Miter Saw	159
6513-09	1 1/2" Dr. Impact Wrench	119
98003	Cordl Drill Battery Pack	38

Delta Carbide

Blades and Cutters

35-512	10 x 40 ATB	34
35-517	10 x 50 Comb	36
35-523	10 x 80T ATB	59
35-677	14 x 108T ATB	99
35-647	12 x 72T ATB	69
35-626	10 x 60T ATB	49

Prepaid Freight to 48 States
Any Item This Page

Model 1581VS \$124

Bosch Power Tools

1581VS	Orbital Action Jig Saw	124
11202B	1 1/2" Roto Hammer	349
11203B	1 1/2" Roto Hammer	349
1601	1 HP Router	89
1604	1 3/4 HP Router	119
3230	Jig Saw	49
11305	30lb Demo Hammer	645
1608T	Bit Base Lam. Trimr	89
1609	Offset Laminate Trimr	115
1609K	Lam Trimr Inst. Kit	165
1651	7 1/4" Circ. Saw	89

ABBEY TOOLS

A DIVISION OF ABBEY MACHINERY

516 NORTH BROOKHURST STREET • ANAHEIM, CALIFORNIA 92801

ORDER BY PHONE - WE ACCEPT VISA, MASTER CARD, CHECK, MONEY ORDER.

Toll Free 1-800-225-6321 Calif. 1-800-252-2221

Orange County (714) 772-7222

PRICES SUBJECT TO CHANGE WITHOUT NOTICE

Calif. Residents Add 6% Sales Tax

TALKING BACK

Continued from page 10

KIT BUILDERS NOT WOODWORKERS?

In your October issue you ask, "Do Real Woodworkers Build from Kits?" After reading the article, it seems that you do think kit builders are real woodworkers.

I have made several hundred clocks this year. I sell many for less than kits cost, and make a good living at it. What is a kit builder? He is someone who puts a kit together, then puts it in a corner and tells everyone he made it.

—Paul R. Chapman, Amherst, N.Y.

RETROFIT PROGRAM FOR ROCKWELL RADIAL ARM SAWS

Delta International Machinery Corporation, formerly the Rockwell International Power Tool Division, has initiated a safety retrofit program. They will supply a free installable track arm retrofit kit for units of Rockwell 12" radial arm saws manufactured from December 1976 through December 1982. The models covered are: 33-790, 33-791, 33-792, 33-793 with serial numbers IM-7800 through LJ-1273. It also includes successor models: 33-890, 33-891, 33-892, and 33-893 12" units bearing serial numbers LJ-1274 to MC-6923 and 82K04650 to 83C04616. No other models are involved in the program.

If you own a 12" Rockwell radial arm saw that falls within the above identified series, you can get a free track arm retrofit kit #424-02-628-0011 by writing to: Rockwell Radial Saw Retrofit Program, Delta International Machinery Corp., 4290 Raines Rd., Memphis, TN 38118. Indicate the model number and serial number of your saw.

—Carolyn R. Gray,
for Delta International Machinery Corp.

A FASTER WAY TO SQUARE A MITER GAUGE

Your October, 1987 issue, under "Tips," suggested using a framing square as the "fastest way" to square up a table saw miter gauge. Actually, I've found it's even quicker to turn the gauge upside down in the guide slot, and, with the setscrew loose, press the head against the front (or rear) of the table, and then tighten the screw.

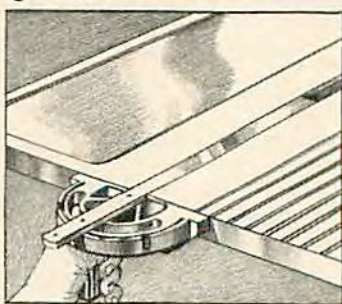

—Jack Pirkey, Ringwood, N.J.

Several readers wrote to tell us that they used this technique for squaring up a table saw's miter gauge. The method is fast, and providing that the table edge has been ground square to the guide slot, should be accurate.

Continued on page 14

NEW
from
Penn State
Industries... a
supplier of quality products
for over 40 years

Professional quality, precision . . . Super 15" Scroll Saw

Comparable value over \$500
Only ~~\$139.95~~ shipped complete
ready to run

Winter Special
\$129.95

This versatile machine makes cutting intricate wood patterns easy — great for making toys, jewelry, puzzles, fretwork, etc. The blade is driven on both up and down stroke with a smooth cutting parallel rocker arm system. This system avoids blade breakage and creates a smooth finish that virtually eliminates sanding. Our saw is easy to use and is made with a cast construction that insures durability. We fully support our product with replacement parts and repairs if needed. Thousands of satisfied customers use our saw world-wide.

SPECIFICATIONS:

- Cast iron construction
- Throat depth — 15"
- Max. depth of cut — 2"
- Cuts per minute — 1725
- Weight — 43 lbs
- Motor — Heavy duty totally enclosed fan cooled 110V - 120V
UL listed, ball bearing — induction motor

NEW!

- **Dust Blower**
(Optional - Add \$15.00)
- Use standard 5" blades
- Stroke length — 3/4"
- Table Tilt — 0 - 45°
- Table Size — 8" x 17"



Dear Penn State:

"My SUPER Scroll Saw was delivered two days ago and it performs like the neighbor's \$700 one. I'm delighted."

Mrs. S.A. Swartz
White Cloud, KS

"I recently received one of your 15" Scroll Saws as a gift and was impressed with its construction and other features. I'd say it can be compared favorably with such saws as Excelsior and the Hegner line."

Mr. E. L. Brendza
San Bernardino, CA

"I am thrilled with the performance as is my wife who has operated it more than I have. As a special automatic machine designer for the last 40 years, I feel that I am qualified to compliment you on a well-designed machine."

C.M. Smeigh
Fl. Worth, TX

The Editor The Woodworker's Journal

"Kudos for the folks at Penn State Industries for value and customer service! When I contacted them concerning a minor problem, replacements were rushed out to me the same day."

As an amateur woodworker, I was pleased to find that lower priced, well made equipment is available from people who are willing to stand behind their products.

A. Mortenson
New Milford, CT

30 Day Money Back
Guarantee—1 year
warranty parts/labor
FREE: 12 Blades &
Blade Holder Set
with purchase

PENN STATE INDUSTRIES-W
2850 Comly Road • Philadelphia, PA 19154
1-215-676-7609 (Ext. 15)

* Add \$15.00 for Blower Option • Visa, MasterCard, Check or Money Order Accepted
Add \$10.00 for shipping in Continental U.S. • Pennsylvania residents add 6% sales tax

TALKING BACK

Continued from page 12

NOT A MOISTURE BARRIER

You do readers a disservice when you perpetuate the myth that you can stabilize wood or seal it from moisture by slapping on a finish ("Ask WOOD," October 1987, pg. 89). Some finishes are more effective at blocking water vapor absorption than others, but no matter what the finish, some moisture always gets through to the wood.

The U.S.D.A. Forest Products Laboratory tested 91 wood finishes. Their results indicate that the moisture excluding effectiveness of a finish depends primarily on the film thickness and the solids content of the finish. Two-part epoxy paint was found to be the most effective moisture barrier, followed by solvent-based enamel paint, then solvent-based varnishes. Lacquer and shellac are much less effective moisture barriers, as are "latex" varnishes. Near the bottom of the list are several penetrating oil finishes, which were found to be ineffective as moisture barriers.

—David Sloan, Emmaus, Pa.

You can obtain a copy of the FPL report to which reader Sloan refers by writing to: Forest Products Laboratory, U.S.D.A. Forest Service, P.O. Box 5130, Madison, WI 53705.

CAUTION: MIXING HAZARD

On page 20 of the October 1987 issue (Shop Tips) the item on "How to Beat the Mixing Game" caught my eye. It is a good tip except for the suggestion that an electric drill be used, and that the beaters be cleaned in thinner. One spark from the drill or beaters could ignite volatile fumes from certain products and thinners and cause severe injury to the user. Please suggest that readers use only air-powered tools or hand mix when they're working with flammable products.

—Tom Stroud, Lynn Haven, Fla.

Right you are, Tom. Safety concerns dictate that we do not use electric or spark-producing tools to mix materials containing volatile ingredients.

CLOCK KIT MAKER MISSED

In our article, "Do Real Woodworkers Build from Kits?" WOOD Magazine, October 1987, pg. 50, we listed suppliers of clock and furniture kits. Unfortunately, one firm was inadvertently left off the list. Please add: Klockit, P.O. Box 629, Lake Geneva, WI 53147. The firm offers a free catalog and can be contacted by calling 1-800-KLOCKIT. 🍀

MINI FRAME CLAMPS

You're gluing up a picture frame and don't have a frame clamp small enough to hold it.

TIP: Make a miniature frame clamp like the one shown in the drawing below. You'll need four small inside corner braces, four rubber bands, and eight 1/4" flathead machine screws with nuts and washers. Attach the screws to the braces as shown, to hold the rubber bands. Simply position the braces at the frame corners and stretch the rubber bands between them to hold the frame pieces in place.

—Joe Baltz, Joliet, Ill.

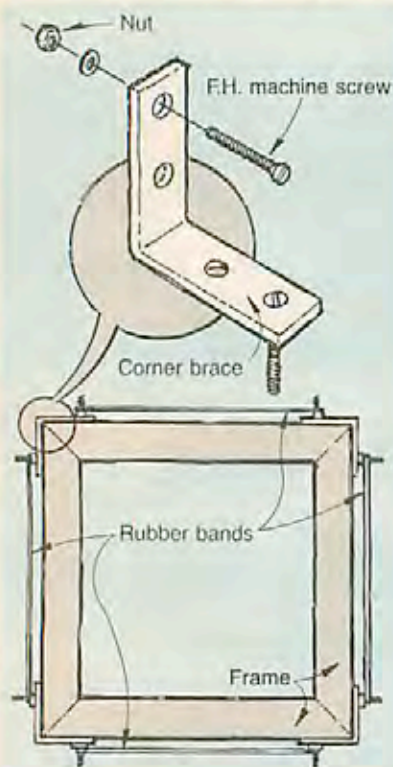

Do you have any good tips you'd like to share with our readers? We'll pay you \$25 for each submission we publish. No shop tips can be returned. Mail your tips to:

Shop Tips
 Better Homes and Gardens
 WOOD® Magazine
 Locust at 17th
 Des Moines, IA 50336

PUTTING THE SQUEEZE ON BROKEN LEGS

The conventional way of fixing breaks in cylindrical furniture legs often seems like more trouble than it's worth: building a jig to hold the leg, then gluing and clamping it with a C-clamp.

TIP: You can do the job just as well—and much faster—with stainless-steel hose clamps. You'll find a wide variety of sizes at most auto-supply stores. To avoid marring the piece when tightening the clamps, insert a strip of cardboard between the clamp and the work.

—Hal Doolittle, Kirkwood, Mo.

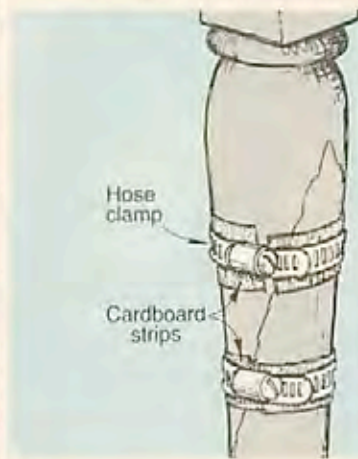

TAPERED TO FIT

It's sometimes hard to get wood plugs or dowels to fit snugly into the holes you've drilled for them, especially if you're working with softwoods.

TIP: Buy a set of inexpensive spade bits, and grind a slight taper on their cutting edges, as shown below. When you use your tapered bits, plugs will fit into their holes like a cork into a bottle. But don't overdo it! Just a few strokes of the file or a light pass or two over the grinder will suffice. Make sure both sides of the bit have identical tapers.

—Don Stutzman, Johnstown, Pa.

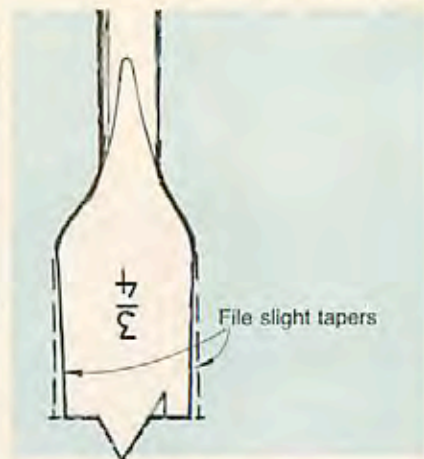

A REAL "STITCH SAVER"

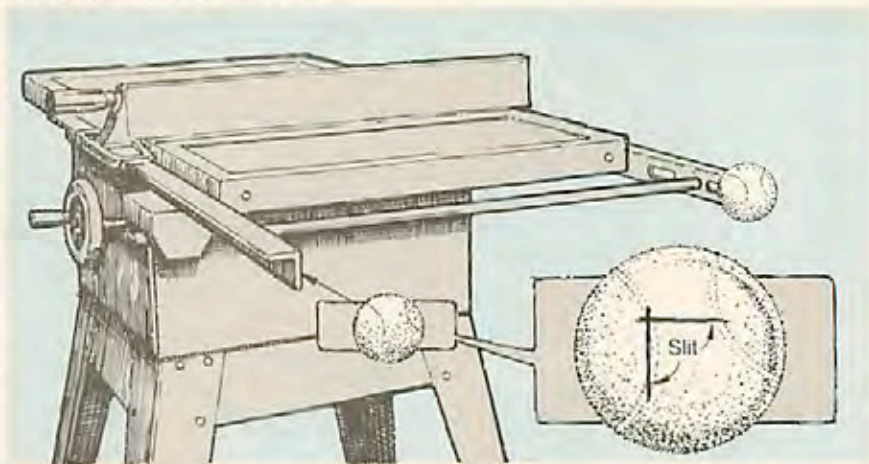

Some table saws have L-shaped metal fence guides protruding at just the right height to inflict painful cuts and bumps on the beads of wee visitors to the shop; also

to the lower portions of a grown-up's anatomy.

TIP: Cut L-shaped slots in two tennis balls, then slip them over the protruding angles.

—Jerry Swenson, Newport News, Va.

Continued on page 18

Continued from page 16

PIN THE SAVAGE BAND

A hand-saw blade can turn vicious and inflict nasty bites, should it jump off the wheels during installation. It's not always easy to keep the blade on one wheel while wrapping it around the other(s).

TIP: Gain a hand to help tame the blade by clipping the blade to one wheel on the saw with two or three clothespins borrowed from the laundry room. This leaves your hands free to slip the blade over the remaining wheel(s).

—David Webber, Chantilly, Va.

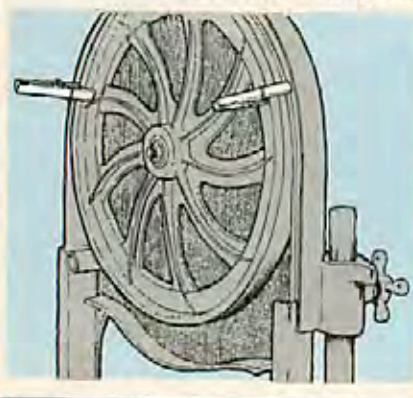

THIS TRICK LICKS GOOEY STICKERS

Who likes to pick away at a hard-to-remove gummed label on a new tool handle or other item, then clean off the gummy residue?

TIP: Before peeling, hit the label with a few squirts of WD-40 lubricant. It quickly dissolves the gum adhesive, so you can easily peel off the label. A quick wipe with a rag will remove any remaining goo. **Caution:** Don't try this on unfinished wood. It may leave a residue.

—Joseph White, Altus, Okla.

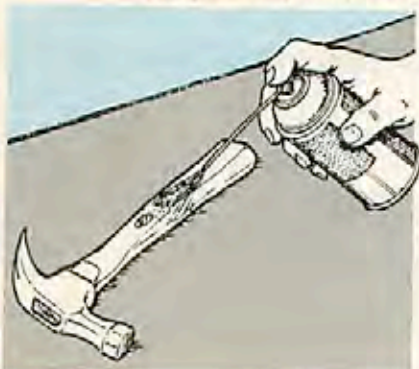

INSTALLING BRADS IN A PINCH

It's not easy to hammer brads into a picture frame to hold the backing in place. Of course, you could buy a framemaker's brad-setting tool. But they're expensive for such an infrequent task.

TIP: Common slip-joint "water pump" pliers make a good substitute for a brad-setting tool. To prevent marring, wrap five or six layers of masking tape around the jaw that will contact the frame. Then squeeze the brad into the frame, as shown below.

—Van Caldwell, Cincinnati, Ohio

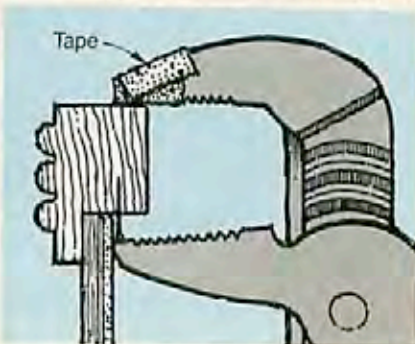

KLUTZ-FREE NAILING

No matter how carefully you work, you often end up banging your fingers or the material when driving brads or short finish nails.

Tip: Start the nail in the thin end of a narrow shim (cedar shingles work well for this). Use the shim to hold the nail in place until you've driven it nearly all the way into the work. Then, pull the shim off the nail and use a nail set to finish the job. No shims available? Use a short length of corrugated cardboard.

—Carl R. Faix, Cherry Hill, N.J.

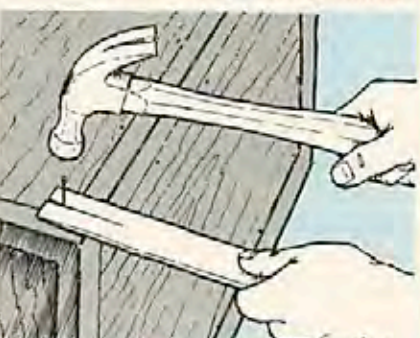

14" Bandsaw

- Blade size up to 3/4" wide
- Cast iron construction
- 156 lbs.
- 3/4-hp

\$239.00

(ships freight collect)

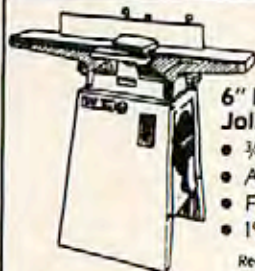

6" Heavy Duty Jointer

- 3/4 hp, 110v
- Adj. speeds
- Fully adjustable
- 190 lbs.

Reg. \$499.00 **\$299.00**

(ships freight collect)

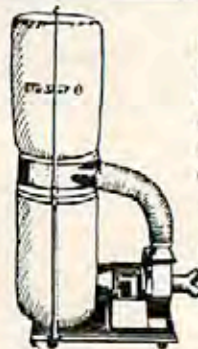

Industrial Dust Collector

- 2 hp, 110v
- Two 4" inlets
- 1185 CFM
- 125 lbs.

\$499.00 **\$339.00**

Value (ships freight collect)

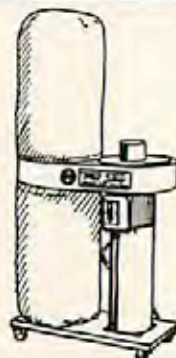

Dust Collector

- 1 hp, 110v
- 4" inlet
- Commercial quality
- Compact size

Reg. \$348.00 **\$199.00**

(Shp. & Hdg. \$30.00)



15" Scroll Saw

- Fully adj. table
- 2" cut depth, 3/8" stroke
- 110v
- Free work/storage table. A \$49.00 value
- 25 assorted blades included

\$199.00

(Shp. & Hdg. \$20.00)

This isn't what you think !

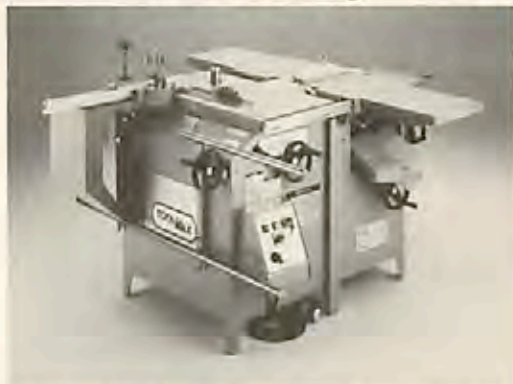

You're probably looking at this machine thinking to yourself, "Oh, it's one of those all in one tools that takes forever to set-up and really isn't practical." Think again. This is the Toolmax T310. The T310 is a quality woodworking tool that requires almost no set-up and meets almost any commercial quality specification for individual equipment. The T310 has 4 Separate motors which power the 10" Table Saw, 1" Spindle Shaper, 12" Jointer, 12" Planer, and Mortise.

If you want to save over 90% of the space in your shop and up to 60% of the cost of buying individual equipment, call Toolmax for more information or send \$19.95 (VISA, MC, AMEX customers call toll free 1-800-535-4788 to order by phone) for an informative video demonstration tape.



TOOLMAX
2439 FRONT ST.
WEST SACRAMENTO CA 95691
1-800-535-4788 USA 1-800-325-8330 CA

PRODUCTS THAT PERFORM

TWO-FACED MITER GAUGE FOR PERFECT RIGHT ANGLES

The standard miter gauges on most table saws can be a framemaker's nightmare. When using one of these to make mitered corners for rectangular frames, you need only be off the 45° setting by a hair's breadth, and the frame pieces won't meet at 90°. Not so with this European-designed miter gauge. By using both faces of the miter gauge, you get a perfect 90° corner, even if your setting is slightly off the 45° mark. Instead of re-setting the gauge, you simply move the fence from one face to the other, then switch the gauge to the opposite side of the blade.

The gauge also comes with an adjustable flip-up depth stop for repetitive cuts, and a jig attachment for making box joints.



A standard accessory for Kity woodworking machines, the miter gauge now comes with guide bars to fit other popular table saw models: specify a 3/8x3/4" guide bar for Delta, Sears, and Taiwanese-made saws. For Shophsmith, Total Shop, and Master Woodcraft, order one with a 1/16x1 1/16" bar.

Kity Miter Gauge, \$84.95 ppd.; box-joint attachment, \$59.95 ppd. from Farris Machinery, 2315 Keystone Drive, Blue Springs, MO 64015.

GREAT SHAKES

If you're into Shaker decor—or even if you aren't—you'll find these giant Shaker pegs especially suitable for hanging large, heavy items or bulky clothing.



Turned from clear maple, these unfinished pegs measure 5 1/4" long with a 3/8"-long, 3/4"-diameter tenon and a 1 1/16"-diameter head. They're the largest commercially available Shaker pegs we've seen so far. Use them along with pegs of other sizes to make attractive wall racks.

Giant Shaker Pegs, bag of 10 (cat. no. 50D10) \$4.95 ppd.; 50 (cat. no. 50D20) \$18.50 ppd.; from Woodcraft Supply Corp., 41 Atlantic Ave. P.O. Box 4000, Woburn, MA 01888.

Continued on page 22

POWERMATIC



Call For Our Low Prices! We carry the entire Powermatic line at very attractive prices. Please call for our prices on the Model 66 and other Powermatic machines. You'll be glad you did!

Model 66 Table Saw with 50" Biesemeyer Rip Fence, 3HP, 1PH or 5HP, 3PH motor. FOB Our Warehouse.

Mini-Max

World's Best Jointer-Planer

FS35 Jointer-Planer \$2195

Length 63" Width 13 1/2" Weight 719 lbs.

3HP, 1PH or 3HP, 3PH Motor

Please call or write for more information on the FS35 jointer-planer. We stock the entire Mini-Max line. Please call for our prices. FOB our Warehouse. Call for discounted freight rates.



MAKITA

804510	4" finishing sander	\$49
1100	3 1/2" planer kit	\$179
1805	6 1/2" planer kit	\$277
2708	8 1/2" table saw	\$229
3612BR	plunge router	\$189
610ES	for 3612BR	\$ 28
3641B	1/2" router	\$118
370B	1/2" trimmer	\$ 95
4301B	orbital jig s/w	\$139
5007B	7 1/2" circular saw	\$109
6000	1/2" clutch drill	\$119
6012HDW	1/2" cordless clutch drill	\$109
900B	3x24 belt sander	\$129
9824B	3x24 belt sander	\$139
8451	4x24 belt sander	\$159
9802	blade sharpener	\$89

RYOBI SPECIALS

S500A	3 x 4 1/2 Pad Sander	\$ 39
SUR200	1/2 Sheet Pad Sander	\$ 99
B7075	3 x 21 Dustless Belt Sander	\$105
B7100	3 x 24 Dustless Belt Sander	\$121
B7200A	4 x 24 Dustless Belt Sander	\$148
R151	1HP Plunge Router	\$ 95
R501	2 1/2HP Plunge Router	\$159
TR30U	Trimmer	\$ 77
TS300	14" Miter Saw	\$369



AP-10 Thickness Planer

30" width of cut
13 Amp 110v
Motor
Powered
CALL FOR
OUR PRICES!

FREUD SPECIALS

TT-108	8 Pc. Turning Tool Set	\$47
90-100	15 Pc. Router Bit Set	\$138
92-100	26 Pc. Router Bit Set	\$284
94-100	5 Pc. Router Cabinet	\$159
FB-100	16 Pc. Forstner Bit Set	\$159
FC-800	5 Pc. Shaper Cabinet Set	\$264
EC-209-213	Raised Panel Cutters	\$85
EC-260	1/2" Cabinet Door Set	\$157

Sawblades

LM72M	10", 241 Rip Blade	\$38
LU73M	10", 601 ATB Cutoff	\$38
LUS4M	10", 50T, Combination	\$38
	Set of Three Above	\$107
LUS2M	10", 60T, Triple Chip	\$42
LUS5M	10", 80T, Super Blade	\$59
DS306	8" Dado	\$99
DS308	8" Dado	\$109
JS100	Plate Joiner	\$169
JS300	1000 Biscuits	\$29
FT100	File Cutter	\$ 34

MAKITA STATIONARIES

2030N	12" Planer - 6" Jointer	\$1275
2040	15" Planer	\$1275
2020	8" Jointer	\$775

HITACHI

F-1000A	Jointer-Planer	\$1395
CB75F	Resaw Bandsaw	\$1645
C15FBP	15" Miter Saw	\$409
C101FD	10" Miter Saw	\$279
TR12	Plunge Router	\$173

PORTER CABLE

518	3HP Speedtronic Router	\$323
630	1HP Router	\$ 93
690	1 1/2HP Router	\$124
310	Laminate Trimmer	\$124
312	Ortset Laminate Trimmer	\$133
319	Tin-Base Laminate Trimmer	\$138
330	Speed-Block Sander	\$ 54
352	3 x 21 Dustless Belt Sander	\$130
360	3 x 24 Dustless Belt Sander	\$165
362	4 x 24 Dustless Belt Sander	\$198
505	Plate Joiner	\$169

JET POWER TOOLS

JRS-14MW	Metal/wood Bandsaw	\$349
JJ-6	6" Jointer	\$339
JTS-10	10" Contractors Saw	\$439
GTAS-10	10" T/A Table Saw	\$1275
	with 50" Biesemeyer Fence	
JJ-8	8" Long-Bed Jointer	\$699
JWP-15H	15" Thickness Planer	\$999
DC-610	1 HP Dust Collector	\$309
DC-1192	2 HP Dust Collector	\$449

JET Prices include delivery.

LEIGH

1051L	24" dovetail jig with 1/2" bits for 1/2" dovetails	\$239
01256-12	New 12" jig for through and half blind dovetails	\$245
01256-24	New 24" jig for through and half blind dovetails	\$269

Optional Bits in Stock

Orders over \$35 ** include delivery unless otherwise noted. Prices subject to change without notice.

PRODUCTS THAT PERFORM

Continued from page 20

DOING BATTLE AGAINST SAWDUST

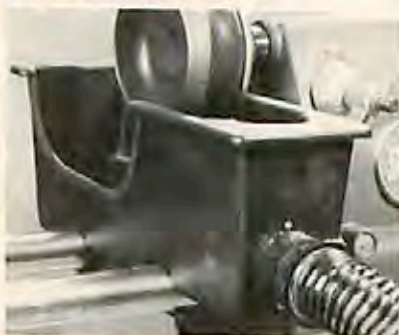

If you own one of the combination machines from Shopsmith, Total Shop, or Master Woodcraft, here's a reinforcement in the war against sawdust. The Dust Star quickly clamps to the way tubes of these machines. A cutout in the profile enables you to get your hands inside the hood to sand bowls and other faceplate turnings. The unit accepts a standard 2 1/2" vacuum hose.

Dust Star, \$21.50 ppd. from E & L Plus Inc., 623 Osage, Neodesha, KS 66757 (Kansas residents add 5% sales tax).

A SLICK PROTECTANT FOR SAW TABLES



Metal saw tables rust. They also gum up with pitch and resins. Besides looking bad, a rusty, gummy saw table creates friction, which hogs down the wood as you saw.

Here's a product especially designed to protect tables on saws and other woodworking machines. Kity Speed contains graphite and a long-lasting, nonstaining surface protectant that repels rust-causing moisture.

Kity Speed, 18-ounce can \$14.95 ppd. from Farris Machinery, 2315 Keystone Drive, Blue Springs, MO 64015.

Continued on page 24

The workbench companion



WATCO®

The Original and Still the Best

DANISH OIL FINISH

Watco Danish Oil Finish can be your ideal workbench companion for all those wood finishing projects around the house. You'll be amazed at how easy it is to finish wood beautifully with Watco, "The Original Danish Oil". Watco gives wood that natural, hand-rubbed look with long-lasting durability. And because Watco is IN the wood... not on it like temporary surface coatings... there is no finish that will wear off. Watco Danish Oil is ideal for furniture, paneling, cabinets, doors, trim-work and even antiques. It's also safe for use on butcher blocks, cutting boards, and children's toys after Watco dries and cures in the wood. Choose from 8 beautiful finishes... Natural and Medium, Dark, and Black Walnut shades, and Cherry, Golden Oak, Fruitwood, and English Oak colors.

Send today for "Free" color booklet "How to Finish Wood Beautifully and Easily" and the name of your nearest Watco distributor.

WATCO-DENNIS CORP., Dept. BH-W18
2407 Wilshire Blvd., Suite 90
Santa Monica, CA 90403

Name _____
Street _____
City _____
State _____ Zip _____

Continued from page 22

THIS SKEW WON'T PUT YOU ON EDGE



Does the rectangular blade on your skew chisel leave you feeling a bit edgy? Tired of filing the dings out of the top of your tool rest? If so, you'll love the new oval skew from Robert Sorby Ltd., the English hand-tool specialists. Looking straight down the blade-end of this tool, you'll notice an oval-shaped profile rather than the rectangular one you're used to. The oval shape provides a smoother ride across the tool rest, and allows you to rotate the cutting edge to any angle without balancing the blade on a sharp corner. And, it's less likely to nick the tool rest should the tool happen to jump while you're turning.

Just as strong as its rectangular counterparts, the oval blade is lighter, giving greater sensitivity for making finishing cuts. The high-speed steel blade comes in 1/2", 3/4", 1", and 1 1/4" widths.

We found three sources for the Sorby oval skew (addresses listed below). Constantine and Woodcraft only carry the 3/4"- and 1"-wide skews; Garrett Wade carries all four sizes.

Sorby Oval Skew: From about \$20 for the 1/2" width to \$36.50 for the 1 1/4" width. Sources: Albert Constantine and Son, Inc., 2050 Eastchester Road, Bronx, NY 10461; Woodcraft Supply Corp., 41 Atlantic Ave., P.O. Box 4000, Woburn, MA 01888; Garrett Wade, 161 Ave. of the Americas, New York, NY 10013.



THINK ALL C-CLAMPS ARE THE SAME? THINK AGAIN.

Not all C-Clamps are created equal. For a tradition of quality and performance, choose VISE-GRIP® Locking C-Clamps. Old fashioned screw-type C-Clamps just don't compare with VISE-GRIP clamps. Unique self-leveling swivel pads protect work. They're easy to use, lock on quickly and provide a sure grip on any surface.

With nine sizes—ranging from 4" to 24"—there's a VISE-GRIP Locking C-Clamp for every job.

Don't go round and round with screw-type C-Clamps when you can have the quality and efficiency of VISE-GRIP Locking C-Clamps.

VISE-GRIP. THE ONLY NAME YOU NEED TO KNOW IN LOCKING HAND TOOLS.

© 1987 Peterson Manufacturing Co., Inc., Lincoln, Nebraska 68504



NEW

GREAT FURNITURE SHOWPIECES-- they're surprisingly easy to build

In addition to our Rolltop Desk **CLASSIC**, we have a series titled **WEEKEND WORKSHOP**. Instructions are just as complete as our **CLASSIC** plans. Rolltop desk plan costs \$11.00 plus \$1.00 s&h. Catalog is \$1.00 (free if you request it with your plans order). NY residents must include sales tax. Canadian residents please remit a postal money order in US funds.



HAMMERMARK ASSOCIATES, P.O. Box 201-WJ, Floral Park, NY 10002















Save time— call 516/352-5198 with your Mastercard or VISA order.

CARBIDE TIPPED ROUTER BITS

PROFESSIONAL PRODUCTION QUALITY

1000's SOLD TO READERS OF FINE WOODWORKING

BEST CUT BEST PRICE	ITEM NO.	DESCRIPTION	RADIUS	LARGE DIAM.	CUTTING LENGTH	PRICE
	COVE					
	#01	1/4" R	1/4"	1"	1/2"	\$13.00
	#02	3/8" R	3/8"	1 1/4"	9/16"	14.00
#03	1/2" R	1/2"	1 1/2"	5/8"	15.00	
	ROUND OVER					
	#04	1/4" R	1/4"	1"	1/2"	15.00
	#05	3/8" R	3/8"	1 1/4"	5/8"	16.00
#06	1/2" R	1/2"	1 1/2"	3/4"	19.00	
	ROMAN OEGEE					
	#07	5/32" R	5/32"	1 1/4"	15/32"	18.00
#08	1/4" R	1/4"	1 1/2"	3/4"	20.00	
	RABBETING					
	#11	3/8" R	Deep 3/8"	1 1/4"	1/2"	14.00
	#09	1/8" (KERF) SLOT CUTTER		1 1/4"	1/8"	14.00
#10	1/4" (KERF) SLOT CUTTER		1 1/4"	1/4"	14.00	
	#12	45° CHAMFER	45° Angle	1 1/2"	5/8"	15.00
	#15	RAISED PANEL	20° Angle	1-5/8"	1/2"	25.00
	V GROOVE 90°					
	#35	1/4" V Groove 90°		1/4"	1/4"	8.00
	#36	3/8" V Groove 90°		3/8"	3/8"	9.00
#37	1/2" V Groove 90°		1/2"	1/2"	11.00	
	DOVETAILED					
	#16	3/8" Dovetail 9°		3/8"	3/8"	7.50
	#17	1/2" Dovetail 14°		1/2"	1/2"	8.50
#18	3/4" Dovetail 14°		3/4"	7/8"	10.50	
	CORE BOX (ROUND NOSE)					
	#19	3/8" Core Box	3/16"	3/8"	3/8"	11.00
	#20	1/2" Core Box	1/4"	1/2"	11/32"	14.00
#21	3/4" Core Box	3/8"	3/4"	5/8"	18.00	
	GROOVE FORMING OEGEE					
	#22	1/2" Grooving Ogee		1/2"	3/8"	16.50
#23	3/4" Grooving Ogee		3/4"	7/16"	21.00	
	STRAIGHT					
	#24	1/4" Straight Bit		1/4"	3/4"	7.00
	#25	5/16" Straight Bit		5/16"	1"	7.00
	#26	3/8" Straight Bit		3/8"	1"	7.00
#27	1/2" Straight Bit		1/2"	1"	7.00	
#28	3/4" Straight Bit		3/4"	1"	10.50	
	FLUSH TRIM					
	#13	1/2" FLUSH TRIM		1/2"	1"	8.50
	KEY HOLE					
	#14	3/8" KEY HOLE (This Bit only HSS)	CUTS 3/8" KEY HOLE FOR FLUSH MOUNTING PICTURE FRAMES, ETC.			8.50

WHEN ORDERING ANY THREE OR MORE DEDUCT \$1.00 EACH
ALL PRICES POSTAGE PAID

- Professional Production Quality • 1/2" Ball Bearing Pilot
- 1/4" Diameter Shanks x 1 1/4" Long • One Piece Construction
- Two Flute Thick High Quality Tungsten Carbide Tips

To order by Mastercard or Visa Toll Free
7 Day—24 Hour Order Service, Call
1-800-533-9298 (in PA 1-800-346-7511 Ext. 56)
or send check to:

MLCS, P.O. Box 4053D, Rydal, PA 19046

ASK WOOD

Whether your woodworker's license reads "Beginner," "Intermediate," or "Advanced," you're bound to have a few questions about your favorite hobby. We can help. Each issue, we'll consult our experts for answers to your most-asked questions. Send your questions to:

Ask WOOD®
Better Homes and Gardens®
WOOD Magazine
Locust at 17th
Des Moines, IA 50336

Due to the volume of mail, we can't promise to answer all questions, but we try! Letters selected for use will be edited for publication.

SET THE PERFECT ANGLE EVERY TIME

Q. Could you please tell me if there is a way to set the blade of my table saw to any angle that I choose and have it be correct? The scale on the saw is not accurate enough. I want something I can lay on the table and against the blade to set the precise angle.

—Cordell Langley, Ackerman, Miss.

A. Cordell, there are several ways to set the angle of a table-saw blade (or the table of any other adjustable tool). For the first technique (illustrated below), you need a simple protractor, such as the kind you used in geometry class, and a sliding bevel gauge available at most tool stores.

To use, loosen the wing nut on the bevel gauge and then place the gauge alongside the protractor. Set the gauge at the angle you want. Tighten the wing nut, then place the bevel gauge on the saw

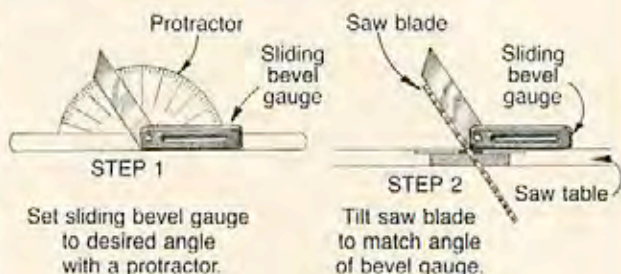

table and against the blade. Adjust the saw arbor until the blade aligns with the bevel gauge and matches the angle you've set on the gauge.

As a second option, you can buy preset-angle gauges from tool suppliers. One source, Robert S. Smith, Inc., Dept. JA87, P.O. Box 17330, Phoenix, AZ 85014, offers a set of six angles for \$29.95. To use, you simply select the desired gauge and position it on the saw table. Then, adjust the saw blade until it rests flat against the beveled edge. These gauges work well, but they do limit you to the angle of the gauges provided in the set.

Continued on page 28

24 SHOWS IN 1988!
Free Workshops ★ 100 Exhibits ★ Door Prizes

★ THE WOODWORKING SHOWS★

machinery
tools—supplies



SEE THE WIDEST VARIETY OF WOODWORKING
PRODUCTS ALL UNDER ONE ROOF

HUNDREDS OF ITEMS

Machinery * Power & Hand Tools * Supplies

Arizona	Jan. 8-9-10	Phoenix Civic Plaza
Metro Richmond	Feb. 5-6-7	Richmond Centre
Colorado	Feb. 12-13-14	National Western Complex, Denver
Greater Milwaukee	Feb. 19-20-21	Mecca Convention Hall
Florida	March 4-5-6	Curtis Hixson Conv. Ctr., Tampa
No. California	Mar. 25-26-27	San Jose Convention Center
Atlanta	April 8-9-10	Georgia Int'l Conv. Ctr., Atlanta
So. California	April 29-May 1	Los Angeles Airport Hilton
North Texas	May 6-7-8	Dallas Convention Center
Chicago	May 13-14-15	Pheasant Run Expo Hall, St. Charles
Upstate New York	May 20-21-22	Rochester Riverside Conv. Ctr.
New York	June 17-18-19	Nassau Coliseum

Seminars by Ian Kirby - Roger Cliffe - Bob Rosendahl -
Rude Osolnik - and other Master Craftsmen

1-800-826-8257, In California 213-477-8521.

Call for free brochure, 8:30-5 Pacific Time

Save \$1 off reg. \$6 admission with this ad

ASK WOOD®

Continued from page 26

YES, COCOBOLO CAN BE TOXIC

Q. I've read that cocobolo wood gives off a toxic fume when cut. I love the looks of the wood and have been wanting to do a few things with it. Is it safe to use cocobolo wood in anything that might come in contact with food?

—SSG Eric Moorehouse, Ft. Huachuca, Ariz.

A. Eric, we called Paul McClure, our wood expert, and he advises cocobolo wood not be used for projects such as drinking vessels, bowls, cutting boards, or any other items that hold or come in contact with foods.

Here's the concern: cocobolo (*Dalbergia retusa*), native to Central America, belongs to the rosewood family. As with most rosewoods, cocobolo contains potentially toxic chemicals, such as acids, alkaloids, resins, and tannins. These chemicals cause allergic reactions in some individuals on contact, producing an itchy rash similar to poison ivy. The reactions most often come from the dust created while sanding the wood. A reaction will more likely occur when one perspires, or when the dust might be damp. Using old, seasoned sapwood may help avoid some of these problems.

WOOD PARTS FROM MIDWEST DOWEL WORKS

Compare our low prices!

	Qty.	Cost
3/16" Poplar Shaker Peg	_____	_____
1 1/4" Mini Shaker Peg	_____	_____
3/16" Country Wall/Mug Peg	_____	_____
2 1/4" Country Shanty Peg	_____	_____
Large Bean Pot Candle Cup	_____	_____
Brass Inserts	_____	_____
1/2" Mini Candle Cup	_____	_____
1 1/4" Toy Wheel	_____	_____
2" Toy Wheel	_____	_____
Axis Pegs	_____	_____

Smooth Sanded Hearts

1/2" x 1/4" Hearts	_____	_____
3/4" x 1/4" Hearts	_____	_____
1" x 1/4" Hearts	_____	_____
1" x 1/2" Hearts	_____	_____
1 1/4" x 1/4" Hearts	_____	_____
1 1/4" x 1/2" Hearts	_____	_____
1 1/4" x 1" Hearts	_____	_____

FREE 16-PAGE CATALOGUE

Circle this section for
FREE Dowels — mixed pack,
Maple, Oak, Walnut, Cherry,
from 3/4" x 1" Approximately
10 LFL. 14" long.
\$5.00 value with any order.

Great Buys

	Qty.	Cost
1/2" x 36" Standard Dowels	_____	_____
1/2" x 36" Oak Dowels	_____	_____
1/2" Maple Butrons	_____	_____
1/2" Maple Butrons	_____	_____
1 1/4" Maple Spindles	_____	_____
2 1/4" Maple Spindles	_____	_____

ORDER NOW

MC/Visa Check Enclosed

Total Cost _____

Handling \$ 3.00 _____

Ohio residents
add 5 1/2% sales tax _____

Final Cost _____

MC/Visa # _____

Expires _____ Phone _____

Name _____

Address _____

City/State/Zip _____

MIDWEST DOWEL WORKS

4631 Hutchinson Rd.
Cincinnati, Ohio 45248
513-574-8488

Same Day Service/Order before Noon
Factory Direct/Satisfaction Guaranteed

HOME WOODWORKING TRAINING

Q. I have been a sawdust eater for about five years now. Some of my projects have turned out, but too many keep my fireplace blazing on cold nights. Can you suggest a home-study course on wood-working—something presented in a logical, progressive, self-evaluating manner?

—Len Henkel, Evendale, Ohio

A. You have several alternatives, Len, and one of these may work for you. For example, you may attend any number of woodworking schools and seminars that teach the basics. A listing of such schools ran in our April, 1987 issue, starting on page 86. You'll find a variety of classes ranging from two-day seminars to six-week courses. Some woodworkers enjoy planning a hobby vacation around a class.

Many local high school shop and/or industrial arts teachers also offer evening classes. Inquire with your school district's adult education department or with the nearest area college.

Recently, Foley/Belsaw began offering a home study course. For information write the firm at 6301 Equitable Rd., Dept. 43016, Kansas City, MO 64120.

There are many good books available on just about any phase of woodworking one could be interested in. For starters, see the article suggesting "woodworking books" on pages 58-59 of the December, 1987 issue. And, don't forget your public libraries. 📖

FREE Sanding Belts . . . get 6 FREE Belts for each dozen ordered. All belts, aluminum oxide, first quality, with bump-free splices.



On your next order of \$25.00 or more, subtract \$5.00 from your total order, fill in the coupon and mail.

INDUSTRIAL ABRASIVES CO.
643 N. 8th STREET
READING, PA 19612

"EVER-LAST" Belts from...

INDUSTRIAL ABRASIVES CO.

Check your size and how many dozen. We will ship assorted grits unless otherwise specified.

- 1" x 30" \$13.70/doz.
- 1" x 42" \$13.75/doz.
- 1" x 44" \$13.80/doz.
- 3" x 18" \$14.75/doz.
- 3" x 21" \$15.25/doz.
- 3" x 23 3/4" \$15.70/doz.
- 3" x 24" \$15.75/doz.
- 3" x 27" \$16.25/doz.
- 4" x 21 3/4" \$17.75/doz.
- 4" x 24" \$18.25/doz.
- 4" x 36" \$21.95/doz.
- 6" x 48" \$27.95 1/2 doz. (3 FREE)

Other size belts on request.

STIKY DISC, Rugged cloth with PSA backing.

- 6" diameter . . . \$1.00 each
- 8" diameter . . . 1.25 each
- 9" diameter . . . 1.50 each
- 12" diameter . . . 2.00 each

* Our Catalog contains 100's of useful sanding items for the woodworker!

9" x 11" PAPER SHEETS

A/O Cabinet Paper

- | | | |
|-------------|-----------------------------------|-----------------------------------|
| | 50/pk. | 100/pk. |
| 40-D . . . | <input type="checkbox"/> \$17/pk. | <input type="checkbox"/> \$31/pk. |
| 50-D . . . | <input type="checkbox"/> 16/pk. | <input type="checkbox"/> 28/pk. |
| 60-D . . . | <input type="checkbox"/> 15/pk. | <input type="checkbox"/> 26/pk. |
| 80-D . . . | <input type="checkbox"/> 14/pk. | <input type="checkbox"/> 24/pk. |
| 100-C . . . | <input type="checkbox"/> 13/pk. | <input type="checkbox"/> 22/pk. |
| 120-C . . . | <input type="checkbox"/> 13/pk. | <input type="checkbox"/> 22/pk. |
| 150-C . . . | <input type="checkbox"/> 13/pk. | <input type="checkbox"/> 22/pk. |

No Load Finishing Paper

- | | | |
|-------------|-----------------------------------|-----------------------------------|
| | 50/pk. | 100/pk. |
| 180-A . . . | <input type="checkbox"/> \$11/pk. | <input type="checkbox"/> \$19/pk. |
| 220-A . . . | <input type="checkbox"/> 11/pk. | <input type="checkbox"/> 19/pk. |
| 280-A . . . | <input type="checkbox"/> 11/pk. | <input type="checkbox"/> 19/pk. |
| 320-A . . . | <input type="checkbox"/> 11/pk. | <input type="checkbox"/> 19/pk. |
| 400-A . . . | <input type="checkbox"/> 11/pk. | <input type="checkbox"/> 19/pk. |

- BELT CLEANING STICK
- 2" x 2" x 6" \$6.95

- MONEY BACK GUARANTEE
- PROMPT DELIVERY FROM STOCK
- QUALITY PRODUCTS SINCE 1950

\$5.00 USE THIS COUPON AND **\$5.00**
SAVE \$5.00
ON YOUR NEXT ORDER OF \$25.00 OR MORE!

- SEND FOR FREE CATALOG *
- MONEY ORDER CHECK
- MASTER CARD VISA

SHIPPING CHARGES - Under \$35 add \$2.50. \$35 or more add \$4.00. Over \$100, shipping free. PA residents add 6% sales tax.

C188

Acct. # _____ Exp. Date _____
NAME _____ DAYTIME PHONE () _____

ADDRESS, ZIP _____
INDUSTRIAL ABRASIVES CO. • 643 N. 8th ST. • READING, PA 19612

WOOD ANECDOTE

SATINWOOD

Can you solve "The Mystery of the Open Hearth"?

On the hearth, flickering flames dance across golden wood. In a corner of the room, a canary twitters a farewell to daylight. The master of the house, his body lost in the billowy confines

of his club chair, sets his mind adrift in the peace of the moment as a coconutlike fragrance caresses his nose.

Shortly, the canary will fall from its perch. The body of the master will sink back in helpless slumber. And, in the firelight, the strangest burglary in history will begin.



Satinwood's yellow color and sheen make it a favorite for inlays.

Could even the famed Sherlock Holmes solve this mystery we've created? Perhaps not, unless he had been schooled in the world's wood. Only a dendrologist (one who studies trees) might suspect that it was the beautiful wood, once favored by famed furnituremakers Sheraton and Hepplewhite, that produced the aromatic smoke to sedate the man and send a canary to eternity.

It's doubtful that satinwood's dubious distinction as a natural sedative was well known by early

woodworkers. Instead, its fame came from a unique, golden yellow color and a satiny sheen.

The satinwood popular in the 1800s was *Zanthoxylum elephantiasis*, imported from the West Indies in quantity by England and the United States. It smells like coconuts when worked or burned. However, early exploitation of the species has made it unavailable today. The satinwood craftsmen now use is East Indian, or Ceylon, satinwood (*Chloroxylon swietenia*), a species with the same color, sheen, and sedative properties as the other, but without the smell. Don't burn Ceylon satinwood as a remedy for insomnia, though. Due to limited quantities, it sells for over \$2 a square foot — for veneer! 🌿

Photograph: Bob Calmer
Illustration: Jim Stevenson

There's a transformation going on in the Northwest logging country. A tree long considered an ugly duckling is finally becoming a swan!

Red alder, the Pacific coast's most abundant hardwood, has been around for at least 40 million years—often in too great of numbers. Timber producers even called it a weed because this fast-grower pops up in burned or logged out forest areas, sometimes menacing the growth of commercially important softwood seedlings.

Over time, though, foresters began to realize something special about red alder. It resists a wild-fire's consuming flames. Taking advantage of this, they planted red alder along logging roads for fire breaks to protect stands of conifers. Today, after loggers harvest the stands, they turn to the red alder for logs to supply a steadily developing market demand.

Red alder has gained respect as an absorbent pulp for paper towels, and as a tough pallet material. Even in woodworkers' eyes, red alder has emerged as an attractive, low-cost, easily worked, and durable stock.

Wood identification

All along its coastal range from Alaska to California, red alder (*Alnus rubra*) seldom grows alone. It typically occurs in groves along streams, rivers, and on slopes, where soil is moist and fertile. In perfect conditions, such as around Washington's Puget Sound, red alders

RED ALDER

The West Coast's weed tree goes to market



Red alder

reach a peak height of 130' and 36" maximum diameter.

You could easily mistake red alder for aspen or birch because of its smooth, very light gray bark with mottled markings often spotted by moss. The leaves appear similar, too, except red alder's are nearly twice as long and coated with short hairs on the underside. In the fall, the still-green leaves swirl to the ground.

Red alder's yellowish-white heartwood quickly

turns a reddish color when exposed to air.

However, the brightness fades to a flesh shade during seasoning. The wood's straight, close grain has subtle figure.

Working properties

At 28 lbs. per cubic foot, dry red alder weighs about two-thirds less than red oak. A little harder than butternut and not quite as strong as mahogany, the wood works easily even with hand tools. It accepts nails and screws readily, and holds them well. The wood has a good reputation for gluing.

We recommend a sealer or shellac wash coat

before staining to avoid blotchiness. While red alder's grain may raise if you use a water-based stain, the wood sands easily to a smooth finish. All kinds of clear top coats adhere readily.

Uses in woodworking

Due to red alder's stability and good gluing properties, manufacturers often use it as plywood core stock. Because it requires little cleanup sanding, the wood has also become a favorite for factory-made, mass produced turnings. You'll find this wood being used on the West Coast for paneling, doors, millwork, unfinished furniture, and even waterbed frames.

At home, you can use red alder for practically any project calling for hardwood. It turns and carves easily, and is hard and strong enough for furniture and casework. Use it as a substitute for cherry, mahogany, and/or walnut.

Cost and availability

Now that red alder has become appreciated as woodworking stock, and is light to ship, its availability has spread from the West Coast to the Midwest. Competition from woods such as poplar and willow make red alder less likely to be found in the East.

Red alder comes in five grades. Selects and better, the finest grade, costs less than \$2 per board foot. And, you can often find red alder boards up to to 3" thick. ♣

Illustration: Steve Schindler
Photograph: Bob Calmer

PLUNGE ROUTERS

GET DOWN TO
WORK WITH
ONE OF THESE
NEW-BREED TOOLS



Even if you already own a router, consider this: With a plunge router, you can start and end cuts in the middle of your workpiece without ever having to remove the tool from the wood's surface. So, if you like to plunge right into a project, here's a router you can do it with!

You just can't beat a plunge router for all sorts of interior routing: blind mortises and dados, cutouts, template routing, and freehand routing techniques, such as inlay work and sign making.

If you've ever tried to do any of these jobs with a conventional router, you know how tough they can be. For starters, you have to balance the router on the edge of the base, start the motor, then carefully tilt the bit into the stock. And you hope the bit hits the target without chewing up too much surrounding wood or your template in the process.

Not so with a plunge router. Why? Because the entire motor and bit assembly slides up and down (against spring tension) on two posts attached to the base. To make the plunge, you set the base on the stock, turn on the motor, release the locking lever, and push down on the handles, driving the bit arrow-straight into the wood. Then, you lock the motor down against the pre-set depth stop, and make your cut.

When done routing, release the locking lever and retract the bit by easing up on the handles. Straight in, straight out — a much safer way to

route. And, with the motor and bit assembly locked in the "down" position, a plunge router works just like a conventional one.

As versatile as plunge routers are, they do have a few drawbacks. One is higher cost. You'll usually get more horsepower for your money if you buy a conventional router. You also have a greater selection of sizes, prices, and optional features with the conventional tools.

Except for the two large Elu models, we found the depth-adjustment mechanism on plunge models harder to set and fine-tune than on most ordinary routers — especially if you have the router installed in a router table.

Plunge routers don't perform quite as well for edge routing, either. Most models have a large hole in the base which doesn't provide much stability for edge-routing narrow pieces and at corners. You can minimize the problem by installing a template guide adapter with a smaller opening.

Despite these few inconveniences, we consider the advantage of having the plunge feature well worth the extra cost!

HOW MUCH ROUTER DO YOU NEED?

You'll notice in the photos at *right*, that the plunge routers we tested fit into two basic groups: *heavy duty* (2 to 3 hp.) and *light duty* ($\frac{3}{4}$ to 1 hp.). The heavyweights include the Bosch 1611, Elu 3337 and 3338, Hitachi TR-12, Makita 3612BR, and Ryobi R-501. We feel that these tools have plenty of power for just about any routing job we'd ever do in our shop.

With this power comes a greater variety in bit choices. The big units come with $\frac{1}{2}$ " collets, but they also accept sleeves for $\frac{3}{8}$ " and $\frac{1}{4}$ " bits. The light-duty routers take $\frac{1}{4}$ " bits only. The bigger units also have a deeper plunge capacity than the little guys. In fact, we think they're the best of *any* router for cutting deep dados and mortises in a single pass; also for making cutouts in stock up to $\frac{3}{4}$ " thick.

But be prepared to pay the price. With a few exceptions, the heavyweights cost about twice as much as the light-duty, 1-hp. models.

If you do mostly medium- to light-duty routing, go with one of the small ones. These include the Elu 3303 and 3304, Makita 3620 (see chart), Hitachi TR-8, Metabo RT 508, and Ryobi R-151 and R-50 models.

Unlike their big brothers, these lightweight, easily maneuverable tools give you better control for precision work. Al Neilson at Ryobi suggests that their $\frac{3}{4}$ -hp. R-50 would be perfect for fine detail work, such as inlays.

Buymanship Note: With these plunge routers, when we say "light-duty," we're not implying cheap construction. Unlike other groups of tools we've tested, even the smallest routers have plenty of power for their size, and contain high-quality materials throughout. For example, all feature cast-aluminum lower motor/bearing housings and ball-bearing motor construction.

THE BIG BOYS



Hitachi TR-12

Bosch 1611

Makita 3612 BR

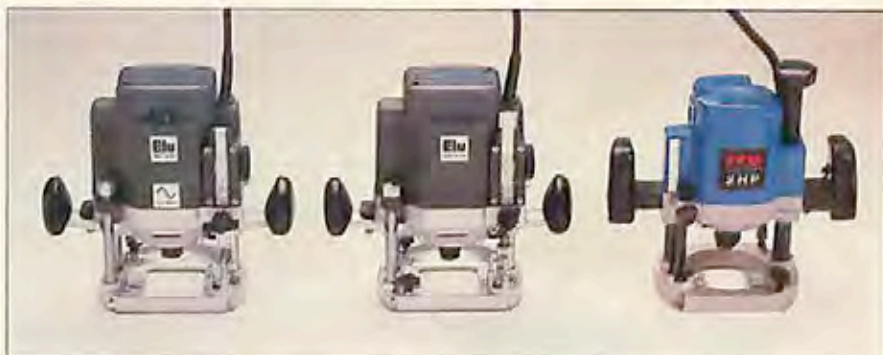

Elu 3338

Elu 3337

Ryobi R-501

THE BABY BROTHERS



Ryobi R-50

Ryobi R-151

Metabo RT 508



Hitachi TR-8

Elu 3304

Elu 3303

PLUNGE ROUTERS

READY TO BUY? CONSIDER THESE FEATURES

LOOK FOR SMOOTH PLUNGING ACTION

While checking out these routers, the first thing you'll probably want to do is plunge them up and down a few times. Does the router have a smooth, stick-free plunging action? Also test for slop (side-to-side movement) between the posts and

router body. To do this, have a friend hold the base firmly against a flat surface while you rock the body by the handles.

In our tests, the Elu and Makita routers had the smoothest overall plunge action. The plunge mecha-

nism on the Bosch 1611 had slightly more slop than we'd like to see. But we were testing an early prototype. Gary Compton at Bosch informs us that their engineers intend to correct this problem before the router goes into production.

THREE CHOICES IN PLUNGE LOCKS: We Prefer Self-Locking Levers

These levers or knobs enable you to lock the router body in any position on the posts. Ryobi, Hitachi, and Makita have manual levers. You push down with your thumb to lock, pull up with your index finger to unlock. (See photo *below*.) If you don't lock these levers firmly, they may vibrate loose. We found

the Makita lever somewhat cumbersome to operate, due to its close position to the ON/OFF switch.

On the Metabo and small Elu routers, you lock the plunge mechanism by twisting one of the knob-type handles, as shown in the photo *below*. They're real convenient to use. But you may accidentally

loosen the handle while using the router or picking it up.

We favor the spring-loaded, self-locking levers on the Bosch (shown *below*) and large Elu routers. To unlock the lever, you push down with your thumb; release the lever and it locks the router automatically in that position.



Manual locking lever requires the most effort to operate. Push down with thumb to lock; up to unlock.



Twist knob (right-hand handle) locks easily, but may loosen while you're routing or handling the router.



Spring-actuated lever automatically locks when you release your thumb. We found this type the easiest to use.

ROUTER BASES: We Like Screw-On Type

You'll notice that most of these tools have a base plate with one or more flat sides. This feature enables you to rout closer to adjoining vertical surfaces. For example, if you're making a sink cutout in a countertop, the flat side allows you to rout closer to the backsplash. It also makes it easier to follow guide boards clamped to the stock when cutting dados and other mortises.

You have two choices in base shoes: screw-on and stick-on (see photo at *right*). We prefer the

screw-on shoes because we like to remove them to use as a template for making our own subbases.

In terms of versatility, the small Ryobi R-50 has a distinct advantage. Ryobi uses the same motor assembly for their 3/4-hp. standard router (R-30), laminate trimmer (TR-30U), and tilt-base laminate trimmer (R-70). So, you can buy one tool, and add the bases of the other three as accessories. They're easily interchanged. Ryobi also sells an offset laminate trimmer base for this unit.



Stick-on base shoe, at *left*, peels off base for replacement. We prefer the screw-on type, shown at *right*. For details, see discussion at *left*.

ON/OFF SWITCHES: Are They Easy To Operate?

Check to see how easily you can flip the ON/OFF switch—*without* letting go of the router handles. On the Hitachi TR-12, you have to remove your right hand to operate the switch. We found this inconvenient. You have to do the same with

the Ryobi R-50. But its small size makes switch operation easier.

Switch types include toggles, rockers, slide switches, and triggers, shown in the photos *below*. We found the handle-mounted trigger switch (Bosch, Ryobi R-501 and

R-151) the safest and most convenient to operate—unless you plan to use the tool in a router table. The other switch types can be left on when the router isn't in use. So, the tool could start up unexpectedly when you plug in the cord.



Exposed toggle switch can get turned on by accident, even while the router isn't being used.



On the Hitachi TR-12, you have to let go of the right-hand handle to actuate the rocker switch.



The handle position on the Elu 3303 and 3304 models makes the slide switch hard to operate.



We found the trigger-type switches on the Ryobi and Bosch routers the easiest to use.

GETTING A HANDLE ON COMFORT

Comfort may not be everything when choosing a router, but sore arms and cramped hands are no fun. You can get a feel for the handles while shopping. To test, place the router on a surface at about the

same height as your workbench. Then plunge it a few times at different distances from your body. How does it feel?

We prefer large, elongated handles over the small, ball-shaped

knobs. Larger handles provide better control, especially on the heavier routers. Our favorites? The handles on the Bosch, Hitachi, and Makita. We'd like to see larger handles on the big Elu models (3337 and 3338).

DEPTH ADJUSTMENTS: How They Work

On most of these routers, the depth-adjustment mechanism works pretty much like the one on the small Elu shown at *right*. To set the depth, you first have to insert the bit so its bottom aligns flush with the router base. Next, you drop the adjustment rod onto the depth-stop screw, noting the indicator position on the depth scale. Then, slide the rod up a distance to equal the depth of cut you want to make, and lock it in place with a thumb screw.

All routers but the Metabo have turret stops with three positions, enabling you to make

multiple passes for deep cuts without having to reset the stop gauge each time. The Metabo stop has one position only.

We found the depth adjustment on the large Elu routers heads above the others (see photo at *far right*). It features rack-and-pinion adjustment, a fine-tuning knob, and a sliding hairline indicator to reset the zero mark.

Most of the routers have depth scales graduated in fractions of an inch. The Bosch scale reads in fractions of an inch and metric; the Makita in metric only.

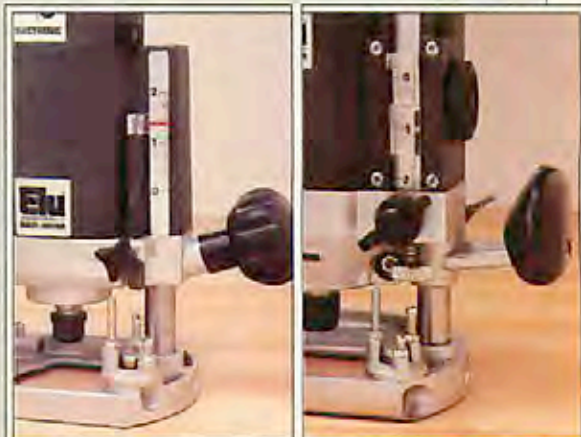

Depth adjustments on most units work like the one on the small Elu, *left*. The large Elu (*right*) has a more sophisticated mechanism.

PLUNGE ROUTERS

ACCESSORIES: Standard Or Optional?

As you might guess, all of these routers come with collet wrenches (required to change bits). And, most include edge guides as standard accessories. We like the sturdy, adjustable edge guides on the Bosch and Elu routers.

The Hitachi TR-12 offers the

most generous standard accessory package of all: wrenches, collet sleeves, edge guide, trimmer guide, and a 1/2"-diameter straight bit.

Refer to the buymanship chart below for standard and optional accessories each company offers for their routers. When comparing

prices, also compare the accessories that come standard with each tool. And remember to figure all of the accessories you'll need or want into the overall price of the router. For example, if you buy a 1/2" router, you'll probably want to get a 1/4" collet sleeve.

PLUNGE ROUTERS: VITAL STATISTICS

MANUFACTURER	MODEL NUMBER	MOTOR				COLLET CAPACITIES	MAXIMUM PLUNGE DEPTH (INCHES)	DEPTH STOP POSITIONS	SWITCH TYPE ²	PLUNGE LOCK TYPE ³	BASE			HEIGHT (IN.)	WEIGHT (LBS.)	ACCESSORIES ⁶		SUGGESTED LIST ⁷
		NO LOAD, RPM	HORSEPOWER ¹	AMPS (at 115V)	ELECTRONIC VARIABLE SPEED (Y/N)						OUTSIDE DIAMETER ⁴	HOLE DIAMETER ⁵	SHOE TYPE (ST/JCK-ON OR SC/REW)			STANDARD	OPTIONAL	
Bosch	1611	22,000	3	14	N	1/4, 3/8, 1/2	3	3	TR	S	6 3/4	2 3/8	SC	12 1/2	12	B	A, C, I, J	\$329
Elu	3303	24,000	1	6.5	N	1/4	1 1/8	3	S	T	5 1/16	2 1/8	ST	9 9/16	6	A, B	C, E	\$252
Elu	3304	8,000 - 24,000	1	6.5	Y	1/4	1 1/8	3	S	T	5 1/16	2 1/8	ST	9 9/16	6	A, B	C, E	\$299
Elu	3338	8,000 - 20,000	2 1/4	12	Y	1/4, 3/8, 1/2	2 1/8	3	S	S	6 1/16	2 3/8	ST	11 1/4	11 1/4	A, B	C, E, F, H, I, J	\$550
Elu	3337	20,000	2 1/4	12	N	1/4, 3/8, 1/2	2 1/8	3	S	S	6 1/16	2 3/8	ST	11 1/4	11 1/4	A, B	C, E, F, H, I, J	\$498
Hitachi	TR8	24,000	1	6.9	N	1/4	2	3	R	M	5 3/8	1 1/8	ST	9	6.6	A, B, C, D	G	\$218
Hitachi	TR12	22,000	3	12.2	N	1/4, 3/8, 1/2	2 3/8	3	R	M	7	1 1/8	SC	10 3/8	12.3	A, B, C, D, H, I, J	G	\$338
Makita	3620	24,000	1 1/4	7.8	N	1/4	1 3/8	3	TR	S	5 3/8	2 3/8	SC	8 13/16	5.7	G	A, B, C, E	\$166
Makita ⁸	3612 BR	23,000	3	14	N	1/4, 1/2	2 1/8	3	T	M	6 3/8	2 3/8	SC	9	6.6	J	A, B, C, E, H	\$338
Metabo	RT 508	27,000	3/4	5	N	1/4	1 3/4	1	S	T	5 3/8	1 1/8	ST	11 1/4	7 3/4	A	B, E	\$224
Ryobi	R-50	29,000	3/4	3.8	N	1/4	2 1/4	3	T	T	5 3/8	1 3/8	ST	9 3/8	5.12	A	B, C, D, E, F	\$164
Ryobi	R-151	24,000	1	6.5	N	1/4	2	3	TR	M	5 3/8	2	ST	9 3/4	5.9	A	B, C, D, E, G	\$199
Ryobi	R-501	22,000	2	13.3	N	1/4, 3/8, 1/2	2 3/8	3	TR	M	6 1/8	1 1/8	SC	10 1/4	9.7	A	B, C, D, E, H, I, J	\$326
Ryobi ⁹	RE-600	10,000 - 22,000	3	15	Y	1/4, 3/8, 1/2	2 1/8	3	TR	M	6 3/8	—	SC	12 1/4	14.4	A	B, C, E	— ⁷
Skil ¹⁰	1835	25,000	1 1/4	8.5	N	1/4	2	1	R	M	6	3 3/8	ST	9	7.5	—	A, B, C, E	\$125

1. Manufacturer's listed rating.
2. (T) Toggle (R) Rocker (S) Slide (TR) Trigger
3. (M) Manual lever (T) Twist knob (S) Self-locking lever
4. Maximum diameter on bases with

5. Minimum diameter of base opening; determined maximum bit profile diameter
6. A. Edge guide B. Template guide adapter C. Template guide bushing

- D. Straight bit E. Assorted bits F. Extra base and subbases G. Carrying case H. Trimmer guide I. 3/8" chuck sleeve J. 1/4" collet sleeve
7. Many routers discounted 10-30% below manufacturer's list price: List price

- for Ryobi RE 600 not established at time of publication.
8. Also available with square base.
9. Nonelectronic version also available (R-600).
10. New introduction: see opposite page.

MANUFACTURERS LIST: PLUNGE ROUTERS

Black & Decker Inc.
Call (800) 235-0870
for nearest dealer

Robert Bosch Power Tool Corp.
100 Bosch Blvd.
New Bern, NC 28562
(919) 633-4133

Kress Tools of America
1698 Post Rd. East
Westport, CT 06880
(203) 254-0067

Hitachi Power Tools U.S.A. Ltd.
4407-F Park Dr.
Norcross, GA 30093
(404) 975-1774

Makita U.S.A. Inc.
12950 Alondra Blvd.
Cerritos, CA 90701
(213) 926-8775

Metabo Corp.
1231 Wilson Dr.
P.O. Box 2287
West Chester, PA 19380
(215) 436-5900

Ryobi America Corp.
1158 Tower Lane
Bensenville, IL 60106
(312) 766-1621

Skil Corp.
4801 W. Peterson Ave.
Chicago, IL 60646

ELECTRONIC SPEED CONTROL: Nice!

Today, you'll find quite a few power tools with electronic variable-speed control. But Elu and Ryobi offer the only plunge routers with this feature. We tried out the Elu 3304 (1 hp.) and 3338 (2 1/4 hp.), shown in the photos on page 35.

The new variable-speed, 3 hp. Ryobi RE-600 (shown at *right*) wasn't available in time to test for this report, but should be on the market by the time you read it, along with a nonelectronic version (R-600). You'll find the specs for it in the buymanship chart on the next page. We understand that Freud also has a 3-hp. electronic router in the works, which may be available later this year.

We like this feature a lot. Not only can you dial the speed you want, but the electronics maintain a constant speed under varying loads by monitoring rpm and feeding voltage as needed. As a result, you're less likely to bog down the motor.

The electronics also include a "soft-start" circuit that smoothly accelerates the motor up to speed at startup. So, these routers don't jerk in your hands when you start them. Slower startup also extends the life of the switch, motor, and bearings.

We consider variable speed especially useful on the large routers (Ryobi and Elu 3338). Here's why: Several manufacturers now sell large-profile router bits, such as 4" raised-panel cutters. But these bits, because of their size, really aren't designed to cut at the very high speeds most single-speed routers run (20,000 to 24,000 rpm). With a variable-speed router you can closely match the listed speed ratings for these large bits for optimum performance and safe operation. Speed control also comes in handy for making slow, finish cuts in hardwoods.

These routers have an infinitely variable speed control: 8,000 to 20,000 rpm on the Elu 3338; 8,000

to 24,000 rpm on the Elu 3304; 10,000 to 22,000 rpm on the Ryobi RE-600. The speed control dial on the Ryobi has six reference settings, with corresponding applications listed in the owner's manual and on a chart attached to the router.



New from Ryobi: the RE-600 electronic variable-speed router. At 3 hp., it's their biggest unit. Ryobi also offers the same tool without the electronics (R-600).

THREE NEW ROUTERS

Too Late To Classify

Even as we were wrapping up this article, we discovered three more companies rushing to get their plunge routers on the market. Unfortunately, prototype units weren't available for us to test in our shop. But the manufacturers did provide us with the inside scoop on their

Priced at about \$55, the new 1 1/2-hp. Skil plunge router (model 1835) should be available later this year.



new introductions. (Prices and features may be subject to change).

Jepson

This heavy-duty Taiwanese import (model 7412) will sport a 3-hp., 14-amp motor, with a running speed of 28,000 rpm. It's similar to the Makita 3612BR in appearance and specifications. Priced at \$299, the Jepson plunge router should offer plenty of horsepower for the money. A straightedge guide and roller guide will come as standard accessories. The Jepson should be available by the time you read this article.

Kress

Made in West Germany, the 1-hp., 4.5-amp Kress (model KR-185) will represent one of 16 portable power tools to be imported by Kress Tools of America in early '88. Features include variable-speed control (8,000 to 24,000 rpm), a 1.8" plunge depth, and a three-position depth stop. In addition, it's designed so you can remove the base and use the

router motor as a straight die grinder. Kress Tools expects the router to retail for about \$120.

Skil

This well-known maker of consumer tools plans to introduce a new 1 1/2-hp. router (model 1835) later this year. This 8.5-amp tool, shown at *left*, will run at 25,000 rpm, and have a 2" plunge depth. Although we didn't get to hand-test this one, the large handles should be an improvement over the smaller handles on other plunge routers.

Other specs: a flat top and a shaft lock for easy, one-wrench bit changing, 1/4" collet, manually operated plunge lock lever, single-position depth stop, 6' cord, handle-mounted rocker switch, and a depth scale graduated in metric and 1/8" increments. Skil expects the tool to list for about \$125. ♣

Written by Jim Barrett
Technical Consultant: George Granseth
Photographs: Bob Calmer

ONE MAN'S ONE-



With a one-man, backyard sawmill, Darrell Mattson rips wood for his woodworking projects as well as nominal-size boards for construction.

Darrell Mattson, an industrious Illinois woodworker, lives out a dream many craftsmen share—being a sawyer at his own backyard sawmill.

Had lean, six-foot-tall Darrell Mattson lived when pioneers settled Illinois prairies, he would have been called a "Jack of all trades." At 42, he's an experienced auto and truck mechanic, a licensed pilot and flight instructor, a locksmith, carpenter, woodworker, and, since 1983, a sawyer with his own mill. Explains Darrell: "I try to be self-sufficient."

When Darrell and his wife, Connie, bought five acres just outside Sterling, Illinois, three years ago, they began to practice what Darrell has always preached. He drilled the well for water. Rows of evergreens they planted will someday give them shade and windbreak, or even Christmas trees to sell. A tennis-court-size garden yields vegetables from spring through fall. Chickens provide eggs, and the Mattsons have traded labor harvesting sorghum for gallons of sweet syrup. And, with his sawmill, Darrell cut boards for framing, fencing, and constructing outbuildings, such as the stable for his daughter Colleen's Appaloosa horse. He also uses his home-sawed hardwood for making clocks and furniture.

"I probably should have lived 100 years ago, when people *had* to do all these things," Darrell says half-jokingly. Then, more seriously, "I'd rather make or install something myself than have it done. This way, if something goes wrong, I know how to fix it."

That philosophy was responsible for Darrell's decision to buy a sawmill. Sure, he planned to save money on dimension lumber and woodworking stock. But, there was a good measure of just wanting to saw his own boards, too. When it

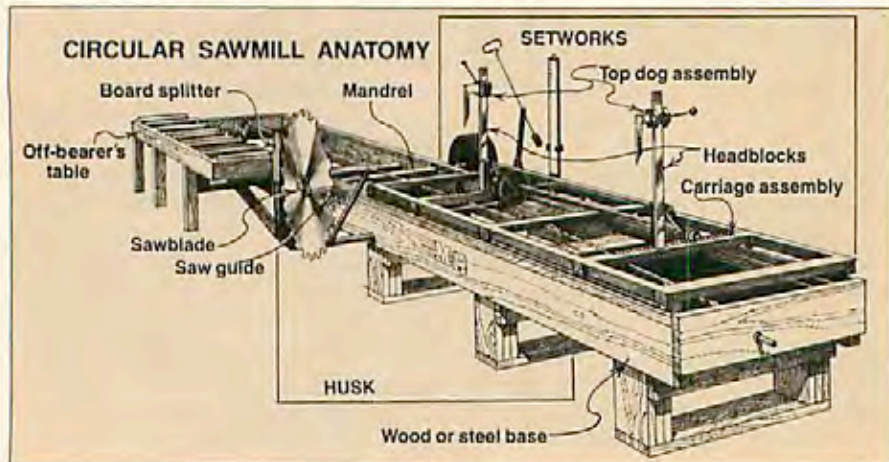

MAN SAWMILL

came time to buy, Darrell purchased a circular sawmill. "I wanted to saw logs the traditional way, and without doing it in a trench with a pit saw," he muses, "a circular mill was as traditional as I could get."

A NO-FRILLS SAWMILL OUT OF A BOX

A graduate of Foley-Belsaw's home study course on locksmithing, Darrell wrote to the same Kansas City, Missouri company when it came time to buy a sawmill. He read about, then ordered their Model M-14—no-frills simplicity. This saw, relatively unchanged, has been marketed by the firm since 1926, first to Midwest farmers who turned woodlots into cattle barns, then to entrepreneurs looking for a business, and now to a growing number of woodworkers.

Foley-Belsaw's M-14 sawmill arrives in a box, ready to assemble. Except for an optional 46" diameter blade with 36 replaceable steel teeth (a 40" blade is standard), Darrell bought the basic package (see sawmill drawing, opposite page): a 40"x10'-long steel carriage with setworks that feeds logs to the blade and gigs back, a mandrel assembly for the saw blade, and a headblock and top dog assembly to hold the log. The sawmill cost him about \$2,400. The manufacturer offers an extra-cost steel base on which to mount the mill, but Darrell elected to build his own. The M-14 does not come with a power plant—the buyer must furnish a gasoline or electric motor, or a tractor with power take-off (PTO) from the drive train.

Set up as instructed, the M-14 will saw logs up to 14' long and 20" in diameter (24" diameter with the 46" blade Darrell uses). The blade reaches an operating speed of 600 rpm, and the carriage moves forward 54 feet per minute. Advertisements say one man can produce 1,000 board feet of lumber per day. Darrell doesn't. It's a hobby.

Working in his spare time, Darrell got his sawmill up and running in about two months. For the base, he welded a framework made from steel I-beams salvaged from an old mobile home. It rests on railroad ties buried in the ground. Deeply set, treated posts keep the base steady. And, everything is perfectly level and plumb, from power source to mandrel, off-bearer's table (where boards come to rest after they're sliced off the log) to setworks. For accurate sawing, it has to be.

"For power, I started with my tractor's PTO, but it was too slow," Darrell explains. "I ended up trading some work in exchange for a six-cylinder Ford engine and transmission. I hooked up the transmission so it uses reverse gear to turn the drive shaft for the saw blade. That way, the rpm's are about right, and I get enough power."

Darrell also fabricated the shed, the off-bearer's table, and he assembled a simple log deck. Its two wooden arms, though hardly fancy, absorb the shock from loading logs that the carriage couldn't take. "I built the shed roof to protect the mandrel, the saw, and the setworks. I've also put the engine behind a wall, away from the mandrel, so it runs quieter and I can concentrate on the sawing," he advises.

LEARNING TO SAW FROM A BOOK

Not knowing how to do something has never stopped Darrell from giving it a try, and the sawmill was no exception. Everything he's learned about sawing logs came from the guidebook he got with the sawmill—and from hands-on experience.

"I'm still learning," Darrell admits. Yet, he tosses sawmill terminology around as effortlessly as he does fresh-sawed boards. Terms he uses, that have to be understood even by backyard sawyers, include: **cant**—*a log that has been squared up, or slabbed on at least two sides* **dog**—*device with adjustable*

spikes to secure a log on the sawmill carriage for sawing

dog board—*the last full-width board to be sawed off a log*

gig back—*to return the carriage back to the starting position after making a saw cut*

hammer—*the professional tensioning (conditioning) of a circular sawmill blade with a hammer so that it will expand evenly in use* **hammer speed**—*the operating speed of a sawmill at which the blade runs true*

lead—*the slight misalignment (measured in fractions of an inch) of the saw arbor with the log that keeps the back edge of the blade from contacting the log as it passes and that also counteracts the tendency of the blade to run out of the cut (see drawing, below)*

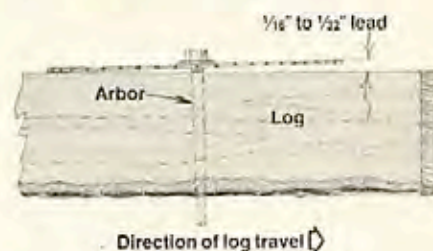

swage—*the technique of shaping saw teeth for an even bite by hand with a hammer and a die called a swage*

SETTING UP FOR SAWING

You wouldn't think of ripping stock on your table saw without first checking the blade's alignment and cutting height, and setting the fence. It's not much different with a circular sawmill.

With proper lead on the blade, Darrell can saw away effortlessly all day long, and count on every board being the same thickness. Improper lead shows up right away. "If lead is off a bit," the hobby sawyer notes, "boards will be thinner at one end because the blade runs out of the kerf. The blade heats up, too."

On his sawmill, Darrell adjusts

Continued

ONE MAN'S ONE-MAN SAWMILL



Darrell uses a 46" diameter, inserted tooth sawblade that cuts a $\frac{1}{32}$ " kerf. The blade's 36 steel, style-B teeth can be replaced individually.



Without a metal detector, a home sawyer takes the chance of hitting metal embedded in the log. This model reads right through a log.



A cant hook helps turn heavy logs on the carriage. Darrell slabs off two sides to get the log to rest squarely and solidly against the headblocks.

lead with bolts on either side of the drive shaft that angle the blade arbor in or out. "For softwood," he says, "lead should be about $\frac{1}{16}$ " (and can be as much as $\frac{1}{8}$ "), and for hardwoods and frozen wood, about $\frac{1}{32}$ ". Each type of wood runs a little different, though, so I measure the thickness of the first board, then check occasionally."

"Sometimes," he continues, "what at first looks like improper lead may actually be dull teeth." When teeth get dull on a table saw blade, you send it out for sharpening, or replace it. With a 46"-diameter sawmill blade, you start filing. Darrell's blade has 36 removable teeth—when they're too far gone to sharpen, he pulls them and inserts new ones, as in photo, above left. "They're called 'Type B' inserted teeth, and cost 60 cents apiece," Darrell says. He bought 100 of them with the saw, and has used only two-thirds of them in four years.

Filing isn't difficult, only time-consuming. "Right now, until I get a grinding jig built, I file the teeth by hand, then swage them to their original $\frac{1}{32}$ " width. In a full day of sawing, I'll probably file about three times," he explains.

Swaging a tooth requires a metal swaging tool and a ball peen hammer. One end of the tool has two indentations: a slightly concave one

to spread and shape the tooth point and a straight one to square it off. Darrell says: "All you do is insert the swage on the tooth and tap it."

All a sawyer's preparation for lead and sharp teeth would only be in vain, though, if the saw were to hit metal buried in the log. A nail might chip a tooth, a spike shear one off. Tales of hatchet and hammer heads, pieces of farm machinery, and strands of old barbed wire buried in large old trees taken from hedgerows and woodlots give Darrell a cold sweat. Many of his logs come from neighboring farms, so he goes over every inch of them with a metal detector (see photo above, center). "On sale, this detector cost me about \$350, but it can pick out metal with mass as small as a quarter," he says. "I haven't hit anything since I got it."

GETTING TO KNOW THE TOP DOGS

A light sawmill, such as Darrell's M-14, will produce lumber that compares favorably to lumber sawed by the most expensive, heavy-duty commercial mill. However, for this to happen, the operator must know the equipment from top dogs to board splitter, be able to fine-tune it, and recognize its limits.

With his mechanical aptitude and skills, Darrell grasped his role as a

sawyer as easily as he changes plugs in his Jeep C-J. From the time he lays a log down on the carriage to when he removes the rough-sawed boards, there's little wasted motion. Confidence, care, and concentration result in the steady, deliberate sawing from log to log that produces accurately dimensioned stock.

A typical sawing sequence starts by lifting a log onto the deck—small logs with muscle power, large ones with a tractor. Then, Darrell rolls it over on the setworks, shown above, right. "If they don't rock, heavy logs don't really have to be dogged down because their weight will hold them steady," he advises. "Lighter ones, though, need to be dogged for safety, so they won't shift under the saw blade." The two pronglike instruments mounted above the setworks, called the *top dogs*, hold the log in place by pressing it against the carriage. By eye, Darrell lines up the log for the slab cut (first cut) by moving the setworks closer to or farther away from the blade.

"What I try to do," he tells us, "is saw a flat spot on the log so I can turn it to rest flat on the carriage. After the second cut, I turn the log again so the other flat surface can go firmly against the headblock."

Once the log sets against the headblock, Darrell sends it re-



Darrell controls throttle and feed rate as the sawblade bites into the "dog board," the last full-thickness board cut off a log. He saws each board to $\frac{1}{16}$ " thick.



A half hour's sawing yields several board feet of black walnut. Darrell turned the log in order to obtain a few crotch-figured boards he'll save for special projects.

peatedly into the blade, listening to the engine and the spinning blade to make sure it's running at hammer speed: "I have to maintain hammer speed by either throttling the engine up or down, or slowing down the feed rate. To increase speed, I slow down the feed rate—that's how a guy can get by with a rig like this for even large logs. Just creep the timber through." Darrell is so careful about controlling hammer speed, and not heating up the blade to throw off its tension, that he has never had to have the blade professionally rehammered.

Each trip into the blade yields a board measuring $\frac{1}{16}$ " thick (photo above, left). For $\frac{3}{4}$ " stock, that leaves Darrell $\frac{1}{16}$ " to take off on his planer after the green boards have dried. But before he seasons them, Darrell trims off the irregular edges from the rough-cut lumber by hand with a portable circular saw and a super straightedge made from a 10'-long, steel signpost.

RIPPING WITH CRUISE CONTROL

All the wood Darrell saws ends up, for a time, baking in his solar kiln. A greenhouse-like structure made from polyethylene film stretched over a framework, the kiln presently depends on natural convection to move air over the wood. Accord-

ing to Darrell, he has plans to improve on that, and install a system that will more efficiently whisk away moisture.

He also intends to modify the powerplant by adding cruise control to govern engine speed! "Right now, I have to listen for the engine to slow down, then quickly crank up speed or slow down on my feed." Darrell's face wrinkles to the thought, his blue eyes beam on a distant focus. A smile starts as he anticipates the resourceful connection. "And, I don't imagine it would be hard to hook up a regular automobile cruise control on the engine. What do you think?"

Written and photographed by
Peter J. Stephano
Illustrations: Jim Stevenson

HOME SAWMILL OPTIONS

Until a few years ago, your options for a home sawmill were limited primarily to circular saw mills or those made from a basic chain saw. Today, portable mills proliferate as interest in sawing grows.

Basically, you'll find only three types of mills—circular, chain saw, and band saw. Briefly, here's how they differ:

- **Circular sawmills** use a round, multitoothed, stationary blade of 30" to 46" diameter to saw logs fed to it on a traveling carriage. Setup can be on a permanent base anchored in the ground, or portable, mounted on a trailer. Cost varies from \$2,500 (less power unit and base) to about \$14,000.

- **Chain-saw mills** operate with high rpm, lightweight engines, special rip chains, and slabbing rails to saw a log into boards. The operator, or the operator and a helper, guide the mill down the length of the log. Extremely portable, chain-saw mills range in price from \$600 to about \$1,200.

- **Band-saw mills** utilize a thin (from .032" to 0.090"), horizontally or vertically mounted blade to saw. Some band-saw mills feature a traveling carriage that feeds logs to the blade. Other smaller, lighter units take advantage of gravity to ride the length of a log positioned at a slight pitch. Some large band-saw mills are trailer-mounted; smaller ones can be carried by the operator. Prices start at \$2,400 and climb to about \$10,000.

For more information about portable sawmills, contact these major manufacturers:

BAND-SAW MILLS

Delta International Machinery Corp.
246 Alpha Dr.
Pittsburgh, PA 15238

WoodMizer Products
Div. of Laskowski Enterprises, Inc.
8180 W. 10th St.
Indianapolis, IN 46214

W.K. Ross, Inc.
640 Main St.
West Hempstead, NH 03841

CIRCULAR SAWMILLS

Foley-Belsaw Co.
6301 Equitable Rd., Dept. 30818
Kansas City, MO 64120

Mobile Mfg. Co.
798 NW. Dunbar Ave., P.O. Box 258
Troutdale, OR 97060

CHAIN-SAW MILLS

Sperber Tool Works, Inc.
Box 1224
West Caldwell, NJ 07007

MAKE 'EM YOURSELF MOLDINGS

It's Easy With Our Multiple-pass Router Techniques



Armed with a router, router table, and a few bits, you can turn plain stock—of any species you want—into custom moldings for a fraction of the cost of milled ones.

If you've ever purchased cabinet-quality moldings, you know that they can cost a bundle. And, you can't always locate the exact molding profile you need for your project. Most outlets that handle moldings stock only the most commonly used designs in the most popular species—pine, oak, poplar, and mahogany.

Of course, woodworkers who own a shaper and a good complement of cutters have no problems making their own moldings. But we've been curious for some time about whether or not it really makes any sense to mill decorative moldings with a router.

To find out, we asked Design Editor Jim Downing to develop five attractive, useful molding profiles to test-make in the shop. Then, once the design work was finished, we rounded up the necessary bits and headed for the router table.

What did we find out during our shop test? Two things, actually. First, if you work carefully, you can, indeed, get good results. And, you can have a lot of fun doing it.

On the following pages we show you exactly how we made our five decorative moldings. Try making one or more of them to get a feel for how the multiple-pass procedure works. Then, once you get the hang of it, try making a few moldings of your own design.

HERE'S WHAT YOU'LL NEED TO MAKE THE MOLDINGS

We recommend at least a 1-hp. router. You'll also need a router table with a 90° fence 3" to 4" high. The chair rail molding on page 49 also requires a 45° fence for one of the cuts (see drawing on page 49 for details on making one).

We chose standard, commonly available bits to make most of the cuts. But several cuts require specialized Sears bits (specified in the instructions). You can substitute similar bits from another manufacturer, but you may have to make some slight adjustments to the bit height and fence locations shown on the drawings.

TIPS ON MAKING THE CUTS

For each molding, follow the step-by-step drawings to set the bit height and fence position for each pass (we also specify which bits to use). To orient yourself to the end-view drawings, face the router table so the fence is to your right.

Note: In the drawings we include a reference dot (★) to help you identify the position of the piece for each cut.

TABLE EDGING



This edging fits tables with 3/4"-thick tops. A 1/4"x1/2" slot in the back edge of the molding enables you to spline-join it to the top.

BASE MOLDING



This popular design adapts well to walls and furniture pieces. Try this easy-to-make molding for starters; it takes only two bits and five cuts.

2 For a few of the cuts, you'll need support strips to steady the workpiece while routing. Make them the length of the table, and attach them with double-faced tape.

3 Support the ends of long pieces with auxiliary table supports or rollers. Use a feather board to hold the stock against the fence.

4 You'll get more uniform results in grain pattern and color if you

make all your molding from the same board.

5 Allow about 6" waste for each 8' of material. You're more likely to dip the stock into the bit or move it away from the fence at the beginning or end of the cut.

6 When making each pass, don't rely entirely on the measurements on drawings. Double-check the bit position against the previous cut to

make sure they're perfectly aligned. (We sometimes had to make adjustments in the fence position or bit height because the previous cut was slightly off.) Use a short piece of stock to test bit and fence positions for each pass.

7 If you're making several lengths of the same type of molding, be sure to run all lengths through each step before changing settings.

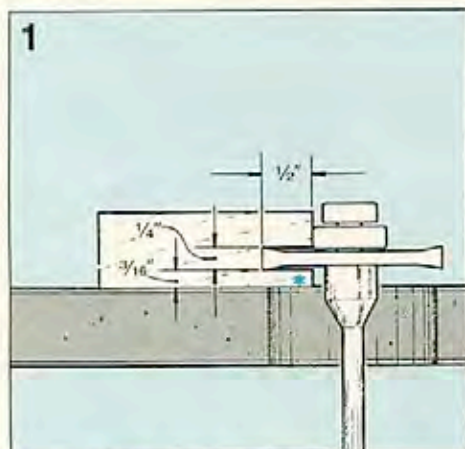

1 Start with $\frac{3}{4} \times 2\frac{1}{8}$ " stock. Use a $\frac{1}{4}$ " slot-cutter bit to rout a groove along one edge of the piece, where shown on the drawing.

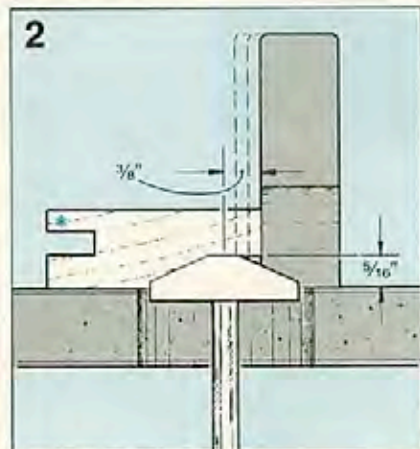

2 Switch to a Sears $1\frac{1}{16}$ " raised-panel bit no. 25465. Make three passes by repositioning fence in $\frac{1}{8}$ " increments.

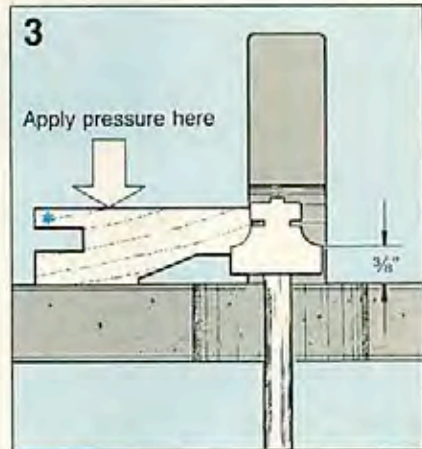

3 Switch to a $\frac{3}{16}$ " round-over bit with pilot. While cutting, push down on back side of stock to keep it from rocking.

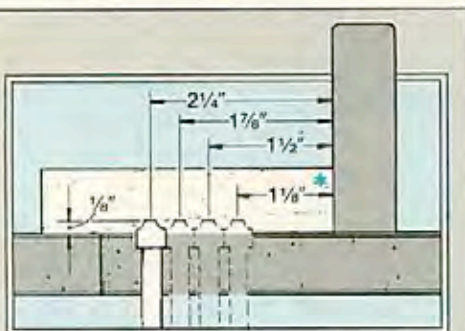

Start with $\frac{3}{4} \times 3\frac{1}{2}$ " stock. Use a $\frac{3}{8}$ " beading bit to make cuts where shown by moving the fence.



Make the final cut with a $\frac{3}{4}$ " classical bit, centered on front edge of fence, as shown on the drawing.

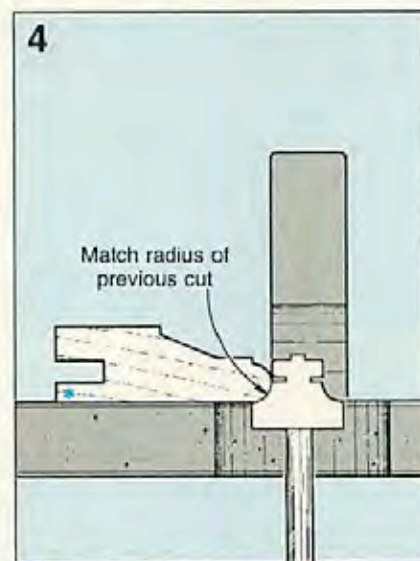

4 Flip the piece end-for-end. Lower bit to match radius of previous cut. (Do not change the fence position.)

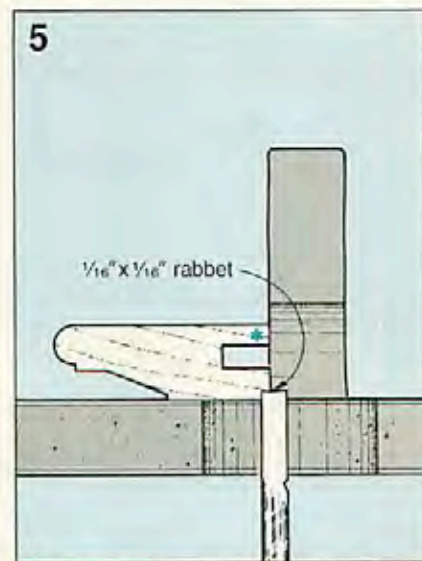

5 Switch to a $\frac{1}{16}$ " straight bit. Set bit height and fence position to cut a $\frac{1}{16}$ " \times $\frac{1}{16}$ " rabbet. Flop piece as shown.

Continued

ROUTER MOLDINGS



PICTURE FRAME

Beauty often lies in simplicity. As intricate as this decorative picture frame molding looks, you need only two bits to make it: a $\frac{1}{2}$ " straight bit and a $\frac{3}{4}$ " ogee bit. And therein lies much of its beauty.

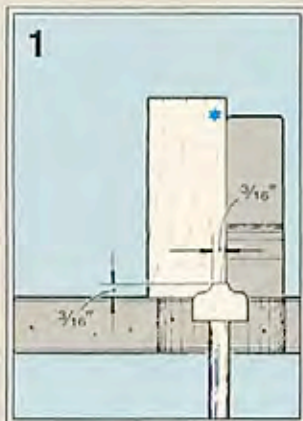

1 Start with $1\frac{1}{16} \times 2\frac{3}{4}$ " stock. Use a $\frac{3}{4}$ " ogee bit to make cuts for steps 1 through 3.

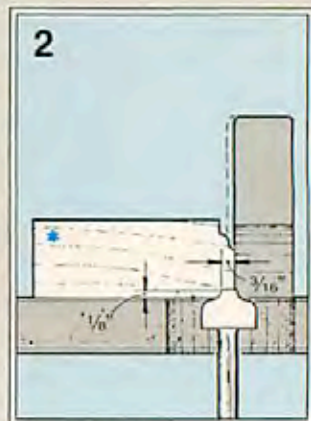

2 Make two passes by moving the fence to keep top of bit from chipping out the wood.

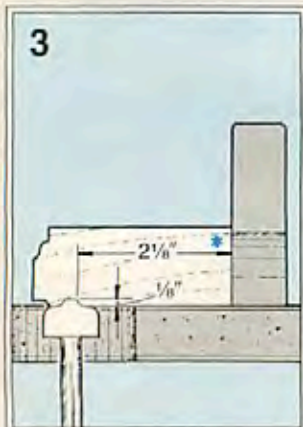

3 Flip the piece end-for-end. To make the cut, align bit with radius of previous cut.

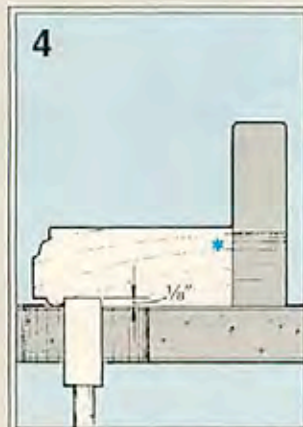

4 Use a $\frac{1}{2}$ " straight bit. Set fence and bit height so bit cuts flush with corner of bead.

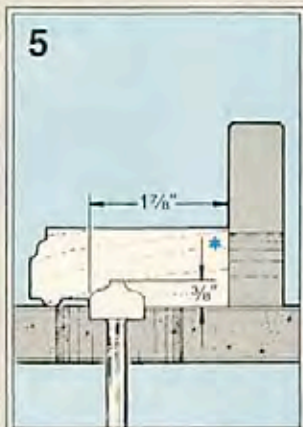

5 Switch back to the $\frac{3}{4}$ " ogee bit to make this cut. You may need to make two passes.

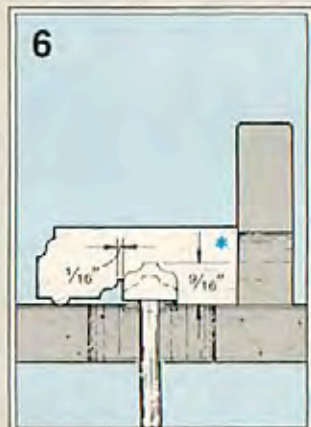

6 Cut requires two passes. Raise bit to full height to set fence, then lower to make first pass.

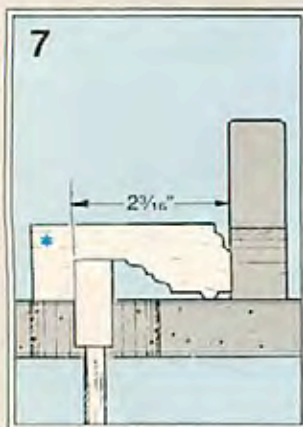

7 Flip piece end-for-end. Set $\frac{1}{2}$ " straight bit to match height of previous cut, as shown.

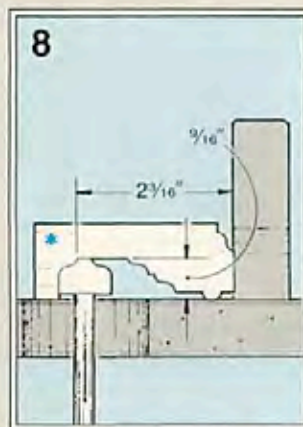

8 Switch back to the $\frac{3}{4}$ " ogee bit, setting its height to match that of the previous cut.

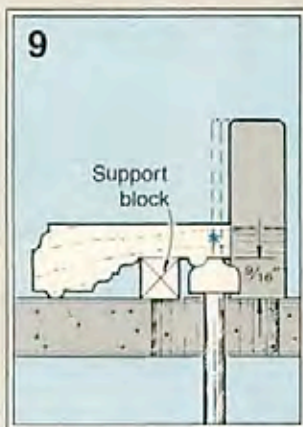

9 Attach a $\frac{1}{2} \times \frac{3}{16}$ "-high support block to table where shown. Make three passes.

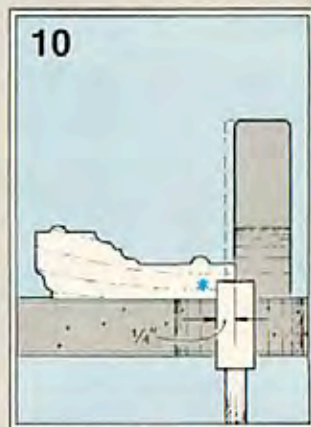

10 Position the $\frac{1}{2}$ " straight bit to cut a $\frac{1}{4} \times \frac{1}{4}$ " rabbet. Move fence; make two passes.

CONTINUOUS DRAWER PULL

Continuous pulls make a popular alternative to hardware on the doors and drawers of contemporary cabinets and other furniture. We've designed this one to fit standard $\frac{1}{2}$ " laminated plywood or particleboard drawer fronts.

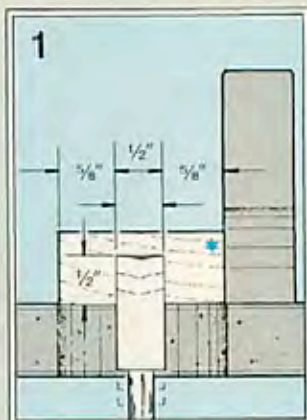

1 Start with $\frac{3}{4} \times 1\frac{1}{4}$ " stock. Use a $\frac{1}{2}$ " straight bit. Make three passes by raising bit.

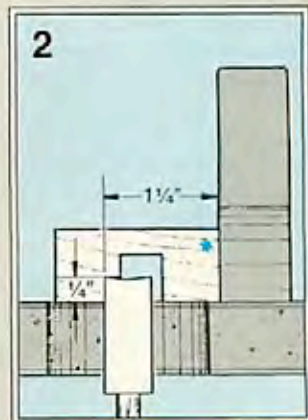

2 Lower bit to $\frac{1}{4}$ " above table height, and reposition fence to make cut where shown.

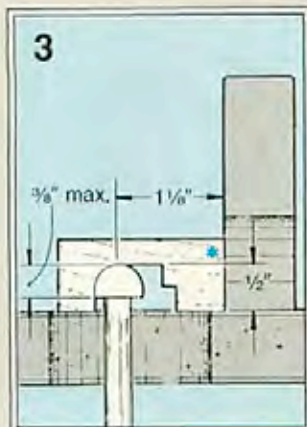

3 Flip the piece end-for-end. Use a $\frac{1}{2}$ " core box bit with a maximum profile height of $\frac{3}{8}$ ".

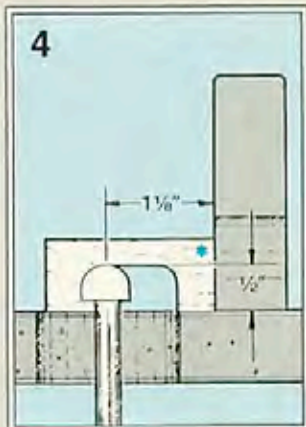

4 Flip piece end-for-end. Do not change bit height or fence position when making this cut.

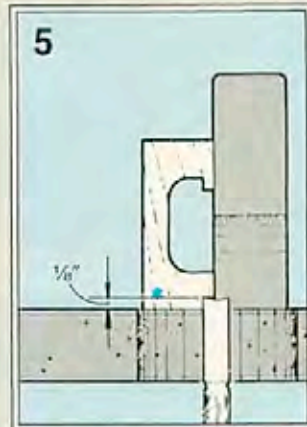

5 Use a $\frac{1}{4}$ " straight bit, centered on front face of fence, to cut the rabbet where shown.

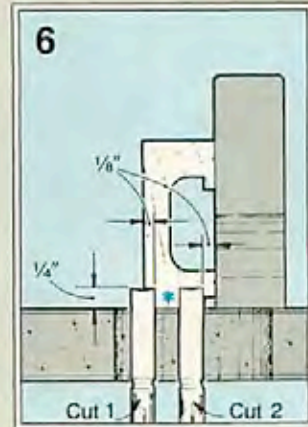

6 Reposition fence and bit where shown on drawing to make cut 1; again to make cut 2.

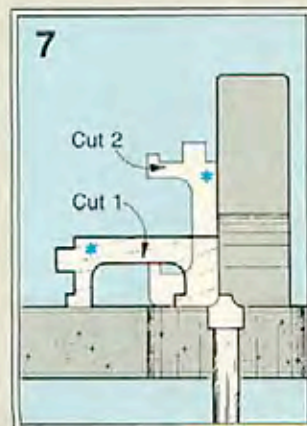

7 Align radius of $\frac{3}{8}$ " beading bit with face of fence to round over outside corners as shown.

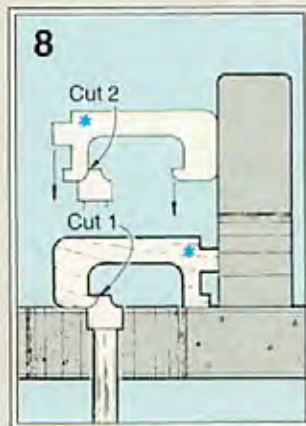

8 Reset fence to round over inside corners of pull (cuts 1 and 2). Do not change bit height.

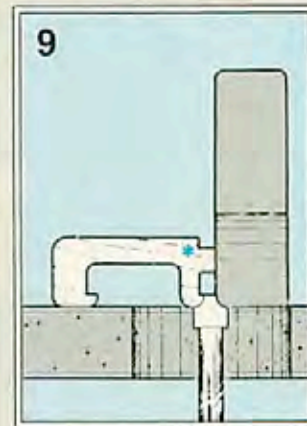

9 Reset fence again to round over bottom lip of pull as shown. Do not reset bit height.

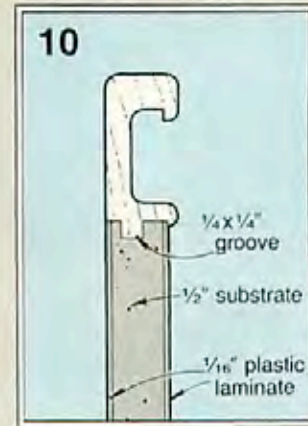

10 To install, rout a $\frac{1}{4} \times \frac{1}{4}$ " groove in top edge of door or drawer front. Glue pull in place.

Continued

ROUTER MOLDINGS



PICTURE RAIL

You'll most often see this molding in older homes with tall ceilings. Running horizontally about 2' below the ceiling, the rail forms a lip for hanging pictures (or displaying china plates). You'll need a table saw to do step 6.

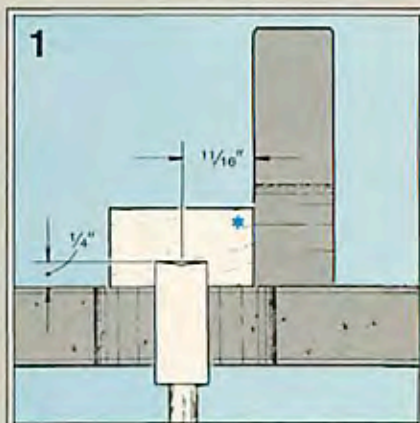

1 Start with $\frac{3}{4} \times 1\frac{1}{8}$ " stock. Use a $\frac{1}{2}$ " straight bit to cut a $\frac{1}{4}$ "-deep groove in the center of the piece.

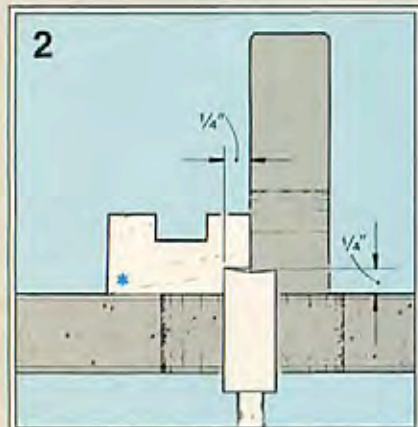

2 Without changing the bit height, move the fence to center its front face above the router bit, as shown.

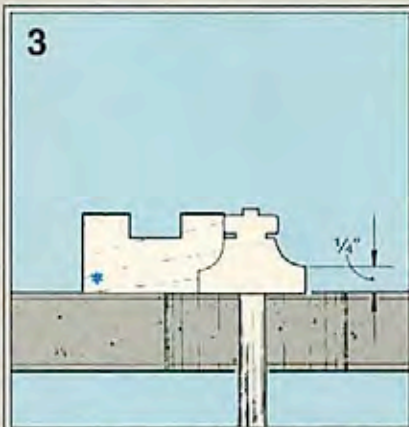

3 Use a Sears $\frac{1}{4}$ " bead quarter-round bit no. 25563, with pilot bearing. You won't need the router table fence for this step.

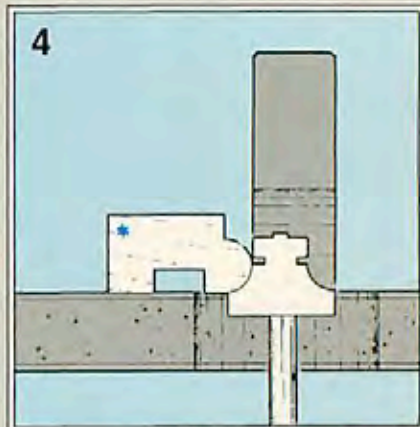

4 Position fence and adjust bit height to align bit so it matches radius of cut you made in previous step.

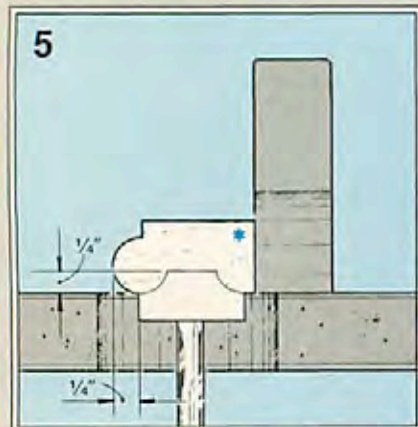

5 Remove the bit's pilot bearing to make this cut. Align bit with radius of cut you made in previous step.

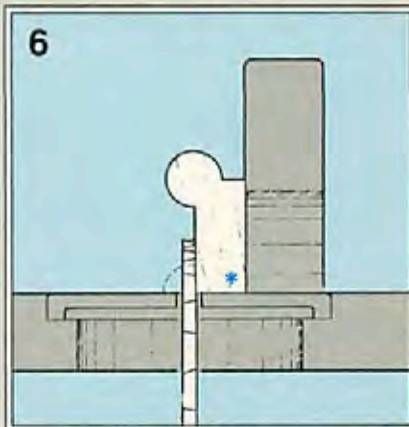

6 On your table saw, cut off the lower projection on the piece where shown on the drawing, to make a flush edge.

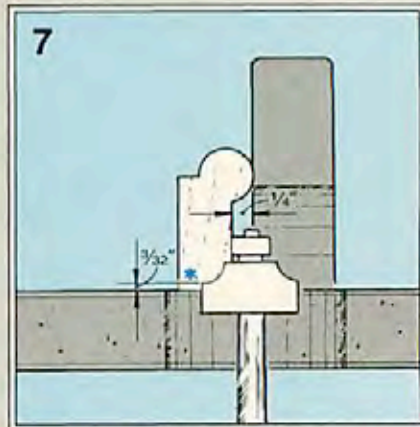

7 For the final cut, use a $\frac{3}{16}$ " beading bit (with pilot). Set fence to support the piece, as shown on the drawing.

CHAIR RAIL

Use this molding as a decorative accent on walls—and to keep the backs of chairs and other furniture from marring wall coverings. Typically, you'd run this molding horizontally, 32-36" above floor level. You'll need a 45° fence to make the second cut.

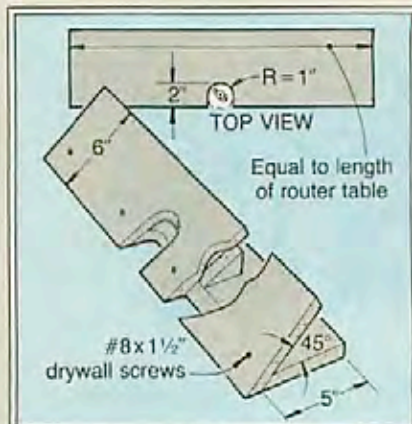

You'll need a 45° fence on your router table to make this molding. We made the one pictured here from 3/4" particleboard.

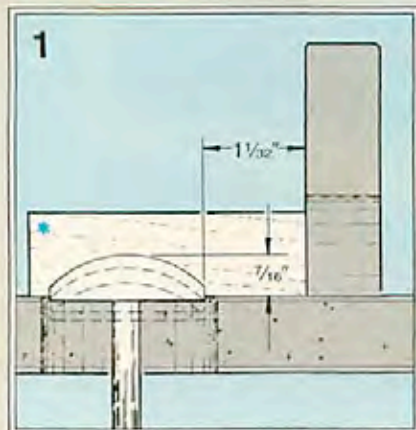

1 Use Sears 1" radius end-cover bit no. 25526. Start with 3/4"x2 3/4" stock. Make three passes.

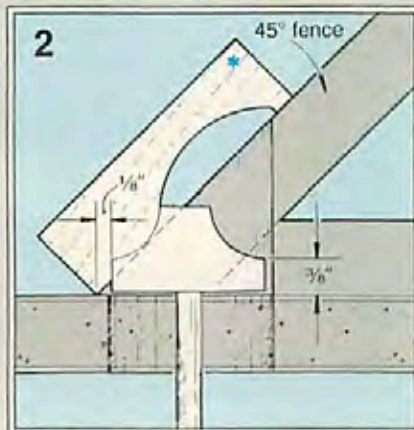

2 Use Sears 1/2" round-over bit without pilot. Switch to a 45° fence like the one shown in the drawing top right.

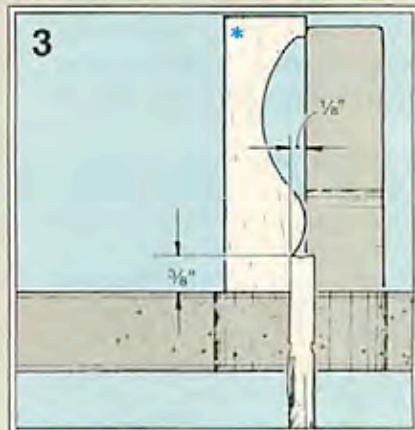

3 Switch back to a 90° fence. Use a 1/4" straight bit; align it to bottom edge of the radius made in step 2.

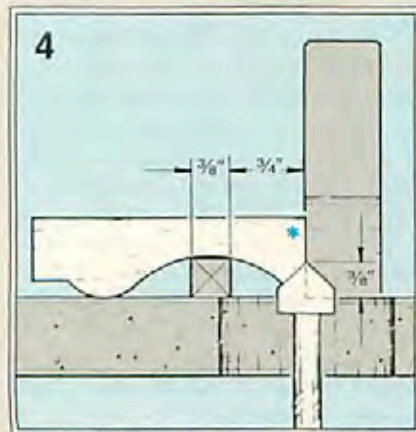

4 Attach a 7/16"x7/16" support strip to the table where shown. Chamfer edge with a 3/8" V-grooving bit.

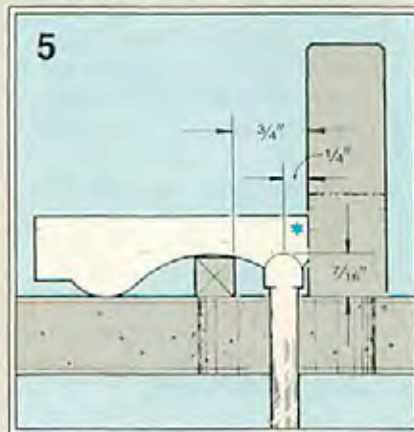

5 Leave support strip in the same position. Reposition fence and make cut with a 3/8" core box bit.

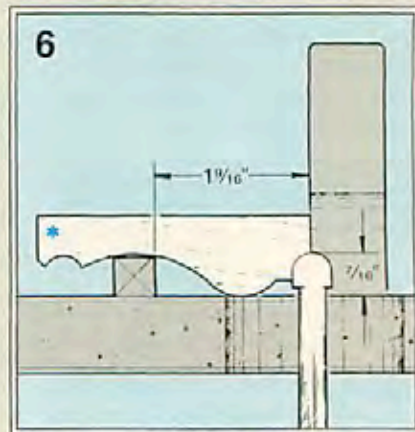

6 Flip piece end-for-end, reposition support strip and fence, and make cut with same bit used for step 5. ●

TRY OUR
STACK-MOLDING
TECHNIQUE FOR THIS

PORTRAIT- PERFECT PICTURE FRAME

Finding run-of-the-mill picture frames never seems to be a problem. But, if you want a truly unique frame that you can build yourself and size to meet your framing requirements, then we've got just the project for you.

Note: We machined each molding for our 25x33" frame from one long length (we used 12' stock). But you might find it easier to handle two shorter lengths instead. Either way, cut a piece of mahogany about 10" long and use it as a test piece before machining the long length.

To determine the total length of each molding needed, simply measure the perimeter (the total of the four sides) of the item you plan to frame; then add 2" to that figure to allow for miter cuts and waste. The Molding Length Chart below lists the figures for several common mat and print sizes.

MOLDING LENGTH CHART	
Common Mat and Print Sizes	Total Length of Molding Needed
8x10"	60"
11x14"	74"
12x16"	80"
16x20"	96"
18x24"	108"
20x24"	112"



HERE'S HOW TO SHAPE THE MAHOGANY MOLDING

1 Rip enough 1 3/8"-thick mahogany (we planed down 1 1/2" stock) to 1 1/4" wide for the outer frame parts (A). Crosscut to the length needed. (Refer to the note and the Molding Length Chart at left for help with this.)

2 Using carbon paper or a photocopy machine, transfer the full-size pattern of part A (see the Assembled-Frame Detail on the opposite page) to white paper or tablet-type cardboard. Cut the template to shape, and trace the profile onto both ends of the mahogany.

Note: Study the molding drawings carefully as you'll need to turn the mahogany several times when making the dado and router cuts. To help ensure starting the cuts on

the correct end, we marked an "A" on one end and a "B" on the opposite end.

3 Fasten a 1/2"-wide dado blade and an auxiliary wood fence to your table saw. Now, raise the dado blade 1/16" above the surface of the saw table. Using the setup shown on the Step 1 Drawing and a push stick for safety, cut a 1/8" rabbet 1/16" deep along one edge of the test strip. Check the cut against the S-marked profile; then make the cut along the mahogany piece starting at the end labeled "A." Reposition the blade and fence, and make a second rabbet cut where shown on the Step 2 Drawing.

4 Reposition the rip fence again, raise the dado blade, turn the mahogany end for end, and remove the excess material where shown on the Step 3 Drawing.

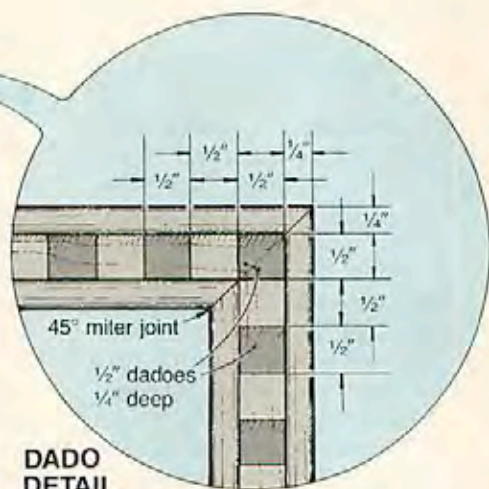
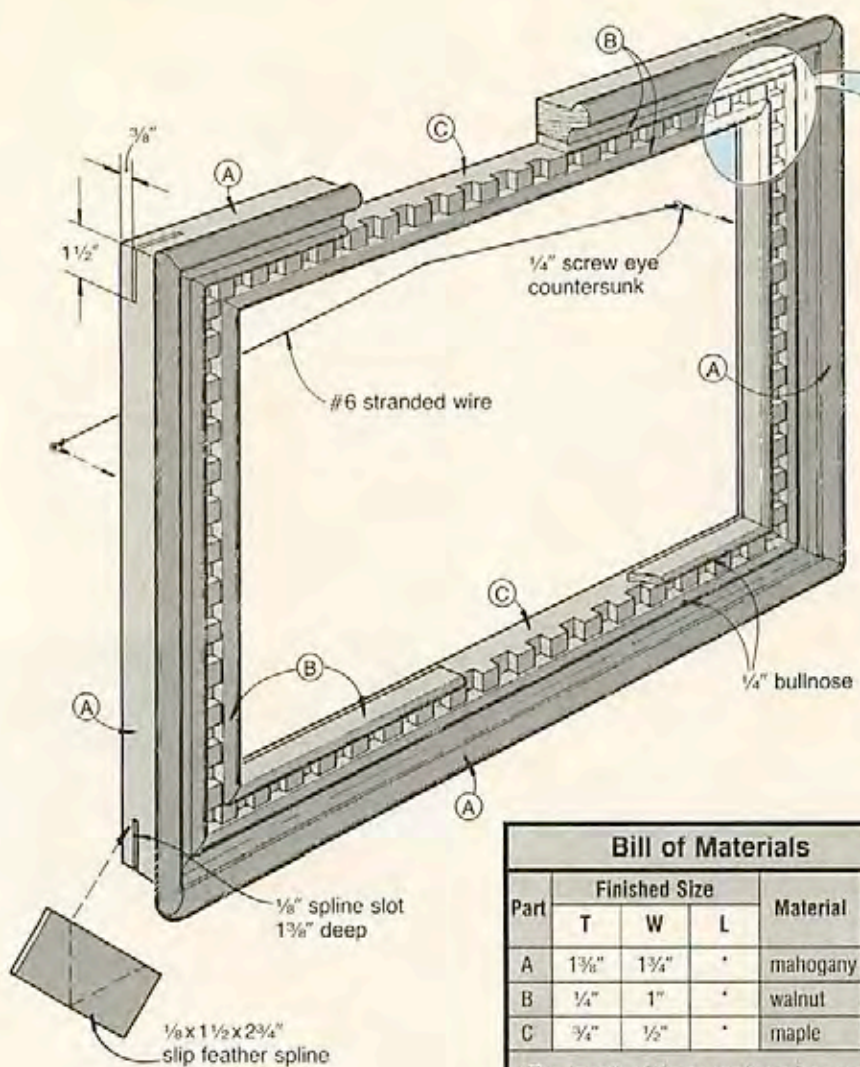

DADO DETAIL

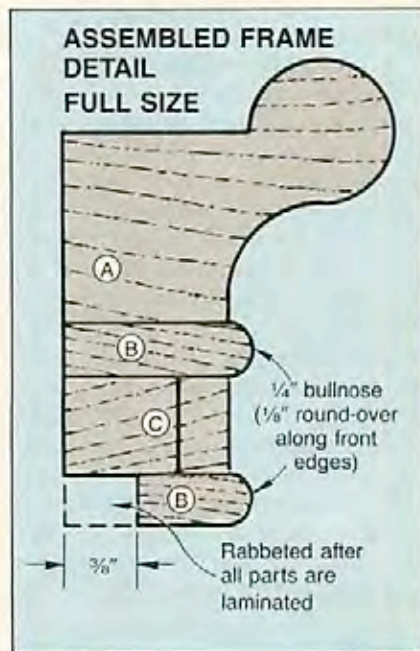

Bill of Materials					
Part	Finished Size			Material	Qty.
	T	W	L		
A	1 3/8"	1 3/4"	*	mahogany	4
B	1/4"	1"	*	walnut	8
C	3/4"	1/2"	*	maple	4

*The length of these parts varies, see the note at the beginning of the article.

Supplies: carbon paper, #6 stranded wire, 2—1/4" screw eyes, #0000 steel wool, finish

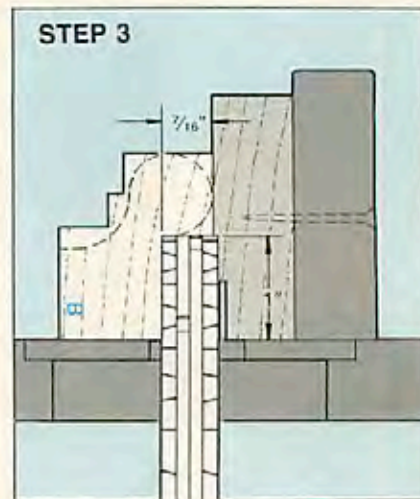
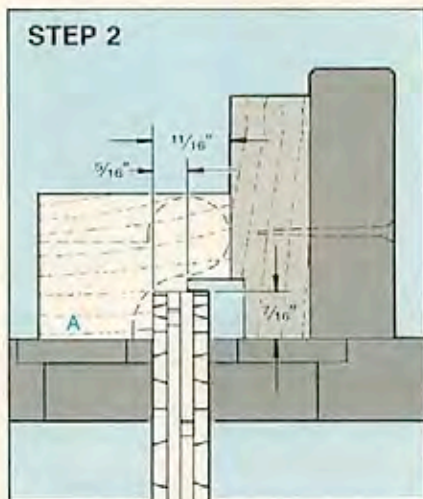
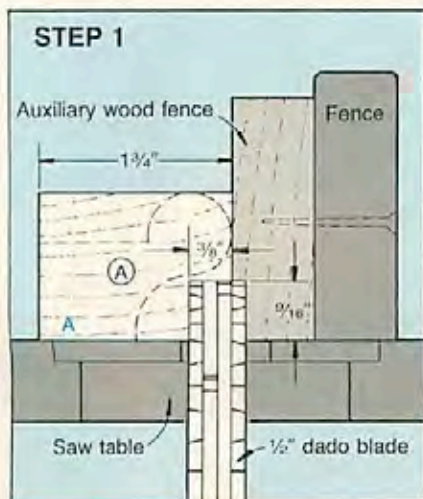

Continued

PICTURE FRAME

5 Cut a $\frac{1}{4} \times \frac{7}{16}$ " support block the same length as the router table. Using double-faced tape, adhere the support block to the router table where shown on the Step 4 Drawing below. The support block prevents the mahogany piece from falling onto the router bit and ruining the molding. Next, chuck a $\frac{3}{8}$ " bead/quarter-round bit (without the ball-bearing pilot) to a table-mounted router (see the Buying Guide for our source of router bits). With the end labeled "A" next to the bit, start the router, slowly push the mahogany stock into the bit, and rout a round-over along the inside edge of the molding where shown on the Step 4 Drawing.

6 Relocate the support block on the router table, and reposition the router fence. Turn the stock end-for-end so the end labeled "B" faces the bit, and round over the opposite edge of the mahogany stock where shown on the Step 5 Drawing.

7 Remove the support block from the router table. Using the Step 6 Drawing for reference, turn the stock end-for-end, and round over the rest of the outside edge.

8 Switch to a $\frac{1}{2}$ " cove bit (without the ball-bearing pilot), reposition the router table fence, and make several routing passes, raising the bit each pass until you reach a $\frac{3}{8}$ " height, to cove the area shown on the Step 7 Drawing.

NEXT, FORM THE WALNUT MOLDING

1 Resaw enough $1\frac{1}{16}$ " walnut for the $\frac{1}{4}$ "-thick molding (B). You'll need two strips the same length as the mahogany molding. Now, rip the walnut to 1" wide, and crosscut the two strips to the same length as the mahogany molding.

2 Chuck a $\frac{1}{8}$ " round-over bit (see the Buying Guide for our source) into the collet of your table-mounted router, and rout a round-over on the top and bottom of one edge of each strip to create a bull-nose. Sand the molding smooth.

AND NOW, THE MAPLE MOLDING

1 To form the dadoed molding (C), start by ripping a piece of $\frac{3}{4}$ "-thick maple to $\frac{1}{2}$ " wide. Crosscut it to the same length as the other moldings.

2 Lay out lines $\frac{1}{2}$ " apart the entire length of the maple strip. Attach a $\frac{1}{2}$ " dado blade to your radial arm saw, and cut the $\frac{1}{4}$ "-deep dadoes as shown in the photo at right. (We replaced the fence on our radial arm saw with a new one, and then cut through it with the dado blade. The $\frac{1}{2}$ "-wide kerf in the new fence makes it easy to accurately line up the dado lines with the blade and also prevents chip-out.) After cutting all the dadoes, sand the strip smooth.

IT'S TIME TO ASSEMBLE THE FRAME

1 Glue and clamp one of the walnut strips (B) to the mahogany (A), with the back edges flush (see the Assembled Frame Detail accompanying the Exploded-View Drawing on the previous page). Allow the glue to dry. (We used wood spacers between the clamp head and moldings to prevent marring the wood.) Later, glue and clamp the maple strip (C) to the walnut-mahogany lamination, with the back edges flush. (Use a sharp chisel to scrape away the excess glue from the dadoes before it dries. We found it is much harder to do this later after the glue had dried



Align the marked dado lines on the maple with the dado cut in the fence.

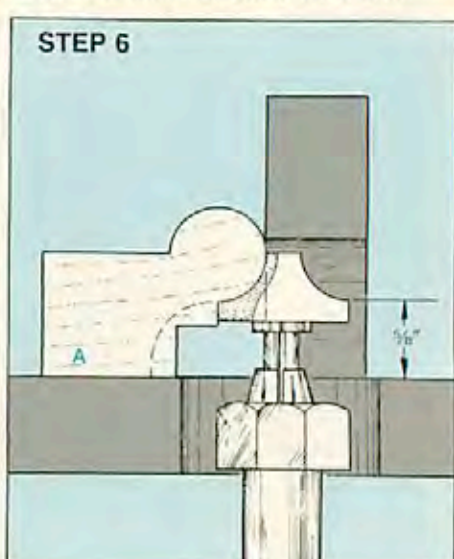
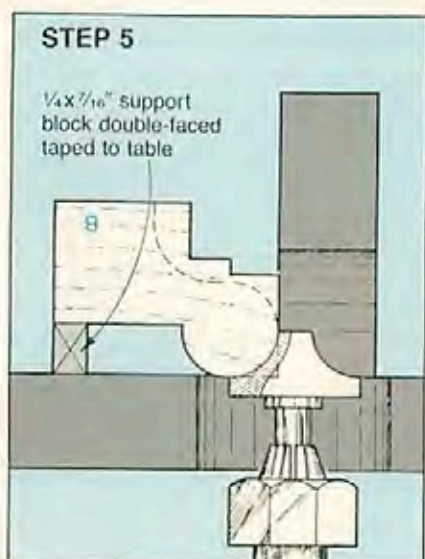
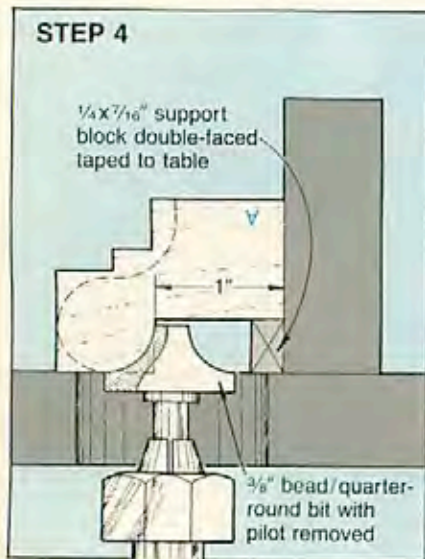

without scratching the wood.) Glue and clamp the remaining walnut strip (B) to the maple strip, with its back flush with that of the rest of the lamination.

2 Attach a $\frac{3}{8}$ " dado blade to your table saw arbor. With the end labeled "B" facing the blade, start the saw, and cut a $\frac{1}{4}$ " rabbet $\frac{3}{8}$ " deep along the back edge of the frame lamination where shown on the Step 8 Drawing.

3 Miter-cut the frame lamination to the lengths needed for the four frame sides. For perfectly matched corners when making the mitered cuts, cut at the corner of a maple square or dadoed gap where shown on the Dado Detail on page 51.

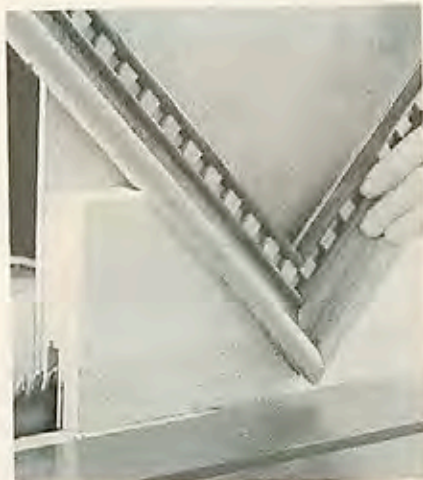

Use a V-block jig to cut the spline slot in each frame corner.

4 Checking for square, glue and clamp the four frame sides together. (We used a band clamp for this.)

5 Using a V-block jig (see the V-Block Jig Drawing if you don't have one), cut a $\frac{1}{8}$ " spline slot $1\frac{1}{8}$ " deep in each corner of the assembled frame as shown in the photo at left.

6 Cut four feather splines (we resawed walnut) to the size stated on the Exploded-View Drawing. Glue the walnut feather splines in the spline slots you just cut in each corner. Later, after the glue has dried, trim and sand the splines flush with the mahogany.

APPLYING THE FINISH

1 Apply two coats of sanding sealer, steel-wooling between coats. Be sure to remove all the steel wool, especially from between the dados before applying the next coat. (We used a vacuum cleaner with a brush attachment to clean the residual steel wool from the frame after each rub-down with steel wool.)

2 Apply two coats of finish (we used lacquer), again steel-wooling between coats. Mount your artwork.

3 To hang the frame, countersink two holes on the back side of the frame where shown on the Exploded-View Drawing (countersinking helps the frame hang flatter against the wall). Now, turn $\frac{1}{4}$ " screw eyes into each countersink. String #6 stranded wire from screw eye to screw eye. Hang in a deserving place.

BUYING GUIDE

• $\frac{1}{8}$ " round-over bit. Catalog no. TF34104/WD188, \$27.10 plus \$3.95 postage. Trendlines, 375 Beacham Street, Box 6447, Chelsea, MA 02150, or call 800/343-3248.

• Router bits and arbor set. $\frac{3}{8}$ " bead/quarter-round bit, catalog no. 9HT25562, \$5.49. $\frac{1}{2}$ " cove, catalog no. 9HT2557, \$5.49. Arbor set to be used with the bead/quarter-round and cove bits, catalog no. 9HT25601, \$4.69. Bits and arbor set available at Sears. ●

Project Design: James R. Downing
Photographs: Bob Calmer, William Hopkins
Illustrations: Kim Downing; Bill Zaun

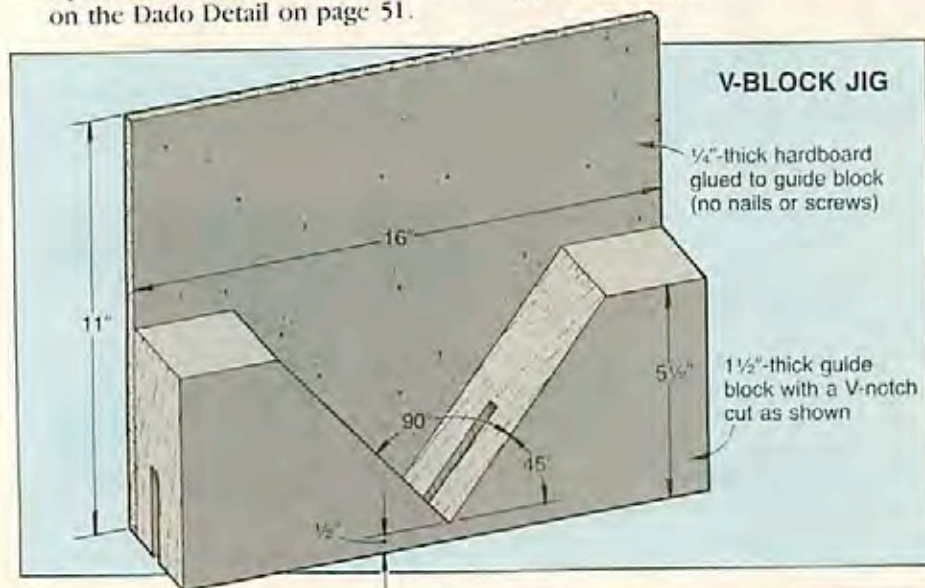

STEP 7

Make several passes to cut cove, raising the bit each pass

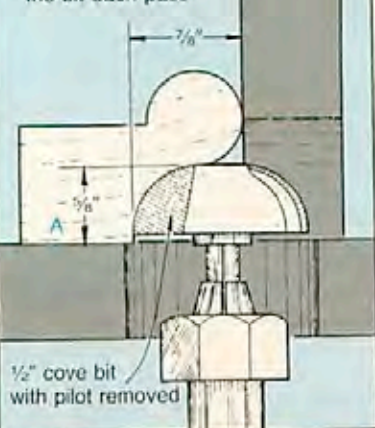

STEP 8

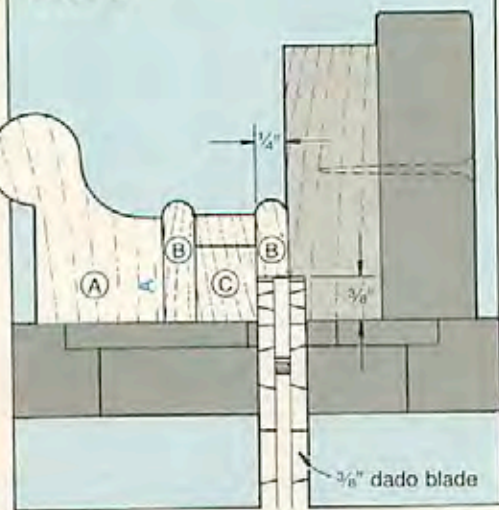

TURN SCRAP
STOCK INTO
SOMETHING
SPECIAL
WITH OUR

LAMINATED LETTER OPENER

Short on gifts but long on scrap? If so, you'll find our hardwood opener, with its interesting chevron-patterned handle, a real lifesaver. It's hard to believe that something so simple could be so elegant.

1 From $\frac{3}{4}$ " stock, cut the strips for the handle lamination (A, B, C, D) to the sizes listed in the Bill of Materials. (We specified 11" lengths for these pieces to allow for safety when miter-cutting the lamination. There's enough length to the lamination to cut handle pieces for several additional openers.)

2 Glue and clamp the strips together stair-step fashion in the sequence shown in the Handle Lamination Drawing on top of the opposite page. Keep the top edges of

all the strips flush when clamping. After the glue dries, remove the clamps, and scrape off the excess glue. Belt-sand the top and bottom surfaces smooth.

3 Position your radial arm saw blade to cut a 45° angle, and miter-cut one end of the lamination where shown on the Handle Lamination Drawing. Now, mark a stop line on the saw table to ensure consistent $\frac{1}{2}$ "-wide miter cuts (see the photo at right). Cut the number of handle strips desired.

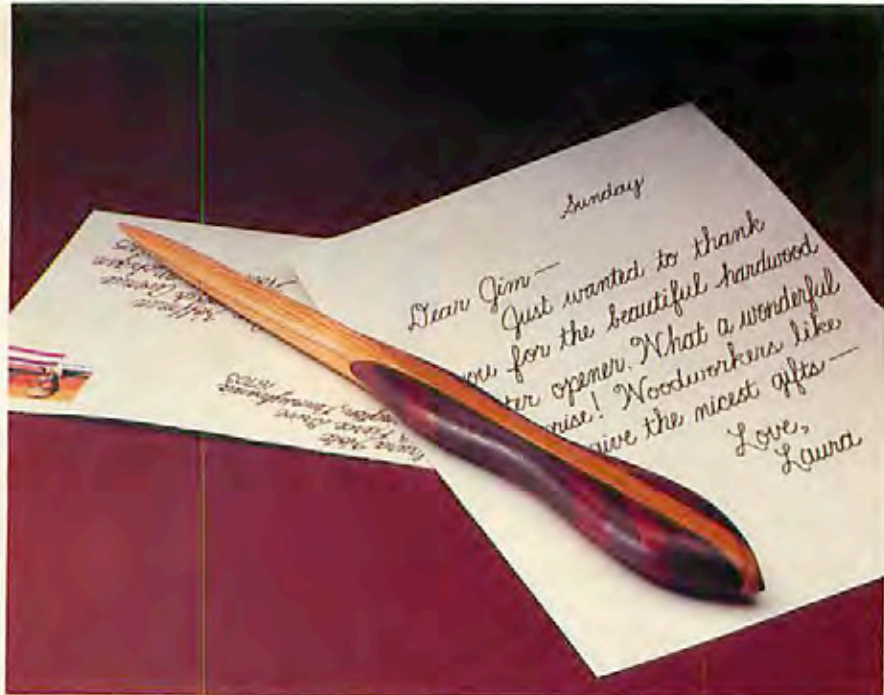

Mark a stop line on the table for consistent lamination lengths. Miter the handle pieces on the radial arm saw.

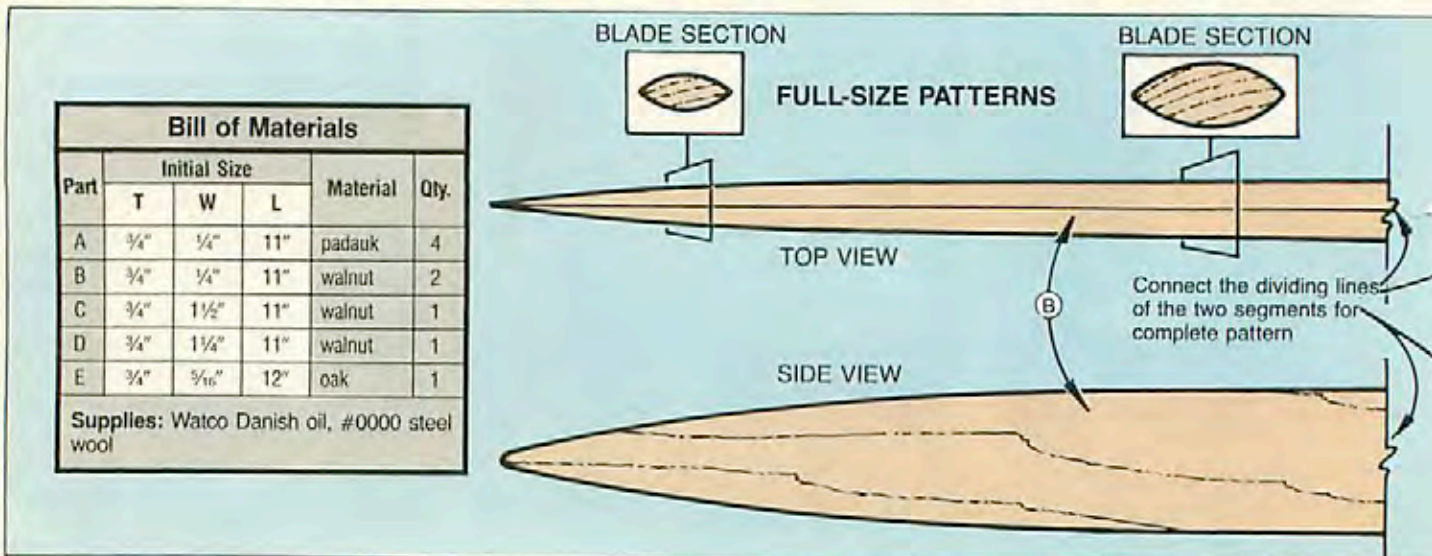

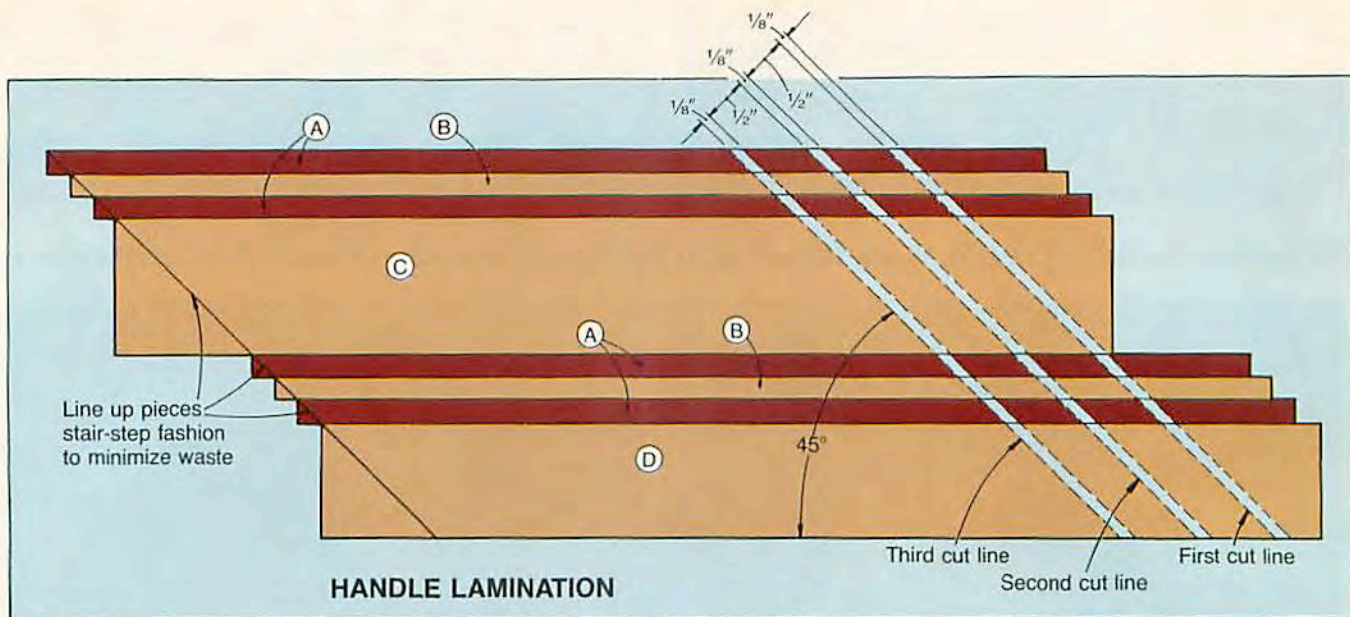

4 Cut the oak blade (E) to size.

5 Glue and clamp the handle pieces to the blade. Align the pieces so they create the pattern shown in the Full-Size Top View Drawing.

6 Using carbon paper, transfer the Top View of the handle and Side View of the blade to cardboard. (We used the back from a writing tablet.) Cut the cardboard templates to shape. Trace the handle outline onto the top of the handle and the blade outline onto the side of the oak blade. Cut the handle and blade to shape on a band saw as shown in the photo at right.

7 Rout a round-over on all edges of the handle, stopping where shown on the Full-Size Top View. (We used a $\frac{3}{8}$ " round-over bit chucked into our table-mounted router.)

8 Using the blade pattern on the Side View as a guide, sand the blade to shape (we used a belt sander; a drum sander would also work



Cut the letter opener handle and blade to shape on a band saw fitted with a fine-tooth blade.

well). When sanding, bevel both edges of the blade to the shape shown in the Blade Sections accompanying the Full-Size Top View. Sand a taper on the blade from the tip to the handle.

9 Finish-sand the completed letter opener.

10 Finish as desired. (We applied several coats of Watco Danish Oil, rubbing lightly between coats with #0000 steel wool.)

Note: After opening a few hundred letters, you may need to "sharpen" the blade. To do so, sand with a belt sander or drum sander, and then refinish the blade. 🌲

Project Design: Frank Nichols
Photographs: William Hopkins
Illustrations: Kim Downing; Bill Zaun

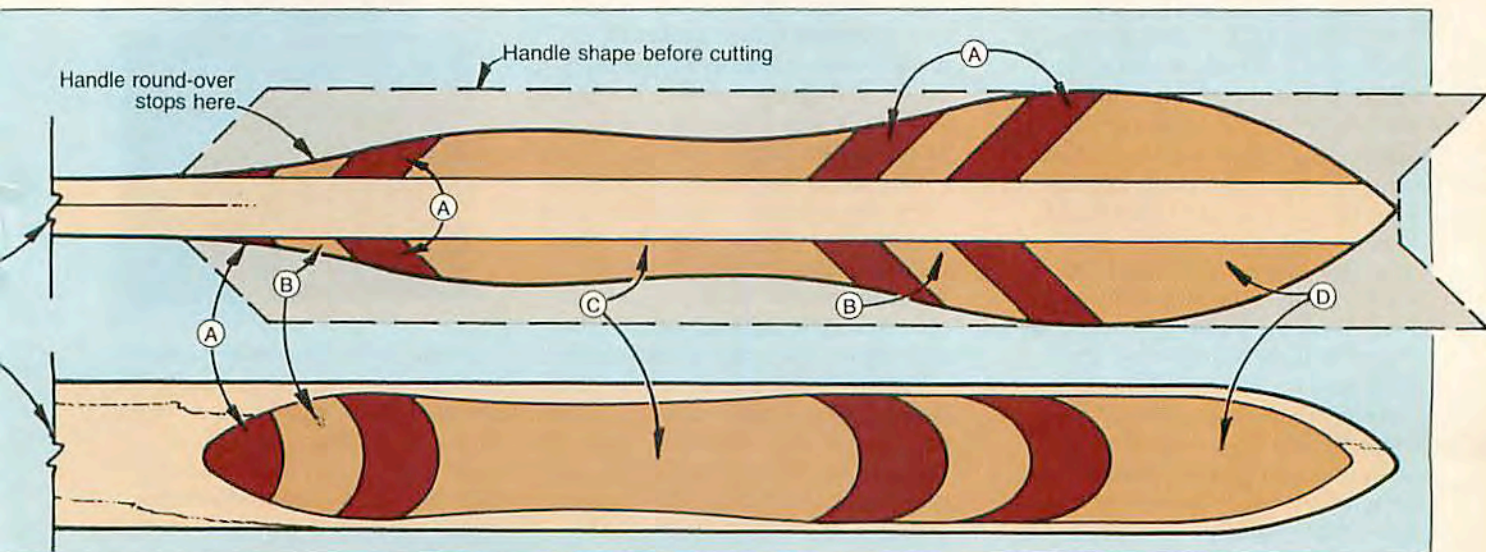

READERS,
IT'S YOUR
TURN!

PROJECT

Whether building replicas or functional projects, woodworkers demonstrate real

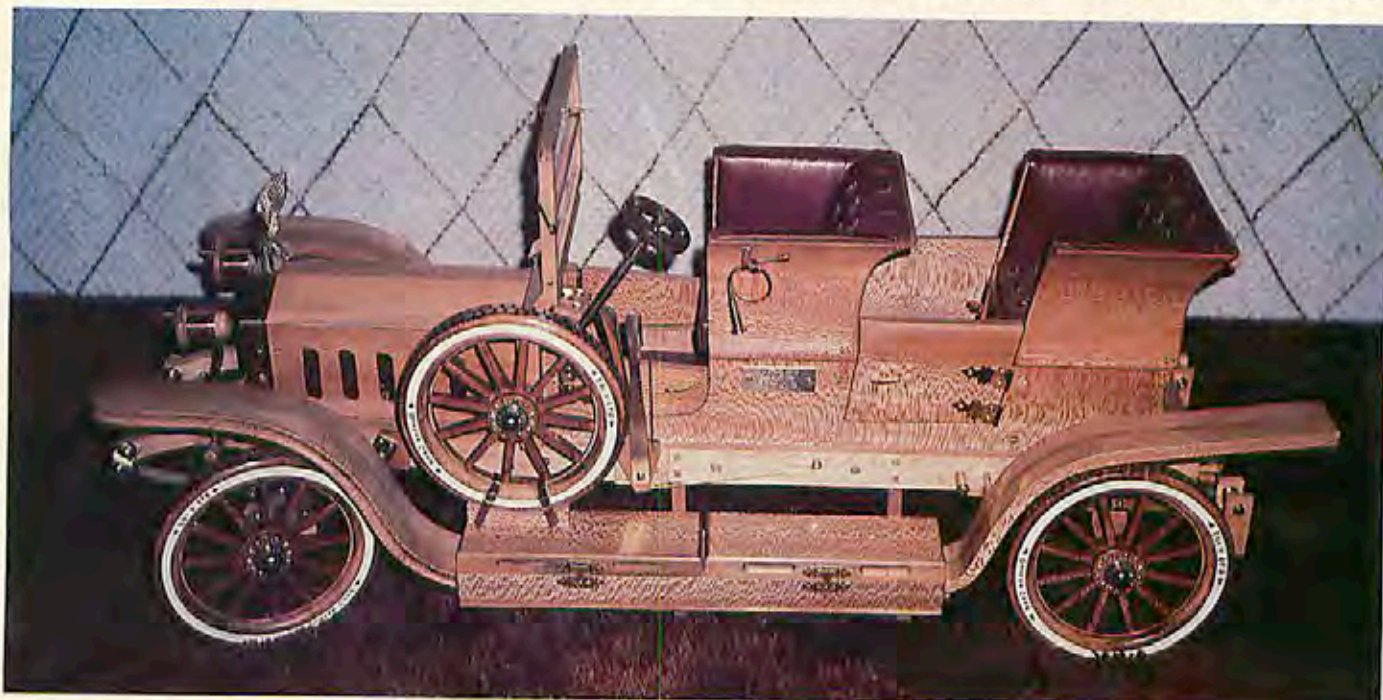

THE SYCAMORE SILVER GHOST

Vern Tschiegg, 62
Orville, Ohio

Mobile home park owner

Ghosts can lurk in a lumber pile. That's where Vern found the quarter-sawn sycamore for his classic Rolls Royce Silver Ghost.

"I made my model big enough (36x10½x12") so that people could really see the detail in the car, down to the rosettes tufted in the leather seats," Vern says. He admits the toughest job was constructing the seats without allowing end grain to show. He glued together three pieces of wood, cut them to shape with a hand saw, then "refined" the seat with rasps. Vern lined the running board tool chests with velvet because they hold jewelry instead of tools.

Tung oil and wax give the sycamore Silver Ghost the luster and protection it deserves. Meanwhile, Vern has already started a new project—replicating an old sailing ship.

SCORE ONE FOR AL

Al Price

Tulsa, Okla.

Manufacturer's representative,
part-time "award" maker

Al once carved Woody Hayes' name on a walnut football award. He did the same with Barry Switzer and Richard Nixon, too. A walnut tennis racket he made hangs in Jimmy Conner's home, and Bob Hope will never lose the 2'-tall walnut golf tee Al turned for him!

"My theory is to put the award back into awards," explains Al, who specializes in limited-edition, black walnut, regulation-size footballs. Whether memorializing a game or recognizing a lifetime's work, Al's awards are no casual remembrance.

Each football starts as four 2x8" boards of seasoned walnut. Al laminates them, then turns the stock cylindrical. He next carves the six pounds of featureless wood into a lifelike pigskin. After sanding the



ball and its walnut base, Al stains both to enhance the natural color. He uses paste wax and a machine buffer to get the silken finish.

Al, we have an idea for your next award: A mounted turning gouge with *your* name on it!

SHOWCASE

effort and ingenuity. Our caps are off to you!



WELL-SPENT HOURS

Wayne Cameron, 30
Saskatoon, Saskatchewan, Canada
Utility company operator

Gifts made for someone special seem to turn out special, too. The hourglass Wayne built for his mother shows how lovingly and well he put his spare hours to use.

Wayne says he chose *manio*, a wood from Chile, because its color ranges from yellows to browns and its grain changes from curly to straight. "And if you use a finish of clear oil, then wax, the color remains true," Wayne advises.



A COFFEE TABLE THAT SETS THE MOOD

Bruce Boyd, 35
Topeka, Kans.
State property officer

Some folks create a romantic mood by lighting candles. Bruce says he and his wife light up their life by "lighting" their coffee table.

Beneath the stained glass in the tabletop, this craftsman installed a fluorescent light in a 3"-deep box. The wiring runs through one of the 2x5" maple legs. The switch rests in an opening in the furnace grate framing the stained glass.

Bruce edge-joined and doweled

1/2x4" maple to surround and support the grate. A crisscrossed framework of maple 1x1s helps hold up the 30 pounds of iron.

Designed for easy disassembly, the 45x24x18" tabletop rests on cleats screwed into the 1x4" maple sides so it can be lifted up and out. Legs and side boards connect by unglued dowels.

Bruce applied three coats of polyurethane topped with paste wax for the shine. And we can only agree—Bruce's table sure beats candles!

The holes left in the top and bottom plates by the lathe face-plate screws were put to inventive use. Pegs now fit into the bored-out screw holes to secure the cap, which ends up as the "top" when the 9 1/2 x 4 1/2" hourglass is turned over and reset.

Wayne found the spindles tough to turn on his lathe. "I had to hold them so they wouldn't vibrate. And because many were so thin (1/16"), I ended up turning half a dozen to get four."

Wayne, your perseverance paid off. Your mother agrees. ♣

To submit your projects...

Send a 35-mm color slide *only* with the project as the focal point and a simple background. Include a capsule description—materials, joinery, finish, and dimensions. WOOD will pay \$25 for published projects. Slides cannot be returned unless you enclose a self-addressed, stamped envelope.

Project Showcase
Better Homes and Gardens®
WOOD® Magazine
Locust at 17th
Des Moines, IA 50336

WOODWORKERS' STANDARDS

BOOKCASES & SHELVES



Libraries make the most of every inch of shelf space. Careful calculations of book size and weight make it possible to store vast collections. When it's time for you to build storage at home, your audiovisual equipment, books, and collectibles demand no less attention.

Bookcases and shelves begin with planning, not only for stability and attractiveness, but because the size and spacing of your shelves will be determined by what you'll put on them. Down at your local library, for instance, the staff knows that every running foot of shelf space will hold 10-12 children's books, or seven fiction titles, or five medical books. For your home library, you may not need to be quite so exacting, but glancing at the chart below you'll see that all books and audiovisual equipment—for purposes of shelf spacing—aren't created equal.

ITEM	HEIGHT BETWEEN SHELVES	SHELF DEPTH
Children's books	8"	8"
Paperbacks	8"	10"
General reading	11"	12"
Large hardbound	15"	12"
Reference	10"	14"
Magazines	10-12"	14"
Records albums	13¼"	14"
Slide trays	9¾"	10"

If you plan to house your television, stereo, speakers, and other entertainment equipment in the same shelving unit, you'll need a shelf depth of from 18" to 20" for most systems and a height spacing made to order for your components. Videocassettes (about 1x9x6") and audiocassettes (½x3x4") can fit into custom or ready-made racks, either on shelves or in drawers. When shelving units accommodate audiovisual components as well as books, they often are in modular sections: a deeper one for the bulkier equipment, and side or top bookcase/display units.

THE GOAL: SAGLESS SPANS

For traditional, living-room-type storage, shelving options include glass, acrylic, and wood. Each type of material, however, has a span limit—the maximum distance it can span between supports without sagging or breaking under a load. Architects figure that books represent a load averaging 25 pounds per cubic foot. The chart *below* indicates the maximum, no-sag span limit (under load) of the most commonly used shelving materials.

MAXIMUM NO-SAG SPAN WITHOUT ADDITIONAL SUPPORT	
MATERIAL	MAXIMUM SPAN
3/4" plywood	36"
3/4" particleboard	28"
3/4" hardwood board*	48"
1/2" acrylic	22"
3/8" glass	18"

*wood species vary in rigidity

Most solid hardwood shelves are stiffer than plywood or other materials, but as noted above, this varies with the species. Here's how some common hardwoods stack up:

Stiff—aspen, alder, butternut, poplar

Stiffer—ash, cherry, mahogany, walnut

Stiffest—beech, birch, maple, oak, pecan

You can increase the stiffness of a wood shelf by sinking screws into the shelf through the solid back of the case. For more strength, attach a 1x2" cleat to the front of the shelf, or to the front and the back, as in

the drawing *below*. Or, you can build an amazingly strong, yet light-weight shelf called a *torsion box*. When constructed as shown *below*, a 1 1/2 x 12" torsion box shelf using oak-faced plywood has two-thirds less deflection under weight than 3/4 x 12" solid oak at one third-the cost.

ONLY DUST COLLECTS ON SHELVES YOU CAN'T REACH

In a hallway, mudroom, family room, or bedroom, shelves usually store more than books. This means that gloves, hats, boots, toys, and other frequently used items have to be within reach of family members. Follow these guidelines for easy-to-reach shelf heights:

AGE	SHELF HEIGHT MAXIMUM
Preschoolers	4'
Through third grade	4'3"
4th through 6th grades	4'7"
Young teens	5'1"
Adults	5'8"

PUTTING SHELVES IN THEIR PLACE PERMANENTLY

Permanently attaching shelves to the sides (vertical supports) adds strength and rigidity to a shelving unit or cabinet. The drawing, *right*, shows the most common methods. Wooden *cleats* attached to the vertical supports provide a resting place for shelving and are the easiest, but not always the most attractive solution. When glued and screwed to the shelf as well as the sides, cleats provide stout support.

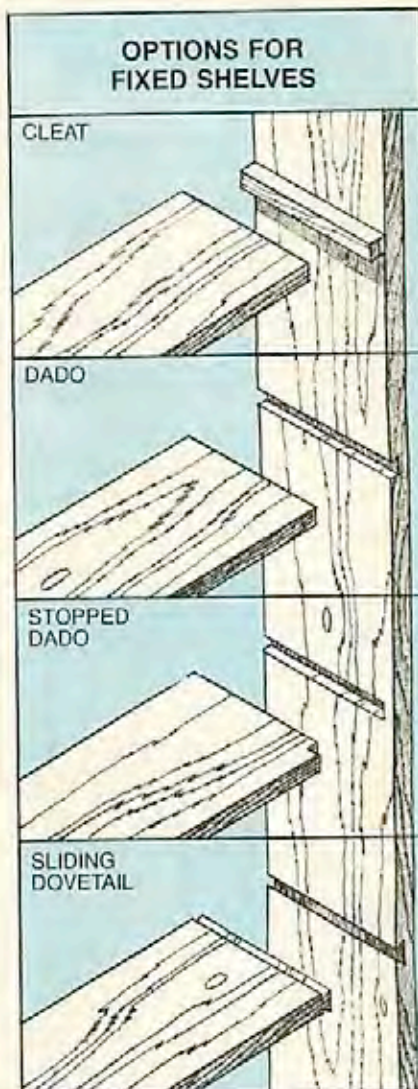

The *dado* offers a stronger, cleaner-looking alternative to the cleat. Tightly fitted and glued into the dado, the shelf unites with the wood all along the cut for tough support. Many woodworkers cover the exposed dado end with a strip of matching wood or veneer tape.

Going the dado one better, the *stopped dado* doesn't need to be concealed with veneer tape or a wood strip. However, cleaning out the dado and notching the shelf for a tight, no-rattle fit requires some skill and effort.

Choose *sliding dovetails* for truly decorative shelf support joints. Besides their attractiveness, sliding dovetails resist racking and provide the strongest joint because the shelf and the case side interlock.

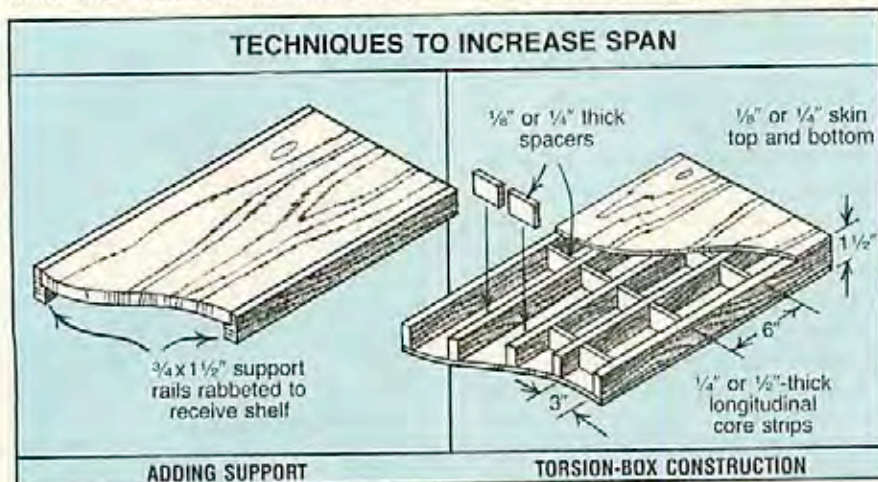

Continued

WHEN YOU CAN'T MAKE UP YOUR MIND

Adjustable shelves allow you to alter spacing to suit changing lifestyles and whims for display. As this option grows in popularity, new types of hardware continue to be developed. We show the basic alternatives for installing adjustable shelves *below*.

Eliminating the need for any hardware, the wooden *bar-and-notch* method has been used for at least a hundred years. Wedge-

shaped notches cut at regular intervals into 1x2s attached to the unit's sides accept wooden bars to support shelves. Note also that you must notch the corners of each shelf to fit against the sides. You won't be able to make small changes in shelf spacing, but for a refurbished antique or reproduction piece, the bar and notch system looks authentic.

Pin supports, made from metal or plastic, fit into 1/4" holes drilled in the sides of the unit. This method permits more flexibility in spacing, but requires super-accurate drilling for perfectly level shelves. Also, because of the L-shaped design of most pins, shelves won't butt tightly against the sides. Using hardwood dowels instead of pins eliminates these gaps, but unless you cut grooves in the bottom of the shelf to accommodate the dowels, this method appears rustic.

Metal and plastic *standards and clips* install easily and accurately. You can surface-mount the support strips on the case sides. To avoid space at the ends of the shelves recess the vertical strips in shallow dados.

A relatively new, practically invisible, shelf support from Sweden features a *spring steel clip*. To attach them, you saw a blind slot in the ends of each shelf to conceal the clip. The ends of the wire clip fit into 5/32" holes you drill in the shelf sides.

WRESTLING WITH RACK AND WOBBLE

Stand two boards on end, then fasten to them a top board and a bottom one, and you have the basic bookcase: two uprights and two shelves. You can use corner joinery such as the *rabbet* and the *dado*, detailed *above right*, to make strong, good-looking joints.

Installing fixed shelves helps stiffen the construction, but they won't necessarily eliminate wobble. Fastening the basic case to a wall

THE BASIC CASE

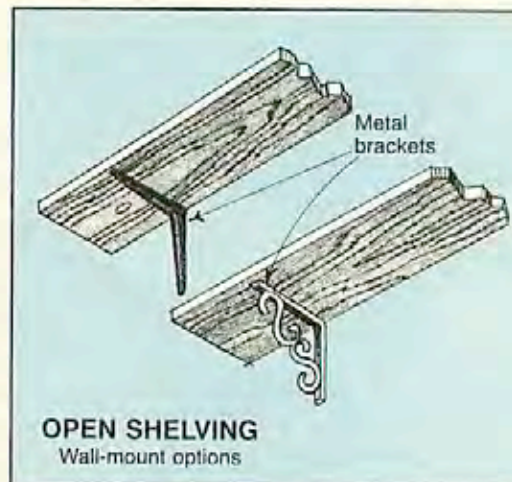
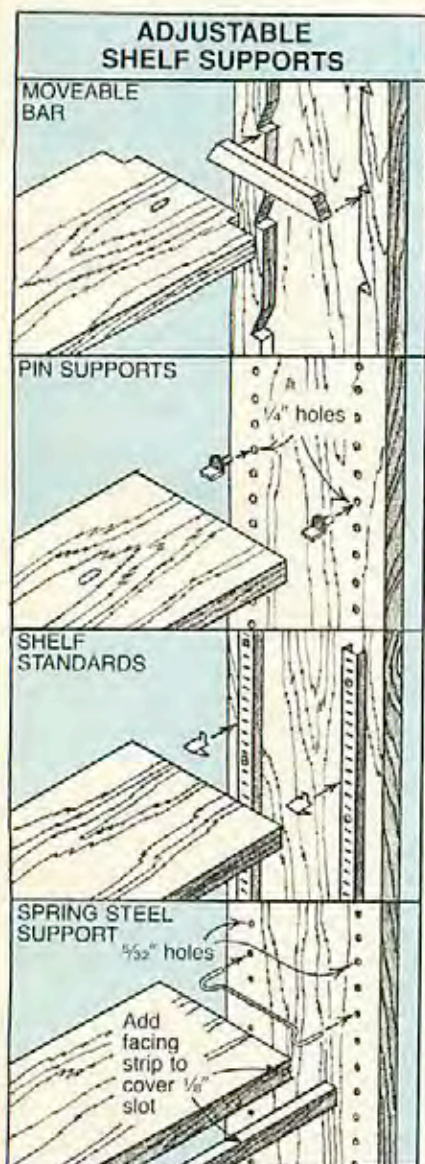
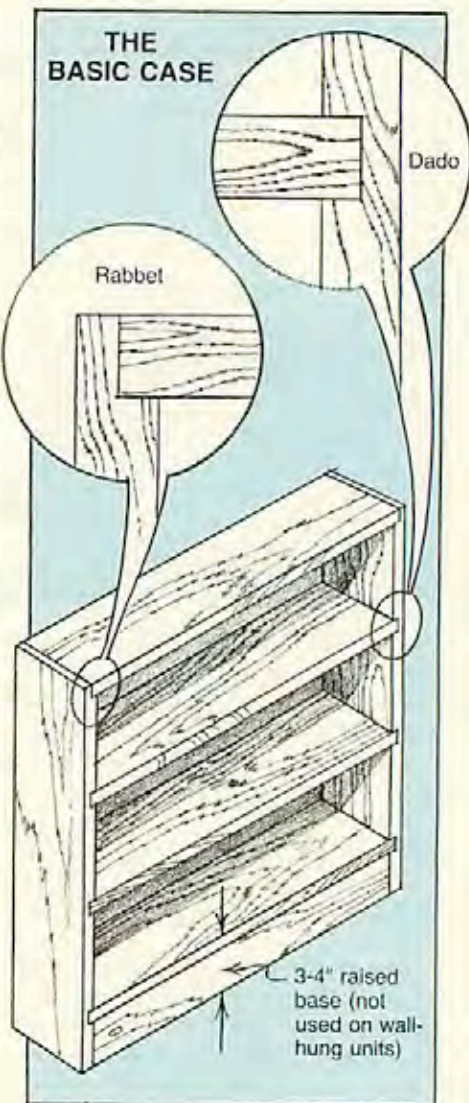

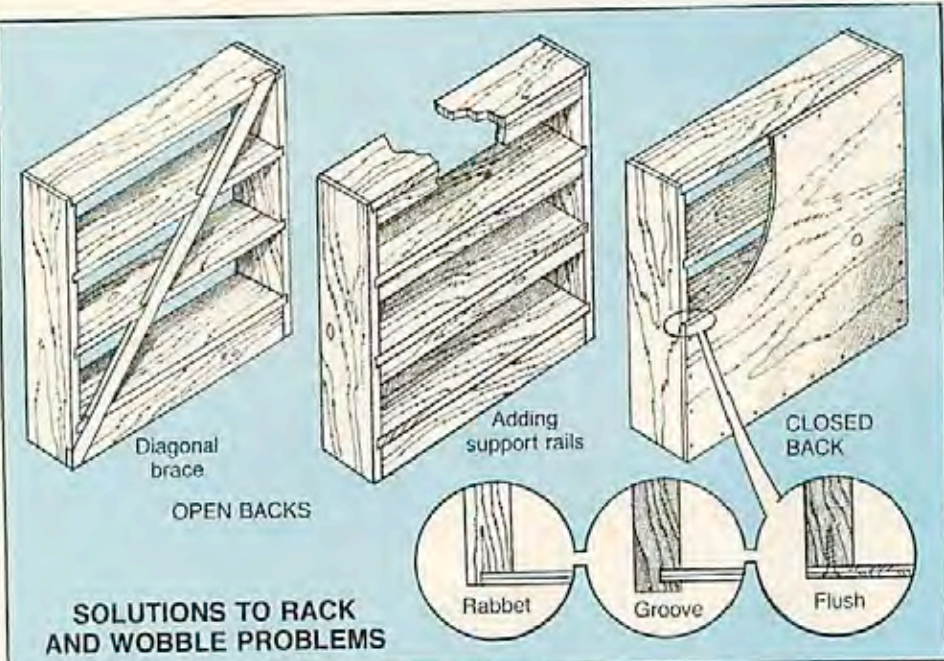

SOLUTIONS TO RACK AND WOBBLE PROBLEMS

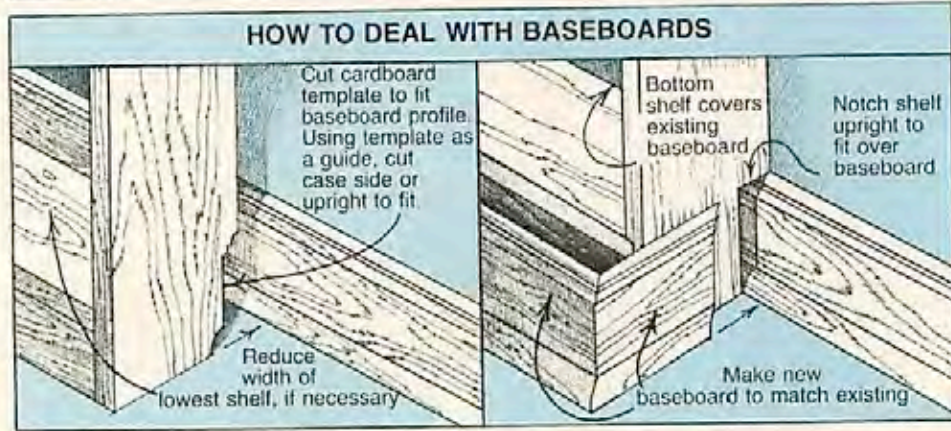

HOW TO DEAL WITH BASEBOARDS

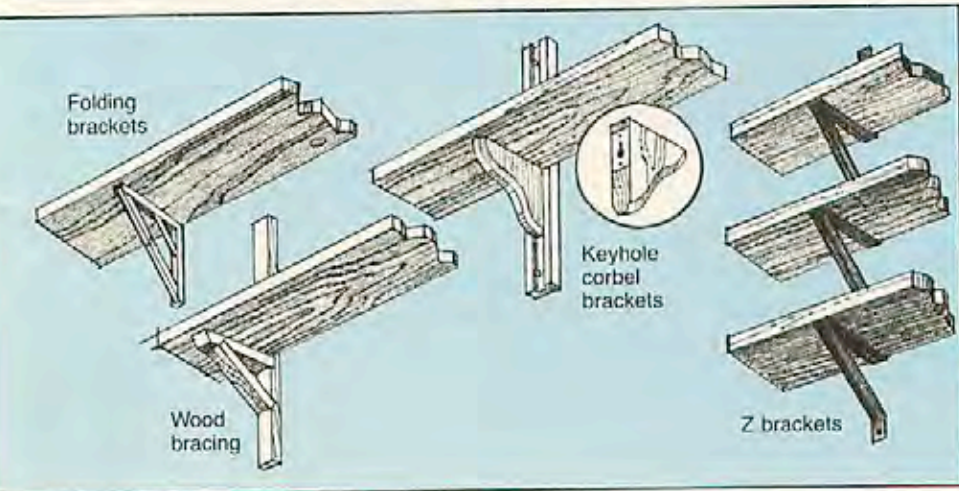

quickly sturdies it. A freestanding unit, however, calls for one of the solutions demonstrated at left. The simplest way to steady a wobbly case: the unattractive, but effective *diagonal brace*. For a better-looking alternative, attach *support rails* to the shelf bottoms and the case back.

Mounting a solid back *flush* to a case offers about the same stability as wall attachment, if you glue and screw the back to each member. Other back-joining options include the *rabbet* and the *groove*. To use this technique, cut a groove into both sides and the top and bottom. Then fit a plywood or hardboard back into the groove. A face frame added to the front of the case will also strengthen it.

A freestanding shelving unit poses another problem, especially in older homes: How do you set it tight against a wall when there's a baseboard molding? You'll find two solutions to the problem.

SHELVES IN A HURRY

Open shelving, often referred to as "utility" shelving because it dutifully fulfills the storage role in basement, laundry room, or garage, can dress up and look presentable for company, too. Use keyhole corbel brackets and those made to resemble wrought iron scrollwork for a more decorative look. These, as well as the other types of brackets, left, allow you to set up open shelving quickly, and change shelf spacing when the whim hits you.

If your open shelving system has to bear heavy loads, you'll have to attach the standards (or brackets alone, in some cases) to the wall with sturdy hardware, such as lag screws set directly into wall studs. Hollow-wall anchors and toggle bolts will handle only light loads in wallboard or plaster and lath. ♣

Written by Peter J. Stephano with James R. Downing
Illustrations: Bill Zaun
Photograph: Hopkins Associates

A PROJECT INSPIRED BY THE DEEP BLUE SEA

BAND-SAWN SCALLOP BOXES



When we saw our first band-sawn boxes at a crafts fair about three years ago, we were amazed. How could a single piece of wood and a band saw yield projects of such beauty? Actually, as we found out, they're much easier to make than you might imagine.

With our tidal wave of accompanying photos, you'll have no difficulty crafting the scallop boxes shown above on your band saw. These little treasure chests work great for housing anything from a string of pearls at home to paper clips at the office.

CUTTING AND SHAPING THE BOX PARTS

1 Start by cutting a block of wood to $2\frac{1}{4}$ " high by 4" wide by 6" long, or laminate thinner stock to size. Sand the top and bottom of the block smooth. (The stock for two of our boxes came from the firewood pile.)

2 Using carbon paper or a photocopy machine, transfer the Full-Size Top View Pattern located on page 65 to a piece of paper. Cut the paper pattern to shape, making sure you don't cut away any of the exterior pattern lines. Apply spray adhesive to the back of the pattern; then adhere it to the top of the wood block.

3 Fit your band saw with a $\frac{1}{8}$ " blade. (This fine-toothed blade makes cutting the curves a snap.) Make a series of relief cuts where shown in photo A below. Then, cut the box exterior to shape, cutting just outside the marked line. Sand the sawn sides smooth.

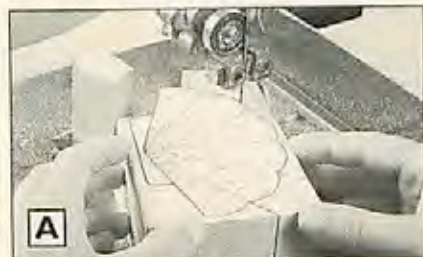

Cut slightly outside the marked perimeter line to cut box to shape.

4 Position the fence on your band saw $\frac{1}{16}$ " away from the *inside* edge of the blade. Now, *slowly* and *carefully* slice $\frac{1}{16}$ " off the top face of the block for the lid and $\frac{1}{16}$ " off the bottom face for the base (see photo B below).



With the fence for support, cut the lid and then the base from the box.

5 Cut the lid to finished shape as shown in photo C. Sand the two edges you just cut.

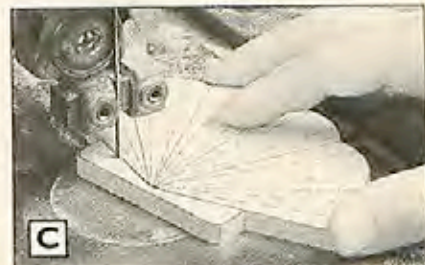

Follow the marked lines to cut the lid to finished shape on the band saw.

Continued

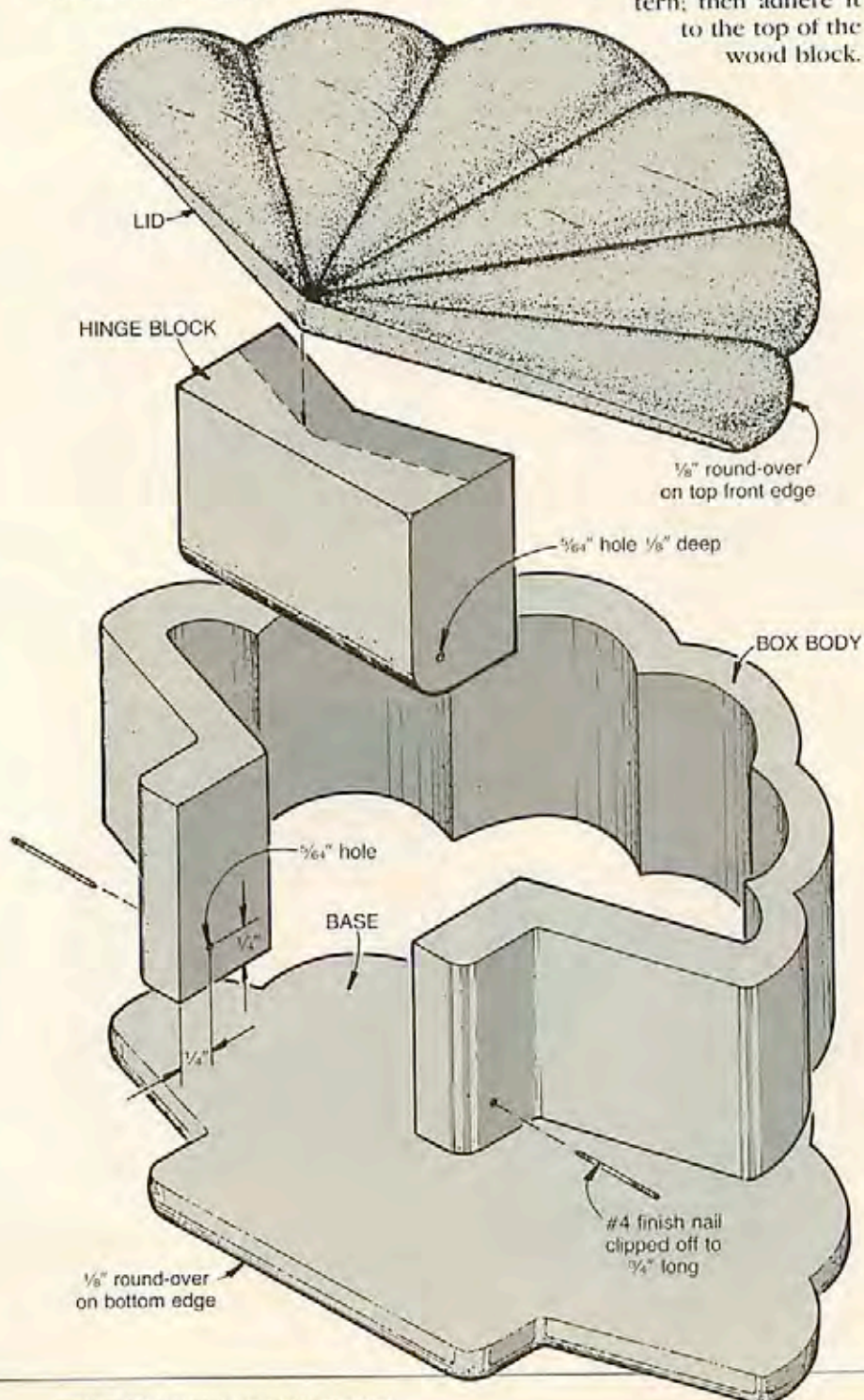

BAND-SAWN BOXES

6 Set the box lid aside for now. Then, using the Full-Size Body Pattern on the *bottom* of the opposite page as reference, transfer the straight and scalloped lines to the box body (see photo D).



Use a compass and sharp pencil to mark the box's curved interior lines.

7 Carefully cut along the *inside* edge of the line just drawn on the box body, following the route shown in photo E. *Save* the small wedge-shaped cutout; you'll use it later for the lid hinge.

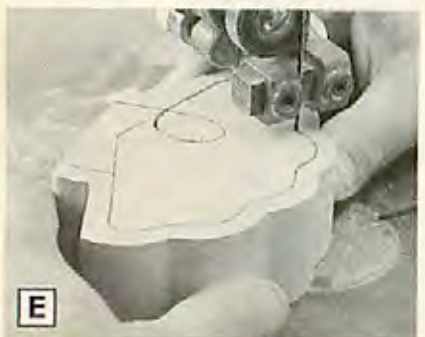

Slowly and carefully follow the marked lines to cut the box's interior to shape.

8 To sand the interior curved areas of the box body, wrap 100-grit sandpaper around lengths of $\frac{3}{8}$ "- and $\frac{1}{4}$ "-diameter dowels (see photo F). Sand the other interior surfaces smooth, too.

9 Sand the *top* face of the base smooth. (To keep the base flat while sanding, we taped a full sheet of 100-, and later 150-grit, sandpaper to a flat surface and moved the base back and forth evenly on the sandpaper.)

10 To glue the base onto the box body, start by clamping the hinge block (no glue) back into its original position as shown in photo G (the hinge block serves only as a spacer at this point). To prevent the hinge block from being too tight when installed later, place thick paper or thin cardboard spacers between the hinge block ends and the box body where shown in the photo. Cover the bottom face of the hinge block with tape to prevent it from being glued to the base. Finally, glue the base to the box body. After the glue dries, remove the clamps and the hinge block. Sand the edges of the base flush with the outside edges of the box body.

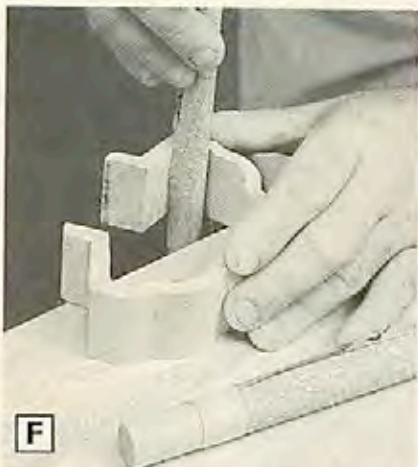

Wrap sandpaper around a dowel to sand the interior curves smooth.



Hand screws make clamping the base back onto the box body easy.

"SCULPTING" THE BOX LID

1 Using double-faced tape, tape the lid (pattern side up) to the corner of the workbench top. Then, cut kerfs through the paper pattern and into the lid as shown in photo H *below*. (We used a dovetail saw; a backsaw also will work.) The kerfs should be $\frac{1}{8}$ " deep at the front of the lid and barely scratch the surface at the hinge end. (We used a combination square to mark the $\frac{1}{8}$ " kerf depths on the front edge of the lid.)

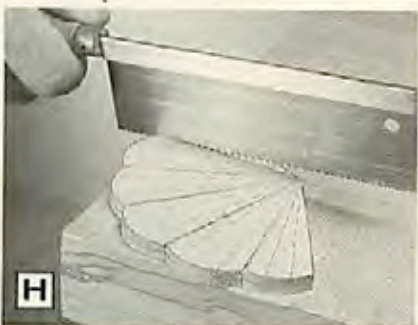

Cut angled kerfs with a fine-toothed saw at the marked lines.

2 With a sharp $1\frac{1}{4}$ " chisel, make paring cuts starting at the marked chisel lines and ending at the kerf as shown in photo I.



Sculpt the lid top to rough shape with a sharp $1\frac{1}{4}$ " chisel.

3 Sand the chiseled surfaces smooth, forming a round-over like that shown in the opening photograph.

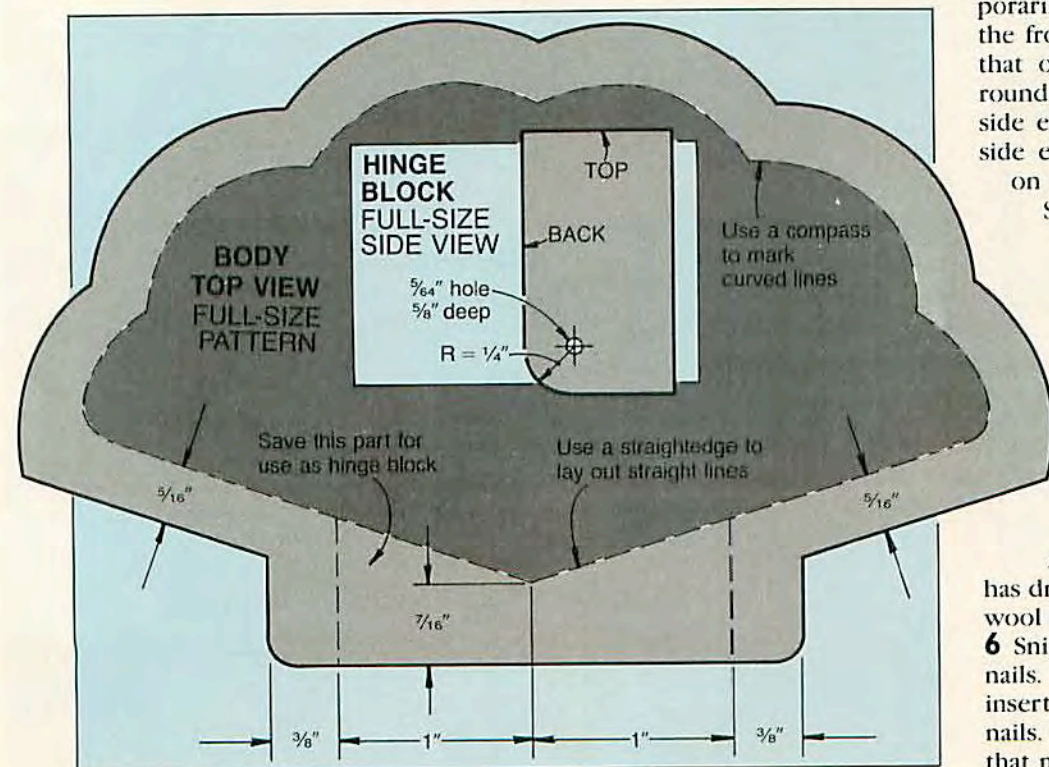
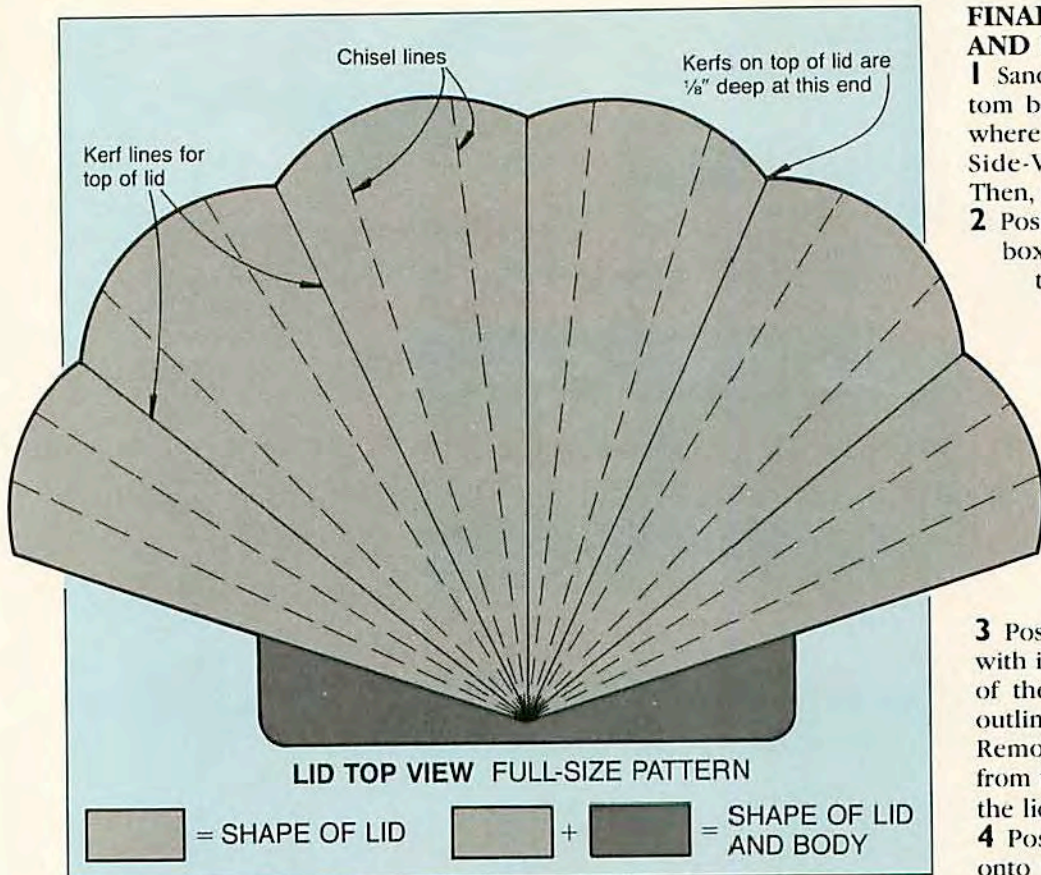

FINAL ASSEMBLY AND FITTING

- 1 Sand a $\frac{1}{4}$ " round-over on the bottom back edge of the hinge block where shown on the Hinge Block Side-View Drawing, *below left*. Then, sand the hinge block smooth.
- 2 Position the hinge block in the box body, centering it from side to side and flush with the top and back edges (we used paper spacers to center and hold it in position). Drill a $\frac{5}{64}$ " hole on each side of the box body $\frac{5}{8}$ " deep into the hinge block where shown on the Exploded-View Drawing on page 63, and temporarily insert the #4 finish nails.
- 3 Position the lid on the box body with its back edges flush with those of the box. Mark the lid location outline on top of the hinge block. Remove the lid and hinge block from the box body. Glue and clamp the lid to the hinge where marked.
- 4 Position the lid assembly back onto the box body, and again temporarily insert the hinge nails. Sand the front edge of the lid flush with that of the box body. Sand a $\frac{1}{8}$ " round-over along the bottom outside edge of the base and top outside edge of the lid where shown on the Exploded-View Drawing. Sand the base and lid. (We sanded with progressively finer [100- to 320-grit] sandpaper.) Remove the lid assembly from the box body.
- 5 Apply the finish to the box body and lid assembly (we sprayed on three coats of lacquer). Rub the surface with #0000 steel wool between coats. After the final coat of lacquer has dried, rub the surface with steel wool loaded with finishing wax.
- 6 Snip the heads off the two hinge nails. Position the lid on the base, insert the hinge nails, and set both nails. Fill the nail holes with a putty that matches the wood's color. 🌲

Produced by Marlen Kemmet Project Design: James R. Downing Photographs: Bob Calmer; William Hopkins Illustrations: Bill Zaun



OUR RENDITION OF A WOODWORKING CLASSIC

THE BARRISTER'S BOOKCASE

Note: The instructions explain how to make the components for one cabinet, one cabinet door, one base, and one top. The Bill of Materials on page 69 also gives the number of pieces for a single cabinet, door, base, and top. If you plan to make more than one cabinet, we suggest you cut all identical pieces at the same time to ensure uniformity.

FIRST, BUILD THE CABINET FRAMES

1 Cut the back, end, and bottom frames members (A-F) to the sizes listed in the Bill of Materials. (We ripped all the stock for parts A through F at the same time.)

2 Attach a $\frac{1}{4}$ " dado blade to the table saw arbor. Raise the blade $\frac{3}{8}$ " above the surface of the saw table. Cut a $\frac{1}{4}$ " groove in the center of *one* edge the length of each back frame member (A, B) and each side frame member (C, D) as shown in the photo at *right*. (We first test-cut the $\frac{1}{4}$ " groove in scrap stock the same thickness as the rails and stiles until we had the groove accurately centered. Also use the scrap stock to verify that the dado blade is set at the correct height ($\frac{3}{8}$ ") before cutting the actual cabinet frame members.)

3 To cut the stub tenons on the ends of parts B and D, position the auxiliary wood fence (attached to your rip fence) $\frac{3}{8}$ " from the outside edge of the dado blade as shown in the photo at *right*. Position the blade so it is $\frac{1}{4}$ " above the surface of the saw table. Now, using a miter gauge for support, cut the rabbets on both faces of each end of the parts as dimensioned on the Stub Tenon Detail on the Cabinet Drawing on page 68. Again, test-cut scrap stock first, and check the fit of the tenon in the $\frac{1}{4}$ "-wide groove.

Long ago, attorneys serving in England's Superior Court became known as barristers. And like all good lawyers, these chaps had an ever-increasing need for practical, yet attractive book storage. Their solution: the barrister's bookcase.

Like the originals, you can stack our version, too. Build one or two cabinets now, and add more cabinets as your storage needs expand.

And, don't forget our matching file cabinet on page 72. The two make a terrific duo.



Cut the $\frac{3}{8}$ "-deep groove with a $\frac{1}{4}$ " dado blade on the table saw.



Use a miter gauge and auxiliary wood fence when cutting the stub tenons.

4 Cut the back panel (G), the two end panels (H), and the bottom panel (I) to size from $\frac{1}{4}$ " oak plywood. (After cutting the plywood panels to the sizes stated in the Bill of Materials, we trimmed the back and end panel a fraction. This makes for a slightly loose fit of the panel in the frame, and allows for expansion of the frame members. Too tight a fit might force the frame-member joints to separate later.) Next, dry-clamp the side and back frames with the plywood panels in place to check the fit. Glue and clamp the end and back frames together, checking each frame for square. (To prevent the plywood panels from rattling in the frames, we used silicone sealant to hold them in place.)

5 For the bottom frame, dry-clamp parts E and F together. Mark the dowel hole center points where dimensioned on the Rabbet and Hole Detail accompanying the Cabinet Drawing. Remove the clamps, and drill $\frac{3}{8}$ " holes $1\frac{1}{16}$ " deep in the mating parts where marked. (We used a doweling jig when drilling the holes and dowel centers to transfer the hole locations to the mating parts.) Using $\frac{3}{8}$ " dowel pins 2" long, glue and clamp the bottom frame together, checking for square.

6 Sand the top face of the bottom frame smooth. Using a $\frac{3}{8}$ " rabbet bit, rout a rabbet $\frac{1}{4}$ " deep along the top inside edge of the bottom frame. Square the round corners with a chisel. Glue and clamp the bottom plywood panel (I) in the bottom rabbeted frame. Wipe off any excess glue immediately with a damp cloth.

7 Finish-sand all four frames, being careful not to sand through the thin oak-veneer surface.

Continued

BARRISTER'S BOOKCASE

ASSEMBLING THE FRAMES TO FORM THE CABINET

1 Using the Router Template Drawing at right as a guide, cut the router template to rectangular size (7x16") from 1/4" stock. (We cut ours to size from a scrap piece of 1/4" hardboard.) Now, carefully lay out, mark, and cut the 1 1/2 x 11 1/16" notch along the bottom edge of the 1/4" stock.

2 Fit your router base with a 3/8" bushing and a 3/8" straight bit. (Our bushing was too long, so we cut it with a hacksaw until it protruded a fraction less than 1/4" below the surface of the router base.) Clamp the template to the top of an end frame with the top and front edges flush where shown on the Router Template

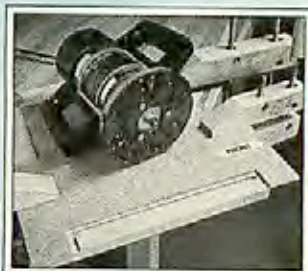
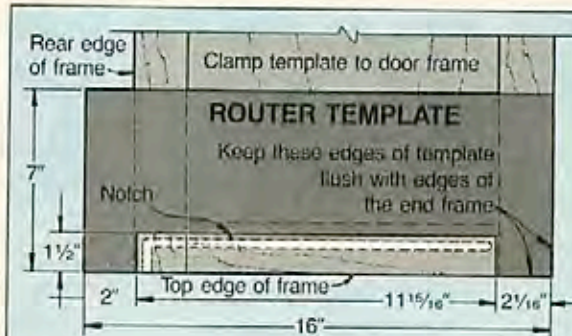

Template with a routed groove in an end frame.

Note: The hinge pin grooves in the end frames must be a mirror image of each other. Lay the frames side by side as shown at left so you don't rout the grooves in the same position on each.

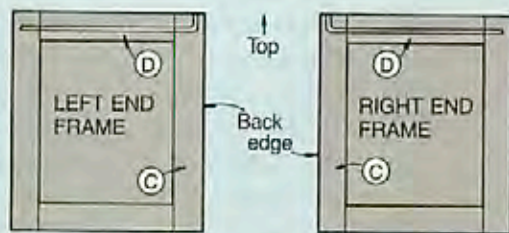

STUB TENON DETAIL

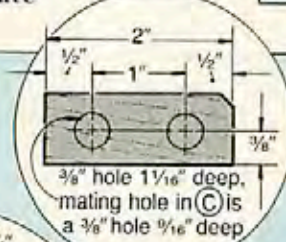

3/8" hole 1 1/16" deep, mating hole in (C) is a 3/8" hole 3/16" deep

Cutting Diagram



3/4 x 9 1/4 x 72" Oak

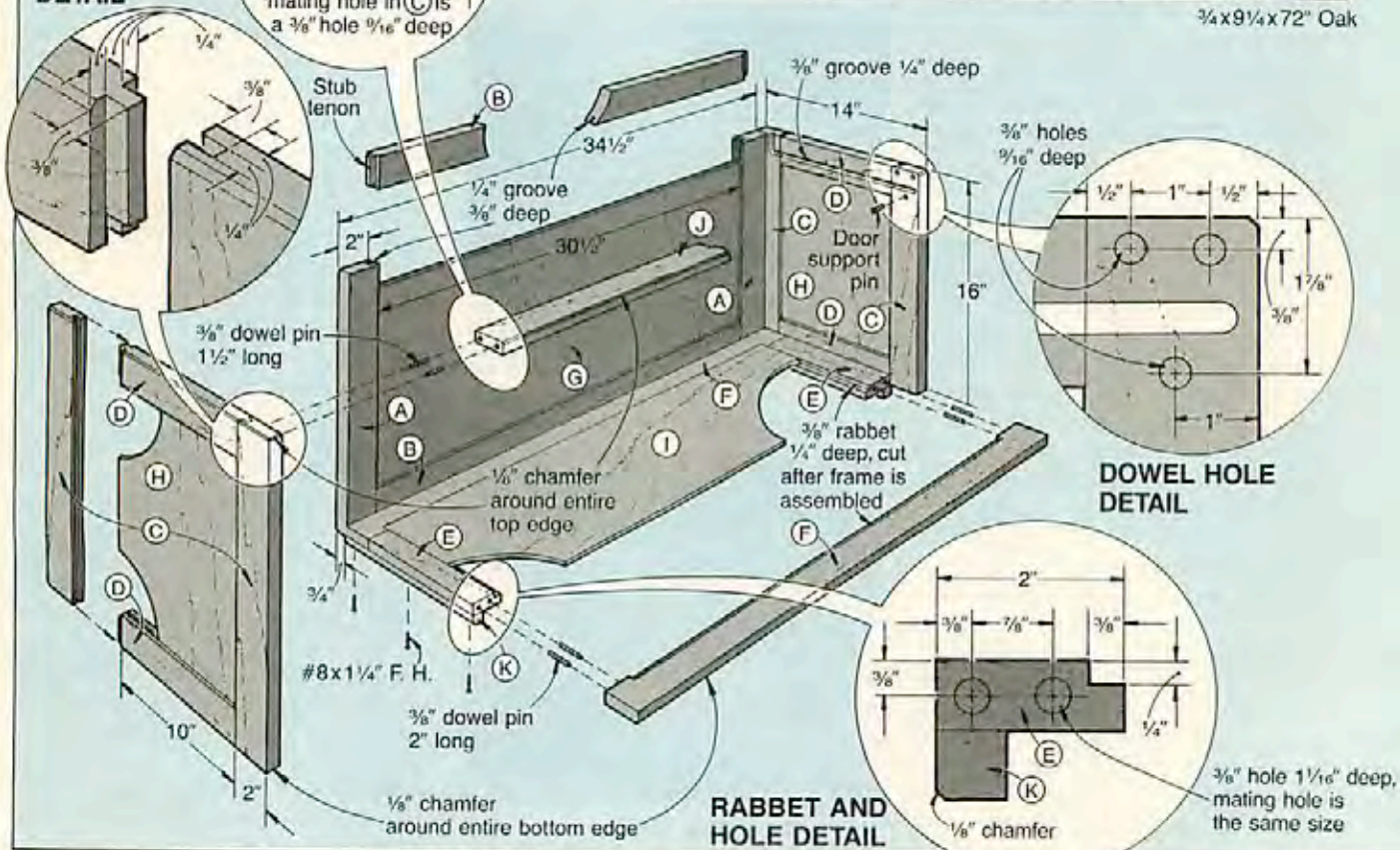

Drawing and as shown in the photo at left. Then, rout a $\frac{3}{8}$ " groove $\frac{1}{4}$ " deep. Repeat this procedure for the other end frame.

3 Cut the cabinet's front rail (J) to size from $\frac{3}{4}$ " oak stock.

4 Using the Dowel Hole Detail on the Cabinet Drawing as a guide, lay out and drill three $\frac{3}{8}$ " holes $\frac{3}{16}$ " deep in the upper front corner of each end frame.

5 Now, using the dimensions on the Cabinet Drawing, lay out and drill a pair of $\frac{3}{8}$ " holes $1\frac{1}{16}$ " deep in each end of the front rail (J). (If you have them, you could use a pair of $\frac{3}{8}$ " dowel centers to transfer the hole positions to the ends of the front rail.)

6 Using the Cabinet Drawing as a guide, glue and clamp the back

frame to the bottom frame, checking for square. Keep the bottom edge of the back frame flush with the bottom face of the bottom frame. Wipe off any excess glue with a damp cloth.

7 Glue two $\frac{3}{8}$ " x $1\frac{1}{2}$ " dowel pins in the holes in each end of the front rail (J). Aligning the bottom edges of the end frames flush with the bottom face of the bottom frame, glue and clamp the end frames and front rail to the back-bottom frame assembly. Check for square. Wipe off any excess glue with a damp cloth, or scrape it off after it forms a tough skin.

8 Cut two $\frac{3}{8}$ " dowels 1" long. Glue one dowel in the remaining hole on each end frame where shown on the Cabinet Drawing. (These pins

support the door horizontally when you open it. They also force the top of the door to align flush with the front of the cabinet when the door is closed.)

9 Using a chamfer bit, rout a $\frac{1}{8}$ " chamfer along all top outside edges of the cabinet.

10 Cut the two alignment blocks (K) to size. Rout or sand a chamfer along one edge of each. Screw them (no glue) to the bottom of the bottom frame, $\frac{3}{4}$ " in from the back edge and flush with the outside edge of E (not D). The chamfer should be on the *bottom* facing out. (The alignment blocks center and hold the cabinet on the base so all outside surfaces are flush. Using screws and no glue allows you to realign them if necessary.)

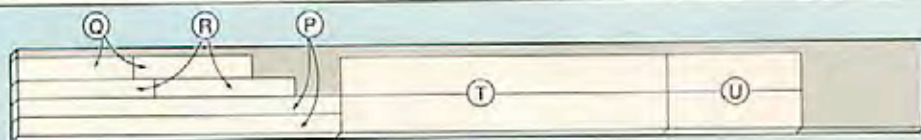

$\frac{3}{4}$ " x $9\frac{1}{4}$ " x 96" Oak

Bill of Materials

Part	Finished Size*			Material	Qty.	Part	Finished Size*			Material	Qty.
	T	W	L				T	W	L		
THE CABINET						THE DOOR					
A	$\frac{3}{4}$ "	2"	16"	oak	2	L	$\frac{3}{4}$ "	2"	14 $\frac{1}{4}$ "	oak	2
B	$\frac{3}{4}$ "	2"	31 $\frac{1}{4}$ "	oak	2	M	$\frac{3}{4}$ "	2"	30 $\frac{1}{4}$ "	oak	2
C	$\frac{3}{4}$ "	2"	16"	oak	4	N	$\frac{1}{4}$ "	$\frac{3}{8}$ "	30 $\frac{1}{4}$ "	oak	2
D	$\frac{3}{4}$ "	2"	10 $\frac{3}{4}$ "	oak	4	O	$\frac{1}{4}$ "	$\frac{3}{8}$ "	11"	oak	2
E	$\frac{3}{4}$ "	2"	9 $\frac{1}{4}$ "	oak	2	THE TOP					
F	$\frac{3}{4}$ "	2"	34 $\frac{1}{2}$ "	oak	2	P	$\frac{3}{4}$ "	2"	34 $\frac{1}{2}$ "	oak	2
G*	$\frac{1}{4}$ "	31 $\frac{1}{4}$ "	12 $\frac{3}{4}$ "	oak plywood	1	Q	$\frac{3}{4}$ "	2 $\frac{1}{2}$ "	12 $\frac{1}{2}$ "	oak	2
H	$\frac{1}{4}$ "	10 $\frac{3}{4}$ "	12 $\frac{3}{4}$ "	oak plywood	2	R	$\frac{3}{4}$ "	2"	14 $\frac{3}{4}$ "	oak	2
I	$\frac{1}{4}$ "	10"	31 $\frac{1}{4}$ "	oak plywood	1	S	$\frac{1}{4}$ "	13 $\frac{1}{4}$ "	34 $\frac{1}{2}$ "	oak plywood	1
J	$\frac{3}{4}$ "	2"	34 $\frac{1}{2}$ "	oak	1	THE BASE					
K	$\frac{3}{4}$ "	$\frac{3}{4}$ "	11 $\frac{1}{4}$ "	oak	2	T	$\frac{3}{4}$ "	4"	34 $\frac{1}{2}$ "	oak	2
						U	$\frac{3}{4}$ "	4"	14 $\frac{3}{4}$ "	oak	2

*Part marked with an * is 31 $\frac{1}{4}$ " wide by 12 $\frac{3}{4}$ " long. Measure width across the grain; the length is measured with the grain. See the Cutting Diagram for layout.

Supplies: $\frac{3}{8}$ " dowel pins 1 $\frac{1}{2}$ " long, $\frac{3}{8}$ "

dowel pins 2" long, $\frac{3}{8}$ " dowel stock (no glue groove), $\frac{1}{8}$ "-thick glass for door, #8 x $1\frac{1}{4}$ " flathead wood screws, #8 x $1\frac{3}{4}$ " flathead wood screws, #8 x $1\frac{3}{4}$ " flathead wood screws, $\frac{3}{4}$ " x 17 brads, carbon paper, $\frac{1}{4}$ " hardboard for template, silicone sealant, paraffin, stain, finish

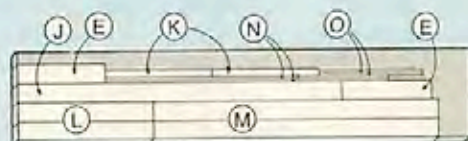

$\frac{3}{4}$ " x $9\frac{1}{4}$ " x 48" Oak

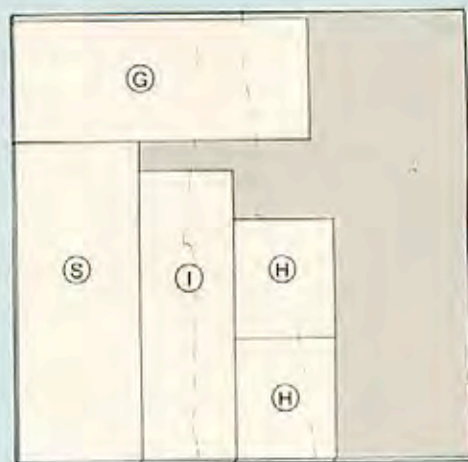

$\frac{1}{4}$ " x 48" x 48" Oak Plywood

Continued

BARRISTER'S BOOKCASE

NOW, LET'S MAKE THE CABINET DOOR

1 Cut the stiles (L) and rails (M) to size. Dry-clamp the door frame together. Then, using the dimensions on the Dowel Hole Detail accompanying the Cabinet Door Drawing at right, mark the dowel hole reference lines on the frame. Remove the clamps, and drill $\frac{3}{8}$ " holes $1\frac{1}{16}$ " deep where marked. Use a doweling jig for proper alignment and $\frac{3}{8}$ " dowel centers to transfer the hole positions to the mating piece.

2 Glue, dowel, and clamp the door frame together. Check for square and flatness as you work. (We clamped the door frame to our workbench top to ensure flatness.)

3 Sand the door smooth. Mount a $\frac{3}{8}$ " rabbet bit into your router. Then, with the front of the door facing down, rout a $\frac{3}{8}$ " rabbet $\frac{3}{8}$ " deep along the back inside edge of the door frame for the glass. Square the rabbet corners with a chisel.

4 Rout a $\frac{3}{16}$ " chamfer along the front edges of the door frame where shown on the Cabinet Door Drawing.

5 Drill a $\frac{1}{4}$ " hole 5" from each end where shown on the Cabinet Door Drawing for mounting the wooden knobs later.

6 Cut the glass stops (N, O) to size.

7 Lay out and drill a $\frac{3}{8}$ " hole $\frac{1}{4}$ " deep $\frac{3}{8}$ " down from the top edge on each end of the door frame where shown on the Cabinet Door Drawing. Cut two 1"-long dowels from $\frac{3}{8}$ " dowel stock. Glue the dowels into the $\frac{3}{8}$ " holes you just drilled. Check that the dowels protrude no more than $\frac{1}{4}$ "; sand down if necessary. Then, sand a slight round-over on the protruding end of each dowel. Doing this enables the door to track smoothly in the hinge pin groove in each end frame.

8 Rip or joint a 5° bevel along the bottom edge of the door frame where shown in the Dowel Hole Detail. (The bevel keeps the door from binding and nicking the cabinet when you open and close it.)

9 Lay out and drill a $\frac{3}{16}$ " hole $\frac{3}{8}$ " deep 1" from the bottom of each

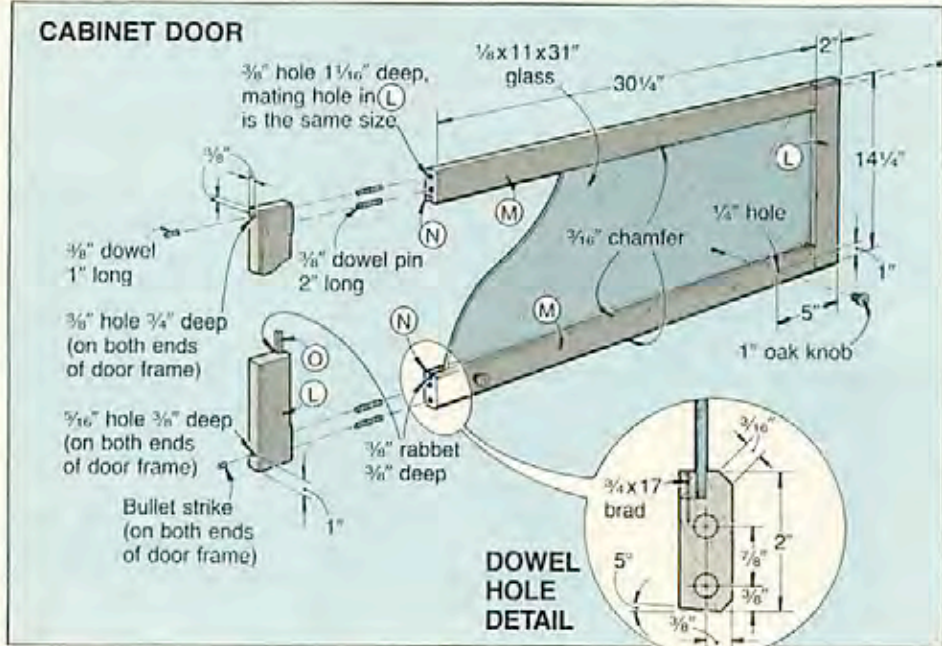

door stile (L) for the bullet strike (see the Cabinet Door Drawing). Install the strikes in the door.

10 Lower the door frame into the hinge pin grooves in the end frames, and close the door. With the front of the door flush with the front of the cabinet, mark the position, and nail the catch plates to the inside edges of the cabinet frame where shown on the drawing below. Locate carefully; the door should align with cabinet front.

THE CABINET TOP COMES NEXT

1 Cut the front and back pieces (P), end pieces (Q), and decorative end pieces (R) to width and length. Mark and cut the $\frac{7}{8}$ x $1\frac{1}{4}$ " notch in the front end of each end piece where shown on the Cabinet Top Drawing.

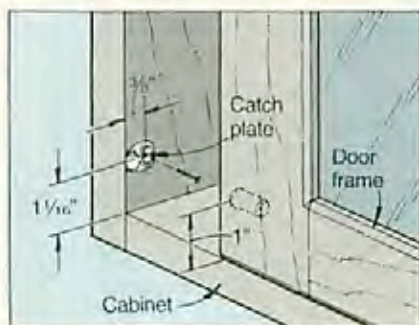

2 Using carbon paper, transfer the Full-Size Pattern accompanying the Cabinet Top Drawing to the front end of each decorative end piece. (If you're making several cabinets, transfer the shape to paper and make a template.) Cut the marked fronts to shape on a band saw, and sand smooth.

3 Cut or rout a $\frac{3}{8}$ " rabbet $\frac{1}{4}$ " deep along the top inside edge of the front and back pieces (P).

4 Dry-clamp the cabinet top (P, Q, R) together, and check the fit of the top on the cabinet. (When clamping the pieces, make sure that the top edge of the end pieces (Q) align flush with the bottom edge of the rabbet in the front and back pieces.) When checking the fit of the top on the cabinet, check to see that all edges are flush. Remove the clamps, and trim if necessary. Glue and clamp the top assembly together, checking for square.

5 Measure the rabbeted opening, and cut the plywood panel (S) to fit snugly inside the $\frac{1}{4}$ "-deep rabbet. Glue and clamp the panel in position.

6 Rout a $\frac{3}{8}$ " chamfer along the entire bottom edge of the cabinet top to match the chamfer on the top of the cabinet.

CABINET TOP

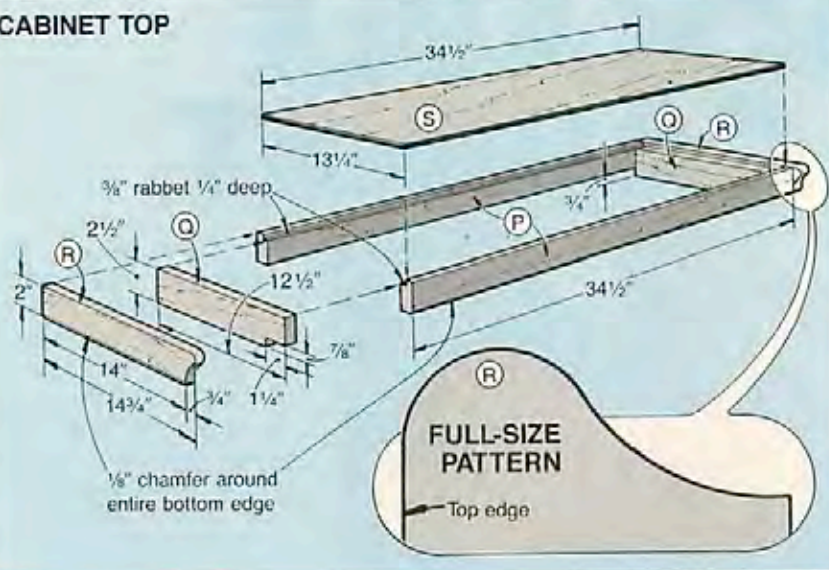

CABINET BASE

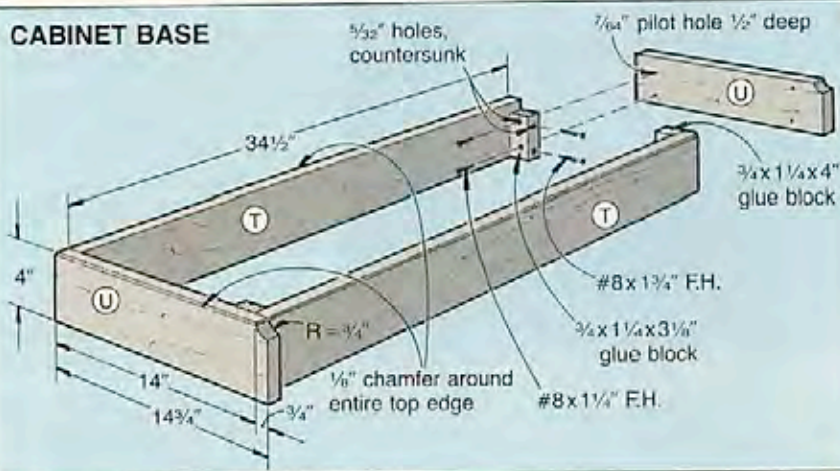

FINAL ASSEMBLY

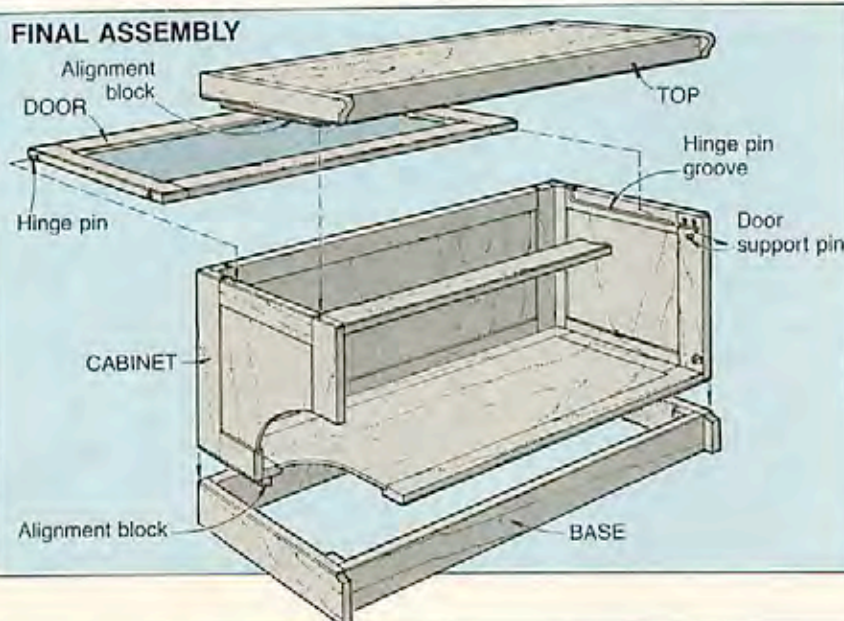

AND NOW FOR THE BASE

- 1 Cut the front and back (T) and the ends (U) to size. Now, cut the four glue blocks to the sizes stated on the Cabinet Base Drawing.
- 2 Mark and cut a 3/4" radius on the front top corner of each end piece.
- 3 Drill and countersink 3/32" holes in the glue blocks. Glue and screw the glue blocks to the front and back pieces (T), flush with their ends. Next, glue and screw the ends (U) to the front and back pieces.
- 4 Rout a 1/8" chamfer around the top edge of the base where shown on the drawing.

FINAL ASSEMBLY AND FINISHING

- 1 Stack the components, and sand the outside surfaces flush. Unstack, and finish-sand each component.
- 2 Mask off the bullet catch hardware. Stain and finish all the pieces (including the glass stops and knobs) as desired.
- 3 Have glass cut to size for the door. Position the glass and glass stops (N, O) in the rabbet, and drive brads to secure the stops. (To avoid splitting the oak, we pre-drilled holes in the stops using one of the brads as a drill bit.)
- 4 Apply paraffin to the hinge pins (3/8" dowels) and to the inside edges of the hinge pin grooves.
- 5 Remove the masking from the hardware, attach the knobs, stack the units, and fill with books.

BUYING GUIDE

- **Bullet catches.** Complete with strikes and pins. 5/16" diameter by 3/8" long, catalog no. D3601. \$3.85 for ten. \$2.50 handling charge per order. The Woodworkers' Store, 21801 Industrial Blvd., Rogers, MN 55374, or call 612/428-2199.
- **Oak knobs.** 1" diameter, catalog no. E4601, 2 needed for each cabinet, 50¢ each from the Woodworkers' Store, address and handling charge above. 🌲

Produced by Marlen Kemmet
Project Design: James R. Downing
Photographs: William Hopkins
Illustrations: Kim Downing; Bill Zaun

A FILE CABINET THAT GROWS AS YOUR NEEDS DO

STACKABLE FILE CABINET

No matter how large our desks, most of us always seem to need more space, especially for filing. If you face the same space problem in your home or office, why not solve it with our stackable file cabinet. Made of oak—like the classic file cabinets of old—it matches the barrister's bookcase on page 66 in design and construction.

The double file cabinet shown measures 15" wide by 24" deep by 30" high. If you don't need the extra worktop surface, but do need extra room for your papers, make the file cabinet four or five units high.



Note: The techniques used to build the file cabinet are quite similar to those used to make the barrister's bookcase on page 66. To avoid duplication, we'll be referring back to some of the bookcase step-by-step instructions and photos in that article.

The instructions explain how to make the components for one cabinet carcass, one file drawer, one top, and one base, and the Bill of Materials on the opposite page gives the number of pieces required for the same components. If you're making more than one cabinet carcass and drawer, we suggest you cut all identical pieces at the same time to ensure uniformity and save time.

LET'S START WITH THE CABINET CARCASS

1 Cut the back frame stiles (A) and rails (B) to the sizes listed in the Bill of Materials. Then, cut the side frame and bottom frame stiles and rails (C, D, E, F) to size.

2 Attach a $\frac{1}{4}$ " dado blade to the table saw. Raise the blade $\frac{3}{8}$ " above the surface of the saw table. As shown in photo A of the bookcase article on page 67, cut a $\frac{1}{4}$ " groove, centered from side to side, along one edge the length of each part. (We test-cut the groove in scrap the same thickness as the rails and stiles to ensure it was centered.)

3 To cut the stub tenons on the ends of parts B, D, and E, reposition the auxiliary rip fence next to the dado blade as shown in photo B on page 67. Position the blade $\frac{1}{4}$ " above the surface of the saw table.

Using a miter gauge, cut a $\frac{3}{8}$ " rabbet $\frac{1}{4}$ " deep on both faces of each end of the parts to form the stub tenon (see the Stub Tenon Detail accompanying the Cabinet Carcass Drawing on the opposite page).

4 Cut the back panel (G), side panels (H), and bottom panel (I) to size from $\frac{1}{4}$ " oak plywood. Dry-clamp the frames together. The plywood panels should fit a bit loosely to allow for frame movement; trim the plywood, if necessary.

5 Glue and clamp the four individual frames together, checking for square. (We ran a small bead of silicone sealant in the back- and side-frame grooves to keep the plywood panels from rattling later.) Finish-sand each frame.

6 Cut the front rail (J) to size.

7 Using the dimensions on the Cabinet Carcass Drawing, mark the

location of, and drill a pair of $\frac{3}{8}$ " holes $1\frac{1}{16}$ " deep in each end of the front rail. (We used a doweling jig when drilling the holes.) Using dowel centers, transfer the hole location in the front rail to the top front corner of each side frame. Drill $\frac{3}{8}$ " holes $\frac{1}{2}$ " deep where marked by the dowel centers.

8 Glue and clamp the back frame to the bottom frame, checking for square. Later, remove the clamps, and glue and clamp the side frames and front rail to the back-bottom frame assembly. Make sure all edges are flush, and wipe off any excess glue with a damp cloth.

9 Rout a chamfer along the top and bottom edges of the cabinet.

10 Cut the two alignment blocks (K) to size. Rout a $\frac{1}{8}$ " chamfer along one edge of each block. Screw them (no glue) to the bot-

CABINET CARCASS

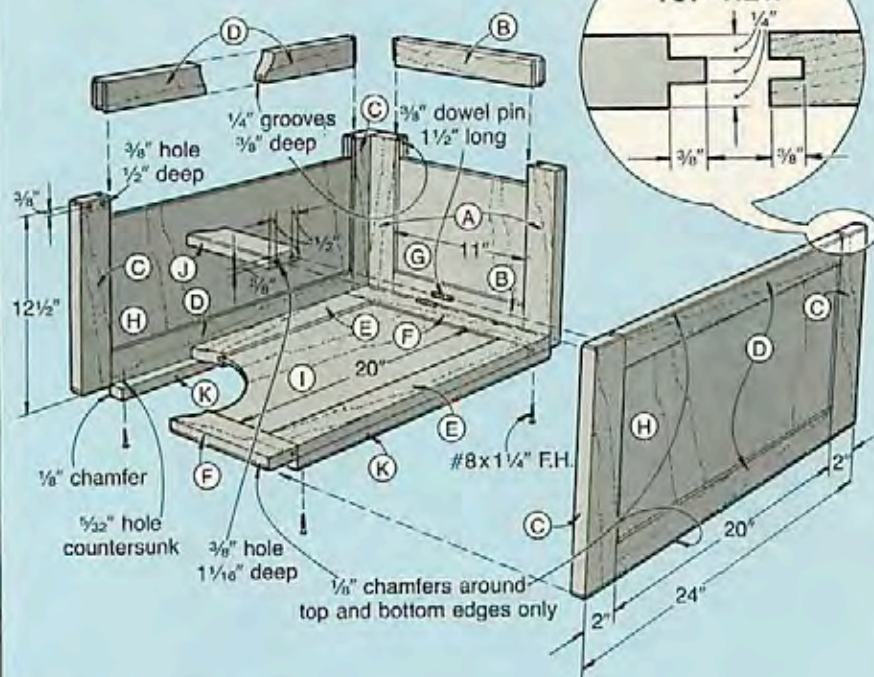

Cutting Diagram

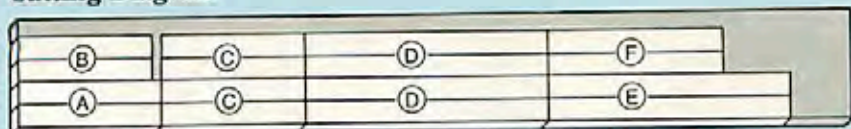

3/4 x 9 1/4 x 72" Oak

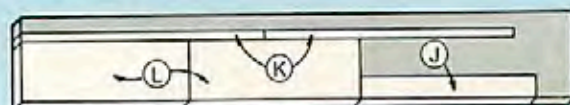

3/4 x 7 1/4 x 48" Oak

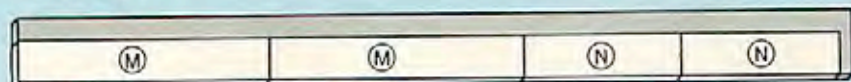

1/2 x 5 1/2 x 72" Oak

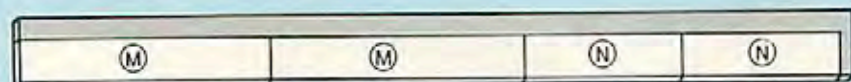

1/2 x 5 1/2 x 72" Oak

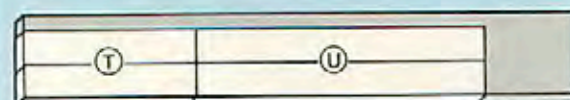

3/4 x 7 1/4 x 48" Oak

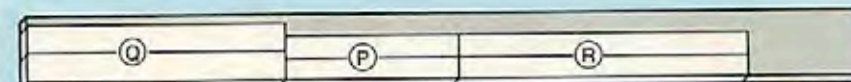

3/4 x 5 1/2 x 72" Oak

Bill of Materials					
Part	Finished Size			Material	Qty.
	T	W	L		
THE FILE ENCLOSURE					
A	3/4"	2"	12 1/2"	oak	2
B	3/4"	2"	11 1/4"	oak	2
C	3/4"	2"	12 1/2"	oak	4
D	3/4"	2"	20 3/4"	oak	4
E	3/4"	2"	20 3/4"	oak	2
F	3/4"	2"	15"	oak	2
G	1/4"	11 3/4"	9 1/4"	oak plywood	1
H	1/4"	20 3/4"	9 1/4"	oak plywood	1
I	1/4"	11 3/4"	20 3/4"	oak plywood	1
J	3/4"	2"	15"	oak	1
K	3/4"	3/4"	21 1/4"	oak	2
THE DRAWER					
L	3/4"	10 3/4"	14 3/4"	oak	1
M	1/2"	7 1/2"	22"	oak	2
N	1/2"	7 1/2"	13 1/2"	oak	2
O	1/4"	13 1/2"	21 1/2"	oak plywood	1
THE TOP					
P	3/4"	2"	15"	oak	2
Q	3/4"	2 1/2"	22 1/2"	oak	2
R	3/4"	2"	24 3/4"	oak	2
S	1/4"	15"	23 3/4"	oak plywood	1
THE BASE					
T	3/4"	3"	15"	oak	2
U	3/4"	3"	24 3/4"	oak	2

Supplies: 8 x 1" flathead wood screws, #8 x 1 1/4" flathead wood screws, #8 x 1 1/4" flathead wood screws, 3/8 x 1 1/2" dowel pins, #4 finish nails, stain, finish

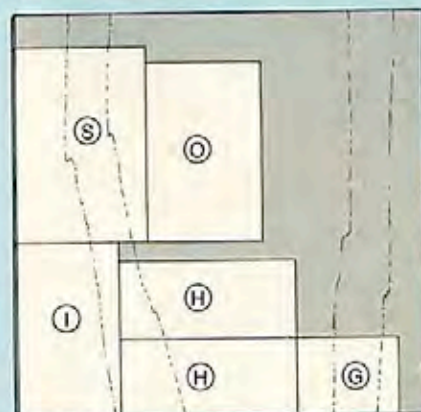

1/4 x 48 x 48" Oak Plywood

Continued

FILE CABINET

tom of the bottom frame $\frac{3}{4}$ " in from the back edge, $\frac{3}{4}$ " from the side edges and with the chamfered edge facing down and out. (The alignment blocks center the cabinet over the base.)

NEXT, BUILD THE FILE DRAWER

1 Cut the false drawer front (L) to size. (We glued up narrower stock to achieve the $10\frac{3}{4}$ " width.)

2 To form the chamfer on the drawer front, start by raising the table saw blade $\frac{1}{8}$ " above the surface of the saw table, and position the rip fence $1\frac{3}{8}$ " away from the outside edge of the blade. (See the Panel Section Drawing.) Make a cut along each edge of the panel where shown on the Kerf Location Drawing. To cut the bevels, position the rip fence $\frac{7}{16}$ " from the inside edge of the blade at table level. Raise the table saw blade $1\frac{1}{4}$ " above the surface of the saw table, and tilt the blade 10° from center. Then, make the four cuts on the false door front as shown in the photo below. Sand the beveled surfaces smooth.



Cut the relief kerfs first; then bevel-cut the drawer front on a table saw with the blade tilted to 10° .

3 Cut the drawer sides (M) and front and back panels (N) to size from $\frac{1}{2}$ " oak. (Edge-join stock to achieve the required width.) Cut the drawer bottom (O) to size.

4 Using your table saw and dado blade, cut a $\frac{1}{4}$ " groove, $\frac{1}{4}$ " deep, $\frac{1}{4}$ " from the bottom edge of the drawer sides, front, and back panels where shown on the Drawer Drawing. With a $\frac{1}{2}$ " dado blade, cut a $\frac{1}{2}$ "

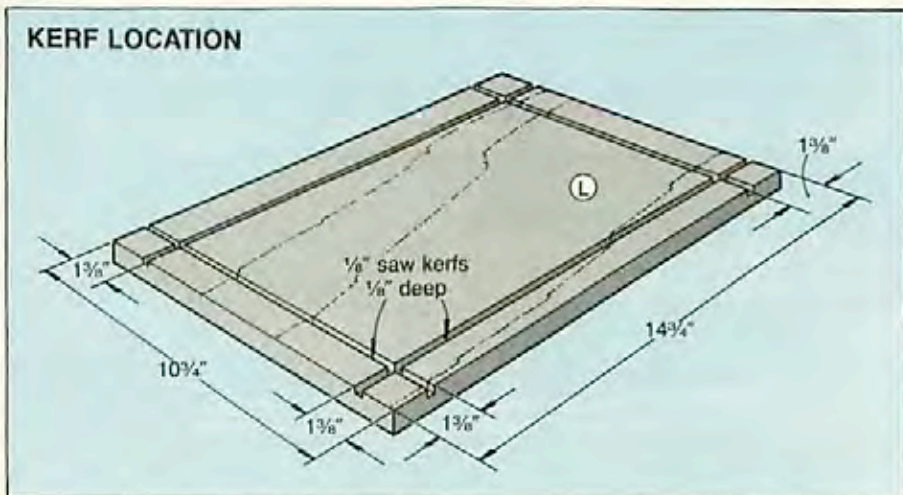
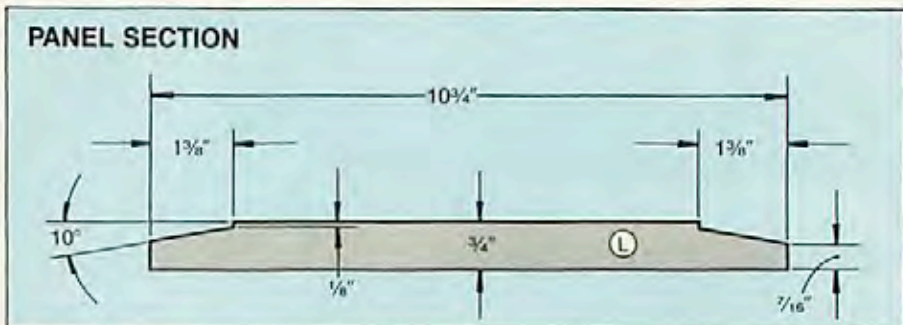
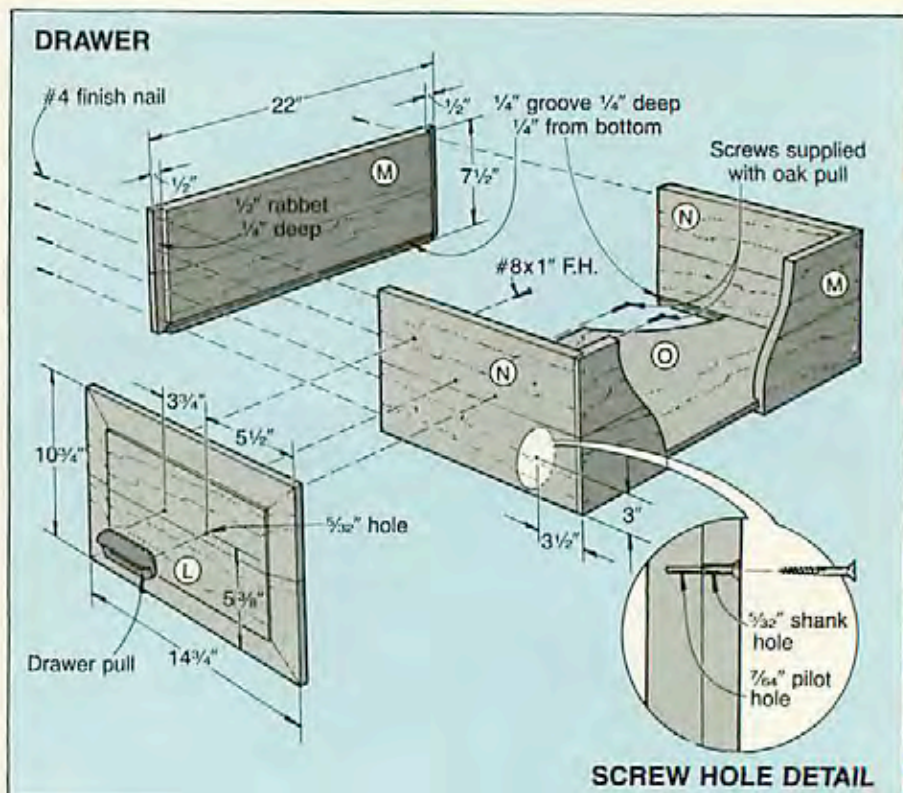

A WISCONSIN FISH STORY

Racine, Wisconsin carver Rick Beyer breaks the surface with dramatic underwater close-ups sport fishermen only dream about. Plus, his cherry trophies bring home blue ribbons.

"Feeding Frenzy" depicts wall-eyed pike feasting on minnows. The carving measures 18x24" and carries a price of \$775.

Nine years ago, Rick Beyer, 32, was making rough, primitive attempts to carve lifelike fish. Now, he's taking top honors in major competitions. Even masters of the art have begun to defer to his blooming talent.

A part-time carver until a year ago, Rick went full-time when the company he worked for decided to pull out of

Racine—and leave him without a job. Today, Rick climbs to world fame on cherry chips from carvings, such as his scene, *right*, called "Ambush," exhibited in the wildlife gallery owned by him and his wife, Nancy. Riveted to Rick's carvings from our first glimpse, we had to bring you his fish story.



“Where the heck did this guy, Rick Beyer, come from?” That’s the question going around at major wildlife art competitions these days, after the ribbons are handed out—to Rick Beyer.

The answer lies just a few blocks from the Lake Michigan shore in Racine, Wisconsin. There, you’ll find R.J. Beyer Galleries. Inside, hang the works of prominent wildlife artists: paintings and painted carvings of eagles, hawks, songbirds, upland game, big game, and fish. Yet, compared to the carvings signed “R.J. Beyer,” other art simply blends into a colorful backdrop. For Rick skillfully blends the beauty of naturally finished cherry, the equivalent of stop-motion underwater photography, and your imagination to convey what otherwise only fish could experience.

Topping a doorway, “Feeding Frenzy,” shown *opposite*, captures a trio of walleyes gulping down dinner. Above a display case hangs a largemouth bass, its gills flared and mouth spread wide, ready to inhale whatever your mind supplies—some finned morsel or an angler’s lure. On a nearby shelf, the diorama “Final Battle” pits a feisty crayfish against a charging bass.

IMAGINING THE SCENE BELOW

Anyone who has spent time in a canoe or fishing boat knows that what Rick carves happens continually. Every foot of sur-

face water has action beneath—the flashing fight for survival, the predator against the prey, the battle for life in nature’s food chain. Few, however, have glimpsed the scene. Most of us imagine it. The gifted, like Rick, make these imaginations real.

The young carver’s largest work to date, “Ambush,” commands center stage in the gallery (photo *above*). A 6’-long glass case displays a world-class size muskellunge chomping down on a northern pike. In Macon, Georgia, last spring, “Ambush” set the World Wildlife Art Festival on its ear and earned Rick two top awards: Best in World, Fish Sculpture; and Best in World, Group Fish Carving. For this diorama, Rick supplied these notes for minds to nurture:

“Carved entirely of cherry, this piece (shown above) exemplifies a muskellunge feeding in its natural habitat. As this 53”, 40-some-pound muskie explodes, it brings with it turbulent water, bending and breaking vegetation. The 27” northern pike’s life is ended quickly as his role changes from predator to prey within an instant. And, as the perch swim away in nervous relief, a crayfish and bluegill hide from numerous troubles.”

The muskie’s tail seems frozen in a bullwhip snap that would churn water. The power and grace Rick embodied in the muskie’s posture contrasts with the convulsion or two left in the pike. The underwater plants even appear to shake.

Each of Rick’s carvings has to be lifelike, and anatomically correct, down to the millimeter. That’s because the judges in wildlife art competitions attack carvings with calipers. At the last event Rick attended, one judge was a marine biologist. He lined up every fin, precisely measured the distance between eye sockets, and carefully inspected for tiny imperfections.

Instead of relying on taxidermy mounts to study details, Rick researches. “I have to imagine how the fish’s tail moves the water—there’s little reference for that,” says Rick. “So, I’ve watched fish at an aquarium. Northern pike strike prey from an S-shaped coil. Muskie’s hit from a C-position. But, bass and other fish vary. Salmon and trout, for instance, cruise, and propel themselves quite differently.” He also uses books and photographs, and he fishes.

“I used to go fishing a lot more, before I started carving full-time,” he recalls, with a sigh. “Every summer, I’d go with my family to a cabin on the Chippewa Flowage, Wisconsin’s best muskie water.” He would immediately release a muskie now if he caught one, because legal-size ones are a rare catch. Other fish, though, he examines closely, out of the water. “I take a snapshot of my catch, turn and feel the fish in my hands, and watch gill and mouth movement. It’s important to understand the relationship of features to each other.” Yet, for all Rick’s interest in details, there’s a significant detail he intentionally ignores.

Continued

FISH STORY

"I never do the scales," he notes. "If you are going to leave the carving unpainted, you just can't do scales because they make any fish look like a carp. Scales overpower the grain of the wood."

Rick also pays close attention to underwater plant life. "In the muskie scene, it took me more time to do the vegetation than to do everything else," he explains. "The tail is bringing all the water flow that way, so the leaves have to turn. The hardest part was figuring out which way the leaves would all be going if this really happened. Plants have to be as accurate as I can get them, and out of the water they look a lot different. So, I get details from underwater photos in books. I also have to imagine what's going on and where it's happening. The big muskie, for instance, is in shallow water, because otherwise you wouldn't see the tree stump."

THE BEGINNING OF A FISH STORY

"I was carving fish before I knew that anyone else was," Rick says. "I started carving them because I

thought that there were 6 zillion decoy carvers out there already, but no one was catering to the 5 million fishermen. Now, though," he chuckles as he folds his arms across his flannel shirt, "I bet only 5 percent of what I make sells to fishermen. Women buy the majority, as art."

Perhaps that's because the cherry Rick carves attracts the eye with a red-brown glow long before his detailed artistry comes into focus. "I've always loved working with wood," he says, "but I love working cherry most of all. It's the most beautiful wood there is, and has the strength I can't get from softwoods. Yet, it has smooth grain and doesn't splinter."

"Besides," he continues, "softwoods are meant to be painted. All the other pieces I compete against are painted. I let the beauty of the cherry show."

Cherry goes into everything—the bass, the walleyes, the crayfish, even the stumps, plants, rocks, and sand on the lake bottom. But the natural wood lends more than beauty to Rick's work. The grain running horizontally through each fish's body contributes to the amazing sense of motion.

"Action is what counts, and I try to put more in than anyone else," Rick says. "The cupping of a tail fin, the curve of a spine, the set of a jaw—all these details portray motion."

COAXING TROPHIES FROM BLOCKS OF WOOD

Rick never sketches his carvings on paper first. "I just start with an idea and a main piece of wood, then work it until it's the way I want. I usually just do a freehand drawing on the block of cherry, cut it out on the band saw, and start carving."

Because large-dimensional blocks of cherry have a tendency to split, Rick uses Elmer's yellow glue to laminate 2"-thick boards into blocks that become fish bodies. After band-sawing the block to rough shape (for real large fish, Rick has used a chain saw for roughing), he continues to take wood off fast. It reduces production time and lets him get down to the details he enjoys.

The viewer supplies the outcome of this scene. Will the largemouth smash a fisherman's lure or a hapless frog?



"Final Battle."



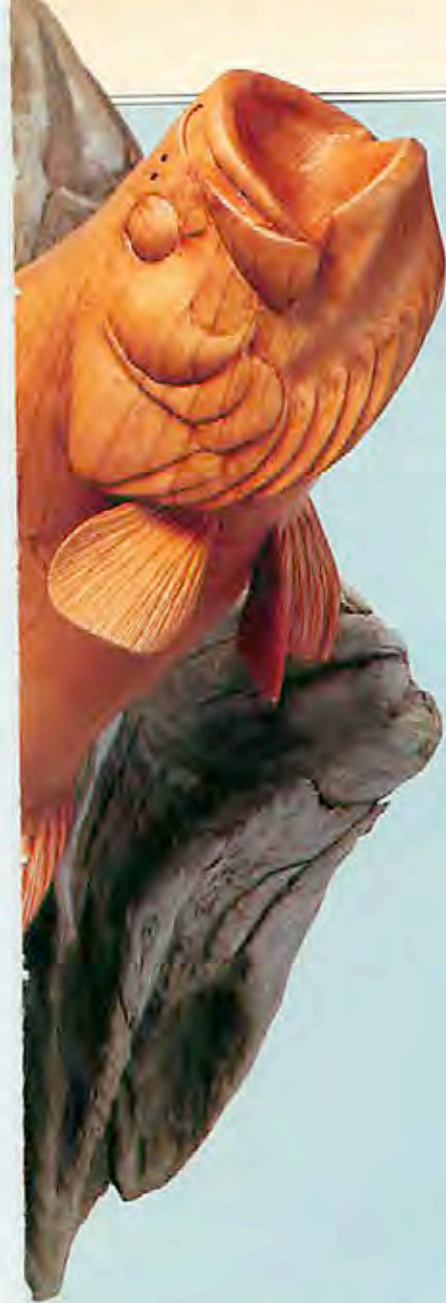

To chip away cherry quickly, he relies on an Automach power chisel. Next comes a hand rasp, then a power disk sander to smooth the surface. For details, Rick reaches for his set of five Dremel Moto-Tools—each with its own time-tested bit. But not all his cherry blocks meet those tools.

In his shop, amid a pile of rejects, lies the half-carved body of a northern pike that didn't make it into "Ambush." Even though it's jagged



A flexible-shaft Moto-Tool, one of five such tools Rick uses, bites into the cherry of a bluegill's lips.

and squarish, the unfinished fish seems to be struggling to come alive. If the cherry chunk doesn't end up in the fireplace, it may become smaller fry. Rick admits he's fed his fireplace with lots and lots of unfinished pieces because he couldn't coax the wood into exactly what he wanted to see.

No matter the size of the carving, though, there's always a lot of sanding. The giant muskie took hours and hours, and a special solution for a smooth finish. "In order to avoid ripples in such a large surface," he says, "I borrowed large sanding blocks for doing cars from a friend who happens to be the foreman in a body shop."

Following the final sanding, Rick applies several coats of Formby's tung oil. "That particular brand always seems to give the wood just the right amount of warmth," he says. "It has gleam without wax."

MAMMOTH MUSKIE, MOVE OVER

Even at prices that immediately place his work on the collectible art level—from \$475 for a battling largemouth to \$30,000 for the mammoth muskie and its prey—Rick doesn't think about someday being wealthy. A good fishing pole, and the time off to use it, mean as much to him as a Porsche. He and Nancy wouldn't mind, however, selling large carvings to corporate clients, such as fishing tackle manufacturers and financial institutions. No doubt that a work like "Ambush" would pull customers into your local bank. Or how about one larger than that? Rick has plans for a scene three times the size of his present giant: "It's in my head right now—a school of salmon or lake trout chasing shad." That ambitious undertaking will top the 1,000 hours of carving effort he put into "Ambush."

Size isn't all that counts in the future, though. Rick would like to put some humor in his work. For example, Rick comments that fishermen always wonder what happens to their boat anchors. A bluegill swimming around an anchor still tied to a frayed rope might help explain the phenomena. Then, for an upcoming exhibition in Hawaii, Rick has started carving a restaurant place setting with a lobster in the middle of the plate pinching a vessel of drawn butter. The title: "The lobster doesn't agree with me." 🍷

Written with Gregory C. Erickson
Photographs: William Hopkins



Laminated thicknesses of 2" cherry form Rick's carving blocks. This roughly shaped pike displayed a streak of color that ruled it out for finishing and a place in "Ambush."

Solid-cherry
bluegill



A "TURN-RIFIC" TRIO WALNUT SPICE JARS



Another
in a collection
of patterns
from the nation's
top woodturners.



Phil Brennon

Phil Brennon specializes in sculpted and turned vessels. Inspired by the works of the Anzazi (ancient one) Indians and the local Indian environment of the secluded Arizona high plains where he lives, Phil strives for turnings pleasing to the eye and beckoning to the touch.

HOW TO START OUT

"In making the spice jars, I start with a 4" walnut turning square crosscut to 13 1/2"—the total height of all three spice jars, plus waste for the faceplate screws and parting cuts" notes Phil. "After centering and screwing one end of the turning square to a 3" faceplate, I slide the tailstock into position centered against the other end for extra sup-

port. Then, I turn the square round with a 3/8" Sorby bowl gouge."

Phil next marks the layout lines for each of the three jars where shown on the drawing below. Using a parting tool, he cuts the necks to a 2 1/2" diameter and the bases to a 2" diameter, checking the depth of the cuts with an outside calipers.

TURN, TURN, TURN

After making a template for each of the three jars (see the Full-Size Half Patterns at right), and turning the jars to their final shape with the bowl gouge, he cuts the decorative grooves with a parting tool. "I paint the grooves with fast-drying black paint, not worrying about overspray," Phil admits. "After the paint dries, I sand the jars being careful not to scratch the paint in the grooves." Once the sanding has been completed, Phil finishes the three-tiered turning with Watco Danish Oil and Watco Satin Wax applied with #0000 steel wool.

FINISHING UP

Next, he removes the faceplate and walnut turnings from the lathe. Moving to the drill press, Phil clamps a handscrew around the faceplate for support, and using a 1 7/8" Forstner bit centered over the center point left by the tailstock, he bores a hole in the top jar to a depth of about 3/4" from the bottom. He then re-mounts the assembly to the lathe, sands a contour to the inside lip of the hole just drilled, and parts the bored jar from the cylinder. Phil repeats this process for the remaining two jars.

Finally, he sands a slight concave surface on the bottoms of the jars with a 2" flexible sanding disk

mounted to the drill press. To finish the interiors, he applies salad bowl finish to the inside wall of each jar.

BUYING GUIDE

• **Tapered corks.** 2"-dia. top, 1 1/2"-dia. bottom, \$3 ppd for a set of three from Stoneweavers, 3054 North First Ave., Suite 9, Tucson, AZ 85719. ♣

Photographs: William Hopkins,
Gordon Diffendaffer

Illustrations: Kim Downing; Bill Zaun

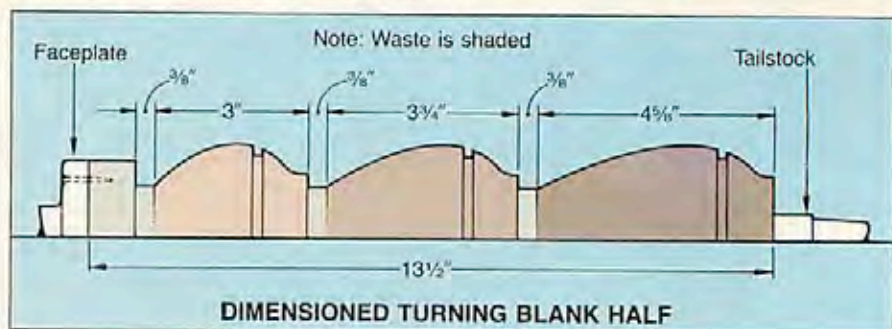
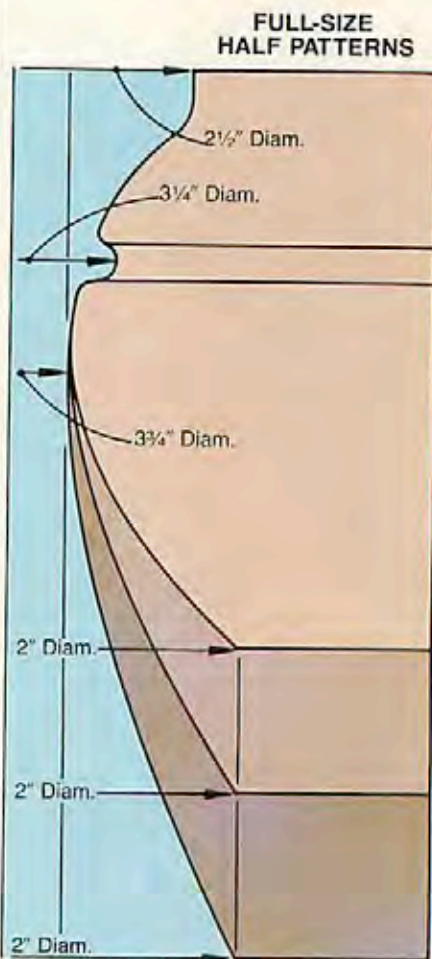

Introducing less of a good thing.



The new Delta 6" Precision Jointer.

Sometimes, you need a tool that's a little bit smaller to fit the needs of your shop. So we "shrank" our popular 8" Precision Jointer to a smaller 6" size. But there's nothing smaller about its quality or performance.

Like its big brother, the new Delta 6" Precision Jointer features a parallelogram-design table support system for uniform chip breaking and smoother finishes. And its large, stable rabbeting ledge lets you cut rabbets up to 1/2" deep.

We gave it a 55 1/2" table (30" infeed), center-mounted tilting fence, and three-knife cutterhead. So it can handle full-size stock easily. And give you the same perfect straight edges, bevels, and surfaces you'd expect from a bigger machine.

The new Delta 6" Precision Jointer proves that good things *do* come in smaller packages. Call toll-free for the name of your Delta Distributor. Delta International Machinery Corp., 800/438-2486 (in PA, 800/438-2487).

 **DELTA**
Building On Tradition

OLD HAND WAYS

THE WOODLOT

ONE FAMILY'S
TREASURED HEIRLOOM

"It is remarkable what a value is still put upon wood . . . , a value more permanent and universal than that of gold."

— Henry David Thoreau, 1854

Not many Harvard graduates drive oxen these days, but Martha-Mac hardly gave it a thought. I could barely keep up with her as she guided the great beasts and their sledge up the hill between the trees. It was early spring. We were cutting firewood on a 40-acre woodlot that had been tended by her family for five generations. After the death of her father, it was hers.

"Better drop that maple that the cows messed up," she said, pointing to a 10"-diameter tree with a weeping brown scar where its bark joined the Pennsylvania hillside. For a woman trained in the arts, she certainly knew the business of nurturing her forest.

The chips that fell from my ax showed dark stains where decay had developed in the wood. She picked up one of the larger chips, peeled it apart, and studied its grain. "Straight stuff, too bad," she said, tossing the chip back to the ground. "I'd sure like to have another curly maple or two to sell for gunstocks."

"Why not just leave it?" I asked, giving my ax a well-deserved rest. "Because," she replied, "it's a bad investment. It's taking space that could be used by these younger trees around it. If you want a forest to be productive, you have to tend it like a garden. I manage this estate for long-term growth, just as my father did."



Sassafras for oxen yokes, persimmon for golf clubs, and curly maple for gunstocks all come from Martha-Mac's nurtured woodlot.

WOOD FOR ALL REASONS

We loaded the maple on the sledge, leaving behind only the uppermost branches. I nodded at the remaining brush: "At least we brought all those buds and twigs within reach of the deer."

Martha-Mac was not nearly so sentimental. "Those deer tear this place up when they're hungry," she informed me. "Remember, I make a living here, too." She walked on up the hill, stopping now and then to study the lean of a black cherry tree or to knock the dead branches from a red cedar.

Deer were not the only unwelcome visitors to her forest. Every few years a timber buyer made his way up the valley. He would pop his chewing gum and offer Martha-Mac a few hundred dollars for "that patch of timber on the hill." Provided, of course, that he could come in and cut everything. He could not have known that he was talking to a lady who knew the value of her land.

The childhood story of the "Goose that laid the golden egg" had not been lost on Martha-Mac. She intended to take care of her forest. After all, her family had cut and sold prime furniture-grade cherry, walnut, oak, tulip poplar, and hard maple from this land for two centuries.

Continued on page 84

FACTORY DIRECT CLOCKS AND FURNITURE

\$10 OFF INITIAL PURCHASE*

Do-It-Yourself Kits or Completely Assembled and Finished

- Grandfather Clocks
- Mantel and Wall Clocks
- Accent Furniture: Curio Cabinets, Chests, Tables, Chairs, Desks, Secretaries...and more!
- Solid 3/4" hardwoods: black walnut, cherry, oak
- Heirloom quality
- Solid brass West German chiming clock movements and dials
- No woodworking experience necessary

SEND \$1 FOR 40-PAGE FULL-COLOR CATALOG

EMPEROR CLOCK COMPANY

WORLD'S LARGEST MANUFACTURER OF GRANDFATHER CLOCK KITS
Dept. CP-2606, Emperor Industrial Park • Fairhope, Alabama 36532 • Phone 1-205-928-2318

• Money back guarantee
KIT PRICES STARTING AT
\$89.50
*Minimum Order \$99.00

I am interested in
 Do-It-Yourself Kits
 Finished Clocks
 Finished Furniture

Name _____
 Street _____
 City _____ State _____ Zip _____
(PLEASE PRINT)

CHQ/GE PRECISION TOOLS, INC.

Should be YOUR first CHOICE for

ROUTER BITS & SHAPER CUTTERS

HERE'S WHY... We feature over 50 different Router bit shapes in over 350 sizes AND 48 shaper cutters 1/2" bore to 1 1/2". AND exciting new ideas in Router Accessories.

CARBIDE TIPPED ROUTER BIT SETS

6 Bit Set	(1/4" Shank)	10 Bit Set
1/4" Round Nose	1/4" Mortise	
1/4" V-Groove	1/4" 30° Bevel Flush Trim	
1/4" Cove	1/4" Panel Pilot	
1/4" Round Over	1/4" Core Box	
1/4" Bead	1/4" Round Over	
1/4" Ogee	22° Bevel Trim W/Bearing	
	1/4" Slot Cutter	
	1/4" V-Groove	
	1/4" Straight Bit W/Bearing	
	1/4" Beading Bit W/Bearing	

\$79

Both Sets include cast aluminum router bit holder. Holder will take 24 bits. Router bit holder only \$14.95.

\$114

3 PIECE CABINET DOOR SET

- REVERSIBLE STILE/RAIL
- RAISED PANEL
- DOOR LIP
- 1/2" SHANK

Set of 3 **\$119**

RAISED PANEL CUTTERS (1/2" Shank)

68247 - \$49	68250 - \$34	68252 - \$39	67256 - \$48	67264 - \$48	68282 - \$49
45225 - \$29	45300 - \$34.00	45222 - \$39	45223 - \$39	45224 - \$39	
2 1/4" Diameter	2 1/2" Diameter	3 1/2" Diameter	2 1/2" Diameter	3" Diameter	

NEW—ROUTER TABLE

- A rigid casting with ground top
- Adapts to any router under 6" dia.
- Miter Slide
- 4-Way Mount
- Optional Fence
- Bench Top Leg Set

\$199

To order by C.O.D., MasterCard or Visa call Toll Free 1-800-544-BITS (2487) in Florida Call 1-305-857-3610 or send check to Choice Precision Tools, Inc. P.O. Box 520999 Orlando, Florida 32856

FREE CATALOG
1-800-544-BITS (2487)

"Jorgensen" AND "Pony"

CLAMPS

Dependable extra hands for all types of clamping and work-holding jobs:
Woodworking Projects, Home Maintenance, and Furniture Repair.

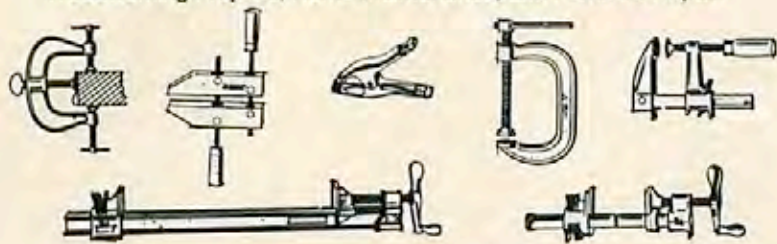

Write for FREE LITERATURE.

For big 32-page "how-to-clamp-it" catalog, send \$1.00.

ASK YOUR DEALER

ADJUSTABLE CLAMP COMPANY

THE CLAMP FOLKS

410 N. Ashland Avenue • Chicago, IL 60622

OLD HAND WAYS

Continued from page 83

Her people could find a market for anything. Before the First World War, they sold winter-cut hickory saplings to rustic furniture makers. In the spring, they peeled hickory bark to sell for weaving chair seats. They sold second growth ash and hickory for tool handle stock. But her father had always been proudest of the 40"-long ash bolts he sold to the baseball bat factory. He was sure he won the World Series every year.

Even obscure species turned a profit for her family. They had sold soft, decay-resistant sassafras for ox yokes, dense persimmon for golf club heads, smooth-wearing dogwood for industrial weaving shuttles, and even some of the light but tough willow wood down by the pond to make artificial arms and legs.

WHEN THE ARMIES CAME CALLING

Over the years, much of the odd timber from the woodlot had been used for fencing. On the homestead, they always needed rot-resistant chestnut, catalpa, black locust, red cedar, or Osage orange. "My great-grandfather had to replace all these fences in 1863," she said, beginning an old familiar story. "The soldiers camped here the night before the fight over by Gettysburg. They were supposed to take only the top rails of the fences to build their cooking fires. Of course, when the top rail was removed, the next one down became the top rail and was fair game. Great-grandfather refused to replace them with his good timber. Instead, he used crooked stuff that was no good for anything else. Some rails were so crooked that a horse could jump over the fence and still be inside!"

Certainly, Martha-Mac's woodlot management consists of much more than thinning out the unproductive growth. She has to be careful about thinning too severely. The added light could cause remaining trees to sprout new branches, making knotty timber.

Continued on page 86

No workshop is complete without the Constantine Catalog.



It's the supply center for 15 product categories, in 116 pages jam-packed with 4,000 woodwork items for Woodworkers, Restorers, Finishers. It puts 250 sizes and kinds of cabinet or furniture wood at your fingertips—and 150 richly-grained veneers... hardware and hand tools... 110 carving tools and chisels... 300 How-To books and plans... 76 inlay designs and lots more. All with a 60-day, money-back, no-questions-asked guarantee!

Send just \$1.00 for your catalog TODAY—and complete your workshop!

CONSTANTINE Est. 1812
2054Y Eastchester Road, Bronx, NY 10461

Name _____

Address _____

City _____

State _____

Zip _____

The mark of excellence
for router bits is

Stile/Rail Router Bit Set

Introductory
Price

\$94.95

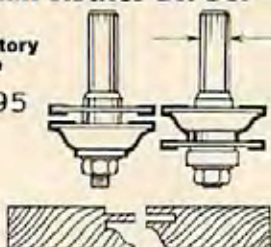

DML

Cutting everything but corners

Panel Raising Bits

Introductory
Price

\$74.95

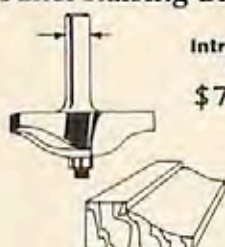

DML's New Radi-All® Saw Blade Cuts Overfeed

For virtually effortless cutting – a new carbide tipped radial armsaw blade that reduces overfeed so you don't fight the equipment. Created for trim, cutoff, and general purpose cutting.

	Diameter	Teeth	List	SALE
Radi-All Blade	10"	60	\$92.50	\$69.50

Call for our low prices on DML saw blades, shaper cutters, router bits and drill bits

W CHANDLER & Co

6005 Milwee, Suite #709

Houston, Texas 77092

call us toll-free

1 (800) 247-9213

(713) 683-8455

Adams NEW Wood Products

"LUMBER"

KILN DRIED, SURFACED TO 5", 1", 1/2" WITH 2 PARALLEL EDGES. 100% CLEAR IN USABLE SIZES. OAK, HONDURAS MAHOGANY, WALNUT, CHERRY, MAPLE, PINE. TURNING SQUARES, DRAWER SIDES, CARVING BLANKS. DRAWER SIDES IN OAK, CEDAR, MAPLE.



QUEEN ANNE CHAIR



QUEEN ANNE LEG

"FUTURE ITEMS"

COUNTRY STYLE AND CLAW/BALL TABLE LEGS

ALL ITEMS AVAILABLE IN QUANTITIES OF ONE OR MORE.

INCLUDING TABLE BASES, QUEEN ANNE LEGS, AND R.T.A. QUEEN ANNE CHAIRS, WHICH ARE SHIPPED FROM STOCK.

"FREE BROCHURE"
DEPT. "MD"



Adams Wood Products, Inc.

974 Forest Dr., Morristown, TN 37814

DAVID J. ADAMS
President

TELEPHONE
(615) 587-2942



#12 VAN \$4.75



#13 DUMP TRUCK \$6.75

STICKLER FOR DETAIL? At last, an exciting new line of REALISTIC Wood Block Models that you can build with your own scrap wood & dowels, and my easy to follow instructions.

CONVERSION VAN measuring over 15' long x 7' high, includes details of dash/console units, aircraft seats, roof luggage rack, ladder, spare, mirrors, shocks, lights, working steering, and even a drink tray.

DUMP TRUCK measures over 20' x 8 1/2' high. Model plans include a detailed engine, drive-train, and rear axle gear assembly. Operational parts include a pivoting hood, tailgate, dump body, unique front steering, working tailgate slide hatch & all turning wheels. *Send check of money order in the above amount to: Galto Plan Supply, P.O. Box 373, Blandon, Pa. 19510 215-926-2570*

OLD HAND WAYS

Continued from page 84

Yet, trees need to be cut when they are ready. Otherwise, they can go bad like "apples that hang too long on the branches." Most of her work would take so long to have an effect that it would only benefit the grandchildren. Fortunately, that fact never stopped her grandfather.

The hill was covered with a thriving woodland reflecting the energy she had put into the land. That was why the old beech trees on top of the hill stood out. Surprisingly, they were well past their prime, probably 200 years old. Branches had broken from their tops, and one was completely hollow. Their bark was scarred and furrowed as high as a man could reach. "Why haven't you cut these old beeches?" I asked.

"Stand back and see if you can read the date on the one in the middle," she responded, wiping her forehead with the hem of her long skirt.

I squinted at the tree, and realized that the scars were actually barely legible writing carved into the bark. I read the date slowly: "June 30, 1863."

Martha-Mac spoke quietly, gesturing toward distant Gettysburg. "The soldiers carved their names in these trees the night before the battle. When I was young, I could still read most of the names. These trees belong to them." 🌲



By Roy Underhill

Master housewright at Colonial Williamsburg and host of the popular PBS series *The Woodwright's Shop*. Underhill is also an author, and lecturer.

SIGNCARVING IS PROFITABLE!



And it's easy, if you use the Marlin Woodcarvers and accessories. You can carve signs quickly at home or at swap meets. The machines do the work, the operator has the fun and profits.

No Special Training Is Required!

SEND \$1.00 FOR OUR BROCHURE AND PRICE LIST, AND BEGIN TO PLAN YOUR FULL OR PART-TIME BUSINESS.

Fine Carving Machines Since 1971

MARLIN INDUSTRIES

RR 70, BOX 191, DEPT. D82
CASHIERS, NC 28717
(704) 743-5551



Some decisions in life are not easy.



Light Duty Wood Shaper

Your choice, \$499 each.

For a limited time, Delta is lowering the price on their 14" Wood Cutting Band Saw and their Light Duty Wood Shaper. So take your choice.

14" Wood Cutting Band Saw

- 6 1/4" cutting capacity
- 14" x 14" tilting table
- Precision-balanced aluminum wheels
- Equipped with 1/2 HP motor, lamp attachment, and steel stand

Light Duty Wood Shaper

- Makes mouldings on straight, internal, and external surfaces
- Stable 15 1/2" x 18" table with fully-adjustable fence
- Equipped with 1 HP motor and steel stand

At this price for Delta quality, you might just want to choose both.

Offer good only in the continental U.S.

- We honor all Freud nationally advertised specials.
- Call or write today for current prices on other tools/accessories.
- Prices quoted, delivered prepaid on \$75 minimum order.
- Visa, MasterCard accepted.

CALL TODAY FOR NEXT DAY SHIPPING.

803-779-3131 Ext. 10



STACKABLE FILE CABINET

Continued from page 75

clip on each telescoping section. Screw the drawer mount (not the telescoping section) to the drawer side, flush with the front (see the photo below).

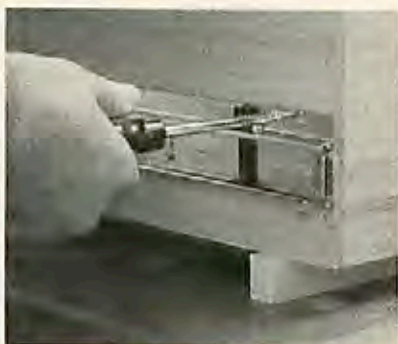

Elevate the drawer to the correct height; then screw the drawer mount to the side of the drawer.

4 To attach the false drawer front (L) to the drawer, start by placing a piece of double-faced tape on the front face of the drawer front (N). Position the false front against the drawer front, centered in the cabinet carcass opening from side to side and top to bottom. When correctly positioned, squeeze the two together. Carefully extend the drawer from the cabinet carcass, and clamp the false front to the drawer front to ensure that it doesn't move. Using the hole sizes stated in the Screw Hole Detail accompanying the Drawer Drawing, drill and screw the false front to the

drawer front. Finally, drill two 5/32" holes through the drawer front assembly for the drawer pulls.

FINAL ASSEMBLY

1 Stack the assemblies, adjust the alignment blocks if necessary, and sand the outside surfaces flush. Now, disassemble the components, and finish-sand each.

2 Stain and finish as desired. Reassemble all parts and attach the drawer pull.

BUYING GUIDE

• **Door pull.** Surface-mounted, unfinished oak, 4 1/2" wide by 1 1/4" high, mounts from rear with machine screws which are included. Catalog no. D8250, \$3.10 each from The Woodworkers' Store, address and handling charge above.

• **Full-extension slide.** Ball-bearing construction, zinc-plated cold-rolled steel, 22" long, catalog no. D7532, \$25.65 per set. \$2.50 handling charge per order. The Woodworkers' Store, 21801 Industrial Blvd., Rogers, MN 55374-9514, or call 612/428-2199 to order. ●

Produced by Marlen Kemmet
Project Design: James R. Downing
Photographs: Bob Calmer
Illustrations: Kim Downing; Bill Zaun

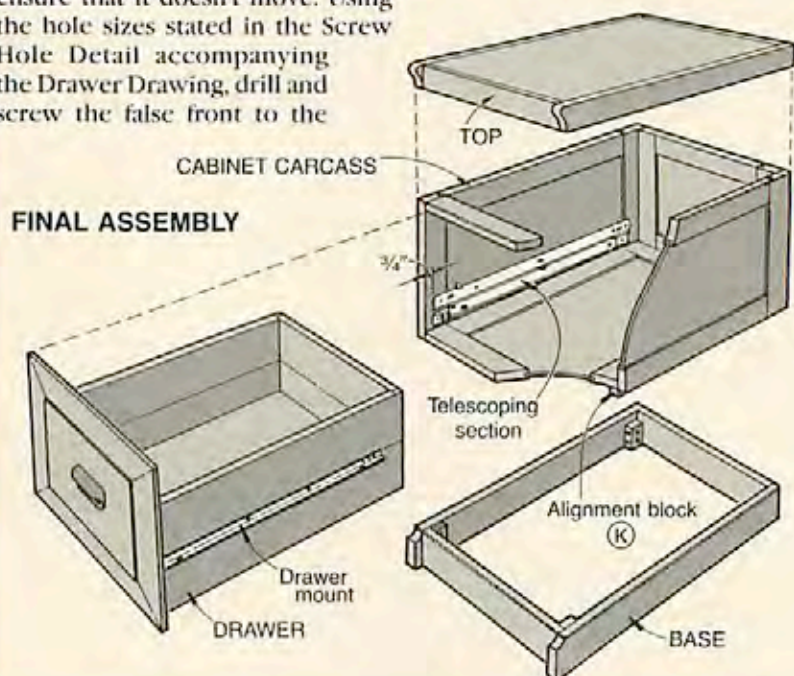

FINAL ASSEMBLY

SUBSCRIPTION PROBLEM?

We want to solve it to your complete satisfaction, and we want to do it fast. Please write to: Robert Austin, *Better Homes and Gardens*® WOOD, P.O. Box 10628, Des Moines, Iowa 50336.

You can help us by attaching your magazine label to this coupon, or printing your name and address as it appears on your label on a piece of paper and sending it along with your correspondence.

MOVING?

Simply attach the mailing label from this magazine and write in your new address below. (Please allow 4-8 weeks.)

Your New Address Goes Here

Name _____
 Address _____ Apt. # _____
 City _____
 State _____ Zip _____

FOR FAST SERVICE...

...it is better to write us concerning your problem and attach your magazine label to this coupon, or print your name and address as it appears on your label on a piece of paper and send it along with your correspondence. Should you need to reach us quickly the following toll-free number is available:

1-800-678-2666

Better Homes and Gardens®
WOOD

P.O. Box 10628 • Des Moines, Iowa 50336

Don't forget to include your old label!

FOLEY-BELSAW ONE-MAN PORTABLE SAWMILL

Goes right to the trees!

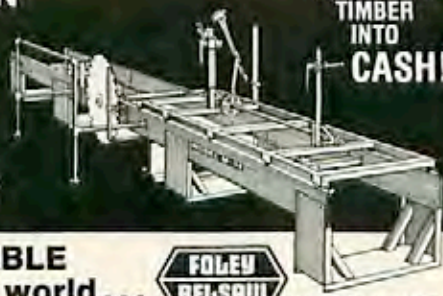

**TURN YOUR
 TIMBER
 INTO
 CASH!**

The only ONE-MAN PORTABLE SAWMILL of its kind in the world . . .



Established In 1926

. . . and still worthy of its 50-Year reputation for turning out accurately cut lumber at a LOW-COST!

Yes, if you're needing good, high-quality lumber don't let today's inflated lumber prices stop your important building projects. Take the Foley-Belsaw right to the trees and turn out foot-after-foot of smooth, true-cut lumber . . . even beginners get excellent results. For power use your tractor PTO or other gas, diesel or electric unit as small as 25-HP. Our factory-direct selling keeps the price low, and convenient time payments may be arranged.

And The Foley-Belsaw Can EARN You Extra Cash!

Just one man (no crew needed) can easily saw enough on weekends to **SAVE** hundreds of dollars over high lumberyard prices. But you can also Custom-Saw for others or sell the lumber produced from your timber and **EARN** excellent Cash Income — with a Foley-Belsaw the choice is **YOURS**. And when **YOU** are the **Boss YOU** pick the hours to work and **ALL** the **Profits** go in **YOUR** pockets.

There is **NO** obligation and **NO** salesman will call!



**FREE
 BOOKLET!**

ONE-MAN SAWMILL

Foley-Belsaw Co.
 6301 Equitable Rd., Dept. 30827
 Kansas City, Mo. 64120

Please send all facts and details **PLUS FREE** "How To Saw Lumber" Booklet. I understand there is **No** Obligation and that **No** Salesman will call on me.

NAME _____
 ADDRESS _____
 CITY _____
 STATE _____ ZIP _____

Send TODAY for FREE BOOKLET!

Just mail coupon for "How To Saw Lumber" booklet and complete facts on the One-Man Sawmill. Send to:

One-Man Sawmill
 Foley Belsaw Co.
 6301 Equitable Rd., Dept. 30827
 Kansas City, Mo. 64120

**HOW TO
 SAW
 LUMBER**



SHOP SENSE

LOOK WHAT ELSE A FOLDING RULE CAN DO

A rule with a slide-out extension makes many measuring jobs easy.

1 TAKE INSIDE MEASUREMENTS



Extension rules excel at inside measuring jobs. Because they're rigid, they give more precise readings than a flexible steel tape. First unfold as many sections as needed, then pull out the brass extension slide to complete the span. Check the reading on the slide, then add this measurement to the total length of the unfolded sections of the rule (sections typically measure 7" for the first and last, 6" for the others).

2 MARK PARALLEL LINES



Looking for a quick way to draw a line parallel to an edge? If you don't have a marking gauge handy, a folding rule will do the job almost as well. First, align the dimension you want with the edge, and hold the rule in place with your thumb and finger as shown in the photo above. Then place your pencil against the extension, and slide the rule and pencil slowly toward you along the stock.

Continued on page 93

SHOP SENSE

Continued from page 91

3 SET DIVIDERS

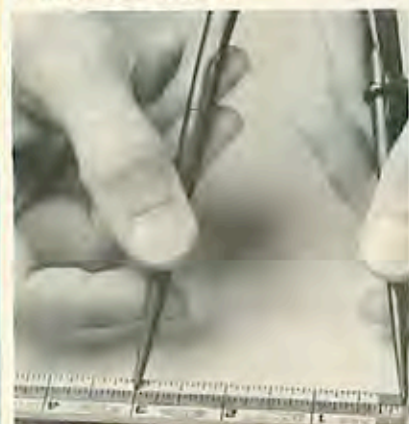

You'll also find a folding rule superior to a steel tape for precision measuring tasks, such as setting dividers, calipers, or a pencil compass. To set these measuring devices, hold the very tip of one leg against the end of the rule, then set the other leg to the desired measurement. One type of folding rule available already has slide-out calipers to measure the thickness of lumber or the diameter of round stock.

4 GAUGE HOLE DEPTHS



Want to know the exact depth of hole or mortise? The extension gives you a quick, accurate reading. Position one side of the rule end on the edge of the hole. Then, slide the extension down into the bottom of the hole and take your reading. Standard rules are graduated in inches and sixteenths. You can also buy versions that divide feet into tenths and hundredths, and ones with metric markings to the millimeter. 🌲

ANYTIME ANYWHERE ANYWOOD

mold plane and edge



Professionals and hobbyists alike know the strengths of the W&H molder-planer. Superior US-made construction and quick two-minute cutter changes make it a snap to cut moldings and plane hardwoods. It's fast, easy, and super-smooth.

Picture frames. Crown moldings. Raised panels. And more. Our three models offer the best value in your shop or on the job site!

Our five-year warranty and free 30-day trial are your assurance that W&H goes the distance.

Mail this ad or call us toll-free today.

1-800-258-1380 In NH 603-673-3446

Williams & Hussey Elm Street Dept. 238AM
Milford, NH 03055

YES! Send your free information kit today.

Name _____

Address _____

City _____ State _____ Zip _____

I am a professional I am a hobbyist

I am also interested in your 12" lathe



MAR-WOOD HARDWOODS

of PHILADELPHIA

Presents

WORLD'S FASTEST, MOST VERSATILE WOODWORKING CLAMPS!

CLAMP'N
TOOL GUIDE

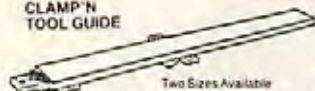

Two Sizes Available

The first "obstruction-free" straight edge bar clamp with unlimited uses. (See Clamp • Power Tool Guide • Jig Clamp • Straight Edge • Auxiliary Fence. Wide edge to edge grip. No surface marking. No "C" clamp hassle!



CT24C -24" - \$22.95

CT50C -50" - \$29.95

BACK-TO-BACK
BENCH CLAMP

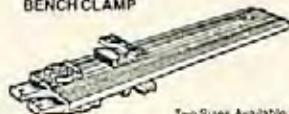

Two Sizes Available

Instant Bench Clamp. Bottom jaws clamp to table top or saw horse while top jaws hold the work piece. Obstruction free—no hold-downs or "C" clamps. End test jig applications. Superwide capacity.



BB18C -18" - \$29.95

BB36C -36" - \$39.95

TWO
STYLES

FOUR
SIZES

"Take my word for it, they're a real God-send if you have ever struggled with make shift straight edges & "C" Clamps."

Fran Oldynski, Pres. Mar-wood, Inc.

"We field a world class lineup": DELTA, PORTER-CABLE, RYOBI, BOSCH
RECORDS/MARPLES, SORBY, & ETC.

To order by Mastercard/Visa:
Call Toll Free outside of PA
1-800-255-8363
In PA call
1-215-663-0446

Or send check or money order to ➔

Mar-Wood Hardwoods
Woodworking Tools & Supplies
406A Huntingdon Pike
Rockledge, PA 19111

New Math for Woodworkers.

Price + Quality = Value

For years woodworkers have had to choose between low priced equipment that doesn't perform or quality equipment that costs too much.

See a demonstration of KITY machinery (or better still, try one in your shop for 30 days — free), and see why we guarantee that KITY is the World's Best Machinery Value.

Individual Machines

10" Table Saw
3-Speed Shaper
10" Jointer/Planer
1-HP Band Saw
Slot Mortiser
V.S. Lathe
Duplicator
KITY-Speed Table Wax
Right-Angle Miter Gauge

Combination Machines

K-5 8" Table Saw
6" Jointer/Planer
Spindle Shaper
Slot Mortiser

KDD 9" Table Saw
10" Jointer/Planer
Spindle Shaper
Slot Mortiser

Call or Write for More Information and the Demonstration nearest you.

1-800-USA-KITY

2315 Keystone Drive • Blue Springs, MO 64015

	<p>Distributed in the U.S. Exclusively by</p>	<p>FARRIS MACHINERY</p>
---	---	------------------------------------

World's Best Machinery Value



The Excalibur T-Slot Saw Fence

When choosing investments, cheaper isn't better... better is better!



A Cut Above Lesser Saw Fences...

...and there's a good reason why

Like any other precision tool, a saw fence is an investment. And when it comes to choosing investments, cheaper isn't better. Better is better. So T-Slot owners rightfully count themselves among the ranks of perfectionists who have high standards and are willing to pay a bit more to maintain them. A better saw fence... and a more accurate one. The Excalibur T-Slot saw fence will convert your table saw into a precision wood-cutting machine.

EXCALIBUR MACHINE & TOOL COMPANY

U. S. A.
210 Eighth St. South
Lewiston, NY 14692
Toll Free: 1-800-387-9789

CANADA
3241 Kennedy Rd., #7
Scarborough, Ont. M1V 2J9
(416) 291-8190

- ✓ Quick installation on General, Rockwell/Delta, Powermatic, Craftsman and most other saws
- ✓ Slipping of large stock is quickly accomplished
- ✓ Positive front and rear self locking
- ✓ The necessity of always having to retrace from the saw blade to the fence has been eliminated
- ✓ Built in scale and adjustable belt-horne cutter for precise cuts every time
- ✓ Easy parallelism adjustment
- ✓ Efficient accessibility for slipping to right or left of saw blade — plus many more exciting features, including the Ultimate Guarantee

For the name of your nearest Dealer, please Phone 1-800-387-9789

SHOP SENSE



HOW WOOD-WISE ARE YOU?

Test your wood lore with these true or false tales. You'll find the answers on page 96. Don't peek!

- 1 Philippine mahogany is the same as Honduras mahogany, except that it grows in the Philippines.
 True. False.
- 2 Everyone knows that iron-wood ranks as the world's hardest wood.
 True. False.
- 3 Trees actually produce the raw material for chewing gum.
 True. False.
- 4 Ash was so named because so much of it remains after it burns.
 True. False.
- 5 Heartwood sustains the life of a tree by circulating nutrients.
 True. False.
- 6 Spaniards in Columbus' time called lignum-vitae the "wood of life" because they thought it would never decay.
 True. False.
- 7 Teak, although a large tree, has comparatively small leaves.
 True. False.
- 8 Balsa is the lightest weight wood you can buy.
 True. False.
- 9 Peavy and Spud were famous New England furniture makers.
 True. False.
- 10 Tree bark is porous.
 True. False.

Answers on page 96

America's Finest Do-It-Yourself Clocks!

Kits and Plans



Join the thousands who have discovered the best way to build a clock starts with CRAFT PRODUCTS COMPANY America's leading supplier of do-it-yourself products since 1940!

COMPLETE KITS include ready-to-assemble pre-cut wood parts, movement, dial, hardware, glass and instructions. Our PLANS KITS include detailed plans, all above components, you supply the wood.

Amherst School Clock

An imposing, solid oak traditional case with West German solid brass 8-day Westminster chime movement. Chimes play every quarter hour. A real collector's piece... worth well over \$300 when finished!

1335 F43 Complete Kit \$169
92780 Plans Kit \$ 99

Shipping and Handling: Add \$5 per kit
Wisconsin Residents add 5% Sales Tax

FREE SHIPPING ON ORDERS OVER \$150



Bedford Bracket Clock

Enjoy the traditional charm of this popular English design. Select solid walnut richly surrounds elaborate brass and silver finished dial. Ultra-accurate quartz movement plays Westminster chime melody at the hour.

1367 W82 Complete Kit \$59.50
92700 Plans Kit \$17.90

28 1/4" H
16 1/2" W

10 1/2" H
8 1/2" W

FREE CATALOG

Anyone interested in building fine clocks should not miss this collection of clock kits, quartz and traditional brass movements, dials and hard-to-find hardware items. There is a challenge for all skill levels with kits ranging from \$20 to \$2000. Call today for your copy!

CALL OR WRITE TODAY!
(715) 823-5101



Craft Products Co.

P.O. Box 326, Dept. BG8J, Clintonville, WI 54929

Serving America's Craftsman Since 1940

SHOP SENSE

Questions on page 94

- 1 **False.** Central and South American mahoganies, such as Honduras, belong to the swietenia genus, while Philippine "mahogany" is a shorea.
- 2 **False.** Botanically, there just isn't any specific wood named "ironwood." The term refers to the heaviest or hardest wood found growing in a region.
- 3 **True.** The chicle tree of Mexico, South America, and the West Indies yields a latex used in making chewing gum.
- 4 **False.** Just the opposite. Little ash remains after burning.
- 5 **False.** Heartwood supports and strengthens the tree, but the sapwood has the vascular system to circulate nutrients.
- 6 **False.** When Columbus lived, resin from lignum-vitae was thought to be a cure-all.
- 7 **False.** Teak leaves are among the largest in the world, often measuring 2x3'.
- 8 **True.** But balsa is not the world's lightest wood. Although never sold commercially, *Aeschynomene hispida*, from Cuba, claims that title. It weighs about five pounds per cubic foot to balsa's 10 lbs.
- 9 **False.** A peavy and a spud are two logging tools used to remove bark from a felled tree.
- 10 **True.** Air flows through tree bark to the sapwood. That's why corks, made from the bark of the Mediterranean cork oak, must be cut in the direction of the grain. If corks were cut from the bark radially (crossgrain, from the outside of the bark to the center), they would leak. ☛

How do you rate?

- 0-2 correct - Mere seedling
- 3-5 correct - Sapling
- 6-8 correct - Saw timber
- 9-10 correct - Veneer log

NOW RING MASTER™ attaches to your:

NEW! SHOPSMITH MARK V®



Create Any Hollow Cylindrical Shape up to 12" dia. Cut flat wood into straight or angle rings, stack rings, glue, sand, & finish. All on your Ring Master.

CRAFTSMAN 12" LATHE

\$199

ORIGINAL RINGMASTER™
WITH MOTOR

\$399

CALL 1-800-854-9815
FOR FREE BROCHURE.

Project A

Using one board foot of wood, a lathe project enclosed 89.06 cubic inches. All enclosed area was wasted wood.

Project B

Using a Ring Master the same amount of wood enclosed 611 cubic inches, with virtually no waste.

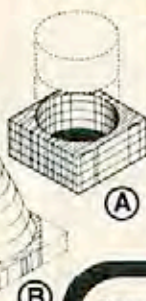

**EASY, FUN
and
PROFITABLE
to
operate!**

ORDER NOW!

RING MASTER, INC.
DEPT. A
P.O. BOX 8527A
ORLANDO, FL 32856
IN FLORIDA CALL (305) 859-2664

Please send me complete facts about the ALL NEW Ring Master:

Name _____

Address _____

City _____ State _____ Zip _____

Ring Master DEALERS wanted in all areas.



RING MASTER

The Bulletin Board

WOODWORKING FACTS, FACES, AND FABLES

BEAUTY AND THE ITCH

Rosewood's beauty tantalizes the eye. Its scent tickles the nose. But its dust can make you itch.

Craftsmen working rosewood often develop a skin rash resembling poison ivy. The cause: rosewood's unusually high content of acids, alkaloids, gums, resins, salts, and tannins. Some people never experience an allergic reaction to these "extractives," others only get it in the summer, when rosewood dust clings to perspiration.

Research points to only four real culprits: Brazilian rosewood, East Indian rosewood, East Indian blackwood, and cocobolo, all members of rosewood's *Dalbergia* family.

MUSEUM PAYS HOMAGE TO THE HOLTZAPFFEL

During England's Victorian era, artisans used special "Holtzapffel" lathes with revolving cutters (shown above) to produce delicately turned works in ebony, boxwood, and ivory. Soon, practitioners of this advanced lathe work called "ornamental turning," or those wanting to learn, will have a U.S. mecca to visit.

The Museum of Ornamental Turning, in North Andover, Massachusetts, will present this decorative art to the public. Founded by ornamental turners Richard I. Mil-

ler and Warren G. Ogden, Jr., the museum (housed in Ogden's spacious private residence, library, and workshop) plans to provide exhibits, demonstrations, research, and a quarterly newsletter. Membership costs \$15 annually. At present, visits are by appointment. For more information, or arrangements to visit, write: *Richard I. Miller, Secretary/Treasurer, The Museum of Ornamental Turning, c/o 1661 South Research Loop, Tucson, AZ 85710.*

Turned boxes: Richard I. Miller

THE WORLD'S OLDEST TOOL

Of all tools for working wood, history points to the axe as the oldest. It has been used as a hand tool by man for over 10,000 years, with only minor refinements and changes in basic appearance.



TERROR TREE OF THE EVERGLADES



In South Florida, the *Melaleuca quinquenervia*, a tree transplanted from Australia more than 80 years ago, terrorizes the Everglades. According to *Time* magazine, foresters, naturalists, and conservationists fear that the tree, known variously as cajeput, punk tree, and paper-bark tree, will eventually displace much of that part of the state's natural trees and plants if its advancement isn't thwarted.

A first cousin to the eucalyptus, the pesky tree gulps so much water it dries out swampland. Its oil-filled leaves turn the tree into a pyrotechnic torch at a wildfire's faintest spark. Despite this, fire won't kill it. The thick, soft bark insulates the wood as the leaves burn. Moreover,

the tree invades areas cleared of native vegetation, grows into thick stands, and virtually takes over by crowding out other desirable plants. Locals joke that even rabbits can't probe the tangle.

Melaleuca was first planted in 1906 by a well-intentioned forester as a potential commercial hardwood. However, its wood has such a high moisture content that sawmilling and seasoning prove impractical. With no harvest, the tree proliferates. Tight government budgets have limited the battle with the tree's encroachment to hand-to-hand combat. Workers use machetes to hack the trees, then pour toxic chemicals into the slashes. ♣

Illustrations: Jim Stevenson