

Better Homes and Gardens®

# WOOD

THE MAGAZINE FOR HOME WOODWORKERS

\$3.95

AUGUST 1988 • ISSUE NO. 24  
Display until August 16

## DRILL PRESSES

What to know before  
you purchase one

17 ways to put this tool  
to use in your shop

## IMPROVE YOUR PROJECT PHOTOGRAPHS

Our tips help you get  
professional results

## SHOP SAFETY

Your eyewear options

## SUPER PROJECTS

Outdoor planters

3 cutting boards

Adjustable sawhorse

Mosaic wall hanging

Hillbilly carving

Low-boy truck

Rugged dump truck

## EYE-CATCHING WOOD MOSAICS

See page 38

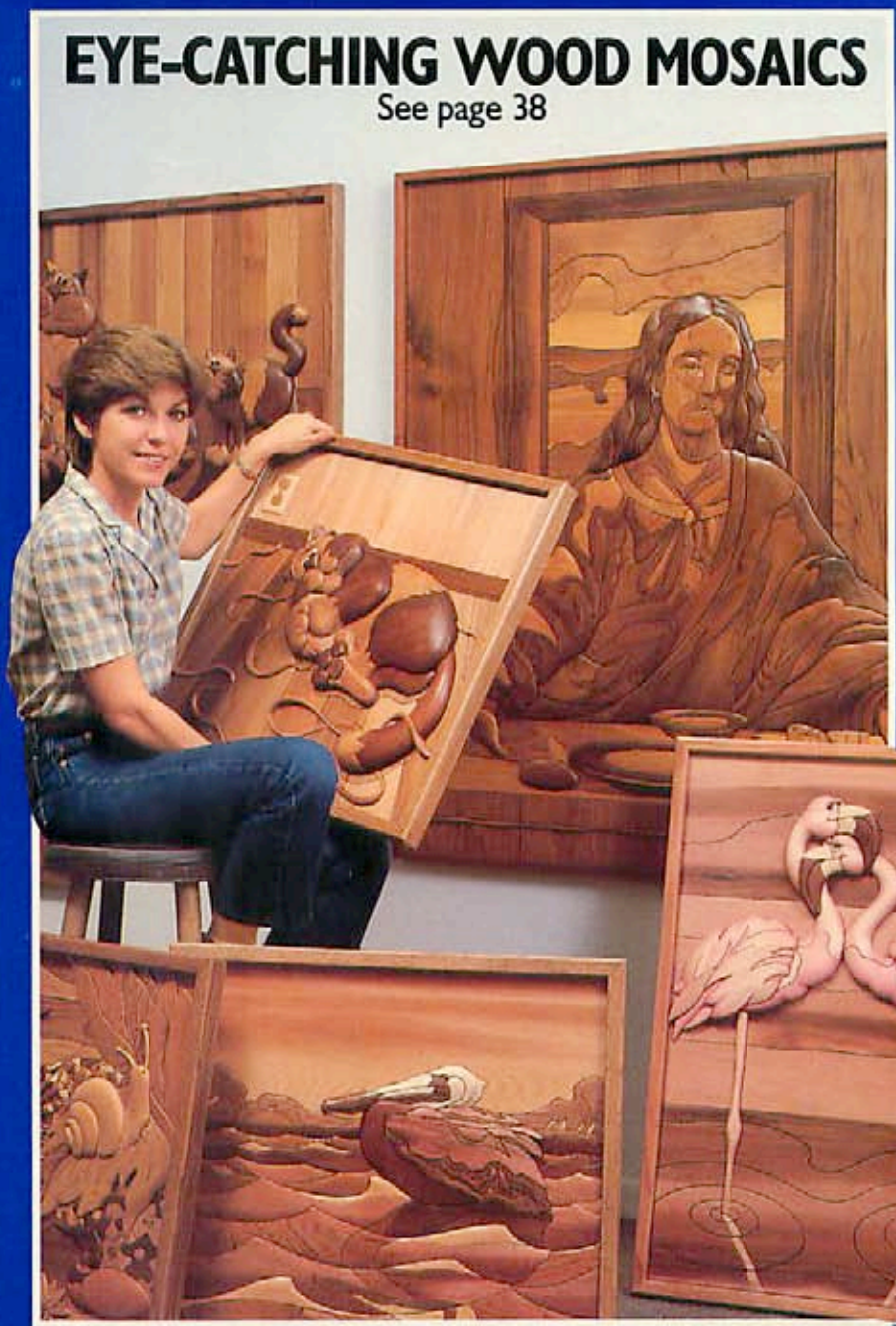

# MORE POWER TO YOU.



With Makita cordless power tools anything is possible. You can turn raw lumber into finished furniture. Add a new room to your house. Even build a new house.

Because Makita tools do more than free you from a power cord. They connect you to two heavy-duty cordless systems. An extensive 15-tool, 7.2VDC system. And a versatile 10-tool, 9.6VDC system. Each with an interchangeable battery that gives you more than enough power to get the job done.

In fact, more professional builders use Makita power tools than any other cordless. Maybe they're impressed by the quality of our tools. Maybe it's their power.

Maybe it's because we have the industry's broadest cordless tool line.

Or maybe they know that the most impressive thing about Makita cordless tools is what they build. Reputations.

**Makita**  
IT'S ALL THE POWER YOU NEED.™

Makita U.S.A., Inc., 14930-C Northam St., La Mirada, CA, 90638-5753, (714) 522-8088

# Total Shop

## We Can't Promise!

These prices may never be this low again!

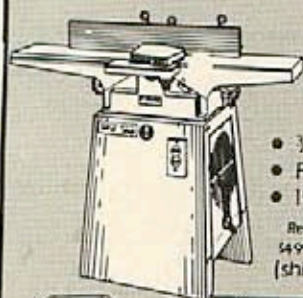

### 6" Heavy Duty Jointer

- ¾ hp, 110v
- Fully adjustable
- 190 lbs.

Reg. \$499.00  
**\$299.00**  
(ships freight collect)

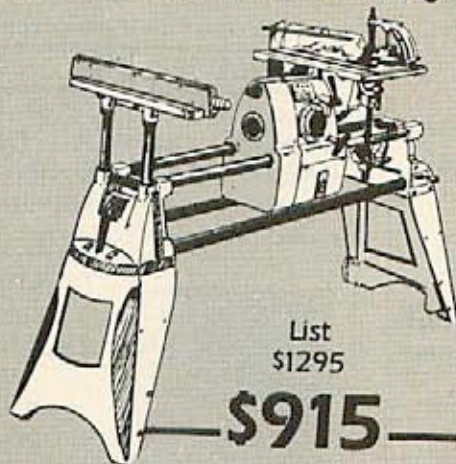

List \$1295

**\$915**

Very soon we'll have to raise our prices, including the tremendous buy on this multipurpose machine. Call now and we will send you 15 more reasons why Total Shop is a better buy than Shopsmith

**But You Better Hurry!**

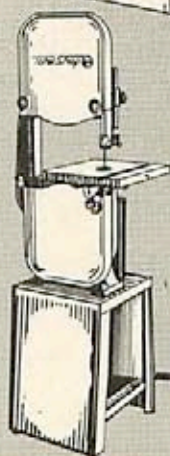

### TS 14-56 14" Bandsaw

- Blade size up to ¾" wide
- Cast iron construction
- 156 lbs.
- ¾-hp

**\$259.00**  
(ships freight collect)

Call Toll Free **1-800-845-9356** or in S.C. 288-4174

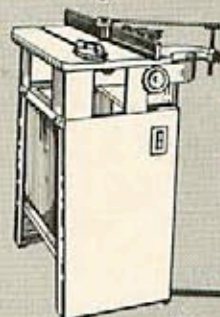

### Wood Shaper

- ½" Spindle
- 1 hp
- Cast iron construction
- Precision fence
- 160 lbs.
- Ball bearings

Reg. \$499.00  
**\$239.00**  
(ships freight collect)

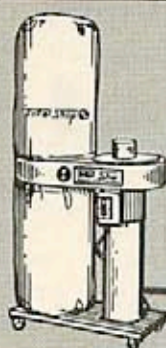

### Dust Collector

- 1 hp, 110v
- 4" inlet
- Commercial quality
- Compact size

Reg. \$348.00  
**\$209.00**  
(Shp. & Hdlg. \$30.00)

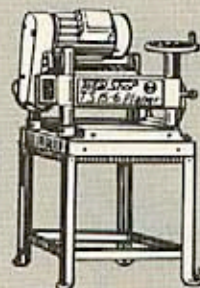

### TS 15-6 Planer

- 110v (owner convertible to 220v)
- Optional stand & Dust Collector Available
- 15" x 6" Board Capacity

**\$795.00**  
(ships freight collect)

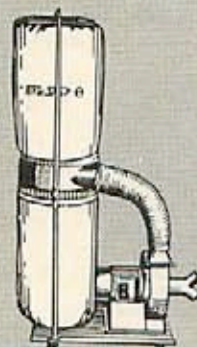

### Industrial Dust Collector

- 2 hp, 110v
- Two 4" inlets
- 1185 CFM
- 125 lbs.

\$499.00 Value  
**\$339.00**  
(ships freight collect)

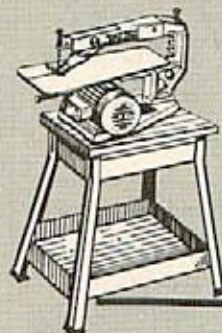

### 15" Scroll Saw

- Fully adj. table
- 2" cut depth, ¾" stroke
- Free work/storage table. A \$49.00 value
- 25 assorted blades included

**\$199.00**  
(Shp. & Hdlg. \$20.00)

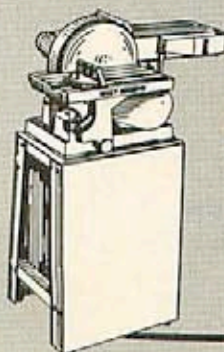

### 6" Belt Sander

- ¾ hp
- 6" x 48" belt
- Cast iron construction
- 152 lbs.
- 9" Sanding Disc Included
- Ball Bearings

**\$199.00**  
(ships freight collect)

30 MINUTE DEMONSTRATION VIDEO

Total Shop

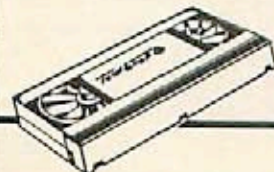

- YES! Please send me your free 24 page catalog
- YES! Please send me your 30 minute demonstration video (Enclose \$10.00 refundable deposit - specify VHS or Beta)

P. O. Box 25429, Greenville, SC 29616  
Dept. Q  
Name \_\_\_\_\_  
Address \_\_\_\_\_  
City \_\_\_\_\_  
State/Zip \_\_\_\_\_  
Phone \_\_\_\_\_

**FREE 24 PAGE CATALOG**

Call Toll Free or Write for our newest catalog today **1-800-845-9356**

**NOW!  
REDUCE THE  
RISK AT YOUR  
TABLE SAW**



folds down neatly

WITH THE **MOBILE SAWING CENTER**

**OUTFEED ROLLERS**

- safe, accurate sawing
- handle panels with ease
- available in 15" and 37" widths
- dual-position table

**AND INCREASE FLOOR SPACE**

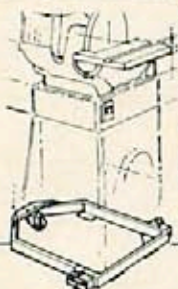

**MOBILE MACHINE BASES**

- increase shop working area
- maximize usable floor space
- 3 point base will not rock
- locking wheels
- makes machine so easy to use and store
- over 80 standard models

**PLANER STAND WITH ROLLERS**

- raises planer to proper working height
- provides machine mobility
- five-fold increase in workpiece support
- storage is a snap



**NEW**



**ROLLERTABLE Rock Solid Support**

- adjustable
- portable
- use at any machine

PEDESTAL ROLLER

Discover HTC's many unique products designed only with you, the dedicated woodworker in mind. Find out how you can make your machining safer, increase working area of your shop and accomplish nearly impossible tasks easily, quickly and accurately - **all by yourself!**

**CALL TODAY!**

HTC PRODUCTS, INC.  
120 E. HUDSON S-8  
ROYAL OAK, MI 48067  
(313) 399-6185



1-800-624-2027 ext. 108

Better Homes and Gardens®

**WOOD**

This issue's cover wood grain: Sassafras

**AUGUST 1988**

**ISSUE NO. 24**

WOOD PROFILE

**PADAUK: THE WOOD OF KINGS, RAILROAD TRAINS, AND MANY NAMES** 25

From the chalices of emperors to Empire-style furniture and Pullman cars, padauk has won worldwide fame under assorted names.



SHOP-TESTED TECHNIQUES

**17 WAYS TO TURN YOUR DRILL PRESS INTO A SHOP HERO** 26

Dust off your drill press and explore some new ways to expand the versatility of a valued workshop friend. We also show you how to build four helpful jigs to make your drill press even more effective.



**HEAVY HAULIN' LOWBOY AND DUMP TRUCK** 32

Our fleet of heavy-duty toy trucks continues to grow! The newest additions, a lowboy and dump truck, share the same sturdy, simple tractor design.



DEVELOP YOUR SHOP SKILLS

**THE PERFECT HINGE MORTISE** 37

Learn how the pros give their hinged projects that "cabinet-quality look." We show you step-by-step how to cut hinge mortises.



CRAFTSMAN CLOSE-UP

**SHE PAINTS WITH WOOD** 38

Feast your eyes on some remarkable wood mosaics crafted by Texas artist Judy Gale Roberts. And don't miss the exclusive pattern Judy created for WOOD magazine readers.



**MAKE YOUR BEST PROJECTS PICTURE-PERFECT** 44

Even though you've rubbed on that final coat of wax, your project isn't "finished" yet! Learn how to make stunning pictures of your best handiwork.

A TERRIFIC TRIO

## SUNBURST SINK BOARD 50

Laminate maple and walnut strips to create the cheeriest board this side of sunrise.



## ART-DECO CHEESE BOARD 54

Step back into the past with our handsome board reminiscent of the 1920s and 30s.



## TEXAS TOAST CUTTING BOARD 55

Take a small bite out of an evening and whip up our sandwich board for your next gathering.

TOOL BUYMANSHIP

## THE HOLE STORY ABOUT TODAY'S DRILL PRESSES 56

Even though one Taiwanese plant produces most of the drill presses on the U.S. market, there are differences you should consider before buying. We tested 10 popular benchtop and floor models priced under \$800.



## TRIPLE-CROWN SAWHORSE 62

This sawhorse wins on all counts—it's sturdy, attractive, and adjustable. Build our design from a 2x4, a little maple, and less than a 4x8' sheet of plywood.



## KEEP SAFETY IN SIGHT 64

If comfort and appearance have kept you from wearing safety glasses, you've run out of excuses. See what's offered in your price range.

## PLANTERS APLENTY 68

Readily available, durable cedar fencing makes our trio of planters a handsome set for any patio. They're affordable, too—for about \$90, you can knock out this set in no time at all.



## SHORT-SUBJECT FEATURES

Editor's Angle .....	6	Project Showcase .....	48
Talking Back .....	10	Drill Press	
Tips From Your		Grinding Jig .....	74
Shop (And Ours) .....	16	Carving Pattern .....	76
Products That Perform .....	20	Finishing Touches .....	96

# WOODWORKS

## American Made Woodturnings

3-1/2" Maple Shaker Pegs	2-1/2" Stubble Peg	1-3/4" Mini Shaker Pegs	3-3/8" Kitchen Mug Pegs	2-7/16" Tie Rack Pegs	Bean Pot Candle Cup	Medium Bean Pot	Small Bean Pot	Mini Bean Pot
\$20.00/100	16.00/100	7.00/100	20.00/100	7.00/100	17.00/100	15.00/100	12.00/100	10.00/100
Qty.	Total							

## LOW PRICES

Dia. x Thick		(24 Size)		
3/4" x 1/8" Hearts	\$3.00/100			
3/4" x 1/4"	5.00/100			
3/4" x 1/2"	8.00/100			
1-1/4" x 1/8"	9.00/100			
1-1/4" x 1/4"	11.00/100			
1-1/4" x 1/2"	3.50/25			
1-3/4" x 1/8"	3.75/25			
1-3/4" x 1/4"	5.00/25			

## HIGH QUALITY

3/4" Full Round Balls	1" Full Round Balls	Large Egg 1-7/8" x 2-1/2"	Small Eggs 1-3/8" x 2"	5/8" Mini Eggs
\$8.00/100	10.00/100	35.00/100	25.00/100	10.00/100
		1" Toy Wheel	1-1/2" Toy Wheel	Axle Peg
		6.50/100	10.00/100	4.50/100

## FAST SERVICE

3/8" Maple Buttons	1/2" Maple Buttons	3/8" x 2" Dowel Pins	1-1/2" Maple Spindles
\$2.15/100	2.25/100	2.20/100	12.00/100
			2-1/8" Maple Spindle
			18.00/100
			Picture Hanger
			1-5/8" Sawtooth Hanger
			4.50/100
			Nailless Sawtooth Hanger
			8.00/100

## MONEY BACK GUARANTEE

**BONUS** CHECK THIS BOX, AND AS A BONUS WITH ANY ORDER FOR WOOD PARTS, WE WILL SEND YOU A COMPLIMENTARY 8 OZ. BOTTLE OF FRANKLIN TITE-BOND WOOD GLUE.  CHECK HERE **\$2.25 VALUE #B3**

## ORDER NOW

	TOTAL FOR GOODS	
	TEXANS ONLY ADD 6% SALES TAX	
32 PAGE 887 CATALOG \$1.00 (Free With Order)	HANDLING AND INSURANCE	\$3.00
	FINAL TOTAL	

MC OR VISA  ACCOUNT # \_\_\_\_\_ CHECK ENCLOSED

EXPIRES \_\_\_\_\_ PHONE \_\_\_\_\_

NAME \_\_\_\_\_

SHIP TO \_\_\_\_\_

CITY/STATE/ZIP \_\_\_\_\_

**817/281-4447 B7**

**WOODWORKS**

4013-A CLAY AVE. • FT. WORTH, TX 76117

**NOW! TIMELESS BEAUTY...  
IN NO TIME AT ALL.**



**Announcing WoodSheen™**  
*Rubbing oil stain and finish in one easy step.*

A traditional finish used to take days to achieve. Now, with new WoodSheen by Minwax, you can have the look of a deep, hand-rubbed finish in just two hours! Simply wipe it on with a cloth—in one easy step, you'll have rich color and a tough protective Danish oil finish. New WoodSheen penetrates deep into wood, so it highlights the beauty of the grain. And it dries in just two hours! Available in 6 rich colors plus Natural.

For a free copy of Tips on Wood Finishing write to Minwax Co. Inc., Dept. WO-078, P.O. Box 426, Little Falls, NJ 07424.



**NEW!** COMBINATION VERTICAL  
PANEL SAW/ROUTER PLANS



Now even working alone you can easily make deadly accurate cross and rip cuts up to five feet wide in plywood and sheet goods • Instant set up on V Grooves, Dados, Rabbits and more • Inexpensive and easy to build utilizing your saw and router • Ideal for amateurs and pro's alike. For complete plans and parts list send \$14.95 today to: Brad O'Conner, 11 Cypress Drive, Denville, NJ 07834. NJ residents add 90c sales tax.

**CLOCK PLANS**

**FULL SIZE**

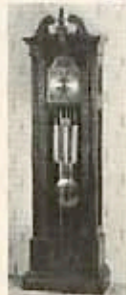

Over 40 Styles  
Build your own Grandmother, Wall, Shelf or Bracket Clocks from our plans - several Antique Reproductions included  
FULL LINE of Quartz and Mechanical Movements, Hardware, Dials, Trim & Glass

Catalogue \$3.95  
Refundable

**SWEETHEART PRODUCTS CO.**  
P. O. Box 1297W  
Loveland, CO 80539

Better Homes and Gardens  
**WOOD**

THE MAGAZINE FOR HOME WOODWORKERS

August 1988 • Vol. 5, No. 4 • Issue No. 24

**Editorial/Art Staff**

Editor **LARRY CLAYTON**  
Managing Editor **CARL VOSS**  
Art Director **C. L. GATZKE**  
Design Editor **JAMES R. DOWNING**  
Features Editor **PETER J. STEPHAN**  
How-To Editor **MARLEN KEMMET**  
Products/Techniques Editor **BILL KRIER**  
Project Builder **JAMES E. BOELLING**  
Senior Graphic Designer **PERRY A. McFARLIN**  
Administrative Assistant **DARLENE REYNOLDS**  
Business Office Clerk **JODI DOWNING**

Technical Consultants: **GEORGE GRANSETH** Product Testing; **PAUL L. McCLURE** Wood Technology; **PHILIP WHITBY**, Collectible Tools

**Publisher JERRY KAPLAN**

National Advertising Manager **MARK S. HART**  
Advertising Representatives **ANTHONY IMPERATO**,  
**ROBERT NEWKIRCHEN**, **JASON B. WEINGER**  
Promotion/Research Director **THOMAS R. TROLAND**  
Marketing Services Manager **NANCY DALY**  
Circulation Director **WILLIAM HUMMEL**  
Circulation Manager **BILL REED**  
Production Director **DALE SCHENKELBERG**  
Editorial Research Director **C. RAY DEATON**

**Weekend Woodworking Projects™**

Managing Editor **JIM HARROLD**

**Magazine Group Officers**

Group President **JAMES A. AUTRY**  
Group Vice Presidents: Publishing Directors **ADOLPH AUERBACHER**, **MYRNA BLYTH**, **BURTON H. BOERSMA**; **CHRISTOPHER M. LEHMAN**; Editorial Director **DORIS M. EBY**; Operations **DEAN PIETERS**

Chairman of Executive Committee **E. T. MEREDITH III**

**Corporate Officers**

Chairman of the Board **ROBERT A. BURNETT**  
President **JACK D. REHM**  
Group Presidents: Book **JERAMY LANIGAN**; Broadcasting **W. C. McREYNOLDS**; Magazine **JAMES A. AUTRY**; Real Estate **ALLEN L. SABBAG**;  
Vice Presidents: Administrative Services **GERALD D. THORNTON**; Corporate Relations **DONALD L. ARNOLD**; Finance **JAMES F. STACK**; General Counsel and Assistant Secretary **THOMAS G. FISHER**;  
Product Development **NEIL KUEHNL**; Special Projects **FRED STINES**  
Corporate Secretary **BETTY CAMPBELL MADDEN**  
Treasurer **MICHAEL A. SELL**  
Corporate Controller **LARRY D. HARTSOOK**

Better Homes and Gardens® WOOD® - the magazine for home woodworkers (ISSN 0743-894X) is published bimonthly in February, April, June, August, October, and December by Meredith Corporation, Locust at 17th, Des Moines, IA 50336. Second class postage paid at Des Moines, Iowa. Trademark registered in Canada and Australia. Marca Registrada en Mexico. **SUBSCRIPTION PRICES:** One year \$18 in the United States and its possessions. Canada and other countries add 46 per year. **POSTMASTER:** Send address changes to WOOD, 1716 Locust Street, Des Moines, IA 50336. August 1988, Vol. 5, No. 4, Issue No. 24. **CUSTOMER SERVICE:** For service on your magazine subscriptions, including change of address, write to Customer Service Manager **ROBERT AUSTIN**, P.O. Box 10628, Des Moines, IA 50336. Please enclose your address label from a recent issue. If you wish to phone, call toll free 1-800-678-2666.

© COPYRIGHT MEREDITH CORPORATION 1988. ALL RIGHTS RESERVED. PRINTED IN U.S.A.

# GRIZZLY'S MUCH AWAITED SUMMER SALE!

**EXPIRES SEPT. 30, 1988**

G1018 8"x 65" Jointer



Regularly \$665.00  
**SALE PRICE \$625.00**

G1033 20" Planer



Regularly \$1295.00  
**SALE PRICE \$1175.00**

G1024 1/2" Shaper



Regularly \$245.00  
**SALE PRICE \$225.00**

G1182 6"x 47" Jointer



Regularly \$335.00  
**SALE PRICE \$310.00**

G1538 16" Bandsaw



Regularly \$495.00  
**SALE PRICE \$465.00**

G1662 Dowelling Jig



**SPECIAL PRICE \$39.95**  
**PREPAID TO YOU**

G1022 10" Tablesaw



Regularly \$365.00  
**SALE PRICE \$325.00**

G1014 6/9 Sander



Regularly \$195.00  
**SALE PRICE \$175.00**

G1522 Radi Plane



**SPECIAL PRICE \$18.95**  
**PREPAID TO YOU**

G1021 15" Planer



STAND IS  
OPTIONAL

**SPECIAL PRICE \$695.00**

G1183 6/12 Sander



Regularly \$395.00  
**SALE PRICE \$330.00**

G1518 15-Pc. Router Bit Set  
(Carbide-Tipped)



**SPECIAL PRICE \$125.40**  
**PREPAID TO YOU**

Unless otherwise stated, all above prices are F.O.B. Williamsport, PA or Bellingham, WA.  
Call for our fully loaded, full color 1988 catalog - it's free!  
2 warehouses to serve you better

If you live West of the  
Mississippi River contact  
our West Coast Warehouse at:

P.O. Box 2069  
Bellingham, WA 98227  
Phone: (206) 647-0801

Mon.-Fri. 8:30 a.m. to 5:00 p.m.



**IMPORTS, INC.**

If you live East of the  
Mississippi River contact  
our East Coast Warehouse at:

2406 Reach Road -  
Williamsport, PA 17701  
Phone: (717) 326-3806

Mon.-Fri. 8:30 a.m. to 5:00 p.m.  
Saturday: 8:30 a.m. to 1:00 p.m.







# Sharp Savings

## ...ON ADVANCED LASER-CUT BLADES!

### Laser Cut Blade Bodies

Laser Technology allows Freud to produce one of the quietest running, safest, and accurate running saw blades in the world.

Expansion slots on the Freud industrial saw blade are cut with a laser and are only .003 or less wide (about the thickness of a human hair). This assures tensioning strength for a true cut. It creates a quieter blade because there are no large holes or wide expansion slots for the air to whistle through. It guarantees a safer saw blade as there are no plugs in the expansion slot that can fly out when the blade is in use.

With this advanced technology, all shoulders and gullets are identical in shape and most important strength. The arbor holes are perfectly centered and rounded by precision grinding. An extra step to guarantee a true running blade.

### Special Carbide Mix

Freud produces a special mix of carbide at their own factory. It is produced from titanium and carbon using cobalt as a binder. Producing this important part of the saw blade within their own factory assures the consistency and quality needed to hold a sharp edge.

The carbide is induction brazed onto Freud's laser produced blade bodies. This process is computer controlled to guarantee uniformity of brazing. A razor edge is then put on the teeth with a 400 grit diamond wheel. This guarantees you of a blade that will provide a maximum of production hours before sharpening is needed.

E=Excellent G=Good F=Fair NR=Not Recommended  
8", 9", and 10" have 5/8" Bore.  
12" and 14" saws have 1" Bore.

Item No.	Diameter	Teeth/Grind	General Purpose	Cross Cut Wood	Plywood	Plastic	Rip Wood	List	Sale
LM72M008	8	24 Rip						68.48	51.48
LM72M010	10	24 Rip	NR	NR	NR	NR	E	77.93	50.68
LM72M012	12	30 Rip						104.03	65.98
LU78M008	8	64 TCG						112.57	93.98
LU78M010	10	80 TCG	G	G	E	E	NR	140.63	104.48
LU78M012	12	96 TCG						169.29	135.68
LU78M014	14	108 TCG						199.80	141.98
LU84M008	8	40 Comb						85.96	59.58
LU84M009	9	40 Comb						85.31	59.58
LU84M011	10	50 Comb	E	G	G	NR	G	89.54	52.18
LU84M012	12	60 Comb						135.31	97.98
LU84M014	14	70 Comb						161.34	116.48
LU85M008	8	64 ATB						112.08	73.98
LU85M009	9	72 ATB						122.56	76.98
LU85M010	10	80 ATB	NR	E	G	G	NR	133.25	85.58
LU85M012	12	96 ATB						161.40	114.98
LU85M014	14	108 ATB						179.06	124.88

## ...ON ADVANCED LASER-CUT DADO SETS!



Freud Carbide Tipped Dado Sets will produce a smooth and accurate groove when cutting either with or across the wood grain. Properly stressed and tensioned outside blades feature extremely sharp and steeply beveled carbide teeth that leave clean edges.

The laser cut blade bodies ensure the quietest running dado you can buy.

The 4 chippers and 2 outside blades can cut a width up to 13/16 of an inch. Can be used on softwood, hardwood and veneered plywoods with excellent results.

	Bore	List	Sale
DS306	6" set 5/8"	176.54	110.98
DS308	8" set 5/8"	216.18	118.98

# freud®

218 Feld Ave., High Point, NC 27264  
(919) 434-3171  
1570 Corporate Drive, Suite G  
Costa Mesa, CA 92626  
(714) 751-8866

The Number One Do-It-Yourself Book Club

Take any

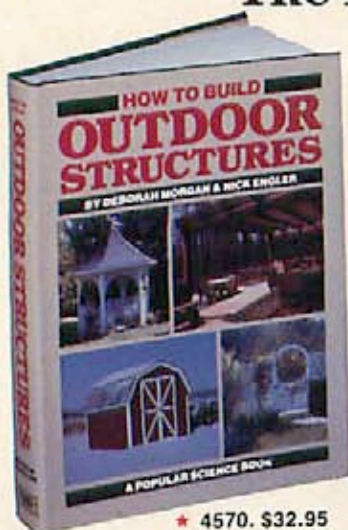

★ 4570. \$32.95 (counts as 2)

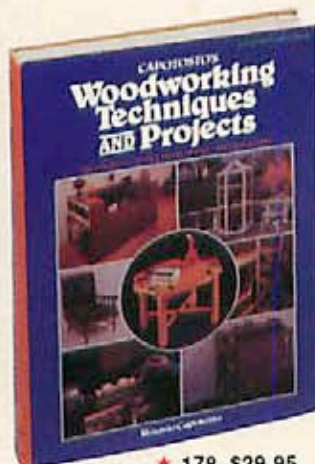

★ 178. \$29.95

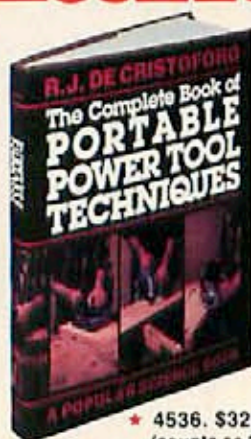

★ 4536. \$32.95 (counts as 2)

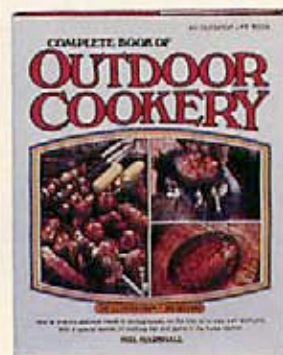

★ 166. \$26.50

# Popular Science

## BOOK CLUB

A Service of Grollier Book Clubs, Inc.

P.O. Box 2006, Latham, N.Y. 12111

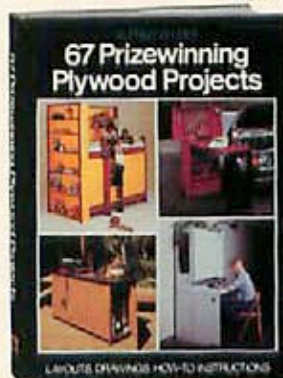

★ 4501. \$27.95 (counts as 2)

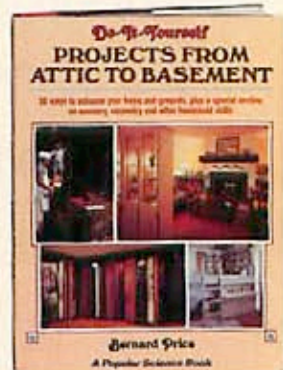

★ 4508. \$29.95



5821. \$39.95



6753. \$11.95



★ 89. \$19.95



★ 97. \$19.95



★ 105. \$17.95



5994. \$19.95



★ 113. \$15.95



★ 1978. \$17.85 Paperbound



3 Books—count as 1

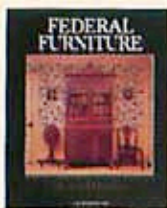

6085. \$24.95



6056. \$17.50



5831. \$19.95

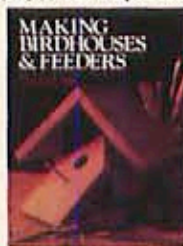

6041. \$16.95

Mail card today!

### The #1 DO-IT-YOURSELF BOOK CLUB

**The Best How-To Authority...** Popular Science Book Club is the largest and oldest special-interest book club serving successful do-it-yourselfers for more than 25 years!

**The Best Do-It-Yourself Books...** PSBC editors comb the country searching for the newest, finest and often hard-to-find books on today's important homeowner subjects: HOME REPAIR & IMPROVEMENT • HOME REMODELING, RENOVATION • RESIDENTIAL CARPENTRY • BASIC & ADVANCED WOODWORKING • HOME WORKSHOPS • HOUSE BUILDING • HOUSE WIRING, PLUMBING, HEATING, MASONRY & CONCRETE • APPLIANCE REPAIR and much more.

**Exclusive "Popular Science Books"...** PSBC serves its members best by commissioning the top how-to writers-photographers to produce definitive books on important Club subjects. See titles with ★. These are cream-of-the-crop, do-it-yourself books available nowhere else at Club discount.

**Big Bargains—UP TO 75% DISCOUNT...** PSBC cuts prices on hundreds of special book bargains offered throughout the year to the membership.

**Quality Production Control...** PSBC selections are printed with careful attention to detail on paper, printing, binding. You'll use these books for years!

**NO-RISK GUARANTEE...** PSBC guarantees your complete satisfaction—or you may return the books at our expense.

offers you super savings up to \$104.90!

**3** for just **\$4.95** Values up to \$109.95!

with No-Risk Free Trial Membership  
in Popular Science Book Club

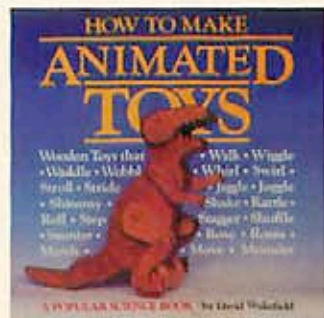

★ 4538. \$29.95 (counts as 2)



6027. \$16.95

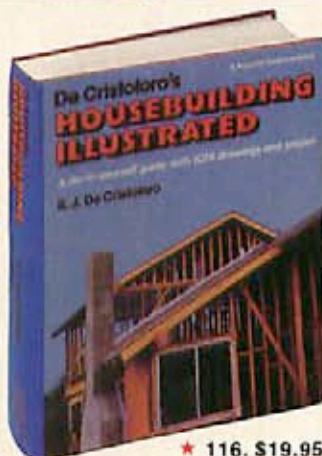

★ 116. \$19.95



5878. \$21.95

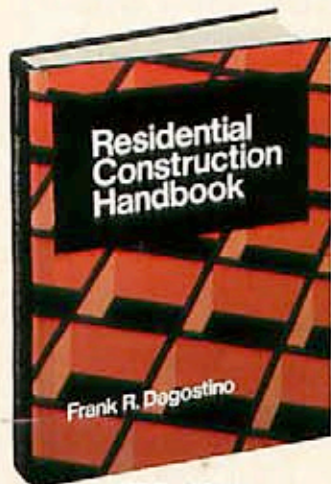

5858. \$39.95

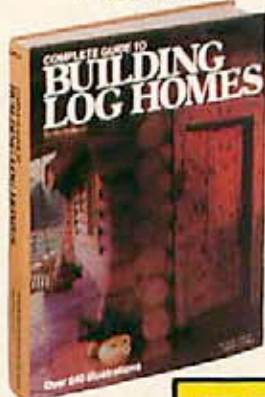

★ 190. \$29.95 (counts as 2)



★ 4569. \$14.95 Paperbound

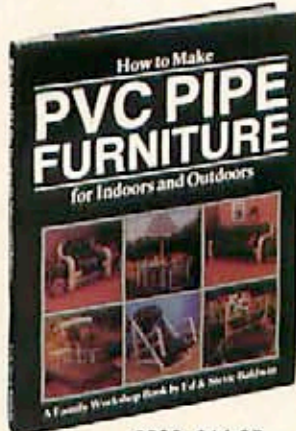

6002. \$14.95

HOW **Popular Science** BOOK CLUB WORKS

**ENJOY SAVINGS UP TO \$94.90 NOW**... When you take any 3 selections here for just \$4.95 plus delivery and handling. Simply indicate your choices on the attached postage-free card and mail.

**CLUB MEMBERS' BULLETINS**... Fifteen times a year (about every 4 weeks), you'll receive a Club Members' Bulletin package describing the coming Main Selection and nearly 100 additional books you may choose from. If you want the Main Selection only, do nothing; it will be sent to you automatically. If you want another book—or no book—indicate your wishes on the form provided and return by date shown. You will always have at least 10 days to do this. Should the bulletin arrive late and you receive an unwanted selection, you may return it at our expense.

**UP TO 75% DISCOUNTS**... Club prices range from \$5.99 for special book bargains offered at super savings up to 75% and even more... all the way to richly-produced, very special books that list as high as \$50 and more—all offered to members at exclusive Club discounts.

**FREE GIFT with cancellation privilege**... You may cancel your membership at any time after buying just two more selections of your choice within a year. To try us with no obligation, simply mail the attached card—a valuable FREE GIFT is yours to keep just for looking. Mail the card now!

PS/S87D

**FREE** when you join

The **BENCHTOP REFERENCE** gives you instant answers to hundreds of do-it-yourself questions on Woodworking, Joinery, Dowels, Veneers, Laminates, Fasteners, Sharpening, Grinding, Concrete, Electrical work, more! 48 big 8 x 10 1/4 pages. All illustrated! Super handy and indispensable.



3 Books—count as 1

★ 1988. \$17.85 Paperbound



5985. \$17.95



★ 109. \$15.00



5882. \$19.95



★ 84. \$31.95 (counts as 2)



6176. \$19.95





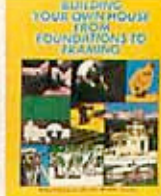









★ 194. \$32.95 (counts as 2)



6033. \$27.95 (counts as 2)

## CARBIDE TIPPED ROUTER BITS PROFESSIONAL PRODUCTION QUALITY

1000's SOLD TO READERS OF FINE WOODWORKING

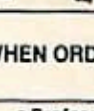
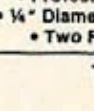
BEST CUT BEST PRICE	ITEM NO.	DESCRIPTION	RADIUS	LARGE DIAM.	CUTTING LENGTH	PRICE	
	COVE						
	#01	1/4" R	1/4"	1"	1/2"	\$13.00	
	#02	3/8" R	3/8"	1 1/4"	9/16"	14.00	
	ROUND OVER						
	#04	1/4" R	1/4"	1"	1/2"	15.00	
	#05	3/8" R	3/8"	1 1/4"	5/8"	16.00	
	ROMAN OGEE						
	#07	5/32" R	5/32"	1 1/4"	15/32"	18.00	
	#08	1/4" R	1/4"	1 1/2"	3/4"	20.00	
	#11	3/8" RABBETING	Deep 3/8"	1 1/4"	1/2"	14.00	
	#09	1/8" (KERF) SLOT CUTTER		1 1/4"	1/8"	14.00	
	#10	1/4" (KERF) SLOT CUTTER		1 1/4"	1/4"	14.00	
	#12	45° CHAMFER	45° Angle	1 1/2"	5/8"	15.00	
		#15	RAISED PANEL	20° Angle	1-5/8"	1/2"	25.00
		#35	1/4" V Groove 90°		1/4"	1/4"	8.00
	#36	3/8" V Groove 90°		3/8"	3/8"	9.00	
	#37	1/2" V Groove 90°		1/2"	1/2"	11.00	
	#16	3/8" Dovetail	9°	3/8"	3/8"	7.50	
	#17	1/2" Dovetail	14°	1/2"	1/2"	8.50	
	#18	3/4" Dovetail	14°	3/4"	7/8"	10.50	
	CORE BOX (ROUND NOSE)						
	#19	3/8" Core Box	3/16"	3/8"	3/8"	11.00	
	#20	1/2" Core Box	1/4"	1/2"	11/32"	14.00	
	#21	3/4" Core Box	3/8"	3/4"	5/8"	18.00	
		GROOVE FORMING OGEE					
		#22	1/2" Grooving Ogee		1/2"	3/8"	16.50
	#23	3/4" Grooving Ogee		3/4"	7/16"	21.00	
		#24	1/4" Straight Bit		1/4"	3/4"	7.00
#25		5/16" Straight Bit		5/16"	1"	7.00	
#26		3/8" Straight Bit		3/8"	1"	7.00	
#27		1/2" Straight Bit		1/2"	1"	7.00	
#28		3/4" Straight Bit		3/4"	1"	10.50	
	#13	1/2" FLUSH TRIM		1/2"	1"	8.50	
	#14	3/8" KEY HOLE (This Bit only HSS)	CUTS 3/8" KEY HOLE FOR FLUSH MOUNTING PICTURE FRAMES, ETC.			8.50	

WHEN ORDERING ANY THREE OR MORE DEDUCT \$1.00 EACH  
ALL PRICES POSTAGE PAID

- Professional Production Quality • 1/2" Ball Bearing Pilot
- 1/4" Diameter Shanks x 1 1/4" Long • One Piece Construction
- Two Flute Thick High Quality Tungsten Carbide Tips

To order by MasterCard or Visa Toll Free  
7 Day—24 Hour Order Service Call

1-800-533-9298  
or send check to:

MLCS, P.O. Box 4053D, Rydal, PA 19046

## TALKING BACK

We welcome comments, criticism, suggestions . . . even an occasional compliment. The volume of mail we receive makes it impossible to answer every letter, but we promise to do our level best.

Send your correspondence to: Letters Editor, Better Homes and Gardens® WOOD® Magazine, Locust at 17th, Des Moines, IA 50336.

### CUT, BUT NOT FORGOTTEN!

Often, when we do research for our articles in WOOD magazine, we consult people we know in the woodworking field. That was the case recently as we prepared the "Basic Stave-Bowl Construction" article that appeared in our June 1988 issue. We received some excellent input from a couple of our California woodturning friends, Yosh Sugiyama from Redding and Andy Goldman from Placentia. Both of these gentlemen provided us with useful background information, and for that we thank them. We also apologize for accidentally omitting their names from the credit line at the end of the stave-bowl article. We do appreciate your help, guys.

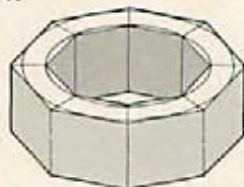

### COMBINATION MACHINES UPDATE

Zinken International, manufacturers of the MIA 6 and ZC 21 featured in the April issue of WOOD magazine, has closed its U.S. operations. We have no further information available at this time.

Toolmax changed its mailing address to P.O. Box 539, Murphys, CA 95247. You can reach a representative at 209/728-3417 or toll-free at 800-535-4788 (California residents call 800-325-8330).

We incorrectly listed the weight of the Kity K5 in our comparison chart. The correct weight is 165 pounds.

### MORE THAN ONE WAY TO CANE A CHAIR

In separate letters commenting on the trimming technique we used in our June 1988 article, "Recane a Chair in a Jiffy," two readers suggest a different approach. Edward M. Tansey of Wakeman, Ohio, and Wendell J. Kopp of Oak Ridge, Tennessee, prefer to trim the excess cane deep in the groove before fitting in the spline. They suggest tapping the webbing firmly in the groove, trimming the excess material with a sharp wood chisel, applying woodworker's glue, and then driving in the spline. We trimmed the excess webbing after applying the glue but before tapping the spline all the way in groove. Our local caning expert taught us to trim away any "fuzz" after fully seating the spline because the danger does exist that a beginner may trim the cane too short, allowing some to escape and not fully line the spline groove. We took our final picture before removing unsightly remnants.

Continued on page 12

# How to make home improvements without a home improvement loan.

More than a quarter of a million people like you have already chosen the Shopsmith® MARK V for their home workshops.

And in today's tight money market, it's no wonder. People just can't afford professional help to maintain and upgrade their homes. Or the high interest on home improvement loans.

That's why more and more folks are turning to do-it-yourself home improvements ... and to the MARK V by Shopsmith!

## A complete system you can afford

Thousands of MARK V owners have added value to their homes by remodeling kitchens, updating bathrooms, finishing basements and doing other home improvement projects. Now you can, too!

That's because the MARK V is more than a power tool. It's the complete home workshop that gives you the versatility you need in a single unit that takes no more space than a bicycle.

You get a table saw, drill press, horizontal boring machine, lathe and disc sander — all powered by one rugged, variable-speed motor. Much more affordable than five separate single-purpose tools!

## Start your Projects today!

Learning to use the MARK V is so easy that you'll soon be able to start those projects today. And built-in precision will make short work of some jobs that seem too tricky to tackle now.

What's more, the MARK V lets you "borrow" functions from one operation to make another more productive.

You'll discover that the MARK V by itself is a complete basic power workshop, ready to take on almost any home woodworking project.

Then, as your skills improve and your needs change, you can customize it with Shopsmith accessories designed to make your MARK V even more versatile!



The Original Woodworking System  
Designed and Built in the U.S.A.

## Ask for a Free MARK V Information Kit!

To find out more about the rewards and satisfactions of woodworking, call Toll Free or mail the coupon below. We'll rush you a Free MARK V Information Kit, available in your choice of Full-Color Brochure or VHS Cassette.

## No Obligation

Remember, you're under no obligation. So, act NOW and learn more about this super money, space and time saving system.

CALL:

1-800-445-4040



**Shopsmith Inc.**

The Home Workshop Company  
3931 Image Drive  
Dayton, Ohio 45414-2591

© 1988 Shopsmith, Inc.  
Shopsmith® is a registered trademark of Shopsmith, Inc.

**YES!** I want to find out how to make home improvements without a home improvement loan. Please send me my:

- Free Information Kit on the Shopsmith MARK V; or  
 Free VHS Video Information Kit (3747-128)

I understand that I am under no obligation.

Name \_\_\_\_\_

Address \_\_\_\_\_

City \_\_\_\_\_

State \_\_\_\_\_ Zip \_\_\_\_\_

I currently own Shopsmith Power Equipment.

Send to: Shopsmith, Inc., 3931 Image Drive,  
Dayton, Ohio 45414-2591

Dept. 3746





## Modelling and Miniature Crafts Magazine

A big magazine full of little things  
100 pages per issue of all that is best in the  
miniature world, now published twice a  
year! In each issue you will find 30 intriguing  
articles, 10 complete projects and over 200  
photos ... hours of entertainment.

**Issue One:** Complete Plans for a Georgian Doll's House, Military Miniatures, Gunsmithing in Miniature, Peg Dolls, Making Miniature Furniture, Radio Controlled Models, Scale Model Trains, Making a Model Stone Cottage, Dolls' Houses

**Issue Two:** Full-size Working Plans for Model Dinghy, Building the Steam Launch Isis, Miniature Desk and Chair, Horse Drawn Vehicles, Building Doll's Houses, Collecting Figures, Brass Miniatures, Lighting Systems for Dolls' Houses

**Issue Three:** Plans for a Norfolk Barn, Oak Originals, Four Poster Bed, Magic in Miniature, Floating Dolls' Houses, Model Shipwrights, Modelling Figures, Scale Model Vehicles, Furnishing a Georgian Dolls' House, Miniature Art

**Issue Four:** Turning Miniatures, Ceramic Sculpture, Making Miniature Furniture, A Model Thatched Cottage, Model Soldiers, Period Furniture, Miniature Books, Turkish Carpets, Small Ship Models, Architectural Period Models, Peg Dolls to Make

**Issue Five:** Dunster Yarn Market, Model Glues and Gluing, Miniature Heirlooms, Military Cannons, The Carpet People, Elegance in Miniature, How to Photograph Miniatures, Restoring a Victorian Dolls' House

**Issue Six (Available July '88):** Books Galore, Fairgrounds and a Country Mansion, Flowers, Jointed Table, Lighting Made Easier, Victorian Pianos, Matchstick Model Bus, Dolls' House Soldiers, Blue and White China, Miniature Cricket Ground, Jane Austen Doll

### ORDER FORM

Please send me Issues  1  2  3  4  5  6 of Modelling and Miniature Crafts at:

\$10 plus \$1.75 p&p each or  
 \$43 for all six issues, plus \$4.50 p&p

Surname \_\_\_\_\_ Initials \_\_\_\_\_ Mr/Mrs/Miss \_\_\_\_\_

Address \_\_\_\_\_

City \_\_\_\_\_

State \_\_\_\_\_ Zip Code \_\_\_\_\_

Send this form with cheque/money order/credit card details to:  
GMC Publications Ltd, 166 High Street, Lewes, East Sussex BN7 1XU,  
England. Tel: +44 273 477374

WM

## TALKING BACK

Continued from page 10

### MORE THAN A PLATE JOINER



The Elu 3380 joiner/spliner

I read with a lot of interest the "Plate Joiners" article in the June, 1988, issue of *WOOD* magazine. The article did an especially good job of describing the ease of making biscuit joints and the relative strength of those joints versus ordinary wood screws or dowels.

However, I take issue with the article's assertion that plate

joiners are "... limited to reinforcing flush (butt and miter joints)..." The Elu 3380 actually is two machines—a joiner and a spliner—as a result of Elu engineers identifying woodworker's needs.

It was pointed out in the article that the Elu can cut continuous grooves for splines. It also should be noted that the ability to adjust the cutting blade's lateral position relative to the locating face of the tool allows for accurate positioning and width control of the groove so that, for example, a drawer bottom could be installed in a biscuit-joined drawer frame.

The Elu 3380 also has continuously variable depth of cut settings from 0 to 22 mm (0 to approximately  $\frac{7}{8}$ "). This feature allows for very accurate depth control of spline grooves; and further, the  $\frac{7}{8}$ " depth of cut allows for trimming 1" finished material.

Since you tested the Elu 3380, we have improved the design to incorporate small spurs on the faceplate to grip the wood when biscuit joining. The pins can be removed for splining and cutoff jobs.

—Clay Furtaw, Group Product Manager,  
Black & Decker

### FINISH FOR RATTAN AND WICKER

I have finished furniture for the last 20 years, and I thought you might be interested in a simple way to achieve a superior finish for rattan and wicker.

Because I finish a majority of the wicker we sell in white, I first apply a base coat of a flat white primer. I then apply a topcoat of a gloss white polyurethane.

If a customer requests a color other than white, I mix about 3 parts of white primer with 2 parts of the desired color. The tinted primer provides an adequate base for the polyurethane topcoat.

—Danny S. Ward, Spanish Fort, Ala.

As president of an Oriental importing company, you must know a lot about rattan and wicker! Rattan and wicker continue to be popular for home furnishings. We appreciate your suggestion.

Continued on page 15

## WOODWORKER'S PLANS & PARTS

### Heirloom Rocker

Build our classic rocking horse and create a family heirloom which will delight the children in your family for generations to come.

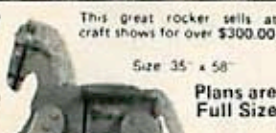

This great rocker sells at craft shows for over \$300.00

Size 35" x 58"

Plans are Full Size

Order Plan #400  
Only \$10.25



This collection of 5 toy vehicles will delight the heart of any youngster lucky enough to own them. They range in size from 12" to 18" Plan set #18004 \$12.75



Door Harp Plans

FULL SIZE PLANS

Set of four award winning Door Harp Plans \$12.50

New Design No Fret Bar



Plans include Stencil Design

Hardware Kit for all four harps (no plywood) \$12.50



Music Wire 25' for \$2.50

Tuning Pins .30 each 100 for \$18.00

Door Harp Plywood Harps require 2 pcs. \$1.00 per piece



Door Harp Plywood Harps require 2 pcs. \$1.00 per piece

Shipping add \$2.50. New York Res. add tax. Prices valid thru 10/88

We accept VISA & MASTERCARD. Phone (516) 462-6228

Armor Products Box 445-L East Northport, NY 11731

# Your workshop can PAY OFF ...BIG!

SAVE ... convert low  
cost rough lumber  
for use in your  
home projects

OR

EARN EXTRA  
INCOME by supplying  
custom Planed Lumber,  
trim, and molding to  
lumberyards ...  
contractors ...  
cabinetmakers ... home  
hobbyists and others ...



## FOUR BIG ADVANTAGES ...



PLANE



MOLD



SAW



SAND

### You can plane, mold, saw & sand All with Automatic Power Feed!

From the Day It Arrives ... the Planer will make and save you money. With shortages and inflation driving lumber prices sky-high, this versatile power feed tool quickly pays for itself by easily converting low cost rough lumber into high value finished stock. In just one pass turn out your own quarter round, door and window stop, casing, tongue-and-groove ... all popular patterns. Other operators are making cases for grandfather clocks, furniture, picture frames, bee hives, bed slats, surveying stakes ... all kinds of millwork.

**Built For Pros ... Priced For Home Craftsmen ...** it is engineered and built to industrial standards, but factory-direct selling keeps the price low. Handles tough oak and walnut as easily as pine, and so simple to operate even beginners with no experience can use it.

**Start Your Own Business ...** with just this one low cost power feed machine in a corner of your garage or basement, you're set up to supply lumberyards, cabinetmakers, carpenters, remodelers, contractors and hobbyists in your area with custom-planed lumber, trim, molding ... All of their millwork requirements. You can supply picture frame moldings to art shops, hardware and department stores, or sell direct to framing shops. All standard patterns are available from stock, or we'll custom grind a knife to your own special design or sample.

**FREE  
BOOKLET!**

Get **FREE  
BOOK** with  
facts and  
full details

... RUSH COUPON TODAY!



Just Mail Coupon ...  
**30-DAY FREE  
TRIAL OFFER!!!**  
ACT NOW!  
Coupon  
Brings  
Full Details!

**SAVE!!! FACTORY PRICES DIRECT TO YOU!**

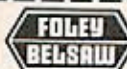

FOLEY-BELSAW CO.  
6301 EQUITABLE RD., DEPT. 91323  
KANSAS CITY, MO. 64120  
Established in 1926

YES, please send me the FREE Booklet that gives me complete facts about your Planer-Molder-Sander-Saw and full details on how I can qualify for a 30-Day FREE Trial right in my own shop. I understand there is No Obligation and that No Salesman will call.

Name \_\_\_\_\_  
Address \_\_\_\_\_  
City \_\_\_\_\_ State \_\_\_\_\_ Zip \_\_\_\_\_

# TOOL CITY

WE HAVE EVERY TOOL YOU NEED



**CALL TOLL FREE**

INSIDE CALIF. **1-800-826-7819**  
OUTSIDE CALIF. **1-800-423-7899**

(213) 802-1238 • (714) 525-3581  
OPEN 8 AM to 5:30 PM PACIFIC STANDARD  
14136 E. FIRESTONE BLVD.  
SANTA FE SPRINGS, CA. 90670

ALL ORDERS SHIPPED UPS FREIGHT PREPAID (CONTINENTAL USA) ON ORDERS \$50 OR MORE. SINGLE ITEMS WEIGHING TO LBS. OR MORE ARE SHIPPED F.O.B. SANTA FE SPRINGS, CA. CALL FOR DISCOUNT FREIGHT RATES. SALE PRICES. LIMITED TIME ONLY SUBJECT TO CHANGE WITHOUT NOTICE.



OUR GIANT 500 PAGE FULL LINE CATALOG IS YOURS FREE WITH ORDER OF \$50. OR MORE OR ONLY \$5.00 EA.

## RYOBI

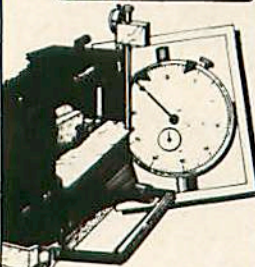

#AP10C **\$399**  
w/Dust Chute

AP-10 10" Planer With Dust Chute Attachment **\$399**

DC-1 Dust Chute For AP-10	25
EB-1 Extra Blades For AP-10	39
DG-1 Depth Gauge For AP-10	79
R150K 1 HP Plunge Router Kit	119
R500 3 HP Plunge Router	169
R501 3 HP Plunge Router	169
RA200 8" Radial Arm Saw	249
S500A Palm Sander	37
TR30U Laminate Trimmer	79
TS200 8" Compound Saw	189
TS251U 10" Miter Saw	199
X2300 Miter Saw Accessory Kit	29
TS380 14" Miter Saw	389

## HITACHI

TR12 3 HP Plunge Router With \$60 Worth of Accessories	169
TR8 1 1/2 HP Plunge Router	129
C10FA 10" Miter Saw	289
C10FB 15" Miter Saw	399

## ELU

WOODWORKING TOOLS BY **BLACK & DECKER**

3304 1 H.P. Electronic Plunge Router	254
3337 3 H.P. Plunge Router	399
3338 3 H.P. Electronic Plunge Router	439
3375 Universal Planer	238
3380 Jointer-Spliner	399
4023 3 X 21" Belt Sander	219
4024 3 X 21" Electronic Belt Sander	245
4029 4 X 24" Belt Sander	398

## 3M Stikit

13599 Stik-it Dispenser	15
3M Stik-it Adhesive Back Rolls	13
13608 80 Grit 10 Yard Roll	11
13600 100 Grit 10 Yard Roll	11
13620 120 Grit 10 Yard Roll	11
13618 180 Grit 10 Yard Roll	11
13622 220 Grit 10 Yard Roll	11
MKSP Makita Stik-it Pad	8
PCSP Stik-it Pad For PC #330	5
PCSP Stik-it Pad for PC #505	8



#7514 **\$129**

## PORTER-CABLE

100 7/8 H.P. Router	\$107
309 Laminate Trimmer	99
310 Laminate Trimmer	132
312 Offset Trimmer	144
314 4 1/2" Saw	139
315-1 7/4" Circular Saw	129
319 Tilt Base Trimmer	149
320 Abrasive Plane	109
330 Speed-Block Sander With 3M Stik-it Pad	59
345 6" Saw Boss Circ. Saw	109
351 3 X 21" Belt Sander	134
352 3 X 21" Dustless	144
360 3 X 24" Dustless	205
361 3 X 24" Belt Sander	192
362 4 X 24" Dustless	215
363 4 X 24" Belt Sander	205
503 Wormdrive Belt Sander w/bag	359
504 3 X 24" Wormdrive Belt Sander	349
505 1/2 Sheet Sander w/Stick-it Pad	119
513 Lock Mortiser	699
518 3 H.P. 5 SPD Router	369
520 3 H.P. Router	349
536 1 1/2 H.P. Speedmatic Router	207
537 1 1/2 H.P. D-HDL Speedmatic	219
555 Plate Jointer w/Case	169
621 3/8" V.S.R. Drill	89
666 3/8" T-Handle V.S.R. Drill	29
690 1 1/2 H.P. Router w/2 Collets	129
691 1 1/2 H.P. D-Handle Router	149
695 Router-Shaper Table w/Router	219
696 Router Table	119
5008 Dovetail Jig	79
5009 Mortise & Tenon Jig	39
5061 Stair Template	159
7511 3/8" Heavy Duty V.S.R. Drill	199
7514 1/2" V.S.R. Drill	129
7533 Adj. Clutch Screwgun	159
7545 Drywall Screwgun HVY-Duty	119
7548 VS Jig Saw w/3 Bearing Guide	139
9118 Porta Plane w/Case, Carbide	229
9314 4 1/2" Trim Saw Kit w/Case	159
9548 Bayonet Jig Saw Kit	189
9627 2 SPD Recip Saw Kit	149
9629 VS Recip Saw Kit	159
9652 Versa-Plane Kit	309
95981 Hinge Butt Template Kit	159



## BOSCH



#1581VSK **\$154**

1272 3 X 24" Belt Sander	192
1272D 3 X 24" Dustless	206
1273 4 X 24" Belt Sander	206
1273D 4 X 24" Dustless	219
1273DVS 4 X 24" Variable Spd. w/Bag	229
1581VS Top Handle Jig Saw	139
1581VSK Top Handle Jig Saw Kit	154
1582VS Barrel Grip Jig Saw	134
1604 1 1/4 H.P. Router	139
1609K Laminate Trimmer Kit	169
1611 3 H.P. Plunge Router	229
3270D 3 X 21" Belt Sander w/Bag	147
11203K Rotary Hammer Kit	439
91066 1/2" Mighty Midget Drill	115

Call For Discount Prices On Bosch Router Bits



#9820-2 **\$169**

## Makita

410 Dust Collector	\$269
1100 3/4" Planer	229
1900BW 8 1/4" Planer	119
2708W 8 1/4" Table Saw with Carbide Blade	269
3612B 3 H.P. Plunge Router	184
3612BR 3 H.P. Plunge Router	199
4200N 4 3/8" Tri. Saw	109
4301BV VS Jig Saw	159
5005BA 5 1/2" Trim Saw	119
5007NBA 7 1/4" Saw w/Brake	129
5077B 7 1/4" Wormdrive Saw	149
6801DBV Drywall Screwgun	89
9820-2 Blade Sharpener	169
BO-4550 Sander w/Bag	49
JR3000V Recip Saw	129
LS1000 10" Miter Saw	229

All MAKITA Tools on Sale Phone for Discount Prices!

<b>9.6 Volt Cordless Tool Systems</b>	
6012HDW Driver-Drill Kit	\$119
6012HD Driver Only	69
6093DW VS Driver-Drill Kit	139
6093D VS Driver-Drill Only	79
4300D Jig Saw	69
5081D 3 3/8" Circular Saw	79
6891D Drywall Screwgun	87
ML900 Flashlight	34
9 6 Volt Battery	36
Charger for Car-Cig. Lighter	49

## freud

FB-107 7pc Forstner Bit Set	\$59
FB-100 18pc Forstner Bit Set	159
90-100 15pc Router Bit Set	179
91-100 13pc 1/2" Shank Router Set	199
91-102 6pc 1/2" Shank Straight Bit Set	89
91-104 6pc 1/2" Shank Profile Bit Set	129
94-100 5pc Cabinet Bit Set	179
95-100 5pc Cabinet Set w/Perfecta Bit	229

Both Above Come With Free Door Making Book!  
DB-050 50pc Drill Bit Set **59**  
EC-900 5pc Shaper Cabinet Set **329**

99PK1 Multiform Router Bit	\$75
99-034 Lock Miter Router Bit	59
WC-106 6pc Chisel Set	39
WC-110 10pc Chisel Set	59
TT-108 8pc Lathe Turning Set	59
CS-112 12pc Carving Set	129

ALL FREUD SHAPER & ROUTER BITS  
DISCOUNTED UP TO 50%. CALL FOR PRICES

We Honor All **FREUD Specials!**



### FINE CUT-OFF CROSS CUT BLADES

LU73M008 8" X48T ATB	\$54
LU73M009 9" X54T ATB	59
LU73M010 10" X60T ATB	39
LU73M012 12" X72T ATB	85

### PRECISION PLYWOOD BLADES

LU82M008 8" X48T TCG	59
LU82009 9" X54T TCG	64
LU82M010 10" X60T	44
LU82M012 12" X72T TCG	92

### COMBINATION BLADES

LU84M008 8" X40T COMB.	53
LU84M009 9" X40T COMB.	53
LU84M011 10" X50T COMB.	39
LU84M012 12" X60T COMB.	69

### RIPPING BLADES

LM72M008 8" X24T FLAT TOP	43
LM72M010 10" X24T FLAT TOP	39
LM72M012 12" X30T FLAT TOP	65

### SUPER FINE CUT-OFF BLADES TEFLON COATED

LU85M008 8" X64T ATB	\$69
LU85M009 9" X72T ATB	75
LU85M010 10" X96T ATB	62
LU85M012 12" X80T ATB	99
LU85M014 14" X108T ATB	119
LU85M015 15" X108T ATB	149

ATB = Alternate Top Bevel  
TCG = Triple Chip Grind

### SC-001 Saw Blade Stabilizer

DS306 6" Dado	\$99
DS308 8" Dado	109
AD800 8" Adjustable Dado	49
JS-100 Joining Machine	169
0-10-20 Bisquits box of 1000	34



## POWERMATIC

#66 2 H.P. 1 Phase **\$1549**

66 2HP Table Saw W/50" Biesmeyer	\$1549
66 3HP Table Saw W/50" Biesmeyer	1785
80 8" Jointer W/1 1/2 HP	1349
26 Shaper 2 HP	1399

## BIESEMEYER

Biesmeyer 40" Homeshop Fence System	209
Biesmeyer 52" Commercial Fence System	299
Paralock Table Saw Fence 50"	339

Call For Price On Custom Fences And Mobile Bases



## LAMELO

Lamelo Junior	299
Lamelo Top	589
Lamelo Junior with Adjustable Fence	389

## SENCO NAIL GUNS

SFN1 1-2" Finish Nailer	\$269
SFN1K 1-2" Finish Nailer Kit With Metal Case	299
LS2 Pin Nailer 1/4" - 1"	269
LS4 Pin Nailer 3/8" - 1 1/4"	279
SFN2B 1-2 1/2" Finish Nailer	399
SFN2BK Finish Nailer Kit With Case	439
SN4 Framing Nailer	549
SKS 1/4" - 1 1/2" Finish Stapler	269
SKSK Finish Stapler Kit With Case	299

Phone for Nail & Staple Prices

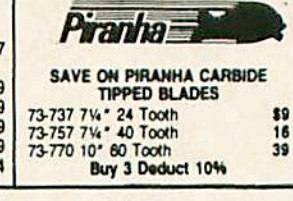

### SAVE ON PIRANHA CARBIDE TIPPED BLADES

73-737 7 1/4" x 24 Tooth	\$9
73-757 7 1/4" x 40 Tooth	16
73-770 10" x 60 Tooth	39

Buy 3 Deduct 10%

## We Ship Two Ways



**\$8.95**



**FREE**



## TALKING BACK

Continued from page 12

### THE END OF AN ERA—AGAIN?



Paul Dicob rides a log wagon through the woods.

Because I'm interested in traditional woodworking methods, and also live in the Adirondack region, your April 1988 article about Paul Dicob, "Horse Logging in the Adirondacks," intrigued me. You gave me an insight into the older method of harvesting timber. After reading the story, I was thrilled to learn that some people still believe in tradition and can make it turn a profit for themselves. However, a short time later, a local newspaper carried an article stating that Paul was out of business due to high liability insurance premiums. As more and more of the Paul Dicobs of this world are lost, we lose more and more of our heritage.

—David McKane, Molra, N.Y.

David, we echo your concern. When we visited Paul working his draft horses amidst the hemlocks in May, 1987, he never indicated increasing insurance costs were a problem. In fact, he predicted a bright future for "a man and a team," so we were surprised at his decision to quit logging with his Belgians. Paul says, "Yep, insurance costs were really agoin' up, so I sold my teams. But, I keep gettin' calls for horses, so maybe I'll be getting back in it."

### IMPROVED SCALLOP BOX

While building the band-sawed scallop boxes (February 1988 issue), I discovered a way to prevent small objects such as paper clips and pins from getting trapped under the wooden hinge. I first cut the hinge block in half on the vertical midpoint at about  $\frac{1}{16}$ " [see drawing at right]. Then I repositioned the hinge pin and round-over accordingly, and glued the bottom half of the original hinge to the box.

—Dick Brill, Riverview, Mich.

We agree with your fine suggestion, Dick. Thanks for sharing it with our readers. 🍀

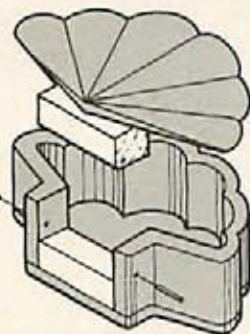

## Another breakthrough tool only from Garrett Wade.

As the industry innovator we don't let sawdust grow under our feet. Years ago we introduced a whole new kind of catalog that went on to pioneer INCA Machinery, Chamfering Planes, Horizontal Wet Grinders, and countless other breakthrough tools. And our 1988, 212-page Catalog is no exception. It's new from start to finishing.

It has dozens of new woodworking hand tools, machines, accessories and finishing supplies that are the finest available. Anywhere. It's packed with detailed photographs, honest specifications, reliable descriptions, all divided into easy-to-find, easy-to-use sections.

But offering quality tools isn't all that sets our catalog apart. There's quality advice. On current woodworking techniques. On choosing the right tool. On sharpening, clamping, finishing and more.

Just send us the coupon with \$4.00 or call for your 1988 Garrett Wade Catalog — plus *free* handy supplements throughout the year. It could be just the kind of breakthrough tool your workshop needs.

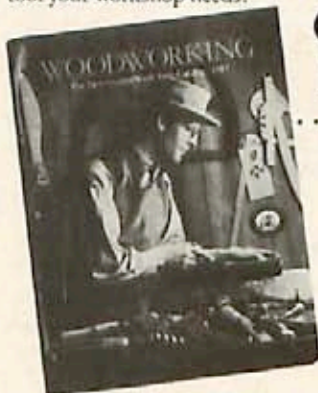

### Our 1988 Catalog.

Garrett Wade Dept 608  
161 Avenue of the Americas  
New York, NY 10013



Name \_\_\_\_\_  
Address \_\_\_\_\_  
City \_\_\_\_\_  
State \_\_\_\_\_ Zip \_\_\_\_\_

Toll Free  
800-221-2942

New York State Residents (212) 807-1757

New  
"Quad-Drive"

## DRUM SANDER with Infinitely Variable Power Feed!

At last! A complete power-feed Drum Sander at an affordable price! Choose from 12" and 26" models SAVES TIME...IMPROVES RESULTS. Use this high-tolerance machine for light dimensioning as well as the finest finish work. Now you can add new beauty to each woodworking project...save hours of tedious hand sanding! In a matter of seconds you can produce a satin-smooth finish impossible to duplicate with hand methods or hand-held power sanders...no more low spots, waves or cross-grain marks! Check these advantages...

#### FREE FACTS!

Send for complete facts on how you can try this low-cost tool in your own shop for one full month without risk. See how the sander can dimension and finish sand cabinet pieces, resawn stock, paneling, toys, tabletops, knees, burls, crotches and much, much more! You'll soon find it's one of the most valuable tools in your shop! Made in U.S.A. Easy Terms.



Call Toll-Free  
1(800)538-4200, Ext. 2425



**YES!** Please rush my FREE INFORMATION KIT and details on your 30-Day Free Trial Guarantee.

Woodmaster Tools, Dept. RW25,  
2908 Oak, Kansas City, MO 65108

NAME \_\_\_\_\_  
ADDRESS \_\_\_\_\_  
CITY \_\_\_\_\_  
STATE \_\_\_\_\_ ZIP \_\_\_\_\_

**NEW INFINITELY VARIABLE FEED RATE** gives you total control in any sanding situation!  
**EXCLUSIVE QUAD-DRIVE FEED SYSTEM**...four, power-feed rollers for maximum traction. Eliminates oversanding at first and last few inches of a board!

**NEW FELT-BACKED ABRASIVE** mounts in just seconds to Velcro covered drum. The harder you sand, the tighter it stays! Eliminates stretching...allows fast removal and re-use!

**GET A GRIP ON HANDSCREWS**

You can apply a moderate amount of torque with handscrew handles, but most of us have difficulty bearing down on the smooth handles.

**TIP:** Bicycle inner tubes provide an inexpensive, quick solution to this gripping problem. Use baby or talcum powder to help stretch and position the inner tube.

—Calvin H. Henne  
Bridgeport, Neb.

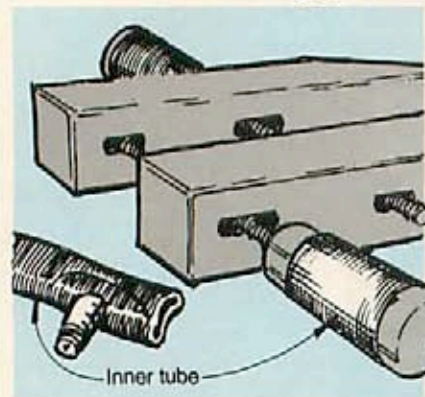

**FOLLOW SOME BASIC LINES ON YOUR SAW TABLE**

Aligning the ripping fence truly perpendicular to the blade of your table saw can be pretty iffy—especially with a narrow or loosely fitting fence. Similarly, accurately setting a 45° angle on a miter gauge can be tricky.

**TIP:** Clamp a carpenter's square at a right angle to the miter-gauge groove, top drawing, right, and score a fine line in the surface of the table with a steel scriber. Next, clamp the square in place so the legs of the square are equally long, middle drawing, right, and scribe another line that intersects the first one at 45°. Finally, flip over the square, clamp in place at the correct diagonal, and scribe a third time. This provides you with accurate reference lines for setting your miter gauge at the three most common angles.

—From the WOOD magazine shop

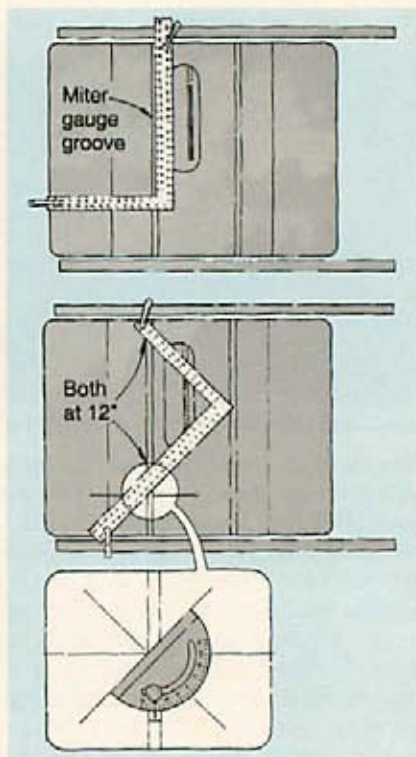

**PUT A LONG MEMBER IN A SHORT SPACE**

Occasionally the rung in the back of a chair or a stretcher between chair legs will break, even though all the chair's joints remain tight. At first glance, replacing the broken member seems to require disassembling an otherwise healthy chair.

**TIP:** Turn a replacement part or use the old one if it can be repaired. You may need to shorten one tenon so you can wiggle the damaged piece into the original position. Remove the shortened piece. Drill a 1/4" hole in the center of the shortened tenon deep enough to accept a 2"-long dowel and a ballpoint pen spring. Next, bore a 1/4" hole at least 1/2" deep in the middle of the rail as shown in the drawing at right. Apply glue to both ends of the rung and slip into place as you would reload a roll of toilet paper. The spring will push the dowel into place and, when the glue sets, the dowel will make the repair permanent.

—Earl W. Zieg, Fairfax, Va.

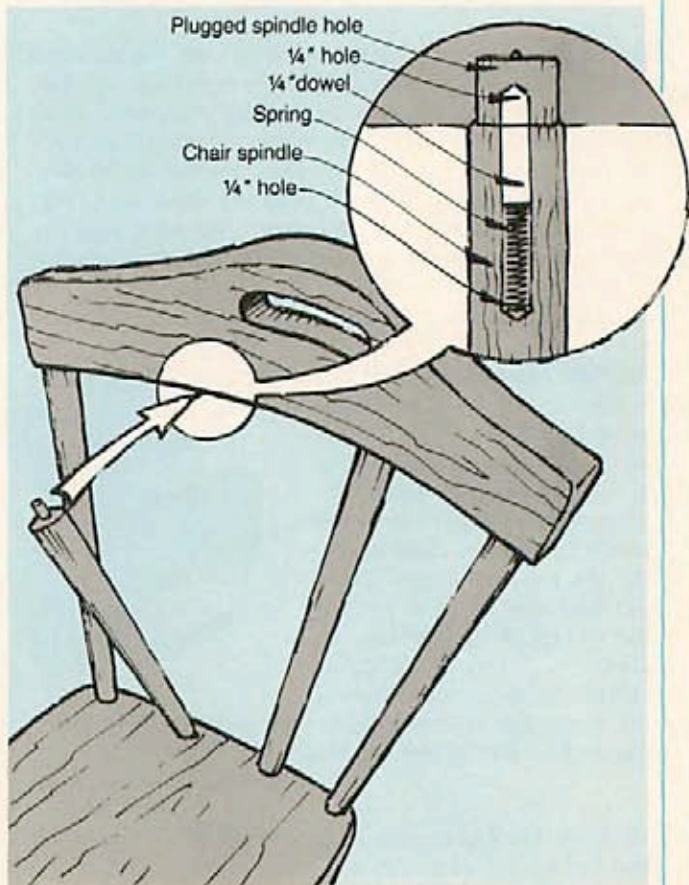

Do you have any good tips you'd like to share with our readers? We'll pay you \$25 for each submission we publish. No shop tips can be returned. Mail your tips to:

Shop Tips  
Better Homes and Gardens®  
WOOD® Magazine  
Locust at 17th  
Des Moines, IA 50336

Continued on page 18



## ORDINARY PEOPLE. EXTRAORDINARY RESULTS.

Results that come from a conditioning Furniture Refinisher that nourishes as it refinishes.



The ordinary person: Dave Bostic, Purchasing Agent. The extraordinary result: a miraculous makeover of this desk.

© 1988 Thompson & Formby Inc.  
The Formby's Workshop, Olive Branch, Mississippi 38654



"My desk was only a step away from the Salvation Army."

Dave had given up until he discovered Formby's® Conditioning Furniture Refinisher. This innovation from the Formby's Workshop contains penetrating wood conditioners that help prevent drying and cracking.

"Formby's dissolved the built-up varnish, lacquer and shellac—revealing the wood's inner glow. And it conditioned my wood at the same time," continued Dave.

Let Dave's triumph inspire you. Thanks to the remarkable products that come from the Formby's Workshop—and our toll-free number for expert advice—you can get extraordinary results.



Nothing works like things from The Workshop.

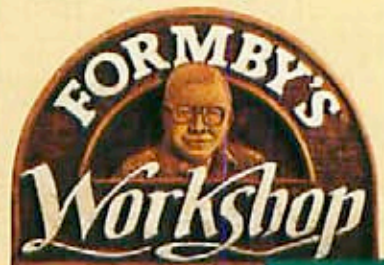

## TIPS FROM YOUR SHOP (AND OURS)

Continued from page 16

### INEXPENSIVE FRAME CLAMPS FROM CABINET HINGES

Relatively high cost keeps some woodworkers from appreciating the convenience of commercially available picture-frame clamps. Here's a picture-perfect solution.

**TIP:** Make this picture-frame clamp with four 4" strap hinges, four 18" lengths of 5/16" threaded rod, and 12 nuts. First, at the ends of the hinges, ream holes large enough to accept the threaded rods, and then bend right angles into the leaves as shown. For assembling smaller picture frames, you may wish to cut a set of shorter threaded rods.

—George A. Heffelfinger  
Lebighton, Pa.

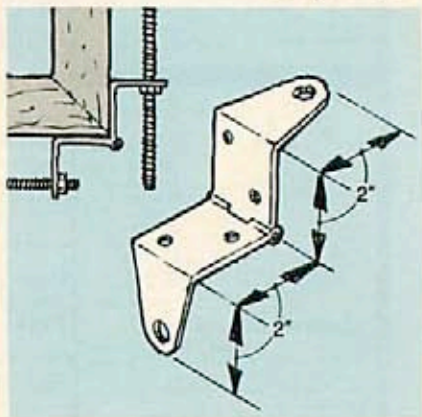

### Rx FOR BALKY TAPE MEASURES

With extended use, metal tape measures get gummed up and no longer retract smoothly. Moreover, the painted markings wear thin.

**TIP:** Pull the tape all the way out and apply a thin coat of auto body wax to both sides. When you roll up the tape, the wax will protect the markings on the face of the tape while lubricating the inner mechanism so it works smoothly.

—D. Roboway  
Winnipeg, Man., Canada

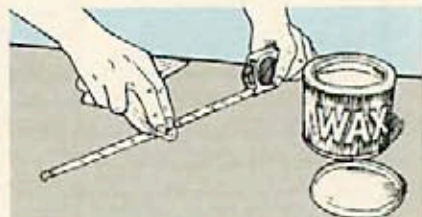

## FREE Tool Catalog

Quality Products For Woodworkers

Send today for your FREE copy of our new colorful catalog. It's fully illustrated with the finest quality tools, supplies, books, components, hardware and much more. Satisfaction Guaranteed.

Write today for a FREE catalog.



WOODCRAFT SUPPLY CORP.  
Dept. WBH78  
41 Atlantic Avenue, Box 4000  
Woburn, Massachusetts 01888

## Furniture Restoration

Big Money in Small Business

Stripping★Repairing★Refinishing  
Mirror Resilvering★Veneering

Earn \$200-\$1000 a day!

At home or in shop ★ Spare time, full time ★ Men or women ★ Complete training, no experience necessary ★ Simple, fast, safe, fun.

FREE CATALOG

Send \$2.00 for postage & handling to  
MINUTEMAN, INC., Dept. 17,  
115 N. Monroe St., Waterloo, WI 53594

# Compare this offer with any other book club for Price • Quality • Benefits • Selection!

An absolutely no-risk guarantee.



2871 \$17.95



2783P \$12.95



2702 \$22.95



2747 \$21.95



1530P \$15.95



2714 \$24.95  
Counts as 2



2799 \$23.95



2790 \$18.95



2629 \$24.95  
Counts as 2

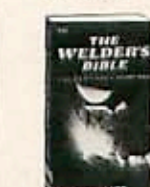

1244P \$14.95



1867 \$21.95



1551P \$12.95



2878 \$21.95



1838P \$10.95

## Select 5 Books for only \$3.95

(values to \$121.70)  
and get a Free Gift!



1971P \$12.95



1675 \$19.95



2883 \$24.95  
Counts as 2



1810 \$18.95

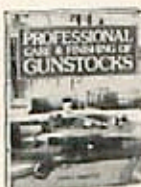

1766P \$10.95



2667 \$19.95



2811 \$27.95  
Counts as 2



2884 \$23.95



1668P \$13.95



1381P \$14.95

**Membership Benefits • Big Savings.** In addition to this introductory offer, you keep saving substantially with members' prices of up to 50% off the publishers' price. • **Bonus Books.** Starting immediately, you will be eligible for our Bonus Book Plan, with savings of up to 80% off publishers' prices. • **Club News Bulletins.** 14 times per year you will receive the Book Club News, describing all the current selections—mains, alternates, extras—plus bonus offers and special sales, with hundreds of titles to choose from. • **Automatic Order.** If you want the Main Selection, do nothing and it will be sent to you automatically. If you prefer another selection, or no book at all, simply indicate your choice on the reply form provided. As a member, you agree to purchase at least 3 books within the next 2 years and may resign at any time thereafter. • **Ironclad No-Risk Guarantee.** If not satisfied with your books, return them within 10 days without obligation! • **Exceptional Quality.** All books are quality publishers' editions especially selected by our Editorial Board

### FREE when you join!

#### 15 Practical Woodworking Projects From Percy Blandford

Exciting projects from master craftsman Percy Blandford include toys, furniture, a go-cart, and more!



1801P \$8.95



2829 \$29.95  
Counts as 2



1954P \$16.95



1763P \$10.95



2739 \$19.95



1761P \$12.95



2816 \$21.95



1468P \$10.95

## HOW-TO BOOK CLUB

Blue Ridge Summit, PA 17294-0800

Please accept my membership in the How-To Book Club® and send the 5 volumes listed below, plus my FREE copy of 15 Practical Woodworking Projects From Percy Blandford (3124P) billing me \$3.95 plus shipping and handling charges. If not satisfied, I may return the books within ten days without obligation and have my membership cancelled. I agree to purchase at least 3 books at regular Club prices (plus shipping/handling) during the next 2 years, and may resign any time thereafter.

Name \_\_\_\_\_  
Address \_\_\_\_\_  
City \_\_\_\_\_  
State/Zip \_\_\_\_\_ Phone \_\_\_\_\_  
Signature \_\_\_\_\_

Valid for new members only. Foreign applicants will receive special ordering instructions. Canada must remit in U.S. currency. This order subject to acceptance by the How-To Book Club®. Signature of parent or guardian required for all new members under 18 years of age. BHGW-788



© 1988  
HOW-TO BOOK CLUB®  
Blue Ridge Summit,  
PA 17294-0800

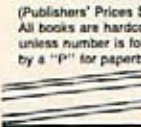

(Publishers' Prices Shown)  
All books are hardcover unless a number is followed by a "P" for paperback.

## HAVE TOOLS, WILL TRAVEL

The "Traveler" series from Warren Tool Co. contains six gouging blades and, depending upon which kit you choose, a variety of whittling edges. We found the quality of steel in the blades to be first-rate. A little additional honing helped the factory-ground edge. To test the edge, we sliced through 1/2"-thick oak—there still was enough edge to shave the hair on a man's arm.

The 4x6" carrying case makes for easy storage and transport, but a word of caution about the interchangeable handle: The knurled nut on the handle can be difficult to loosen. Use caution when removing the blades.

*The "Traveler" combination carving kit with 8 blades and 6 gouges; catalog no. COMBI-T4, \$58.95 ppd. from Warren Tool Co. Inc., Rte. 1, Box 14A, Rhinebeck, NY 12572.*



## CUSHY SOLUTION TO ROUTER PROBLEMS

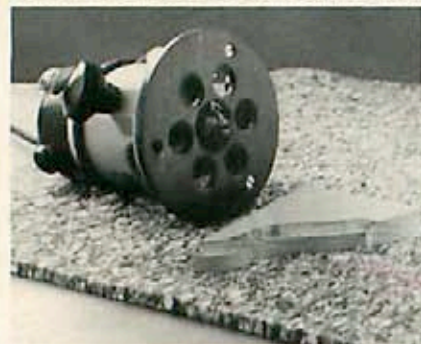

Keeping wood from walking or sliding on a workbench while using a router, sander, saw, or other tools aggravates many woodworkers. The 2x3' Router Master pad solves this problem. Although it looks like carpet padding, which is slippery on one side, Router Master grips on both sides and is much denser than carpet pad, too. The 3/8"-thick material grips virtually anything placed on it and held down with normal pressure.

Accumulated sawdust can cause the pad to slip, so it helps to occasionally shake it clean. The pad also protects previously sanded surfaces from picking up dings while you work on the other side of a piece.

*Router Master pad; available at some regional woodworking shows, from selected dealers and mail-order catalogs, or for \$9.98 ppd. from Kencraft Co., 5212 Tractor Rd., Toledo, OH 42612.*

*Continued on page 23*

# ONLY THE PIRANHA<sup>®</sup> BLADE DESERVES THESE CUTTING REMARKS.

THE PIRANHA<sup>®</sup> BLADE'S UNIQUE CURVED CARBIDE TEETH SLICE THROUGH WOOD FOR SMOOTHER, FASTER CUTS THAN CONVENTIONAL CARBIDE BLADES

CONVENTIONAL BLOCK SHAPED CARBIDE TOOTH

The Black & Decker Piranha<sup>®</sup> Carbide Tooth Saw Blade outperforms both conventional carbide and steel blades. The Piranha<sup>®</sup> Blade lasts up to fifty times longer than steel blades and it's resharpenable. It's also available in sizes from 5 1/2"–10" to fit all brands of saws. And that adds up to one very remarkable saw blade.

The Piranha<sup>®</sup> Blade. Only from Black & Decker.

THE PIRANHA<sup>®</sup> BLADE'S "FISH HOOK" GULLET REMOVES CHIPS FAST, REDUCES DRAG AND MAKES CUTTING EASIER.

**BLACK & DECKER<sup>®</sup>**

**Piranha<sup>™</sup>**  
Carbide Tooth Saw Blade



introducing . . .

**rbindustries** family of  
*fine quality tools . . .*



## The rbi Hawk™

### Precision Scroll Saw

America's best selling scroll saw can give you the capabilities you need at a price you can afford. With five models to choose from, the Hawk is the scroll saw for you! Unlock your creativity and enjoy precision woodworking you never dreamed possible. Send for a free fact kit today!



## rbi Joint Machine™

Create beautiful wood joints so precise they don't even require gluing. Make beautiful finger joints, dovetails, mortise and tenons, and more! By using the optional inverted pin router attachment you can make wooden signs and any precision router work all with one simple machine. Send today for more information!



## rbi WOODPLANER®

Planer • Sander • Molder • Gang Saw

Four heavy duty precision operations in one rugged, dependable workhorse of a tool. Plane tough stock into finished lumber, put a satin smooth finish on your projects with the sanding head attachment, create beautiful custom moldings with the molding head assembly, or gang saw lumber to exact dimensions with the power fed gang saw. Send today for your free fact kit on all RBI products.

For Faster Service Call Toll Free

1-800-535-8665

MAIL TO:

**rbindustries**

1801 Vine Street, P.O. Box 369  
Harrisonville, MO 64701

Yes! Please Rush Me A FREE Information Kit  
(Check One)  RBI WOODPLANER  RBI JOINT MACHINE  
 RBI HAWK PRECISION SCROLL SAW

Name \_\_\_\_\_  
Address \_\_\_\_\_  
City \_\_\_\_\_  
State \_\_\_\_\_  
Zip \_\_\_\_\_

W20

Wood-working's best value is now even better. Cascade is having a great summer sale!! Now thru July '88 take 10% off all router bit & shaper cutter orders of \$100 or more. (Sale limited to \$10 off on each 6 pc. cabinet set purchased.)

Cascade Precision Tool Co.  
Box 848, Mercer Island, WA 98040

"Custom Grinding a Specialty"

**BEST FACTORY DIRECT PRICES ON PROFESSIONAL**

**QUALITY CARBIDE TIPPED S BRAND ROUTER BITS AND SHAPER CUT-**

**TERS!! SEND \$1 (Refundable with first order) FOR OUR NEW 12 PAGE CATALOG FEATURING A GREAT SELECTION LIKE THESE:**

**CARBIDE TIPPED SHAPER CUTTER PANEL RAISER** - 3 WING, 5 PROFILES, 3MM THICK CARBIDE  
• 4-5/8" O.D. with 3/4" BORE (1/2" BUSHING)  
• 5-1/2" O.D. with 1-1/4" BORE (1" BUSHING)

**\$69.95**

**6 PC CARBIDE TIPPED CABINET SETS**  
• 3 mm CARBIDE  
• 3/4" BORE W/ 1/2" BUSHING  
**ONLY \$179.95**

13 Great Cabinet Sets including these popular Profiles:

(1-1/4" Bore with 1" Bushing - ONLY \$249.95)

**1/2" SHANK CARBIDE TIPPED CABINET DOOR SET**  
• Big 3-1/2" O.D. PANEL RAISER 3 pc. set  
**ONLY \$179.95**

• RAILSTILE CUTTER  
• RAIL END CUTTER  
• PANEL RAISER ALONE  
**\$59.95**

• DRAWER GLUE JOINT \$35.00  
• CORNER LOCK MITRE 3-3/8" O.D. \$49.95 For up to 1" material

**FOR THE SHAPER**

3 mm thick C-2 carbide, 3/4" Bore w/ 1/2" Bushing

**Straight**



SY-1212-1 SY-1212-4  
1/4" \$24.95 3/4" \$32.95

SY-1212-2 SY-1212-5  
3/8" \$26.95 1" \$35.95

SY-1212-3  
1/2" \$28.95

**Flute**



SY-1223-1 SY-1223-4  
1/4" \$24.95 3/4" \$32.95

SY-1223-2 SY-1223-5  
3/8" \$26.95 1" \$35.95

SY-1223-3  
1/2" \$28.95

**Bead**



SY-1224-1 SY-1224-4  
1/4" \$24.95 3/4" \$32.95

SY-1224-2 SY-1224-5  
3/8" \$26.95 1" \$35.95

SY-1224-3  
1/2" \$28.95

**FOR THE ROUTER!**

**Dovetail**

PART NO.	D	PRICE
804	1/2	\$6
*804 1/2	1/2	\$6
805	9/16	\$8
810	3/4	\$8
*810 1/2	3/4	\$8
812 1/2	1	\$10

**Flush Trimming**

PART NO.	A	PRICE
S8012Y	3/8	\$7
S8016Y	1/2	\$8
*S8016Y 1/2	1/2	\$8
S8020	5/8	\$10
*S8020 1/2	5/8	\$10

**Vee Groove Bits**

PART NO.	A	PRICE
S112	3/8	\$10
S114	1/2	\$10
S128	3/4	\$12
*S128 1/2	3/4	\$18
S130	1	\$20
*S130 1/2	1	\$24

**Corner Round**



SY-1225-1 SY-1225-4  
1/4" R \$24.95 3/4" R \$35.95

SY-1225-2 SY-1225-5  
3/8" R \$26.95 1" R \$49.95

SY-1225-3 SY-1225-6  
1/2" R \$28.95 1 1/4" R \$49.95

**Cove Bits**

PART NO.	A	PRICE
S702Y	1/16	\$11
S704Y	1/8	\$11
S706Y	3/16	\$11
S708Y	1/4	\$12
S710Y	5/16	\$12
S712Y	3/8	\$12
S716Y	1/2	\$13
*S716Y 1/2	1/2	\$14

**Roundover**

PART NO.	A	PRICE
S502Y	1/16R	\$10
S504Y	1/8R	\$10
S506Y	3/16R	\$10
S508Y	1/4R	\$10
S510Y	5/16R	\$11
S512Y	3/8R	\$13
S516Y	1/2R	\$15
*S516Y 1/2	1/2R	\$15
*S520Y 1/2	5/8R	\$18
*S524Y 1/2	3/4R	\$18
*S528Y 1/2	7/8R	\$30
*S532Y 1/2	1R	\$30
*S536Y 1/2	1-1/4R	\$38

**Core Box**

PART NO.	A	PRICE
S408	1/4	\$9
S412	3/8	\$10
S416	1/2	\$11
S420	5/8	\$12
S424	3/4	\$14
*S424 1/2	3/4	\$14
*S432 1/2	1	\$15

**Beading**

PART NO.	A	PRICE
S602Y	1/16R	\$11
S604Y	1/8R	\$11
S606Y	3/16R	\$11
S608Y	1/4R	\$12
S610Y	5/16R	\$13
S612Y	3/8R	\$15
S616Y	1/2R	\$15
*S616Y 1/2	1/2R	\$15
*S624Y 1/2	3/4R	\$18

\*Indicates 1/2" shank.

**Bull Nose**

PART NO.	A	PRICE
SY9-1	1/4	\$12
*SY9-1 1/2	1/4	\$12
SY9-3	3/8	\$14
*SY9-3 1/2	3/8	\$14
SY9-4	1/2	\$14
*SY9-4 1/2	1/2	\$14
SY9-5	5/8	\$15
*SY9-5 1/2	5/8	\$15
SY9-6	3/4	\$15
*SY9-6 1/2	3/4	\$15
*SY9-6 1/2	1	\$17
*SY9-9 1/2	1-1/8	\$25
*SY9-10 1/2	1-1/4	\$30
*SY9-11 1/2	1-1/2	\$38

**Roman Ogee**

PART NO.	A	PRICE
S5705Y	5/32	\$15
*S5705Y 1/2	5/32	\$15
S5708Y	1/4	\$16
*S5708Y 1/2	1/4	\$16

**Slot Cutter - 4 Flutes**

PART NO.	A	PRICE
SY7002	1/8	\$20
*SY7002 1/2	1/8	\$20
SY7004	5/32" (4mm)	\$20
*SY7004 1/2	5/32" (4mm)	\$20
SY7006	3/16	\$20
*SY7006 1/2	3/16	\$20
SY7008	1/4	\$20
*SY7008 1/2	1/4	\$20

**Slot Cutters/ Rabbeting Bit**

PART NO.	B	PRICE
S1702Y	1/16	\$10
S1704Y	1/8	\$10
*S1704Y 1/2	1/8	\$10
S1706Y	1/4	\$11
*S1706Y 1/2	1/4	\$11
S1708Y	3/8	\$11
*S1708Y 1/2	3/8	\$11
S1712Y	1/2	\$12
*S1712Y 1/2	1/2	\$12

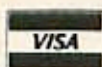

MC / VISA / COD USERS ORDER TOLL FREE 1-(800)-235-0272

IN WASHINGTON STATE CALL 1-236-0272

10 AM - 7 PM - Monday through Saturday





## PRODUCTS THAT PERFORM

Continued from page 20

### LEAVE YOUR MARK



There are many ways to leave your mark on your handcrafted treasures, but here is a high-tech version of a time-honored method — branding. Many of the nation's top woodturners prefer Woodwriter's fine-tipped woodburning pen.

At its hottest setting, the pen point turns red hot and quickly sears. A slightly lower setting, when the tip glows light reddish to orange color, is preferable for most signing jobs.

*The Woodwriter, available for \$62.95 ppd. from Craft Supplies, 1287 E. 1120 S., Provo, UT 84601.*

### BUILT FOR BIG SANDING JOBS

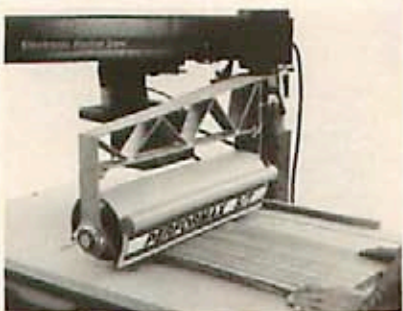

If you routinely belt-sand wide boards, you'll appreciate a precision surface sander that attaches to your radial arm saw. After the initial adjustment, the 44"-wide sanding unit attaches to the saw in a matter of minutes. We were pleased with the quality of sanding on random boards and a 32"-wide tabletop. You can easily replace strips of 3"-wide sandpaper.

*Performax S/T, \$315 ppd. from Performax Specialty Products Co., 17065 Judicial Road, Lakeville, MN 55044.*

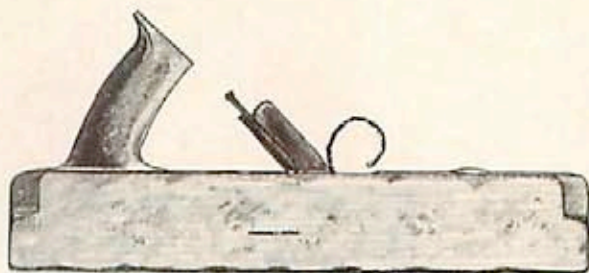

## APPALACHIAN HARDWOODS

**Beautiful grain and textures. Exceptionally workable.** Our Appalachian hardwoods are locally grown, personally selected and kiln-dried . . . a guarantee of our measure of quality. ■ We handle 21 species of domestic hardwoods, softwoods and hard-to-find imports. ■ Send \$2.00 for our catalogue today (refunded with order). All purchases at delivered prices. **EDLCO**

P.O. Box 5373-A, Asheville, N.C. 28813

For fast service, call 1-704-255-8765

THE ALL-NEW

## Scroll Mate

14" 3-SPEED SCROLLSAW

You Owe It To Yourself To  
COMPARE BEFORE YOU BUY!

- 3 Speeds**—To handle all types of materials from soft woods and delicate veneers through plastic and non-ferrous metals
- Ample Capacity**—14" throat, Generous 2" depth-of-cut
- Built-In Blower**—(Standard) Keeps the cutting line clear of debris
- Smooth, Quiet Operation**—Delivers the sound and feel of quality
- Powerful Enclosed Induction Motor**—Tackles even the toughest jobs
- Built To Last**—Made of rugged, cast aluminum for a lifetime of dependable service
- Compact**—Small enough for the utility room or garage with room to spare



**CALL TOLL-FREE  
FOR MORE INFORMATION  
1-800-533-3728**

OR, send your mail-in inquiry to the address below:

Get Your  
**FREE**  
FACT KIT TODAY!

LIMITED 2-YEAR WARRANTY

**MADE IN U.S.A.**

NAME: \_\_\_\_\_  
ADDRESS: \_\_\_\_\_  
CITY: \_\_\_\_\_ STATE: \_\_\_\_\_  
ZIP: \_\_\_\_\_ PHONE: \_\_\_\_\_

DEALER INQUIRIES INVITED



SAKURA, U.S.A.  
P.O. Box 710-J  
Xenia, Ohio 45385

# TURN HOME REPAIR PROBLEMS INTO NO PROBLEMS.

## WITH ELMER'S—THE HOME SOLUTION™ PRODUCTS.

If you have a problem in your home that needs gluing, caulking, filling, glazing or spackling, Elmer's has the answer. THE HOME SOLUTION™ line of products. Look for them at your favorite store. © Borden, Inc. 1988.



**ELMER'S**  
THE HOME SOLUTION™



*Problem: How to stop the draft from drafty windows.*  
THE HOME SOLUTION™: Elmer's Silicone Caulk. Gives you a long-lasting, flexible seal that insulates and waterproofs.



*Problem: How to replace broken window glass.*  
THE HOME SOLUTION™: Elmer's Glaze-Tuff™ glazing compound. It's paintable in only 30 minutes.



*Problem: How to reglue loose rubber on appliances.*  
THE HOME SOLUTION™: Elmer's Stix-All®. A strong, high-tech adhesive that bonds just about anything to anything else.



*Problem: How to repair a crack in a wall.*  
THE HOME SOLUTION™: Elmer's Redi-Spax™ spackling compound. Fast-drying acrylic latex formula stays flexible but sands easily.



*Problem: How to patch the deep gouge in the dining room table.*  
THE HOME SOLUTION™: Elmer's Carpenter's Wood Filler. Resists shrinking and accepts dark and light stain.



*Problem: How to patch the nicks and scratches in the dining room table.*  
THE HOME SOLUTION™: Elmer's Fill'N Finish. Perfect for delicate work. Accepts all kinds of stains, paint and varnish. Easy to sand, too.



*Problem: How to replace caulking around your tub and tile.*  
THE HOME SOLUTION™: Elmer's Tub Caulk. Provides a flexible seal that's water and mildew resistant.



*Problem: How to protect your hands from paint, oil and grease.*  
THE HOME SOLUTION™: Elmer's Invisible Glove™ Protective Hand Cream. Just apply before any dirty job.



*Problem: How to attach Formica® to a countertop.*  
THE HOME SOLUTION™: Elmer's Contact Cement. Forms a strong bond.



*Problem: How to glue the arm back on the armchair.*  
THE HOME SOLUTION™: Elmer's Carpenter's Wood Glue. Penetrates wood deeply for a strong bond.

**K**ing Solomon, proverbial for his wisdom in governing the Israelites during the 10th century B.C., must have really known his wood, too. He chose stalwart padauk for the pillars of his temple.

French kings Louis XV and Louis XVI were separated from Solomon by thousands of years. Yet, these 17th-century rulers also favored a red-orange padauk they called narra. With it, royal woodworkers crafted kingly cups and chalices. Because water placed in these vessels turned yellow, royalty believed the "potion" had medicinal properties.

A century later, the colorful wood of Solomon and the Louis attracted even wider acclaim. As a veneer named amboyna, padauk was featured in Empire-style furniture.

Far removed from European pomp and furniture fashion of the 1800s, convicts sent to British penal colonies in the Andaman islands off Burma labored to supply the padauk sought by world craftsmen. In fact, Chicago's Pullman Company imported much of this exotically beautiful and durable "Andaman" padauk to panel railroad passenger cars.

#### Wood identification

All seven species we recognize as padauk belong to the genus *Pterocarpus*. African padauk (*P. soyauxi*), sometimes referred to as vermilion, is the only padauk species readily available today. Others occasionally sold include: Andaman padauk

## PADAUK

### The wood of kings, railroad trains, and many names



(*P. dalbergioides*), Angola padauk or muninga, kiat (*P. angolensis*), Burmese padauk (*P. macrocarpus*), narra (*P. indicus*), and sandalwood padauk (*P. santalinus*).

Padauk grows in tropical climates, although the geography changes from rain forest to dry, nearly treeless plains with each species. You'll find padauk in India, Indochina, the South Pacific, West Africa, and even southern Florida.

Except for squat African muninga, most padauk trees look like elms, with large, spreading crowns reaching to a height of 120'. Averaging 7' in girth, their slightly irregular, fluted trunks have smooth, yel-

low-tinted bark. Trunks often have no branches for the first 65'.

The leaves of some padauk species provide protein in human diets as a substitute for green vegetables. All padauks bear distinctive, round, inedible fruit banded by a flat wing that gives them a flying saucerlike appearance. In fact, *pterocarpus* means "winged fruit."

Depending on the species, padauk's coarse-grained heartwood varies in color from a lustrous purple-red to orange-red. With age and exposure to sunlight, it turns deep maroon. Quarter-sawn wood features a pronounced ribbon stripe. Sapwood never reaches market.

#### Working properties

About as heavy, but stronger than oak, padauk generally works exceptionally well with either hand or power tools. You'll have no trouble gluing padauk, and screws remain secure.

The wood sands easily, but for a glass-smooth finish, we recommend a paste wood filler or sealer to even out its open grain. Clear finishes should contain an ultraviolet inhibitor to reduce padauk's tendency to darken. Sanding dust may stain your hands and clothes, and may even irritate your nose. And, padauk's bright dust can discolor adjacent unfinished stock if it's of a lighter shade.

#### Uses in woodworking

A first-class furniture and cabinet wood, padauk also makes fine turnings, carvings, and musical instruments. Because it has a high resistance to abrasion, great strength, and doesn't readily decay, it adapts well to cutting board stock. Seaworthy boats have even been made of padauk.

#### Cost and availability

Due to freight costs, padauk prices run higher inland than on the East, West, and southern coasts. Except for Amboyna burl and vermilion, little padauk becomes veneer.

African padauk costs about the same as top-grade black walnut. Other padauks demand higher prices, as do veneers.

Illustration: Steve Schindler  
Photograph: Bob Calmer

# 17

# WAYS TO TURN SHOP

We were curious about how many different jobs a drill press can actually do, so we went to work in our shop exploring its uses. Whether the stock is flat or round, small or long, the drill

press can handle it. *WOOD*® magazine Design Editor Jim Downing even came up with some clever jigs (see pages 30-31 and 74-75) to stretch the use of this handy machine even further.

## WORKING L-O-N-G

Trying to drill accurate holes near the ends of stock with a standard-size drill press table is a lot like balancing on a high wire. It's a tough job! Here's a solution:

We clamped a piece of  $\frac{3}{4}$ " plywood to the drill press table. Make the support as long as necessary, and clamp the workpiece to the fence to keep it from shifting.

1

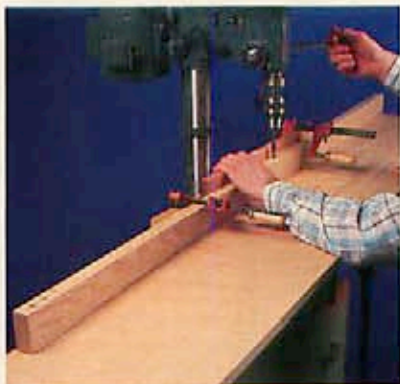

2

## GET THE RIGHT ANGLE EVERY TIME

With our easy-to-make adjustable-angle jig (see design, page 31), you'll never again have to eyeball the angle of cut. To use this jig, just loosen the wing nuts so the fence portion can move freely. Then, use a sliding T-bevel or an adjustable triangle to set the required angle and re-tighten the wing nuts.

# YOUR DRILL PRESS INTO A HERO

In our shop, the drill press earns its keep. We turn to it for help with a myriad of shaping, sanding, boring, cleaning, grinding, and polishing chores. You, too, can test the limits of this truly versatile performer.

We'll bet some of you have discovered other interesting uses, or developed innovative jigs, for your drill press, too. How about sharing with the rest of the *WOOD* magazine audience? Just jot down a

quick note describing the technique and, if possible, a snapshot or sketch showing how you do it. We'll pay \$25 for each entry we publish, and we'll also tell everyone who supplied us with the idea.

Send your entry to:  
MY BEST DRILL  
PRESS TECHNIQUE  
*WOOD*® Magazine  
Locust at 17th  
Des Moines, IA 50336



### 3

#### SPACE SUCCESSIVE HOLES PERFECTLY

If you've made a cribbage board, cradle, or other project that calls for drilling hole after evenly spaced hole, you'll appreciate this technique.

To drill a succession of evenly spaced holes, use our "high-low" fence (see page 31). Start by marking the hole spacing on the stock. Center the bit on one of the marks, clamp the stock, and fasten the fence alongside the stock.

Now, pencil a reference mark on the fence, unclamp the stock from the table, and slide the stock along the fence, drilling holes where marked.

For greater accuracy, use a brad-point bit rather than a twist drill. The brad point will produce a straighter hole because it won't skew off course with hard and soft grain.

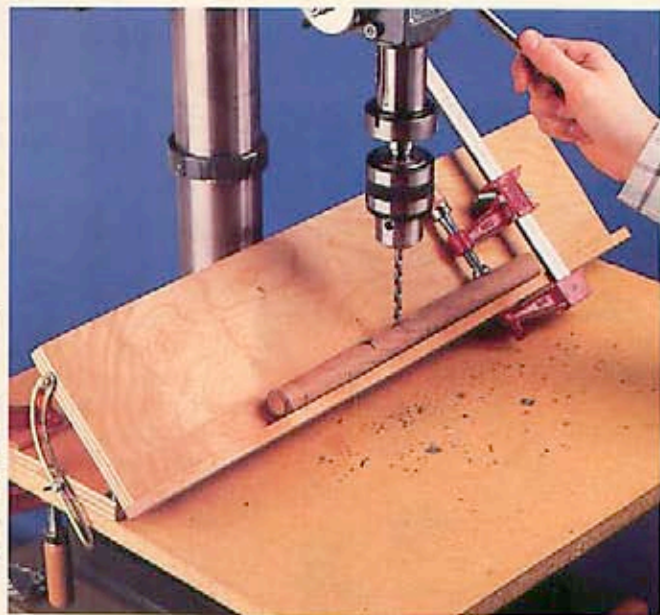

#### DON'T GO 'ROUND GUESSING

You also can use the angle-drilling jig on the previous page to take the guesswork out of drilling round stock, such as a dowel. To be certain you'll drill through the center of the stock, first set the jig at a 45° angle by using a sliding T-bevel as in tip #2. Lower the tip of the bit until it touches the bottom of the jig's V. Clamp the stock to keep it from rolling. Now you're ready to drill the hole. Use a pilot-pointed bit such as a brad-point or Forstner for precise drilling.

### 4

*Continued*

# SHOP HERO

## 5 GETTING A HANDLE ON SMALL STOCK

We've had small parts literally fly out of our hands or break apart during drilling, so anytime you can't get a hand on the stock, just clamp it with a hand-screw. You'll increase both your control and margin of safety.

Do you want even more control, more safety? Then secure the clamp to the drill press table.



## 6 CIRCLE CUTTING THE SAFE WAY

If you've ever had your fingers smacked by a rapidly spinning circle cutter, you'll appreciate this little tactic. Place the stock against the fence and clamp it with a notched hold-down. Before you start cutting, spin the circle cutter by hand to make sure it clears the fence and hold-down.

In the interest of safety, we painted the ends of the circle cutter yellow for clear visibility.

For best results and less overheating, cut until the pilot drill just penetrates the bottom surface of the stock. Then, turn over the workpiece, put the pilot drill in its hole, and finish the cut.



## 7 HAVE A BALL DRILLING SPHERES

Remember that ball you wanted to attach to a handle on a tool or a favorite toy project? Here's an easy way to put a hole through the center of any sphere.

To start, drill a hole that's somewhat smaller than the ball's diameter into a clamped piece of scrap stock. The secret to this technique is to not change the position of the table or scrap while switching to the desired bit. Place the ball on top of the hole, clamp it, and drill away.



## 8 DRILL HOLES INTO ENDS OF DOWELS

To drill a hole into the end of a short length of dowel, clamp a scrap piece of wood to the table, and drill a hole in it that's the same diameter as the dowel. Without changing the position of the table or scrap piece, change bits and insert the dowel into the hole. Now grab the dowel with a handscrew to keep it from rotating, and drill the centered hole. This technique also works well for longer dowels. Just swing the drill press table to one side so the dowel clears its edge.

## 9 MAKE A MIGHTY-FINE MORTISE

Even if you don't have a mortising attachment (see page 60), you can work without one. Lay out the mortise in pencil and center the bit on it. Using a bit the same width of the mortise, drill the end holes first to control the size of the opening.

With a bit  $\frac{1}{16}$ " smaller than the width of the mortise, bore out the remaining wood between the holes. You will have a minimum of  $\frac{1}{16}$ " wood on the inside of the edges—enough for hand chiseling up to the edges.



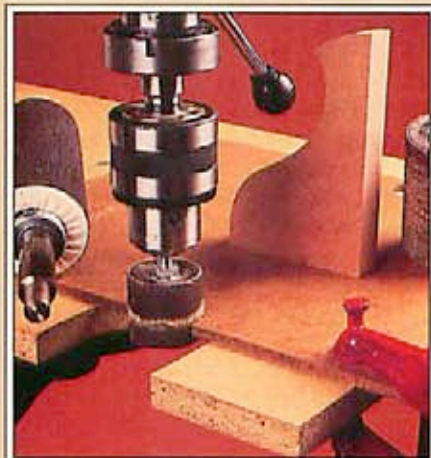
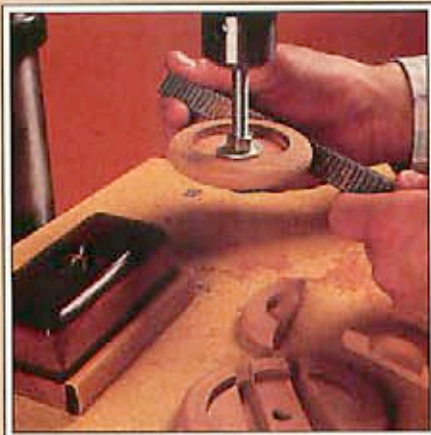

## 10 GETTING "IN SHAPE" WAS NEVER EASIER

Here, your drill press works like a mini-lathe. You can make your own work arbor from carriage bolts or lengths of all-thread rod.

By using wood rasps, files, sanding blocks, dowels wrapped in sandpaper, or other abrasives, you can shape many small objects.

This photo shows us shaping a pair of drawer pulls, believe it or not. After smoothing on the work arbor, cut the pulls apart as shown.

## 11 HAVE BIG SUCCESS WITH SMALL PARTS

You also can insert one end of the stock directly into the chuck, tightening until the part is firmly held (without crushing the wood). Shape with rasps and successive grades of abrasives.

## 12 BE A SANDING DISC JOCKEY

You can save your skin by using a jobber stick like the one shown here. Attach the stick to the workpiece with instant glue or hot-melt glue, and then saw the stick off after you've finished the shaping.

Keep in mind that a slow spindle speed—500 to 700 rpm—gives you the best control when shaping delicate work.

## 13 YOUR DRUM CAN HUM

You just can't top drum-sander attachments for sanding curved edges.

We first cut notches in each side of  $\frac{1}{4}$ " hardboard as shown at left. The notches corresponded to the sizes of the common drum sanders.

We swung the drill press table off to the side so we could plunge the sander through the cutout in our auxiliary table. With this setup, you'll have less chipping of sanded edges as well as edges that are square to the face of the stock.

*Continued*

# SHOP HERO



## 14 GOOD-BYE, RUST. HELLO, SHINY TOOL

Question: How do you turn old tools into new ones?

Answer: With a flap sander, make your tools look like they did when you bought them. With a flip of a switch, you're ready to chase away corrosion on all your tools.



## 15 BE SHARP!

You can quickly sharpen your own jointer/planer blades at home with this handy jig. Now you don't have to take the blades out of your shop and pay someone else to sharpen them, or laboriously do it yourself by hand. (See page 74 for how to build and use this grinding jig.)



## 16 HERE'S A POLISHED PERFORMER

Slap a buffing wheel on your drill press and you're ready to clean and polish neglected hardware such as drawer and cabinet handles. Use the buffing wheel in combination with a metal polishing compound to achieve a lusty finish. For best results, run the buffing wheel between 1,500 and 2,000 rpm.



## 17 DO YOU KNOW ABOUT THIS CLAMP?

When a conventional clamp just doesn't do the job, don't forget your drill press. It may offer an effective solution, especially when you're out of other clamps.

Your drill press will enable you to direct pressure from the center of the glued piece, applying the force evenly. This technique is simple; just position the work to be clamped, lower the quill, and tighten the depth stop.

This works great for a variety of applications, especially when you're preparing stock for the lathe. Here, we've attached an auxiliary faceplate to the clamped piece.

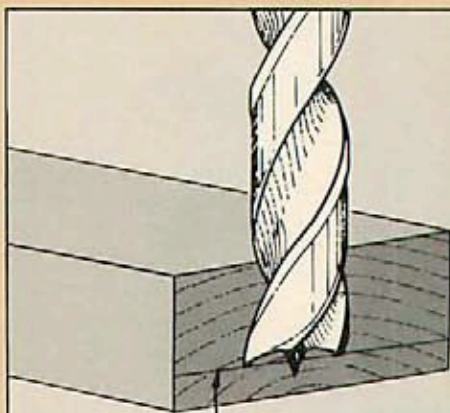
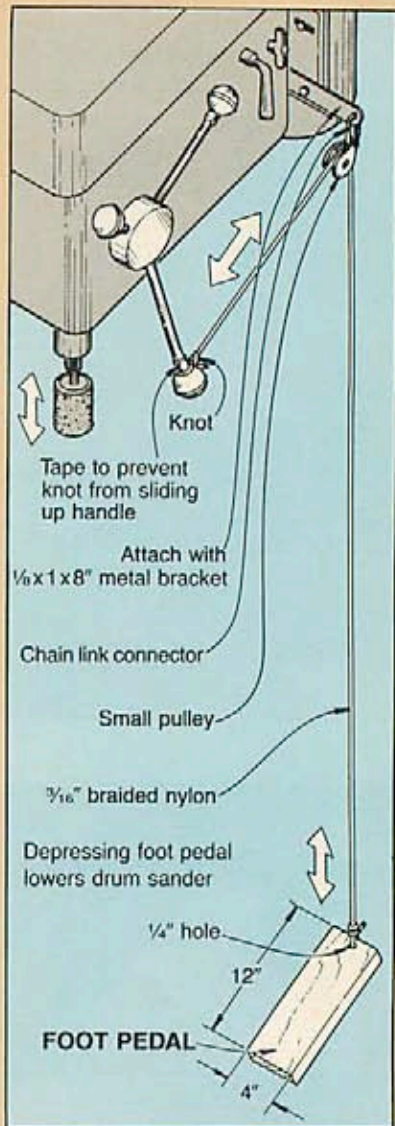

Mark desired hole depth and set depth stop to match

Produced by Bill Krier



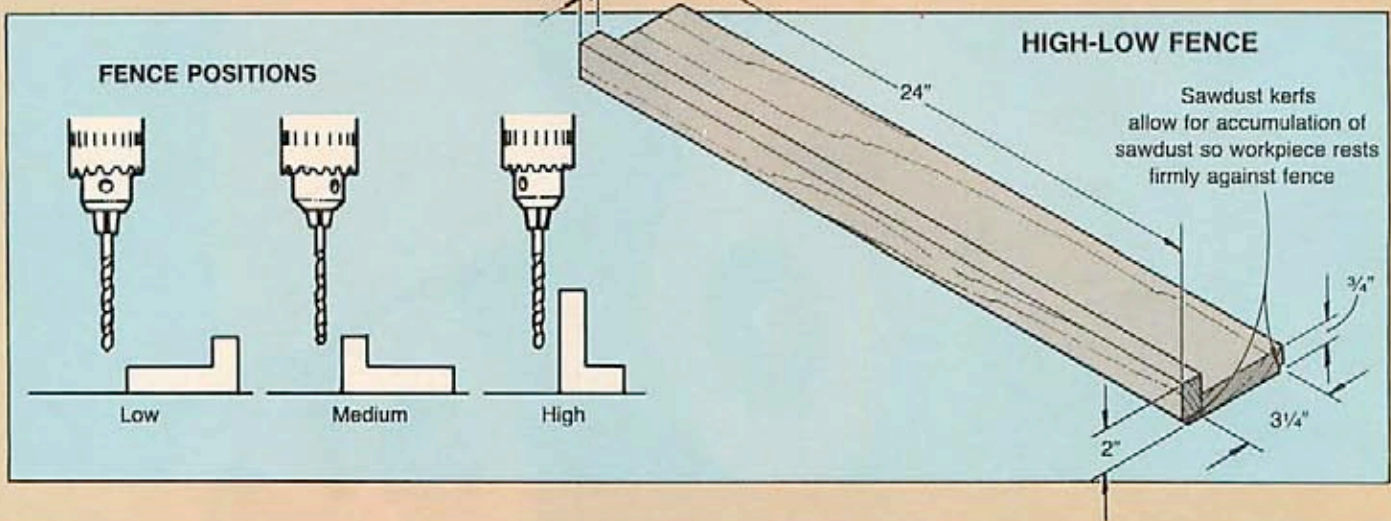
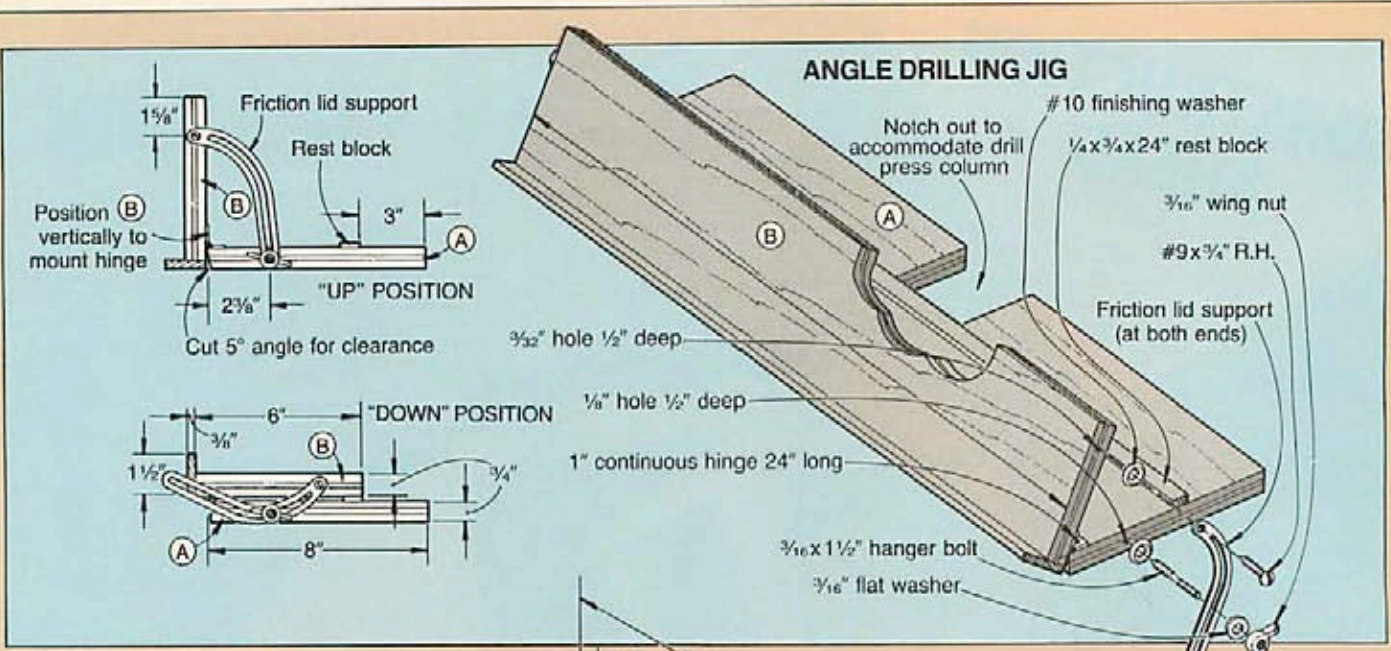

### FIVE TIPS FOR BETTER AND SAFER DRILL PRESS USE

- **DON'T GO OFF THE DEEP END**  
 Achieving exact depth is easy using the handy technique shown at left. Mark the hole depth on the end of the stock, and with the switch off, bring the bit down so its tip aligns with the mark. Lock the drill press depth stop at that point, raise the drill, line the bit up with the marked hole, and proceed.
- **AVOID CHAIN REACTIONS**  
 To keep track of your chuck key, attach it to the side of your drill press with a cord or string. Do not attach it with a chain. If you accidentally turn on the machine with the key inserted, chain links may literally become shrapnel. Always wear adequate face protection when operating a drill press.
- **MAKE YOUR FLUTES PLAY SWEET MUSIC**  
 Don't place your bit so far into a chuck that you cover the flutes (hollow portion). Covering the flutes may dull the cutting edges and inhibit the bit's ability to remove cuttings when drilling deep holes. Raise and lower bits often to clear flutes of debris (not completely clearing top of hole).
- **WEAR DOWN SANDING DRUMS EVENLY**  
 If you've done a lot of drum sanding on a drill press, you know how a drum tends to wear in one area until you stop sanding to move the drum. The solution: The handy foot pedal shown at above, left. Simply step on the foot pedal to lower the sander. The upward spring-action of the drill press will slowly raise the drum sander as you work.
- **DON'T LOSE YOUR TEMPER!**  
 Like people, drill bits lose their temper (hard cutting edge) when caught speeding. Keep your bits sharp by remembering these points:
 
  - Run larger drill bits slower than smaller bits.
  - Drill slower in hardwoods than you would in softwoods.
  - Your bit is too hot if water sizzles on its surface. Use water to cool it down.
 To help you keep your bits from speeding, WOOD® magazine's experts have developed a drill press speed chart. As a reader service, we'll send you this invaluable chart for only \$1 (to cover printing and postage). See the Editor's Angle on page 6 for more information. Then post the chart near your drill press.

Technical Consultant: Jim Boelling Jig Designs: James R. Downing Illustrations: Mike Henry, Bill Zaun Photographs: Jim Kascoutas, Bob Calmer

**CONSTRUCTION  
AHEAD**

## HEAVY HAULIN'

*Note: The instructions and the parts listed in the Bill of Materials are for one tractor. Cut twice as many parts if you want to build two tractors.*

### START WITH THE TRACTOR

**1** Cut a piece of  $\frac{3}{4}$ " pine to 2" wide by 12" long for the cab parts (A).

**2** Measuring 1" from each end of the pine, mark the location for a  $1\frac{3}{8}$ " dado  $\frac{1}{2}$ " deep. Cut the marked dados as shown on the drawing on the opposite page.

**3** Next, crosscut the pine piece into two equal lengths. Mark the windshield location on one of the pieces. (The pine piece is still extra



The construction business has never been better. The roaring success of our Fat Cat Bulldozer in the December 1987 issue of *WOOD*<sup>®</sup> magazine sent Design Editor Jim Downing scurrying to the drawing board to create more road-building pieces. Now we have a fleet!

Build two identical tractors, add a box to one for the dump truck and a lowboy to the other, and watch as your youngster's imagination moves mountains.

# LOWBOY AND DUMP TRUCK

long, so mark the top of the windshield flush with the top of the dado where shown on the photo below. See the Tractor Drawing for size of the window opening). Drill a blade start hole in the center of the windshield, and cut the opening to shape with a coping saw as shown in the photo. Sand or file the windshield edges smooth.

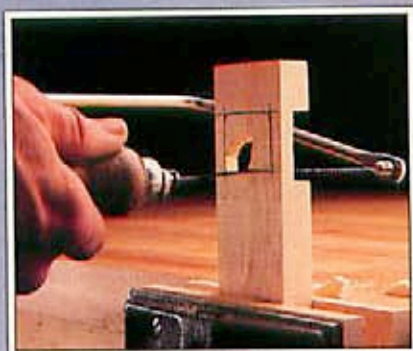

Mark the windshield location, drill a blade start hole, and cut the windshield opening to shape.

4 Apply glue to the mating surfaces, align the dados, and clamp the cab parts (A) together face to face. Later, use a sharp chisel to

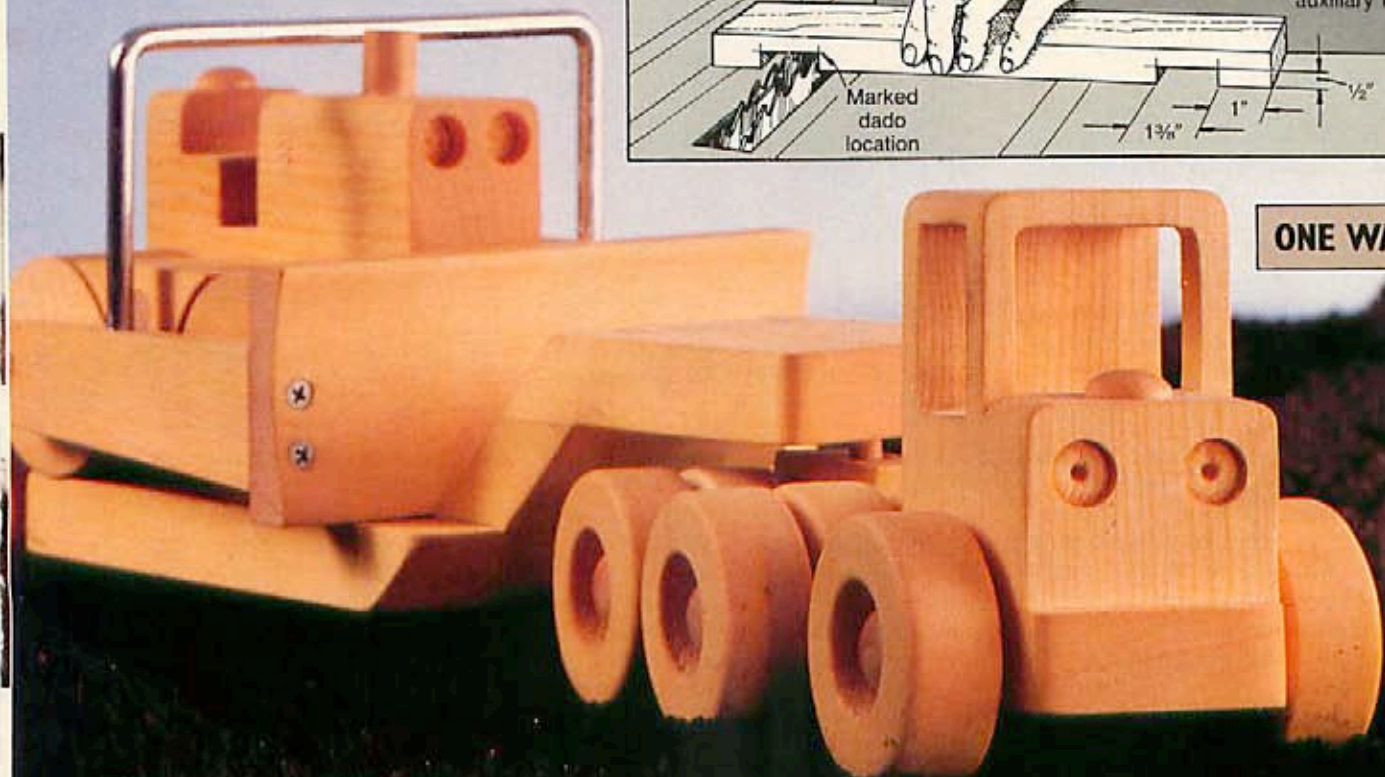
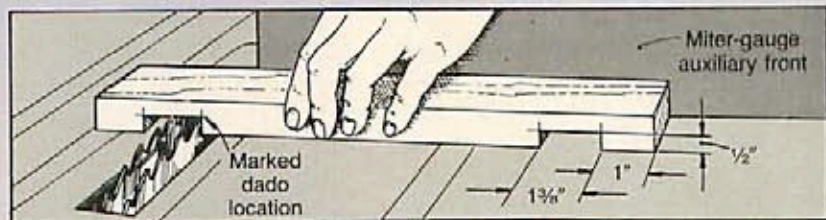
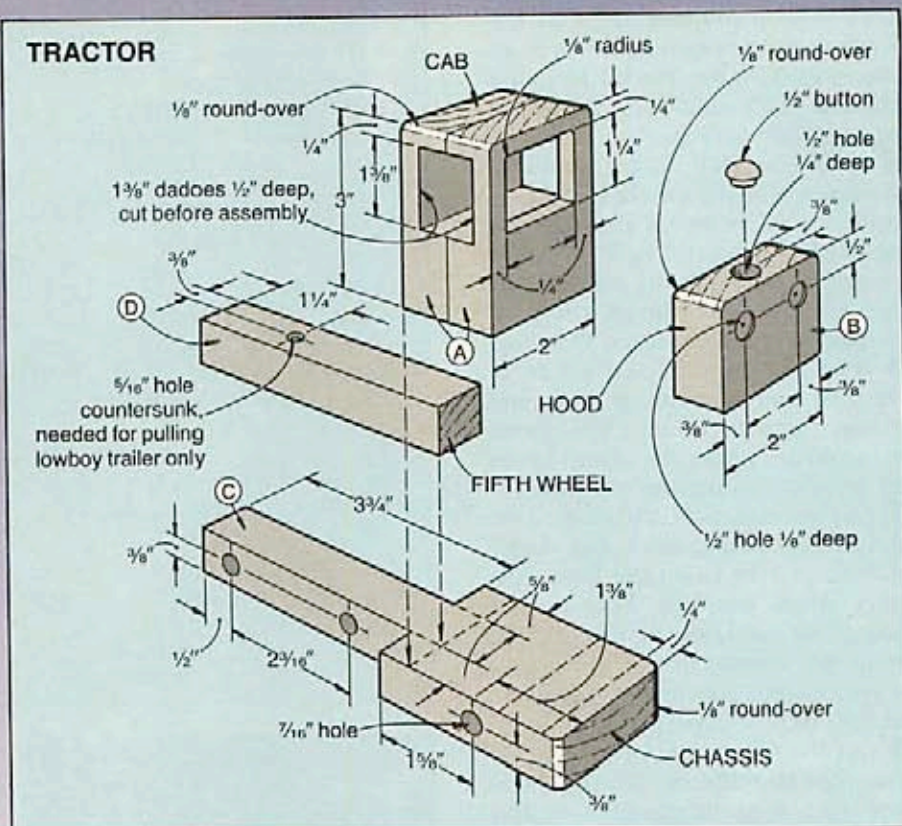

## LOWBOY AND DUMP TRUCK

remove all the excess glue, including that inside the cab opening. Trim the top and bottom of the cab lamination to length (3") where dimensioned on the Tractor Drawing. Sand a  $\frac{1}{8}$ " round-over along the sides of the cab top.

**5** Cut the hood (B) to size. Sand a  $\frac{1}{8}$ " round-over on the top corners. Then, drill two  $\frac{1}{2}$ " holes  $\frac{1}{8}$ " deep for the headlights and a  $\frac{1}{2}$ " hole  $\frac{1}{4}$ " deep centered from side to side for the radiator cap in the hood where dimensioned on the Tractor Drawing.

**6** With the bottom and edges of the cab and hood flush, glue and clamp them together. (We placed scrap pieces under the clamp heads to prevent denting the soft pine.)

**7** Cut the chassis (C) to shape (we did this on a band saw), and sand a  $\frac{1}{8}$ " round-over along the front corners. Mark the axle hole center points on one side of the chassis. Hold the chassis firmly in a hand-screw clamp, and use a drill press to drill the  $\frac{7}{16}$ " axle holes.

**8** Cut the fifth wheel (D) to size. If you plan to build the lowboy later and hitch it to the tractor, drill and countersink a  $\frac{5}{16}$ " hole where shown on the Tractor Drawing.

**9** Leaving a  $\frac{1}{4}$ " gap at the front to form the bumper, glue and clamp the cab assembly to the chassis. Later, glue and clamp the fifth wheel on top of the chassis and against the back of the cab. Sand smooth, and glue a  $\frac{1}{2}$ " button into the radiator cap hole.

### FORMING THE DUALS

*Note: You'll need four inside wheels (E) and six outside wheels (F) for each tractor. In addition, if you make the lowboy, make four inside and four outside wheels.*

**1** To make enough wheels for one tractor, cut a  $\frac{3}{4}$ "-thick piece of pine to 4" wide by 33" long. Use a piece  $\frac{3}{4}$ "x4"x27" for the lowboy. Starting 3" from either end, mark center points 3" apart down the center of each pine board.

**2** With a compass, mark a 2"-diameter circle (1" radius) at each marked center point.

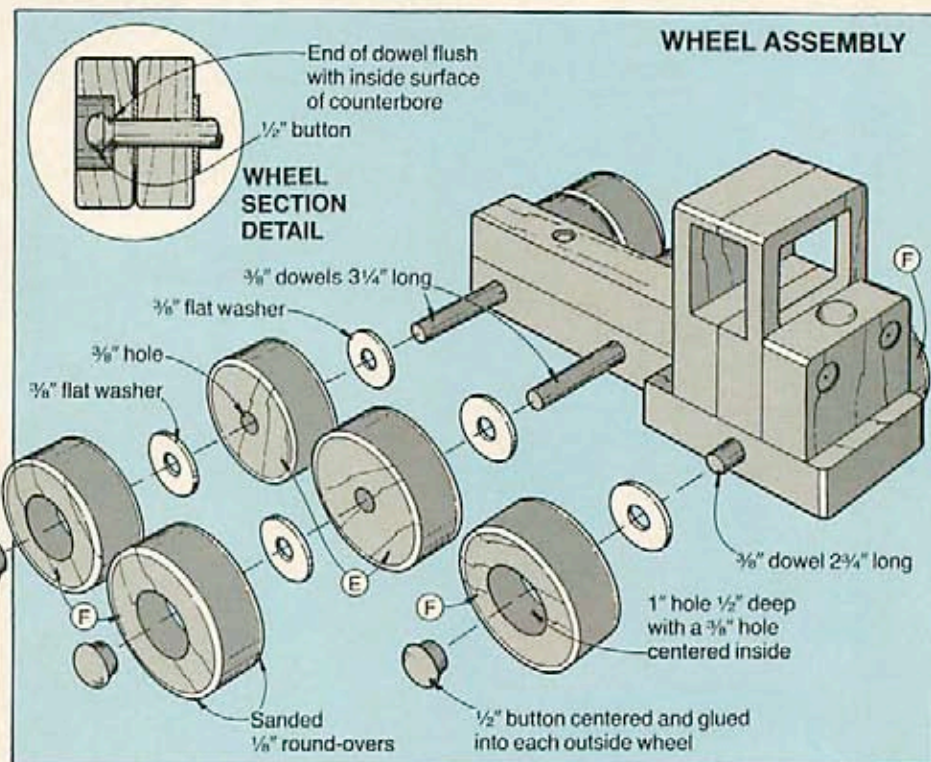

Mark the wheel center point locations on the pine, and drill holes  $\frac{1}{2}$ " deep for each outside wheel.

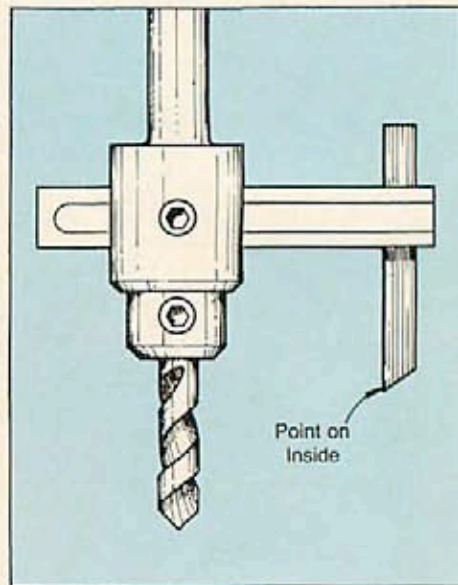

**3** Chuck a 1" Forstner bit into your drill press. Attach a scrap work surface to your drill press table. As shown in the photo above, center the bit over a marked center point, and bore a  $\frac{1}{2}$ " deep hole for each outside wheel (6 outside wheels on the tractor and 4 on the lowboy). We used the stop on our drill press to ensure uniform hole depths.

**4** Chuck a circle cutter to your drill press. Turn the cutter blade to cut a perfect wheel where shown on the drawing above. Raise the cutter blade  $\frac{3}{8}$ " higher than the bottom of the pilot bit. Center the pilot bit over the centered depression in each 1" hole, and slowly cut the wheels to shape as shown in the photo above right.

# KIDS WORKING



## SANDING THE DUALS

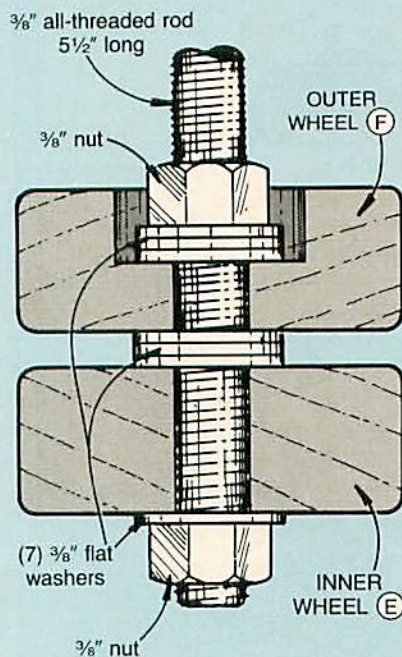

Fasten two wheels at a time to the threaded rod, and sand the wheels smooth. Start with 80-grit sandpaper.

## Bill of Materials

Part	Finished Size*			Material	Qty.
	T	W	L		
<b>ONE TRACTOR</b>					
A*	3/4"	2"	3"	pine	2
B	3/4"	2"	1 1/2"	pine	1
C	3/4"	2"	6 3/4"	pine	1
D	3/4"	3/4"	4 1/2"	pine	1
<b>WHEELS FOR ONE TRACTOR</b>					
E	3/4"	2" diam.		pine	4
F	3/4"	2" diam.		pine	6
<b>DUMP TRUCK BOX</b>					
G	1/4"	2 3/4"	4"	pine	1
H	1/4"	2 1/2"	2 3/4"	pine	1
I	1/4"	2 3/4"	4"	pine	2
J	1/4"	3/4"	3 1/4"	pine	1
<b>LOWBOY TRAILER</b>					
K*	3/4"	4 1/4"	11"	pine	1
L*	3/4"	2 1/2"	2"	pine	1
M*	3/4"	2 1/2"	3 3/4"	pine	1
N	3/4"	3/4"	4 1/2"	pine	1

\*Parts marked with an \* are cut larger initially, and then trimmed to finished size. Please read the instructions before cutting.

**Supplies:** 1/2" wood buttons, 3/8" flat washers, 3/8" dowel rod, 1/4" dowel rod, 3/8x5 1/2" all-thread rod and nuts for work arbor, polyurethane.

## HERE'S HOW TO BUILD THE DUMP-TRUCK BOX

*Note: You'll need 1/4" stock to build the box. We resawed 2x4 pine stock on the band saw to 5/16" thick, and then sanded it to 1/4" thick.*

**1** Cut the box bottom (G) and front (H) to size. Now, cut the sides (I) and cab overhang (J) to a rectangular size, mark the radii, and cut the pieces to shape.

## DUMP TRUCK BOX

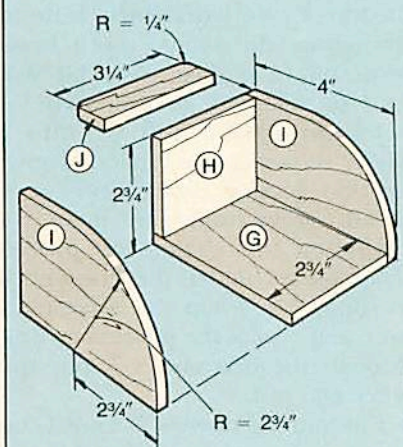

**2** Glue and clamp the box bottom and front between the two side pieces, making sure all the edges are flush. Scrape off the excess glue. Later, sand the box smooth, and glue and clamp the cab overhang to the front of the box.

**3** Glue and clamp the box to the tractor, flush with the back end of the chassis.

**DETOUR**



Center the circle-cutter pilot bit over the Forstner-bit depression, and cut the wheels to shape.

**5** Center the circle-cutter pilot bit over the remaining marked center points, and cut the four inside wheels to shape.

**6** Remove the circle cutter, and chuck a 3/8" twist drill bit into your drill press. Using a handscrew clamp to secure the wheels, enlarge the 1/4" axle hole in the center of each wheel to 3/8".

**7** Cut a piece of 3/8" all-thread rod to 5 1/2" long, and chuck it into your drill press. Attach two wheels at a time to the work arbor where shown on Sanding The Duals Drawing. Starting with 80-grit sandpaper and proceeding through finer grits, sand the wheels smooth. Sand a slight round-over on each wheel as shown in the photo above.

# LOWBOY AND DUMP TRUCK



## NOW, LET'S CONSTRUCT THE LOWBOY TRAILER

**1** Cut a piece of  $\frac{3}{4}$ " pine to  $4\frac{1}{4}$ " wide by 12" long for the bed (K). Miter-cut the front end of the bed for an 11" finished length. Lay out and cut the notches for the rear duals where dimensioned on the Lowboy Trailer Drawing at right.

**2** Mark the axle hole center, and drill the  $\frac{7}{16}$ " axle holes.

**3** Cut a piece of  $\frac{3}{4}$ " pine to  $2\frac{1}{2}$ " wide by 12" long for the gooseneck parts (L, M). With the saw blade  $45^\circ$  from vertical, cut part L to length. From the remaining pine stock, measure  $3\frac{3}{4}$ " from the square end, and miter-cut gooseneck part M to the length shown on the Gooseneck Detail.

**4** Using the dimensions on the Lowboy Drawing, glue gooseneck part L to the front end of the bed (K). (We used masking tape to hold part L in position on the bed.) After the glue dries, remove the tape, and glue and tape part M to part L. Let the glue dry and remove the tape.

**5** Clamp the lowboy assembly to the top of your workbench. Now, to strengthen the joints, use a brad-point bit (a regular twist bit will tend to wander), to drill two  $\frac{1}{4}$ " holes through M and  $\frac{1}{2}$ " into L where shown on the Lowboy Drawing and accompanying Gooseneck Detail. (When drilling the holes, we eyeballed the angle, and placed scrap pieces under the gooseneck to support it.) Flip the assemblies over, and repeat the process to drill through the bed and  $\frac{1}{2}$ " into the other end of L.

**6** Cut four  $\frac{1}{4}$ " dowels 2" long. Glue two dowels in place in M and L, and let the glue dry. Next, glue two in place in K and L. After the glue dries, trim and sand the ends flush with the bottom of the bed and the top of the gooseneck.

**7** Drill a  $\frac{1}{4}$ " hole  $\frac{1}{2}$ " deep centered from side to side in the bottom of gooseneck part M where shown on the Gooseneck Detail. Cut a  $\frac{1}{4}$ " dowel  $1\frac{3}{8}$ " long, and sand a chamfer on one end of it. With the chamfered end protruding, glue the dowel into the hole.

## LOWBOY TRAILER

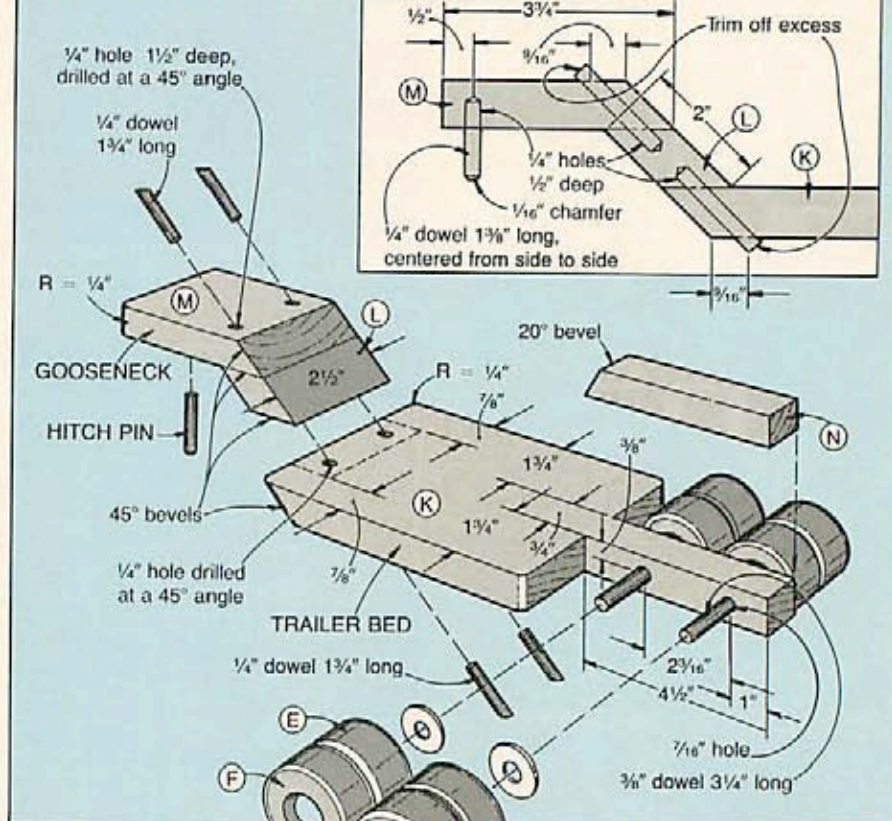

**8** Cut part N to size, miter-cutting the front at  $20^\circ$ . Glue and clamp it to the back of the bed (K) with the back of N flush with the back end of the bed.

## ATTACH THE DUALS AND APPLY THE FINISH

**1** Cut the tractor and lowboy axles to length from  $\frac{3}{8}$ " dowel stock as dimensioned on the drawings.

**2** Glue one outer wheel onto each dowel axle so that the end of the dowel is flush with the inside of the counterbore where shown on the Wheel Section Detail accompanying the Wheel Assembly Drawing. After the glue dries, slide a  $\frac{3}{8}$ " flat washer next to the outer tire and an inner tire next to the flat washer. Don't glue the inner tire to the dowel. Slide the axle assembly through the axle hole, and then add a washer, inner tire, and another washer. Glue the outer wheel to the end of the axle dowel, leaving enough free play so the tires turn easily.

**3** Follow the procedure in step 2 with two wheels and two washers to form the front-axle assembly.

**4** To add the hub caps, set the tractor and lowboy assemblies on their side. Place a dab of glue on the ends of the axle dowels, and glue a  $\frac{1}{2}$ " wood button to the end of the dowel. After the glue dries, flip the assemblies over and repeat for the other hub caps.

**5** Apply the finish (we used Varathane Professional Clear Finish, an aerosol polyurethane).



**Note:** If you don't have the issue with the Fat Cat Bulldozer, send us a self-addressed, stamped no. 10 business envelope to: Fat Cat Bulldozer, WOOD Magazine, Locust at 17th, Des Moines, IA 50336. We'll send you a free photocopy of the how-to article. Offer expires March 1, 1989.

Produced by Marlen Kemmet  
Project Design: James R. Downing  
Photographs: Bob Calmer  
Illustrations: Kim Downing, Bill Zaun

# THE PERFECT HINGE MORTISE

Hand-cutting mortises (gains) for hinges can be tedious work, especially if your project has lots of doors. Worse yet, one little slip and you end up with an ill-fitting hinge. Here's how to speed things along — and end up with a perfect fit every time.

**1** Separate the hinge leaves (if possible) and cut a piece of double-faced tape for each. The tape helps you accurately position the leaf, and holds it securely in place for step 2.

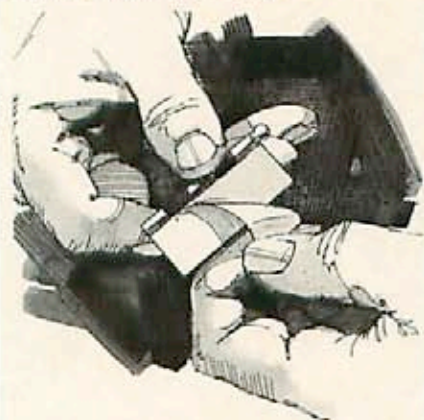

**2** Tape the hinge leaf in position, drill pilot holes, and screw the leaf to the surface. This way, the leaf won't slip when you mark the hinge mortise and drill the pilot holes. To avoid damaging the heads of finish screws, use surplus screws of the same size.

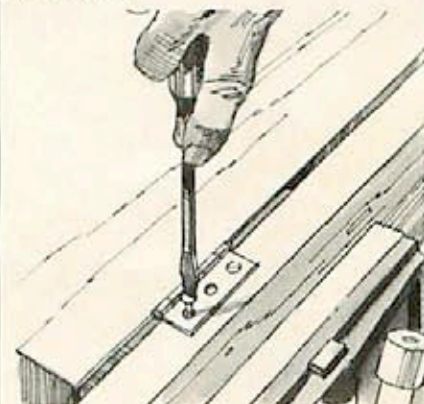

**3** Carefully score end and side cuts with a sharp knife. Scoring gives you more precise lines than you'll get with a pencil. It also helps ensure that your initial cuts won't split the wood fibers along the grain.



**4** Back out the screws and remove the leaf. Mark the mortise's depth. Holding your chisel perfectly vertical with its bevel facing the inside of the mortise, make stop cuts at the ends and side. Easy does it. Don't try to cut to the full depth in one operation, lest you score too deeply and overshoot your mark.

Next make a series of crosswise depth cuts along the length of the mortise — the more cuts, the better.

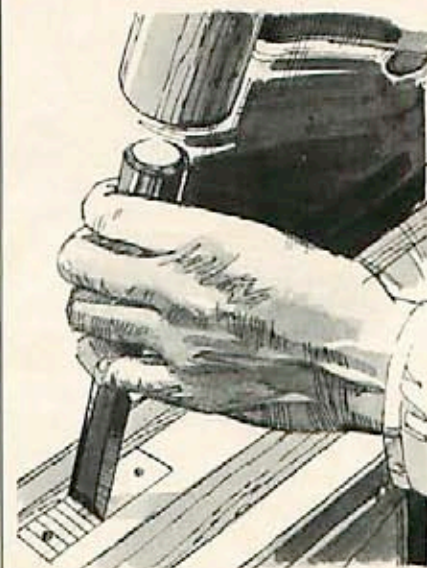

**5** Holding the chisel at a low angle to the wood, bevel side down, clean out the hinge mortise. Work from the center toward the ends. After you've made these lifting cuts, check the depth of the leaf in the mortise. Repeat steps 4 and 5 until the leaf lies about 1/32" above the surrounding surface.



**6** Holding the chisel bevel side up, make light, flat paring cuts across the width of the mortise to achieve a perfectly smooth, flat bottom. When you're done, the leaf face should be perfectly flush with the surface. ♣

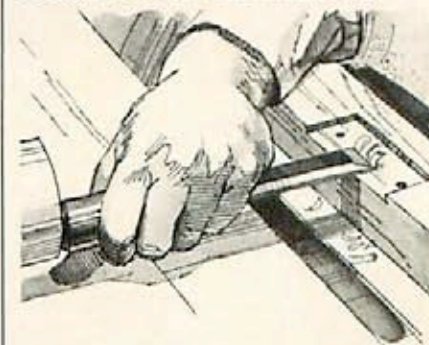

Illustrations: Jim Stevenson



"I always wanted to work with wood," explains Judy Gale Roberts, above. "But, in high school in Houston the principal wouldn't let me take shop class. 'Boys can't take homemaking and girls can't take shop!,' I was told."

School rules didn't discourage her, though. Fortunately for Judy, her father Pat, is an artist. She

tagged along in his studio while he worked on clay sculpting, relief carving, and painting. Hands-on experience with her father's work also nurtured her creativity.

Following high school, Judy enrolled in Houston's Museum of Fine Arts. It proved disappointing. She already knew the first-year basics. "I decided hands-on learning

was preferable, and started working with Dad," she says.

We first spotted Judy's spectacular work among the selections readers send in for "Project Showcase." In Lufkin, Texas, we got a much closer look while Judy shared her skills with us.

Judy's creativity was nurtured by her artist father, Pat Roberts. ▶



# SHE PAINTS WITH WOOD

Judy Gale Roberts crafts spectacular wood mosaics from a palette of surprising color and beautiful grain.

Lufkin, Texas never made it as a cowtown. Oil wells failed to gain a foothold there, too. Logging trucks, rather than hooves or drilling rigs, made all the thunder on main street.

Today, southern pine lumber remains big industry, but trucks bypass the business district. In fact, about the only unfinished stock you'll see downtown belongs to woodworking artist Judy Gale Roberts.

Her studio/gallery on East Lufkin Avenue fills a once-vacant storefront—the result of a state-assisted program to revive Texas' small-town downtowns. In exchange for low-rent space, Judy and a couple other notable artists serve as a tourist draw. Despite the high-quality attraction, Lufkin hasn't seen a boom. There's still plenty of parking space within footsteps of the newly occupied shops and galleries. Occasionally, though, visitors peer through gallery windows. At the studio of Judy Gale Roberts, they discover wood more spectacular than the potential of any seen on local logging trucks.

## "WHAT WOOD IS THAT?"

No one refrains from a question when they first glimpse Judy's work: "How many different kinds of wood are in this picture?"

"Did you carve these?"

"Isn't this marquetry?"

"What sort of stains do you use?"

Even those claiming decades of woodworking experience aren't without comment. "They look at my pieces and say 'This is walnut here.

That's maple there,'" she says. "They really find it difficult to tell what wood it is." The petite artist giggles thinking of the illusions she creates.

With a frank, it-was-beyond-me smile, Judy admits that she only recently discovered the name for her form of wood mosaics. "In 15th-century Italy," she recites, "the inlaying of contrasting woods to form pictures was called *intarsia*."

She doesn't have any stock secrets, either. Judy relies on western red cedar, the same stalwart wood the nation looks to for siding, shingles, and outdoor projects such as decks and planters. "I've experimented with other woods, but keep going back to red cedar," she says. "I never get bored with it. For my purposes, no other wood can match red cedar for varying color and grain."

There's another bonus in Judy's preference for western red cedar—one for the buyer. "This wood doesn't deteriorate," she explains. "So, 100 years from now someone could sand and refinish one of my pieces and the wood will look as warm and colorful as it does today."

## DEVELOPING FEELING, PIECE BY PIECE

Of course, Judy owes much of the know-how she uses today to her father, as well as her sense of color and design. In fact, Judy shared in the toil of a business her father once owned called "Custom Art." The two artists exclusively catered to architects and designers who needed artwork to complement building interiors.

About those days, Judy recalls, "We worked in all different types of mediums. The first thing we did in

*Continued*

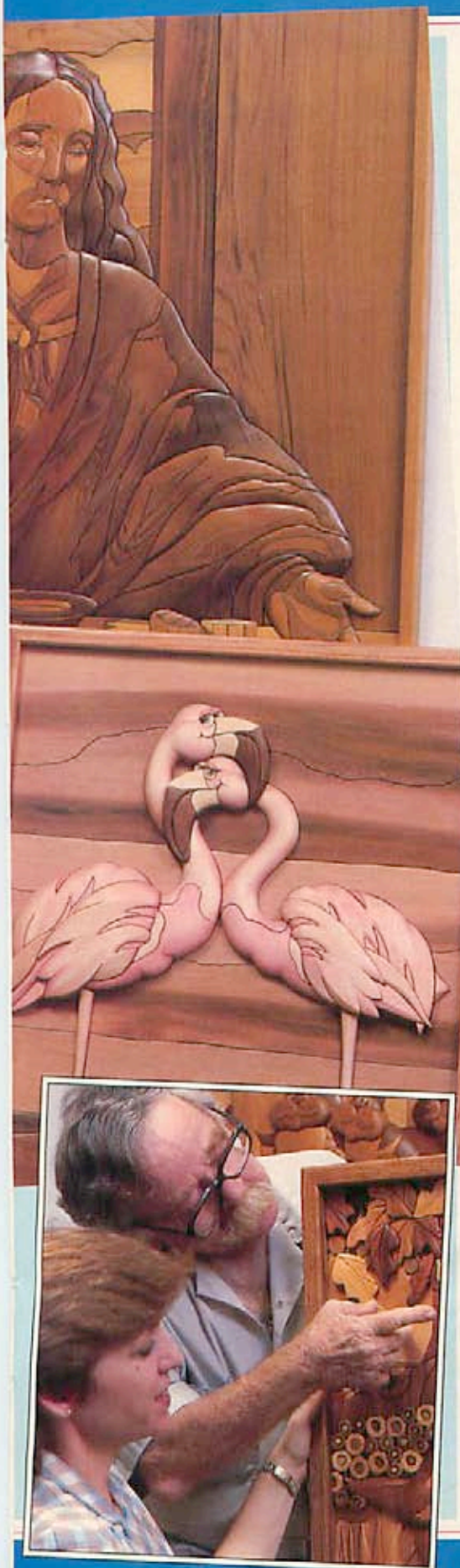

## SHE PAINTS WITH WOOD

wood were some huge flowers about 20' high for the atrium of a bank. Next came a large wall mural for the restaurant at the airport Quality Inn. Then, we did a 14x20' mural for Dow Chemical."

Pat created the designs, but he also helped Judy cut and shape the wood. "What we did then was rougher than what I do now, and it lacked the great variety of color," she says.

Four years ago, when Houston's galloping economy slowed to a walk, Judy and her fiancé, Jerry Booher, decided to move where the art market might be better, and gave Florida a try for a few years. Although back in Texas now, Judy doesn't regret the departure. "Despite leaving Dad behind, the move proved really good for me," Judy says, "because design became my total responsibility."

Judy mastered the basics of fitting mosaics by enlarging her father's small drawings. But Jerry, an experienced machinist, taught her why some designs won't work because the pieces can't be cut on the band saw. Judy began to think of designs in relation to tools, and simplified them. And, she learned the necessity of keeping her work within a price range that sells.

Bombarded with new design ideas, Judy began to portray Florida's abundance of fish, flowers, and wildlife in wood. She pored through books to find out more about what she saw. "I try to read as much as I can on the subject so I can put life and feeling into the figure," she explains. "Who would want one of my porpoises or pelicans if they looked like stuffed, lifeless specimens?"

### WOOD WORK TO FALL IN LOVE WITH

At first, Judy worried that the public might not accept her designs. She needn't have.

At a Florida art fair, a lady purchased a piece featuring a cartoon-like mother cat and her kittens that Judy titled "Kitty Litter." "The woman was so fond of that picture that

when she finally could hold it in her arms, she began to cry," Judy remembers. "And, after she left, I found myself standing there wiping tears from my eyes, too. I guess I get attached to a piece after spending so much time on it. That's especially true of large pieces. They take up so much space on the workshop wall that when they sell I can't get used to the void. It's devastating."

Devastating, maybe. But at times thrilling, too. When famed underwater explorer Jacques Cousteau paid a visit to St. Augustine to overhaul his ship, Judy greeted him with a wood mosaic of the *Calypso*. "I was so excited, I could hardly speak a word," she says of the time she presented the gift to the seafaring celebrity.

People even give names to pieces they buy from Judy. Grinning, she starts a story. "I made a clown picture for a man in Ohio. After I sent it to him he wrote: 'Oliver arrived just fine.' The man had hung 'Oliver' in a special place and talked about him as if he were a person. That always makes me feel good. Selling directly to the public might be more of a gamble, but it's satisfying." At prices that approach \$500 per square foot for intricate, custom-designed murals, and as much as \$1,500 for the 24x42" "Family Portrait," shown *below*, direct sales also put food on the table.

### COLLECTING BOARDS FOR THE PALETTE

Painters draw their hues from tubes of artist's acrylics or oils. Perky Judy selects her palette board by board at the local lumberyard.

"When we go to a lumberyard, I'm like the proverbial kid in a candy store," she beams. "Each piece of red cedar is a new discovery. That's why I have to sort through the boards. If a yardman bugs me about it, I show him my brochure so he can see what I do."

Judy never sees just wood. To her, darkly streaked, figured areas become threatening sky or storm-lashed water.

What she sees and buys becomes part of a mental inventory of images. "I never forget the boards I have; I just keep them in the back of my mind. When I draw a design, I know which boards I'll use in it," explains Judy. "Or, I may design a piece around some spectacular figure or color in a particular board."

Judy and Jerry buy 1x12" and 2x12" nominal, utility-grade western red cedar, even with lots of knots, because that grade offers the greatest contrasts. Most of their lumber comes surfaced one side only, so Jerry runs it all through the planer, a process that Judy views as a further revelation of hidden treasures in color and grain. He rips the wide stock for easier handling.



A fondness for animals and a whimsical imagination result in pieces just made for cat lovers. Judy's "Family Portrait" has all eyes focused on the clan's rascal.



Judy's skill in selecting red cedar colors and grains for a piece such as "Pelican" makes stain manufacturers wince.

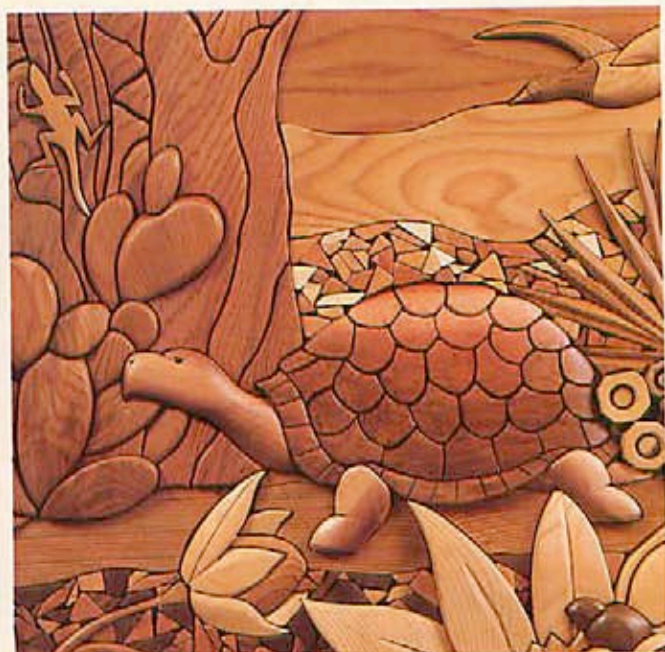

Detail from a 3x5' custom piece depicting Texas flora and fauna illustrates the multitude of pieces Judy employs.

## FILLING A FRAME WITH WOOD—AN INTARSIA PICTURE STORY

When she began her intarsia techniques, Judy's last step would be to frame the assembled pieces. Now, she *begins with the frame*. "It's a lot easier to adjust the pieces of the design to fit. Filling the frame first gives Jerry and me the chance to stand the work up before shaping, then step back and view it. Sometimes, we make a change," she notes. "When you don't have a frame to assemble the pieces in, you can't see the whole picture from a distance unless you glue all the pieces down."

In their creative timetable, the first "standup" comes at about one-third of the way through the process. "If the piece took one day of cutting and fitting," Jerry says, "it's going to take two days of shaping and finishing. Remember, each piece has to be touched a lot more than once."

So where does it all begin? Follow Judy through the steps of her technique, then try your hand at crafting a design she's created specially for you on page 42.

**STEP 1. Select the grain and wood color to match your design.** After Judy draws the full-size pattern from her smaller sketch, she begins searching through her cedar boards. The medium-weight, transparent drafting paper on which she draws her pattern telegraphs wood color and grain to her exploring eyes as she moves it over the board, photo *below*. When she finds a perfect match for one piece or area of

the pattern, she sets the pattern on the board, slides carbon paper under the pattern, and traces the appropriate outline on the wood, *below*. After assigning that piece a number and marking it on the wood, she moves on to other sections until she transfers and numbers all the pattern pieces. In the process, Judy varies color, figure, and board thickness (normally from  $\frac{3}{4}$ " to  $3\frac{3}{4}$ ").



Sometimes, Judy moves the board around under the pattern, scanning it for the specific color or grain pattern.

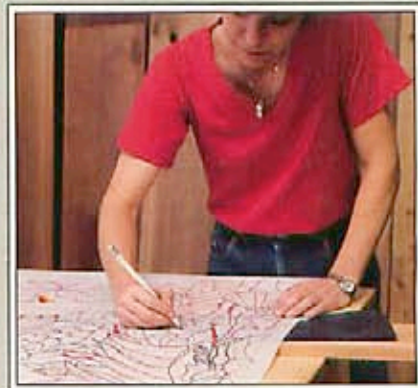

With carbon paper, Judy traces a piece in the design onto the red cedar board and assigns it a number.

*Continued*

## SHE PAINTS WITH WOOD

Jerry's shop-made gauge tells him which size saw blade to use for cutting out the pieces. Tight cuts require the  $\frac{1}{8}$ " blade.

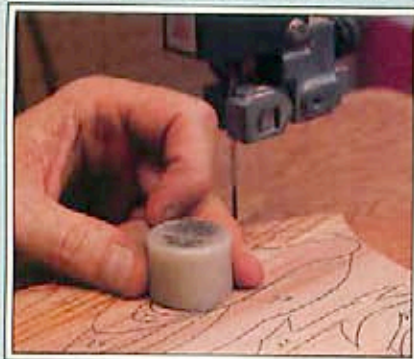

**STEP 2. Cut out the pieces for your picture.** In the shop, Jerry does most of the bandsawing, but Judy often helps out. Two Sears 12" band saws, one fitted with a  $\frac{1}{8}$ " blade, the other with a  $\frac{1}{4}$ " blade, provide the ability to make a full range of cuts without changing blades. The "go-no-go" gauge, *above left*, Jerry made from polyester resin poured into a spray can cap, duplicates the minimum,  $\frac{3}{4}$ " turning radius of a  $\frac{1}{4}$ " blade. It shows him which pieces require the tighter turning radius of the  $\frac{1}{8}$ " blade.

**STEP 3. Fill in the frame.** As Jerry band-saws the numbered pieces from the cedar stock, Judy assembles them—jigsaw puzzle fashion—onto the framed backing of  $\frac{1}{4}$ " lauan plywood, *above center*. To give the mosaic more depth and definition, Judy spaces the pieces about  $\frac{1}{16}$ " apart, *above right*. At this point, Judy sees

As the cutout pieces come from the band saw, Judy assembles them on the framed backing of  $\frac{1}{4}$ " lauan plywood.



her choices of color and grain beginning to work together. She also visualizes how to sand to shape the pieces that will give her work a three-dimensional quality.

**STEP 4. Shape the wood.** A few years ago, Judy shaped pieces with any tool that removed wood, including files and rasps. Today, she works with sophisticated equipment, such as a quartet of inflatable drum sanders in 8", 4", 3", and 2" diameters, and a stationary disk and belt sander. Red cedar sands easily, even with the crudest of tools, but when a 2x4' mosaic contains 1,000 pieces, machinery helps.

Often, shaping means little more than rounding edges. Flower petals, trees, and bird and animal bodies, however, receive nearly a complete contouring under the bite of 80-grit sandpaper, *below left*. Swipes with 120-grit paper smooth the surfaces.

Judy leaves a  $\frac{1}{16}$ " space between pieces to give the design depth. Here, she determines how to shape the tail.



**STEP 5. Spray on a finish, then smooth some more.** Jerry takes over the finishing after Judy shapes the pieces. He sprays all except the backs of each piece with as many as three heavy coats of Krylon-brand clear acrylic. The red cedar soaks it up like a sponge. To get at the sides of even the tiniest pieces, Jerry impales the pieces on dowels fitted with old X-acto blades, *below right*. After the pieces dry, Jerry sands them with 0000 steel wool before the final coat. Some custom work receives up to five coats of finish.

**STEP 6. Reassemble the pieces for the glue-down.** To fasten the finished red cedar to the backing of the frame, Judy has always relied on yellow woodworker's glue. However, she first dry-assembles the pieces to make certain that each one functions in the design as she planned it.



At the inflatable drum sander, Judy sands a section of tree trunk to a gentle roundness with 80-grit sandpaper.

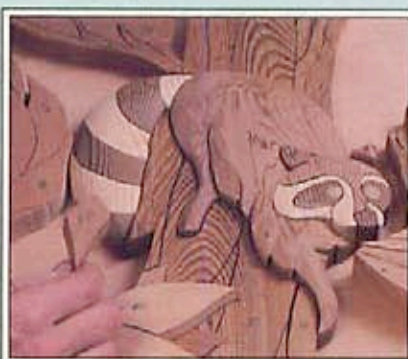

Not all pieces must be shaped, according to Judy. But, the raccoon's tail must look as if it curls behind the tree trunk.



Holder made from dowels and X-acto blades make it possible for Jerry to spray even tiny pieces on all sides.



## TRY YOUR SKILL AT INTARSIA

**HERE'S A PATTERN FOR YOU DIRECT FROM JUDY GALE ROBERTS!**

When we asked Judy the title for the owl wall plaque shown here, she hesitated a minute trying for something clever, then

exclaimed "Oh Hoot!" That's pure Texas!

Judy suggests that you don't need a band saw to cut these pattern pieces. A jigsaw or coping saw will do just fine. And, you can even make it less intricate by cutting each leaf as one piece rather than two as shown. "Then, all you need do is carve the lines on them," she notes. The shaping (by sanding or with a rasp) doesn't have to be elaborate either.

Regarding finishing, she advises, "I like my pieces to be really smooth to the touch, and therefore do lots of sanding. But this plaque could look equally nice with some roughness and texture, especially on the tree."

To make the owl plaque, you'll need:

- Carbon paper
- Medium tracing paper for the pattern
- One  $\frac{1}{4}$ x8x24" western red cedar board of any grade that shows color variety (or a selection of scraps)
- A  $\frac{1}{4}$ x8x24" piece of lauan plywood for backing
- Yellow woodworker's glue
- Clear finishing material

*Note:* Judy always makes the frames first, but for this frameless project, she advises cutting out the pieces first. After you lay them in position on the backing, draw an outline around the picture with a pencil. Then, saw the backing to the shape of the pattern before gluing down the pieces.

**To obtain a free full-size pattern, send a self-addressed, stamped, business-size envelope to: OH HOOT!, WOOD® Magazine, Locust at 17th, Des Moines, IA 50336. Offer expires Feb. 28, 1989.**

For a list of Judy's patterns, send your request with a self-addressed, stamped envelope to J. G. Roberts Patterns, P.O. Box 1925, Lufkin, TX 75902. ♣

Written by Peter J. Stephano  
Photographs: Bob Hawks  
Project design: Judy Gale Roberts

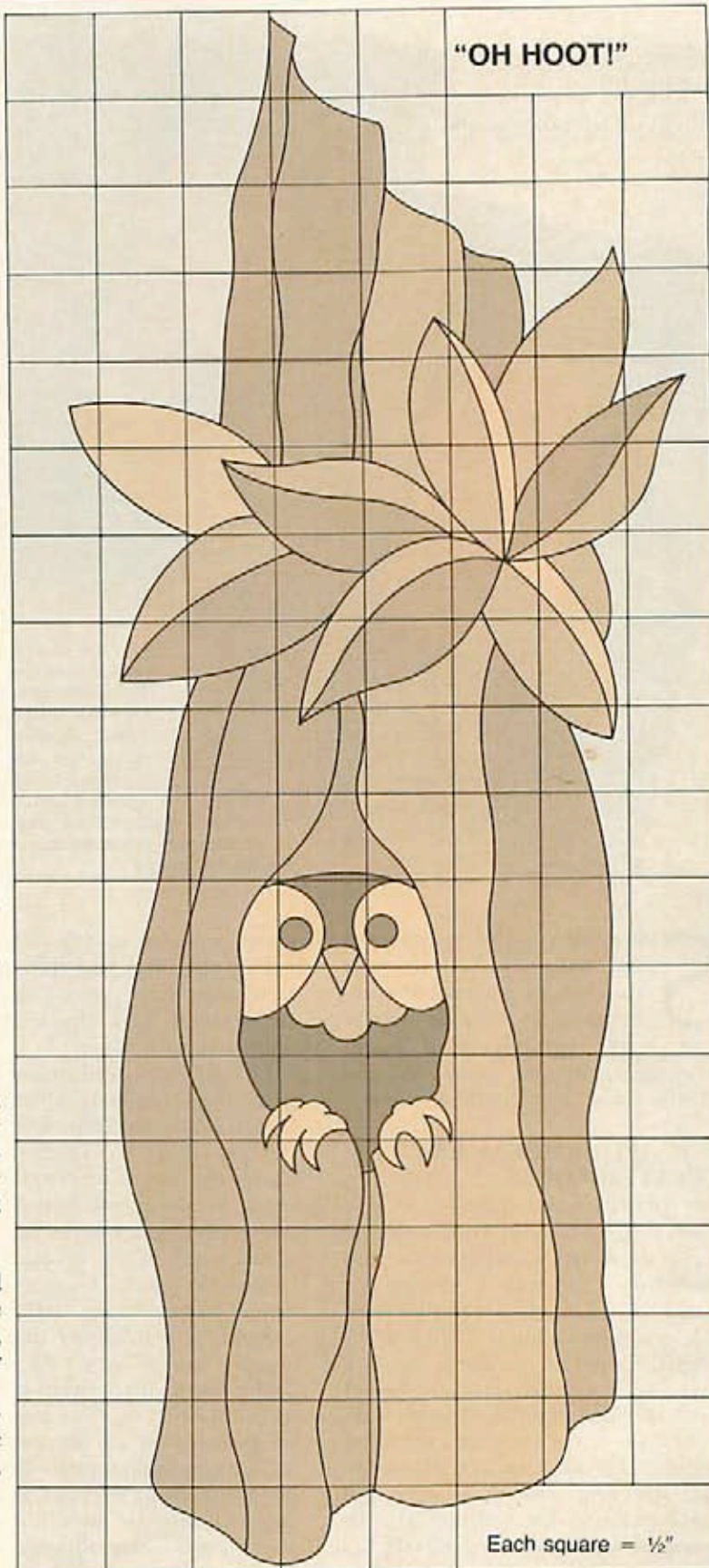

## THE LAST STEP IN FINE CRAFTSMANSHIP



*Left:* An electronic flash washed out the detail in the photograph of the carving and created a harsh shadow. In addition, the background distracts. *Above:* Two photo lamps, a photo background, and the techniques described in this article produced this photo.

# MAKE YOUR

With a good 35-mm camera, some inexpensive lights, a few accessories, a basic technique, and a little work, you can take excellent photos that capture and enhance the beauty of your woodworking projects.

the frame with objects 1" tall.

Photographing large objects, such as a bed or hutch, in cramped spaces with a normal lens poses another problem—sometimes you can't back up far enough to fit all the object in the viewfinder. In this situation, a wide-angle lens works perfectly. Wide-angle lenses have focal lengths of 35 mm and lower. But, you can get too much of a good thing: The wider the angle (the lower the number), the easier it distorts.

A 50-mm lens may also distort somewhat. The part of the object closest to the lens can appear abnormally large, and vertical lines converge. Our eyes and brain compensate when we look at such an object, but not the camera lens. A longer-than-normal lens, such as an 85- to 135-mm, corrects the illusion.

Prevent damage to the lens by adding a lens shade. This inexpensive device also keeps stray light from degrading picture quality.

For the absolute sharpest photographs, you'll need a camera support that holds the camera still during the exposure. Tripods make the best supports, but you can get by with an inexpensive camera clamp—a C-clamp with a tripod screw attached. To increase your camera's steadiness during the shot, purchase a cable release so you won't have to touch the camera.

### HOW TO BE SAFE AT THE RIGHT SPEED

Film has two critical characteristics—speed and type. Speed, expressed as a number, indicates how long the film must be exposed to

**S**kipping on the finish of a carefully crafted project cancels out your woodworking skill. So do poor photos. And, in photography as in woodworking, technique, time, care, and quality tools yield the best results.

### NOT ALL CAMERAS ARE CREATED EQUAL

For professional-quality, studio photos to document your work or send to juried competitions and craft fairs, start with a 35-mm (or larger format, such as 120 film) single lens reflex camera (SLR). Why? Viewfinder-type cameras have a viewing lens separate and offset from the lens that takes the picture. Your eye never sees exactly what the film records. An SLR, however, uses the same lens for viewing and picture-taking. This enables you to compose your picture perfectly be-

cause you see exactly what you'll get on the film. And although most new SLRs have an automatic feature, you'll have the best results with manual settings.

For the bulk of project photography, the standard 50-mm focal length (distance from front of lens to film) lens works fine. It sees things the way your eye does. However, in some situations, such as when photographing small objects, it just won't do the project justice.

Most 50-mm lenses can't focus on objects closer than 18" from the camera, which means that objects smaller than 8" won't fill the viewfinder frame. If you want pictures of miniature pieces, solve the problem by purchasing an inexpensive set of close-up attachments that screw onto the front of your lens. Used individually or in combination, these accessories allow you to fill

# PROJECTS PICTURE-PERFECT

light before it accurately records what you're photographing. "Fast" films (higher numbers) require less light and exposure times than "slow" films (lower numbers). The usual trade-off for higher speed is less definition in your photo. For sharp pictures and tolerable times, select medium-speed films.

Type of film translates to prints or slides, and also whether you expose it with daylight, flash, or photo lamps. For black-and-white prints, a film such as KODAK PLUS-X PAN Film does the trick. For color pictures, you have two choices. Color prints require a film such as KODACOLOR VR-G 200 Film; for slides, use KODAK EKTACHROME 160 Film (tungsten). With an 80A filter that screws onto your camera lens, you can use a film made for daylight exposure—such as KODACOLOR VR-G 200 Film—indoors, with photo lamps.

Prints, both black-and-white and color, will do if you want to display your work. Most juried competitions, art fairs, and publishers only accept color slides (sometimes called transparencies).

## LIGHTS AND BACKGROUNDS PROS RELY ON

In photographing your projects, you have three types of lighting to choose from. Daylight provides the most convenient source. However, you'll have little control. Sunny days produce harsh shadows. Overcast skies or shade won't give you enough lighting contrast and your photographs appear flat and lifeless.

Electronic flash, although inexpensive and portable, doesn't allow you to see the lighting effect until after the picture has been processed. You can't soften glaring highlights, lighten shadows, or eliminate reflections beforehand.

Photo lamps provide the best alternative to daylight and flash because you control the amount of

light. Thus, you'll see the effects *before* you take the picture.

Shaped like large light bulbs, photo lamps are specifically designed for photographic use. A basic setup requires one *ECT* (500-watt) lamp, one *ECA* (250-watt) lamp (*ECT* and *ECA* are industry designations for lamp type and use), and two 10-12" photo reflectors rated for 500 and 250 watts. Either buy light stands for the reflectors, make your own, or purchase spring-loaded clamps you attach to a support.

To soften the light for project photography, you can use diffusers to position in front of the light. These are available ready-made, or you can make your own from a piece of matte acetate mounted to a frame. With this setup, don't let daylight into the room during photography or you'll disrupt color balance!

For backgrounds, you have two choices. Either photograph an object in a setting that relates to its use, such as outdoor furniture on a patio, or in front of a paper photographic background. In your first option, the project suffers from surrounding distractions. The second method focuses only on the object.

Standard backgrounds come in

rolls 53" and 107" wide and a variety of colors. Many photographers prefer a medium gray, such as Thunder Gray or Slate Gray (standard industry colors).

You can buy or make a holder for the background to support it. Always unroll the background so that it comes down behind and under the piece to be photographed with a smooth transition from the vertical to the horizontal. For professional quality, never try to substitute a freshly ironed bed sheet for background paper—it will still look like a sheet!

## A SET MADE FOR STARS

The technique for good composition begins with setting up the camera and tripod. Next, look through the viewfinder and determine the viewing angle that best illustrates your project. Usually, you position the camera so that you see the object as your eyes would. Photograph a table with the camera above it and tilted downward. To photograph a large armoire, keep the camera at eye level. Always move the camera close enough to the object so that the area of interest—your work—nearly fills the

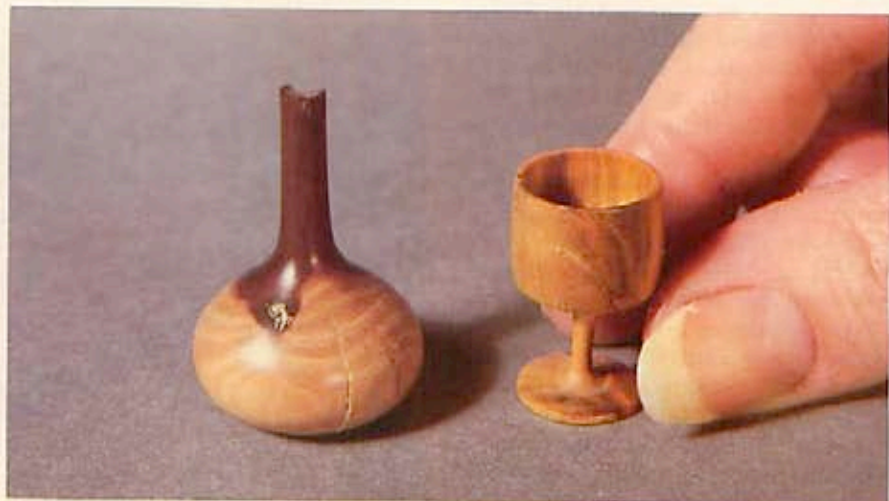

Without fingers to give these pieces proportion, would you know they were only 1" tall? Items such as coins, keys, pencils, etc. also will work.

*Continued*

## MAKE YOUR PROJECTS PICTURE-PERFECT

viewfinder frame, and carefully focus on the object.

If the size of an object isn't obvious, place a prop next to it to show relationship (see photo, *preceding page*). Don't be afraid to turn the camera vertically to capture all the image in the frame.

To light your set so your work looks its best, arrange the photo lamps with the 500-watt light high and to one side of the camera and at a 45° angle to the subject. Place the 250-watt fill light near to and on the other side of the camera, as shown in the drawing at *right*. Diffuse the fill light or move it far enough back so that it won't cast a second shadow off the project.

When you adjust the lights, keep in mind that you want to show size, shape, texture, and detail (see jewelry box photo, *lower right*). You may need more than one photograph to completely show your work, as shown in the table photos, *far right*.

### THE LIGHT AND DARK OF CAMERA SETTINGS

With your work, the lights, and the camera in place, you next have to determine exposure settings. The two camera settings that determine the amount of exposure are aperture size (how much light actually reaches the film) and shutter speed (the length of time you allow the light to expose the film).

Aperture sizes show up as "f" numbers, such as f/16 or f/5.6. Fractions of a second indicate shutter speeds, such as 1/4 or 1/250 of a second. The best combination for most of your project photography will be f/16 to f/8 with the corresponding shutter speed determined by your camera's metering system. These apertures give you more "in focus" area, called depth of field, than a wider setting, such as f/2.8.

To help determine exposure settings when light and dark woods and varying backgrounds might fool a camera's light meter, pros turn to the neutral gray card. Set this gray piece of cardboard near the object,

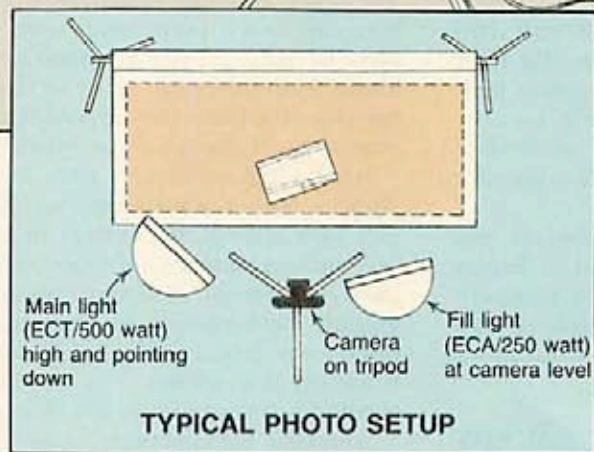
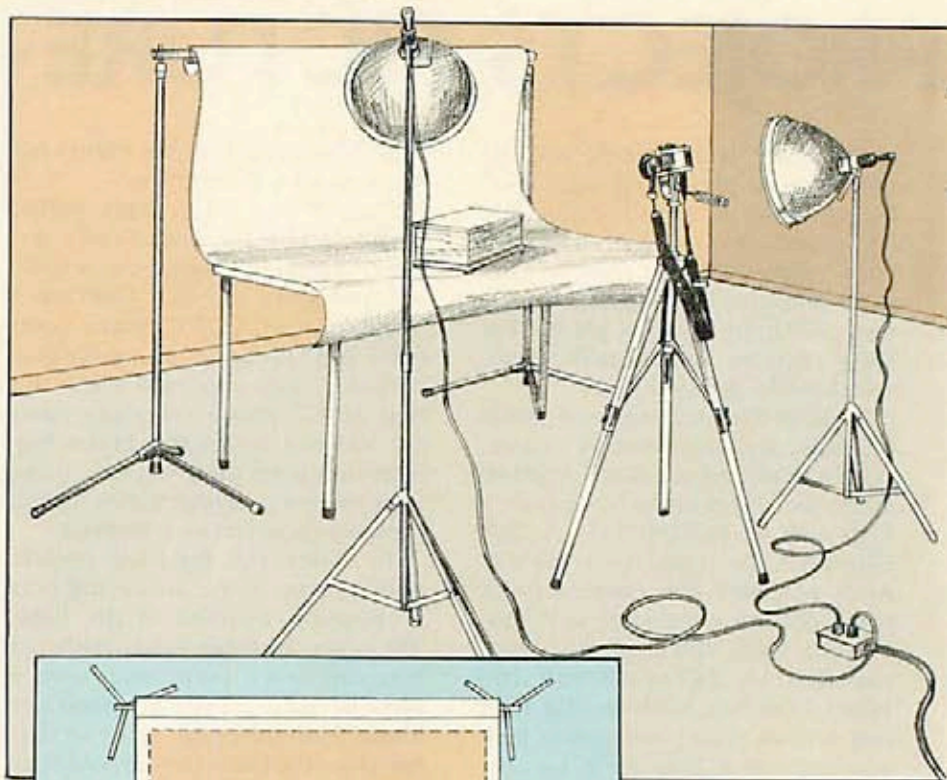

To obtain a professional-quality photo with minimum shadows, set up your lights and camera as *above*. For a project approximately 2' x 2', the main light, fill light, and camera should be about 4' away from it.



This properly lit photo of a 12"-long jewelry box shows how a different amount of light illuminates each plane and adds dimension.



## APPROXIMATE CAMERA EXPOSURE SETTINGS FOR EXAMPLE SHOWN IN DIAGRAM

TYPE OF PICTURE	FILM	FILTER	TYPICAL CAMERA SETTING*
Black-and-white print	KODAK PLUS-X PAN Film	None	1/8 sec. @ f/16
Color print	KODACOLOR VRG 200 Film	80A	1/4 sec. @ f/11
Color slide	KODAK EKTACHROME 160 Film (tungsten)	None	1/8 sec. @ f/16



Props help show the size of this cherry, black walnut, and padauk table. Often, you'll need more than one photo to show details not easily seen in an overall photo.

point the camera and fill the viewfinder frame with it, and the camera's built-in exposure meter makes an average reading compensating for shadows as well as bright spots. If you use an 80A filter to balance daylight film with photolamps, put the filter on the lens when you take the reading.

For the most satisfying results, borrow a technique from the pros called "bracketing." Bracketing consists of a series of five different exposures: the calculated exposure, and four others—two on either side of the calculated exposure—allowing more and less light to reach the film. For example, if your calculated exposure is 1/30 second at f/16, your bracketed series would be: f 1/8, f 1/15, f 1/30, f 1/60, and 1/125 second at f/16. You can also bracket by keeping the shutter speed constant and changing the lens aperture.

### FOR A FINAL FINISH

When you have print film processed, always ask for glossy paper because it produces the best detail. Inspect the results. Look for proper exposure, sharpness, and color. Any problems in these areas may be your fault, but they could be that of the processing lab. Sometimes a lab can reprint a negative and improve the quality. ♣

### PHOTO SUPPLIES YOU'LL NEED FOR PRO-QUALITY PICTURES

(In addition to camera, lenses, and film)

Lens cleaner and tissue .....	\$4
Cable release .....	5
ECA/ECT photo lamps, each .....	3
Tripod .....	40
Lens shade .....	5
Neutral gray card .....	7
Paper background (9' x 12 yards) .....	30
80A filter .....	10
Close-up lenses .....	15
10" light reflectors, each .....	25
Light stand, each .....	20
Light diffuser .....	15

Written and photographed by Gary A. Zeff  
Projects crafted by: carving, David Yendes; miniature vessels, Jerry Glaser; jewelry box, Charlie Johnson; table, T. C. MacMichael

### CURIOSITY GOT HIM

*Brent L. Veleker, 38  
Lockport, Illinois  
Machinist*

When Brent's mental gears start shifting to creation, he sprints for the woodshop. This time, what he went round and round about was the construction of a spinning wheel.

Researching spinning wheels provided Brent with only the rough dimensions he needed to complete his solid-cherry spinning-wheel project. But, he took it from there, first building the 1 $\frac{3}{4}$ x6 $\frac{1}{2}$ x18" platform and the 20"-diameter great wheel that mounts on it. His calculations of 34" in overall length and 35" for height turned out to be on target.

About the spinning wheel he crafted, Brent says, "One of the hardest parts was making the wheel. The spokes are longer than the radius between the hub and the rim." In order to properly fit the spokes in place, he drilled holes in the four-piece, dovetailed rim and in the hub. Then, Brent sawed the hub in half, fitted the spokes in the rim, and glued the hub back together around the spokes.

Brent likes dark, rich, naturally aged cherry. To get it, but still protect the wood, he applied a clear Minwax finish. By the way, Brent also built his lathe, band saw, and jointer!



### A JEWEL OF A BOX

*Rusty Martin, 38  
Poplar, Montana  
High School Activities Director*

Rusty's eye for detail shows in this musical jewelry box he made for his wife, Juanita. He resawed the walnut to precisely the thickness he wanted: top, 1/2"; sides and drawer front, 3/16"; drawer sides, 1/4"; base, 3/4", and 3/8" for the base trim. He assembled the 7x7x14" box with mitered joints and routed the thin edges. To mount the purchased, pre-assembled inlay flush with the top, Rusty says he cut out an area with router, chisel, and knife that "wasn't even 1/8" deep."

The drawer separates earrings and baubles. With a dado blade, Rusty notched two sets of 1/4x1x6" strips, then crisscrossed them for compartments. So necklaces won't get hung up in the works, he boxed in the music box movement.

Rusty hand-rubbed the box with oil. He then applied a liquid wax.



#### To submit your projects . . .

Send a 35-mm color slide with the project as the focal point and a simple background—no people. Include a description of materials, special joinery, finish, and dimensions. *WOOD*® magazine will pay \$25 for published projects. Slides cannot be returned unless you enclose a self-addressed, stamped envelope.

# SHOWCASE

## TEAMWORK HALVES THE EFFORT AND QUADRUPLES THE PROJECTS

*Frank and A.J. Bock, 58 and 57*

*El Toro, California*

*Professor of Anthropology, Petroglyphologist*

Not sold on the venerated cedar chests they saw in furniture stores, Frank and A.J. joined forces to make this 17x17x45" clean-lined, traditional chest of solid eastern red cedar which smells as good as it looks. Teeming with enthusiasm over their success, the

brothers—who share unique professions in the study of ancient man and cultures—went on to make three more as gifts for their daughters.

Frank and A.J. edge-joined random-width, aromatic cedar boards they first planed down to 3/4" thickness for top, bottom, and sides. Rabbed joints hold the chest together; locking hinges brace the top. Inside, they constructed a tray made from pre-cut, tongue-and-groove aromatic cedar sold for closet lining. The tray rests on a cedar railing to make it easy to lift out and remove large objects.

After sanding their way through multiple grits of sandpaper to a final polish with 0000 steel wool, Frank and A.J. finished the exterior with "seemingly dozens of coats" of tung oil. The interior was left unfinished so contents would be deluged in cedar fragrance.

After sharing the labor of four cedar chests, a rocking burro for a grandson, and other projects, the brothers still enjoy working together making sawdust in the shop. How's that for an enduring, woodworking brotherhood?



## GLIDE-A-BY BABY IN GRANDPA'S OAK CRADLE

*Daniel Schildkraut, 57*

*Mesa, Arizona*

*Retired Physician*

As his first "built-from-scratch" project, Dan designed the 32"-high oak cradle for his expected grandchild around the size of a baby's mattress. The edge-joined, 3/4"-thick cradle sides slope outward seven degrees and butt-join with the end panels.

Dan liked the smooth, near-flat back-and-forth movement of a porch glider, and thought baby would, too, so he bought glider hardware to hang the cradle in its stand. The stand itself features oak bars and stretchers mortise-and-tenoned together.

To lighten the cradle's Mission-style appearance, Dan routed teddy bear and heart designs on the sides of the cradle and the stand. Several coats of Watco oil finished his project. ♣

Send to:  
Project Showcase  
Better Homes & Gardens®  
WOOD® Magazine  
Locust at 17th  
Des Moines, IA 50336

## A Terrific Trio

Liven up your kitchen work space with any or all three of our decorative boards. Not only will they stand the test of time, but they'll look darn good doing it.

# BRIGHTEN YOUR KITCHEN WITH OUR SUNBURST SINK BOARD



### FIRST, CUT AND LAMINATE THE MAPLE AND WALNUT

**1** Rip and crosscut seven pieces of  $1\frac{1}{16}$ "-thick maple (five-quarter stock) to  $2\frac{3}{4}$ " wide by  $22\frac{1}{2}$ " long for parts A. (We cut all seven pieces from a board 6" wide by 8' long.)

**2** For the walnut strips (B), set your table saw fence  $\frac{1}{4}$ " away from the inside edge of the saw blade. Rip 14 strips  $\frac{1}{4}$ " wide from the edge of a piece of  $1\frac{1}{16}$ "-thick walnut  $22\frac{1}{2}$ " long. You also could cut 7 pieces of  $\frac{3}{4}$ " stock to  $1\frac{1}{16}$ " wide by  $22\frac{1}{2}$ " long, and then resaw two  $\frac{1}{4}$ " strips from each piece.

**3** With the surfaces flush, glue and clamp two walnut strips (one along each edge) to each piece of maple. Later, scrape off the excess glue.

### MAKE THE TAPER JIG AND CUT THE WEDGES

**1** Cut a piece of  $\frac{3}{4}$ " plywood to 6" wide by 30" long. Mark three reference points where dimensioned on the drawing at *right*. Using a framing square, draw two lines to connect the points.

**2** Cut along the marked lines to form the wedge-shaped taper in the plywood (we used a hand saw).

**3** Position your table saw fence and jig where shown on the drawing at *far right*. Now, using the drawing as a guide, cut *two* wedge-shaped pieces from each lamination.

### HERE'S HOW TO LAMINATE THE WEDGES

**1** To form the clamping jig shown in the photo on the opposite page, lay a piece of plywood about 30" square on top of your workbench. Now, cut two pieces of  $\frac{3}{4}$ "-thick scrap stock about 1" wide by 26" long. Nail one of the strips onto the plywood near an edge. Then, position the 14 wedges, edge to edge, with the points converging where

## ART-DECO CHEESE BOARD

54



## TEXAS-TOAST CUTTING BOARD

55



In our travels around the country, we see thousands of handcrafted cutting boards. But this one-of-a-kind design originated right here in our shop. Jim Boelling, our project builder, made these as gifts years ago. Jim's short-cuts make cutting and laminating the maple and walnut strips a snap for a stunning finished product.

*Note: This cutting board was made to fit a standard sink with a basin interior measuring  $14 \times 15\frac{1}{2}$ ". For a smaller sink, construct the laminated board as described, and cut it to size later. If your sink is larger, you'll need to make longer laminations and change the cutting angle of the taper jig.*

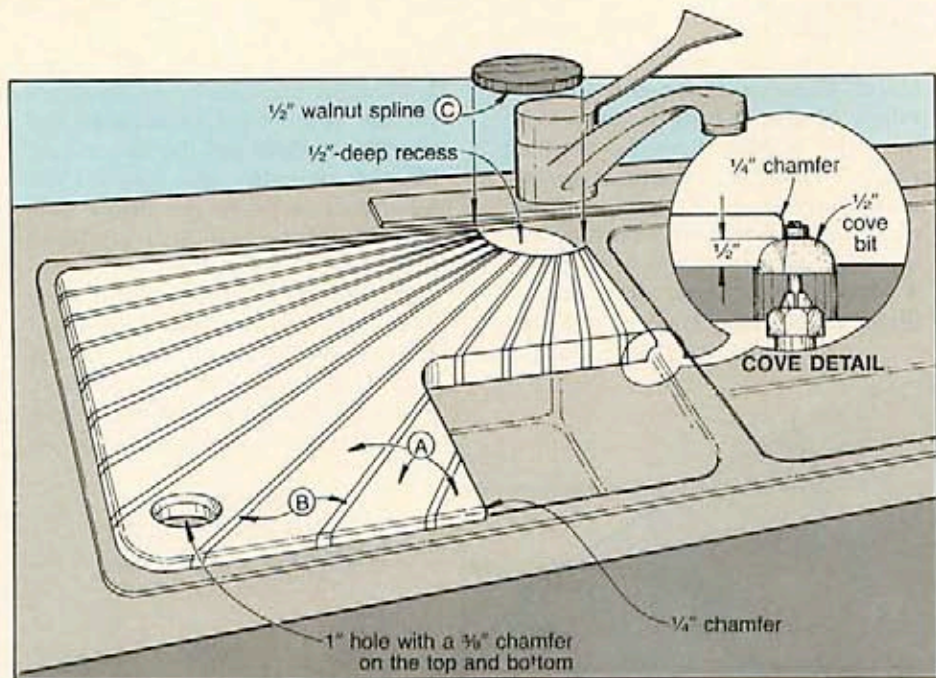

shown in the photo *below*. While holding the laminated pieces tightly against one another, nail the second scrap strip to the plywood and against the other straight edge of the wedges. Remove the wedges from the clamping jig.

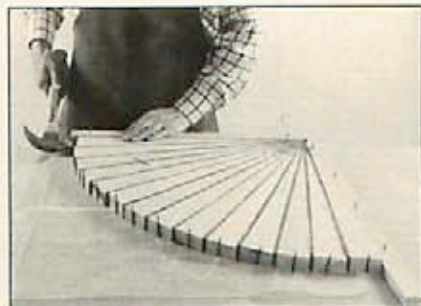

Tap the wedges into the corner of the clamping jig, and then hold the wedges in position with nails.

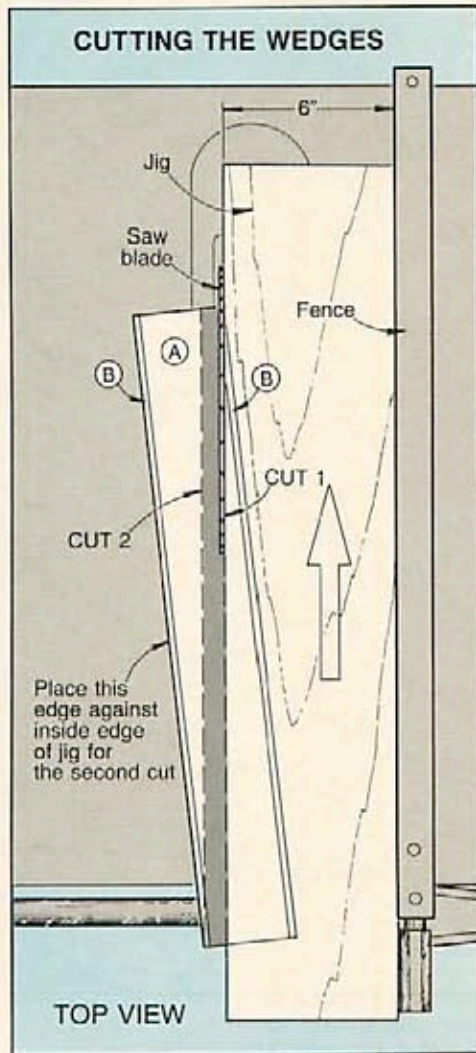
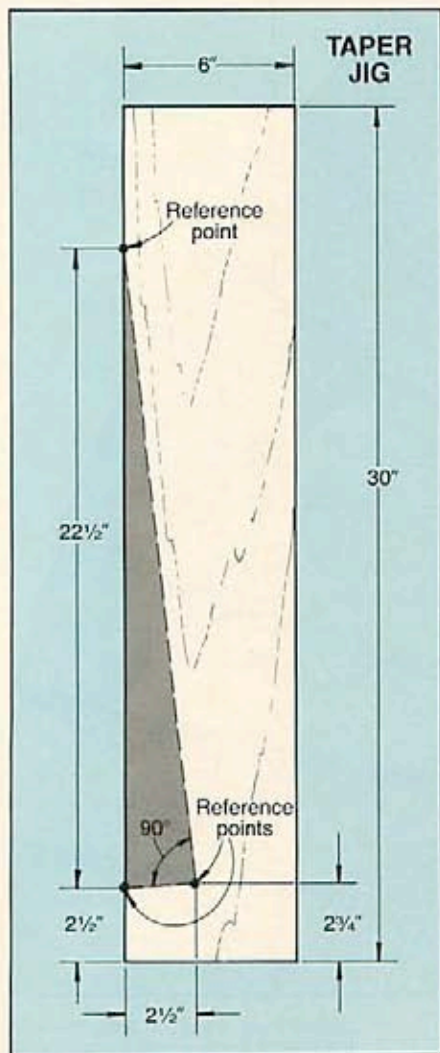

**2** Lay waxed paper on the plywood between the strips. Spread woodworker's glue on the mating edges of the wedges, and position them where shown in the photo *above*. Now, lightly tap the pieces toward the inside corner of the jig, and drive a #6 finish nail into position at the end of each wedge. Check for a flush top surface and tight joints. (We found it necessary to tap a few of the wedges in tighter and renail after initially nailing all the wedges in place.)

**3** Let the glue dry, remove the nails, and scrape the excess glue from the lamination.

### CUT THE TEMPLATE AND CUTTING BOARD TO SHAPE

**1** Measure the interior opening (front to back and side to side) of your sink basin (we measured ours 1" from the top edge). On a piece of cardboard, mark layout lines the exact size of your basin opening.

**2** Mark a radius at three of the corners to connect the layout lines on the cardboard. Leave a square corner where the walnut strips converge; you'll mark and cut it to shape later. (To determine the necessary radius for a tight fit onto the sink basin later, we marked different sized radii on cardboard scraps, and cut them to shape. Next, we trial-fit

*Continued*

# SUNBURST SINK BOARD

each scrap against the rounded inside corner of the sink. Once we found the right radius, it became a template to mark the three radii onto the cardboard template.)

**3** Draw four more lines  $\frac{3}{8}$ " outside and parallel to the first lines drawn

(later these will be the outside edges of the cutting board). Connect the *outside* lines by marking radii  $\frac{3}{8}$ " larger than the ones marked in the previous step (our outside radii measured  $2\frac{5}{8}$ "). Carefully cut the cardboard template to shape.

**4** Mark the location, draw the 1" finger hole circle, and cut the hole in the template to shape.

**5** Position the cardboard template on the sink board lamination and trace its outline and the finger hole location onto the sink board. (You may need to move the finger hole around a bit until it is centered over a piece of maple.)

**6** Position the rip fence on your table saw (we moved ours  $16\frac{1}{2}$ " away from the inside edge of the blade), and trim the board where shown on the drawing below. Next, cut the other two edges square. Fi-

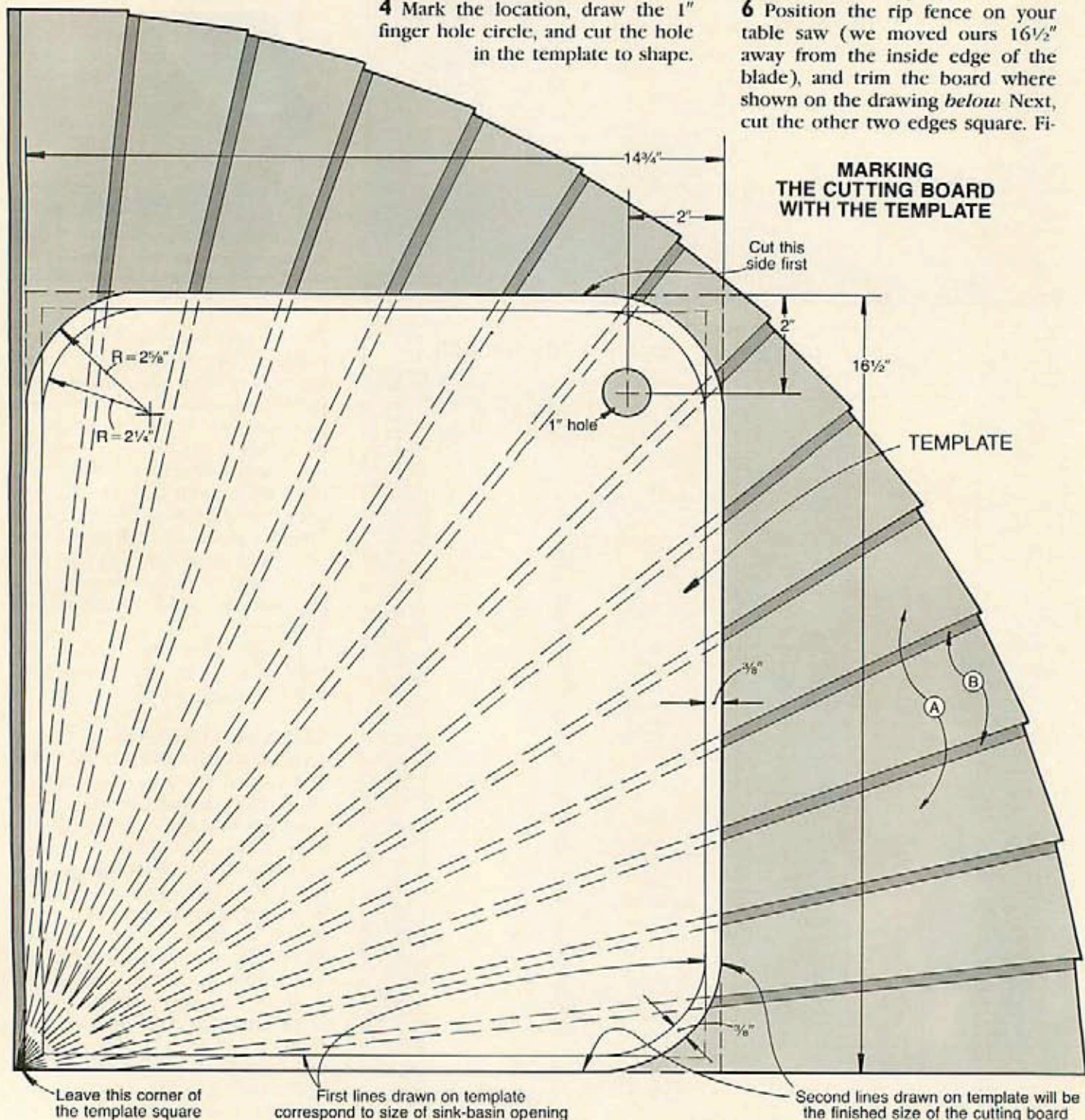

nally, use a band saw to cut the three rounded corners, and then sand them smooth.

**7** Bore a 1" finger hole through the cutting board where marked.

## NOW FOR THE SURFACE SPLINE

**1** Cut a piece of 1 1/16" stock to 8" square for the drilling jig. Mark diagonals to find center.

**2** Mark and cut a 3 3/8"-square notch at one corner of the jig where shown on the drawing at *right*.

**3** Chuck a circle cutter to your drill press, and position the *outside edge* of the cutter blade 3/4" from the center of the pilot bit. Raise the bottom tip of the cutter 1/4" higher than the bottom of the bit. For a cleaner cut, you want the bit to make contact with the jig before the cutter enters the lamination.

**4** Center the jig under the pilot bit, and clamp it to the drill press table. Slide the cutting board into the notched corner, and clamp it to the table. Start the drill, and *slowly* cut into the jig and sink board until you've cut 1/2" deep with the cutter. Remove the cutting board and jig from the drill press table.

**5** Fit your router with a 1/2" straight bit. Clamp the sink board and drilling jig (the jig helps support the router) to a workbench. Starting at the outside edges and working in, rout a 1/2"-deep recess in the corner of the board. Rout just up to the groove you cut with the circle cutter. Now, as shown in the photo at *right*, clean the ridge between the routed area and circle-cutter groove with a 1/2" chisel.

**6** Mark a 3/4" radius on a piece of 1/2" walnut where shown on the drawing at *right*. Cutting just outside the line, band-saw the surface spline (C) to shape. Check the fit of the spline into the routed recess, and sand if necessary.

**7** Glue and clamp the walnut spline into the recess, noting the direction of grain shown on the Exploded-View Drawing. After the glue dries, use the cardboard template to mark the radius on the splined corner, and cut it to shape.

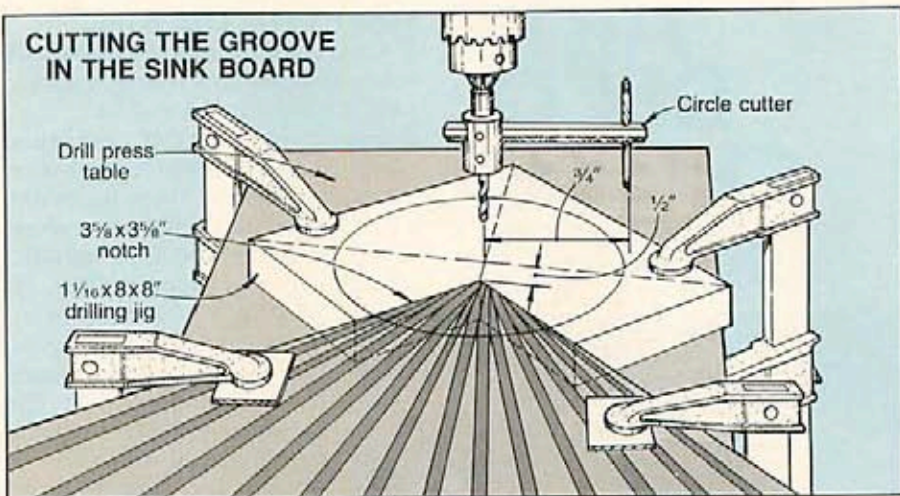

After routing the excess material, clean the surface between the routed area and circle-cutter groove with a sharp chisel.

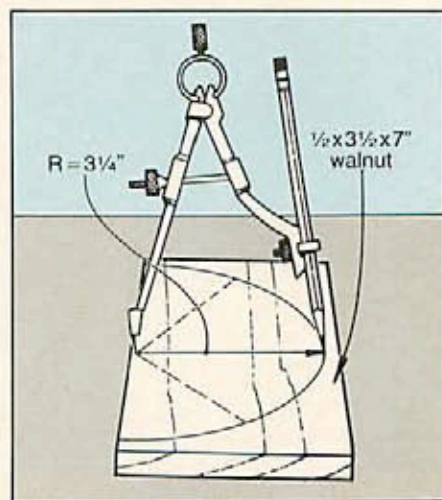

## SANDING, ROUTING, AND FINISHING

**1** Sand the sink board smooth.

**2** Rout a 1/2" cove along the bottom edge of the sink board (see the Cove Detail accompanying the Exploded-View Drawing).

**3** Rout a 1/4" chamfer along the top edge of the sink board and 3/8" chamfers on both edges of the 1" finger hole.

**4** Finish-sand the sink board, and apply the finish (we used Behlen's Salad Bowl Finish). ●

Project Design: Jim Boelling

Photographs: Bob Calmer

Illustrations: Mike Henry, Bill Zaun

# ART-DECO CHEESE BOARD



Our counter-conscious bird's-eye maple cheese board fills the bill for all of us who love to display our handiwork. At your service to handle a quick snack, this Art Deco-style entertainer goes back onto its ebony stand for conspicuous storage.

Project Design: Dave Ashe  
Photograph: Jim Kascoutas  
Illustrations: Kim Downing, Bill Zaun

## START WITH THE BASE

**1** Cut two pieces of  $\frac{3}{4}$ "-thick ebony (walnut also would work) to  $3 \times 6$ " for the base sides (A).

**2** Locate and mark a centerline across each piece where shown on the Exploded-View Drawing. Scribe a  $2\frac{7}{8}$ " radius on each, cut to shape on the band saw, and sand smooth.

**3** Cut the center support (B) to  $\frac{7}{8}$ " wide by  $1\frac{1}{8}$ " long from  $\frac{3}{4}$ " stock. Mark a  $\frac{3}{8}$ " radius on one end (see the drawing for reference). Cut the radius to shape on the band saw, and sand smooth.

**4** Using the dimensions on the drawing, mark the dowel hole center points on the center support. Clamp the support in a handscrew clamp, and drill the holes to size on a drill press.

**5** Using the center support as a guide, center it over the marked centerline on one base side, and drill a pair of  $\frac{3}{8}$ "-deep holes into the base side. (We held the center support in place with double-faced tape when drilling.) Repeat for the other base side.

**6** Cut two pieces of  $\frac{3}{8}$ " dowel to  $1\frac{1}{2}$ " long.

## CUTTING AND LAMINATING THE MAPLE BOARD

**1** Cut three pieces of  $\frac{3}{4}$ "-thick bird's-eye maple to  $3\frac{3}{8} \times 9\frac{1}{4}$ " long for the cutting board (C). Glue and clamp the three pieces together edge to edge.

**2** After the glue dries, scrape off the excess. Crosscut about  $\frac{1}{4}$ " off one end of the lamination to square it with the sides.

**3** Mark the centerline and the radius center point on the board where shown on the drawing. Now, mark a  $4\frac{7}{8}$ " radius on the board.

**4** Center the support (B) over the centerline and flush with the bottom edge of the board. Trace the support's outline onto the maple board. Now, cut the board and the notch to shape.

## ROUTING AND FINAL ASSEMBLY

**1** Rout a  $\frac{1}{4}$ " round-over along the edges (not on the bottoms) of the board and base sides where shown on the drawing. Sand smooth.

**2** Glue, dowel, and clamp the center support between the base sides. Scrape off any excess glue.

**3** Check the fit of the maple board on the base, and sand the notch if required for a good fit.

**4** Apply several coats of Behlen's Salad Bowl Finish or vegetable oil.

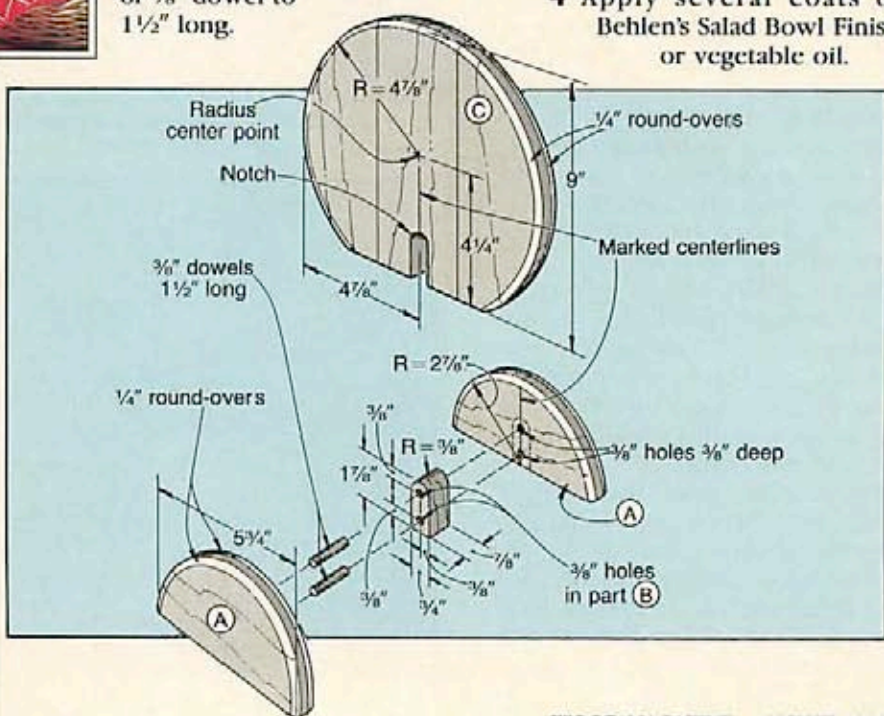



# TEXAS TOAST CUTTING BOARD

## LAMINATING AND SHAPING THE BOARD

**1** Rip and crosscut three pieces of  $1\frac{1}{16}$ "-thick stock (we used Honduras mahogany) to  $3\frac{1}{2} \times 12$ " long. Glue and clamp the pieces together edge to edge, with the edges and ends flush. Later, scrape off the excess glue, and sand the top and bottom surfaces smooth.

**2** Crosscut the ends for an  $11\frac{1}{2}$ " finished length.

**3** Now, using the dimensions on the drawing and a compass, mark the radii. Cut the board to shape on a band saw. Leave a square corner at the bite mark; we'll cut it to shape later. Sand a slight round-over on all edges.

## "TOASTING THE CRUST" AND APPLYING THE FINISHING TOUCHES

**1** To darken the edges of the cutting board, singe them with a small propane torch, being careful not to burn the top and bottom surfaces. Darken the edges to a uniform color. If you don't have a torch, you could stain the edges darker.

**2** Now, cut the bite mark to shape on a band saw.

**3** Sand the top and bottom surfaces of the board smooth again. This will help remove any burn marks or stain that may have seeped to the surface.

**4** Apply the finish (we applied several coats of salad-bowl finish). See the Buying Guide for our source.

## BUYING GUIDE

• **Behlen's Salad Bowl Finish.** One quart, catalog no. BB616, \$12.95 ppd. Constantine's, 2054 Eastchester Rd., Bronx, NY 10461; 800-223-8087, 800-822-1202 in New York. ♣



Bite into the construction of this cutting board tonight, and you'll be ready to serve sandwiches on it tomorrow. It's one great cutting board any way you slice it.

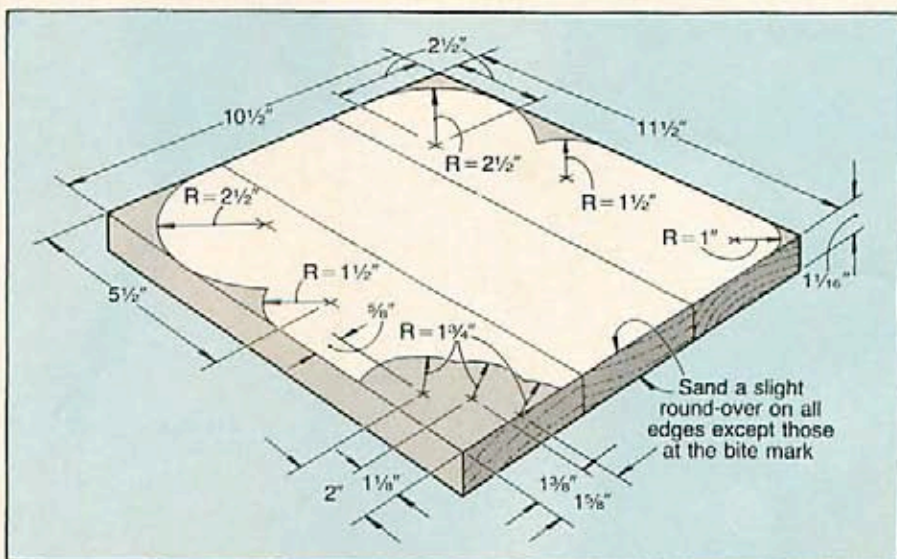

Produced by Marlen Kemmet  
Project Design: Dave Ashe  
Photograph: Jim Kascoutas  
Illustrations: Kim Downing, Bill Zaun

# THE HOLE STORY ABOUT TODAY'S

# DRILL

A drill press rarely captures the limelight in a workshop—it's content to plug away, standing tall while performing workaday tasks. However unassuming, though, a drill press ranks only a step below a power saw in the hierarchy of valued workshop friends.

**A**fter unpacking a mountain of boxes, we stepped back to appraise the drill

presses under \$800 assembled for this article. Our workshop reminded us of a family reunion: We had a roomful of drill presses so similar that, with one exception, they appeared to be cousins.

And in fact, importers agree that just two companies manufacture all the Taiwanese drill presses exported to the United States. Taiwanese workers assemble many of the drill presses we tested—AMT, Delta, Black & Decker, Grizzly, and Orbit by Jet—right in the same factory, Rexon Company. Although Sears stands firm on its policy not to reveal manufacturing sources, their competitors say they've seen Sears machines on the production line, too.

According to Mike Mangan, Sears product manager, American-made machines have priced themselves right out of the market.

"The U.S. lost the market on the drill press," Mangan said, "and will never regain it, from what I hear." The Delta radial drill, manufactured in Tupelo, Mississippi, was the only U.S. product we tested among 10 drill presses.



Grizzly's  
G-1200

# PRESSES

In particular, we noted similarities in the head assembly, elevating track, power cords, switches, and tightening knobs. A couple of the machines even packed identical generic instruction manuals!

But that's where the similarity ends: Engineers from American firms specify how they want their machine built in Taiwan. They may specify American-made motors, Japanese-made sealed bearings, or their own ON/OFF switch. And certainly, engineers specify a production quality level based on price.

## DRILL PRESSES: WHO NEEDS ONE, ANYWAY?

Drill presses continue to be one of the most popular stationary power tools in the home workshop. A recent survey of *WOOD* magazine readers indicates that nearly 60% already own a drill press. An additional 11% of our readers plan to purchase a drill press in the next 12 months.

The woodworker's yearning for a drill press stems from a need to precisely control drilling, often repeatedly drilling hole after hole to a prescribed depth. And although most of us routinely drill 90° to the surface, nearly all of the larger drill presses we tested offer a tilting table to drill angled holes.

But drilling holes represents only a fraction of drill press capabilities. The drill press shines at drum-sanding, mortising, countersinking, and other tasks. (A related story beginning on page 26 outlines numerous ways to expand the use of a drill press.)

## THE IMPORTANCE OF SPINDLE SPEED

We tested drill presses with up to 16 speeds ranging from 150 spindle rpm to 4,700 rpm. From talking to shop experts around the country, we found out that if there's any drill-press shortcoming, it's that too many operators fail to understand or heed recommended spindle speeds.

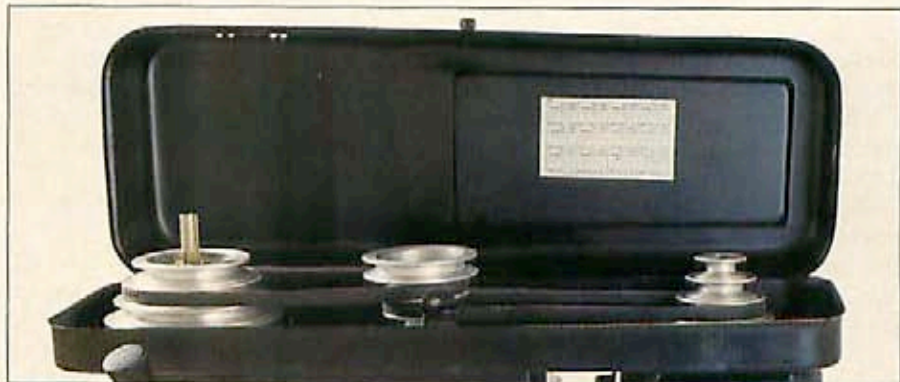

Inside the head, most drill presses look like the Black & Decker, above. Combinations of belt arrangements on the pulleys set different speeds.

In our own *WOOD* magazine shop, we have ruined several expensive large-diameter Forstner bits by running them at too high a speed—it's just too convenient to run the machine on the last-used belt arrangement. And once the bit begins to smoke, you've destroyed the steel temper.

When you flip open the top of larger drill presses, you'll see three step pulleys connected by two V-belts. On the inside of the lid or on the head, a chart tells you how to set up the two belts to attain each desired speed. Most charts won't tell you, for example, how fast to run a 1½" Forstner bit in maple. (You'll want to see page 6 for details on how to order *WOOD* magazine's drill speed chart.)

So for drill presses, it's the range of spindle speeds and the horsepower that you must carefully consider. We did detect differences between the ½- and ¾-horsepower motors when running larger bits and circle cutters. Sadly, at least one importer has proof that some companies slap ¾-horsepower labels on ½-horsepower motors.

## CHOOSING BETWEEN FLOOR AND BENCHTOP MODELS

Before getting too involved in a drill press purchase, you'll have to choose between a tabletop and floor model. But only you can match a drill press with your pocketbook and space requirements.

etbook and space requirements.

The benchtop press will continue to be popular in small workshops where space dictates limitations. Some woodworkers lug their drill press to a workbench and bolt it down whenever the need arises. The smaller, lightweight Black & Decker and Sears benchtop models fit this application.

The sturdy AMT and Orbit benchtop machines we tested weigh too much for one person to place either machine on a bench. You should mount both of these machines—full-size drill presses with a short column—to a bench or table.

However, most woodworkers rarely move their drill press table lower than 7" to 9" below the chuck—the range of benchtop models. We put a new drill press in our shop three years ago and still haven't cranked the table lower than 8". And if, for example, you had to bore a hole into the end of a table leg with your benchtop press, you should be able to swing the head around and drill off the floor.

Unfortunately, for woodworkers without floor space, benchtop presses do eat up a lot of precious workspace. But if you can spare floor space and an extra \$40-\$100, consider purchasing a floor drill press. You can forget lugging a drill press onto a table or spending the time and money to make a separate table for a benchtop unit.

*Continued*

## DRILL PRESSES

### THE SPINDLE—THE HEART OF THE MACHINE

Quill travel describes the depth of a hole you can drill without changing the table elevation. Most of the Taiwanese models we tested have a 3¼ to 3½" quill travel. Three exceptions—the Grizzly G-1201, the Black & Decker 1782, and the Orbit 1758—have even longer reaches.

We believe a drill press should be free of runout—the condition when the circular drilling motion becomes eccentric. Because three-jaw chucks don't necessarily clamp the bit exactly on center each time, we reinstalled the bit at least twice more to check for runout. The presses passed our test with no signs of appreciable runout, although the big Grizzly and the Black & Decker drilled with less vibration.

But remember we tested new machines. Will you experience runout in a few years? It's only a guess. We can't attest to the quality of the sealed ball bearings in the spindle assembly, shown *below*, but we can tell you only Delta's radial drill has durable, expensive thrust bearings.

Engineers designed these machines to press vertically. If you apply a lot of sideways pressure, such as routing (not advised with a drill press) or drum-sanding, you could damage the ball bearings. Only the big Grizzly, as shown in the photo

*bottom right*, and the Delta radial have a bolt to eliminate play between the quill and the head.

All of the floor models have three-jaw ½" chucks, many of them made in the Rexion plant. Orbit, not satisfied with Taiwanese quality, ships their machines with German-made Rohm chucks.

### DEPTH CONTROL CHOICES OFFER ADVANTAGES

Most of the machines we tested have a dial-stop system to lock in the desired depth of the hole. To establish a drilling depth, "zero" the dial, lower the drill bit to the desired level, and lock in the depth.

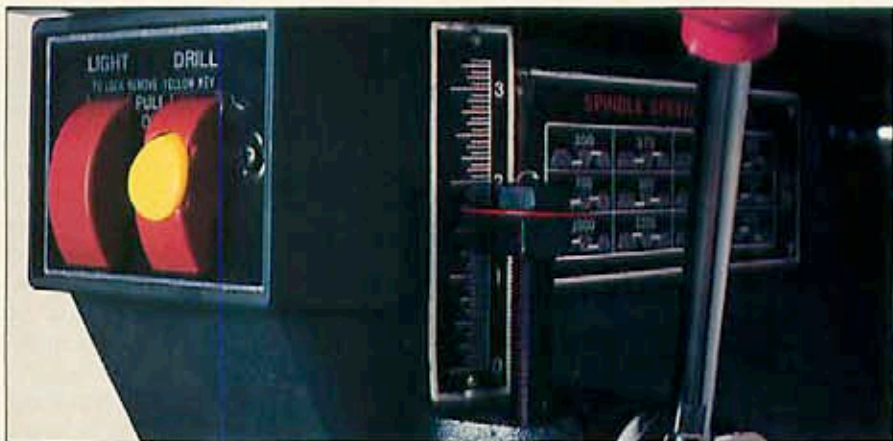

A threaded rod depth stop, shown above on the Sears 21385, takes longer to set than the dial systems, but the threaded rod ensures more accurate repetitive drilling.

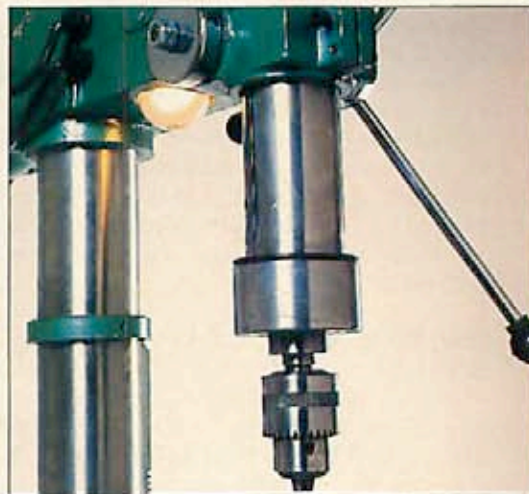
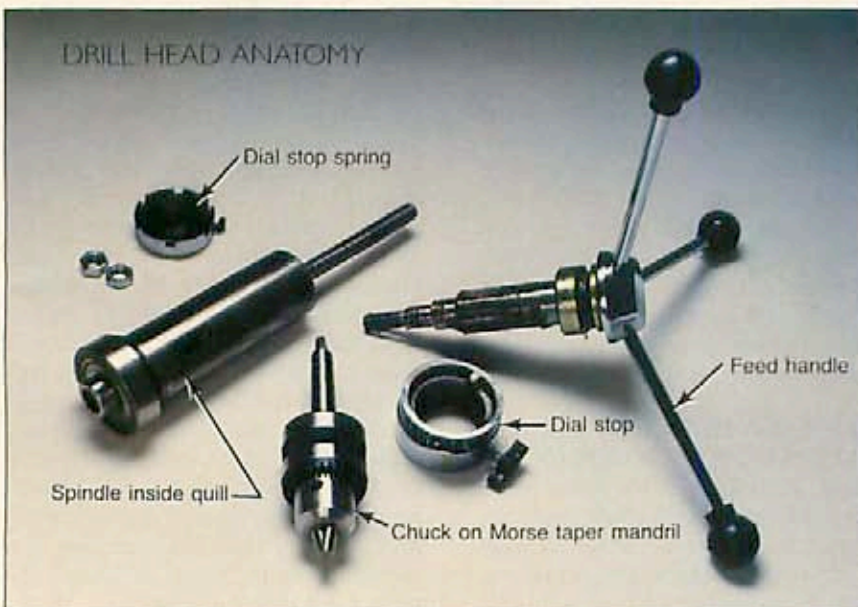

The 5¼" quill travel on the Grizzly G-1201 outdistanced all the others we tested. By adjusting the allen bolt, *top center*, the operator can eliminate spindle play between the quill and the head.

## WHATEVER HAPPENED TO THROAT DEPTH?

If you haven't followed drill press marketing in the past few years, you may be surprised that most manufacturers no longer speak of throats to express the maximum depth between the column and the drill-bit

center. In today's advertising world, the same drill press that once had 7" throat now has a 14" swing—the maximum diameter of a circle you could spin around without hitting the column. That's advertising!

## TABLE MATTERS

We expected all the tables to tilt, but were surprised to find Black & Decker's 1782 table fixed at 90°, as shown in the photo *below*.

The Black & Decker table has another deficiency. Although all of the other floor drill presses we tested have a cranking device to raise and lower the table, you must push the Black & Decker table by hand.

We think a floor-model drill press needs to have a rack-and-pinion table to lessen the chance of injury and to fine-adjust the table height. Without a cranking mechanism, a 25-pound table can easily accidentally drop and crush fingers.

Michael Austin, product manager for Black & Decker, confirms that his firm uses original Toolcraft castings formerly produced in another Taiwanese plant. "We are looking to make improvements in our drill press," Austin says. "We have recognized the faults and there will be improvements in a redesigned, up-

graded unit we plan to introduce early in 1989. We think it will be a super unit and it will be sold under the DeWalt label."

Only the Sears table has the tilting scale on the same side as the tightening handle as shown in the photo *below*. On the negative side, note in the photo *below* how the front of the Sears table hits the column when swung around.

Most of the drill presses we tested have a forgiving hole in the center if you accidentally pilot too deep. However, Orbit ships their 1458F drill press with a milling table seen primarily in metal shops. Because milling tables must retain coolant to bathe metal, they lack a center hole—and thereby a forgiving margin of error if you drill too deep.

## FINAL OBSERVATIONS

We'd like to see better depth-stop knobs and belt-tension lock handles. The locking bolts with plastic knobs work fine until the plastic

breaks off—only a carriage bolt remains. In the photo *below*, compare the plastic knob to the Sears and benchtop Black & Decker knob with a pinned flipper lever.

Most of the engineers curiously specify the ON/OFF switch on the side of the drill press. Sears and Delta put their switch in front where you can get to it quickly. They also incorporate a plastic safety key to prevent curious hands from turning on the machine.

And finally, the bottom line: cost. In our tests, the lower-priced machines held their own against machines that retail for twice as much. Think long and hard before you spend \$400 on a drill press that performs like a \$200 model.

But don't overlook quality and a dealer network. Dean Ruffner, a Jet product manager, minces few words about today's competitive market. Of the drill presses on the market, Ruffner says, "I'm seeing a downhill run on quality to become competitive. The first way a company cuts cost is in the service department. Then you can cut costs by accepting lower-quality motors and chucks. We once had a 10 percent return on motors until we upgraded about eight years ago. The average consumer won't notice some differences, but Taiwan will build any quality level you want."

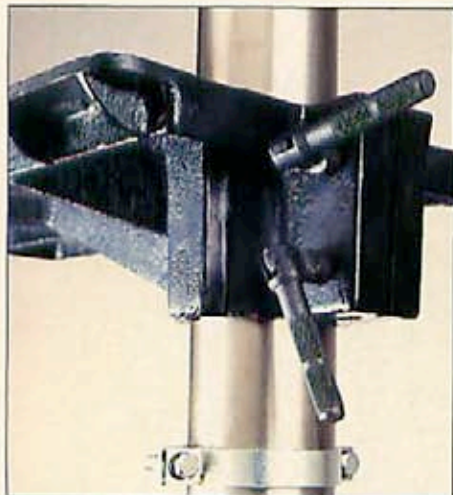

Black & Decker's table lacks a rack-and-pinion cranking mechanism found standard on other floor-model machines we tested. In addition, we missed the ability to tilt the work surface.

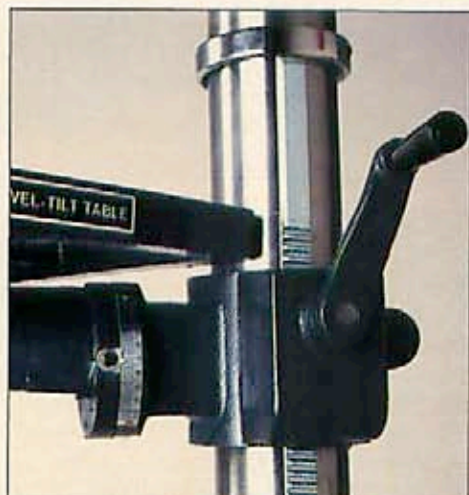

Unlike other floor models, Sears places its tilting guide conveniently near the handle used to raise and lower the table. However, the squared front edge of the Sears table hits the column.



Most of the machines have plastic locking knobs, *left*, to tighten depth stops and belts. The flipper lever used on some Sears and Black & Decker machines, *right*, should give more service.

# DRILL PRESSES

## DRILL PRESSES UNDER \$800: TALE OF THE TAPE

MANUFACTURER	MODEL	SPEEDS			SPINDLE		MOTOR			TABLE				RACK AND PINION	TABLE TRAVEL <sup>5</sup> (INCHES)	WORK LIGHT	HEIGHT (INCHES)	WEIGHT (POUNDS)	WARRANTY	SUGGESTED RETAIL PRICE <sup>7</sup>
		NUMBER	LOW	HIGH	QUILL TRAVEL (INCHES)	DEPTH STOP <sup>1</sup>	CHUCK CAPACITY (INCHES)	HORSEPOWER	RPM	LOCKING SYSTEM <sup>2</sup>	SWING (INCHES)	TILT								
BENCHTOP MODELS	AMT	4590	12	250	3100	3/4	D	5/8	3/4	1725	H	12 1/2	Y	Y	8	Y	32	102	10 yrs.	\$185
	Black & Decker	9400	5	620	3100	2	TR	1/2	1/2	1720	H	8	Y	N	7	N	23 3/4	45	2 yrs.	\$202
	Delta	11-950	5	620	3100	2	TR	1/2	1/4	1720	H	8	Y	N	7	N	23 3/4	45	2 yrs.	\$160
	Delta	11-072	4	700	4700	3 1/4	TR	1/2	1/2	1725	NA <sup>3</sup>	32	NA <sup>3</sup>	N	10 3/4	N	36	126	2 yrs.	\$450 <sup>6</sup>
	Orbit	OR-1758	16	260	3650	4 1/4	D	5/8	1/2	1725	D	17	Y	Y	14 1/4	Y	42	179	90 days	\$319
	Sears	21372	3	700	3000	2 1/2	TR	3/4	1/4	1725	H	8	Y	N	5	N	23 1/2	39	1 yr.	\$114.99
	Sears	21383	4	480	3000	2 1/2	TR	1/2	1/4	1725	D	10	Y	Y	7 3/4	N	32	79	1 yr.	\$199.99
FLOOR MODELS	AMT	4560	12	250	3100	3/4	D	5/8	3/4	1725	H	12 1/2	Y	Y	25 3/4	Y	63	125	10 yrs.	\$231
	Black & Decker	1782	12	250	3000	3 1/2	D	5/8	1/2	1725	D	16 1/2	N	N	25 3/4	N	66	190	1 yr.	\$404
	Delta	17-900	12	250	3000	3 1/2	D	5/8	3/4	1720	D	16 1/2	Y	Y	25 3/8	N	66	180	2 yrs.	\$399
	General	34-01	6	460	4910	4 1/2	TR	1/2	1	1725	D	15	Y	0 <sup>4</sup>	39 1/2	0 <sup>4</sup>	66 1/2	185	1 yr.	\$786.91
	Grizzly	G-1201	9	150	2470	5 1/4	D	5/8	3/4	1720	D	18	Y	Y	21 1/4	Y	68	340	1 yr.	\$395
	Grizzly	G-1200	12	250	3100	3 1/4	D	5/8	1/2	1720	D	14	Y	Y	27 1/2	Y	66	210	1 yr.	\$225
	Orbit	OR-1458F	16	260	3650	3 1/4	D	5/8	3/4	1725	D	14	Y	Y	25	Y	66	212	90 days	\$369
	Orbit	OR-1758F	16	260	3650	4 1/4	D	5/8	3/4	1725	D	17	Y	Y	29 1/2	Y	66	216	90 days	\$395
	Sears	21385	12	300	4600	3 3/8	TR	5/8	1/2	3450	D	15	Y	Y	24 1/2	Y	66	167	1 yr.	\$429.99
	Sears	21384	5	400	2800	3 3/8	TR	1/2	1/4	1725	H	13	Y	Y	26 1/2	N	66 1/2	152	1 yr.	\$279.99

- (D) Dial (TR) Threaded rod
- (S) Single knob  
(D) Dual knob

- (N/A) Head tilts, swivels, and moves in and out; table doesn't tilt
- Optional

- Maximum distance table lowers from bottom of chuck

- Includes stand, but no motor
- Prices may be discounted 10-30%

### MANUFACTURERS LIST: DRILL PRESSES

American Machine & Tool Co.  
Fourth Avenue and Spring Street  
Royersford, PA 19468  
215/948-3800

Black & Decker Inc.  
Call 800-235-0870  
for nearest dealer

Delta International  
Machinery Corp.  
246 Alpha Drive  
Pittsburgh, PA 15238  
800-438-2466

General by J. Phillip Humfrey  
3241 Kennedy Rd #7  
Scarborough, Ontario M1V2J9  
800-387-9789

Grizzly Imports  
P.O. Box 2069  
Bellingham, WA 98227  
206/647-0801

Orbit by Jet Equipment & Tools  
1901 Jefferson Ave.  
P.O. Box 1477  
Tacoma, WA 98402  
800-426-8402

Sears, Roebuck & Co.  
Contact local store for  
latest tool catalog

### MORTISING SHORTCUT

For the woodworker who occasionally relies on a mortise-and-tenon joint, a mortising attachment for a drill press answers the call.

Complete mortise attachments cut from 1/4" to 3/4" mortises and start at about \$30—considerably less expensive than purchasing a plunge router and much faster than chiseling by hand. The setup requires attention to detail, but a

slow feed rate minimizes deflection of a specialized bit surrounded by a box-cutting chisel.

You should only consider mortising attachments with replacement bits. As with the AMT attachment we tested, *right*, most attachments include hold-downs absolutely essential to accurate work. Mortise the ends first and then connect the two holes with successive holes.

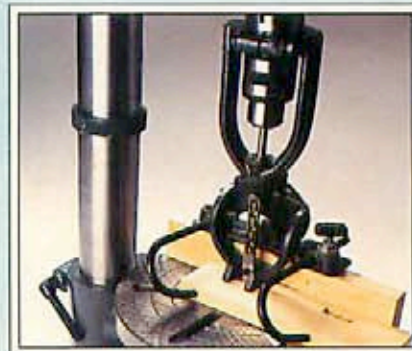

## BENCHTOP MODELS



## FLOOR MODELS

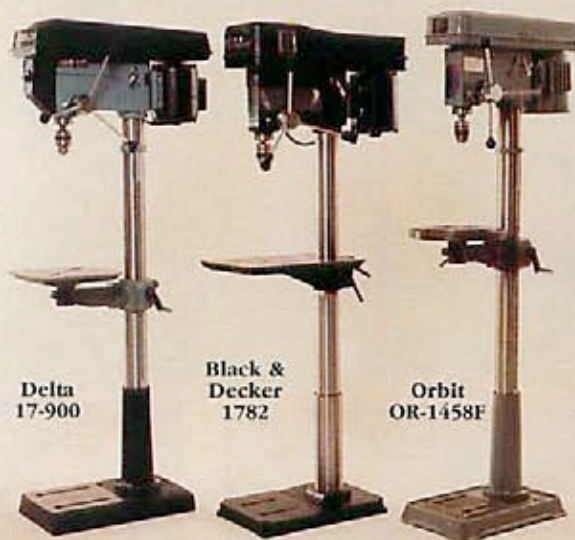

## DELTA'S DISTINCTIVE RADIAL PRESS



Perhaps Delta should rename their 32" radial press a "radical press"—there's nothing like this machine on the market for under \$5,000. It's the only machine we tested that we could tilt the head, which greatly simplifies drilling holes at an angle on long stock. Woodworkers also love the 32" swing—created by the head that slides in and out on the column. For these features, woodworkers pay a premium price for this benchtop machine.

This threaded-rod stop adjusts quickly. In addition, it's easy to turn the head 90° and disc-sand or polish in a convenient position.

Unfortunately, the radial's slowest speed—700 rpm—runs faster than the recommended speed for circle cutters and most Forstner bits in hardwood. And, we miss a table with a cranking mechanism. 🌲

Written by Carl Voss  
Technical Consultant: George Granseth  
Photographs: Jim Kascoutas

# TRIPLE-CROWN SAWHORSE

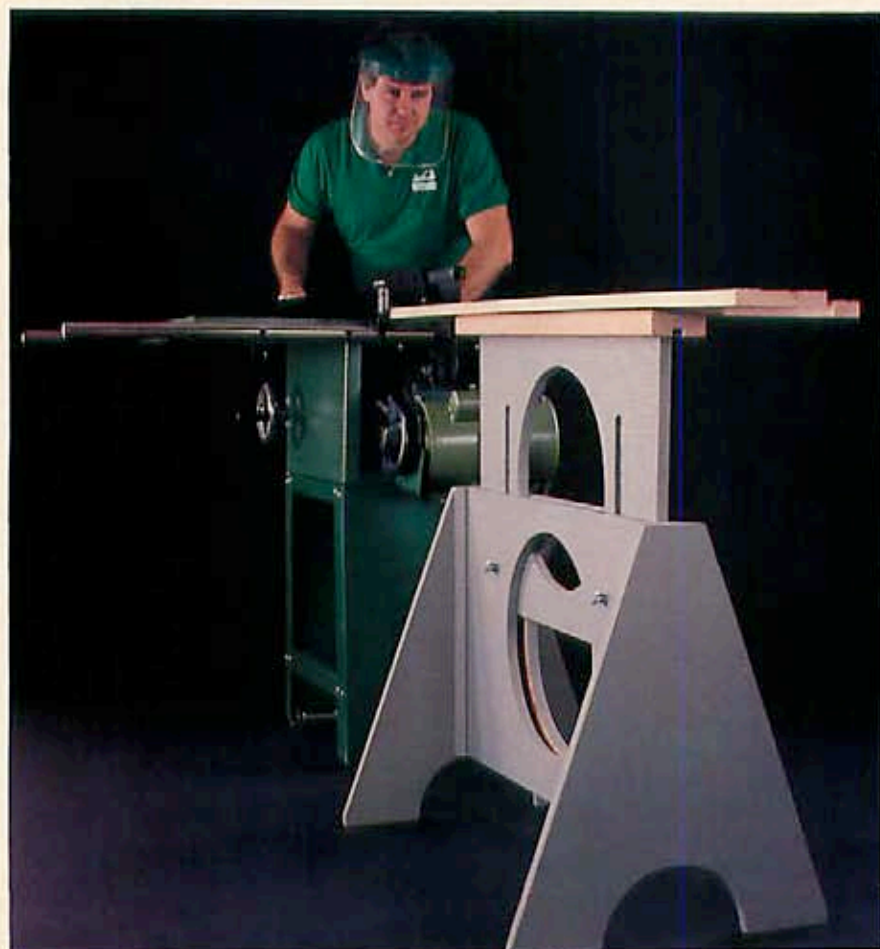

This handy-to-have-around sawhorse literally rises to the occasion. Build one for use as a ripping support, or build a pair and raise projects to back-pleasing heights.

## FORM THE END SUPPORTS

**1** Cut two pieces of  $\frac{3}{4}$ " plywood (we used A-C fir plywood) to  $20 \times 22\frac{3}{4}$ " for the end supports (A).

**2** Cut two pieces of  $\frac{3}{4}$ " maple to  $\frac{3}{4}$ " wide by 20" long for the banding (B). Glue one piece to the bottom of each end support.

**3** Using the dimensions on the Exploded-View Drawing, mark a centerline the length of one end support. Measuring from the centerline, lay out and cut the angled sides on one end support. Use this support as a template to mark the shape onto the second end support, and cut it to shape.

**4** From the center point at the bottom, mark a 4" radius. Cut the arc to shape, and again use this support as a template to mark the arc onto the second support. Cut it to shape, and sand both arcs smooth.

## ATTACH THE CENTER PANELS TO THE END SUPPORTS

**1** Cut the spacers (C) to size. Center the spacers on each end support, and glue and screw them into place, using the hole sizes in the Screw Hole Detail.

**2** Cut the two center panels (D) to size. Locate and mark the center of one panel, and mark a 1-4"-diameter circle. Drill a blade start hole, cut the circle to shape with a jigsaw, and sand smooth. (The circle cutting helps reduce the total weight of the sawhorse.) Trace the circle outline onto the second panel, and cut that circle to shape.

**3** On one center panel, mark the locations for the two  $\frac{3}{8}$ " holes, referring to the drawing for dimensions. Clamp the two panels together with the edges flush, and drill  $\frac{3}{8}$ "

## Bill of Materials

Part	Finished Size*			Material	Qty.
	T	W	L		
A*	$\frac{3}{4}$ "	20"	$22\frac{3}{4}$ "	plywood	2
B*	$\frac{3}{4}$ "	$\frac{3}{4}$ "	6"	maple	4
C	$\frac{3}{4}$ "	$1\frac{1}{16}$ "	$19\frac{1}{2}$ "	maple	2
D	$\frac{3}{4}$ "	$19\frac{1}{2}$ "	$30\frac{1}{2}$ "	plywood	2
E	$\frac{3}{4}$ "	$\frac{3}{4}$ "	$19\frac{1}{2}$ "	maple	4
F*	$\frac{3}{4}$ "	19"	29"	plywood	1
G	$1\frac{1}{2}$ "	$3\frac{1}{2}$ "	34"	pine or fir	1
H*	$\frac{3}{4}$ "	$1\frac{1}{4}$ "	3"	maple	1

\*Parts marked with an \* are cut larger initially, and then trimmed to finished size. Please read the instructions before cutting.

Supplies: #8x1 $\frac{1}{4}$ " flathead woodscrews, 1—#8x1 $\frac{1}{4}$ " roundhead wood screw, 2— $\frac{3}{8}$ x3" carriage bolts with flat washers and wing nuts, primer, paint.

## WING NUT WRENCH (H)

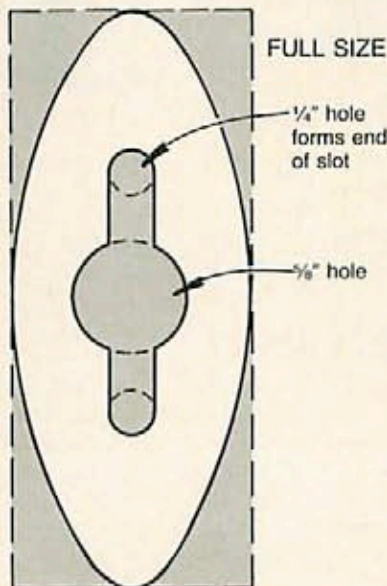



## STURDY, ADJUSTABLE, AND ATTRACTIVE

holes through both panels where marked. Remove the clamps.

**4** Cut the four maple corner braces (E) to size, bevel-ripping a chamfer along one edge of each.

**5** With the top edges flush, glue and screw one center panel (D) to a spacer (C) on each end support (A). See the Screw Hole Detail for hole sizes. Repeat for the second panel. Now, glue and screw the corner braces (E) into position.

### ADD THE ADJUSTABLE CENTER SUPPORT

**1** Cut the adjustable support (F) to 19x29". Mark and cut a taper on each end of the piece (see the Exploded-View Drawing for dimensions).

**2** Cut the top beam (G) to size (we cut ours from a 2x4). Rout a 1/4" round-over along the top edges. Cut or rout a 3/4" groove 3/4" deep down the center of the beam. Center and glue the beam to the top of the adjustable support.

**3** Slide the adjustable support between the center panels. Using the two previously drilled 3/8" holes in the panels as guides, drill just far enough into the adjustable support to make a mark.

**4** Remove the support, and drill a pair of 3/4" holes through the support where marked with the 3/8" bit. Now, as shown in the photo below, mark parallel lines on each side of each 3/4" hole to the bottom of the support. Center and bore a 3/4" hole between the lines 2" from the bottom of the support where shown on the Exploded-View Drawing.



Mark lines on the adjustable support, perpendicular to the beam, on each side of the holes.

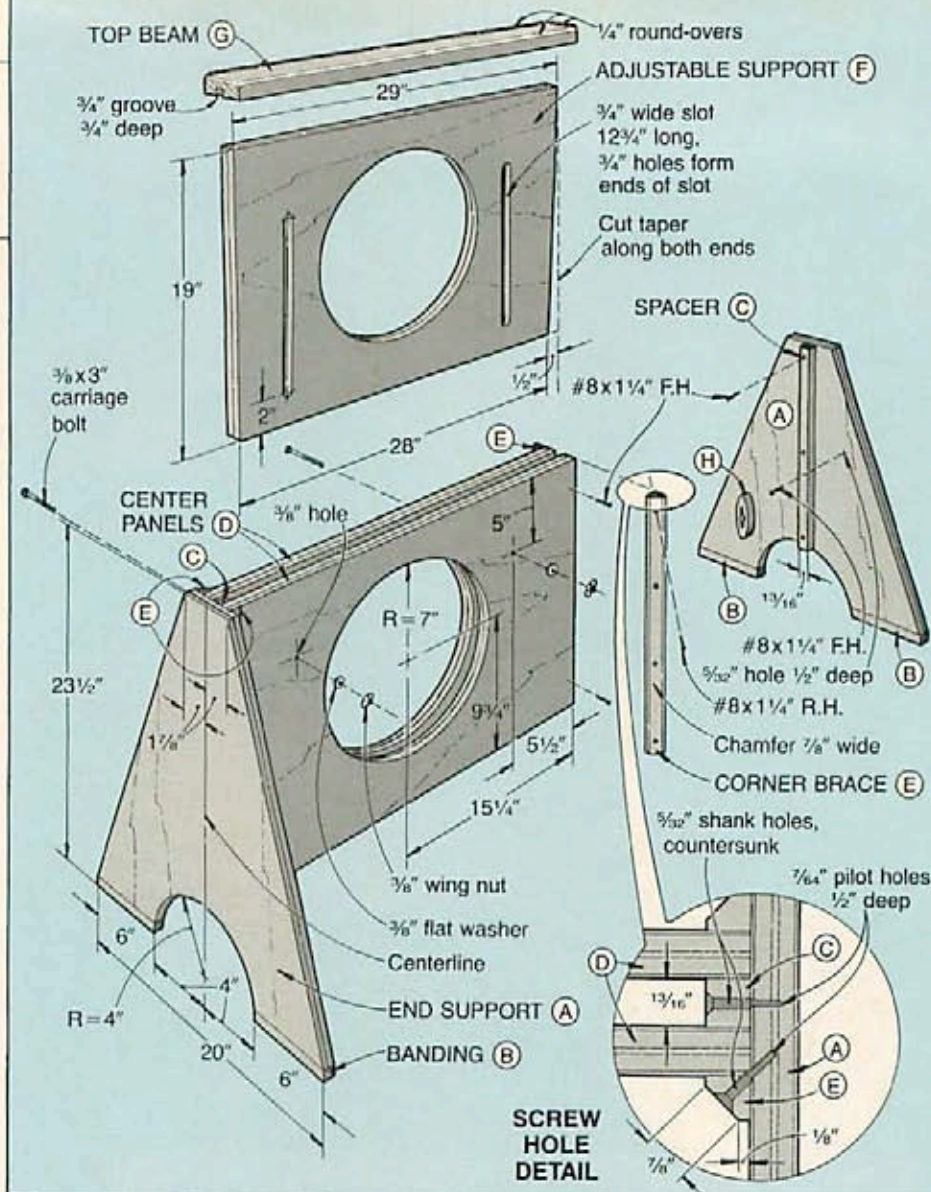

**5** Using a jigsaw, saw along the marked lines from hole to hole to form the slots where shown on the Exploded-View Drawing.

**6** Slide the support between the center panels until the top beam rests on top of the center panel, and trace the 14"-diameter circle onto the support. Remove the support, and cut the hole to shape.

### MAKE THE WRENCH AND ADD THE CARRIAGE BOLTS

**1** To make the wrench (H) for ease in loosening and tightening the wing nuts, cut a piece of 3/4" maple to 1 1/2 x 3". Using tracing paper, transfer the wrench pattern onto the stock. Drill the holes where shown, and cut the wrench interior and exterior to shape.

**2** Sand the parts smooth, and prime and paint as desired.

**3** Position the adjustable support between the center panels. Install the carriage bolts through the holes. Slide a flat washer through each hole, and then thread on the wing nuts. Drill a 3/32" pilot hole 1/2" deep, and add a #8x1 1/4" wood screw to hang the wrench.

**4** Raise the adjustable support to the desired height, and use the wrench to tighten the wing nuts.

If you have an uneven shop floor, the tapered sides on the adjustable support allow the support to be tilted and positioned level. 🍛

Project Design: Jim Boelling,  
James R. Downing  
Photographs: Bob Calmer  
Illustrations: Kim Downing, Bill Zaun



# KEEP

Wood splinters and

Whatever excuse you might have for not wearing eye protection in the shop, it won't hold up. Today's standard lineup of safety glasses presents dozens of style and comfort options to fit all budgets. However, when it comes to a standard of protection, there's only one.

## 'REAL' SAFETY GLASSES HAVE A PEDIGREE

"Real" safety glasses *must* meet ANSI Z87.1-1979 ("Z87" for short), the performance standard for protective eyewear set by the American National Standards Institute (ANSI). ANSI, a voluntary organization, coordinates the development of standards used in business, industry, government, and educational institutions. It wrote the Z87 standard for the workplace. But, your home workshop differs only in size, not in the number of possible hazards you risk.

Most safety glasses or goggles manufactured after 1979 that meet Z87 will have that fact right on

**D**on't have illusions about protecting your eyes. According to the National Society to Prevent Blindness, hospital emergency rooms annually treat at least 35,000 people for eye injuries received in the home workshop! Jim Boelling, *above*, our Project Builder at WOOD® magazine, once nearly counted himself among the statistics.

*"I was working for the local school district in their furniture factory," Jim recalls. "The union required us to wear both eye and ear protection. So, I was wearing my safety glasses one afternoon when I started up the big, straight-line saw to rip 2x2" table legs from rough, 8/4 oak. As I turned to feed more board into the blade, it happened. WHAM! My glasses exploded off my face and dropped. I heard tinkles like a handful of buckshot on a tin roof as carbide flew everywhere. A chunk of barbed wire buried in the wood had fractured 14 of the 28 carbide teeth on that saw!" he exclaims. "One tiny piece of carbide had hit the edge of the lens, chipping it. My optometrist said the carbide would have penetrated my eye socket and probably killed me if I hadn't worn my safety glasses. To this day, I can't help viewing thick boards with suspicion—through safety glasses!"*

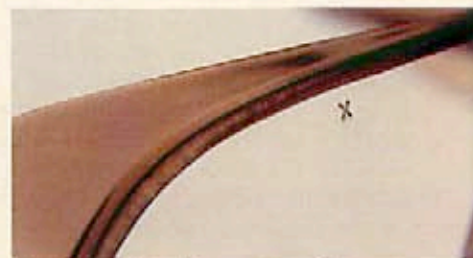

Genuine safety glasses carry the manufacturer's monogram on the lenses.



Frames that meet the Z87 standard usually carry this marking.

# SAFETY IN SIGHT

metal fragments strike fast. Safety glasses will protect you.

them. Look at the lenses (usually in the top center or outside edges at top and bottom). As shown in the top photo, *below left*, each lens displays the manufacturer's monogram or trademark—such as *TO* for Titmus®, *AO* for American Optical, *X* for UVEX, *VC* for Pearle Vision Center. Inspect the frame on the front and temple or ear pieces and you'll see a *Z87*, bottom photo, *below left*. Older glasses may only carry the lens marking.

Although these markings generally hold true in indicating compliance with Z87, a few very contemporary, wraparound styles, though completely safe, carry no marking at all. Kathy Peterson, a spokesperson for American Optical, maker of the "Saf Scanner," a one-piece molded model of safety eyewear, explains: "ANSI sets the minimum performance standard for designs of glasses with a frame and two lenses. Our Saf Scanners are of one-piece construction. They meet or exceed ANSI Z87. But, because of the design, we cannot imprint the designation on them."

## LENSES AND FRAMES: PARTNERS IN SAFETY

Both the frame and the lenses of safety glasses work together for the utmost protection. If only one partner meets the standard, the pair won't protect you.

For instance, the lens might not shatter under an impact. The impact, though, could drive the lens *out of a regular frame and into your eye!* Lenses in plastic safety frames must be mounted from the front with a strong retention lip to prevent them from projecting back into the eye. Metal frames use an equally effective lens insertion.

**Warning:** Don't confuse "impact resistant" lenses with industrial quality safety glasses. Regular pre-

scription (Rx) glasses are, by law, required to be impact resistant. However, safety glasses must withstand nearly four times the impact (in foot-pounds of pressure) of regular prescription glasses.

Frames for regular glasses have no strength or impact requirements to protect you. But safety frames, like safety lenses, must tolerate pressure and impact from the front and sides. Metal frames, for example, must show no cracks or solder breaks after being bent in half until the lenses touch, and then straightened.

## YOUR OPTIONS IN SAFETY EYEWEAR

Top-notch eye protection should be your only consideration when it comes to selecting eyewear. The chart, *next page*, details the minimum eyewear protection you need for different types of woodworking processes and hazards.

Your eyesight, however, partially determines your style options. For instance, if you don't require corrective lenses, you can choose (1) goggles, (2) prefabricated safety eyewear (*prefabs*) with noncorrective clear (*plano*) safety lenses already in place, or (3) safety frames in which plano safety lenses are inserted.

If you need corrective lenses, you can (1) wear goggles or prefabs designed to be worn over your regular glasses, or (2) order prescription safety glasses made.

Contact lens wearers can (1) wear their contacts protected by goggles, prefabs, or safety glasses with plano lenses, or (2) remove contacts and wear prescription safety glasses instead. Note: Contact lenses — either hard or soft — *do not* protect your eyes. Never wear them in shop situations without adequate safety eyewear.

## THE COST OF QUALITY PROTECTION

Surprisingly, protection at the Z87 level starts at \$1.89, and may go as high as \$100. Generally, at the lower end of the scale you're trading off some optical clarity in the lenses and custom fit. On the high end, you'll get glasses you can wear in the shop and out to dinner, too.

Prefabricated plano safety eyewear, either as glasses or in a wrap-around style, comes ready to wear with plano lenses in place for \$4 to \$25. Prefabs offer many choices in style: (1) regular spectacle look-alikes with side shields that may or may not be removable, (2) ones that wrap around your face, giving you wider peripheral vision, and (3) glasses in which the shields are an integral part of a plastic frame.

You can wear some prefabs over prescription glasses. Others have adjustable temples or come in more than one size. When you purchase prefabs from an eyewear specialist, the specialist usually can make some adjustments for a better fit.

In general, you'll pay more for "prefabs" that have frames and lenses of the same quality as regular glasses. The quality of the optics usually ascends with the price, although some pairs for \$5 still have good optics.

Prescription safety glasses give you a custom fit, usually the clearest look at your work, and, if you choose, a pair of glasses you could wear all the time (with side shields removed). Prices for most safety frames fitted with single vision prescription safety lenses range from \$30 for a not-so-stylish pair to \$60 for plastic-framed glasses (bifocals and trifocals cost more) that look as handsome as any fashion pair. Some plastic-framed and metal-framed pairs soar to the \$100 level.

*Continued*

# KEEP SAFETY IN SIGHT

A few safety glasses have permanently attached side shields; some have no shields. Most safety glasses, though, can be fitted with side shields. Side shields provide you with 20 to 25 percent more protection than safety glasses alone, according to Dr. Joseph E. Novak, a University of Pennsylvania clinical professor of ophthalmology and eye-safety consultant to U.S. Steel. And, shields add only \$1 to \$5 to the price. The bottom line: Buy shields and wear them.

## GOGGLE-EYED OVER SAFETY

Fitting closely to your face, goggles give you the best impact protection from every angle. They're the safe choice when you work with chemicals, such as strippers (see chart for special chemical goggles). Many goggles with an adjustable elastic band fit easily over regular glasses. Neoprene head straps may be used with chemical goggles.

And yes, some goggles even prove comfortable worn over prescription glasses. But at only \$2 to about \$10, goggles won't be the highest quality optical product. What you see may be a little fuzzy. "Seeing with a slight distortion through goggles won't harm your eyes. Instead, it will save them," reminds Dr. Novak. We found, by the way, that goggle optical quality does vary greatly between brands and price ranges.

## SAFETY LENSES—A TOUGH MATCH FOR STEEL WOOL

Both plastic and glass lenses can meet the Z87 standard. However, plastic—specifically polycarbonate plastic—receives the highest recommendation from a safety standpoint from a majority of manufacturers. Polycarbonate tops glass and CR-39®, another high-quality plastic, for impact resistance.

You'll find that plastic lenses have greater impact resistance than glass. They're also lighter. And although plastic lenses do pit and scratch easier than their glass equivalent, this won't reduce their impact resistance as with glass.

You should always ask for "scratch-resistant" lenses. Scratch resistance, like safety lenses, has come a long way. For example, in Titmus® test comparisons, their scratch-resistant lenses are eight times more resistant to scratching from a pencil than uncoated lenses. At Pearle Laboratories, the scratch-resistant lenses test 15 times more resistant than untreated ones when rubbed with 0000 steel wool!

## HOW TO DEAL WITH MULTIPLE DISTANCES

If you want to see to saw safely, you may need bi- or trifocals. If your regular glasses, for instance, magnify so you can see clearly close up, but your vision gets fuzzy when you work at the table saw, you can get one pair of safety glasses made to cover both distances. Consult an ophthalmologist or optometrist about your specific distance problem. He or she can write a prescription that will correct for two or three distances.

Another option: If you almost exclusively do one type of woodworking at a single distance—such as lathe turning—you can get single-vision safety glasses or bifocals corrected to a specific distance(s).

Your prescription for correction won't specify safety glasses. That's up to you to request. Simply order frames and lenses that meet ANSI Z87. When your glasses arrive, inspect them for the manufacturer's monogram on the lenses and the Z87 imprinted on the frames.

*Note: You won't always find safety glasses on display because they rarely account for a large percentage of sales. Ask for them.*

### STOP YOUR GLASSES FROM ATTRACTING SAWDUST

Static electricity attracts sawdust to lenses, especially plastic ones. Dennis Tumminello, a woodworker who heads Pearle Laboratories in Dallas, has the solution: "Start with scratch-resistant lenses for some antistatic protection. Then, clean them with ArmorAll®, a product available at hardware stores."

Type	Manufacturer
READY TO WEAR	Jackson Prod. Arden Safety
	American Optical Corp.
	American Optical Corp.
	UVEX Winter Optical Inc.
	Titmus Optical Inc.
CUSTOM-FIT	Titmus Optical Inc.
	Titmus Optical Inc.
	Liberty Safety
	Titmus Optical Inc.
	Titmus Optical Inc.
SAFETY GOGGLES	Jackson Prod. Arden Safety
	UVEX Winter Optical Inc.
	Titmus Optical Inc.
	UVEX Winter Optical Inc.
	Titmus Optical Inc.

## WHERE TO BUY SAFETY GLASSES

• *Hardware stores and home centers* sell goggles and prefab safety eyewear. However, all of their products may not meet the Z87 standard, so read labels and warnings carefully.

## SAFETY EYEWEAR LINEUP

		TYPE					PROTECTION					FEATURES					COST								
		Plane Z87 lenses	Rx Z87 lenses	Permanent shields	Detachable shields	Permanent wire-mesh shield	Brow shields	Wear over normal glasses	Wipe-on chemicals only	Chemical sprays	Hand tools only	All tools	Frontal impact protection only	Dress-work wear	Adjustable temple	From eyewear specialists	All hardware or safety suppliers	Scratch-resistant lenses available	Fog-resistant lenses available	Metal frames	Plastic frames	Under \$20 w/plano lenses	Under \$20 Frame only	\$35-\$50 Frame only	About \$100 Frame only
*		*						*		*					*	*				*	*				
*		*						*		*					*	*				*	*				
*		*						*		*			*	*	*	*				*	*				
*		*			*			*		*			*		*					*	*				
*		*		*				*		*		*			*					*	*				
*	*							*	*	*	*	*	*	*	*	*	*	*	*	*	*			*	
*	*		*					*		*	*	*	*	*	*	*	*	*	*	*	*			*	
*	*		*					*		*	*	*	*	*	*	*	*	*	*	*	*			*	
*	*	*		*				*		*	*	*	*	*	*	*	*	*	*	*	*			*	
*	*	*	*		*			*		*	*	*	*	*	*	*	*	*	*	*	*			*	
*	*	*	*		*	*	*	*		*	*	*	*	*	*	*	*	*	*	*	*	*	*	*	*
*	*	*	*	*	*	*	*	*	*	*	*	*	*	*	*	*	*	*	*	*	*	*	*	*	*
*	*	*	*	*	*	*	*	*	*	*	*	*	*	*	*	*	*	*	*	*	*	*	*	*	*

• **Opticians and optical centers**, such as Pearle Vision Centers, Sterling Optical, and others, fill prescriptions, make prescription safety glasses, sell safety glasses with plano lenses, and sell prefab safety glasses. Some, with affiliated optometrists, also write prescriptions.

• **Optometrists** usually provide the services of opticians and optical centers, plus they test your eyes. *Ophthalmologists* are doctors of medicine who also prescribe corrective lenses. Some will dispense glasses; others only provide the prescription you fill elsewhere.

• **Safety specialty stores** carry goggles and prefabs and from bulk often will break out a single pair for you. Find them in the Yellow Pages under "Safety Equipment." 🍀

Written by Emily Freeman Pinkston  
Photographs: Hopkins Associates;  
Jim Kascoutas

BUILD THIS TERRIFIC TRIO FOR YOUR PATIO OR DECK

# PLANTERS



Blooming beauties rise to the occasion in these outdoor decorators. Simple to construct, the framework consists of 2x4 stock, handsomely covered with weather-resistant cedar fencing. Each planter has a shelf you can position to elevate your favorite plants to just the right height. With a total cost of under \$90, what better way to display your greenery?

# AMPLENTY

*Note: The following directions are for the medium-height planter. To build the other two planters, refer to the Bill of Materials on page 72 for the short planter and page 71 for the tall planter. Although the sizes of the parts vary from planter to planter, the parts for all three planters are lettered the same. To build the shortest and tallest planters, follow the directions for the medium-height planter.*

## CONSTRUCT THE SKELETON FRAMEWORK

**1** Cut four uprights (A) and cross members (B) to the sizes listed in the Bill of Materials. (We ripped and crosscut the uprights to size from one 8' pressure-treated fir 2x4.)

**2** Clamp two cross members between two uprights as shown on the drawing below. Check for square, drill  $\frac{1}{8}$ " pilot holes, and screw the frame together. Repeat for the second frame.

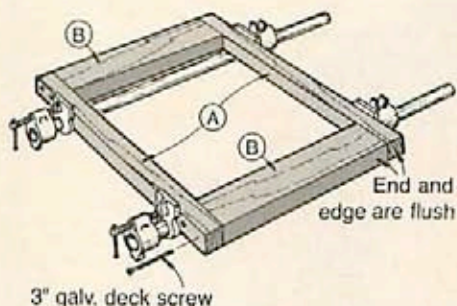

**3** Clamp the remaining four cross members between the two assembled frames. Now, drill pilot holes, and screw them in place as shown in the photo at right.

## NAIL ON THE SIDING

**1** Cut eight corner siding pieces (C) and the center siding pieces (D) to length. (We used 1x6x8'

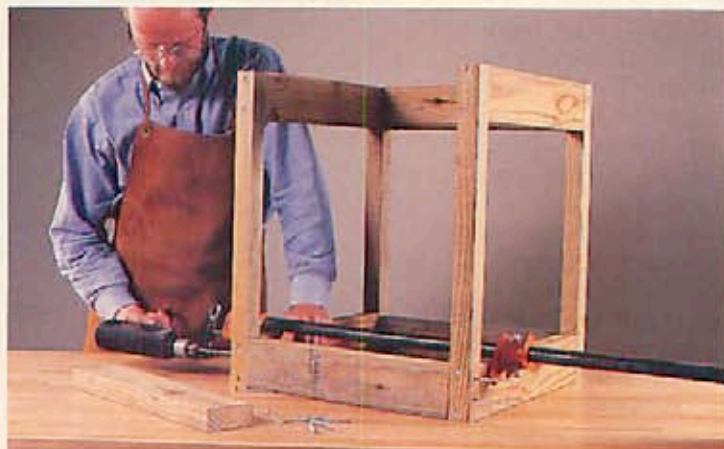
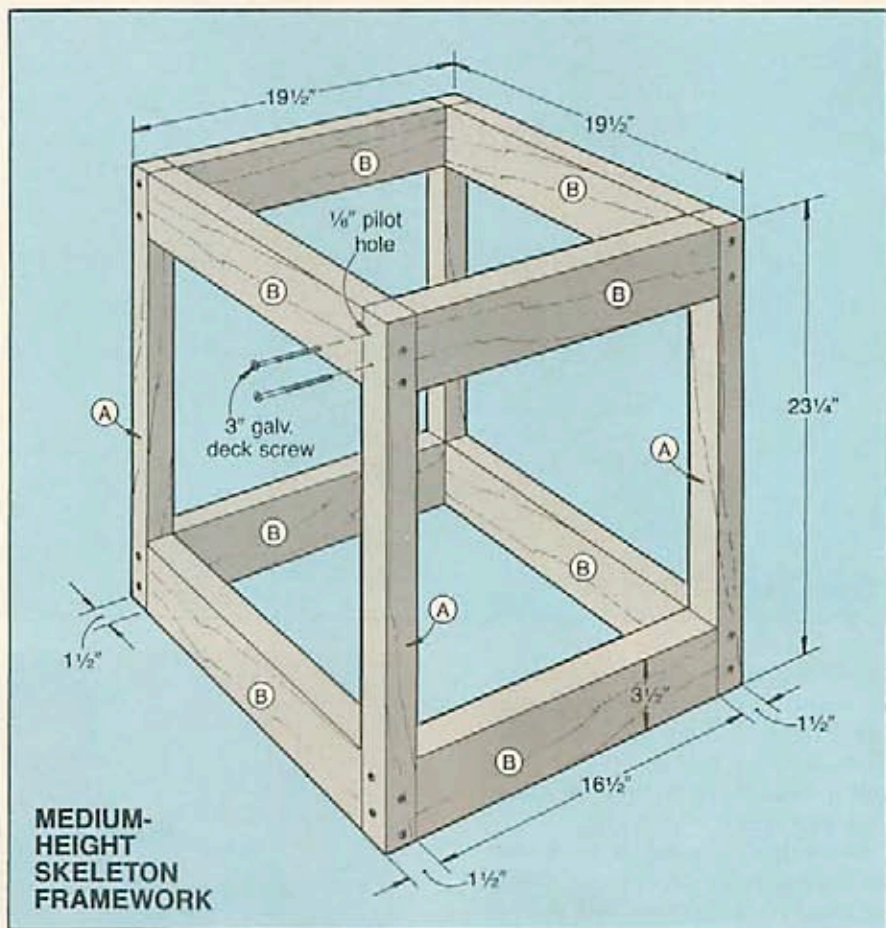

Construct the two frames, clamp the cross members between them, and screw the cross members in position with 3" deck screws.

# PLANTERS APLENTY

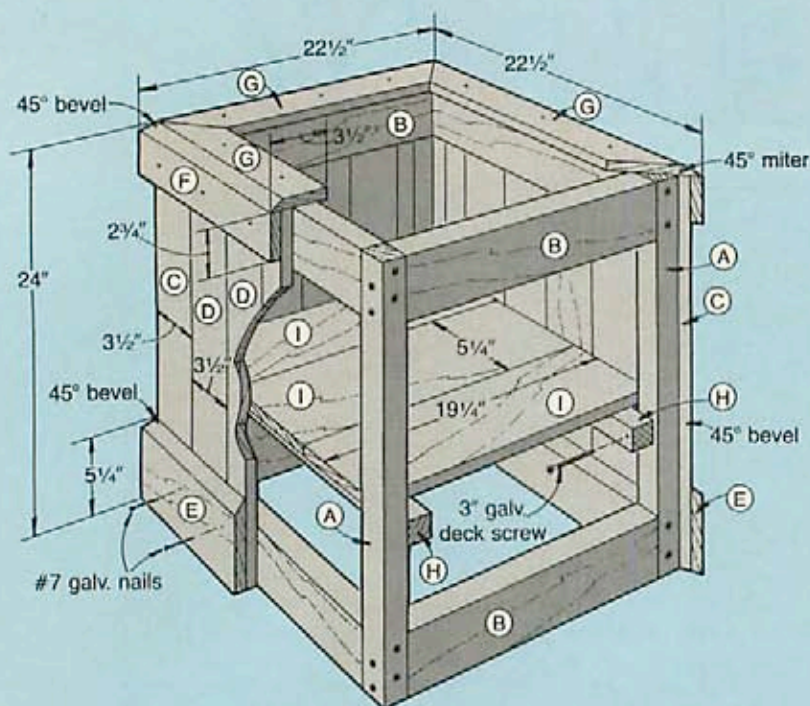

**MEDIUM-HEIGHT PLANTER**

**Bill of Materials**

Part	Finished Size*			Material	Qty.
	T	W	L		
A	1 1/2"	1 1/2"	23 1/4"	fir (treated)	4
B	1 1/2"	3 1/2"	16 1/2"	fir (treated)	8
C	3/4"	3 1/2"	23 1/4"	cedar	8
D*	3/4"	3 1/2"	23 1/4"	cedar	16
E*	3/4"	5 1/4"	22 1/2"	cedar	4
F*	3/4"	2 3/4"	22 1/2"	cedar	4
G*	3/4"	3 1/2"	22 1/2"	cedar	4
H	1 1/2"	1 1/2"	19 1/4"	fir (treated)	2
I	3/4"	5 1/4"	19 1/4"	cedar	3

\*Parts marked with an \* are cut larger initially, and then trimmed to finished size. Please read the instructions before cutting.

**Supplies:** 3" galvanized deck screws, #7 galvanized nails.

cedar fencing. In checking sources, we found that 1x6 cedar fencing varies from 5 1/4" to 5 1/2" in width. With this in mind, 5 1/4" is the widest board you'll find on these three planters.)

**2** Bevel-rip one edge of each corner siding piece at 45° to obtain the finished width (we did this on the table saw).

**3** Holding the beveled edges tight, nail two corner siding pieces to each corner of the framework. Keep the top edges of the siding pieces flush with the top of the framework. (See the Siding and Trim Drawing for details.)

**4** Measure the distance between the corner siding pieces (C), divide this distance by 4, and rip each center siding piece (D) to this width plus 1/8" (we cut our pieces to 3 3/8" wide). Next, starting at the outside and working in, as shown in the photo at right, nail the center pieces in place. Plane one edge of each of the last two remaining in-



After assembling the skeleton frame, nail the siding pieces in place by starting at the outside and working in. Plane the center piece to fit.



### Bill of Materials

Part	Finished Size*			Material	Qty.
	T	W	L		
A	1½"	1½"	29¼"	fir (treated)	4
B	1½"	3½"	7"	fir (treated)	8
C	¾"	3¾"	29¼"	cedar	8
D*	¾"	4"	29¼"	cedar	4
E*	¾"	5¼"	13"	cedar	4
F*	¾"	2¾"	13"	cedar	4
G*	¾"	3"	13"	cedar	4
H	¾"	1½"	9¾"	cedar	2
I	¾"	5¼"	9¾"	cedar	1

\*Parts marked with an \* are cut larger initially, and then trimmed to finished size. Please read the directions before cutting.

Supplies: 3" galvanized deck screws, #7 galvanized nails.

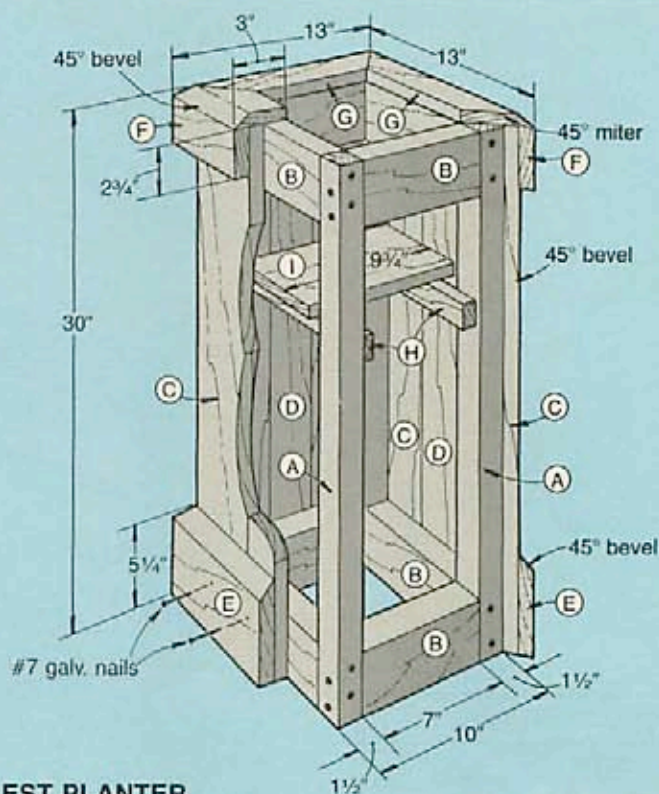

TALLEST PLANTER

### Cutting Diagram

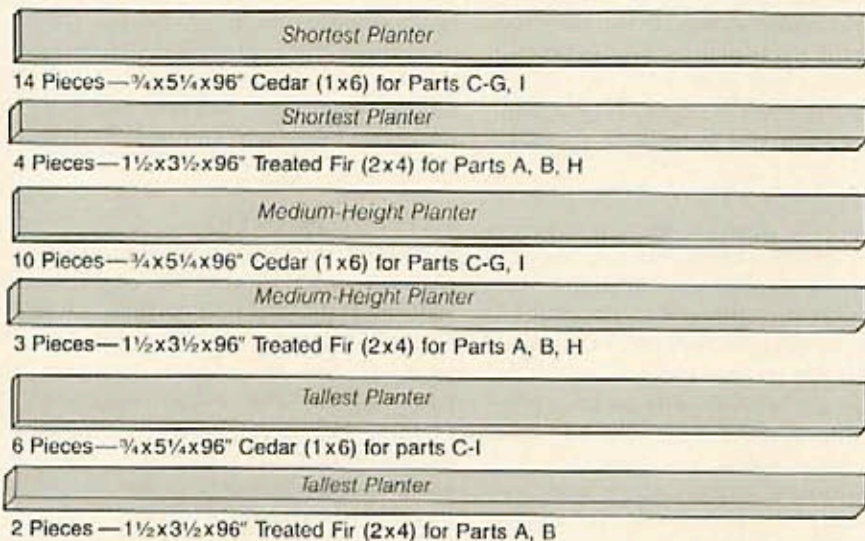

side pieces until they fit snug between the other pieces.

**5** Belt-sand the top and bottom edges of the siding (C, D) flush with the top and bottom edges of the framework (A, B).

### CUT AND ADD THE TRIM PIECES

- 1 Cut the base pieces (E) to length plus 1".
- 2 Hold the pieces in place, and mark the length needed (a combi-

nation square works well for marking the 45° angles). Miter-cut both ends of each base piece. (We cut ours on the table saw using a miter gauge to push the pieces over the angled blade. You could also cut the pieces on the radial arm saw.)

**3** Bevel-rip the top edge of each at 45° to trim the board to width. Nail the pieces in place around the perimeter of the base.

**4** Mark the lengths needed, and cut the top trim pieces (F) to length plus 1". Now, rip the pieces to width, and miter-cut them to length. Nail the pieces in place flush with the tops of the siding.

**5** Measure the distance, and cut the top pieces (G) to length plus 2". Now, bevel-rip the outside edge of each piece to trim the piece to a 3½" width. Carefully measure the distance, and miter-cut the top pieces to length. With the outside edge of each G flush with the outside face of each F, nail the top pieces in place.

Continued

# PLANTERS APLENTY

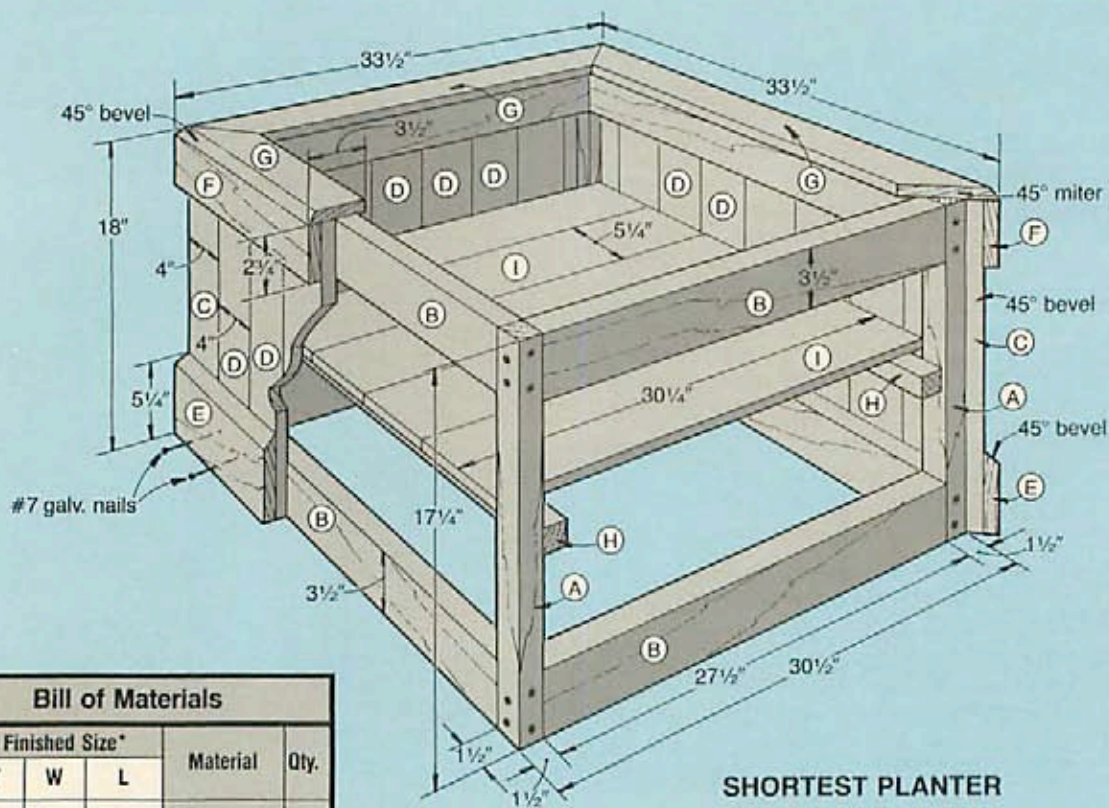

**Bill of Materials**

Part	Finished Size*			Material	Qty.
	T	W	L		
A	1 1/2"	1 1/2"	17 1/4"	fir (treated)	4
B	1 1/2"	3 1/2"	27 1/2"	fir (treated)	8
C	3/4"	4"	17 1/4"	cedar	8
D*	3/4"	4"	17 1/4"	cedar	24
E*	3/4"	5 1/4"	33 1/2"	cedar	4
F*	3/4"	2 1/4"	33 1/2"	cedar	4
G*	3/4"	3 1/2"	33 1/2"	cedar	4
H	1 1/2"	1 1/2"	30 1/4"	fir (treated)	2
I	3/4"	5 1/4"	30 1/4"	cedar	5

\*Parts marked with an \* are cut larger initially, and then trimmed to finished size. Please read the instructions before cutting.

Supplies: 3" galvanized deck screws, #7 galvanized nails.

## ADD THE SHELF

**Note:** The shelf allows you to raise or lower your potted plants for the best viewing height. We positioned our shelf so the top of the pots was about level with the top of the planter.

**I** Rip and crosscut the shelf cleats (H) to size from 2x4 stock. Now, cut the shelf boards (I) to size.

**2** To locate the shelf for the planter, measure down from the top edge of each planter the height of the flowerpot plus 3/4", and make a mark on each upright. (For example, if your pot is 8" high, measure down 8 3/4" and make a mark on each upright.) Then, lay the planter on its side, position the top edge on one cleat (H) even with the marked lines on two of the uprights, and screw it into place. Lay the planter on the opposite side, and repeat to fasten the second cleat.

**3** Lay the shelf boards on the cleats (we didn't nail ours in place in case we ever wanted to change the cleat positions for new pots), and add the plants. Finally, call the neighbors over for coffee on the patio—they can't help but notice your sharp new planters.

## SHORTEST PLANTER

To build the shortest of the three planters, refer to the Bill of Materials on this page, the Cutting Diagram on

the previous page, and the directions starting on page 69 for the medium-height planter. Although the sizes of the parts vary, they are lettered the same, and the building procedure is nearly identical to that of the medium-height planter.

## TALLEST PLANTER

To build the tallest of the three planters, refer to the Bill of Materials and the Cutting Diagram for the tall planter on the previous page and the directions starting on page 69 for the medium-height planter. Although the sizes of the parts vary, they are lettered the same and the building procedure is nearly identical to that of the medium-height planter except for the shelf. Due to the small opening at the top, attach the cleats (H) before attaching the siding.

Written and Produced by Marlen Kemmet  
Project Design: James R. Downing  
Photographs: Bob Calmer  
Illustrations: Mike Henry, Bill Zaun

**NEW**  
From  
Penn State  
Industries... a  
supplier of quality products  
for over 40 years

*Professional quality, precision . . .*  
**Super 15" Scroll Saw**

Comparable value over \$500  
Only ~~\$189.95~~ shipped complete ready to run

**New Lower Price**  
**\$129.95**

This versatile machine makes cutting intricate wood patterns easy — great for making toys, jewelry, puzzles, fretwork, etc. The blade is driven on both up and down stroke with a smooth cutting parallel rocker arm system. This system avoids blade breakage and creates a smooth finish that virtually eliminates sanding. Our saw is easy to use and is made with a cast construction that insures durability. We fully support our product with replacement parts and repairs if needed. Thousands of satisfied customers use our saw world-wide.



Dear Penn State:  
"My SUPER Scroll Saw was delivered two days ago and it performs like the neighbor's \$700 one. I'm delighted."

Mrs. S.A. Swartz  
White Cloud, KS

"I recently received one of your 15" Scroll Saws as a gift and was impressed with its construction and other features. I'd say it can be compared favorably with such saws as Escaliber and the Hegner line."

Mr. E. L. Brendza  
San Bernardino, CA

"I am thrilled with the performance as is my wife who has operated it more than I have. As a special automatic machine designer for the last 40 years, I feel that I am qualified to compliment you on a well-designed machine."

C.M. Smeigh  
Ft. Worth, TX

The Editor  
The Woodworker's Journal  
"Kudos for the folks at Penn State Industries for value and customer service! When I contacted them concerning a minor problem, replacements were rushed out to me the same day."

As an amateur woodworker, I was pleased to find that lower priced, well made equipment is available from people who are willing to stand behind their products.

A. Mortenson  
New Milford, CT

NEW!

★ **Dust Blower**  
(Optional - Add \$15.00)

**SPECIFICATIONS:**

- Cast iron construction
- Throat depth — 15"
- Max. depth of cut — 2"
- Cuts per minute — 1725
- Weight — 43 lbs
- Motor — Heavy duty totally enclosed fan cooled 110V - 120V  
UL listed, ball bearing — induction motor

- Use standard 5" blades
- Stroke length — 3/4"
- Table Tilt — 0 - 45°
- Table Size — 8" x 17"

30 Day Money Back  
Guarantee—1 year  
warranty parts/labor

FREE: 12 Blades &  
Blade Holder Set  
with purchase

**PENN STATE INDUSTRIES -W**  
2850 Comly Road • Philadelphia, PA 19154  
1-215-676-7609 (Ext. 15)

\* Add \$15.00 for Blower Option • Visa, MasterCard, Check or Money Order Accepted  
Add \$10.00 for shipping in Continental U.S. • Pennsylvania residents add 6% sales tax

# Like Having A Lumberyard Right In Your Shop!

## NOW! PLANE, MOLD & SAND with the Precision Control of Infinitely Variable Power-Feed!



**FREE  
30-DAY  
TRIAL**

Just a twist of the dial gives you from 70 to over 1000 cuts per inch... you can sail through even the toughest oak at higher speeds, or slow down to surface stock that is virtually impossible on any other machine. Slower speeds turn out glass smooth molding... no sanding needed!



Woodmaster's Quick-Change Molding Head lets you create custom moldings from any stock. Choose from over 250 standard trim and picture frame patterns... or design your own!

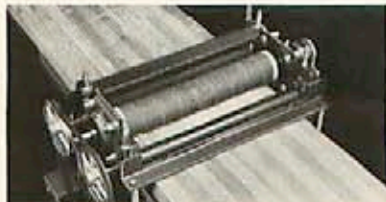

Power-fed sanding speeds production and improves the quality of your work. No more waves or crossgrain scratches. Separate Sanding head installs in just minutes.

Now choose from two powerful models! Woodmaster introduces the first 18 1/2" Planer/Molder... The "BIG 18"... with all the features that have made the 12-in. model the most versatile Planer/Molder on the market! Send for Free Facts today!



details on your 30-DAY FREE TRIAL GUARANTEE!

**WOODMASTER TOOLS, INC., DEPT. PW25 • 2908 Oak Street  
KANSAS CITY, MO 64108 • Or Phone: 1-800-538-4200 Ext. 2325**

**YES!** Please rush me your **FREE** Information Kit plus details on your **30-DAY FREE TRIAL GUARANTEE!**

NAME \_\_\_\_\_  
ADDRESS \_\_\_\_\_  
CITY \_\_\_\_\_  
STATE \_\_\_\_\_ ZIP \_\_\_\_\_

# HOBBY WORKHORSE



Whether your hobby is building planes, trains, automobiles or hobbyhorses, you need the right tool for the job.

The Dremel Moto-Tool® is a hobby workhorse that works wonders. It shapes cherry wood into lifelike wildlife. Cuts off model railroad tracks at the end of the line. Sands balsa wood smooth enough to really take wing. And buffs an old iron horse to a showcase shine.

The Moto-Tool lets you get more satisfaction and enjoyment out of your hobby by putting more precision and control into it.

With speeds up to 30,000 RPM, the Moto-Tool gives you the "horsepower" to cut, grind, sand, drill and polish with pinpoint accuracy. And its lightweight housing makes hours of work seem effortless.

See the Moto-Tool at your hobby, craft or hardware dealer. And put a little more horsepower into your hobby.



**DREMEL**  
Gets the job done bit by bit.

© 1988 Dremel

## SAVE \$\$ SHARPENING YOUR OWN JOINTER/PLANER KNIVES

See related article on page 26

Instead of waiting days for a sharpening shop to grind your jointer knives, do the job in minutes at your drill press.

You can save the expense of someone else sharpening your jointer/planer knives by building this jig conceived by *WOOD*® magazine Design Editor Jim Downing. As shown below, the secret to the success of this

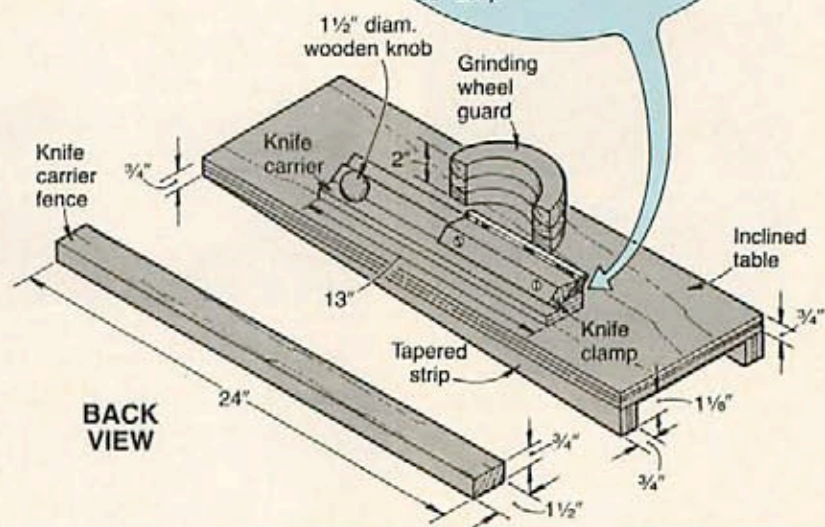
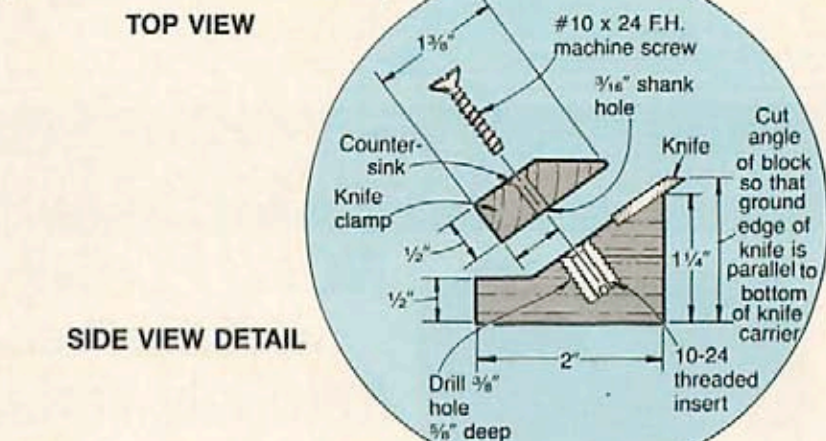
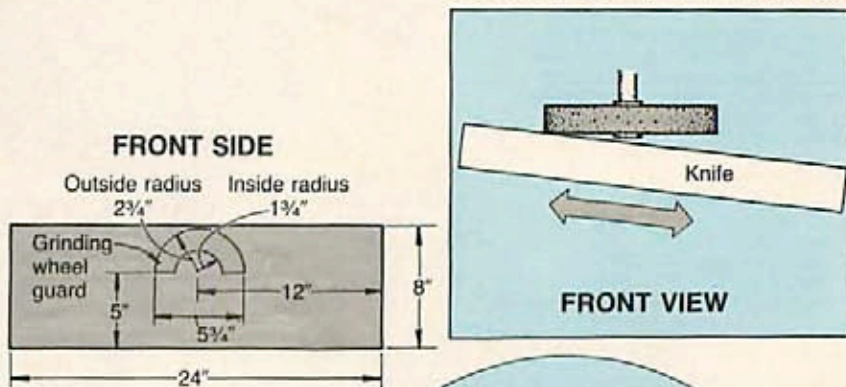

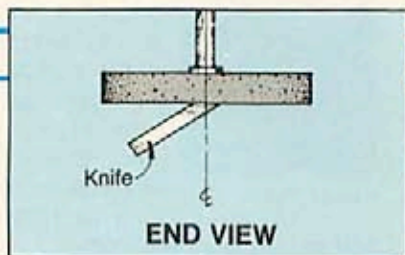

sharpener is that the knife passes across the stone at an angle. Result: only the outside rim of the stone touches the knife, creating a sharp edge and minimum heat. After you build the jig, you'll only need to fashion a knife carrier for each of your knives (if they're different in size).

To use the jig:

- Put the grinding stone into the chuck and set your drill press for 3,000 rpm.

- Clamp the inclined jig table to the drill press table, positioned so the stone centers within the curved guard.

- Clamp the knife into the carrier.

- Raise the table so the knife just touches the stone.

- Adjust the carrier fence so the bevel on the knife centers on the stone (see the end view illustration above).

- With the drill press still turned off, slide the carrier/knife assembly across the stone to check for adequate clearance.

- Don your face shield, start the drill press, and slide the knife across the stone. Slide in a slow and steady movement (about 1" every second). Once past the stone, slide the knife back across the stone and repeat until sharp. You may have to raise the table slightly to remove any nicks in the knife.

- Caution:** Raising the table too much will put excessive pressure on the stone, causing the knife edge to overheat or possibly shatter the stone. So take it easy!

- Finally, remove the knife from the carrier and whet away the burr from the knife's back side.

Jig design: James R. Downing  
Illustrations: Mike Henry, Bill Zaun

## Be Your Own Boss and Make

# \$18.00 to \$30.00 AN HOUR!



Your FREE Lifetime Security Fact Kit tells you how to make \$18.00 to \$30.00 an hour in your own Foley-Belsaw Full-Service Saw and Tool Sharpening Business. Your FREE Fact Kit explains how you can:

- be your own BOSS!
- work full time or part time, right at home.
- do work you enjoy and take pride in.
- operate a CASH business where 90¢ of every dollar you take in is clear CASH profit.

And it is so easy to learn. Foley-Belsaw gives you all the facts and instructions. No experience or special training is necessary. Foley-Belsaw tells you everything you need to know to be successful.

And there's plenty of business available in your area. You will be able to sharpen all types of saws, garden and shop tools for home, farm and industry.

You will be able to set your own hours and not have to worry about layoffs and strikes. And there are no franchise fees. Any age person can succeed.

But you've got to get the FACTS before you can get started. So write NOW for your FREE Lifetime Security Fact Kit. It's yours to keep with NO OBLIGATION.

... send NOW for your FREE Lifetime Security Fact Kit!



FREE  
LIFETIME  
SECURITY  
FACT KIT



Foley-Belsaw Co.  
6301 Equitable Rd., Dept. 20687  
Kansas City, Mo. 64120

YES, I want to know more!  
Please rush my FREE Lifetime Security Fact Kit.

Name \_\_\_\_\_

Address \_\_\_\_\_

City \_\_\_\_\_

State \_\_\_\_\_

Zip \_\_\_\_\_

(Area Code) Phone \_\_\_\_\_

## Precision Pockethole Joinery Every Time!

With the **Portalign Pockethole Guide**, the strength, speed, and accuracy of pockethole joinery has never been easier. Manufactured to the highest standards, the pockethole guide comes in your choice of two kits — one for use with a drill press (model 801), and the other with an adapter guide for use with a power hand drill (model 811). Depending on which kit you choose, you can begin making perfect pocketholes for all the most common joints including butt, post and rail, or any angle miter joint.



Model 801



Model 811



**Portalign**  
Precision for Precision Power Tools™



Butt Joint

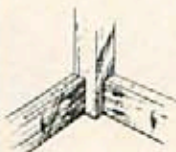

Post & Rail Joint  
(Model 801 only)



Miter Joint  
(Model 801 only)

**Action Welding & Supply, Inc.**  
6140 County Rd. 17  
Helena, AL 35080  
1-800-228-0474  
205-663-0130

**AAA Wholesale Tool & Supply**  
17300 Romeo Boulevard  
Northridge, CA 91325  
818-996-1800

**Atlas American Tool Co.**  
869 N. Hollywood Way  
Burbank, CA 91505  
818-954-9487

**Hemy Electric Tool Co.**  
7635-A Auburn Blvd  
Citrus Heights, CA 95610  
916-723-1088

**Tool City #**  
14138 E. Forestone Blvd.  
Santa Fe Springs, CA 90670  
1-800-423-7899  
1-800-828-7819 (CA)

**Whole Earth Access**  
2900 7th Street  
Berkeley, CA 94710  
415-848-3800

**Wanona Hardware**  
Corner 1st & Delaware  
San Mateo, CA 94401  
415-348-1082

**Schlosser Tool & Machinery**  
301 Bryant St.  
Denver, CO 80219  
303-822-8244

**Brian's Tool Sales**  
9 Moody Road  
Enfield, CT 06082  
203-823-6282

**Jacksonville Woodworkers Supply, Inc.**  
2535 Powers Ave.  
Jacksonville, FL 32207  
904-727-7508

**R.A. Ness & Co.**  
8888 N. Milwaukee Ave.  
Niles, IL 60648  
312-824-0565

**The Tool Haus**  
620 N. Silverleaf  
Gladwin, MI 48624  
1-800-828-0001  
313-224-0489 (MI)

**Diversified Equipment & Supply**  
11223 Star Road  
Charlotte, NC 28212  
704-545-5198

**Woodworking Machinery & Supplies**  
294 Beatty Dr.  
Belmont, NC 28012  
704-827-3190

**The Tool Chest**  
45 Emerson Plaza East  
Emerson, NJ 07630  
201-261-8665 (261-Tool)

**Hedeler Hardware Inc.**  
3 No. Main St.  
Pearl River, NY 10965  
814-725-2066

**Northland Woodworking Supply**  
1 Lee @ N. Genesee Sts.  
Lisica, NY 13502  
315-724-1299

**The Woodworkers' Store at Brewer's**  
161 E. Boston Post Road  
Manassas, VA 20108  
914-699-3232

**Lahman Hardware**  
4779 Kidron Rd.  
Kidron, OH 44836  
216-857-5441

**Mett Master Power Tools**  
5223 Market Street  
Youngstown, OH 44312  
216-783-2130

**Quality Saw & Tool, Inc.**  
328 S. Main St.  
Marshall, OH 44603  
419-526-4221  
1-800-523-6927 (OH)

**Woodcrafters Supply Co.**  
20 Arcadia Avenue  
Columbus, OH 43202  
614-262-8095

**Woodcrafters**  
212 N.E. 5th  
Portland, OR 97232  
503-231-0226

**Man-Wood Hardware**  
426-A Huntington Pike  
Rockledge, PA 19111  
1-800-255-8383  
215-663-0448 (PA)

**Olde Mill Cabinet Shoppe**  
Rt.4 Box 547-A  
Camp Bery Washington Rd.  
York, PA 17402  
717-755-8884

**Cherokee Lumber Company**  
1410 Severnville Pike  
Maryville, TN 37802  
615-982-8250

**Wood World**  
13650 Floyd Rd., Suite 101  
Dallas, TX 75243  
214-859-9133

**Western Woodcraft Supply**  
3149 South State Street  
Salt Lake City, UT 84115  
801-485-5253

**The Source**  
7505 Boudin Dr.  
Springfield, VA 22150  
800-482-9999  
703-544-5460

**Madison Builders Supply, Inc.**  
2021 E. Madison  
Seattle, WA 98122  
206-328-2994  
800-428-1164

**The Wooden Boat Shop**  
1007 NE Boat St.  
Seattle, WA 98105  
206-834-3600

**Rainhold Brothers Company**  
2402 West Lisbon Avenue  
Milwaukee, WI 53205  
414-344-5230

For other areas contact: **Robert Larson Company, Inc.** Dealer inquiries welcomed.  
33 Dorman Ave., San Francisco, CA 94124 • (415) 821-1021

# WOODWORKER'S CATALOG

There are over 4,000 money-saving reasons why woodworkers rely on Constantine.

4,000 woodwork items—to help you Build-Restore-Repair-Refinish! Over 200 different woods... 150 veneers... 500 plans... cabinet hardware... 96 How-To Books... 118 carving tools and chisels... 76 inlay designs... and lots more for One-Stop, Right-Price Shopping without leaving home!

116 Page Catalog—Only \$1.00

**CONSTANTINE** Est. 1812  
2054L Eastchester Road, Bronx, NY 10461



## Make Signs?

If you make or are interested in wood signs, you'll want SignCraft — the magazine for the sign artist. You'll see creative wood signs in every issue — carved, routed and sandblasted — plus how to's, pricing, technical help and more! Your satisfaction is guaranteed.

- 1 yr. (6 issues) . . . \$21
- 1 yr. Outside U.S. (U.S. funds) \$27

**SignCraft Magazine**  
P.O. Box 06031-W, Ft. Myers, FL 33906

## BAND SAW OWNERS!

A NEW TOOL is now available so you can make or repair any length Band Saw Blade in minutes!

This patented tool was developed for use in our own shop and has proven itself with thousands of high quality, true running splices.

Our splicer enables any craftsman to make up any length blade from economical coil blade stock QUICKLY and EASILY. The resulting silver brazed joint normally outlasts the service life of the blade.

Three models are currently available:

- IC-001 1/4" to 3/4" Blades..... \$ 49.95 ppd
- IC-002 3/4" to 1 1/4" Blades..... 49.95 ppd
- IC-003 1 1/4" to 1 3/4" Blades..... 150.00 ppd

The tool comes complete with detailed instructions and supplies for approximately 100 splices.

We also carry additional supplies and OLSON band saw stock at reasonable prices.

Send L.S.A.S.E. for FREE information to:  
**NEW MILFORD SPECIALTIES CO.**  
Dept. BH, 24A South Main Street  
New Milford, CT 06776  
(203) 426-4276

# FREE



48 page catalog for  
decoy carvers  
wood carvers  
wood turners

ORDER TODAY  
1-800-221-9474 OR WRITE TO:

**P.C. ENGLISH, INC.**  
P.O. Box 580, Dept FD12, Thornburg, VA 22565

# CARVE HILLBILLY WILL

An Ozark caricature by Harold Enlow



Harold Enlow

Carver Harold Enlow lives in Dogpatch, Arkansas, smack dab in the middle of the Ozark mountains. Figures of local characters and fictional folk such as Hillbilly

Will stream from his studio.

"I have my carving studio-workshop at home, on our peaceful 38 acres where deer often graze in our field," Harold says, describing



One in a collection of regional patterns from the nation's top carvers.

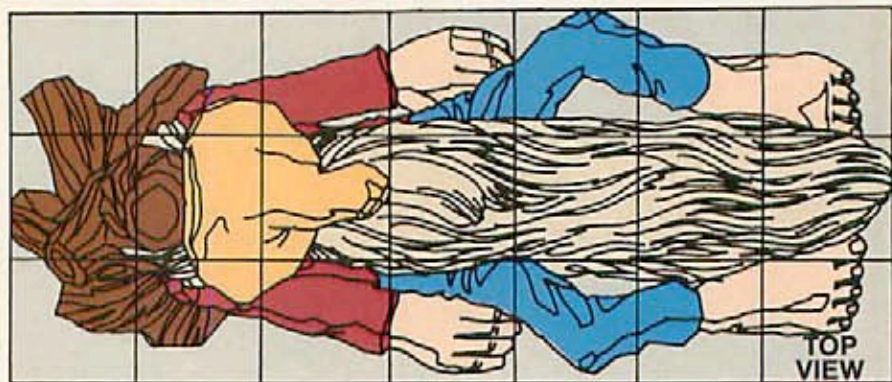
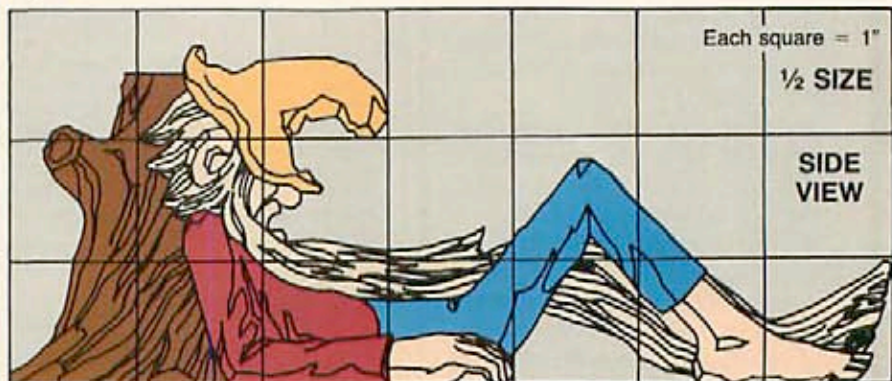

the setting. "My wife, Elaine, does all the finishing on my carvings, and our four-year-old daughter, Katie, plays in the woodchips with our dog, Wendell."

Harold began carving as a hobby in the Army. After his service stint, he learned more about carving by working alongside master carver Peter Engler in Silver Dollar City, Missouri. From there, Harold moved to Dogpatch. Now, in addition to his carving, he writes books and teaches the subject.

Renowned among carvers and the public for his caricatures, Harold says of Hillbilly Will, "This reclining figure is typical of the Arkansas Ozarks' hillbilly all tourists *anticipate* seeing, but rarely do. However, there are a few of us left if you look in just the right places."

#### CARVING AND FINISHING HILLBILLY WILL

Harold likes basswood, and that's what he used for this 7x2 1/4" figure. However, any carving wood that takes detail will work.

"Trace the pattern on the carving block so that the wood grain runs the length of the figure," he advises. "That way, your long, continuous cuts for the hair of his beard will flow smoothly."

This accomplished carver relies on a carving knife and a few small palm gouges to shape the figure and add details. For the tiny furrows in the figure's hair, beard, fingers, and toes, Harold calls on a narrow-angled V-tool. "Make sure your V-tool is extremely sharp," he notes, "or the cuts will be ragged instead of clean and smooth."

For finishing, Elaine thins artist's acrylic paints to stain consistency. After the paint dries, she applies a furniture antiquing finish, then wipes it off immediately. Sprayed-on acrylic protects the figure.

**Note:** For a full-size pattern, send a self-addressed, stamped, business-size envelope to: HILLBILLY PATTERN, WOOD® Magazine, Locust at 17th, Des Moines, IA 50336. Offer expires Dec. 31, 1988. ♣

Design: Harold L. Enlow  
Photographs: Bob Calmer, Elaine Enlow

# SAVE NOW... PAY LATER!



Critically acclaimed, high precision German made true parallel arm scroll saw.

- Perfectly square cuts
- Quickest blade change
- Cuts 2" hardwood, plus metals and plastics.

Order your HEGNER Precision Scroll Saw now at big savings! Open your Advanced Machinery Imports Revolving Charge and enjoy your HEGNER for 3 months before paying a penny, except shipping.

After 90 days, pay monthly or pay in full with no service charge.

Offer expires Aug. 31, 1988.

Don't delay, take advantage of this limited-time opportunity. Call now for details, or to order.

CALL TODAY **1-800-648-4264**



ADVANCED  
MACHINERY  
IMPORTS LTD

P.O. Box 312  
Dept. 289  
New Castle, DE  
19720

## The workbench companion

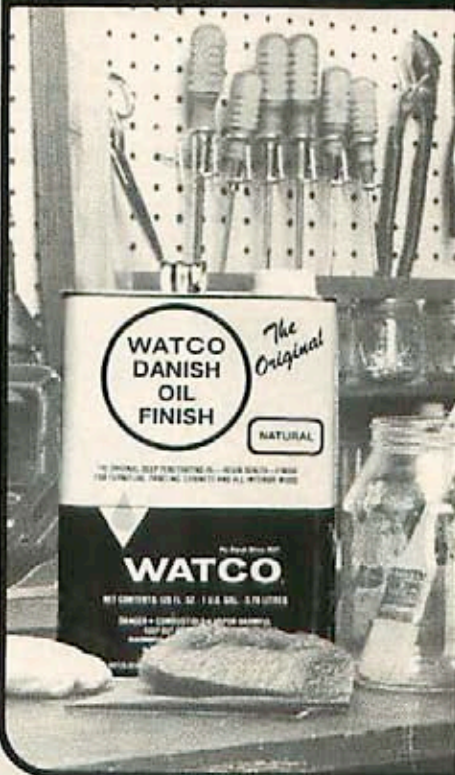

## WATCO®

*The Original and Still the Best*

### DANISH OIL FINISH

Watco Danish Oil Finish can be your ideal workbench companion for all those wood finishing projects around the house. You'll be amazed at how easy it is to finish wood beautifully with Watco, "The Original Danish Oil". Watco gives wood that natural, hand-rubbed look with long-lasting durability. And because Watco is **IN** the wood... not on it like temporary surface coatings... there is no finish that will wear off. Watco Danish Oil is ideal for furniture, paneling, cabinets, doors, trim-work and even antiques. It's also safe for use on butcher blocks, cutting boards, and children's toys after Watco dries and cures in the wood. Choose from 8 beautiful finishes... Natural and Medium, Dark, and Black Walnut shades, and Cherry, Golden Oak, Fruitwood, and English Oak colors.

Send today for "Free" color booklet "How to Finish Wood Beautifully and Easily" and the name of your nearest Watco distributor.

**WATCO-DENNIS CORP.**, Dept. BH-W88  
2407 Wilshire Blvd., Suite 90,  
Santa Monica, CA 90403

Name \_\_\_\_\_  
Street \_\_\_\_\_  
City \_\_\_\_\_  
State \_\_\_\_\_ Zip \_\_\_\_\_

**MAKE UP TO \$26.00 an HOUR**

**START YOUR OWN MONEY MAKING BUSINESS**

Hundreds of FOLEY-BELSAW trained men have succeeded in this fascinating and highly profitable field...

You Can Do It Too! ... BE A

**LOCKSMITH**

**FREE BOOKLET**



Never before have money-making opportunities been so great for qualified Locksmiths. Now lucrative regular lock and key business has multiplied a thousandfold as millions seek more protection against zooming crime. Yet there's only one Locksmith for every 17,000 people! Train FAST at home — Collect CASH PROFITS Right Away. You're in business ready to earn up to \$26.00 an hour a few days after you begin Foley-Belsaw's short-cut training. Take advantage of today's unprecedented opportunities in Locksmithing for year-round EXTRA INCOME in spare time — or full time in a high-profit business of your own. Hundreds we've trained have done it. So can YOU! All tools plus practice materials and equipment, plus simple, illustrated lessons, plus expert supervision, plus business-building guidance will enable you to KEEP THE MONEY COMING IN! Ideal for retirement — good jobs, too.

SEND FOR EXCITING FACTS — NO OBLIGATION! PRO KEY MACHINE YOURS TO KEEP FREE

This machine can add up to \$200 a month to your income... it won't cost you a penny extra with your training.



FIND OUT ABOUT IT RUSH COUPON TODAY

There is NO OBLIGATION \* NO SALESMAN Will Call - ever!

**FREE** FOLEY-BELSAW INSTITUTE  
4321 Equitation Rd., Dept. 11434  
Kansas City, MO. 64122

PLEASE RUSH FREE BOOK "Keys To Your Future"

NAME \_\_\_\_\_  
ADDRESS \_\_\_\_\_  
CITY-STATE-ZIP \_\_\_\_\_

Tells how you quickly train to be your own boss in a profitable Sparetime or Full-time business of your own.

SEND FOR YOUR COPY TODAY!

30 DAY NO RISK TRIAL

ALL SPECIAL TOOLS AND EQUIPMENT INCLUDED



FOLEY-BELSAW INSTITUTE  
4321 Equitation Rd., Dept. 11434  
Kansas City, MO. 64122

**SHAKER PEGS  
CANDLE CUPS  
MUG PEGS**

\$17.95 per 100, prepaid.  
Wide selection of other wood products.

Catalog \$2.00 or free with order.

**Benny's Woodworks**

P.O. Box 656, Dept. WD10  
Antioch, TN 37013  
1-800-255-1335

Shaker Peg



Mug Peg



**OVAL PICNIC TABLE  
FULL SIZE PATTERN**

Dept. W-2 Plans \$12.50

The oval shape of this table gives an eye catching quality that most people like plus the social feature you get from seating in a semicircle. Table is made of 2" lumber and a bolted construction.

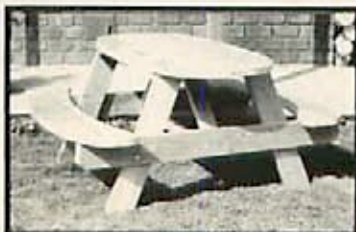

Specialty Furniture Designs  
of Michigan

797 West Remus Road, Mt. Pleasant, MI 48858

**MAKE TOYS  
AND WHIRLIGIGS**

1100's of plans, parts, kits, books, finishes & supplies for toys, whirligigs, classic autos, swing sets, doll houses, crafts & furniture. Also toy, craft, game & furniture parts in maple, oak, walnut & cherry. Bulk prices available. 54 page color catalog subscription \$1. (614) 484-4363

Cherry Tree Toys, Box 369-409, Belmont, Ohio 43718

**WOOD SAWYER**

21" long

Uncut Kit: \$24.95  
Just cut, sand and assemble



Visa/MC  
Precut Kit: \$29.95  
Just sand and assemble

**HORTON BRASSES**

Nooks Hill Road, P.O. Box 1203  
Cromwell, CT 06416 (203) 635-4400

HORTON BRASSES are authentic copies of 17th, 18th, 19th & early 20th century pulls



Mfrs. of Cabinet & Furniture Hardware for Homes & Antiques.  
Send \$3.00 for a Catalogue.

**"Jorgensen" AND "Pony"**

**CLAMPS**

Dependable extra hands for all types of clamping and work-holding jobs: woodworking projects, home maintenance, and furniture repair.

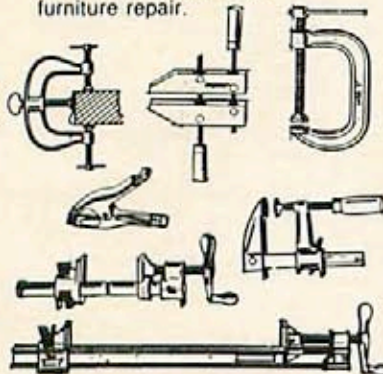

Write for FREE LITERATURE. For big 32-page "how-to-clamp-it" catalog, send \$1.00.

ASK YOUR DEALER

**ADJUSTABLE CLAMP COMPANY**  
THE CLAMP FOLKS  
410 N. Ashland Ave./Chicago, IL 60622

**Workshop Motor**

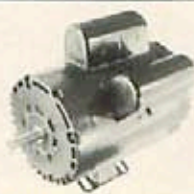

ITEM 10-1142

**\$99.50**

Includes Shpg.

• Brand new LEESON. Ideal for woodworking equipment, power tools, air compressors, pressure washers, etc. Open drip-proof design. 115 VAC, 1 HP, 1725 RPM, 11.2 amp, reversible, 1.25 service factor, cont. duty. Shaft 5/8" diam. x 1 7/8 w/keyway, 56 frame, thermal protection, size 9 1/4" x 6 1/2" x 9".

CALL 800-228-3407  
**Burden's Surplus Center**  
1015 West "O" • P.O. Box 82209-WM • Lincoln, NE 68501-2209  
**Ask For Free Catalog!**

**The Japan Woodworker's Catalog is...**

loaded with the best tools you can get your hands on. In our catalog you will find a complete selection of Japanese tools for the woodcarver, carpenter and cabinetmaker. Send \$1.50 for our catalog and supplements during the next two years.

**THE JAPAN WOODWORKER**  
1731 Clement Ave., Alameda, CA 94501  
Phone (415) 521-1810

ATTENTION  
**FLORIDA WOODWORKERS**

We have Florida's largest and most unbelievable selection of exotic imported and native hard and soft woods, table slabs, veneers, etc. We also stock Ashley Isles carving tools.

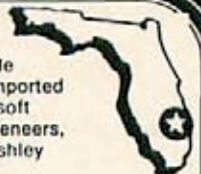

Send \$1 for complete price list.

**HENEGAN'S WOOD SHED**  
7760 Southern Boulevard  
West Palm Beach, FL 33411  
Call (305) 793-1557  
Open Tues.-Sat. 9:00-5:30

**Sand-Rite**

**Pneumatic Drum/Brush Head Sander**  
Eliminate Tedious Hand Sanding!

Model No. DB-612



Sand irregular surfaces without loss of shape or detail.

Made in USA.

Pneumatic sanding drum. Available in five diameters, 2" to 8". Operator-regulated inflated drum conforms abrasive sheet to contoured work.

Our nationwide dealer network serves you. To order, call Toll-Free 1-800-521-2318 or your nearest dealer or a Free brochure.

**Sand-Rite MANUFACTURING CO.**  
321 N. JUSTINE ST. ■ CHICAGO, IL 60607



# 12.5" SURFACE PLANER

Limited  
Time  
Now Only...

# \$401



**TTG-125! THE ULTIMATE POWER PLANER!  
IT'S THE ONE YOU'VE WAITED FOR!**

QUALITY. DEPENDABILITY. AFFORDABILITY.

Machine Data

Motor: \_\_\_\_\_  
Volts \_\_\_\_\_ 115(60Hz)  
Amps \_\_\_\_\_ 15/115V Single Phase

Cutting Capacity:  
Width of Stock \_\_\_\_\_ Max \_\_\_\_\_ 12 1/2"  
Thickness of Stock \_\_\_\_\_ 3/16" - 6"  
Depth of Cut \_\_\_\_\_ Max \_\_\_\_\_ 1/8"  
Feed Rate \_\_\_\_\_ 26.2FPM

Cutter Head  
Number of Knives \_\_\_\_\_ 2  
Diameter \_\_\_\_\_ 1.89"  
No. Load Speed \_\_\_\_\_ 8,000 RPM  
Cuts Per Minute \_\_\_\_\_ 18,000

Over All Dimensions  
Length \_\_\_\_\_ 21.9"  
Width \_\_\_\_\_ 11.4"  
Height \_\_\_\_\_ 15.4"  
Weight \_\_\_\_\_ Approx. 70 lbs.

**Tools-To-Go, Inc.**

15935 N.W. 57th Ave.  
Hialeah, Florida 33014

OPTIONAL ACCESSORIES:



PLANER STAND \$54

Extra set  
of Blades  
\$20.00  
(with purchase)

FREE SHIPPING when you mention  
you saw this in WOOD MAGAZINE\*

Call Toll Free

**1-800-445-1419 (USA)**

800-330-5057 (FL) • 305-620-2999 (LOCAL)

# WOOD PARTS FROM MIDWEST DOWEL WORKS

Compare Our Low Prices!

	Qty.	Cost
3-1/2" Poplar Shaker Peg	\$15/100	_____
1-3/4" Mini Shaker Peg	\$7/100	_____
3-1/2" Country Wall / Mug Peg	\$15/100	_____
2-1/2" Country Shanty Peg	\$12/100	_____
Large Bean Pot Candle Cup	\$17/100	_____
Brass Inserts	\$9/100	_____
1/2" Mini Candle Cup	\$10/100	_____
1-1/2" Toy Wheel	\$10/100	_____
2" Toy Wheel	\$17/100	_____
Axle Pegs	\$4/100	_____

Great Buys!

	Qty.	Cost
3/8" x 36" Standard Dowels	\$21/100	_____
3/4" x 36" Oak Dowels	\$15/10	_____
3/8" Maple Buttons	\$2.15/100	_____
1/2" Maple Buttons	\$2.25/100	_____
1-1/2" Maple Spindles	\$9/100	_____
2-1/8" Maple Spindles	\$18/100	_____

ORDER NOW

MC/Visa  Check Enclosed

Total Cost \_\_\_\_\_

Handling **\$3.00**

Ohio residents add 5% sales tax \_\_\_\_\_

Final Cost \_\_\_\_\_

MC/Visa Number \_\_\_\_\_

Expires \_\_\_\_\_ Phone \_\_\_\_\_

Name \_\_\_\_\_

Address \_\_\_\_\_

City/State/Zip \_\_\_\_\_

SMOOTH SANDED HEARTS

3/4" x 1/8" Hearts	\$2.75/100	_____
3/4" x 1/2" Hearts	\$4.50/100	_____
1" x 3/16" Hearts	\$6/100	_____
1" x 3/8" Hearts	\$7/100	_____
1-3/8" x 1/8" Hearts	\$7/100	_____
1-3/8" x 1/4" Hearts	\$8/100	_____
1-3/8" x 1/2" Hearts	\$10/100	_____
2" x 1/2" Hearts	\$18/100	_____

FREE 16-PAGE CATALOGUE

Circle this section for FREE Dowels  
- mixed pack, Maple, Oak, Walnut  
Cherry, from 1/4" up to 1"  
Approximately 10 L.F.T., 14" long.  
\$5.00 value with any order.

## MIDWEST DOWEL WORKS

4631 Hutchinson Road  
Cincinnati, Ohio 45248  
(513) 574-8488

Same Day Service/Order before Noon  
Factory Direct/Satisfaction Guaranteed



## A tree nightmare.

Don't make bad dreams come true.  
Please be careful in the forest.



Remember. Only you can prevent forest fires.

# U-CAN-BUILD

WOODWORKING MACHINES

ACCURATE • RUGGED • VIBRATION FREE

DESIGNS: HUGE BEARINGS & WORK ARBORS  
FEATURE: AMERICAN MADE INDUSTRIAL MOTOR  
HEAVY-STRONG MD FIBERBOARD  
CONSTRUCTION

• 10" TILT ARBOR  
TABLESAW

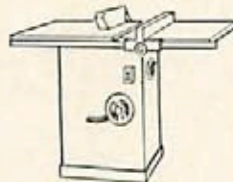

• 18" BANDSAW  
(RESAWS 12" HARDWOODS WITH EASE)

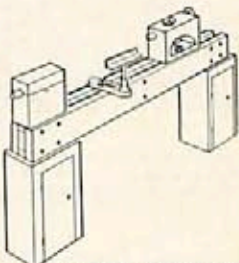

• 15" INBOARD  
24" OUTBOARD  
WOODLATHE

• 16" SCROLL  
SAW

VARIABLE SPEED MODELS AVAILABLE

FREE BROCHURE

CALL: (314) 638-8644

WRITE: J.M. WISE & CO.  
BOX 598  
FLORISSANT, MO 63032

# FACTORY DIRECT CLOCKS AND FURNITURE

Do-It-Yourself  
Kits or Assembled  
and Finished

- Grandfather Clocks, Mantel and Wall Clocks
- Cabinets, Chests, Tables, Chairs, Desks...and more!
- Solid 3/4" Black Walnut, Cherry, or Oak
- Heirloom Quality
- Solid Brass West German Movements and Dials
- Money Back Guarantee

Kit Prices  
Starting at \$89.50.

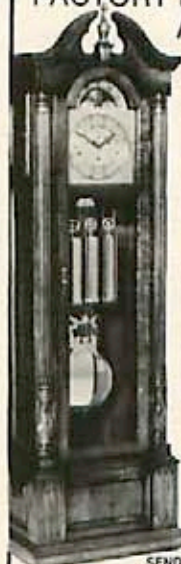

SEND \$1 FOR  
40-PAGE  
FULL-COLOR  
CATALOG



**EMPEROR  
CLOCK COMPANY**

World's Largest Manufacturer of Grandfather Clock Kits  
Dept. 2800, Emperor Industrial Park  
Fairhope, Alabama 36532 • Phone 1-205-928-2316

I am interested in:  
 Do-It-Yourself Kits  Finished Clocks  Finished Furniture

Name \_\_\_\_\_

Street \_\_\_\_\_

City \_\_\_\_\_

State \_\_\_\_\_ Zip \_\_\_\_\_

(Please Print)

# Information

## WORTH WRITING FOR

You can get useful ideas and product information by mail. Use the coupon in this section to order your choice of literature listed below.

### POWER TOOLS

**SCROLL SAW AND LATHE INFORMATION**—More than 20 pages of information, including full-color photos, on HEGNER precision scroll saws, HEGNER lathes, and HEGNER duplicators. Find out why these machines are considered state of the art, and what to look for when shopping for scroll saws or lathes. AMI, LTD. \$1.00. *Circle No. 3.*

**WOODWORKING PROFESSIONALS ONLY**—Now save 50% on machinery, 70% on operating costs! How? By using the world's finest production quality universal machine. Commercial durability, utmost precision, set-up in seconds. No other tool combines usable capabilities like FELDER. Thousands sold all over the world. Now available in America through AMI. Send for brochure. AMI LTD. \$1.00. *Circle No. 4.*

**DREMEL GUIDE TO COMPACT POWER TOOLS**—Contains 266 pages of charts, project plans, "quick fixes", and over 425 photos on how to use all Dremel power tools. Also contains detailed information on how to use the Moto-Tool, which bit to use to cut, carve, grind, polish, sand, engrave, etc., and correct speed for best results. DREMEL, Div. Emerson Electric Co. \$7.95. *Circle No. 33.*

**FREE SUBSCRIPTION TO FOLEY-BELSAW NEWS BULLETIN**—For a limited time Foley-Belsaw will be giving away a 1-yr. subscription to their 64-page color publication. This publication includes stories and shop tips on all types of woodworking, tool sharpening, upholstery, engine repair, and locksmithing. The magazine, published six times a year, includes many special offers on Foley-Belsaw Co. FOLEY-BELSAW. Free. *Circle No. 41.*

**BEAT INFLATION AND HIGH LUMBER YARD PRICES**—Turn trees into valuable lumber with the world famous One-Man Portable Sawmill. Goes right to the trees—turns out smooth, truecut lumber every time. No crew needed, no experience necessary. Send for booklet. FOLEY-BELSAW CO. Free. *Circle No. 42.*

**INCA MACHINERY INFORMATION**—Complete information on the famous line of Inca Swiss woodworking machines. Designed for precision work by the small to medium sized cabinet shop. Used by thousands of hobbyists and professionals. Table saws, bandsaws, joiner/planers, dust collector, radial arm saw. GARRETT WADE CO. Free. *Circle No. 44.*

**IF YOU ARE INTERESTED IN FINE WOODWORKING**—you will not find better machinery than that sold by J.P. Humfrey Ltd. For example, we have 10-in. general tablesaws (3 HP, magnetic switch, available at FOB New York. Send for brochure. J. PHILIP HUMFREY INT. \$1.00. *Circle No. 51.*

**LOBO POWER TOOLS**—surprise the industrial fine woodworking machines with true value. Free 1988 catalog. Listed are all items we sell. Order today and see what we offer. LOBO POWER TOOLS. Free. *Circle No. 57.*

**MAKITA U.S.A. INC.**—offers all new 86-page catalog on their professional line with special emphasis on the entire cordless line. Catalog provides complete information along with available accessories, practical applications at suggested retail prices. MAKITA U.S.A. INC. Free. *Circle No. 61.*

**VERTICAL PANEL SAW/PANEL ROUTER**—Now even working alone you can make extremely accurate rip and cross cuts up to 5 ft. wide in plywood and most sheet goods. Cut V grooves, dadoes, and more quickly, easily and accurately. Utilizing your saw and router, build mobile unit for about \$185, wall unit approx. \$125. Send for plans and parts list. BRAD O'CONNOR. \$14.95. *Circle No. 70.*

**SCROLL SAW**—Information package available from Penn Slate Industries describing the specifications and applications of its super 15-inch scroll saw. Special discount pricing available on current winter promotion. PENN STATE INDUSTRIES. Free. *Circle No. 76.*

**QUALITY AMERICAN-MADE SCROLL SAWS**—The RBI Hawk family of Precision Scroll Saws with 5 models, one to fit your needs. Patent pending Camover Quick Blade Change system, 2 way tilting tabletop, 2 speed or variable speed motor, all add up to make the Hawk the best value on the market today. Virtually end sanding forever! Send for the facts. RB INDUSTRIES, INC. Free. *Circle No. 84.*

**AMERICAN WOODWORKING EQUIPMENT**—Over 57 years of experience manufacturing first quality woodworking machinery. The RBI Woodplaner a leader in versatility and durability featuring planing, moulding, sanding and gang ripping capabilities all in one space saving machine. The RBI Joint Machine makes most precision joints simple to make in just seconds. Send for fact filled brochure. RB INDUSTRIES, INC. Free. *Circle No. 85.*

**SAKURA SCROLL SAW INFORMATION**—You owe it to yourself to compare the value-priced 14-inch 3-speed ScrollMate with other units before you make your buying decision. It offers a built-in air bellows; stand; quick, safe speed changes; and a full 2-year limited warranty—all at a price that's tough to beat. SAKURA USA. \$1.00. *Circle No. 87.*

**SCHPEPPACH #1 NAME IN STATIONARY EQUIPMENT**—Scheppach from Europe has a full line of stationary equipment and combination machines considered #1 in Europe for quality, design, and lasting value. Price of full color catalog is refundable with first purchase. Dealer inquiries welcome. SCHPEPPACH AMERICA. \$2.00. *Circle No. 88.*

**THE VERSATILE TOOLMAX T310**—woodworking machine solves the common "too small a shop" problem by combining a 10" table saw, 1" spindle shaper, 12" jointer, 12" planer and fully adjustable mortising table. Saves 90% on space and 60% on investment. Send for complete color information pack. TOOLMAX. \$1.00. *Circle No. 90.*

**MOLDER-PLANERS FROM WILLIAMS & HUSSEY**—Mold, plane, and edge, convert from moulder to planer in less than 2 minutes. The W-7 series is available in 3 models for manual, power in feed, or power in feed/out feed. The units plane to a satin, almost sanded finish, produce doll house to crown sized moldings, raised panels, and virtually any shape profile. Custom knives available up to 7" wide and 3/4" depth of profile. Rugged, well-made, dependable, and transportable. Complete with sturdy movable stand. Send for catalog. WILLIAMS & HUSSEY. \$1.00. *Circle No. 93.*

**PORTABLE SAWMILLS**—Our new 44-page full color catalog describes each of our 5 sawmill models for 1988, from the compact LT20, that disassembles in 8 light weight pieces, to our largest sawmill, the LT40-HD, with hydraulic log handling capabilities. In addition, dry kiln, carving machines, and shop band saws complete our line of progressive woodworking equipment. WOOD-MIZER PRODUCTS. \$1.00. *Circle No. 94.*

**IS THIS THE WORLD'S BEST JOINER-PLANNER?**—We think so and invite you to take a closer look! MiniMax's new FS-35 joiner-planer combines industrial quality with an affordable price that will appeal to professionals and amateurs alike. THE XYLOPHILES CO. \$1.00. *Circle No. 97.*

**WOODWORKING MACHINES**—New designs that allow you to build accurate, rugged, vibration free machines. 1/4 the cost of their industrial counterparts. 10" tilting arbor table saw, 18" bandsaw, 15" inboard-outboard lathe. Send for brochure. J. M. WISE & CO. Free. *Circle No. 98.*

### HAND TOOLS

**DEALER INFORMATION ON THE ROBERT LARSON CO., INC.**—Specialists in importing, inventorying and wholesaling one of the broadest selections of hand woodworking tools, books and supplies in the U.S. Send for information that includes ten reasons why the Robert Larson Co. is a better wholesale only source for woodworking tools and supplies. Responses will be made to dealer inquiries only on your company letterhead. ROBERT LARSON CO., INC. Free. *Circle No. 135.*

**MAR-WOOD HARDWOODS**—In addition to our wide selection of domestic and imported hardwood lumber, we also offer a world-class selection of quality hand tools at great prices. Send for catalog. MAR-WOOD, INC. \$1.00. *Circle No. 138.*

**PERSONAL BRANDING IRONS**—Brochure describes branding irons that enable you to put your name on your work quickly and easily. Made especially for branding wood, they are available with 1, 2, or 3 lines of copy or with your logo. Changeable data also available. NOVA TOOL CO. \$1.00. *Circle No. 160.*

**THE JAPAN WOODWORKER'S 1987 CATALOG**—is loaded with the best tools you can get your hands on. In our catalog you will find a complete selection of Japanese tools for the woodcarver, carpenter, and cabinet maker. Send for catalog plus supplements for next two years. WOODLINE-THE JAPAN TOOL & SUPPLY. \$1.50. *Circle No. 190.*

### STAINS/FINISHES

**PEG-1000 WHOLESALE**—Polyethylene glycol green wood stabilizer, 10 lbs. \$19.00 plus \$3.20 shipping. Send for additional information. GENERAL FINISHES. 25c. *Circle No. 226.*

**ARTI ANILINE DYES**—Color chart features 28 aniline colors and 8 toy maker's colors. Price list and ordering instructions included. HIGHLAND HARDWARE. \$1.00. *Circle No. 232.*

**TIPS ON WOOD FINISHING**—A comprehensive, 30-page booklet includes numerous tips that save time and trouble for do-it-yourselfers. Information ranges from small repairs to restoring the finish of a priceless antique. Also included is a chart showing the full range of colors available. The name of your nearest dealer is provided. MINWAX CO., INC. Free. *Circle No. 250.*

**EASY WOOD FINISHING**—Learn how to finish wood easily and beautifully with Watco, original Danish Oil Finish. Get a natural, hand-rubbed look in one step...one product. Full color brochure includes usage, tips, trouble-shooting, and more. WATCO-DENNIS CORP. Free. *Circle No. 270.*

### PLANS

**OVER 500 WOODWORKING DESIGNS**—We now offer thirty-nine packets of blueprint plans and full-size patterns with both the home and commercial craftsman in mind. Enjoy making toys, games, children's items, whirligigs, folk art, plaques, magazine racks, shelves, kitchen and household items, birdhouses, plant stands, and more. Simple enough for the beginner, fun and profitable for the pro. Send for illustrated brochure plus sample pattern. ACCENTS IN PINE. \$2.00. *Circle No. 310.*

**WOODWORKERS' PLANS AND SUPPLIES**—Wood projects are simplified with the high quality plans, specialty hardware and other supplies offered by Armor Products. Over 100 plans are available for making toys, desks, clocks, pool tables, lamps, chests, and other furniture. Movements, dials, moldings, ornaments, and hardware also available. ARMOR PRODUCTS. \$1.00. *Circle No. 315.*

**PATTERNS BY DESIGN GROUP**—Hundreds of interesting, useful and fun items to create for personal use or profitable sale. Our newest catalog contains plans for toys, games, plaques, puzzles, birdhouses, planters, furniture, and much more! All Design Group patterns are professional, "same size" blueprints. No enlarging or reducing is necessary. Simply trace outline of item onto wood and create! Started in 1977, Design Group has sold thousands of patterns to thousands of satisfied customers. Prices start at \$1.00, all patterns come with a full money-back guarantee. Wholesale and bulk prices are available on request. Fully illustrated catalog. DESIGN GROUP. \$1.00. *Circle No. 340.*

**FULL-SIZE FURNITURE PLANS CATALOG**—Illustrates and describes over 200 plans for making furniture of quality found in museums and fine furniture stores. Plans include rollout desk, cradles, dining tables, chairs, buffets, chests, gun cabinets, poker table, children's furniture, rocking horse, spinning wheels, and more. Bill of materials exploded drawings assist the woodworker. FURNITURE DESIGNS, INC. \$2.00. *Circle No. 345.*

**COUNTRY FURNITURE PLANS**—Our catalog features 30 designs—from a corner cupboard to an icebox. Our new book on finishing and refinishing will show you how to finish projects like the pros. Also included are various products for the home workshop. Send for our latest catalog (price of catalog deductible from first order). HAMMER-MARK ASSOCIATES. \$1.00. *Circle No. 370.*

**WOODWORKING PLANS**—Catalog of full-size plans printed on heavy paper for toys, gifts, novelties, action windmills, shelves, birdhouses, garden furniture, Dutch windmill, lawn ornaments, old-fashioned lawn swing, jigsaw projects for children, and more. MASTERCRAFT PLANS WEST. \$1.00 (refundable with first order). *Circle No. 390.*

**ANIPUZZLE ONE-OF-A-KIND, CHALLENGING WOODWORKER'S PROJECT**—Plans, full-size assembly drawing, and construction and finishing tips to build multi-piece, three dimensional animal puzzles. Plans for bear and pig puzzles available. These unique puzzles are built from standard dimension lumber and the approximate finished size is 12 3/4" L x 4 1/2" W x 7 3/4" H. Perfect for display or play! Send for price list and descriptions. PKR CORP. Free. *Circle No. 410.*

**PROJECT PLANS FOR WOODWORKERS**—We have expanded our line. By special arrangement with Meredith

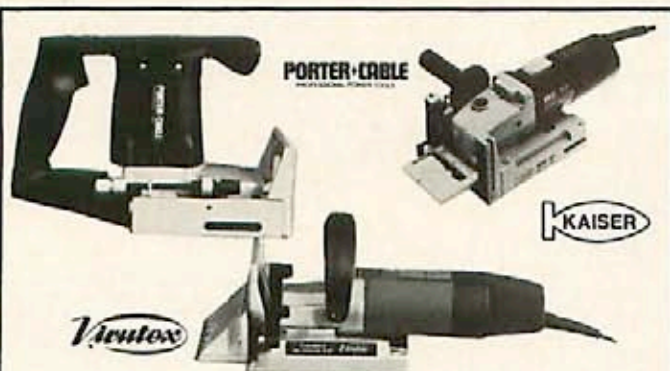

PORTER-CABLE

KAISER

Virutex

## Eliminate your joining hassles with the latest in plate jointers now sale priced

Porter-Cable 555 has a vertical handle with trigger switch, SUPER TORQUE PD Belt drive, rotating depth adjustment, front fence for easy vertical adjustment, miter fence for precise joint matching, dust ejector and carbide tipped blade.

**\$179.95**

Virutex 0-81 Sliding fence adjusts for 45° and 90° joints, and registers from the top of the workpiece. A rotating adjuster quickly selects groove depth for three different plate sizes. Includes carbide-tipped blade and carrying case.

**\$279.00**

Kaiser MINI 3D Top-of-the-line jointer imported exclusively by W.S. Jenks. Powerful AEG 600 watt motor. Non-slip rubber faceplate eliminates machine movement for perfect joints. Guide sets plates at 90° or 45°, and up to 12" from work edge. Steel carrying case.

**\$529.00**

Beechwood Biscuits...\$25.95 Pack of 1000. Sizes 0, 10 or 20.

Send \$2.00 for our complete woodworking catalog  
(Refundable with first order)

**W.S. JENKS & Son**



TOLL-FREE

1-800-638-6405

1933 Montana Ave. NE Washington DC 20002

## IF YOU VALUE YOUR FINGERS..... YOU NEED A **RIPSTRATE®**

The RIPSTRATE holds the work tight against the fence with no hands near the blade. Makes perfect, straight cuts. Wheels lock to prevent kickbacks. *Requires no adjustment for stock width or thickness.*

Over 30,000 now in use in amateur, professional, school, government, military, and corporate maintenance shops.

One year guarantee, 30 day money back trial. \$69 prepaid. Check, M.O., Visa or M.C. Free Brochure.

Write or call our toll free number: 800-421-0256.

Fisher Hill Products 4 Fisher Hill Fitzwilliam, NH 03447  
Dealer inquiries invited.



## CONTROL THE SPEED OF YOUR ROUTER

ROUTE AT THE SPEED THAT GIVES THE BEST RESULTS WITH THE WOOD AND BIT YOU ARE USING!

INTRODUCTORY PRICE  
**\$39.95**  
PLUS \$2.00  
VALUE OVER \$100.00

- LESS TEAR OUT
- STOPS BURNING
- FEED AT COMFORTABLE RATE
- BETTER, SAFER RESULTS WITH LARGE DIAMETER PANEL-RAISING BITS
- LESS WEAR ON BITS
- LESS NOISE AND SOFTER STARTS AT LOWER SPEEDS

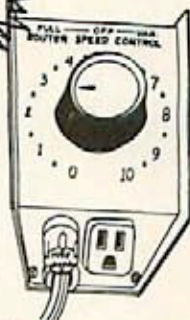

### FEATURES:

- SPEED ADJUSTABLE FROM FULL SPEED TO 0 RPM
- FULL HORSEPOWER AND TORQUE AT ALL SPEEDS
- GO BACK AND FORTH FROM ANY PRE-SET SPEED TO FULL SPEED AT THE FLIP OF A SWITCH
- WORKS WITH ALL ROUTERS 3 HP OR LESS
- 120V 15 AMP
- GIVES YOUR ROUTER A FEATURE ONLY AVAILABLE ON ROUTERS THAT COST OVER \$500.00

**EASY TO USE** — SIMPLY PLUG IN SPEED CONTROL AND PLUG YOUR ROUTER INTO THE SPEED CONTROL — TURN DIAL FOR BEST RESULTS. (SPEED CONTROL HAS A CLIP THAT CAN BE WORN ON YOUR BELT OR HUNG ON WALL OR LEFT LOOSE.)

- REDUCES SPEED ELECTRONICALLY WITHOUT REDUCING TORQUE; ELECTRONIC FEED-BACK MAINTAINS SPEED BY INCREASING VOLTAGE TO MOTOR AS LOAD INCREASES.

To order by Master Charge or Visa Toll Free  
7 Day — 24 Hour Order Service, Call  
1-800-533-9298

or send check to: MLCS, Ltd., P.O. Box 4053D, Rydal, PA 19046

## MAKE BEAUTIFUL RAISED PANEL DOORS . . . WITH YOUR 1/4" ROUTER!

Professional production quality bit makes it quick and easy to produce matching rails and stiles — the panel raising bit with ball bearing guide makes the raised panel perfect every time.

Regular value Over \$150.00

SALE PRICE **\$69.95** FOR COMPLETE SET

ORDER ITEM #054 for 1/4" Shank Set  
(Includes all bits shown)

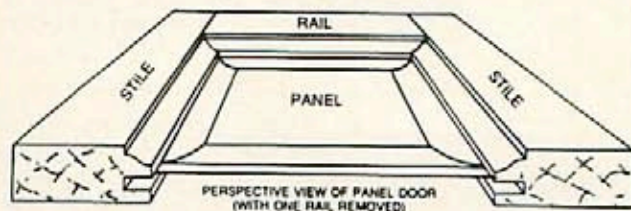

**RAISED PANEL BIT**  
SUPPLIED WITH  
BALL BEARING

2" Large Diameter

CARBIDE TIPPED  
1/4" Shank

**REVERSIBLE  
COMBINATION  
RAIL and STILE BIT**

(For making matching rails and stiles in raised panel doors, etc.)  
Works with stock from  
11/16" to 7/8" thick



CARBIDE TIPPED — TWO FLUTE  
1/4" SHANK  
supplied with Ball Bearing

To order by Mastercard or Visa Toll Free  
7 Day—24 Hour Order Service, Call  
1-800-533-9298

or send check to: MLCS, Ltd., P.O. Box 4053D, Rydal, PA 19046

# LOW COSTS, HIGH QUALITY



**SHAPER**  
Model SK-30SPA .....  
..... Only \$799.00

With 1" x 3/4" spindle, spring hold down 28" x 30" precision ground cast iron table magnetic switch, forward & reverse control two speed, 3HP, table insert, miter gauge.

Optional 1/2" spindle (SK-3012) \$39.00

Model SP-0034 3/4" & 1/2" Shaper \$295.00



**BAND SAW**  
Model SK-20BS .....  
..... Only \$1195.00

20" Width, 11-3/4" High, 2HP, cast iron 45° tilting table, cast iron rip fence, foot brake, dust chute, magnetic switch.

Model BS-1803 .....  
..... Only \$599.00  
18" Width, 11" High, 2HP, 3 speed, cast iron frame, miter gauge, magnetic switch stand, rip fence, 18" x 18" tilting table.

Model BS-1603 .....  
..... Only \$459.00  
16" width, 11" High, 1-1/2HP, 3 speed, cast iron frame, miter gauge, magnetic switch stand, 16" x 16" tilting table. . . Optional rip fence (BE-16EF) \$49.00



**STROKE BELT SANDER**  
Model SK-1500BS .....  
..... Only \$990.00  
60" Working Width, 2HP, dust chute, 59" x 22" sliding table, heavy metal frame.



**DRUM SANDER**  
Model SK-20DS 20" Width .....  
..... Only \$1675.00

Model SK-15DS15" Width .....  
..... Only \$1445.00  
Two different grit precision contract drums. 3HP main motor, 1/4HP auto infeed, magnetic switch, dust chute, cabinet stand, fast high performance sanding.



**POWER FEEDER**  
Model SK-303FD 1HP, 3HP .....  
..... Only \$689.00  
Model SK-301FD 1HP, 1HP .....  
..... Only \$729.00  
Model SK-321FD 1/4 HP, 1HP .....  
..... Only \$449.00  
Three feed rollers, 4 speed, forward and reverse switch, powerful feeding, operated in any position.

Dust Collectors, Table Saws, Jointers, Planers, Belt & Disc Sanders, Jig Saws, 5 in 1 Woodworking Center, Wood Lathes, Sanding Belts & Papers...  
Many Other Fine Woodworking Machines

Please Check To See Free Delivery Items, All Other Prices Are F.O.B. Los Angeles. Offer Up to 40% Trucking Freight Discount.

\* One Year Free Parts Warranty.

\* We Specialize in Customer Satisfaction.

Free Catalogue. Don't Miss It! Write or Call Now! (818) 350-1096



**Lobo Power Tools**

10922 Klingerman St. #3  
S. El Monte, CA 91733

## SQUARE DRIVE SCREWS



- "Cam-Out" is a Thing of the Past
- Heat Treated for Strength
- Deep Thread for Holding Power

Special: 100 each of the following sizes, plus a power driver bit and hand driver. Optional set of 6 heavy duty bins (not shown) stack or wall mount.

Size	Length	\$ W/O Bins	\$ W/ Bins
#6x 1/2, 5/8, 3/4, 1, 1-1/4, 1-1/2		13.35	17.35
#8x 3/4, 1, 1-1/4, 1-1/2, 2, 2-1/2		16.65	20.95
#10x 1-1/4, 1-3/4, 2, 2-1/4, 2-1/2, 3		23.65	27.90

	Order Total	S & H
Shipping & Handling	\$ 0.1 to \$20.00	\$3.00
(Cont. U.S. Only)	\$20.01 to \$50.00	\$4.50
Va. Res. add 4.5% Tax	\$50.01 to \$80.00	\$6.00
	Over \$80.00	\$7.50

**McFEELY** Hardwoods and Lumber  
P.O. Box 3 • 712 12th Street  
Lynchburg • Virginia • 24505  
1-800-443-7937 • In Va. 1-800-542-2023

Over 1,000  
Carving Patterns  
Starting At  
**\$1.75**



Send for your new 80-page Hummul catalog, featuring the entire G. Stiller pattern library. Also reference books galore on carving, woodworking and wildfowl. Full line of carving tools & art supplies.

**C. J. Hummul Co.**

404 Brookletts Avenue  
P.O. Box 1849, Dept. WD  
Easton, MD 21601  
(301) 820-8760

Corp. and Better Homes and Gardens\* magazine, we have added a series of plans originally designed by David Ashe. These plans have appeared in Better Homes and Gardens\* magazine and are a proven favorite among woodworkers across the country. All of our plans are designed using readily available materials, keeping in mind standard sizes of lumber. Instructions are clear and concise, and occasionally include tips that will make your job easier. Order our catalog now and get started! THE WORKSHOP BLUE-PRINT CO. \$2.00. Circle No. 485.

## LUMBER

**QUALITY EXOTIC LUMBER/TURNING WOODS**—We offer a comprehensive selection of fine quality exotic woods: Ebony, Kingwood, Tulipwood, Snakewood, African Blackwood, Cocobolo, Bloodwood, Figured Maple, Spaulded Maple, Padauk, etc. Unique and unusual turning woods and burls are also available. Send for catalog. BEREA HARDWOODS. \$1.00. Circle No. 510.

**WOODWORKERS! HELP CELEBRATE OUR 50TH YEAR OF SERVICE** — Send for our new 148-page Craftsman 1987-88 Catalog #54. 42 varieties of choice hardwoods 1/84 in. to 4-in. thickness. Fine hardwood veneers, tools, moldings, trim, marquetry inlays, upholstery and lamp supplies, finishes, clock kits, and hard-to-find hardware. 4,000-plus items for your projects. CRAFTSMAN WOOD SERVICE CO. \$1.00. Circle No. 520.

**DO-IT-YOURSELF LUMBER DRYING** — This 22-page booklet *Kiln Chamber Construction Guide and Operation Manual* is designed for the individual wishing to dry his own lumber with a minimum investment of money, time, and space. Included are principles of dehumidification lumber drying, selection of which dryer is best for you, and kiln chamber plans and construction information. Also you will receive a questionnaire you can fill out and return. Once completed and returned you will receive a free evaluation of your drying needs including investment considerations, operating costs, and payback. EBAC LUMBER DRYERS. \$10.00. Circle No. 525.

**EdLco — WE KNOW OUR LUMBER** — Educational Lumber Company is pleased to offer you our new catalog, stacked with excellent buys at delivered prices. Available to you are over 21 species of imported as well as domestic hardwoods, softwoods, turnings, shorts, veneers. All our lumber is kiln dried. As school shop suppliers for 35 years, we know our lumber. It is top-grade. Send today and receive your BONUS GIFT: 4 new furniture designs. EDUCATIONAL LUMBER CO., Inc. \$2.00. Circle No. 530.

**RARE AND EXOTIC TROPICAL HARDWOODS**—for the serious turner and woodworker. Largest commercial selection of hard-to-find heavyweight dimensions in the U.S. Includes rare Macassar Ebony as well as Bocote, Brazilwood, Cocobolo, Primavera, Courbaril, Paldao, Lignum Vitae, Ziricote, Kingwood, and others. Turning Stock and some lumber. Wholesale and retail. Best prices from Direct Importer. Color catalogue with prices, description and inventory. ART EISENBRAND, INC. \$1.00 (refundable). Circle No. 535.

**THIN LUMBER** — Approximately 20 species of thin lumber, widths vary up to 3/4-in. Kiln dried. Turning squares. Send for price list. HARDWOODS OF ILLINOIS. 50c. Circle No. 545.

**LARGEST SELECTION EXOTIC HARD AND SOFT WOODS**—When in Florida come see us or send for our price list of Florida's largest and most unbelievable selection of exotic imported and native hard and soft woods, table slabs and veneers. We also stock Ashley Isles carving tools, Watco danish oil finishes, and a complete line of Deft products. HENEGAN'S WOODSHED. \$1.00. Circle No. 547.

**RARE IMPORTED EXOTIC AND DOMESTIC HARDWOODS**—The world renowned Martin Guitar Co. sells wholesale and retail exotic wood (4/4, 6/4, 8/4) and sawn veneers (1/4" & 1/2" Sanded Stock), plus guitar parts, kits, accessories and second quality guitars. Send for catalog. SAWMILL/WOODWORKER'S DREAM. \$1.00. Circle No. 578.

## GENERAL WOODWORKING CATALOGS

**EVERYTHING FOR THE WOODWORKER** — Wide selection of woodworking supplies, including candle cups and shaker pegs. Price of catalog is refundable with order. BENNY'S WOODWORKS. \$1.00. Circle No. 810.

**FINE WOODS AND WOODWORKING SUPPLIES** — Constantine's catalog for woodworkers offers 116 pages, many in full color, of 150 kinds of veneers, over 250 sizes of fine cabinet woods. Decorative inlays, moldings, cabinet hardware, caning materials. Specialty woodworking tools, wood finishes, plans and books. Serving the woodworker since 1812. ALBERT CONSTANTINE AND SON, INC. \$1.00. Circle No. 820.

**FREE WOODWORKING CATALOG**—Buy planers, table saws, scroll saws. Direct from the factory and save. Plus portable tools, hand tools and accessories. Send for free catalog. FOLEY-BELSAW CO. Free. Circle No. 852.

**MASTER TOOLS CATALOG**—1986-87 212-page master woodworking tools catalog. Full line of the best hand tools, power tools & accessories, machinery, glues, finishing supplies, and much more. Hundreds of books included. 212 pages. All four-color. Lots of technical information. GARRETT WADE CO. \$4.00. Circle No. 855.

**WOODWORKING MACHINERY CATALOG** — Planers, jointers, tablesaws, shapers, drill presses, sanders and much, much more. Buy direct from importer at super low prices. Full color catalog. GRIZZLY IMPORTS, INC. Free. Circle No. 860.

**PLANERS** — Heavy duty 15x6 in. planers with 2 hp. single-phase motors. Other woodworking equipment at low, low prices. Send for full color catalog. GRIZZLY IMPORTS, INC. Free. Circle No. 861.

**DUST COLLECTORS** — for the small/medium size shop. Capable of handling from 1 to 3 machines at the same time. Priced within the home shop budget, yet capable of handling cabinet shopwork. Other woodworking machinery and tools — low prices. Send for full color catalog. GRIZZLY IMPORTS, INC. Free. Circle No. 862.

**WOODWORKING TOOLS, MACHINERY, & SUPPLIES** — W. S. Jenks & Son's new 128 page source book is packed with a full range of tools for the serious woodworker, from hand tools, to portable power tools, to woodworking machinery. Includes many imported and hard to find tools, from the best manufacturers at the most competitive prices. Send for catalog. W. S. JENKS & SON. \$2.00 (refundable with first order). Circle No. 877.

**LEICHTUNG WORKSHOPS** — Discover fine woodworking and cabinet-making tools and hardware in our 102-page color catalog. For example: Our exclusively-designed 4-way Equi-Pressure Clamp, Cabinet Maker's Vice, plus Brad-Point and Forstner Bits. LEICHTUNG WORKSHOPS. \$1.00. Circle No. 878.

**WOODWORKING TOOL CATALOGS** — R.A. Ness & Co., the Woodworkers Emporium, offers a 2-year subscription, a total of eight huge sale catalogs. Thousands of industrial quality items — machinery, hand tools, portable electric tools, and supplies — are featured at super sale prices. The fee is refundable with purchase. R. A. NESS & CO., the Woodworkers Emporium. \$4.00. Circle No. 900.

**RENOVATOR'S SUPPLY** — America's Number One source for elegant, old-style reproductions at factory-direct prices! 46 colorful pages of door, window and cabinet hardware; lighting and bathroom fixtures; and gifts for the home in brass, oak, porcelain and wrought iron. RENOVATOR'S SUPPLY. \$3.00. Circle No. 915.

**THE SOURCE, FOR ALL YOUR CABINET MAKING NEEDS** — New 170-page catalog of fine hand and power tools for cabinet makers and serious woodworkers. Features 3 sections on hardware, supplies, and cutting tools. This catalog takes the mystery out of using European hardware. A must reference for the woodworker. THE SOURCE. \$3.00. Circle No. 935.

**TOOL CITY CATALOG HAS THE TOOL OR ACCESSORY FOR YOU** — The 500-page 1987-88 Tool City Catalog is the most complete mail order catalog. It features a comprehensive selection of stationary & portable power tools; hand tools, tool accessories, hardware parts, woodworking books, and shop equipment. Priced to save you money in all categories. TOOL CITY. \$5.00. Circle No. 945.

**FREE CATALOG** — For woodworkers and carvers—it's one of the best sources for quality woodworking and carving tools. You'll find everything from bit braces to wood borers, from saws to sharpening stones. Every product is sold postage-paid and satisfaction guaranteed. WOODCRAFT SUPPLY CORP. Free Circle No. 955.

**THE WOODWORKERS STORE** — A hundred and fourteen pages of hardwoods, veneers, wood parts, specialty hardware, kitchen accessories, finishing supplies, tools, books, and plans. Orders shipped within 48 hours. Customer satisfaction guaranteed. WOODWORKERS STORE. \$1.00. Circle No. 965.

**WOODWORKERS SUPPLY** — Offers high quality tools and supplies for skilled, amateur, and professional woodworkers. Our complete catalog includes machinery, hand tools, plans, router bits, shaper cutters, wood specialties, and more. For your two year subscription send to WOODWORKERS SUPPLY OF NEW MEXICO. Free. Circle No. 975.

## KITS

**FACTORY DIRECT GRANDFATHER CLOCKS** — Build a magnificent grandfather clock kit from world's largest manufacturer. Clocks are made of solid 3/4" hardwoods, primarily walnut, oak and cherry. West German-made solid brass movements. Send for color catalog showing our selection of grandfather clocks, furniture and home accent pieces. Buy direct from factory and save. EMPEROR CLOCK CO. \$1.00. Circle No. 1030.

**QUALITY CLOCK KITS AND PLANS** — Handmade and semi-assembled of carefully selected 3/4 in. cherry, oak, or walnut with beveled glass. Or build from "scratch" using our detailed plans and trim pieces. Choice of quality movements. Established in 1916. KUEMPEL CHIME CLOCK WORKS. \$2.00. Circle No. 1050.

**WOODEN SHIP MODELS** — Discover the world's hobby — building fine-quality, historic wooden ship models. Described are true-to-life scale replicas, lifelike in every detail. A 64-page color catalog introduces you to this fascinating hobby. MODEL EXPO, INC. \$3.00 (Refunded with first order). Circle No. 1060.

**CLOCK COMPONENTS** — Quartz movements of all types. Quartz, Westminster chime, fit-ups, bezel, and flat dials. Hand-painted clock dials with kits for you to assemble and sell. Clock hardware and hundreds of items to build clocks. Send for catalog and sales plan. NEWPORT ENTERPRISES. \$1.00. Circle No. 1065.

# FREE SANDING BELTS

## DIRECT FROM THE MANUFACTURER

GET SIX FREE BELTS FOR EACH DOZEN ORDERED. All belts are aluminum oxide first quality. Our electronic presses make smooth bump-free splices.

Check your size and how many dozen. We will ship assorted grits unless otherwise specified.

- 1" x 30" — \$13.70/doz.
- 1" x 42" — 13.75/doz.
- 1" x 44" — 13.80/doz.
- 3" x 18" — 14.75/doz.
- 3" x 21" — 15.25/doz.
- 3" x 23 1/4" — 15.70/doz.
- 3" x 24" — 15.75/doz.
- 3" x 27" — 16.25/doz.
- 4" x 21 1/4" — 17.25/doz.
- 4" x 24" — 18.25/doz.
- 4" x 36" — 21.95/doz.
- 6" x 48" — 27.95/1/2 doz. (3 FREE)

### 9" x 11" Paper Sheets

A/O Cabinet Paper		No Load Finishing Paper	
50/pk.	100/pk.	50/pk.	100/pk.
40-D <input type="checkbox"/> \$17/pk	<input type="checkbox"/> \$31/pk	180-A <input type="checkbox"/> \$11/pk	<input type="checkbox"/> \$19/pk
50-D <input type="checkbox"/> 16/pk	<input type="checkbox"/> 28/pk	220-A <input type="checkbox"/> 11/pk	<input type="checkbox"/> 19/pk
60-D <input type="checkbox"/> 15/pk	<input type="checkbox"/> 26/pk	280-A <input type="checkbox"/> 11/pk	<input type="checkbox"/> 19/pk
80-D <input type="checkbox"/> 14/pk	<input type="checkbox"/> 24/pk	320-A <input type="checkbox"/> 11/pk	<input type="checkbox"/> 19/pk
100-C <input type="checkbox"/> 13/pk	<input type="checkbox"/> 22/pk	400-A <input type="checkbox"/> 11/pk	<input type="checkbox"/> 19/pk
120-C <input type="checkbox"/> 13/pk	<input type="checkbox"/> 22/pk	<b>Wet or Dry S/C Paper</b>	
150-C <input type="checkbox"/> 13/pk	<input type="checkbox"/> 22/pk	50/pk.	100/pk.

**NEW ITEM!**  
 BELT CLEANING STICK - \$6.95

Other size belts on request.

Shipping Charges - Under \$35 add \$2.50; \$35 or more add \$4.00—PA residents add 6% sales tax.

- Check or Money Order.
- MasterCard  VISA Exp. Date \_\_\_\_\_

Acct. # \_\_\_\_\_

Name \_\_\_\_\_

Address \_\_\_\_\_

City, State & Zip \_\_\_\_\_

**CALL TOLL FREE**  
1-800-428-2222

PA Only - 1-800-222-2292

**INDUSTRIAL ABRASIVES CO.**  
643 North Eighth Street  
Reading, PA 19603

## FULL SIZE Woodcraft PATTERNS

SIMPLE TO MAKE \* FUN \* PROFITABLE

- 125 pattern packet PLUS "Shop Secrets"
- Over 50 "Folk Art" patterns PLUS projects
- 6 enjoyable "Wind-Action" whirligigs
- 100 yard ornaments, animals, birds and more
- 27 toy cars, trucks, train, ferry and more!
- 17 "Show Stoppers" - craft show best sellers

Send \$7.00 per blueprint packet or choose any 3 FOR ONLY \$14.00.

Fast Service • Satisfaction Guaranteed!

**ACCENTS** Dept. MA78, Box 7387, Gorham, NH 03867

Catalog of 1000 patterns - \$1.00 (Free with order)

## MAKE MONEY WITH FURNITURE RESTORATION

SAFE, DEPENDABLE, EASY stripping and refinishing systems and products, featuring HYDROCOTE™ water-base finishes.

## AMITY

Quality Restoration Systems

Wisconsin: 608-837-8484  
Nationwide: 800-334-4259

## Sell Mason Sport & Work Boots and earn instant commission



BE A MASON DEALER and sell our rugged, quality-made sport and work boots to your friends and neighbors. Earn instant cash commissions from \$10.00 to \$20.00 per hour. Absolutely no investment required. All you do is show the full-color Mason catalog to your customers. Let them select from over 400 styles of footwear for men and women. Write for details.

Send for FREE Sales Kit, Mason Shoe Mfg. Co. Chippewa Falls, WI 54774 or call Toll Free 1-800-826-7030, Ext. F-769.

**MASON SHOE MFG. CO., Dept. F-769**  
Chippewa Falls, WI 54774

Please rush giant FREE catalog & dealer starter kit to:

NAME \_\_\_\_\_  
ADDRESS \_\_\_\_\_  
CITY \_\_\_\_\_  
STATE \_\_\_\_\_ ZIP \_\_\_\_\_



# This isn't what you think !



You're probably looking at this machine thinking to yourself, "Oh, it's one of those all in one tools that takes forever to set-up and really isn't practical." Think again. This is the Toolmax T310. The T310 is a quality woodworking tool that requires almost no set-up and meets almost any commercial quality specification for individual equipment. The T310 has 4 Separate motors which power the 10" Table Saw, 1" Spindle Shaper, 12" Jointer, 12" Planer, and Mortise.



**TOOLMAX**  
P.O. BOX 751323  
HOUSTON, TX 77275-1323  
1-800-535-4788 USA 1-800-325-8330 CA

## TOTALLY NEW MASS PRODUCTION FURNITURE REFINISHING



**MasterFinishers Systems™** is a revolutionary new concept of mass production furniture refinishing. It is a system that has been invented to replace the slow, tedious, exacting work of old-time craftsmen who worked for hours and sometimes days to remove old finishes from furniture by hand. That process is now done automatically with the **MasterFinisher System™** chamber. Therefore, anyone who can flick a switch and has the ability to, say wash a car can operate a **MasterFinishers Furniture Refinishing Factory™**, with tremendous profit potential.

The **MasterFinishers System™** has been so successful for shop owner and founder Al Schmitz of the Detroit area. Personal paychecks many weeks exceeded \$3,000 and some months of 1986 in excess of \$10,000 in quality furniture refinishing from this **MasterFinishers System™**.

If you've ever considered starting your own business and you meet our criteria, the **MasterFinishers System™** is the ultimate in rewarding and profitable business in America today!!

Call Collect for Information (313) 338-1630

# USED ROUTER BITS

SOMETHING NEW YOU ASK ?  
NOT REALLY.



BYROM Router Bits have been used by professional woodworkers for over 40 years. The reason is simple. . .  
**QUALITY!**

You can count on our dealers, too. For responsive service, fast delivery, competitive pricing and total support. Send \$3.00 (get \$4 dealer refundable coupon), for our NEW 1988 CATALOG featuring over 670 router bits. See why BYROM is "The World's Router Bit Source"  
**DEALER INQUIRIES INVITED**

**BYROM INTERNATIONAL**  
P.O. Box 246, DEPT. BW8 Chardon, Ohio 44024

**SOLID WOOD CLOCK KITS** — Full-color catalog of beautiful, easy-to-make clocks. All solid wood with solid brass movements. All parts hand cut for perfect assembly, even by beginners. VIKING CLOCK CO. Free. Circle No. 1090.

## PUBLICATIONS

**DISCOVER GUILD OF MASTER CRAFTSMAN PUBLICATIONS**—Unique books and magazines for those who enjoy working wood. Plans and projects, handbooks on tools and techniques, guides for woodturners and woodcarvers, etc. Send for our free catalogue of books collected from around the world. Details of The Society of Wood Craftsmen sent with every catalogue. GUILD OF MASTER CRAFTSMAN PUBLICATIONS. Free. Circle No. 1125.

**WOOD CARVING** — You can obtain information on learning woodcarving by sending for our literature. The offer includes sample copy of *The Mallet Magazine* and two lesson sheets on carving. NATIONAL CARVERS MUSEUM. \$2.00. Circle No. 1140.

## SHOP ACCESSORIES

**RIPSTRATE SAVES FINGERS** — for table saw and radial arm saw users. Brochure describes the RIPSTRATE and shows how it gives straighter cuts, speeds, the work, prevents kickbacks, and keeps hands away from the blade. FISHER HILL PRODUCTS. 25c. Circle No. 1235.

**EASY DOES IT** — with HTC'S power tool accessories. Discover many unique items, designed only with you, the dedicated woodworker, in mind. Make your machinery safer, increase the working area of your shop and accomplish nearly impossible tasks easily, quickly, accurately. Full-line catalog and price list. HTC PRODUCTS, INC. \$1.00. Circle No. 1245.

**BUY YOUR SANDING BELTS DIRECT FROM THE MANUFACTURER** — Industrial Abrasives is the company that gives you six free belts with every dozen ordered. But, sanding belts are not the only product we have to offer. In our catalog you will find many specialty items not readily available in your hardware store. Price of catalog refunded with first order. INDUSTRIAL ABRASIVES CO. \$1.00. Circle No. 1248.

**WOOD MOISTURE METER** — Avoid moisture problems such as cracking, warping, splitting, delamination etc. by using a moisture meter, as described in the latest brochure. Moisture Meter Mini-Ligno is designed for serious hobbyists and woodworkers. Attachments for depth measurements and remote reading during air and kiln drying are available. Available Moisture Range 6-20%, 6-36% or 4-30%, 4-60%. Catalog describes complete line of moisture meters. LIGNOMAT USA, LTD. Free. Circle No. 1250.

**ROUTER SPEED CONTROL**—Reduces speed electronically without reducing torque. Route at the speed that gives best results with the wood and bit you are using. Speed adjustable from full speed to 0 RPM. Less tear out—stops burning—less wear on bits—easy to use. Send today for information. MLCS LTD. Free. Circle No. 1251.

**DRUM SURFACE/THICKNESS SANDER** — Now a radial arm saw accessory providing inexpensive, space saving surface/thickness sanding capability. Product features include: instant attachments to all radial saws, 44 in. sanding width, sanding drum with sandpaper fasteners, and vacuum dust collection. Send for information. PERFORMAX PRODUCTS. \$1.00. Circle No. 1253.

**PROFESSIONAL SANDING EQUIPMENT** — Sand-Rite's Brush Head sands mouldings and intricate carvings without losing detail or shape of the part. Pneumatic drum gives quick and excellent results on contoured shaped parts. Everything we sell is industrial quality. Send for brochure. SAND-RITE. Free. Circle No. 1275.

## BITS, BLADES CUTTING TOOLS

**OVER 600 ROUTER BITS**—are now available. The all-new 1988 Byrom catalog features 1/4" to 3/4" shank in high speed steel, carbide and carbide tip. Over 20 pages, 80 new items, and over 80 technical drawings. "Industrial Information Kit" includes catalog, industrial price list, name of nearest dealer, and 2-yr. subscription to special sales and new product introductions. Dealer inquiries invited. BYROM INTERNATIONAL. \$3.00 (refundable). Circle No. 1308.

**CARBIDE TIPPED ROUTER BITS AND SHAPER CUTTERS** — Over 400 router bits and shaper cutters displayed in catalog featuring 6 piece cabinet sets, 3 piece 1/2-in. shank router bit panel raising system, and 3 wing industrial shaper cutters. An outstanding selection of top quality shaper cutters available in 1/2-in. - 1 1/4-in. bore, and router bits offered in 1/4-in. and 1/2-in. shank at the industry's best factory direct prices. CASCADE PRECISION TOOL CO. \$1.00. Circle No. 1315.

**THE 16-PAGE COLOR**—Choice Precision Tool Catalog offers 350 carbide router bits available in 1/4" or 1/2" shanks. Also included are 48 carbide shaper cutters. Router table and router accessories are available as well. Send today for your catalog. CHOICE PRECISION TOOL. 50c. Circle No. 1317.

## PATTERNS \$100

SAME SIZE OUTLINE DRAWINGS  
NO ENLARGING NECESSARY  
TRACE & CREATE

FREE CATALOG WITH ORDER

SEND THIS AD & \$1.00 FOR EACH PATTERN  
(Plus 50¢ postage per order) OFFER EXPIRES 12/31/88  
DESIGN GROUP, Box 514 J.J. Miller Place, NY 11764

### Thin HARDWOOD Priced Right

Clear - Kiln Dried - 2 Sides Surfaced  
3" to 10" Widths - 3' to 7' Lengths  
20 sq. ft. packs - Random Widths & lengths

	3"	4"	6"	8"	10"
Red Oak	\$32	\$36	\$40	\$40	\$60
Cherry	36	44	48	48	66
Walnut	36	44	48	48	66

Above price includes UPS delivery in continental USA.  
To order circle dollar amount above.

#### BASSWOOD for Carvers KS 54S

3' x 3' x 36"	\$5.70	4' x 6' x 36"	\$15.00
4' x 4' x 18"	\$5.00	4' x 8' x 18"	\$10.00
4' x 4' x 36"	\$10.00	4' x 3' x 36"	\$20.00
4' x 6' x 18"	\$7.50	4' x 10' x 72"	\$50.00

Minimum order basswood \$40.00 - free UPS delivery.  
Circle sizes desired - Send order w/check or money order.

### HARDWOODS OF ILLINOIS

R.R. 4, Box 618 • Mt Vernon, IL 62864

### Thomas Clamp Assembly Aid

ADJUSTABLE ASSEMBLY CLAMP NUMEROUS USES  
NATURAL RUBBER STRAP ZINC PLATED STEEL  
HARDWARE STAINLESS STEEL SPRING  
WHAT EVERY WOODWORKING SHOP NEEDS

MADE IN USA	EACH	FOR 6
4 1/2" TO 30" STRAP CLAMP	4.95	26.00
4 1/2" TO 45" STRAP CLAMP	6.45	28.00
4 1/2" TO 60" STRAP CLAMP	5.95	30.00
2 EACH OF ABOVE		28.00
SET OF 2 HOOKS	.95	5.00
POSTAGE & HANDLING	2.00	2.00

ORDER FROM:  
THOMAS CLAMP CO., BOX 237, ARAB, AL 35016

### QUARTZ CHIME CLOCK MOVEMENTS

Large selection of Westminster and strike movements. Hand painted dials with kits for home assembly. Quartz fitups and LCD movements. Numbers, letters, hardware. Hundreds of items to build clocks.

Send \$1.00 for Catalog and Sales Plan.

### NEWPORT ENTERPRISES INC.

2313 W. Burbank Blvd.  
Burbank, California 91506

### BUILD THIS BLANKET CHEST

(17"D x 18"H x 36"W)

Order plans for this charming reproduction

This beauty will be admired by family and friends alike—especially when they see the great storage space that you've gained for your prized quilts and blankets.

The chest lid is hinged, and a pair of shallow drawers below add an authentic touch.

For complete building plans, including the know-how for duplicating the beautiful antiques, painted finish, send \$12 ppd. (Canadian residents please remit postal money order in US funds) to:

### HAMMERMARK ASSOCIATES

Box 201-ABW8, Floral Park, NY 11002.  
Catalog available for \$1.00 (refundable).  
Prices effective through 12/31/88.

## WOODWORKERS

Save on Wood - Tools - Supplies!

OVER 4000 ITEMS

Send for New 1987 148 Page Money Saving CATALOG

Finest Dimensioned HARDWOODS and Quality VENEERS

42 Varieties 1/64" to 4" Thickness

Fast service on choice kiln dried Wood and Veneers, Moldings, Trim, Hand and Power Tools, Lamp Parts, Upholstery Supplies, Clock Movements and Kits, Hard-to-Find Hardware, Finishing Materials, Books... over 4000 items in stock! Craftsman—Woodworker's best friend.

FREE with Catalog  
-\$3.00 Discount Coupon  
Good on First Order

### CRAFTSMAN WOOD SERVICE

Dept. WM-88, 1735 W. Cortland Ct., Addison, IL 60101  
Please enclose \$1.00 to help pay postage and handling.

### World's Best Machinery Value

KITY  
WOODWORKING  
MACHINES

Distributed  
in the U.S.  
Exclusively by

FARRIS  
MACHINERY

Not the Cheapest - Not the Most Expensive - Simply the Most for your money — — Guaranteed!

Call or Write for information

Name \_\_\_\_\_  
Address \_\_\_\_\_  
City \_\_\_\_\_ State \_\_\_\_\_  
Zip \_\_\_\_\_ Phone \_\_\_\_\_

- 10" Table Saw
- 3-speed Shaper
- Slot Mortiser
- K-5 Combination
- Band Saw
- Jointer-planer
- Lathe/Duplicator
- KDD Combination

### 1-800-USA-KITY

4315 Keystone Drive • Blue Springs, MO 64015

## THE FINE TOOL JOURNAL

ANTIQUE AND OBSOLETE TOOLS  
BOOKS ON TOOLS  
ABSENTEE TOOL AUCTIONS

6 issues per year — \$15.00

Sample \$3.50 • Book List — S.A.S.E  
to:

### FINE TOOL JOURNAL

RD # 2, Box 245B  
Pittsford, VT 05763

### DO IT YOURSELF SMALL DRY KILNS... AMERICA'S FAVORITE!

Kiln Dry Your Own Wood...  
Now As Little As 50 Board Feet  
Per Month With

### EBAC'S NEW TR100 WOOD DRYER!!

- Smaller design for the hobbyist • Simple Operation
- Very low running costs • Fast Payback!
- 6% - 8% moisture content kiln dried wood
- Kiln size as small as 2 1/2' x 2 1/2' x 7 1/2'
- DRYERS UNDER \$1000 • MADE IN THE USA

Call or Send for FREE information: EBAC,  
8432 E 33rd St. Dept. BH, Indpls. IN 46226  
Call toll free 800-433-9011

Name \_\_\_\_\_  
Address \_\_\_\_\_  
City \_\_\_\_\_ State \_\_\_\_\_  
Zip \_\_\_\_\_ Phone \_\_\_\_\_  
 small dryer info  larger info

## NEW! 3-SPEED STROKE SANDER

FREE 30 DAY TRIAL

SAVES TIME... SAVES MONEY!  
Experts agree... a wide-belt stroke sander is the "tool of choice" for panel and long edge sanding... yet this same versatile machine will also handle an endless variety of smaller pieces. In fact, this one low-cost machine can soon become the "sanding center" for your entire shop!

SEND TODAY FOR FREE FACTS!

You'll be amazed at the speed and absolute control this machine can bring to all your sanding projects.

The Model 800 features 3 built-in speeds, a large, 24" x 48" table with automatic elevation and lever-action, traveling pressure plate. Open-ended design accommodates any length of material. Long-lasting belts are 6" x 156".

Designed for years of continuous service, the compact Model 800 (floor space needed is only 3.4' x 6.5') is also ideal for the serious home woodworker!

PHONE TOLL FREE  
1-800-538-4200 EXT. 2125

WOODMASTER TOOLS, DEPT. YW05  
2908 Oak, Kansas City, MO 64108

YES! Please rush my FREE INFORMATION KIT and details on your 30-Day Free Trial Guarantee.

Name \_\_\_\_\_  
Address \_\_\_\_\_  
City \_\_\_\_\_ State \_\_\_\_\_ Zip \_\_\_\_\_

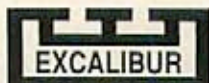

A Cut Above  
Lesser Saw Fences...

## The Excalibur T-Slot Saw Fence

When choosing  
investments,  
cheaper isn't better...  
better  
is  
better!

RATED #1 BY  
FINE WOODWORKING  
JAN. 1988

...and there's a  
good reason why

Like any other precision tool, a saw fence is an investment. And when it comes to choosing investments, cheaper isn't better. Better is better. So T-Slot owners rightfully count themselves among the ranks of perfectionists who have high standards and are willing to pay a bit more to maintain them. A better saw fence...and a more accurate one. The Excalibur T-Slot saw fence will convert your table saw into a precision wood-cutting machine.

EXCALIBUR  
MACHINE & TOOL  
COMPANY

U. S. A.  
210 Eighth St. South  
Lewiston, NY 14092  
Toll Free: 1-800-387-9789

CANADA  
3341 Kennedy Rd., #7  
Scarsborough, Ont. M1V 2J9  
(416) 291-8190

- ✓ Quick installation on General, Rockwell, Delta, Powermatic. Customers used most other saws
- ✓ The necessity of always having to measure from the saw blade to the fence has been eliminated
- ✓ Ripping of large stock is quickly accomplished
- ✓ Built-in scale and adjustable half-inch cursor for precise cuts every time
- ✓ Manufactured from high-quality materials
- ✓ Positive front and rear end locking
- ✓ Easy parallelism adjustment
- ✓ Efficient assembly for tipping to right or left of saw blade — plus many more exciting features, including the Ultimate Guarantee.

For the name of your nearest Dealer, please Phone 1-800-387-9789

Call 1-800-233-SAWS for a copy  
of DML's quarterly promotions and  
your closest  
DML distributor.



DML, Inc., 1350 S. 15th St., Louisville, KY 40210

**INDUSTRIAL QUALITY CUTTING TOOLS** — Three large, colorful wall posters keep DML's huge line of carbide-tipped cutting tools close at hand for easy reference. Separate posters for saw blades, shaper heads (with diagrams of each cut), and router bits. Each features graphic displays of the tools, capabilities, and sizes. DML, INC. \$3.00. Circle No. 1319.

**WOODWORKING TOOLS** — Freud provides the finest in hand tools, carbide cutting tools, and hand held power tools. From drills and sanders to carbide saw blades and router bits. Send for catalog. FREUD. \$1.00. Circle No. 1321.

**PRODUCTION QUALITY CARBIDE TIPPED ROUTER BITS** — MLCS Ltd. offers a full line of professional production quality carbide tipped router bits at 50-70% lower than retail prices. We sell through the mail and only direct to craftsmen. Send today for information. MLCS LTD. Free. Circle No. 1350.

## HARDWARE/WOOD PARTS

**ELIMINATE THE GUESSWORK**—and inconvenience of buying random size lumber. Our new wood parts mail order program allows you to purchase your kiln dried wood from a complete selection of lengths, widths, and thicknesses, including turning squares and glued up panels, in many fine cabinet woods. To complete the program we have available drawersides, carved Queen Anne legs, turned legs, and complete Queen Anne chairs ready to assemble. AOAMS WOOD PRODUCTS. 50c. Circle No. 1401.

**SPECIALTY WOODEN PARTS** — Hundreds of turned wooden parts in maple, birch, oak, cherry, walnut, and colors for toys, furniture, games, and crafts. Included are Shaker pegs, mug pegs, gallery spindles, wheels, axles, balls, finials, smokestacks, plugs, buttons, people, pegs, cargo, game pieces, knobs, handles, candle cups, stool legs. Bulk prices available. Send for color catalog subscription. CHERRY TREE TOYS, INC. \$1.00. Circle No. 1415.

**HARDWARE CATALOG**—A unique 64-page catalog of the very finest in classic, traditional solid brass cabinet hardware. All of British or No. American manufacture. Double & single post handles, knobs, escutcheons, standard & specialty hinges, box hardware, brass screws, castors, latches, catches, locks, and more. GARRETT WADE CO. \$2.00. Circle No. 1427.

**SQUARE DRIVE SCREWS**—Once you try them, you will never want to use anything else! The square drive recess virtually eliminates work-damaging driver bit "cam-out," the "lo-rot" thread design results in superior holding power; and they are heat treated for strength. Sizes from # 6 x 1/2" to # 12 x 3", with brass plated, solid brass, and zinc plated available. Quantity discounts. Send for literature. McFEELY HARDWOODS. 25c. Circle No. 1450.

**WOODWORKER'S SPECIALTIES** — 48-page catalog of plans and hard-to-find hardware for woodworkers. Dozens of wood toy plans & accessories, including wood wheels, fenders & decals. Also wood turnings, brass hardware, canister liners, stencil supplies, & wood cutouts. MEISEL HARDWARE SPECIALTIES. \$1.00. Circle No. 1455.

**WOOD TOY PATTERNS** — Patterns for all ages including children's patterns and executive toys. New catalog has many new patterns to choose from including parts and wheels. Send for new catalog and receive a coupon for free wheels and axle pegs. TOYS AND JOYS. \$1.00. Circle No. 1480.

**QUALITY AMERICAN-MADE WOOD TURNINGS** — such as shaker pegs, spindles, toy wheels, toy parts, craft items, and dowel rods in birch, oak, walnut, and cherry. Send for complete 32-page catalog. WOODWORKS. \$1.00. Circle No. 1490.

## INCOME OPPORTUNITIES

**AMITY, NATION'S #1 QUALITY FURNITURE RESTORATION CO. SINCE 1971**—New 1988 product catalog featuring: Complete restoration systems, Hydrocote non-flammable water based stains and finishes, Permafuse repair products, stripping solvents, chemicals and supplies. Amity 1-2-3 wipe-on finishes and much more. Regional workshops in your area. AMITY. \$1.00. Circle No. 1605.

**START SMALL BUSINESS WITH NEW SCROLL SAW** — The Excalibur precision scroll saw from Canada can turn your workshop into a profit center. Make toys and puzzles, do intricate marquetry work or detailed cabinet work with these "operator friendly" machines. Hundreds sold in the U.S. already. Save, buy direct, from \$495. up. Send for brochure. J. PHILIP HUMFREY INT. \$1.00. Circle No. 1655.

**\$20 PER HOUR/PART TIME!**—Sell Mason Shoes in your spare time. We'll help you turn Saturday mornings into big money. No risk! No investment! It's easy! Send for free catalog and sales kit. MASON SHOE MFG. CO. Free. Circle No. 1658.

**MARLIN WOODCARVERS AND ACCESSORIES**—make all types of wood carving easy, fun and profitable. The machines do the work. Whether for sign carving, flat 3-D, decoys, panels, gun stocks or furniture, we have the proper machine for the job. Professional woodcarving for the hobbyist and superior quality for the professional. Begin your



hobby or full or part-time business by ordering our catalog and price list. MARLIN INDUSTRIES. \$1.00. Circle No. 1659.

**MASS PRODUCTION FURNITURE REFINISHING**—a revolutionary new concept from Master Finishers System™. Totally new, tremendously profitable! The old hand process is now done automatically with Master Finishers Furniture Refinishing Factory. Send for audio tape and brochure. MASTER FINISHERS. \$1.00. Circle No. 1660.

**MAKE MONEY IN FURNITURE RESTORATION THE MINUTEMAN WAY**—Earn \$200-\$1000 per day stripping, repairing, refinishing, mirror resilvering, and/or veneering, at home or in shop, spare time or full time. We provide complete free training; no experience necessary. Free workshop teaches you latest in furniture restoration. You have to see it to believe it! Send for catalog. MINUTEMAN. \$2.00. Circle No. 1661.

## MISCELLANEOUS

**SAVE 25-85% ON MAJOR BRAND**—do-it-yourself tools, home and car alarms, telephones, paint sprayers, pressure washers and more. Order your 100-page catalog packed with savings now! BURDEN'S SURPLUS CENTER. \$1.00. Circle No. 1905.

**MAKE WOODEN TOYS**—Whirligigs, doll houses, swing sets, classic autos, furniture and crafts with our plans, kits, parts, and supplies. For all skill levels. Also parts (toy, craft, game, and furniture) and dimensional lumber in maple, oak, walnut, and cherry along with specialty brass parts, tools, books, organizers and finishes. Send for color catalog subscription. CHERRY TREE TOYS, INC. \$1.00. Circle No. 1918.

**MAKE WOODEN CLAMPS**—Save 60%. Kits and plans for 8, 10, and 12 in. wooden handscrew clamps. Acme threaded steel rods, components, handles and full-sized plans provided. Kits also available with uncut and pre-cut maple jaws. You decide how much you want to save. Also available are hundreds of plans, kits, parts, and supplies for wooden toys and whirligigs in our beautiful color catalog. CHERRY TREE TOYS, INC. \$1.00. Circle No. 1919.

**THE CUSHION CONTOUR SANDER**—is a new concept in pneumatic drum sanding. Sanding sleeves are slid over an air bag (inflated with a hand tire pump) on an arbor to mount it between centers on a wood lathe. Drum effectively takes on profiles, curves, and bevels practically eliminating flat spots and chatter marks. INDUSTRIAL ABRASIVES CO. Free. Circle No. 1976.

**BANDSAW OWNERS**—A new tool is now available so you can make or repair any length bandsaw blade in minutes. Our splicer enables craftsmen to make up any length blade from economical coil blade stock quickly and easily. Three models are currently available to accommodate blade widths from 1/2 to 1 1/2 in. The tool comes complete with detailed instructions and supplies. We also carry OLSON bandsaw stock at reasonable prices. Send for literature. NEW MILFORD SPECIALTIES CO. 50c. Circle No. 2025.

**SLEEVELESS DRUM SANDERS**—Economical—simply cut sandpaper from standard size sheets. Unique way of holding sandpaper to drum—a twist of the key tightens. Sponge rubber backing insures long wear of sandpaper. Sanders can be used on drill press, small motor, lathe, combo-tools, radial saw, hand drill, and other revolving devices. Send for brochure. SINGLEY SPECIALTY CO., INC. 50c. Circle No. 2063.

**IF YOU ARE INTERESTED IN RESTORING ANTIQUES**—this 176-page catalog packed with unusual, hard-to-find items is just for you. Included are hundreds of essential items for antique restoration including top quality brass reproduction hardware, oil lamps and accessories, numerous wood component repair parts and kits, caning and basketry supplies, everything needed for wood refinishing, related tools, books, and a complete line of upholstery equipment and supplies. All at wholesale prices. Send for this informative catalog. VAN DYKE SUPPLY CO. \$1.00. Circle No. 2077.

## CARVING SUPPLIES

**DECAY AND WOOD CARVERS WISHBOOK**—48-page catalog features wide selection of tools and supplies for decay carvers, wood carvers, wood turners. Chisels, gouges, sharpening stones, precision grinding tools, Foreman tools, Fire Brush burners, pneumatic sanders, glass eyes, pewter feet, patterns, paints, reference books. P. C. ENGLISH, INC. Free. Circle No. 2115.

**CARVERS' & ARTISTS' SUPPLIES!**—Now you have a sourcebook for the most sought-after supplies for your pursuits! Thousands of decay carving patterns; kolinsky sable artist brushes; acrylic, alkyd, and oil paint; carving knives and gouges; Fordom & Dremel moto tools; hundreds of moto tool cutters and accessories. New 1989 catalog: 80 pages, over 4500 items! C. J. HUMMUL CO. Free. Circle No. 2130.

**WOODCARVING TOOLS**—Whittlers and carvers—Warren Tool Co. offers a catalog for you full of whittling and carving hand/power tools, books, stones, wood, and supplies. Since 1927, the finest in woodcarvers tools. WARREN TOOL CO., INC. \$1.00. Circle No. 2185.

## POWERMATIC



**Call For Our Low Prices!** We carry the entire Powermatic line at very attractive prices. Please call for our prices on the Model 66 and other Powermatic machines. You'll be glad you did!

Model 66 Table Saw with 50" Biesmeyer Rip Fence. 3HP, 1PH or 5HP, 3PH motor. FOB our Warehouse.

## Mini-Max

World's Best Jointer-Planer

FS35 Jointer-Planer \$2195

Length 63" Width 13 1/2" Weight 719 lbs.  
3HP, 1PH or 3HP, 3PH Motor

Please call or write for more information on the FS35 jointer-planer. We stock the entire Mini-Max line. Please call for our prices. FOB our Warehouse. Call for discounted freight rates!



## MAKITA

804510	4" finishing sander	\$ 59
1100	3 1/2" planer kit	\$209
1805	6 1/2" planer kit	\$309
2706	8 1/2" table saw	\$229
36120R	plunge router	\$189
GUIDES	for 36120R	\$ 28
36018	1/2" router	\$118
37008	1/2" trimmer	\$ 95
40018V	orbital jig saw	\$139
5007NB	7 1/2" circular saw	\$109
6000LR	7 1/2" clutch drill	\$119
6012HDW	1/2" cordless clutch drill	\$199
99008	3x21 belt sander	\$129
9962400	3x24 belt sander	\$149
8401	4x24 belt sander	\$169
98202	blade sharpener	\$169

## RYOBI SPECIALS

S500A	3 x 4 1/2 Pad Sander	\$ 39
SUR200	1/2 Sheet Pad Sander	\$ 99
B7075	3 x 21 Dustless Belt Sander	\$105
B7100	3 x 24 Dustless Belt Sander	\$121
B7200A	4 x 24 Dustless Belt Sander	\$148
R151	1HP Plunge Router	\$ 95
H501	2 1/2HP Plunge Router	\$159
TR30U	Trimmer	\$ 77
TS38U	14" Miter Saw	\$369



10" width of cut  
13 Amp. 110v  
Motor  
Powered  
CALL FOR  
DIS. PRICE!

AP-10 Thickness Planer

## FREUD SPECIALS

TT-108	8 Pc. Turning Tool Set	\$ 69
90-100	15 Pc. Router Bit Set	\$139
92-100	26 Pc. Router Bit Set	\$284
94-100	5 Pc. Router Cabinet	\$159
FB-100	16 Pc. Forstner Bit Set	\$159
EC-900	5 Pc. Sluper Cabinet Set	\$254
EC 209/213	Raised Panel Cutters	\$85
EC 2x2	1/2" Cabinet Door Set	\$157

## Sawblades

LM72M	10", 24T, Rip Blade	\$38
LUR3M	10", 60T, ATB Cutoff	\$38
LUR4M	10", 50T, Combination	\$38
	Set of Three Above	\$107
LUR2M	10", 60T, Triple Chip	\$42
LUR5M	10", 80T, Super Blade	\$59
DS308	6" Dado	\$99
DS308	8" Dado	\$109
JS100	Plate Joiner	\$169
JS120	1000 Biscuits	\$29
F1100	Spare Cutter	\$ 34

## MAKITA STATIONARIES

2040	15" Planer	\$1275
2020	8" Jointer	\$775

## HITACHI

F-1000A	Jointer-Planer	\$1395
CB75F	Resaw Bandsaw	\$1645
C15F6P	15" Miter Saw	\$499
C101FB	10" Miter Saw	\$279
TR12	Plunge Router	\$173

## PORTER CABLE

518	3HP Speedtronic Router	\$323
630	1HP Router	\$ 93
690	1 1/2HP Router	\$124
310	Laminate Trimmer	\$124
312	Offset Laminate Trimmer	\$133
318	Tilt-Base Laminate Trimmer	\$136
338	Speed-Block Sander	\$ 64
352	3 x 21 Dustless Belt Sander	\$130
360	3 x 24 Dustless Belt Sander	\$185
362	4 x 24 Dustless Belt Sander	\$198
555	Plate Joiner	\$169
345	Saw (book)	Call

## JET POWER TOOLS

JBS-10MW	Metal/wood Bandsaw	\$349
JJ-6	6" Jointer	\$339
JTS-10	10" Contractors Saw	\$439
CTAS-10	10" T/A Table Saw	\$1275
JJ-8	8" Long-Bed Jointer	\$899
JWP-15H	15" Thickness Planer	\$999
DC-610	1 HP Dust Collector	\$329
DC-1182	2 HP Dust Collector	\$449

JET Prices include delivery east of the Mississippi.

## LEIGH

T054L	24" dovetail jig with 1 1/2" bits for 1/2" dovetails	\$229
D128-12	New 12" jig for through and half blind dovetails	\$255
D128-24	New 24" jig for through and half blind dovetails	\$289

Optional Biss in Stock

Orders over \$35 \*\*include delivery unless otherwise noted. Prices subject to change without notice.

## The Xylophile's Company

138 E. Loudon Ave. • Lexington, KY 40505

1-800-354-9083 —M/C VISA— (606) 254-9823

## ANYTIME ANYWHERE ANYWOOD mold plane and edge

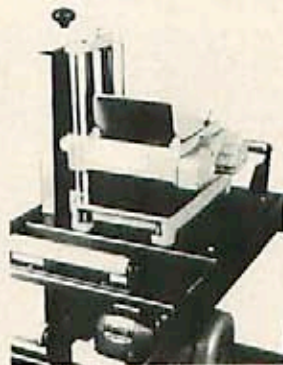

Professionals and hobbyists alike know the strengths of the W&H molder-planer. Superior US-made construction and quick two-minute cutter changes make it a snap to cut moldings and plane hardwoods. It's fast, easy, and super-smooth.

Picture frames. Crown moldings. Raised panels. And more. Our three models offer the best value in your shop or on the job site!

Our five-year warranty and free 30-day trial are your assurance that W&H goes the distance.

Mail this ad or call us toll-free today.

1-800-258-1380 In NH 603-673-3446

Williams & Hussey Elm Street Dept. 238GM  
Milford, NH 03055

YES! Send your free information kit today.

Name \_\_\_\_\_

Address \_\_\_\_\_

City \_\_\_\_\_ State \_\_\_\_\_ Zip \_\_\_\_\_

I am a professional  I am a hobbyist  
 I am also interested in your 12" lathe



# FREE CATALOG



Write today to start your FREE two-year subscription. Complete selection of all kinds of woodworking tools, competitive prices and fast, friendly service have made Woodworker's

Supply of New Mexico the preferred source for professional woodworking tools and supplies.

Please start my two-year subscription.

Name \_\_\_\_\_

Address \_\_\_\_\_

City \_\_\_\_\_ State \_\_\_\_\_ Zip \_\_\_\_\_

## Woodworker's Supply OF NEW MEXICO

5604 Alameda Place, NE • Dept WM2  
Albuquerque, NM 87113 • 505-821-0500

**1-800-645-9292**

# WOOD TOY

- ★ Patterns
- ★ Parts
- ★ Wheels
- ★ Many New Patterns to Choose from.
- ★ Executive toys

SEND \$1.00 FOR NEW CATALOG & RECEIVE COUPON FOR FREE WHEELS & AXLE PEGS.



## toys and joys

Box 628W Lynden, Wash. 98264

## Quality EXOTIC WOOD TURNERS

Burls / Thick Planks / for Bowls / Squares

## CABINET MAKERS

Individually Selected Lumber for Furniture / Boxes / Inlays  
OVER 70 SPECIES

All Inquiries Welcome - Call or Write

## The Berea Hard Woods Co.

125 JACQUELINE DRIVE, DEPT. 10  
BEREA, OHIO 44017  
216-243-4452

"It's a Matter of Pride for Both of Us"

# Van Dyke's

## Presents a Catalog

with supplies for upholstery, antique restoration, wood working, caning, brass hardware, carvings and many related trades!

36 Years in Creative Arts & Trades

Many Hard-To-Find Items!

SEND \$1.00 FOR CATALOG TO:  
**Van Dyke's Restorers**  
Dept. D55 • Woonsocket, SD 57385

## Full-Size Professional Plan ADIRONDACK CHAIR



Make this classic American design. Our special version may be folded for storage by using ordinary hardware available at your local store. Be ready for Summer and get your plan now!

CATALOG 200 full-size professional furniture plans — \$2.00

Plan #700 . . . . . \$12.00  
(Catalog free with order)

FURNITURE DESIGNS, INC., Dept. BA-88  
1827 Elm Dale Ave., Glenview, IL 60025  
(312) 657-7526

## THE SOURCE®

Woodworkers Tools & Hardware

7305 Boudnot Drive  
Springfield, Virginia 22150  
703-644-5460

DELTA  
Complete Drill Press Package  
\$139



10" Portable Planer AP-10 \$369



8 1/4" Portable Radial Arm Saw RA200 \$245

You get:

- Delta 8" Bench Drill Press
- 13 Piece Drill Bit Set
- 15 Piece Sanding Drum Kit

US 800-452-9999 VA 800-468-1778

## SPECIAL OFFER

# BRANDING IRON

For hard and soft wood

\$2600

Plus \$2.00 for shipping and handling

Non-residents add correct sales tax

SATISFACTION GUARANTEED or your money back

HAND CRAFTED BY YOUR NAME HERE

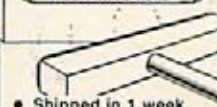

- Shipped in 1 week
- Solid brass head — deep cut letters
- First Line: HAND CRAFTED BY — as above
- 2nd line: Your choice — 20 characters/spaces max.
- Compact size
- As above but with 3rd line — \$37.00 + \$2.00

ORDER TOLL FREE 1-800-826-7606 (except Nebraska) in Nebraska 1-402-464-0511

For free brochure, write or call (402) 464-0511

Order by mail from: **NOVA TOOL CO.**

12500 Fingon Rd. Dept. BH  
P.O. Box 29341, Lincoln, NE 68529



## NOW A 44" WIDE SANDER AT A NEVER BEFORE PRICE

\$249<sup>99</sup>

The Performax S/T Drum Sander Instantly Attaches to a Radial Saw or a Stand Kit.



Sanding Strip Spiraled on 22" Drum

A Space Saving Attachment

- Rigid open end design insures precise thickness dimensioning over 44" width.
- Sanding drum with built-in sandpaper fasteners — no adhesives required
- Vacuum dust collector
- Money back guarantee



STAND HARDWARE KIT \*99\*\*  
(Motor & wood not incl.)

For a free brochure call or write **PERFORMAX PRODUCTS, INC.**

11975 Portland Av. So. Suite 142  
Dept. W, Burnsville, MN 55337  
1-800-334-4910

Dealer Inquiries Welcome

## "TRAVELERS COMPANION" WOODCARVING KIT By WARREN TOOL CO., INC.



CONTENTS OF # COMBI-T3 SPECIAL  
1-Interchangeable Handle  
3-Styles Whittling Blades  
6-Styles Carving Gouges  
1-Durable Tool Box  
1-Complete Catalog of Tools And Supplies.

SAVE \$4.00  
\$57.35 ppd.

SEND TODAY FOR Complete Woodcarving Package of tools and receive "Basic Carving" book written by the National Carvers Museum expressly for Warren Tool users. All tools American made and guaranteed 100% against defects or money refunded. All tools honed sharp for your immediate carving pleasure. Send check or money order to:



WARREN TOOL CO., INC., Rt. 1 Box 14A Dept. W  
Rhinebeck, NY 12572 TEL: (914) 876-7817

## Wood Moisture Meter

- Avoid Moisture Problems
- Protect your Masterpiece

### MINI LIGNO

Incl. Case, Batteries and Pins for 1/4" and 1/2" Measuring Depth.

only \$110

also from Lignomat:  
**MINI-LIGNO E**  
Range: 6%

Easy-to-use, sturdy instruments for the professional woodworker or serious hobbyist. Great for lumber, veneer, fiberboards. Ask for free catalog on the complete line of moisture meters and accessories for kiln drying.

**Lignomat USA Ltd.**  
503-257-8957 800-227-2105

P.O. Box 301450H  
Portland, OR 97230



**WOOD CARVERS SUPPLY INC.**—offers you the widest array of wood carving supplies in the USA. We offer products for turning, checkering, cabinet making, log building, instrument making, and more. Everything is backed by a 32-year reputation for service and our famous 30-day money-back guarantee. Send for 2-year subscription to our color catalog. **WOOD CARVERS SUPPLY INC.** \$2.00. Circle No. 2190.

### CLAMPS

**MERLE ADJUSTABLE CORNER CLAMP** — Quick & easy to use. Fully adjustable from 2 1/4" to 36x36 in. Perfect for clamping picture frames, cabinets, or anything that requires 90° corner clamping. The Merle Clamp is cast aluminum & steel construction, a true industrial quality tool. Send today for information. **MLCS LTD.** Free. Circle No. 2250.

### CLOCKS

**A FREE COLOR CATALOG FROM KLOCKIT**—details hundreds of clock and wood kits, plans, quartz or mechanical clock movements, dials, hands, tools, and other components for the experienced or beginning craftsman. **KLOCKIT.** Free. Circle No. 2335.

### ANTIQUe TOOLS

**THE FINE TOOL JOURNAL** — Published 6 times per year, this publication will keep you up to date with the many aspects of the world of antique and obsolete hand tools. Tools are offered for sale, books on tools are reviewed and sold, auctions are reviewed, articles on identification, values, and history. Send for sample copy. **IRON HORSE ANTIQUES, INC.** \$2.50. Circle No. 2435.

For families who enjoy and take pride in their homes, there is no more appropriate gift than a subscription to **WOOD** magazine.

## WOODWORKERS

### Porter Cable 1.5 Horse Power Router



MODEL  
690

SALE  
\$129.95 ppd

FREE CATALOG SUBSCRIPTION  
WITH PURCHASE.

CATALOG ONLY.

2 year subscription (8 issues) \$4.00.  
Free \$5.00 gift certificate with catalog order.

R. A. NESS & CO.  
**THE WOODWORKERS  
EMPORIUM**

8888 N. MILWAUKEE AVE.

NILES, IL 60648

(312) 824-0565



## Information

WORTH WRITING FOR

TO ENSURE PROMPT HANDLING OF YOUR ORDER FOLLOW THESE INSTRUCTIONS:

- Circle your choice
- Enclose check or money order for cost of booklets plus \$1.00 service charge (no stamps/foreign)
- Send coupon and remittance to address above
- U.S. FUNDS ONLY
- ALLOW 4-6 WEEKS FOR DELIVERY
- Coupon expires August 14, 1989

### WOOD SUBSCRIPTION

1. A 1 year **WOOD** subscription (6 issues) for \$18.00 — a \$3.00 savings off newsstand rate. Allow 6-8 weeks for first issue. Add \$6.00 outside U.S. Be sure to include payment with total below.

### FREE LITERATURE

Circle numbers below corresponding to items in this issue.  
Please include \$2.00 for handling charge

41.	76.	250.	861.	1125.	1658.	2335.
42.	84.	270.	862.	1250.	1976.	
44.	85.	410.	955.	1251.	2115.	
57.	88.	852.	975.	1275.	2190.	
61.	135.	860.	1090.	1350.	2250.	

### PRICED LITERATURE

Numbers below refer to items on which there is a charge.  
Please include proper remittance.

3 ... \$1.00	138 ... \$1.00	485 ... \$2.00	855 ... \$4.00	1065 ... \$1.00	1401 ... 50¢	1661 ... \$2.00
4 ... \$1.00	160 ... \$1.00	510 ... \$1.00	877 ... \$2.00	1140 ... \$2.00	1415 ... \$1.00	1905 ... \$1.00
33 ... \$7.95	190 ... \$1.50	520 ... \$1.00	878 ... \$1.00	1235 ... 25¢	1427 ... \$2.00	1918 ... \$1.00
51 ... \$1.00	226 ... 25¢	525 ... \$10.00	900 ... \$4.00	1245 ... \$1.00	1450 ... 25¢	1919 ... \$1.00
70 ... \$14.95	232 ... \$1.00	530 ... \$2.00	915 ... \$3.00	1248 ... \$1.00	1455 ... \$1.00	2025 ... 50¢
87 ... \$1.00	310 ... \$2.00	535 ... \$1.00	935 ... \$3.00	1253 ... \$1.00	1480 ... \$1.00	2063 ... 50¢
88 ... \$2.00	315 ... \$1.00	545 ... 50¢	945 ... \$5.00	1308 ... \$3.00	1490 ... \$1.00	2077 ... \$1.00
90 ... \$1.00	340 ... \$1.00	547 ... \$1.00	965 ... \$1.00	1315 ... \$1.00	1605 ... \$1.00	2185 ... \$1.00
93 ... \$1.00	345 ... \$2.00	578 ... \$1.00	1030 ... \$1.00	1317 ... 50¢	1655 ... \$1.00	2190 ... \$2.00
94 ... \$1.00	370 ... \$1.00	810 ... \$1.00	1050 ... \$2.00	1319 ... \$3.00	1659 ... \$1.00	2435 ... \$2.50
97 ... \$1.00	390 ... \$1.00	820 ... \$1.00	1060 ... \$3.00	1321 ... \$1.00	1660 ... \$1.00	

Name (please print) \_\_\_\_\_  
Address \_\_\_\_\_  
City \_\_\_\_\_  
State \_\_\_\_\_ Zip Code \_\_\_\_\_

### I AM ENCLOSING:

\$ \_\_\_\_\_ for priced items  
\$ 2.00 for handling  
\$ \_\_\_\_\_ total remittance

## NOW! Get in on the PROFITS in SMALL ENGINE REPAIR!



Start your own money making business!

Work part time, full time—right at home—we help you every step of the way.

No doubt about it... as a small engine pro, you can cash in on the huge demand for qualified men in one of America's fastest growing industries. You'll be able to command top hourly rates of from \$25.00 to \$30.00 per hour—and that's just for labor. A simple tune-up earns as much as \$49.95 for less than an hour's work, and parts, engines and accessories will add even more to the profits.

Plenty of business waiting for qualified men. 65,000,000 Small Engines Are In Use Today!

That's the official count from the Engine Service Assn., and one-million new engines are being built each month. With fully accredited Foley-Belsaw training, you can soon have the skills and knowledge to make top money servicing these engines. People will seek you out and pay you well to service their lawnmowers, tillers, edgers, power rakes, garden tractors, chain saws, minibikes, snowmobiles, generators, go-carts, paint sprayers, snowblowers... the list is almost endless.



Professional Tools and Equipment, PLUS 4 H.P. Engine ALL YOURS TO KEEP... All at No Extra Cost. NO EXPERIENCE NECESSARY!

You don't need to be a "born mechanic" or have any prior experience. You can master this profitable trade right at home in your sparetime. Lessons are fully illustrated... so clear you can't go wrong, and with our famous "learn-by-doing" method you get practical "hands on" experience. We also show you how to get business, what to charge, where to get supplies wholesale... all the inside tricks of the trade you need to assure success right from the start.

Send for FREE Facts—Do It TODAY!  
NO Obligation—NO Salesman Calls!

You risk nothing by accepting this offer to see how easily you can learn the skills you need to increase your income in a high-profit business of your own. Just fill in and mail coupon below (or send postcard with name and address) to receive full information by return mail.

### RUSH COUPON TODAY

Foley-Belsaw Institute  
6301 Equitable Rd.  
Dept. 51459  
Kansas City, MO 64120



FREE BOOKLET!

Send for your copy today!

**FOLEY-BELSAW INSTITUTE**  
6301 Equitable Rd., Dept. 51459  
Kansas City, MO. 64120



YES, please send me the FREE booklet that gives full details about starting my own business in Small Engine Repair. I understand there is No Obligation and that No Salesman will call on me.

NAME \_\_\_\_\_  
ADDRESS \_\_\_\_\_  
CITY \_\_\_\_\_  
STATE \_\_\_\_\_ ZIP \_\_\_\_\_

# WOODCARVING IS FUN & PROFITABLE!



Want to carve decoys, statues or gun stocks?

It's easy when you use the Dupli-Carver Series wood carving machines. A patented five axis carving action allows these machines to complete difficult undercuts and contours as no other machine can. Complete machines are available starting as low as \$359.00

SEND \$1.00 FOR OUR FULL LINE BROCHURE AND PRICE LIST AND START PLANNING YOUR FULL OR PART-TIME BUSINESS.



**MARLIN INDUSTRIES, INC.**

Rt. 70, Box 181, Dept. D 88  
Cahlers, NC 28717  
(704) 743-5551

## Adams NEW Wood Products

### "LUMBER"

KILN DRIED, SURFACED TO 1/4", 1", 1 1/2" WITH 2 PARALLEL EDGES, 100% CLEAR IN USABLE SIZES. OAK, HONDURAS, MANGUANY, WALNUT, CHERRY, MAPLE, FINE TURNING SQUARES, DRAWER SIDES, CARVING BLANKS. DRAWER SIDES IN OAK, CEDAR, MAPLE



QUEEN ANNE CHAIR



QUEEN ANNE LEG

### "FUTURE ITEMS"

COUNTRY STYLE AND CLAW/BALL TABLE LEGS.

ALL ITEMS AVAILABLE IN QUANTITIES OF ONE OR MORE, INCLUDING TABLE BASES, QUEEN ANNE LEGS, AND R.T.A. QUEEN ANNE CHAIRS, WHICH ARE SHIPPED FROM STOCK.

"FREE BROCHURE"  
DEPT. "M"



**Adams Wood Products, Inc.**

874 Forest Dr., Morristown, TN 37814

DAVID J. ADAMS  
President

TELEPHONE  
(615) 587-2942

## National Carvers Museum



LEARN  
WOODCARVING  
AT HOME

Receive sample instructional pack on whittling and woodcarving. Includes copy of Mallet monthly magazine.

Send \$2.00 — deductible upon subscription payment to The National Carvers Museum, 14960 Woodcarver Rd., Monument, CO80132.

(719) 481-4737

## CREATE A FAMILY TREASURE WITH KUEMPEL CHIME Red-i-Kut Kits



Each case is carefully handcrafted by grandfathers in 1/2" walnut cherry or oak. Precision West German movements, handcrafted pendulums, and individually handpainted moonwheels.

Write or Call for  
Catalog \$2  
1-800-328-6445  
Kuempel Chime

Dept. 019

21195 Minnetonka Blvd.  
Excelsior, MN 55331  
Serving clockmakers for 65 years.

## 101 GIFT & NOVELTY PATTERNS

The wonderful packet contains 101 FULL SIZE PATTERNS of Gifts, Novelties, Lawn Figures, Bird Houses, Shelves, Action Windmills, Alphabets, and many more things. Just trace and saw out. Plus "Make Money Jig Sawing". Only \$7.00 Prepaid 1st Class for this big packet.

MASTERCRAFT PLANS WEST, DEPT. 75H  
P.O. Box 625, Redmond, WA 98073



## 90 PATTERNS LAWN ORNAMENTS-NOVELTIES

FULL SIZE patterns up to 20" high of Dutch Boy and Girl, Dwarf, Penguin, Fishing Boy, Animals, Birds, Novelties and many other popular items. Easy to make and sell. Just trace, cut out and paint. Send \$7.00 for the LAWN ORNAMENT PACKET containing all 90 patterns. Prepaid, 1st Class.

MASTERCRAFT PLANS WEST, Dept. 72H  
PO Box 625, Redmond, WA 98073



## SCROLL SAW LETTERS EASILY...



...with Lettering Layout Guides!

- Excalibur Scroll Saws
- Scroll Saw Accessories
- Foredom Tools
- Mill—Route System
- Make Name Plates, Signs, Gifts and more.

Our unique Lettering Guides are available in many styles and sizes to suit your needs. Upper and Lower Case Script and Block Styles...and numbers too. Send \$1.00 for brochure and prices to:

**SEYCO SALES**

1414 Cranford Drive  
Box 472749  
Garland, Texas 75047

## Wood-Mizer®

World's Largest  
Manufacturer  
Of Portable  
Sawmills



## OWN YOUR OWN SAWMILL

Four Models To Choose From  
BUY DIRECT

**1(800)553-0219**

In Indiana call: (317) 271-1542  
**FREE** 44-page catalog or use your MasterCard or VISA to order our 50-minute demonstration video—\$10.00  
Wood-Mizer Products, Inc. • Dept. QX24  
8180 W. 10th St., Indianapolis, IN 46214-2430

## Sleeveless DRUM SANDER

Uses regular sandpaper — no pre-made sleeves to buy!



Lifetime  
Guarantee

USE ON:  
Drill press, motor lathe,  
combo-tools, radial saw, drills

Twist of key tightens sandpaper to drum. Rubber backing insures long sandpaper wear.

1" x 3" long	\$13.95
2" x 3" long	\$15.95
2 1/2" x 3" long	\$16.95
3" x 3" long	\$17.95
1" and 2 1/2" above	\$27.95
Set of 4 above	\$56.95
1/4" x 3" long	\$14.95
2 1/2" x 4 1/2" long	\$21.95
3" x 4 1/2" long	\$23.95
2 1/2" x 6" long	\$25.95
3" x 6" long	\$27.95
Add \$2.50 per order for shipping.	

AVAILABLE WITH:  
1/4" bore with 1/8" or 1/4" shaft  
1/4" 20 RH thread (except 1/4" x 3")  
1/4" bore (except 1/4" x 3" and 2" x 3")

MC, Visa, Check or Money order to:  
**SINGLEY SPECIALTY CO. INC.**  
P.O. BOX 5087B, GREENSBORO, NC 27403  
CALL: (919) 852-8581

## KELLER DOVETAIL SYSTEM

"In a class by itself . . .

. . . made exceptionally clean cuts. It has several advantages over the other jigs. Cleverly simple!" — WOOD Magazine

NOW with a 20 Year Limited Warranty!

Cut through dovetails with your router and get it right the first time.

See your Dealer or contact:  
**KELLER & CO., Dept. G78**  
1327 I Street, Petaluma, CA 94952  
(707) 763-9336

## The Woodturners Catalog

Craft Supplies USA offers woodturners the finest selection of woodturning tools and accessories anywhere.

- Choose from:
- Henry Taylor Custom Tools
  - Sorby
  - Richard Raffan Tools
  - Rude Osolnik Tools
  - Dale Nish Workshops

Also available are "Hot Stuff" glue, Power Sanding Kits, custom turning accessories, Burl Woods, Automach Woodcarver, and many other woodturning items, all at COMPETITIVE prices.

Send \$2.00 for your 52-page color catalog, refunded with order.

Craft Supplies USA, 1287 E. 1120 S., Provo, Utah 84601



## Exotic Hardwoods

Ebony & others. For serious woodworkers & turners.

FREE CATALOGUE

Phone or write:

**ART EISENBRAND**  
4100 Spencer Street  
Torrance, CA 90503  
(213) 542-3576

# The Discerning Craftsman

# CATALOG SHOP



1. **GRIZZLY IMPORTS, INC.** is a unique mail order company that specializes in wood and metal working machinery. Their full color catalog is loaded with great deals. Call (717) 326-3806 — It's Free!



2. **Woodworking Tools—Freud** provides the finest in hand tools, carbide cutting tools, and hand held power tools. From drills and sanders to carbide saw blades and router bits. **FREUD** catalog \$1.00.



3. **Make Whirligigs!** 54-page color catalog loaded with plans, kits (all skill levels), oak, cherry and walnut parts—and supplies for making whirligigs, toys, crafts and furniture. Antique spoked metal wheels, too! Bulk prices. Catalog \$1. **CHERRY TREE TOYS.** (614) 484-4363.



4. **HAMMERMARK ASSOCIATES** 20-page catalog features 31 Country Furniture plans, plus products for workshoppers. Our weekend workshop plans can be completed in a weekend or two. Our classic plans are a bit more extensive. New: Furniture Refinishing Book. Catalog \$1.00 (deducted from first order).



5. **Over 1000 Woodcraft Patterns!** Create gifts, toys, whirligigs, lawn ornaments, folk art, bird houses and feeders, magazine racks, shelves, children's items, kitchen and household accessories plus much more! Simple enough for the beginner, fun and profitable for the pro. **ACCENTS IN PINE** Catalog plus sample pattern only \$2.00.



6. 24-page catalog from one of America's larger woodworking tool suppliers—quite different than the first flyer Total Shop sent out back in 1977. This catalog is the best ever and will inform you on the finest woodworking tools available. **TOTAL SHOP** Catalog Free.



7. **CONSTANTINE'S** complete Woodworkers Catalog offers 116 pages of 150 kinds of veneers, 30 species of hardwoods, specialty woodworking tools and accessories. Hard-to-find hardware, inlays, moldings, cane, books and plans, finishes, etc. The best source for woodworkers and restorers. Satisfaction Guaranteed. \$1.00.

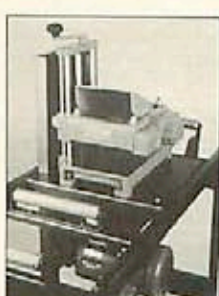

8. *Anytime, Anywhere, Anywood,* mold plane and edge. Professionals and hobbyists alike know the strengths of Williams & Hussey Molder Planers. Quick two-minute cutter changes, our five-year warranty and free 30-day trial are your assurances that **WILLIAMS & HUSSEY** goes the distance. \$1.00.

## Adams Wood Products



9. Our wood parts make it easy to make professional looking furniture. We feature legs, arms & turned columns for tables, chairs, etc. in styles including Chippendale and Queen Anne plus chairs & occasional tables to assemble & finish. Our woods include walnut, mahogany, cherry & oak. **ADAMS WOOD PRODUCTS** brochure packet \$1.00.



10. The **Excalibur T-Slot** precision saw fence system is designed to replace rip fence and guide rails on new and older table saws. Easily installed, new rip fence system guarantees accurate rip cuts on both right or left hand side of table saw's blade, without necessity of hand measuring. **EXCALIBUR MACHINE & TOOL CO.** Catalog \$1.00.



11. If you are making toys and other items for craft shows and flea markets, don't overlook our great selection of patterns for rocking horses, toys, cars, clocks and furniture. Specialty supplies, hardware, tools and gift items also available. **ARMOR PRODUCTS** catalog \$1.00.



12. **W. S. JENKS & SON'S** 150+ page sourcebook is packed with a full range of tools for the serious woodworker, from hand tools to portable power tools, to woodworking machinery. Includes many imported and hard-to-find tools from the best manufacturers at the most competitive prices. \$2.00 (refundable with first order).



13. Woodworkers Catalog — one of the best sources for quality woodworking tools. You'll find everything from bit braces to wood borers, from saws to sharpening stones. Every product is sold satisfaction guaranteed. Free from WOODCRAFT SUPPLY CORP. Includes bonus \$3 discount coupon.



17. The JAPAN WOODWORKER'S 1988 Catalog is loaded with the best tools you can get your hands on. In our catalog are tools for the woodcarver, carpenter and cabinetmaker. Send \$1.50 for our catalog and supplements during the next two years.



21. The 8-page National Carvers Museum Catalog contains woodcarving tools and accessories, books on woodcarving and application for membership to the National Carvers Museum. Send \$1.00 refundable on first order.

## HARDWOODS OF ILLINOIS

25. Thin lumber, approximately 20 species with varying widths up to 3/4", Kiln-dried. Turning squares. Send for more information. HARDWOODS OF ILLINOIS information, 50c.



14. Essential catalog for Woodworkers, Woodcarvers, Upholsterers, Antique Restorers & numerous traditional crafts & trades people. Brass Hardware, Wood Carvings, Turnings, Carving Supplies, Tools and more! VAN DYKE SUPPLY COMPANY catalog \$1.00.



18. Catalog shows moisture meters for wood to monitor air or kiln drying. Info about problems: shrinking, warping, cracking that can ruin beautiful wooden pieces. LIGNOMAT offers a small inexpensive instrument called Mini-Ligno to check moisture in wood. Catalog Free.



22. AMITY catalog features restoration systems, stripping chemicals, supplies and equipment. Hydrocote non-flammable finishes, Permafuse repair products, Amity's 1-2-3 wipe-on finishes, mirror silvering systems, and more! Catalog \$1.00.



26. FOLEY-BELSAW'S new Woodworking Correspondence Course for everyone wishing to learn woodworking skills. Create over 20 projects using professional plans & tools like a table saw, router & more...all included with course. Money-back guarantee. Free 30-Day Trial. Free info.



15. Executive wood toys! If you want more in the line of wood toys, let Toys and Joys offer you a line of detailed patterns for classic cars, trucks, trains, etc. We also carry a complete line of wood toy parts. Ask about our deluxe spoke wheels. TOYS AND JOYS Catalog \$1.00.



19. SEYCO SALES catalog offers durable, transparent plastic letter guides for scroll sawing, routing, carving, sandblasting, poster layout and woodburning. Catalog also offers Excalibur scroll saws & accessories, Freedom woodcarvers kits & the Mill Route. Catalog \$1.00.



23. Patterns by Design Group—Toys, Games, Puzzles, Birdhouses, Rocking Horse, Cars, Trucks, and MORE! All patterns are "Same Size" Blueprints. No enlarging necessary. Simply trace and create. Money Back Guarantee. DESIGN GROUP'S fully illustrated catalog \$1.00.

## MLCS

27. Router owners—large discounts. High quality router bits, router speed controller, and the Merle Adjustable Corner Clamp are our only business. Prices 50%—70% lower than elsewhere. Value, quality, and prompt service guaranteed! MLCS Free Information Kit.



16. CASCADE TOOL COMPANY'S new 12-page catalog featuring over 300 S brand industrial quality carbide tipped router bits and shaper cutters. Best prices are available. The low overhead, factory direct way making our knives the best buy in the industry. Catalog \$1.00.



20. The original woodworking system, the Shopsmith Mark V gives you a table saw, disc sander, vertical drill press, and lathe in one compact unit. Two models and a variety of accessories. The SHOPSMITH Mark V Woodworking System. Free info.

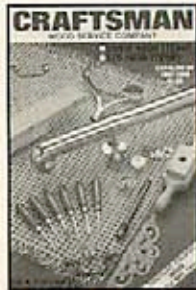

24. 1988 Craftsman Catalog. 148 pages. Over 4000 items. 42 varieties, finest domestic and imported woods 1/16" to 4" thickness. Hardwood Plywoods, tools, moldings, lamp and more! Catalog \$1.00. (\$3 first order discount coupon free with catalog.) CRAFTSMAN WOOD SERVICE.



## THE SOURCE

28. Cabinetmakers' tools and supplies. New 230-page catalog of fine hand and power tools for cabinet makers and serious woodworkers. Also features hardware, supplies and cutting tools. A must reference for the woodworker. THE SOURCE Catalog \$3.



29. Stop looking! The P.C. ENGLISH, INC. Decoy and Wood Carvers Wishbook has imported eyes, handmade knives, Jo Sonya paints, tupelo, basswood, Foredom, Fire Brush burners, bandsaws and reference books galore. Send for your FREE copy today.



30. Quality handcrafted clocks. Made by grandfathers in solid walnut, cherry or oak. Kits, "from scratch plans" or completely finished. Grandfather, wall or mantel clocks. Hand-painted moon wheels on fine West German movements. KUEMPEL CHIME Catalog \$2.00.



31. This PERFORMAX brochure details the Performax S/T drum sander attachment that converts any radial arm saw to a surface thickness sander for finish up to 44" wide. Can be attached to standard kit. Brochure \$1.00.



32. Woodturners: Our one-stop specialty catalog is the best source of woodturning tools and supplies in America. Includes General lathes, abrasives, chucks, tools, grinders, wood, finishes. CRAFT SUPPLIES U.S.A. Catalog \$2.00. Refunded with order.



33. MEISEL HARDWARE SPECIALTIES all new 48-page catalog is the source for hard-to-find woodworker's specialty hardware and project plans. Included are new door harp plans, doll house plans, clock plans and many hard-to-find items for the woodworker. \$1.00.



34. Full-color catalog with a wide selection of innovative products for modern day woodworkers. Professional quality tools at prices every shop can afford. Write today to start your FREE two-year subscription. WOODWORKER'S SUPPLY OF NEW MEXICO.



35. Woodcarving machines for both sign carving and decoy, statuary or panel carving are available from MARLIN INDUSTRIES, INC. Sign carving is easy and profitable with a Marlin CM series machine. The machine does the work—you have fun and make the profit. Catalog \$1.00.



36. BYROM INTERNATIONAL'S 1988 Industrial Router Bit Catalog features over 670 router bits in solid carbide, carbide tipped, and hi-speed steel. The 24-page catalog contains over 125 pictures and technical illustrations. Catalog \$3.00.



37. MINWAX COMPANY — Tips on Wood Finishing. Free 30-page revised edition. Time-saving tips and easy how-to instructions. Details on beautifying and protecting new wood, plus restoration techniques for old wood. Many wood projects are outlined step-by-step, with over 50 photographs plus color charts. Includes name of nearest dealer.



38. New summer 1988 catalog features the incredible square drive screw in steel, solid brass, and stainless steel, router bits, veneers and veneer tape, and other woodworking specialties. McFEELY HARDWOODS AND LUMBER. Catalog 50c.



39. RBINDUSTRIES, a leader in the design & manufacture of American-made woodworking equipment, features 6 models Hawk Precision Scroll Saws. Also 2 models of wood planers that can convert into molders or sanders & joint machine for making precision wood joints. Catalog Free.



40. For the first time ever, BLACK & DECKER is offering its line of Elu woodworking tools in the U.S.—sanders, routers, a power planer and a jointer/spliner—all with a wide range of accessories. ELU WOODWORKING TOOLS by BLACK & DECKER information \$1.00.

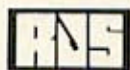

### RJS CUSTOM WOODWORKING

41. Full-size plans for fine furniture, home accessories, & toys featuring Plan Plus—the plan complete with hardware & hard-to-find components. All-American Tool Collection spotlights shop-tested USA made tools. Catalog \$1.00; refunded/1st order. RJS CUSTOM WOODWORKING.



### EDUCATIONAL LUMBER CO., INC.

42. EDUCATIONAL LUMBER COMPANY offers you a new catalog of the finest quality domestic and exotic species available. Including turning stock, shorts, veneer, hardwoods and softwoods. This catalog contains over 21 species. The catalog itself is an educational experience! \$2.00.

### J. M. WISE & CO.

43. Build a 8" jointer or any one of twelve other accurate, rugged, vibration-free woodworking machines. Brass-bound square and marking gauge kits, wooden plane kits and much more. J. M. WISE & COMPANY. Send for free information.



### Berea Hardwoods Co.

44. Quality exotic lumber/turning woods. Fine-quality ebony, kingwood, tulipwood, snakewood, African blackwood, cocobolo, bloodwood, figured maple, spalted maple, padauk, etc. Unique and unusual turning wood and burls are also available. BEREA WOODS. Catalog \$1.00.



45. 212-page GARRETT WADE catalog with over 2500 selections of the finest tools and finishes. Also valuable reference material on care and use of tools. This premium group of products includes hand tools, books, finishes, stones, benches and turning tools. Power tools and accessories featuring INCA woodworking machinery. \$4.



50. Portable Sawmills—Our new 44 page full-color catalog describes each of our sawmill models for 1988. In addition, there is information and pricing on our solar kilns, dry kilns, carving machines, shop bandsaws, and our complete line of progressive woodworking equipment. WOOD-MIZER® PRODUCTS catalog \$1.00.



54. Your C. J. HUMMEL 1988 catalog is your link to a service oriented company that ships fast and stands behind its products. 80 pages filled with over 4500 items. Get great values and selection on Foredom, Dremel, rotary cutters, carving knives, Gordon Stiller wildlife blueprints, books on painting & carving techniques, artist paints & brushes, and museum quality glass eyes. Two dollar catalog is Free to WOOD readers.



46. A Clamp for every need—to get the best clamps available, you need Jorgensen and Pony clamps from the ADJUSTABLE CLAMP COMPANY. The most convenient way to get Adjustable Clamp's quality is by requesting the L-20 Catalog. You can also order a wide range of hand tools. Catalog \$1.00.



51. Mass production furniture refinishing—a revolutionary new concept from Master Finishers System. Totally new, tremendously profitable! The old hand process is now done automatically with Master Finishers furniture refinishing factory. send for audio tape and brochure. MASTER FINISHERS \$1.00.

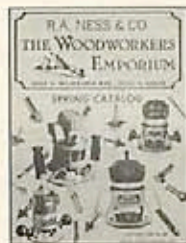

55. R. A. Ness & Co., The Woodworkers Emporium, offers a two-year subscription. Thousands of industrial-quality items—machinery, hand tools, portable electric tools and supplies featured at super sale prices. Fee refundable with purchase. \$4.00.



47. World Leader in Furniture Restoration—MINUTEMAN'S systems and equipment are best by performance. Earn \$200—\$1,000 per day stripping, repairing, refinishing, mirror resurfacing and/or veneering, spare time or full time. No experience necessary; complete training provided. Free furniture restoration seminar. Catalog \$2.00.



52. Woodworkers—A catalog where you'll find unique accessories that will help you work alone. See how to gain valuable floor area and expand your workspace with ease. All products are of top-quality and "Made in USA." HTC Catalog \$1.00—Refund coupon included.



56. Power tool Application Guide/Catalog describes compact power tools, attachments and accessories. Features Moto-Tools, Flex-Shaft attachments, and Drill Press. Includes descriptions of 170 different bits for cutting, carving, polishing, cleaning, routing, grinding, engraving and more. Free from DREMEL.



48. Scroll Saws  
49. Wood Lathes & Duplicators  
Your choice of two beautiful catalogues showing German-made scroll saws and wood lathes and duplicators. The HEGNER products are imported exclusively by ADVANCED MACHINERY IMPORTS, LTD. Free.



53. Buy your sanding belts direct from the manufacturer and save! Yes, INDUSTRIAL ABRASIVES is the company that gives you six free belts with every dozen ordered. But, sanding belts are not the only product we have to offer. In our catalog you will find many sanding-related items not readily available in your hardware store. Catalog \$1.00 (refundable with order).

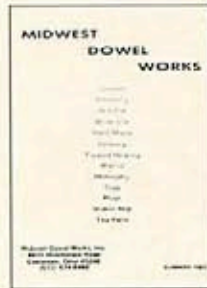

57. Low-cost wood supplies, dowels, and turnings in all species. Same day service, direct from factory. Available through MIDWEST DOWEL WORKS, INC. Send for information 25c.





58. Information package available from PENN STATE INDUSTRIES describing the specifications and applications of the super 15" scroll saw. Special discount pricing available on current promotion. Free.



59. New and exciting wood shades create the European style! WATCO the original Danish Oil people introduces iced oak and light walnut into its quality line of finishes. These new wood shades compliment today's light, bright look in home and office furnishings. Free brochure.



60. Fully illustrated brochure on the critically acclaimed FELDER Woodworking System. Imported exclusively by ADVANCED MACHINERY IMPORTS, LTD., from Austria, this woodworking equipment is state-of-the-art in combination machinery. Free.



61. Catalog of 200 full-size professional plans. Illustrates & describes plans for building fine, museum-quality furniture, including cradles, roll-top desks, tables, chairs, buffets, beds, chests, gun cabinets, rocking horse, children's furniture and more. FURNITURE DESIGNS CATALOG \$2.00.



62. Professional sanding equipment—SAND-RITE'S brush head sands mouldings and intricate carvings without losing detail or shape of the part. Pneumatic drum gives quick and excellent results on contoured shaped parts. Everything we sell is industrial quality. Free brochure.



63. SCHEPPACH #1 name in stationary equipment. Scheppach from Europe has a full line of stationary equipment and combination machines considered #1 in Europe for quality, design, and lasting value. Dealer inquiries welcome. Catalog \$2. (Refundable with 1st purchase.)

### XYLOPHILE'S

64. 24-page color catalog from the XYLOPHILE'S COMPANY is full of tool bargains from Ryobi, Powermatic Hitachi, Makita, Minimax, Freud and many others. Everything for your shop. Professional quality at down-to-earth prices plus the fast, courteous service you demand. Catalog \$1.00.



65. Earn Instant Cash Part-Time. The MASON SHOE catalog features over 400 men's and women's shoe styles for dress, work and play. Turn your spare time into money. FREE Sales and Starter kit.

WARREN TOOL Co., INC.

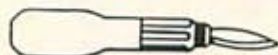

66. WARREN TOOL COMPANY'S Woodcarver's Catalog features the finest quality whittling and carving hand and power tools, books, sharpening stones, wood & supplies. Remember our motto, "Warren Tools give you the edge." We sell only the finest professional tools. Catalog \$1.00.

If you would like more information about advertising in WOOD, contact:

Mark Hart  
WOOD Magazine  
750 Third Avenue  
New York, NY 10017  
212-551-7130

## The Discerning Craftsman Catalog Shop ORDER FORM

Circle the catalogs you want. Fill out the coupon and include your check made out to Better Homes and Gardens® WOOD for the cost of the catalogs you ordered plus the \$2 handling fee. Please allow 4-6 weeks for delivery. Coupon expires August 14, 1989.

### Circle the catalogs you want to receive:

1. FREE	11. \$ 1.00	21. \$ 1.00	31. \$ 1.00	41. \$ 1.00	51. \$ 1.00	61. \$ 2.00
2. \$ 1.00	12. \$ 2.00	22. \$ 1.00	32. \$ 2.00	42. \$ 2.00	52. \$ 1.00	62. FREE
3. \$ 1.00	13. FREE	23. \$ 1.00	33. \$ 1.00	43. FREE	53. \$ 1.00	63. \$ 2.00
4. \$ 1.00	14. \$ 1.00	24. \$ 1.00	34. FREE	44. \$ 1.00	54. FREE	64. \$ 1.00
5. \$ 2.00	15. \$ 1.00	25. \$ .50	35. \$ 1.00	45. \$ 4.00	55. \$ 4.00	65. FREE
6. FREE	16. \$ 1.00	26. FREE	36. \$ 3.00	46. \$ 1.00	56. FREE	66. \$ 1.00
7. \$ 1.00	17. \$ 1.50	27. FREE	37. FREE	47. \$ 2.00	57. \$ .25	
8. \$ 1.00	18. FREE	28. \$ 3.00	38. \$ .50	48. FREE	58. FREE	
9. \$ 1.00	19. \$ 1.00	29. FREE	39. FREE	49. FREE	59. FREE	
10. \$ 1.00	20. FREE	30. \$ 2.00	40. \$ 1.00	50. \$ 1.00	60. FREE	

Send to:  
Better Homes and Gardens®, WOOD  
Dept. JACS8, P.O. Box 5 103  
Pittsfield, MA 01203-5103

I am enclosing:  
\$ 4.50 for priced items  
\$ 2.00 for handling  
\$ 6.50 total remittance

Name \_\_\_\_\_  
Address \_\_\_\_\_  
City \_\_\_\_\_ State \_\_\_\_\_ Zip \_\_\_\_\_

## FINISHING TOUCHES

### WHERE OUR WOOD GOES

Japan buys more American wood and wood products than any other foreign nation. Industry trade data indicates that Japan spent more than \$1.9 billion on U.S. forest



products in 1987. Canada came next, then South Korea, China, and West Germany. Italy, the United Kingdom, Taiwan, Mexico, and Australia made up the second half of our top 10 customers.

### LEARN TO CARVE FROM YOUR EASY CHAIR

Schenectady, New York's public television station, WMHT, has made it possible to learn woodcarving at home from an entertaining friend. At least that's the impression we got from watching a sample program of *Woodcarving with Rick Butz*, a 13-program series produced for that station. The program airs nationally on many PBS channels.

In the series, Butz (pronounced "boots") takes you step by step through a variety of woodcarving projects. From carving his renowned Adirondack characters (see "French Louie," *WOOD* magazine, June, 1987, page 78) to an American eagle, chipmunk, sign, toys, and coat of arms, Rick laces his how-to program with interesting and amusing stories. To chip away with Rick, check your local TV listings.

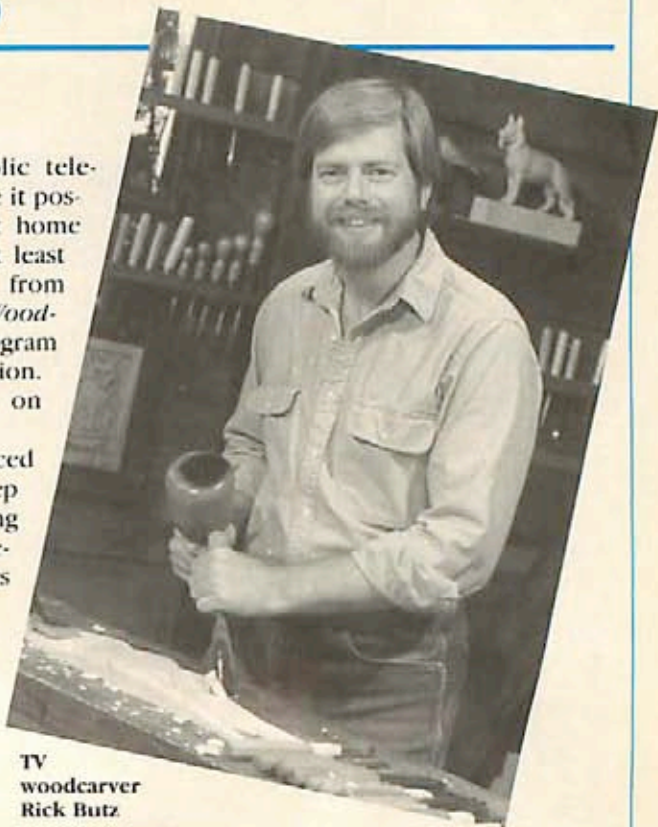

TV woodcarver Rick Butz

### CALIFORNIA REDWOOD LOGGERS FIND TREES WRAPPED IN RED TAPE

California lumber companies that harvest redwood deal with the tightest regulations in the industry, according to the National Forest Products Association. The state requires detailed harvest plans that undergo a 45-day review. Typical plan applications run at least seven pages, include expected erosion hazards and other environmental impacts, and lists of adjoining landowners to be notified. Also, the plan may be subject to public hearings and appeals. California's rules also dictate logging frequency in timber tracts, list the hours of the day loggers fell trees, prescribe the days for log hauling, and allocate the percentage of trees removed.

Yet, the lumber companies don't gripe about the mind-boggling maze of red tape and readily comply with the reams of regulations. It seems that such strict control acts as a two-edged sword. It makes formerly active and vocal environmentalists happy as well as silent. And, the redwood loggers—often maligned as bad guys in the sixties and seventies for pillaging the land—now enjoy a public image as responsible reapers of the resource.



### WOOD CAN'T GET ANY MORE EXOTIC THAN THIS!

You'd have a devil of a time finding goldie wood, red vicis, musk burl, black-heart dorel, and pinkwood at your neighborhood lumberyard. Your queries would only draw blank stares. Unless, of course, you were shopping on the Australian island commonwealth of Tasmania, where these species are commonplace. Or, you talked to Jim Husinger, owner of Berea Hardwoods in Berea, Ohio. He sells them—and other equally exotic Tasmanian wood—as eye-appealing specimens for woodturners and other craftsmen.



"We don't even know the correct botanical names for all of these species," Husinger says about his stash. "This wood comes from one wild, untamed wilderness that has to be cleared for water reservoirs. The government was going to burn the trees."

Through a wood broker living in Tasmania, Jim buys the wood about 30,000 board feet at a time, has it kiln-dried, and foots the shippit for its voyage.

For imagination-boggling descriptions and prices of Jim's Tasmanian hardwoods, call him at 216/243-4452, or write for his brochure: Berea Hardwoods, 125 Jacqueline Dr., Dept. 10, Berea, OH 44017.

Illustrations: Jim Stevenson

# ARE YOU GOOD ENOUGH TO CUT IT?

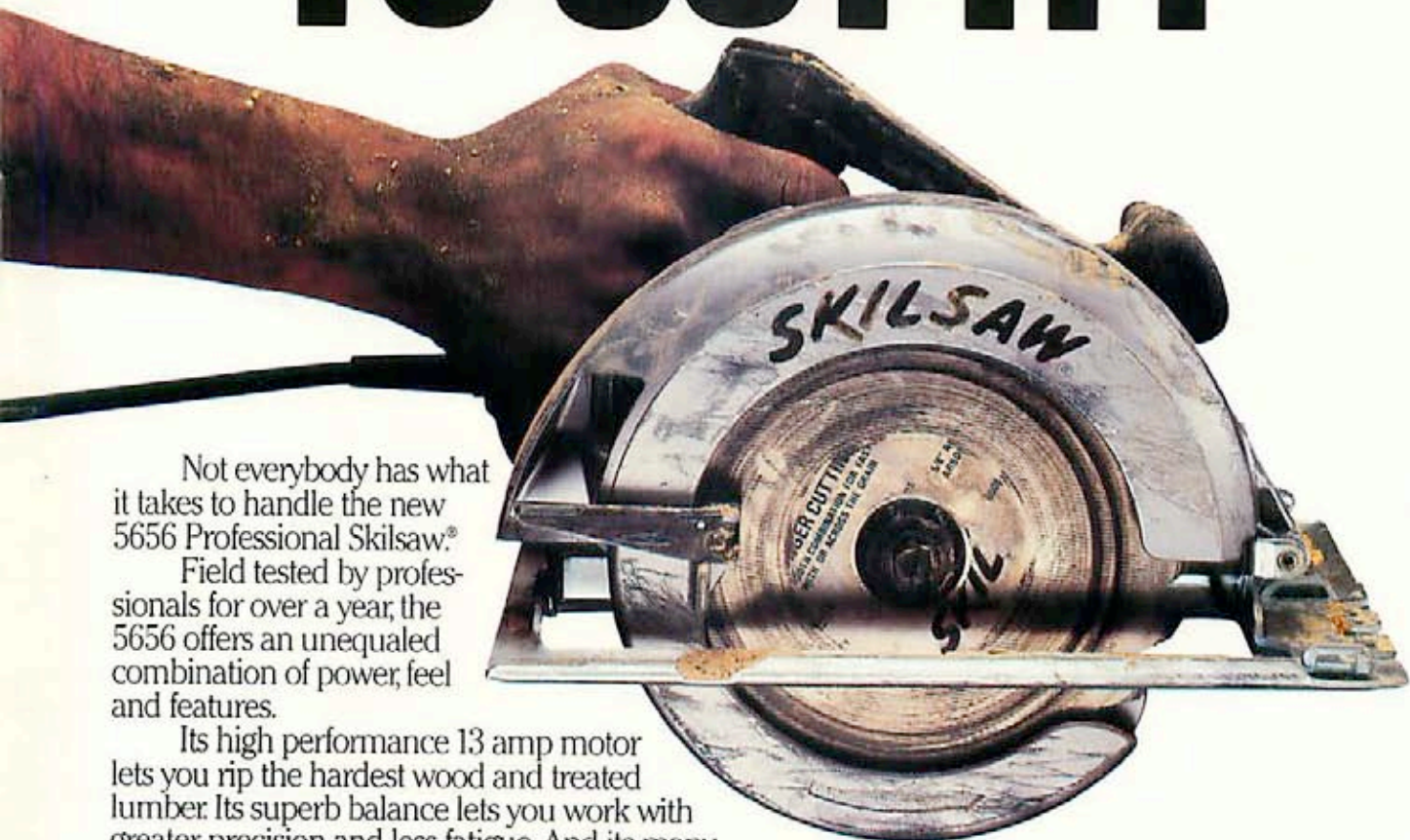

Not everybody has what it takes to handle the new 5656 Professional Skilsaw.<sup>®</sup>

Field tested by professionals for over a year, the 5656 offers an unequaled combination of power, feel and features.

Its high performance 13 amp motor lets you rip the hardest wood and treated lumber. Its superb balance lets you work with greater precision and less fatigue. And its many innovative features, like a patented remote lower guard lift lever, let you do the tough jobs more easily.

Next time you're at your hardware store or home center ask about the new Skil Pro Line of Professional Power Tools.

And see the new Skilsaw 5656 7 1/4" Professional Circular Saw. If you're as good as you think you are, you've earned it.

**SKIL**<sup>®</sup>

At Hardware Stores  
and Home Centers

# What harm can a little water do?



Ordinary Paint: Water pools and soaks in.



New Rust-Oleum Wood Saver: Water beads and runs off.

Ordinary paint can't defend against the damaging effects of water and time. Fortunately, now there's new Rust-Oleum Wood Saver™ paint. A special wood formula with TEFLON\* for twice the moisture protection of ordinary paint. To prevent cracking, peeling and warping.

Try new Rust-Oleum Wood Saver paint. In convenient brush sizes. Handy aerosols. And wonderful colors. Let Rust-Oleum Wood Saver go to work on your wood. Before water does.

**New Rust-Oleum Wood Saver™**  
**If it's going to get wet, get Rust-Oleum:**



**RUST-OLEUM**  
CORPORATION