

# WOOD

**INDEX**  
Projects, tips, techniques  
from issues 17 through 24

THE MAGAZINE FOR HOME WOODWORKERS

\$3.95

OCTOBER 1988 • ISSUE NO. 25

Display until October 11

## 10 LAYOUT TOOLS

no woodworker should be without

## TOUR A MODERN-DAY FURNITURE FACTORY

See page 38

## BECOME A FRAMING PRO

Master the techniques framers use daily to preserve artwork

## START BUILDING HOLIDAY GIFTS NOW!

Kid's wheelbarrow

Mini safe

Bill/key keeper

Turned napkin rings

Rolling pin and rack

Zoo carousel

Cattail centerpiece

Glue caddy

Oval marker

## SHOWCASE YOUR COLLECTIBLES IN THIS CURIO CABINET

See page 60



# You can be sure your Unisaw<sup>®</sup> will last longer than our sale.



## Unless you think we're having a 30-year sale.

We're having a sale, alright. But it's only going to last a few months. But your Unisaw? Get ready for a long-term partnership.

For now, when you buy one of these two rugged, long-lasting 10" Tilting Arbor Saws, you'll save hundreds of dollars.

Take our Unisaw<sup>®</sup>\* with the 3 HP motor, for instance. A real work horse. With power and durability that's perfect for those heavy-duty jobs. Buy one now and you'll only pay \$1499 (\$776 off the list price). Like all our Unisaw models, it comes with a cast-iron table and powerful triple

**3HP UNISAW**  
**\$1499**

V-belt drive. Not only that, this Unisaw comes with the revolutionary UNIFENCE<sup>®</sup> saw guide. So you can step up production without losing any accuracy.

For the homeshop craftsman, our Unisaw<sup>®</sup>\*\*

with the 1 1/2 HP motor and Jet-Lock, Micro-Set rip fence is just what you need. Especially since it's only \$1199. In case you're interested, that's a savings of over \$500. And it delivers perfect precision ripping, crosscutting, dadoing, moulding and tenoning.

Now these prices aren't going to last for long. So choose the model

**1 1/2 HP UNISAW**  
**\$1199**

that best suits you. And get ready to spend a long time with it.

Call-toll free

for the name of your Delta distributor. Delta International Machinery Corp.,

800/438-2486 (in PA, 800/438-2487).

\*Model 34-782 shown with accessory table boards and motor cover.

\*\*Model 34-761 shown with accessory motor cover.

Offer good only at participating distributors in the continental U.S., Alaska and Hawaii from July 1 to December 31, 1988.

**Building  
On Tradition**  
**DELTA**  
A Pentair Company

## We Can't Promise!

These prices may never be this low again!

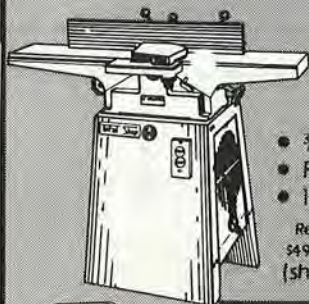

### 6" Heavy Duty Jointer

- ¾ hp, 110v
- Fully adjustable
- 190 lbs.

Reg. \$499.00  
**\$299.00**  
(ships freight collect)

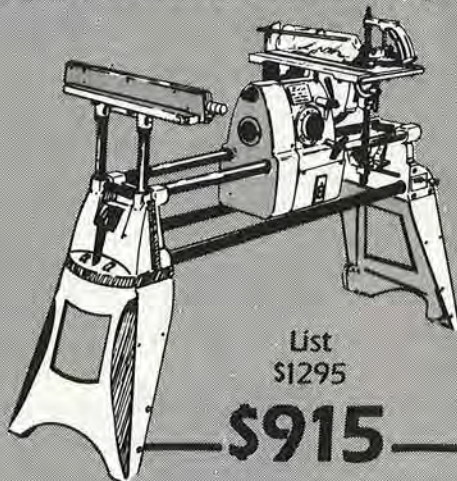

List \$1295

**\$915**

Very soon we'll have to raise our prices, including the tremendous buy on this multipurpose machine. Call now and we will send you 15 more reasons why Total Shop is a better buy than Shoptsmith

**But You Better Hurry!**

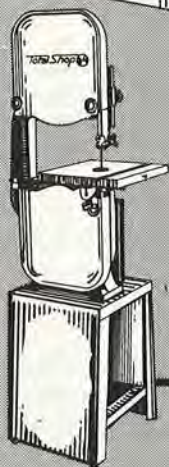

### TS 14-56 14" Bandsaw

- Blade size up to ¾" wide
- Cast iron construction
- 156 lbs.
- ¾-hp

**\$259.00**  
(ships freight collect)

Call Toll Free ☎



**1-800-845-9356**

or in S.C. 288-4174

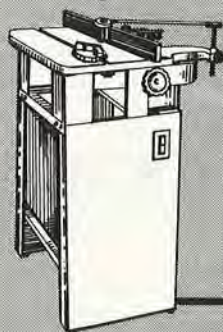

### Wood Shaper

- ½" Spindle
- 1 hp
- Cast iron construction
- Precision fence
- 160 lbs.
- Ball bearings

Reg. \$499.00  
**\$239.00**  
(ships freight collect)



### Dust Collector

- 1 hp, 110v
- 4" inlet
- Commercial quality
- Compact size

Reg. \$348.00  
**\$209.00**  
(Shp. & Hdg. \$30.00)

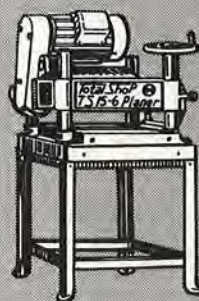

### TS 15-6 Planer

- 110v (owner convertible to 220v)
- Optional stand & Dust Collector Available
- 15" x 6" Board Capacity

**\$795.00**  
(ships freight collect)

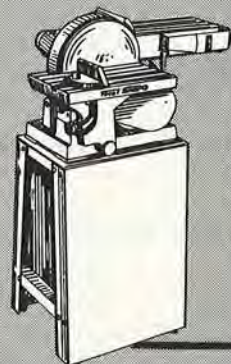

### 6" Belt Sander

- ¾ hp
- 6" x 48" belt
- Cast iron construction
- 152 lbs.
- 9" Sanding Disc Included
- Ball Bearings

**\$199.00**  
(ships freight collect)

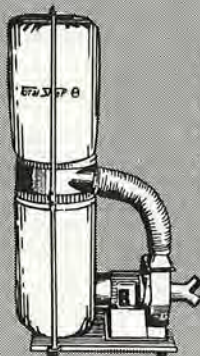

### Industrial Dust Collector

- 2 hp, 110v
- Two 4" inlets
- 1185 CFM
- 125 lbs.

\$499.00 Value  
**\$339.00**  
(ships freight collect)



### 15" Scroll Saw

- Fully adj. table
- 2" cut depth, ¾" stroke
- Free work/storage table. A \$49.00 value
- 25 assorted blades included

**\$199.00**  
(Shp. & Hdg. \$20.00)

30 MINUTE DEMONSTRATION VIDEO

**TotalShop®**



YES! Please send me your free 24 page catalog.

YES! Please send me your 30 minute demonstration video (Enclose \$10.00 refundable deposit - specify VHS or Beta)

P. O. Box 25429, Greenville, SC 29616 Dept. Q

Name \_\_\_\_\_

Address \_\_\_\_\_

City \_\_\_\_\_

State/Zip \_\_\_\_\_

Phone \_\_\_\_\_

**FREE 24 PAGE CATALOG**

Call Toll Free or Write for our newest catalog today **1-800-845-9356**

**NOW!  
REDUCE THE  
RISK AT YOUR  
TABLE SAW**



folds down neatly

WITH THE **MOBILE™  
NEW SAWING CENTER**

**OUTFEED ROLLERS**

- safe, accurate sawing
- available in 15" and 37" widths
- handle panels with ease
- dual-position table

**AND INCREASE FLOOR SPACE**



**MOBILE MACHINE BASES**

- increase shop working area
- maximize usable floor space
- 3 point base will not rock
- locking wheels
- makes machine so easy to use and store
- over 80 standard models

**PLANER STAND WITH ROLLERS**

- raises planer to proper working height
- provides machine mobility
- five-fold increase in workpiece support
- storage is a snap



**NEW**



**ROLLERTABLE  
Rock Solid Support**

- adjustable
- portable
- use at any machine

PEDESTAL  
ROLLER

Discover HTC's many unique products designed only with you, the dedicated woodworker in mind. Find out how you can make your machining safer, increase working area of your shop and accomplish nearly impossible tasks easily, quickly and accurately - **all by yourself!**

**CALL TODAY!**

HTC PRODUCTS, INC.  
120 E. HUDSON S-8  
ROYAL OAK, MI 48067  
(313) 399-6185



**1-800-624-2027 ext. 108**

Better Homes and Gardens®

**WOOD**

This issue's cover wood grain: zebra wood

OCTOBER 1988

ISSUE NO. 25

WOOD PROFILE

**SASSAFRAS: THE LOOK-ALIKE  
WOOD BETTER KNOWN AS TEA 33**

Native Americans have long valued sassafras for its medicinal value. Today's woodworkers treasure sassafras, too, because of its attractive grain. Learn more about an American species with a distinctive aroma.



**CRAFTSMAN CLOSE-UP  
TURNINGS BY THE SEA 34**

The Weston family produces more than exceptional photographs. Neil, a son of Edward Weston, has made a name for himself at the lathe. Find out how Neil turns humongous bowls in Carmel, California.



**CRAFTSMANSHIP  
BY THE CARLOAD 38**

The automated production lines at Thomasville Industries bear several resemblances to your home workshop. Take a closer look at a company that consumes veneer by the mile.



**SHOP-TESTED TECHNIQUES  
YOU CAN FRAME LIKE A PRO 42**

Woodworkers who focus on building an attractive frame may easily overlook the importance of properly preserving artwork. This article shows how to do it!



**HOMEMADE TOOL  
OVAL MARKER 48**

It's a bonus when a reader drops by our shop to show off a device to simplify a tricky task.

**EXOTIC WOOD NAPKIN RINGS 50**

An importer of Central and South American hardwoods shows how he turns thin napkin rings from exotic wood scraps.

**CUMULATIVE INDEX — ISSUES 17 to 24 51**

Our index covering the last eight issues will save you time when you're searching for one of our projects, techniques, or other articles.

**DEVELOP YOUR SHOP SKILLS**

**GET SMOOTH RESULTS WITH YOUR BELT SANDER 55**

A belt sander in untrained hands can severely gouge carefully assembled boards. Don't let this helpful tool get the best of you.

**UNCOMMON STOCKS 56**

Over coffee in Warsaw, Missouri, you're liable to hear folks bragging about the local stock market. That's right: Warsaw's Reinhart Fajen, Inc., produces America's most prestigious line of gun stocks.



**SHOWCASE YOUR COLLECTIBLES WITH THIS STUNNING CHERRY CURIO CABINET 60**

When you build this cabinet, you'll appreciate the four identical sub-assemblies that simplify the construction. Then, watch the cherry cabinet appreciate over the years right along with its valued contents.



**10 LAYOUT TOOLS EVERY WOODWORKER NEEDS 66**

Whether you're drawing precise plans at a drafting table or executing them at your workbench, we have a list of tools you shouldn't be without.

**ON-THE-GO GLUE CADDY 68**

A good idea from our shop organizes your glue and gluing supplies.

**PRESEASON HOLIDAY PROJECTS**

**ROLL OUT THE WHEELBARROW 70**

Our early-bird holiday gift section opens with a pint-size hauler that kids will love.



**FANCIFUL ZOO CAROUSEL 72**

We can just about guarantee that the spinning action of this wild-animal carousel will catch the eye of young and old.



**TURNED ROLLING PIN 74**

You'll appreciate the display rack accompanying this project.



**OAK SAFE AND BILL/KEY KEEPER 77**

Brass post office lockbox doors highlight two practical gifts. Build one as a decorative safe and hang the other for keys and correspondence.



**HANDCRAFTED CATTAILS AND REEDS 80**

Whip up a handful of these roadside favorites in an evening for someone special on your gift list.



**SHORT FEATURES**

Editor's Angle . . . . . 6	Old Hand Ways . . . . . 22
Talking Back . . . . . 10	Lathe Tool Rests . . . . . 26
Tips from Your Shop (And Ours) . . . . . 16	Products That Perform . . . 83
	Magazine Customer Service 96
	Finishing Touches . 104

**DOOR HARPS PLANS & KITS**

**WHAT'S A DOOR HARP?**

Mounted on the inside of your door, a door harp will welcome your guests with a beautiful musical tune each time the door is opened. You'll find it easy to build these door harps in your shop using only standard 3/4" stock and our special Hardware Parts Kits.

Order the project plan and the hardware parts kits below.

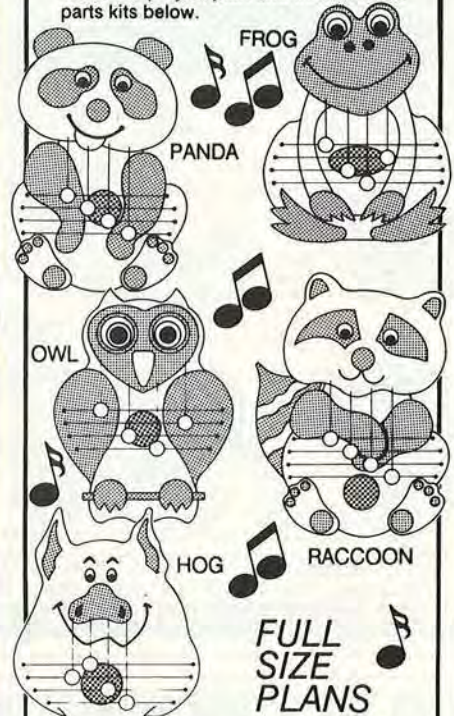

**FULL SIZE PLANS**

**DOOR HARP PLANS**

You'll find our jumbo 22" X 34" blueprints very clear and easy to follow. Full step by step instructions explain every step. All drawings are FULL SIZE.

- #W263 Raccoon plan ..... \$3.50/EA
- #W264 Panda Plan ..... \$3.50/EA
- #W265 Owl Plan ..... \$3.50/EA
- #W266 Frog Plan ..... \$3.50/EA
- #W267 Hog Plan ..... \$3.50/EA
- #W270 Package of all 5 door harp plans above ..... \$12.99/EA

**HARDWARE PARTS KITS**

These kits contain the hard to get parts - special high resonance plywood, tuning pins, clapper balls, music wire and plastic eyes. You need to supply some 3/4" stock, and the paint. Plan is not included with kit, order separately above.

- #7765 Raccoon HDW Kit ..... \$6.50/EA
- #7766 Panda HDW Kit ..... \$5.50/EA
- #7767 Owl HDW Kit ..... \$7.50/EA
- #7768 Frog HDW Kit ..... \$6.50/EA
- #7769 Hog HDW Kit ..... \$6.25/EA

**ADD SHIPPING & HANDLING:**

Mail check or money order and include \$3.50 shipping & handling. MN Res. add 6% tax. Alaska and Hawaii send \$9.50 p&h. Canada send \$15.50 (U.S.) p&h. We accept VISA or MC on orders over \$25.00.

Phone toll free 1-800-441-9870.

MN Res. call (612) 471-8550.

Catalog \$1.00 or FREE with order.

**MEISEL HARDWARE SPECIALTIES**

P.O. BOX 70 W-9 MOUND, MN 55364

# WOODWORKER'S PLANS & PARTS

## Heirloom Rocker

Build our classic rocking horse and create a family heirloom which will delight the children in your family for generations to come.



This great rocker sells at craft shows for over \$300.00

Size 35" x 58"

Plans are Full Size

Order Plan #400  
Only \$10.25



This collection of 5 toy vehicles will delight the heart of any youngster lucky enough to own them. They range in size from 12" to 18". Plan set #18004 \$12.75



FULL SIZE PLANS

Door Harp Plans

Set of four award winning Door Harp Plans \$12.50

New Design No Fret Bar



Plans include Stencil Design

Hardware Kit for all four harps (no plywood) \$12.50



Music Wire 25' for \$2.50

Tuning Pins .30 each 100 for \$18.00



Door Harp Plywood Harps require 2 pcs. \$1.00 per piece

## Low, low prices on wood parts

Smooth Maple Wood Wheels Eight Sizes

WT-3/4"	\$4.50/100
WT-1"	\$5.00/100
WT-1-1/4"	\$7.00/100
WT-1-1/2"	\$10.00/100
WT-1-3/4"	\$15.00/100
WT-2"	\$18.00/100
WT-2-1/4"	\$5.00/20
WT-2-1/2"	\$7.00/20

Axle Pegs AP-1 fits 1" to 2" \$4.00/100

Full Round Wood Balls Four Sizes  
BA-3/4" \$8.00/100  
BA-1" \$10.00/100  
BA-1-1/2" 25 each  
BA-2" 60 each

Shaker Peg Candle Cup  
Reg. Peg \$16.00/100  
Mini-Peg \$6.00/100  
Candle Cup \$16.00/100  
Mini-Cup \$7.00/100  
Tie Peg \$6.00/100

# LOOK! NO HANDS NEAR THE BLADE

STRAIGHTER CUTS  
NO KICKBACKS  
NO ADJUSTMENTS  
KEEPS FINGERS SAFE!



The RIPSTRATE is now an indispensable tool in tens of thousands of amateur, professional, school, corporate, government and military shops. Isn't it time you joined them?

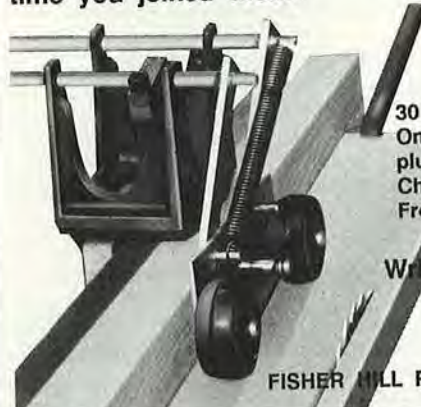

30 day money back trial.  
One year guarantee. \$69 plus \$50 for shipping.  
Check, M.O., Visa or M.C.  
Free brochure.

Write, or call toll free:  
1-800 421 0256

FISHER HILL PRODUCTS 4 Fisher Hill  
Fitzwilliam NH 03447

# RIPSTRATE®

# WOOD PARTS FROM MIDWEST DOWEL WORKS

## Compare Our Low Prices!

	Qty.	Cost
3-1/2" Poplar Shaker Peg	\$15/100	---
1-3/4" Mini Shaker Peg	\$7/100	---
3-1/2" Country Wall/Mug Peg	\$15/100	---
2-1/2" Country Shorty Peg	\$12/100	---
Large Bean Pot Candle Cup	\$17/100	---
Brass Inserts	\$9/100	---
1/2" Mini Candle Cup	\$10/100	---
1-1/2" Toy Wheel	\$10/100	---
2" Toy Wheel	\$17/100	---
Axel Pegs	\$4/100	---

## SMOOTH SANDED HEARTS

3/4" x 1/8" Hearts	\$2.75/100	---
3/4" x 1/2" Hearts	\$4.50/100	---
1" x 3/16" Hearts	\$6/100	---
1" x 3/8" Hearts	\$7/100	---
1-3/8" x 1/8" Hearts	\$7/100	---
1-3/8" x 1/4" Hearts	\$8/100	---
1-3/8" x 1/2" Hearts	\$10/100	---
2" x 1/2" Hearts	\$18/100	---

## Great Buys!

	Qty.	Cost
3/8" x 36" Standard Dowels	\$21/100	---
3/4" x 36" Oak Dowels	\$15/10	---
3/8" Maple Buttons	\$2.15/100	---
1/2" Maple Buttons	\$2.25/100	---
1-1/2" Maple Spindles	\$9/100	---
2-1/8" Maple Spindles	\$18/100	---

## ORDER NOW

MC/Visa  Check Enclosed

Total Cost \_\_\_\_\_

Handling \$3.00

Ohio residents add 5% sales tax \_\_\_\_\_

Final Cost \_\_\_\_\_

MC/Visa Number \_\_\_\_\_

Expires \_\_\_\_\_ Phone \_\_\_\_\_

Name \_\_\_\_\_

Address \_\_\_\_\_

City/State/Zip \_\_\_\_\_

## FREE 16-PAGE CATALOGUE

Circle this section for FREE Dowels - mixed pack, Maple, Oak, Walnut Cherry, from 1/4" up to 1" Approximately 10 LFT. 14" long. \$5.00 value with any order.

## MIDWEST DOWEL WORKS

4631 Hutchinson Road  
Cincinnati, Ohio 45248  
(513) 674-8488

Same Day Service | Order before Noon  
Factory Direct | Satisfaction Guaranteed

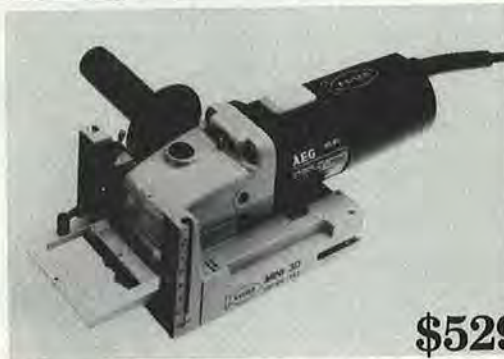

\$529!!!

The Kaiser plate joining machine will save you time and make joining wood for cases, cabinets, and raised panel doors a snap. User friendly features include: easy blade changes, a non-slip/non-marring rubber faceplate, easy to reach switches, simple adjustments and a super tough AEG motor. The perfect plate joiner for the serious woodworker.

Biscuits are made of compressed beechwood that expands when glued into place. Joints become so strong that the wood around the joint will break before the biscuit fails. Unique fence design allows 0-90° jointing and cutting for plates up to 12" from the edge of your boards.

w.s. JENKS & Son



1-800-638-6405 TOLL-FREE

Better Homes and Gardens®

# WOOD®

THE MAGAZINE FOR HOME WOODWORKERS

October 1988 • Vol.5, No.5 • Issue No. 25

### Editorial/Art Staff

Editor **LARRY CLAYTON**  
Managing Editor **CARL VOSS**  
Art Director **C. L. GATZKE**  
Design Editor **JAMES R. DOWNING**  
Features Editor **PETER J. STEPHANO**  
How-To Editor **MARLEN KEMMET**  
Products/Techniques Editor **BILL KRIER**  
Project Builder **JAMES E. BOELLING**  
Senior Graphic Designer **PERRY A. McFARLIN**  
Administrative Assistant **DARLENE REYNOLDS**  
Business Office Clerk **JODI DOWNING**

Technical Consultants: Product Testing **GEORGE GRANSETH**;  
Wood Technology **PAUL L. McCLURE**; Collectible Tools  
**PHILIP WHITBY**

Publisher **JERRY KAPLAN**  
National Advertising Manager **TERRY McINTYRE**  
Advertising Representatives **ANTHONY IMPERATO**,  
**ROBERT NEWKIRCHEN**, **JASON B. WEINGER**  
Promotion/Research Director **THOMAS R. TROLAND**  
Marketing Services Manager **NANCY DALY**  
Circulation Director **CLEM SEVDE**  
Circulation Manager **BILL REED**  
Production Director **DALE SCHENKELBERG**  
Editorial Research Director **C. RAY DEATON**

### Weekend Woodworking Projects™

Managing Editor **JIM HARROLD**

### Magazine Group Officers

Group President **JAMES A. AUTRY**  
Group Vice Presidents: Publishing Directors **ADOLPH AUER-  
BACHER**, **MYRNA BLYTH**, **BURTON H. BOERSMA**,  
**CHRISTOPHER M. LEHMAN**; Controller **MAX RUNCIMAN**;  
Editorial Director **DORIS EBY**; Operations **DEAN PIETERS**  
Chairman of Executive Committee **E. T. MEREDITH III**

### Corporate Officers

Chairman of the Board **ROBERT A. BURNETT**  
President **JACK D. REHM**  
Group Presidents: Book **JERAMY LANIGAN**; Broadcasting **W. C.  
McREYNOLDS**; Magazine **JAMES A. AUTRY**; Real Estate  
**ALLEN L. SABBAG**  
Vice Presidents: Administrative Services **GERALD D. THORN-  
TON**; Corporate Relations **DONALD L. ARNOLD**; Finance  
**JAMES F. STACK**; General Counsel and Assistant Secretary  
**THOMAS G. FISHER**; Product Development **NEIL KUEHN**  
Secretary **BETTY CAMPBELL MADDEN**  
Treasurer **MICHAEL A. SELL**  
Controller **LARRY D. HARTSOOK**

Better Homes and Gardens® WOOD® — the magazine for home woodworkers (ISSN-0743-894X) is published bimonthly in February, April, June, August, October, and December by Meredith Corporation, Locust at 17th, Des Moines, IA 50336. Second-class postage paid at Des Moines, Iowa. Better Homes and Gardens trademark registered in Canada and Australia. Marca Registrada en Mexico. **SUBSCRIPTION PRICES:** One year \$18 in the United States and its possessions. Canada and other countries add \$6 per year. **POSTMASTER:** Send address changes to WOOD, Locust at 17th, Des Moines, IA 50336. October 1988, Vol. 5 No. 5, Issue No. 25. **CUSTOMER SERVICE:** For service on your magazine subscriptions, including change of address, write to Customer Service Manager **ROBERT AUSTIN**, P.O. Box 10628, Des Moines, IA 50336. Please enclose your address label from a recent issue. If you wish to phone, call toll-free 1-800-678-2666. ©COPYRIGHT MEREDITH CORPORATION 1988. ALL RIGHTS RESERVED. PRINTED IN U.S.A.

# NOW! TIMELESS BEAUTY... IN NO TIME AT ALL.



© Minwax is a registered trademark. © 1988 Minwax Company Inc.

## Announcing WoodSheen™ Rubbing oil stain and finish in one easy step.



A traditional finish used to take days to achieve. Now, with new WoodSheen by Minwax, you can have the look of a deep, hand-rubbed finish in just two hours! Simply wipe it on with a cloth—in one easy step, you'll have rich color and a tough protective Danish oil finish. New WoodSheen penetrates deep into wood, so it highlights the beauty of the grain. And it dries in just two hours! Available in 6 rich colors plus Natural.

For a free copy of Tips on Wood Finishing write to Minwax Co. Inc., Dept. WO-118, P.O. Box 426, Little Falls, NJ 07424.



## Sell Mason Sport & Work Boots and earn instant commission



BE A MASON DEALER and sell our rugged, quality-made sport and work boots to your friends and neighbors. Earn instant cash commissions from \$10.00 to \$20.00 per hour. Absolutely no investment required. All you do is show the full-color Mason catalog to your customers. Let them select from over 400 styles of footwear for men and women. Write for details.

**MASON SHOE MFG. CO., Dept. F-770**  
Chippewa Falls, WI 54774

Please rush giant FREE catalog & dealer starter kit to:

NAME \_\_\_\_\_  
ADDRESS \_\_\_\_\_  
CITY \_\_\_\_\_  
STATE \_\_\_\_\_ ZIP \_\_\_\_\_















Send for FREE Sales Kit, Mason Shoe Mfg. Co. Chippewa Falls, WI 54774 or call Toll Free 1-800-826-7030, Ext. F-770.

# CARBIDE TIPPED ROUTER BITS

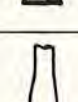
## PROFESSIONAL PRODUCTION QUALITY

1000's SOLD TO READERS OF FINE WOODWORKING

BEST CUT BEST PRICE	ITEM NO.	DESCRIPTION	RADIUS	LARGE DIAM.	CUTTING LENGTH	PRICE
		COVE				
	#01	1/4" R	1/4"	1"	1/2"	\$13.00
	#02	3/8" R	3/8"	1-1/4"	9/16"	14.00
	#03	1/2" R	1/2"	1-1/2"	5/8"	15.00
		ROUND OVER				
	#04	1/4" R	1/4"	1"	1/2"	\$15.00
	#05	3/8" R	3/8"	1-1/4"	5/8"	16.00
	#06	1/2" R	1/2"	1-1/2"	3/4"	19.00
		ROMAN OGEE				
	#07	5/32" R	5/32"	1-1/4"	15/32"	\$18.00
	#08	1/4" R	1/4"	1-1/2"	3/4"	20.00
		Deep RABBETING	3/8"	1-1/4"	1/2"	\$14.00
	#09	1/8" (KERF) SLOT CUTTER		1-1/4"	1/8"	14.00
	#10	1/4" (KERF) SLOT CUTTER		1-1/4"	1/4"	14.00
		45° Chamfer	45° Angle	1-1/2"	5/8"	\$15.00
	#12					
		20° Angle				
	#15	Raised Panel	20° Angle	1-5/8"	1/2"	\$25.00
						
	#35	1/4" V Groove 90°	1/4"	1/4"		\$ 8.00
	#36	3/8" V Groove 90°	3/8"	3/8"		9.00
	#37	1/2" V Groove 90°	1/2"	1/2"		11.00
	#16	3/8" Dovetail 9°	3/8"	3/8"		\$ 7.50
	#80	1/2" Dovetail 8° (For Leigh Jigs)	1/2"	13/16"		12.00
	#17	1/2" Dovetail 14°	1/2"	1/2"		8.50
	#18	3/4" Dovetail 14°	3/4"	7/8"		10.50
		CORE BOX (ROUND NOSE)				
	#19	3/8" Core Box	3/16"	3/8"	3/8"	\$11.00
	#20	1/2" Core Box	1/4"	1/2"	11/32"	14.00
	#21	3/4" Core Box	3/8"	3/4"	5/8"	18.00
	#056	Tongue & Groove (FOR WOOD THICKNESS FROM 1/2" TO 1")		1-5/8"	1"	\$30.00
	#24	1/4" Straight Bit	1/4"	3/4"		\$ 7.00
	#25	5/16" Straight Bit	5/16"	1"		7.00
	#26	3/8" Straight Bit	3/8"	1"		7.00
	#27	1/2" Straight Bit	1/2"	1"		7.00
	#28	3/4" Straight Bit	3/4"	1"		10.50
	#13	1/2" FLUSH TRIM	1/2"	1"		\$ 8.50
	#14	3/8" KEY HOLE (This Bit Only HSS)				\$ 8.50
		CUTS 3/8" KEY HOLE FOR FLUSH MOUNTING PICTURE FRAMES, ETC.				

WHEN ORDERING ANY THREE OR MORE DEDUCT \$1.00 EACH  
ALL PRICES POSTAGE PAID

Professional Production Quality • 1/2" Ball Bearing Pilot  
• 1/4" Diameter Shanks x 1-1/4" Long • One Piece Construction  
• Two Flute Thick High Quality Tungsten Carbide Tips

To order by MasterCard or Visa Toll Free  
7 Day—24 Hour Order Service Call  
1-800-533-9298

or send check to:

MLCS Ltd., P.O. Box 4053D, Rydal, PA 19046

## THE EDITOR'S ANGLE

# BRIAN TAKES THE BLUE... AGAIN



At the Iowa State Fair, Brian Gutzmer and *WOOD*® magazine Project Builder Jim Boelling show off Brian's blue-ribbon-winning 4-H project.

So far, 15-year-old Brian Gutzmer from rural Council Bluffs, Iowa, has a perfect record. Every time he enters a woodworking project in a 4-H competition—most recently at the Iowa State Fair—the judges see blue. I'm happy to report that *WOOD* magazine had a small part to play in Brian's latest award-winning achievement—he built the thickness sander from our October 1985 issue.

Of course, Brian does have the edge on his competition. This fine young woodworker got his start in woodworking at age 2 when, with his first hammer and saw, he signed on as a "remodeling helper" for his dad, Marlin. No wonder he's so successful!

As you probably know, 4-H projects follow a certain theme each year. This time, it was "projects that extend resources." So the young wheels started turning, and Brian decided to use some wood that he and his dad had sawed from logs on their farm. "I used red elm where I needed strength and walnut on those parts that required hardness," Brian told me. To further extend his resources, this frugal woodworker recycled the plastic-laminated top from an old table for the sander feed table.

Brian also kept track of the material costs as part of his project. Even counting the \$23.50 he invested in pillow blocks and bearings and another \$10 for a used motor and pulley, Brian completed the project for less than \$60. Now that's a bargain.

Keep up the good work, Brian. 🍀

 Print this article

*Larry Clayton*

*P.S. Brian wrote me not long ago and said that for this year's project he's building a 12x20' workshop! We could be looking at a future *WOOD* magazine project builder here, folks.*

Photograph: Craig Anderson



# MOST POPULAR.



The Skil Twist® Cordless Power Screwdriver: The world's best selling cordless power tool.

# MOST POWERFUL.



The Skil Top Gun™ Professional Cordless Drill: The most powerful cordless drill sold in America.

And most everything in between. That's the new Skil cordless line. Ten tools from 2.4 to 12 volts with the most power, the most features and the most for your money. Look for them at your hardware store or home center. And don't settle for anything less.

At Hardware Stores and Home Centers



Skil Corporation, Subsidiary of Emerson Electric Co., 4300 West Peterson Avenue, Chicago, IL 60646. Skil Twist and Top Gun are trademarks of Skil Corp. © 1988 Skil Corp.

# The Number One Do-It-Yourself Book Club

# Take any

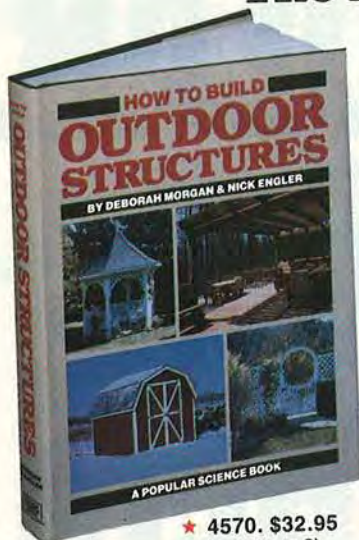

★ 4570. \$32.95  
(counts as 2)

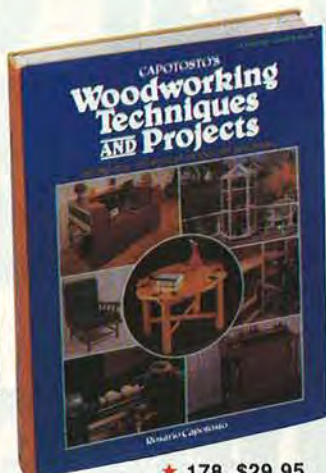

★ 178. \$29.95



★ 4536. \$32.95  
(counts as 2)

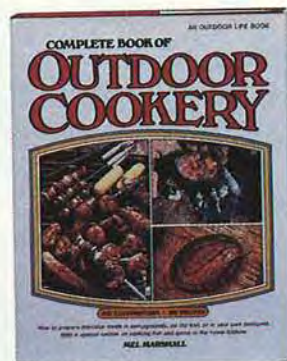

★ 166. \$26.50

# Popular science

## BOOK CLUB

A Service of Grolier Book Clubs, Inc.

P.O. Box 2006, Latham, N.Y. 12111

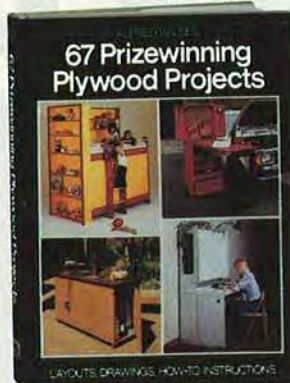

★ 4501. \$27.95  
(counts as 2)

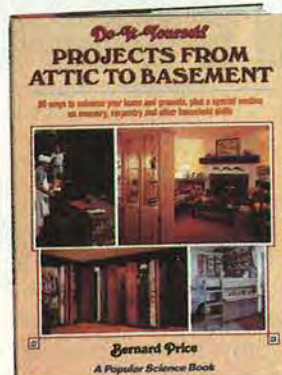

★ 4508. \$29.95



5821. \$39.95

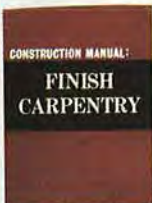

5753. \$11.95



★ 89. \$19.95



★ 97. \$19.95



★ 105. \$17.95



5994. \$19.95



★ 113. \$15.95



★ 1978. \$17.85 Paperbound



3 Books—count as 1



6085. \$24.95



6056. \$17.50



5831. \$19.95



6041. \$16.95

*Mail card today!*

## The #1 DO-IT-YOURSELF BOOK CLUB

**The Best How-To Authority...** Popular Science Book Club is the largest and oldest special-interest book club serving successful do-it-yourselfers for more than 25 years!

**The Best Do-It-Yourself Books...** PSBC editors comb the country searching for the newest, finest and often hard-to-find books on today's important homeowner subjects: HOME REPAIR & IMPROVEMENT • HOME REMODELING, RENOVATION • RESIDENTIAL CARPENTRY • BASIC & ADVANCED WOODWORKING • HOME WORKSHOPS • HOUSE BUILDING • HOUSE WIRING, PLUMBING, HEATING, MASONRY & CONCRETE • APPLIANCE REPAIR and much more.

**Exclusive "Popular Science Books"...** PSBC serves its members best by commissioning the top how-to writers-photographers to produce definitive books on important Club subjects. See titles with ★. These are cream-of-the-crop, do-it-yourself books available nowhere else at Club discount.

**Big Bargains—UP TO 75% DISCOUNT...** PSBC cuts prices on hundreds of special book bargains offered throughout the year to the membership.

**Quality Production Control...** PSBC selections are printed with careful attention to detail on paper, printing, binding. You'll use these books for years!

**NO-RISK GUARANTEE...** PSBC guarantees your complete satisfaction—or you may return the books at our expense.

offers you super savings up to \$104.90!

**3** for just **\$4.95** Values up to \$109.95!

with No-Risk Free Trial Membership  
in Popular Science Book Club

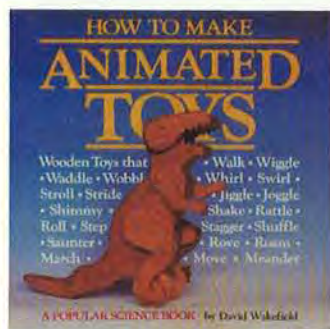

★ 4538. \$29.95 (counts as 2)



6027. \$16.95

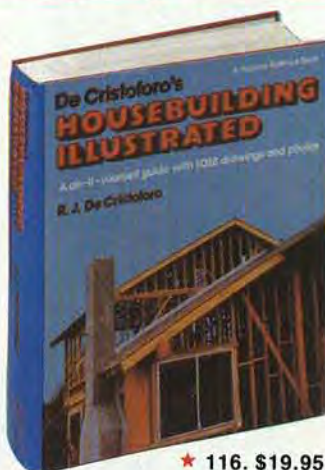

★ 116. \$19.95



5878. \$21.95

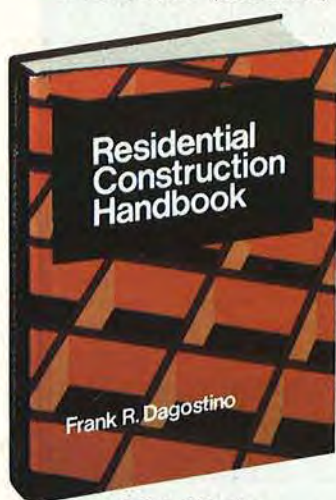

5858. \$39.95

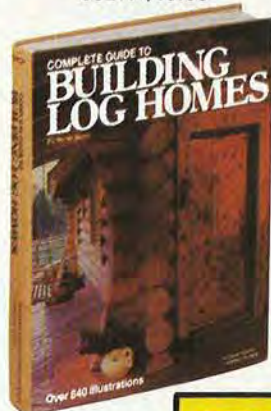

★ 190. \$29.95 (counts as 2)



★ 4569. \$14.95 Paperbound

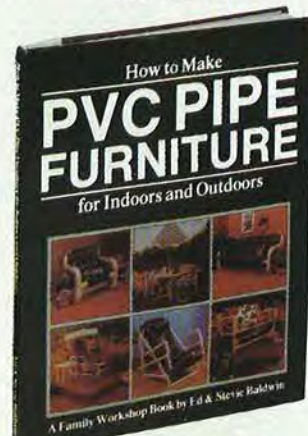

6002. \$14.95

**FREE** when you join

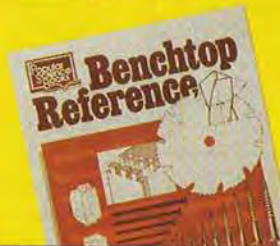

The **BENCHTOP REFERENCE** gives you instant answers to hundreds of do-it-yourself questions on Woodworking, Joinery, Dowels, Veneers, Laminates, Fasteners, Sharpening, Grinding, Concrete, Electrical work, more! 48 big 8 x 10 3/4 pages. All illustrated! Super handy and indispensable.

**HOW Popular Science BOOK CLUB WORKS**

**ENJOY SAVINGS UP TO \$104.90 NOW...** When you take any 3 selections here for just \$4.95 plus delivery and handling. Simply indicate your choices on the attached postage-free card and mail.

**CLUB MEMBERS' BULLETINS...** Fifteen times a year (about every 4 weeks), you'll receive a Club Members' Bulletin package describing the coming Main Selection and nearly 100 additional books you may choose from. If you want the Main Selection only, do nothing; it will be sent to you automatically. If you want another book—or no book—indicate your wishes on the form provided and return by date shown. You will always have at least 10 days to do this. Should the bulletin arrive late and you receive an unwanted selection, you may return it at our expense.

**UP TO 75% DISCOUNTS...** Club prices range from \$5.99 for special book bargains offered at super savings up to 75% and even more... all the way to richly-produced, very special books that list as high as \$50 and more—all offered to members at exclusive Club discounts.

**FREE GIFT with cancellation privilege...** You may cancel your membership at any time after buying just two more selections of your choice within a year. To try us with no obligation, simply mail the attached card—a valuable FREE GIFT is yours to keep just for looking. Mail the card now!

PS/89D



★ 1988. \$17.85 Paperbound

5985. \$17.95

★ 109. \$15.00



5882. \$19.95

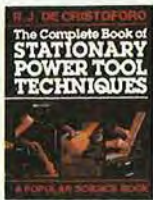

★ 84. \$31.95 (counts as 2)



6176. \$19.95



★ 194. \$32.95 (counts as 2)

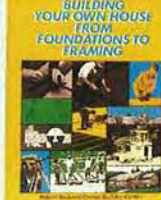

6033. \$27.95 (counts as 2)

# ABBEY TOOLS

WE OFFER DISCOUNTS UP TO 50% AND MORE

Prepaid Freight to 48 States Any Item This Page

## PORTER-CABLE

MOOD DESCRIPTION	Sell
100 7/8 HP Router IIII	95
126 Door Planer	165
130 Laminata trimmer	123
312 Offset trimmer	132
314 4 1/2" Panel Saw	124
319 Tilt base trimmer	130
330 Block Sander	54
345 NEW! Saw Boss	109
361 3x24 Belt Sander	179
363 4x24 Belt Sander	189
504 HD 3x24 Sander	332
505 1/2" Sheet Sander	109
513 Lock Mortiser	679
518 3 HP Spdronic Router	329
520 3 HP Router	299
555 NEW! Palm jointer	159
627 2 speed Tiger Saw	135
690 1 1/2 HP Router	129
5060 NEW! Stair Template	135
7556 1/2" Right Angle Drill	189
7564 1/2" Spd Handle Drill	149
9100 7/8 HP Classic Router	129
9118 Porta Plane w/case	189
9381 Hinge Temp. w/case	149
95839 Hinge Temp. access kit	99
43263 Carbide cutter for #126 Porta Plane	49

### NEW! FROM PORTER CABLE



**555 BISCUIT JOINER**



**Model #345**

### SAW BOSS \$109

### BIESEMEYER FENCES

52" Commercial System	289
52" HomeShop System	219
40" HomeShop System	199
28" HomeShop System	189



### Hitachi Power Tools

C8DA 6 1/2" Cordless Saw	129
DRG10 3/8" Cordless Drill	89
D10DC same as DRG10 w/VR	99
TR12 3 HP Plunge Router	179
PDL180 7" Disc Grinder	119
C10FA 10" Miter Saw	269
CR10V Var Spd Recip Saw	109
W6VA C-2600 RPM Screwdriver	89
D510 V 3/8" Mini Grinder	79
PDM100C 4" Mini Grinder	59
PDM125C 5" Mini Grinder	65

### MAKITA BATTERY PACK SPECIAL

9.6 VOLT.....	29
7.2 VOLT.....	28



**Milwaukee Tools**  
HEAVY DUTY SAWZALL, CASE

# freud

	Carbide
LM72M010 10x24T Rip	39
LUT3M010 10x60T ATB	39
LU82M010 10x60T TCG	43
LU84M011 10x60T Combo	38
LU84M012 10x60T Combo	69
LU85M010 10x60T ATB	59
LU85M014 14x48 ATB	99
PS303 7 1/4"x40 ATB	24
PS306 10x40 ATB	29
DS308 8" Dado set	109
FB100 16 pc Forstner Bit Set	149
DB350 50 pc Drill Bit Set	59
90-100 15 pc Router Bit Set	145



**NEW! From Freud**  
94-100 5 pc Raised Panel door router Bit Set 149  
SC001 Blade Stabilizer 179  
EC260 Sides/Rail Shaper Set 165  
EC900 Shaper Door System 285  
EC210 thru EC213 Raised panel shaper cutters...each 89  
99-210 thru 99-213 Raised panel router Bits...each 58  
99-034 Lock Miter Router bit 89  
99-281 Ogee Sile and Rail set 89  
99-283 Cove/Rail Siles/Rail 83  
99-PK1 Multimorph Router bit 75  
WB 101 Woodworking Box 277

**NEW! From Freud**  
Biscuit Joining Machine comes with carbide blade assortment of biscuits instructions & case  
JS100 price \$164  
0-10-20 100 biscuits 29.50  
1000 Mixed biscuits 32.00

### RYOBI POWER TOOLS



**RYOBI POWER TOOLS**  
AP10 10" Surface Planer 359  
E3800 C-4000 Drywall driver 79  
E3810 C-2500 Drywall driver 79  
JSE60 Var. Spd Jig Saw 119  
RU100VK VS Recipro Saw 109  
S900A Block Sander 39  
SP1800A 7" Sander/Polisher 129  
TR80U Laminata Trimmer 84  
TS251U 10" Miter Saw 179  
TS380 14" Miter Saw 359  
W201S 18 1/4" Beam Saw 329  
RA200 8" Portable Radial Arm 249  
BD10R Cordless Screwdriver 47  
R500 Plunge Router 169  
X2546 AP10 Planer Blades 28

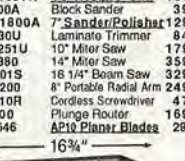

**RYOBI POWER TOOLS**  
AP10 10" Surface Planer 359

### Skill Tools

77 7 1/4" Wormdrive Saw	134
Golden Anvils Mod	54
5150 7 1/4" Circ Saw 2 1/2 HP	79
5510 5 1/2" Circular Saw	79
597 3/8" Vsr Drill	59
6533 3/8" Vsr Drill 3.5 Amp	79
6625 3/8" Vsr Drill 5.0 Amp	109
6650 1/2" Vsr Drill 5.0 Amp	149
768 Palm Sander	35
7235-04 VSR 3 1/2" Cordless drill 12 Volt w/ Extra Bat & case	139

### ABBEY TOOLS

A DIVISION OF ABBEY MACHINERY  
516 NORTH BROOKHURST STREET • ANAHEIM, CALIFORNIA 92801  
ORDER BY PHONE — WE ACCEPT VISA, MASTER CARD, CHECK, MONEY ORDER  
Toll Free 1-800-225-6321 Calif. 1-800-252-2221  
Orange County (714) 772-7222  
PRICES SUBJECT TO CHANGE WITHOUT NOTICE  
Calif. Residents Add 6% Sales Tax

# Makita

1100 3 1/4" Planer w/case	187
1900BW 3 1/4" Planer kit	124
2708 6 1/4" Table Top Saw	229
3601B 1 3/8 HP Router	129
5612BR 3/8" Plunge Router	169
5612B same w/ Square base	169
3200N 4 3/8" Trim Saw	109
5077B 7 1/4" Hypoid Saw	149
5081DW 3 3/8" Cordless Saw	125
5402A 16 3/4" Beam Saw	329
5500DW 6 1/4" Core-Cut Carc Saw	169
5612HD 3/8" Cordless Router	114
60R20D 3 3/8" VS Cord Scroull	149
60R30D same w/clutch	129
6510LVR 3/8" VSR Drill	69
6800DBV C-2500 Drywall cut	89
6905B 1/2" Impact Wrench	166
6906 3/4" Impact Wrench	319
8419B2W 3/4" Hammer Drill	149
9030 1" Belt Sander	139
9207SPB 7" 2 Spd Sander/Polish	149
9501BK 4" Mini Grinder	75
9820-2 Blade Sharpener	169
9924B 3x24 Belt Sander	129
DP4760 1/2" VSR Drill	107
JR3000V VS Recip Saw	124
Carbide Planer Blades for MAKITA 1100 81900B	29

### 3 HP Router Square Base



**3 HP Router Square Base**  
3612B \$169

### MAKITA CORDLESS TOOL ONLY

4300D 3/4" Cord Saw	59
6012HD 9.6v 2 spd drill w/clutch	59
6092 9.6v VSR w/ clutch	69
DA3000D7 2v right angle drill	76

### Englo Compressors

3/4 H.P. 115 Volt 125 PSI	275
AM77-HC2 1.5 Gal. Single Tank	259
AM39-HC4 3.8 Gal. Twin Tank	279
AM39-HC6V 3.8 Gal. Twin Tank	279

### BLACK & DECKER



3310 1 1/2 HP Router	119
1179 3/8" Drill 0-1200	79
1980 3/8" Cordless drill	99
1987 3/8" Vsr Cordless drill	119
3051 7 1/4" Wormdrive Saw	119
3103 2 Sp. Cut Saw w/case	89
4010 Palm Sander	38
6513 1/2" Impact Wrench	119
98003 Cordless Drill Battery	38

### SENCO FASTENING SYSTEMS

### Nail Guns

LSII Brads 5/8" to 1"	220
SFNI Finish Nails 1 1/2" to 2"	259
SFNIII Finish 1 1/2" to 2 1/2"	349
SKS Narrow Crown Stapler	229

Call for other Nail Gun Prices

### Bosch Power Tools

1581 VS Orbital Action Jig Saw	129
1198 1/2" Hammer Drill	127
11203 1 1/2" Rob Hammer	429
11212 3/4" VSR Roto Hammer	199
11305 30 lb Demo Hammer	695
1604 1 3/4 HP Router	118
91084 3/8" VSR Mdrgr Drill	89
1608T 1 1/2" Base Lam Trimmer	89
1609K Lam Trimmer Kit	155

## TALKING BACK

We welcome comments, criticism, suggestions, and even an occasional compliment. The volume of mail we receive makes it impossible to answer every letter, but we promise to do our best. Send your correspondence to: Letters Editor, Better Homes and Gardens® WOOD® Magazine, Locust at 17th, Des Moines, IA 50336.

### BUCKLED UP IN TENNESSEE

Thank you for the belt-buckle article in the December 1987 issue of WOOD magazine. I saw Christmas presents for my family and friends in that project. I didn't have any special woods like the ones shown in the article, but I did have some walnut and white oak logs to use as the base for the buckle. I also

had some scrap cedar, red oak, poplar, sassafras, and even some ebony salvaged from an old piano.

First, I glued the accent wood between the oak or walnut. With a piece of double-faced tape, I mounted a 2x4 "jobber stick" to the back of the blank so I could safely sand at my disc sander. I sanded down to a 320-grit, and switched to hand-sanding for a 400- or 500-grit finish. I then applied four or five coats of tung oil, two coats of a gloss finish called True Oil, and two coats of wax.

I finished 40 buckles for Christmas gifts!  
—Thomas J. Gillard Jr., Tullahoma, Tenn.

Sounds like you were a busy Christmas elf, Tom. You must be one of those guys who doesn't throw away any scraps of wood!

### DON'T FORGET TABLE BOTTOMS

I'd like to comment on David Sloan's letter in the February 1988 issue of WOOD magazine about stabilizing wood by using a finish. I wonder if education is replacing common sense.

I agree that there are few—if any—moisture-proof finishes. But moisture-resistant is another thing. Even air resists moisture in some instances. If you lay a wide board flat on the ground overnight, it will absorb dew from the ground and be cupped in the morning. Uneven moisture on opposite sides of a board causes the same cupping action. So it follows that if you coat one side of a piece of lumber with finish and leave the opposite side unfinished, the unfinished side absorbs moisture much easier.

So for whatever reason, why not continue what has worked for generations? Some of us old-timers who didn't know better coated both sides of wide areas such as tabletops. Woodworkers should continue to coat both sides of wide areas as insurance against warping. I've made numerous harvest tables, and have never had even one warp.

—C. A. Brown, Waterville, Vt.

Print this article

Continued on page 12

# TEN GOOD REASONS TO BUY NOW



1. Model 50 6" Jointer ¾ HP Single or 3 ph \$1154	2. Model 60 8" Jointer 1½ HP Single or 3 ph \$1416	3. Model 180 18" Planer 5 HP/Single ph 7½ HP/3 ph \$4199	4. Model 30B Belt & Disc Sander 1½ HP Single or 3 ph \$1049	5. Model 100 12" Planer 2 HP Single or 3 ph \$1889	6. Model 66 10" T.A. Saw 2 HP/Single ph 3 ph \$1626 \$1658	7. Model 33B Belt Sander 1½ HP Single or 3 ph \$944	8. Model 141 14" Band Saw ¾ HP Single or 3 ph \$1259	9. Model 26 Shaper 2 HP Single or 3 ph \$1455	10. Model 35 Disc Sander 1 HP Single or 3 ph \$734
---	--	--	--	--	---	---	--	---	--

**F**or home and professional hobbyists, start-up users and serious craftsmen, our expanded line of **Powerstars** has everything you need to equip your whole shop.

You'll find the Powermatic standard in every machine: rugged dependability, precision machining

and strict quality control. Excellent service and easy-to-get parts. Unique features that provide strength, accuracy and longevity.

Availability is excellent right now... at a price you can afford. Call us today for details. 1-800-248-0144.

**Better By Design™**  
**POWERMATIC®** 

A DIVISION OF STANWICH INDUSTRIES, INC.  
MCMINNVILLE, TN 37110 615/473-5551  
TELEX-554455 FAX# 615/473-7819

# TOOLCITY

WE HAVE EVERY TOOL YOU NEED



## CALL TOLL FREE

INSIDE CALIF 1-800-826-7819  
OUTSIDE CALIF 1-800-423-7899

(213) 802-1238 • (714) 525-3541  
OPEN 8 am to 5:30 pm PACIFIC STANDARD  
14136 E. FIRESTONE BLVD  
SANTA FE SPRINGS, CA 90670

ALL ORDERS SHIPPED UPS FREIGHT PREPAID (CONTINENTAL USA) ON ORDERS \$50. OR MORE. SINGLE ITEMS WEIGHING 70 LBS. OR MORE ARE SHIPPED F.O.B. SANTA FE SPRINGS, CA. CALL FOR DISCOUNT FREIGHT RATES. SALE PRICES. LIMITED TIME ONLY AND SUBJECT TO CHANGE WITHOUT NOTICE.



OUR GIANT 500 PAGE FULL LINE CATALOG IS YOURS FREE WITH ORDER OF \$50. OR MORE. OR ONLY \$5.00 EA.

## WE SHIP FREE



\$8.95

#S500A

**RYOBI**  
**\$37**

AP-10 10" Planer With Dust Chute Attachment **\$399**

DC-1 Dust Chute For AP-10 25  
EB-1 Extra Blades For AP-10 39  
DG-1 Depth Gauge For AP-10 79  
R150K 1 HP Plunge Router Kit 119  
R500 3 HP Plunge Router 169  
R501 3 HP Plunge Router 169  
RA200 8" Radial Arm Saw 249  
S500A Palm Sander 37  
TR300 Laminate Trimmer 79  
TS200 8" Compound Saw 169  
TS25U1 10" Miter Saw 199  
X2300 Miter Saw Accessory Kit 29  
TS380 14" Miter Saw 389

## HITACHI

TR12 3 HP Plunge Router With \$60 Worth of Accessories 169  
TR8 1 1/2 HP Plunge Router 129  
C10FA 10" Miter Saw 289  
C10FB 15" Miter Saw 399



#1581VSK **\$154**

## BOSCH

1272 3 X 24" Belt Sander 192  
1272D 3 X 24" Dustless 206  
1273 4 X 24" Belt Sander 206  
1273D 4 X 24" Dustless 219  
1273DVS 4 X 24" Variable Spd. w/Bag 229  
1581VS Top Handle Jig Saw 139  
1581VSK Top Handle Jig Saw Kit 154  
1582VS Barrel Grip Jig Saw 134  
1604 1 1/4" H.P. Router 139  
1609K Laminate Trimmer Kit 169  
1611 3 H.P. Plunge Router 229  
3270D 3 X 21" Belt Sander w/Bag 147  
11203K Rotary Hammer Kit 439  
9106E 1/2" Mighty Midget Drill 115

Call For Discount Prices On Bosch Router Bits

## Elu

WOODWORKING TOOLS BY BLACK & DECKER

3304 1 H.P. Electronic Plunge Router 254  
3337 3 H.P. Plunge Router 399  
3338 3 H.P. Electronic Plunge Router 439  
3375 Universal Planer 238  
3380 Jointer-Spinner 399  
4023 3 X 21" Belt Sander 219  
4024 3 X 21" Electronic Belt Sander 245  
4029 4 X 24" Belt Sander 398

## PORTER-CABLE

100 7/8 H.P. Router \$107  
309 Laminate Trimmer 99  
310 Laminate Trimmer 132  
312 Offset Trimmer 144  
314 4 1/4" Saw 139  
315 1 7/4" Circular Saw 129  
319 Tilt Base Trimmer 149  
320 Abrasive Plane 109  
330 Speed-Bloc Sander With 3M Stick-it Pad 59  
345 6" Saw Boss Circ. Saw 109  
351 3 X 21" Belt Sander 134  
352 3 X 21" Dustless 144  
360 3 X 24" Dustless 205  
361 3 X 24" Belt Sander 192  
362 4 X 24" Dustless 215  
363 4 X 24" Belt Sander 205  
503 Wormdrive Belt Sander w/Bag 359  
504 3 X 24" Wormdrive Belt Sander 349  
505 1/2 Sheet Sander w/Stick-it Pad 119  
513 Lock Mortiser 699  
518 3 H.P. 5 SPD Router 369  
520 3 H.P. Router 349  
536 1 1/2 H.P. Speedmatic Router 207  
537 1 1/2 H.P. D-HDL Speedmatic 219  
555 Plate Jointer w/Case 169  
621 3/8" V.S.R. Drill 89  
666 3/8" T-Handle V.S.R. Drill 29  
690 1 1/2 H.P. Router w/2 Collets 129  
691 1 1/2 H.P. D-Handle Router 149  
695 Router-Shaper Table 219  
696 Router Table 119  
698 Dowetail Jig 79  
5009 Mortise & Tenon Jig 39  
5061 Stair Template 159  
7511 3/8" Heavy Duty V.S.R. Drill 199  
7514 1/2" V.S.R. Drill 129  
7533 Adj. Clutch Screwgun 159  
7545 Drywall Screwgun HVY-Duty 119  
7548 VS Jig Saw w/3 Bearing Guide 139  
9118 Porta Plane w/Case, Carbide 229  
9314 4 1/2" Trim Saw Kit w/Case 159  
9548 Bayonet Jig Saw Kit 189  
9627 2 SPD Recip Saw Kit 149  
9629 VS Recip Saw Kit 159  
9652 Versa-Plane Kit 309  
59381 Hinge Butt Template Kit 159

## Makita

410 Dust Collector \$269  
1100 3/4" Planer 229  
1900BW 3/4" Planer 119  
2708W 8 1/4" Table Saw 269  
with Carbide Blade 184  
3612B 3 H.P. Plunge Router 199  
3612BR 3 H.P. Plunge Router 109  
4200N 4 3/8" Tri. Saw 159  
4301BV VS Jig Saw 119  
5005BA 5 1/2" Trim Saw 129  
5007NBA 7 1/4" Saw w/Brake 149  
5077B 7 1/4" Wormdrive Saw 89  
6801DBV Drywall Screwgun 169  
9820-2 Blade Sharpener 49  
BC-4550 Sander w/Bag 129  
JR3000V Recip Saw 229  
LS1000 10" Miter Saw 229

All MAKITA Tools on Sale Phone for Discount Prices!

9.6 Volt Cordless Tool Systems  
6012HDW Driver-Drill Kit \$119  
6012HD Driver Only 69  
6093DV VS Driver-Drill Kit 139  
6093D VS Driver-Drill Only 79  
4300D Jig Saw 69  
5081D 3 3/8" Circular Saw 79



## FINE CUT-OFF CROSS CUT BLADES

LU73M008 8"X48T ATB \$54  
LU73M009 9"X54T ATB 59  
LU73M010 10"X60T ATB 39  
LU73M012 12"X72T ATB 85  
PRECISION PLYWOOD BLADES  
LU82M008 8"X48T TCG 59  
LU82M009 9"X54T TCG 64  
LU82M010 10"X60T 44  
LU82M012 12"X72T TCG 92

## COMBINATION BLADES

LU84M008 8"X40T COMB. 53  
LU84M009 9"X40T COMB. 53  
LU84M011 10"X50T COMB. 39  
LU84M012 12"X60T COMB. 69

## RIPPING BLADES

LM72M008 8"X24T FLAT TOP 43  
LM72M010 10"X24T FLAT TOP 39  
LM72M012 12"X30T FLAT TOP 65

## SUPER FINE CUT-OFF BLADES TEFLON COATED

LU85M008 8"X64T ATB \$69  
LU85M009 9"X72T ATB 75  
LU85M010 10"X96T ATB 62  
LU85M012 12"X80T ATB 99  
LU85M014 14"X108T ATB 119  
LU85M015 15"X108T ATB 149

## SC-001 Saw Blade Stabilizer

ATB = Alternate Top Bevel  
TCG = Triple Chip Grind  
SC-001 Saw Blade Stabilizer 17

## CARBIDE DADO SETS

DC306 6" Dado \$99  
DC308 8" Dado 109  
AD800 8" Adjustable Dado 48  
JS-1000 Joining Machine 169  
O-10-20 Bisquits box of 1000 34

## FB-107 7pc Forstner Bit Set

FB-100 15pc Forstner Bit Set \$59  
90-100 15pc Router Bit Set 179  
91-100 13pc 1/2" Shank Router Set 199  
91-102 6pc 1/2" Shank Straight Bit Set 89  
91-104 6pc 1/2" Shank Profile Bit Set 129  
94-100 5pc Cabinet Bit Set 179  
95-100 5pc Cabinet Set 229  
W/Perfecta Bit  
Both Above Come With Free Door Making Book!  
DB-050 50pc Drill Bit Set \$9  
EC-900 5pc Shaper Cabinet Set 329



Call For Discount Prices On Senco Guns And Fasteners!

## POWERMATIC III

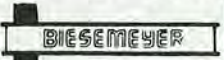

66 2HP Table Saw W/50" Biesmeyer \$1549  
66 3HP Table Saw W/50" Biesmeyer 1785  
60 8" Jointer W/1 1/2 HP 1349  
26 Shaper 2 HP 1399  
Biesmeyer 40" Homeshop Fence System 209  
Biesmeyer 52" Commercial Fence System 299  
Paralock Table Saw Fence 50" 339  
Call For Price On Custom Fences And Mobile Bases

# TALKING BACK

Continued from page 10

## WHAT'S UP ON RABBETS

Most of the projects in your magazine seem to be well thought out and researched, so I was somewhat shocked in going over the February 1988 issue to see that both the article on making router moldings and the article on making a picture frame do not allow enough room for the picture package.

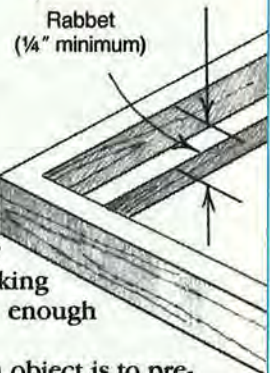

The true reason for framing an object is to preserve the artwork—it does not have to be museum-quality to need correct framing. The 1/4 x 1/4" rabbet, and even the 1/4 x 3/8" rabbet do not give enough room for the fastening in of a proper picture package. I would say that 1/4 x 1/2" would be the minimum.

I have taught college-level classes on conservation of works of art on paper and frequently consult to museum staffs in this area.

—Richard W. Osborn, Oskosh, Wis.

Good point, Richard. We asked some other experts, and yes, a rabbet should be at least 1/2" deep to allow for all the necessary parts, including a spacer between the artwork and glass in some cases.

We've learned a lot about picture-framing techniques in the last eight months. For example, in our sample artwork project on page 47, the glass, mat, mounting board, and backing board make a 1/2"-thick package; we selected a molding with a 1" deep rabbet. The point: Know the thickness of your picture package before selecting or making a molding, and make the rabbet at least 1/4" deeper.

## SANDING DRUMS: NOT MADE FOR ROUTERS

Recently, I overheard a frightening conversation at a store. A customer complained that no one had warned him not to use a sanding drum in his router. The rubber drum partially disintegrated from the centrifugal force and he nearly ruined the router before he could get it shut off. Luckily, he was not injured.

Although few small sanding drums come with instructions, the 1/4" or 1/2" shanks should be used only with lathes, drill presses, or portable drills. Never put a sanding drum in a high-speed router. In addition, the speed of the router is inappropriate for sanding—it would burn the work. Never use anything in the router except bits made specifically for it.

The many collet chucks now being sold for shapers make it possible that someone will try a sanding drum there, also. Even the 9,000 or so rpm of a shaper turns a sanding drum into a dangerous weapon. You can't be safely sand with a shaper without changing the pulleys to lower the speed.

—John Martin, Cumberland, Maine

Continued on page 14

**In 20 years,  
you won't remember  
how much  
you paid for it.**



## **But for now, it's worth mentioning.**

These Delta Jointers are built for the long haul. And years from now, all that'll really matter is the fact that they're still going strong. Because Delta built them that way.

But for now, you can smile and tell yourself you paid hundreds less than you should have.

Because right now our 8" Precision Jointer\* is sale priced at \$1299. That's \$306 off the list price. Along with a single phase 1½ HP motor, it features an extra long, center-mounted tilting fence and parallelogram-design support system for uniform chip breaking and smoother finishes. Not only that, there's a 76½" table

so you can handle that extra long stock. And remember, it's as durable as it is accurate.

But maybe your needs are scaled down to where our 6" Precision Jointer\*\* makes more sense. Right now it's only \$999. That's a nice savings of \$118. It features a single

phase ¾ HP motor with push button switch and 55½" table. And it possesses all the unique design features of the bigger

8" Jointer to give straight edges, bevels and broad, flat surfaces.

So pick one of our Precision Jointers.

And buy it right now. And while

you're at it, jot down the price.

So years from now, when somebody asks, you can tell them you saved big.

Call toll-free for the name of your Delta distributor. Delta International Machinery Corp., 800/438-2486 (in PA 800/438-2487).

\* Model 37-350 with stand, 1½ HP, 115/230V, 1 PH motor and push-button switch.

\*\* Model 37-154 or 37-150 with stand, ¾ HP, 115/230V, 1 PH motor and push-button switch.

Offer good only from participating dealers in the continental U.S., Alaska, and Hawaii from July 1 to December 31, 1988.

**8" JOINTER  
\$1299**

**6" JOINTER  
\$999**

**Building  
On Tradition**  
**DELTA**  
A Pentair Company

## CONTROL THE SPEED OF YOUR ROUTER

ROUTE AT THE SPEED THAT GIVES THE BEST RESULTS WITH THE WOOD AND BIT YOU ARE USING!

- LESS TEAR OUT
- STOPS BURNING
- FEED AT COMFORTABLE RATE
- BETTER, SAFER RESULTS WITH LARGE DIAMETER PANEL-RAISING BITS
- LESS WEAR ON BITS
- LESS NOISE AND SOFTER STARTS AT LOWER SPEEDS

INTRODUCTORY PRICE  
**\$39.95** POSTAGE PAID  
VALUE OVER \$100.00

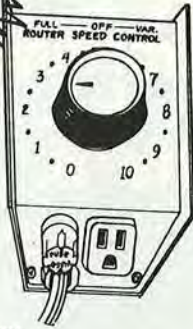

### FEATURES:

- SPEED ADJUSTABLE FROM FULL SPEED TO 0 RPM
- FULL HORSEPOWER AND TORQUE AT ALL SPEEDS
- GO BACK AND FORTH FROM ANY PRE-SET SPEED TO FULL SPEED AT THE FLIP OF A SWITCH
- WORKS WITH ALL ROUTERS 3 HP OR LESS
- 120V 15 AMP
- GIVES YOUR ROUTER A FEATURE ONLY AVAILABLE ON ROUTERS THAT COST OVER \$500.00

**EASY TO USE** — SIMPLY PLUG IN SPEED CONTROL AND PLUG YOUR ROUTER INTO THE SPEED CONTROL — TURN DIAL FOR BEST RESULTS. (SPEED CONTROL HAS A CLIP THAT CAN BE WORN ON YOUR BELT OR HUNG ON WALL OR LEFT LOOSE.)

- REDUCES SPEED ELECTRONICALLY WITHOUT REDUCING TORQUE; ELECTRONIC FEED-BACK MAINTAINS SPEED BY INCREASING VOLTAGE TO MOTOR AS LOAD INCREASES.

To order by Master Charge or Visa Toll Free  
7 Day — 24 Hour Order Service, Call

1-800-533-9298

or send check to: MLCS, Ltd., P.O. Box 4053D, Rydal, PA 19046

## MULTI-FORM MOLDING MAKER #159

MAKES BEAUTIFUL LARGE AND SMALL MOLDINGS

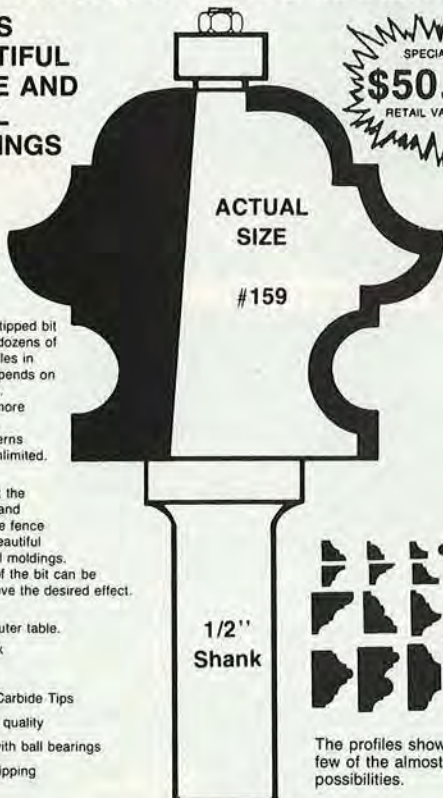

SPECIAL OFFER  
**\$50.00** POSTAGE PAID  
RETAIL VALUE \$108.00

This carbide tipped bit will produce dozens of different profiles in one pass (depends on size of stock). With two or more passes, the possible patterns are almost unlimited.

Simply adjust the depth of cut and position of the fence and create beautiful large or small moldings. Any portion of the bit can be used to achieve the desired effect.

For use in router table.

- 1/2" Shank
- Two flute
- Tungsten Carbide Tips
- Production quality
- Supplied with ball bearings
- We pay shipping

1/2" Shank



The profiles shown are just a few of the almost unlimited possibilities.

To order by Mastercard or Visa Toll Free  
7 Day—24 Hour Order Service, Call  
1-800-533-9298

or send check to: MLCS, Ltd., P.O. Box 4053D, Rydal, PA 19046

## TALKING BACK

Continued from page 12

### ROUTER TABLE IMPROVEMENTS

Recently I came across an old issue of *WOOD* magazine. I found the cover of the April 1985 issue, which is devoted to a routing table, highly interesting. I departed from some of the instructions and the results pleased me. Your readers may be interested.

First, rather than use clamps to hold the fence in place, I designed and constructed a sliding fence. This change makes precise fence adjustment a snap. The fence attaches to the table with two 1/4 x 20 carriage bolts and Delta table saw fence knobs (part 1087534). I also substituted a Sears elbow (model 315.16960, part 2-725384-00, division 9, source 113) to eliminate a curve in the vacuum hose.

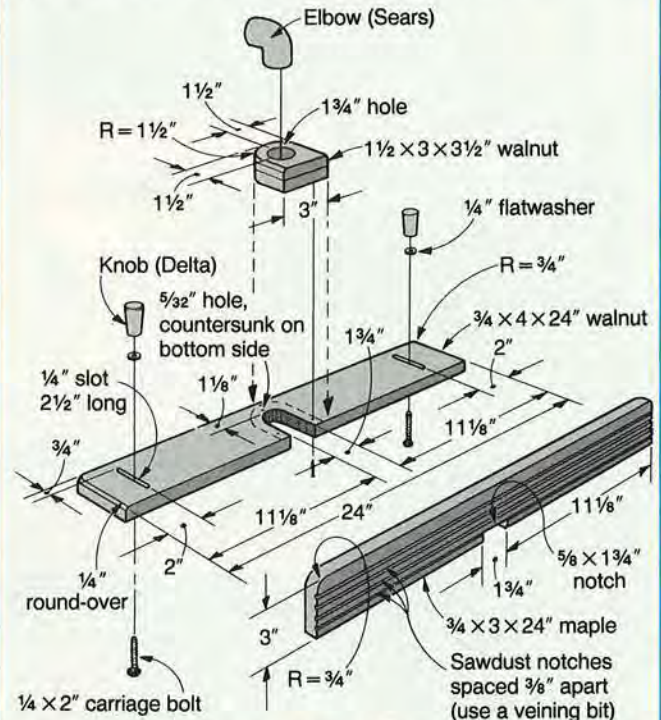

For the tabletop, I chose 1/2" acrylic plastic to increase visibility. Because I didn't want to lose 1/2" of cutting depth, I attached my router to a 3/32" aluminum plate recessed and rabbeted into the table top. Now I can easily pop out the router to change bits.

—Douglas J. Keough, Stroudsburg, Pa.

*Because of fine suggestions such as yours, Doug, our great router table gets even better.*

### STIR UP SOME HOMEMADE PAINT TONIGHT

This is one recipe for milk paint that William H. Mason referred to in his June 1988 "Ask *WOOD*" question. I found the recipe on a 1923 painter's worksheet: Vigorously beat together 1 cup powdered (dry) milk, 1 cup of water, and 2 eggs. Add colored chalk or red iron oxide to desired consistency. Let mixture stand over night. 🌱

—J. Hostetler, Elyria, Ohio



# FREUD'S BISCUIT JOINER: It Works as Easy as 1·2·3



**B**ISCUIT JOINERY is now easy and economical with the Freud Biscuit Joiner machine. Joints, such as butt, edge, "T" and others, can be made quicker and stronger with the use of the Freud joiner.

The Freud joinery machine is a plunge cutting tool. It has a rotating carbide cutter that creates an elliptical slot in the surfaces to be joined. The splines, or "biscuits" as they are called, are inserted into the slot along with any water based glue. Because the biscuits are made of wood, the water makes them swell in the joint making an extremely strong and firm bond.

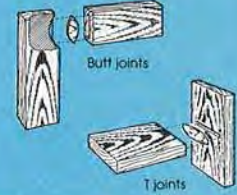
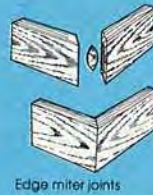
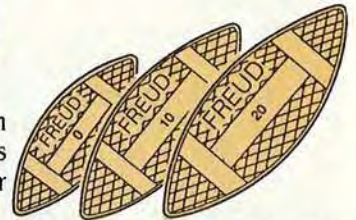

## 1 Lay Out

The boards that are to be joined should be placed together and the location of each joint marked on both pieces. The vertical fence is adjusted to the depth desired for the slots. Turning the wing nuts on the side

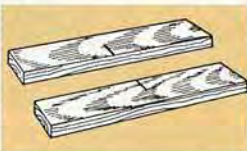

of the fence allows it to move easily in the tracks. The fence is accurately calibrated to allow you to easily move it to center of the joint (See Figure 1).

At this point, you have determined the horizontal location of the joint by marking the wood and vertical location of the joint by setting the fence.

## 2 Cut

You are now ready to make the slots for your biscuit joint.

There is a red indicator line on the front of the fence and a corresponding red mark on the base plate (See Figure 1). You can use either of these marks for alignment with the lines drawn on the mating pieces of wood.

With the wood securely held in place, align the red mark with the line on the board. With one hand you can grasp the body of the machine. The other hand is placed on the handle. Turn the machine on and, with a steady forward motion, push the joiner body forward to make the biscuit slot. Repeat the process for each marked area on all of the wood pieces.

*Simple and Easy!!!* The wood particles are automatically ejected through the machine's exhaust port.

## 3 Assemble

Apply a water based glue to the slots and surfaces being joined. Insert the biscuits in the slots and push the boards together. For best results you will need to clamp the joint together for the glue manufacturer's recommended drying time.

There you have it, 1-2-3!! An extremely strong joint produced quickly and easily by you and the Freud Joiner Machine.

You will find a complete instruction "How to" book with each machine. Illustrated with photographs and drawings, it is designed for those woodworkers not familiar with biscuit joinery. The Freud biscuit joiner will prove to be a highly valued tool for your woodworking projects.

At a List price of \$285.55, the Freud JS100 Joiner Machine is now on sale through your local Freud distributor for \$195.00.

### MITER JOINTS? NO PROBLEM!

By reversing the fence, you can join mitered pieces (See Figure 2). The steps are the same.

Mark the location of your joint and set the fence to the vertical height needed. Line up the fence with the mark and make your cut. Apply glue — insert biscuits — clamp!



### Booklet



# freud®

218 Feld Ave., High Point, NC 27264  
919-434-3171

1570 Corporate Drive, Suite G  
Costa Mesa, CA 92626  
714-751-8866

**STAY CHARGED UP**

The cordless drill is a super convenience—unless you regularly use one all day long. Prolonged operation runs down the battery, meaning you have to stop drilling while it recharges.

**TIP:** When you buy a cordless drill, invest a few more dollars in an extra battery pack. This allows you to continue drilling while the other battery pack recharges. Now you can drill for hours on end and never have to stop in the middle of a job for lack of a charge.

—Dan Miller, Elgin, Ill.

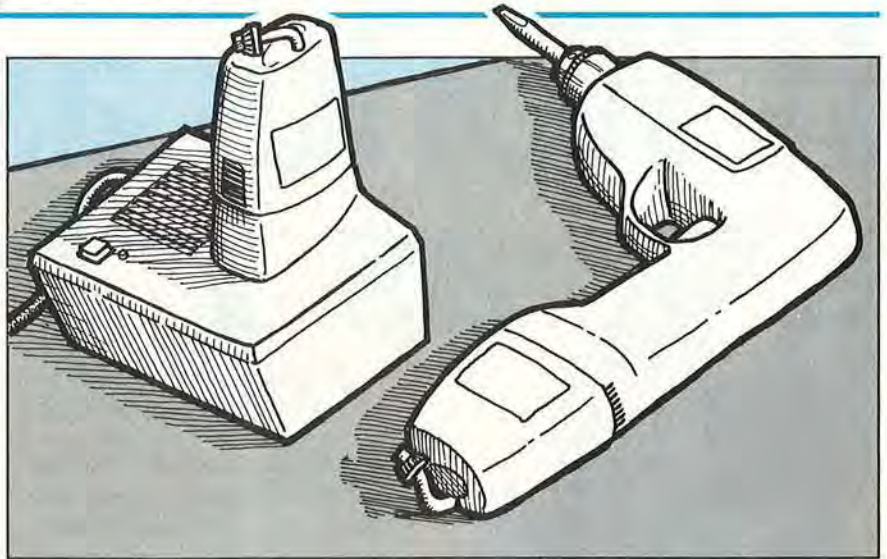

**TAILOR A BIT TO FIT YOUR TAPERED CANDLES**

When boring holes for conventional taper candles 8 to 12" long, a standard spade bit will not produce a snug fit. The holes will be either too large at the bottom, which permits the candle to flop back and forth, or too small for the base to be inserted properly.

**TIP:** Modify a spade bit of the appropriate size— $1\frac{5}{16}$ " matches standard tapered candles. Scribe lines on the bit so it tapers from a  $1\frac{5}{16}$ " diameter to  $\frac{3}{4}$ " as shown below. With a bench grinder, fully remove unwanted material. Finish the cutting edge with a sharpening stone.

—John Wolf, St. Joseph, Mo.

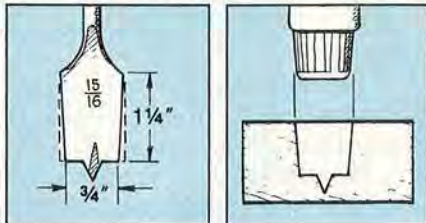

Do you have any good tips you'd like to share with our readers? We'll pay you \$25 for each submission we publish. No shop tips can be returned. Mail your tips to:

**Shop Tips**  
 Better Homes and Gardens®  
 WOOD® Magazine  
 Locust at 17th  
 Des Moines, IA 50336

**TWO TIPS FOR PLUNGING TO PRECISE DEPTHS**

Plunge routers excel in certain operations, such as making signs, cutting dados and rabbets, making hanger holes in the back of plaques, and molding edges. Many of these jobs require precise cutting depths.

**TIP #1:** To fine-adjust plunge routers with thread-rod depth adjustments for exact depth of cut, plunge the bit slightly deeper (about  $\frac{1}{16}$ " ) than desired and lock into place. Bring down the upper nut on the rod until it comes into contact with the router housing. Now, release the lock and slowly loosen the nut, allowing the router's spring action to lift the bit to the precise depth. Tighten the nut to prevent any vertical movement.

—From the WOOD magazine shop

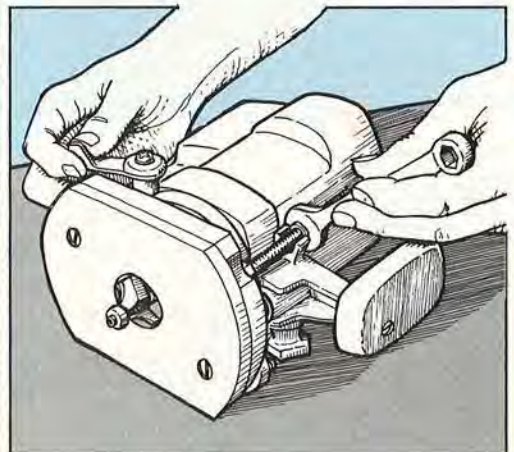

**TIP #2:** Using the depth gauges on plunge routers often creates an irritating variance in rabbet and dado cuts. Try this remedy: Cut a set of precision shims or gauges made of hardwood, metal, or plastic in common thicknesses such as  $\frac{1}{8}$ ",  $\frac{1}{4}$ ",  $\frac{3}{8}$ ", and so on. A convenient size is  $\frac{3}{4}$ " x 3". Drill a  $\frac{1}{4}$ " hole in one end for hanging and label each block according to its thickness. Use these to preset your router depth consistently as shown at right.

—Eugene Fischer, Houston

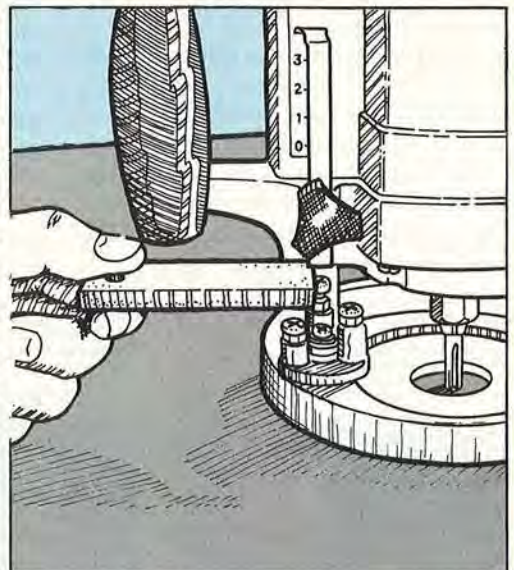

Continued on page 18

# EARN \$18 AN HOUR!

## Turn Your Spare Time into EXTRA INCOME!!!

### Operate your own Profitable Saw & Tool Sharpening Business!



**Sharp-All  
lets you  
easily  
Sharpen  
Saws, Shop  
and Garden-  
ing Tools for  
Home and  
Industry!**



*Now, use your spare time to generate low risk, high profit income to improve your lifestyle!*

With the Foley-Belsaw Model 1055 Sharp-All it's easy for you to start your own profitable Saw & Tool Sharpening Business. Yours is a service business...there's no selling involved, no inventory required. You spread the word about your business and people just start bringing in their saws and tools for you to sharpen...it's that easy...and you pocket year 'round profits for the things you want to do.

**Manage your own time and reap the rewards of financial success and job satisfaction!**

You're your own boss, so you set the hours. Work in your spare time or build into a full time operation right at home in your garage, basement or tool shed. Work as much as you want, as long as you like.

**Plenty of business just waiting for you to start your own Sharpening Business!**

With all the new residential and commercial building in America today, more than enough business awaits you when you open your shop. Every home and business has saws and tools of all kinds that need sharpening periodically and with your Sharp-All you can service the needs of your community...no matter whether you live in a big city, small town or rural farm area...you'll be the sharpening headquarters for carpenters, builders, manufacturers, craftsmen, hobbyists and homeowners.

**It's easy to get started, no experience necessary...and you deal direct with the factory for low prices!**

You don't have to invest thousands of dollars to get started in business for yourself. In fact for less than \$2.00 per day, with the low cost Sharp-All and your desire to get ahead, our *Operators Manual and Guide to Profits* will provide all the necessary information and step-by-step illustrated instructions you'll need to get started. With Foley-Belsaw you deal direct with a dependable company with a history of providing independent businessmen and women with quality products and superior service since 1926.

**To get started ... just fill in the coupon TODAY and MAIL IT!  
30-DAY FREE HOME TRIAL OFFER!**

We'll rush to you our **FREE "Lifetime Security" Fact Kit** by return mail...First Class! You'll receive full details on how to start your own profitable Saw & Tool Sharpening Business with no risk on our **30-Day FREE Home Trial Offer!** There's No Obligation to buy...and No Salesman will call.

#### READ WHAT THESE SUCCESSFUL SHARP-ALL OPERATORS SAY...

*"Sometimes I make more in a week in sharpening than I do on my regular job. I still have a lot of years before I retire, but I can handle both full and part-time jobs without any trouble."*

Don Lollar, Louisiana

*"...the thing that impressed me most is that just about everything that Foley-Belsaw claimed turned out to be true. You normally read the ads you know, and tend to look between the lines for what it's really like, but with Foley-Belsaw it was a straight deal and whatever they said was true."*

Al Krasnow, Connecticut

*"I never sharpened a saw before in my life...only advertised in newspapers for 2 weeks and now I have more work than I am able to do. I have as many as one hundred saws ahead of me at a time."*

Frank Sartin, Washington

*"I have had excellent results with the Sharp-All...you just can't beat it...it is easy to set-up, doesn't take long to change stones...all in all, it's no trouble to work with."*

LaVern Heim, Kansas

**ACT NOW! SEND FOR  
FREE FACTS TODAY!**



Foley-Belsaw Company Since 1926  
6301 Equitable Road, Dept. 20700  
Kansas City, MO 64120

Yes, please rush my FREE "Lifetime Security" Fact kit on starting my own profitable Saw & Tool Sharpening Business!

NAME \_\_\_\_\_

ADDRESS \_\_\_\_\_

CITY \_\_\_\_\_

STATE \_\_\_\_\_

ZIP \_\_\_\_\_

PHONE ( ) \_\_\_\_\_



The originals are in America's museums.  
The reproductions are in our catalog.



Sheraton  
Field Bed  
circa 1790



Rush me your  
40 page color catalog of affordable museum reproduction furniture,  
furniture kits, lighting, brass, pewter, accessories, paint and stain.  
I have enclosed \$3 for a subscription.

Name \_\_\_\_\_  
Address \_\_\_\_\_  
City \_\_\_\_\_ State \_\_\_\_\_ Zip \_\_\_\_\_

*Chasset Colonials*  
by HAGERTY

1081A Ship St., Cohasset Harbor, MA 02025  
Tel. (617) 383-0110 MasterCard & Visa

## TIPS FROM YOUR SHOP (AND OURS)

Continued from page 16

### PLAY IT SAFE WITH SHORT, THIN SLICES OF WOOD

Every once in a while, a project calls for narrow wooden strips which you would normally rip from larger pieces of stock. But if you're caught with only small pieces of stock that you need to cut into even smaller dimensions, it may be difficult and hazardous to run them through a table saw.

**TIP:** Use glue to edge-join narrow or short sections of stock to longer and wider sizes of scrap wood (see drawing below) to give you larger work pieces and increase your margin of safety.

—Robert N. Stuckey, Houston

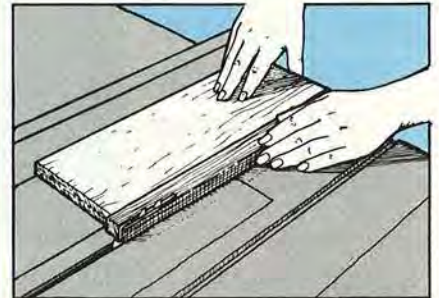

## Dealer's choice.

The Excalibur T-Slot Fence System turns table saws into precision wood-working machines.



**EXCALIBUR**  
MACHINE & TOOL CO.

EXCALIBUR MACHINE & TOOL COMPANY

U.S.A.

210 Eighth St. South,  
Lewiston, NY 14092

TOLL FREE: 1-800-387-9789

CANADA

3241 Kennedy Rd., #7  
Scarborough, Ont. M1V 2J9

(416) 291-8190

PLEASE PHONE FOR THE NAME OF YOUR NEAREST DEALER  
DEALER INQUIRIES ARE WELCOME

**THE EXCALIBUR T-SLOT FENCE SYSTEM  
IS AT SELECTED DEALERS NOW!**

### A GRIPPING IDEA FOR NAIL REMOVAL

You can almost count on the wood splitting when you attempt to pull a finish nail from wood trim or molding you wish to recycle.

**TIP:** Pull these nails through the back side by bending the shank over slightly so your claw hammer can grab it more easily.

Even better, grip the shank of the nail with the jaws of a diagonal wire cutters, slip the hammer claw between the wood and the cutters, and pry out the nail. If any holes remain in the finished face of the molding, fill them with putty.

—Myron S. Levy, Gold Hill, Ore.

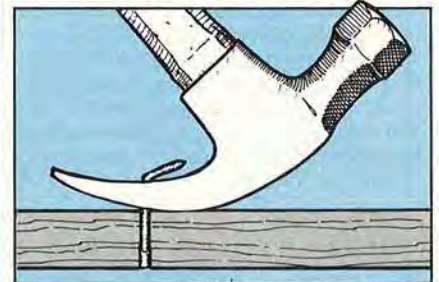

## KEEP THREADS OPEN WHEN CUTTING BOLTS

Occasionally, it's necessary to cut off a bolt that's too long for a specific job. Hacksawing the bolt usually closes the threads, making it very hard—if not impossible—to start the nut.

**TIP:** Thread on a wingnut prior to sawing the bolt, then grind the sawed end on a grinding wheel or belt sander, rotating the bolt 360°. Now the wingnut, which aids in holding the bolt during grinding, will help open the threads completely when spun off. If the wingnut doesn't spin off with little effort, grind the bolt until you can easily remove it.

—From the *WOOD* magazine shop

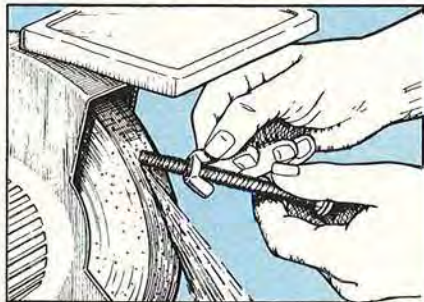

## ON TRACK FOR HANGING FILES

Hanging files keep drawers marvelously organized, but they require a metal frame insert to support them. The insert looks out of place in wooden files you've built yourself.

**TIP:** Mount lengths of  $\frac{1}{2} \times \frac{1}{2}$ " aluminum angle on the top edge of each drawer side, as shown, below. Now, the drawer will support hanging files so you won't need the standard, unattractive racks.

—Craig K. Carlson-Stevemer, Arden Hills, Minn.

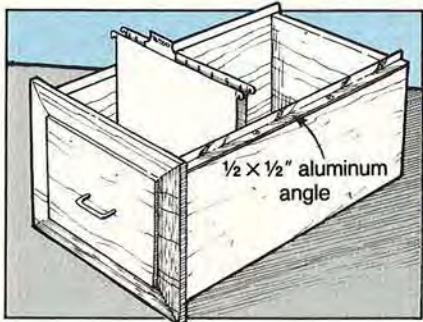

Continued on page 20

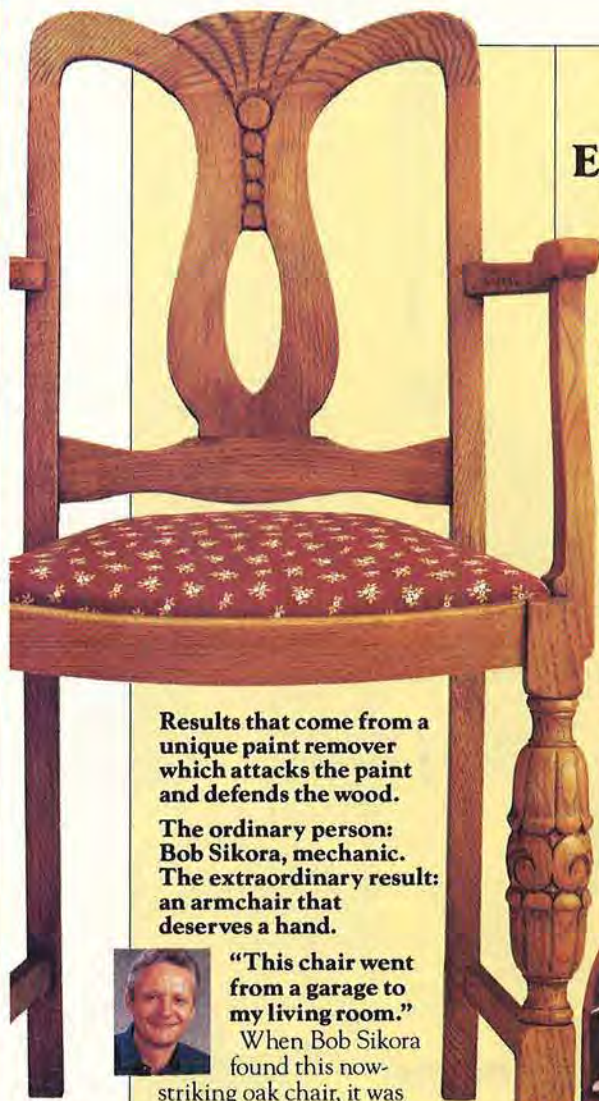

Results that come from a unique paint remover which attacks the paint and defends the wood.

The ordinary person: Bob Sikora, mechanic. The extraordinary result: an armchair that deserves a hand.



"This chair went from a garage to my living room."

When Bob Sikora found this now-striking oak chair, it was submerged under decades of old paint. But Bob spotted the potential. So he grabbed a can of Formby's®

## ORDINARY PEOPLE. EXTRAORDINARY RESULTS.

Paint Remover and went to work. "Formby's Paint Remover easily removed layers of old paint, without hurting the wood," reports Bob. Indeed, at the Formby's Workshop we're particularly proud of our Paint Remover that's tough on paint—but gentle to your wood.

Let Bob's triumph inspire you. Thanks to the remarkable products that come from The Formby's Workshop—and our toll-free number for expert advice—you can get extraordinary results.

Nothing works like things from The Workshop.



© 1988 Thompson & Formby Inc.  
The Formby's Workshop, Olive Branch, Mississippi 38654

**BYROM**  
INTERNATIONAL WILL BE  
OPENING NEW DOORS THIS FALL

ANOTHER  
BYROM ORIGINAL

DON'T MISS OUR FULL COLOR AD IN  
THE NOV./DEC. ISSUE FOR ALL THE  
DETAILS ON OUR NEW  
SAFETY RAISER™ PANEL BITS!

**BYROM™**

INTERNATIONAL CORPORATION

"The World's Router Bit Source"

Box 246, CHARDON, OHIO 44024  
PHONE 800-722-5447, 216-285-2341

"NEW" COMPLETE SET OF WOODCARVING TOOLS  
HONED READY TO USE.

# COMBI T-4 \$57.75 PPD  
Durable Compact Tool-Box  
Included In Offer.  
(Not Shown)

Bear NOT Included.



CATALOG \$1.00

NY Residents include sales tax.

Send Check or Money Order to:

WARREN TOOL CO. INC.  
Rt. 1 Box 14-A Dept. W  
Rhinebeck, NY 12572  
(917) 876-7817

"WARREN TOOLS GIVE YOU THE EDGE"

## SQUARE DRIVE SCREWS



- "Cam-Out" is a Thing of the Past
- Heat Treated for Strength
- Deep Thread for Holding Power

Special: 100 each of the following sizes, plus a power driver bit and hand driver. Optional set of 6 heavy duty bins (not shown) stack or wall mount.

Size	Length	SW/O Bins	\$ W/ Bins
#6x 1/2, 5/8, 3/4, 1, 1-1/4, 1-1/2		13.35	17.35
#8x 3/4, 1, 1-1/4, 1-1/2, 2, 2-1/2		16.65	20.95
#10x 1-1/4, 1-3/4, 2, 2-1/4, 2-1/2, 3		23.65	27.90

	Order Total	S & H
Shipping & Handling (Cont. U.S. Only)	\$ .01 to \$20.00	\$3.00
Va. Res. add 4.5% Tax	\$20.01 to \$50.00	\$4.50
	\$50.01 to \$80.00	\$6.00
	Over \$80.00	\$7.50



McFEELY Hardwoods and Lumber

P.O. Box 3 • 712 12th Street  
Lynchburg • Virginia • 24505

1-800-443-7937 • In Va. 1-800-542-2023

## TIPS FROM YOUR SHOP (AND OURS)

Continued from page 19

### WHEN YOU DON'T KNOW WHICH WAY TO TURN

If you're like us, you may have a devil of a time remembering whether to turn the wrench clockwise or counterclockwise to loosen or tighten the collet that holds router bits.

**TIP:** Label the tightening direction on the router body with a permanent marker so you'll make the right move every time.

—From the WOOD magazine shop

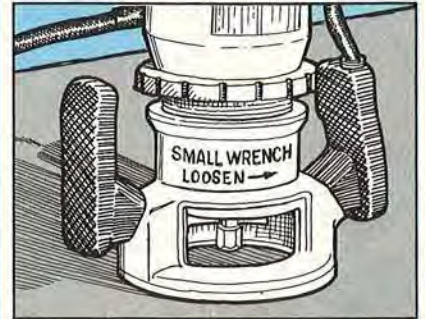

### ONE WAY TO BEAT THE (SANDING) DRUM

Being in the middle of a project and finding out you don't have the right size or grit of sanding sleeves for a drum can be a frustrating experience.

**TIP:** Use double-faced carpet tape to attach the appropriate grade of conventional sandpaper to your sanding drum. First, cover the drum with tape, leaving the protective film on the outside. Cut a strip of sandpaper wide enough to cover the drum, tapering one end at an angle. Fit in place, penciling a line where the ends meet. Cut so the sandpaper ends butt together. Remove the tape's protective strip and affix the sandpaper.

—Thomas P. Rockey, Northfield, Minn.

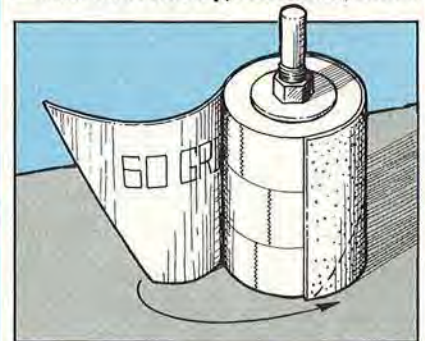

introducing . . .

rbindustries family of  
fine quality tools . . .



The rbi  
**Hawk™**

Precision Scroll Saw

America's best selling scroll saw can give you the capabilities you need at a price you can afford. With five models to choose from, the Hawk is the scroll saw for you! Unlock your creativity and enjoy precision woodworking you never dreamed possible. Send for a free fact kit today!



## rbi Joint Machine™

Create beautiful wood joints so precise they don't even require gluing. Make beautiful finger joints, dovetails, mortise and tenons, and more! By using the optional inverted pin router attachment you can make wooden signs and any precision router work all with one simple machine. Send today for more information!



## rbi WOODPLANER®

Planer • Sander • Molder • Gang Saw

Four heavy duty precision operations in one rugged, dependable workhorse of a tool. Plane tough stock into finished lumber, put a satin smooth finish on your projects with the sanding head attachment, create beautiful custom moldings with the molding head assembly, or gang saw lumber to exact dimensions with the power fed gang saw. Send today for your free fact kit on all RBI products.

For Faster Service Call Toll Free

1-800-535-8665

MAIL TO:

**rbindustries**

1801 Vine Street, P.O. Box 369  
Harrisonville, MO 64701

Yes, Please Rush Me A FREE Information Kit  
(Check One)  Rbi WOODPLANER  Rbi JOINT MACHINE  
 Rbi HAWK PRECISION SCROLL SAW

Name \_\_\_\_\_  
Address \_\_\_\_\_  
City \_\_\_\_\_  
State \_\_\_\_\_  
Zip \_\_\_\_\_ W22



# Compare this offer with any other book club for Price • Quality • Benefits • Selection!

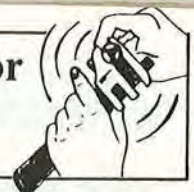

An absolutely no-risk guarantee.



2871 \$17.95



1122 \$21.95



2858P \$14.95



2783P \$12.95

## Select 5 Books for only \$3.95

(values to \$122.70)  
and get a Free Gift!



1971P \$12.95



3014 \$21.95



2863 \$24.95  
Counts as 2



1810 \$18.95

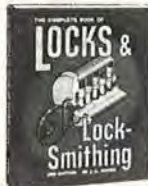

1530P \$15.95



2797P \$14.95



2789 \$23.95



2667 \$19.95



2811 \$27.95  
Counts as 2



2884 \$23.95



3056 \$25.95  
Counts as 2



1381P \$14.95



2788P \$9.95



1769P \$12.95



1744P \$14.95



1465P \$10.95



1654 \$19.95



1573P \$16.95



1801P \$8.95



2806P \$15.95



2629 \$24.95  
Counts as 2



2912 \$23.95



## HOW-TO BOOK CLUB®

**FREE**  
when you join!

### 15 Practical Woodworking Projects From Percy Blandford

Exciting projects from master craftsman Percy Blandford include toys, furniture, a go-cart, and more!

(a 6.95 value)



1954P \$16.95



2602P \$17.95



1967 \$21.95



2774P \$14.95



2739 \$19.95



1871 \$16.95



2878 \$21.95



1838P \$10.95



2816 \$21.95



1148P \$9.95

**Membership Benefits • Big Savings.** In addition to this introductory offer, you keep saving substantially with members' prices of up to 50% off the publishers' prices. • **Bonus Books.** Starting immediately, you will be eligible for our Bonus Book Plan, with savings of up to 80% off publishers' prices. • **Club News Bulletins.** 14 times per year you will receive the Book Club News, describing all the current selections—mains, alternates, extras—plus bonus offers and special sales, with hundreds of titles to choose from. • **Automatic Order.** If you want the Main Selection, do nothing and it will be sent to you automatically. If you prefer another selection, or no book at all, simply indicate your choice on the reply form provided. As a member, you agree to purchase at least 3 books within the next 2 years and may resign at any time thereafter. • **Ironclad No-Risk Guarantee.** If not satisfied with your books, return them within 10 days without obligation! • **Exceptional Quality.** All books are quality publishers' editions especially selected by our Editorial Board. BHGW-988

(Publishers' Prices Shown)

If card is missing use this address to join. HOW-TO BOOK CLUB®,  
Blue Ridge Summit, PA 17294-0800.

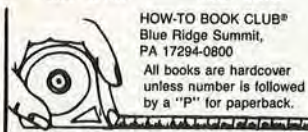

HOW-TO BOOK CLUB®  
Blue Ridge Summit,  
PA 17294-0800  
All books are hardcover  
unless number is followed  
by a "P" for paperback.

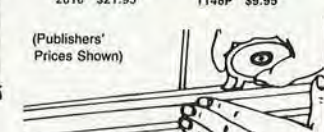

# THE OLD KITCHEN TABLE

“What a great ax! It’s had two heads, seven handles ...and it’s still going strong!” — Ancient joke

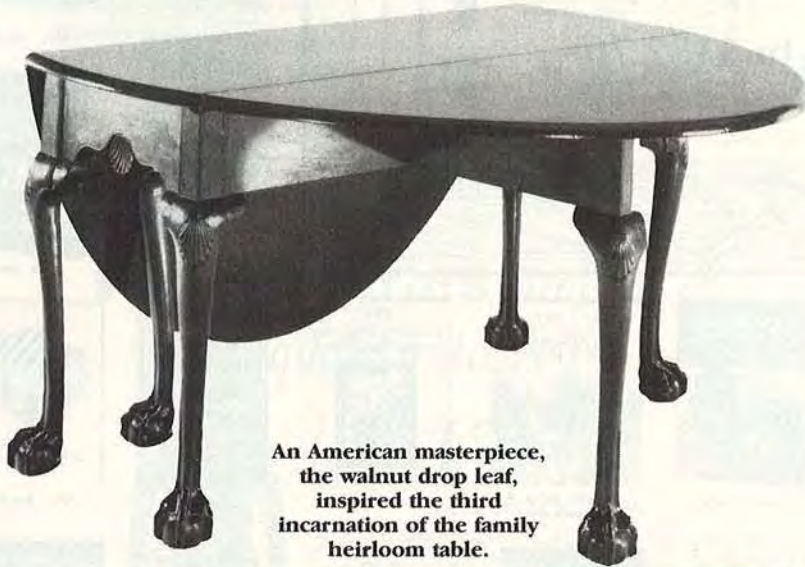

An American masterpiece, the walnut drop leaf, inspired the third incarnation of the family heirloom table.

I grew up convinced that the Pilgrims had their first Thanksgiving dinner on the same walnut tabletop where I ate my cornflakes. “Sure, it’s had some repairs,” said my mother, “but this old table has been in our family since 1627.” It wasn’t until adulthood, when the table had passed down to me, that I first suspected the integrity of our cherished family tradition. Unless history recorded a hingemaker named *Stanley* on the Mayflower, something was incredibly wrong with our heirloom drop-leaf table.

**The pine tree and the trestle**  
Through careful research (and a heavy dose of imagination), I have solved the mystery of our family heirloom. Our walnut drop-leaf table did actually begin in 1627—but as a pine trestle table!

In the beginning, it measured 2’ wide and 12’ long, just large

# Peak Performer. 49,500 board feet and still cutting.

## DML’s New Golden Eagle™ Blade, Featuring Dyanite™ Teeth.



enough for family and friends. The two massive top planks were split from a single pine log, smoothed

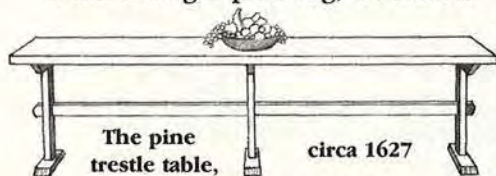

with an adz and plane, then joined along their underside with wooden dovetails, like the one shown.

After joining and gluing the tabletop boards, carved, butterfly-

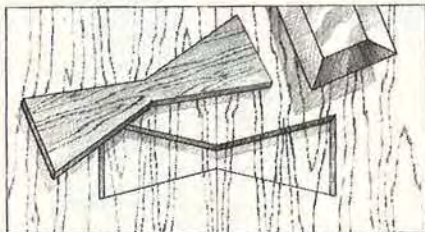

"Butterfly" dovetails

shaped pieces of wood were set across the seam and their outlines carefully traced with a knife. Then the recesses were chiseled out and the dovetails glued into place.

### The drunkard, the drop leaf, and the restoration

Our family table underwent its first major renovation, at the hands of its third owner, just after the American Revolution. An old soldier, beset with the fever, had taken the "two-hat cure"—he put his hat on the table and drank apple brandy until he saw two hats!

Unfortunately, during the curative stupor, his candle burned through the tabletop. But, the old soldier had the right replacement: three walnut boards won in a horse race. Shortening the stretchers, he made it into a large card table.

As often happens, however, the wood used by the old soldier was

better than the craftsmanship. This, coupled with the odd match of the walnut top and the pine trestle base, motivated the table's seventh owner to have it restored as genuine "Colonial" table.

This happened when the centennial of 1876 was fast approaching. The local cabinetmaker chopped up the pine base for kindling, replacing it with a proper one of carved walnut with swing-out, knuckle-jointed side legs.

Cutting the knuckle joints was easier than it looked. With chisels and planes, the cabinetmaker shaped the ends of the two boards into partial cylinders. He then cut away the alternating sections from each cylinder to allow them to intermesh. Iron rods through their centers completed the wooden hinges. The length of the knuckle joints gave stability to the swing-out legs that supported the drop

*Continued*

**Test Location:** H.J. Scheirich Company, Louisville, Kentucky.

**Material:** Particle Board. Single and double face laminated.

**Competition:** C-4 Grade Carbide.

**Results:** With no sharpening, the original Golden Eagle Dyanite saw blade exceeded the standard C-4 grade carbide-tipped blade by 100% and is still cutting.

Why? It's more heat resistant, more corrosion resistant and more productive overall.

Don't believe us? Call or write and we'll send you a copy of the test results to date. 800-233-7297 (SAWS)

DML, Inc. 1350 S. 15th St. Louisville, KY

**DML**  
America's quality toolmaker



# WIN A FREE HEGNER SCROLL SAW



HEGNER  
Multimax 2

Here's your chance to get the scroll saw you've always wanted, absolutely FREE! It's easy - just call toll-free or return the coupon below to register - no purchase necessary to win. You'll also receive free information on HEGNER - the world's finest Precision Saws!

Name \_\_\_\_\_  
Street \_\_\_\_\_  
City, State, Zip \_\_\_\_\_  
Phone ( ) \_\_\_\_\_

**1-800-648-4264**

Details on free drawing included with saw information.  
One entry per name, address, or household. Offer void where prohibited.



ADVANCED  
MACHINERY  
IMPORTS LTD.

P.O. Box 312  
Dept. 295  
New Castle, DE  
19720

## OLD HAND WAYS

Continued from page 23

leaves he recut from the "original" walnut table top.

The cabinetmaker joined the drop leaves with rule joints—so-called because of their resemblance to a folding ruler. They were ideal because the main top supports any load on the leaf.

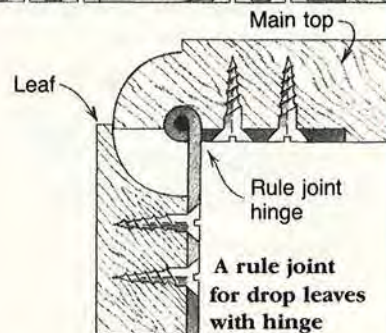

Hinges made for rule joints differ from common ones. They have countersunk screwholes on the opposite side from the raised hinge knuckle. Shaping the hollow and round elements of the rule joint with his two molding planes, he knew that the table was better than the original.

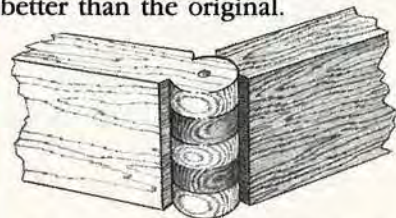

A knuckle joint for swing-out legs

Finally, the table came down to me with not an original piece in it. I am still very proud, though, of my walnut, drop-leaf table that began as a pine tree. 🌲



**By Roy Underhill**  
Master housewright at Colonial Williamsburg in Virginia and host of the popular PBS series *The Woodwright's Shop*, Underhill is also an author and lecturer.

Photograph: Courtesy Colonial Williamsburg  
Illustrations: Jim Stevenson

## ANYTIME ANYWHERE ANYWOOD mold plane and edge

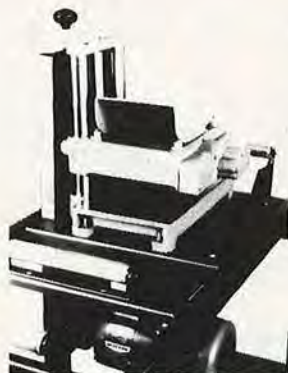

Professionals and hobbyists alike know the strengths of the W&H molder-planer. Superior US-made construction and quick two-minute cutter changes make it a snap to cut moldings and plane hardwoods. It's fast, easy, and super-smooth.

Picture frames. Crown moldings. Raised panels. And more. Our three models offer the best value in your shop or on the job site!

Our five-year warranty and free 30-day trial are your assurance that W&H goes the distance.

Mail this ad or call us toll-free today.

**1-800-258-1380 In NH 603-654-6824**

Williams & Hussey P.O. Box 1149 Dept. 238IM  
Wilton, NH 03086



YES! Send your free information kit today.

Name \_\_\_\_\_

Address \_\_\_\_\_

City \_\_\_\_\_ State \_\_\_\_\_ Zip \_\_\_\_\_

- I am a professional  I am a hobbyist  
 I am also interested in your 12" lathe



**DUST COLLECTOR**

UFO-90 1HP Motor  
UFO-101 2HP Motor  
UFO-102B 3HP Motor



**SPINDLE SHAPER**

SK-30SPA  
1" and 3/4" Spindle  
3HP with forward and reverse control



**STROKE BELT SANDER**

SK-1500BS  
60" x 21 1/4" sliding table  
5" sanding belt width  
2HP motor

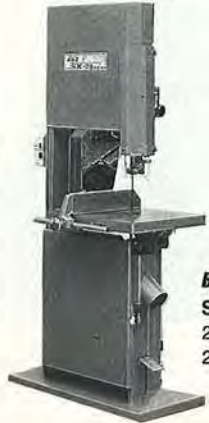

**BAND SAW**

SK-20BS  
20" cutting width  
2HP motor

**12" TILTING ARBOR TABLE SAW**

HTS-0012A ..... **\$805.00**  
With cast aluminum guide rail.  
3HP motor



**DRUM SANDER**

SK-15DS  
15" sanding width  
SK-20DS  
20" sanding width  
Two different grit precision contact drum. 3HP sanding motor. 1/4HP auto feeding motor



**TRUE VALUE for HIGH QUALITY machinery**



**SPINDLE SHAPER**

SP-0034 ..... **\$280.00**  
3/4" and 1/2" spindle  
1HP. with forward and reverse control



**JOINTER**

JT-0012 ..... **\$1950.00**  
12" planing width.  
13 3/8" x 72" precision ground cast iron table.  
3HP motor



**POWER FEEDER**

SK-303FD ..... **\$659.00**  
1HP, 3phases  
SK-301FD ..... **\$695.00**  
1HP, 1phases  
SK-321FD ..... **\$429.00**  
1/4HP, 1phases



**WIDE BELT SANDER**

A-2548 ..... **\$5535.00**  
24" working width.  
A-3760 ..... **\$8685.00**  
36" working width.  
3 precision balanced contact drum. Rugged heavy duty metal construction. Full power motors drive sanding and auto infeed smoothly.

**12" PORTABLE PLANER**

WP-3012 ..... **\$399.00**  
Stand (optional)  
WP-3012S ..... **\$39.00**



**AUTOMATIC SPINDLE SHAPER**

SP-150A  
1 1/4" spindle w/foot spindle lock  
sliding table  
Cast iron fence  
5HP motor 3speed  
Air clamp (optional)

ONE YEAR FREE PARTS WARRANTY.  
WE SPECIALIZE IN CUSTOMER  
SATISFACTION.

**LEBO POWER TOOLS**

10922 KLINGERMANN ST# 3  
S. EL MONTE, CA. 91733

FREE CATALOGUE. DON'T MISS IT.  
WRITE OR CALL NOW  
(818) 350-1096

# HOBBY WORKHORSE



Whether your hobby is building planes, trains, automobiles or hobbyhorses, you need the right tool for the job.

The Dremel Moto-Tool® is a hobby workhorse that works wonders. It shapes cherry wood into lifelike wildlife. Cuts off model railroad tracks at the end of the line. Sands balsa wood smooth enough to really take wing. And buffs an old iron horse to a showcase shine.

The Moto-Tool lets you get more satisfaction and enjoyment out of your hobby by putting more precision and control into it.

With speeds up to 30,000 RPM, the Moto-Tool gives you the "horsepower" to cut, grind, sand, drill and polish with pinpoint accuracy. And its lightweight housing makes hours of work seem effortless.

See the Moto-Tool at your hobby, craft or hardware dealer. And put a little more horsepower into your hobby.



**DREMEL**  
Gets the job done bit by bit.

© 1988 Dremel

# MAKING A GOOD LATHE EVEN BETTER

**O**ur shop-built lathe, featured in the April 1987 issue of *WOOD* magazine, has proven to be popular.

In addition to the original model here in our shop, we've had people on staff build them for their personal workshops. And, according to our suppliers, more than 200 readers have ordered the parts to build their own.

After many hours of use, we found our homemade tool rest wasn't as easy to use as most commercial models. Striving for improvement, we ordered several tool rests and bases, and tried them on our lathe.

Which is the best? It's hard to say. Each performed well (admittedly better than our homemade version), so we decided to show you the four we tested, and let you choose the best system for your needs. The prices listed include postage and handling.



We added  $\frac{1}{2} \times 2\frac{1}{2} \times 64$ " steel strips to the top of the ways for three of the tool-rest bases to track on. The steel and cutting cost us \$25 at a local machine shop. The fourth base, made by Conover, tracks on the wooden ways of the lathe as designed. The drawing *below* shows the steel strips screwed to the laminated-plywood ways.

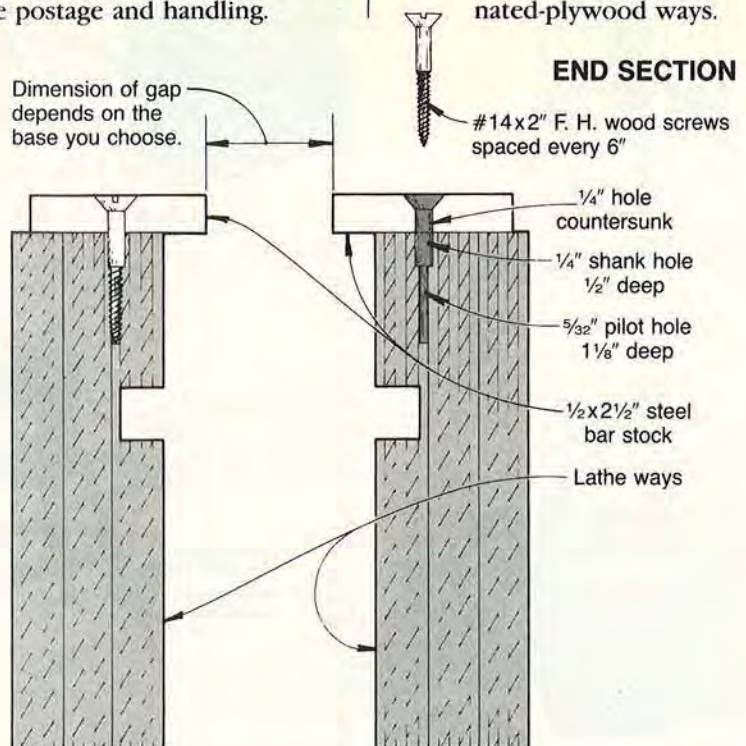

Continued on page 28



## HITACHI

TR12-3 HP Plunge Router, \$60.00 Free Accessories .....	\$160.00
C8FB-NEW-8 1/2" Slide Compound Saw (cuts 2-9/16"x 12"—Tipped Saw Blade) .....	\$549.00
C10FA-10" Deluxe Miter Saw .....	\$259.00
C15FB-15" Deluxe Miter Saw .....	\$379.00
CJ65V-D handle Orbital Jigsaw, Variable Speed .....	\$139.00
CJ65VA-Orbital Jigsaw, Variable Speed .....	\$139.00
F20A-3 1/4" Planer .....	\$98.00
D10D-3/8" Screwdriver Cordless Drill 9.6v .....	\$129.00
D10VC-3/8" Variable Speed Rev. Drill .....	\$74.00
DRC10-3/8" Cordless Screwdriver Drill 7.2v .....	\$89.00
D10DC-3/8" Variable Speed, Cordless Screwdriver Drill 7.2v .....	\$118.00
GP2- 1/4" Longnose Die Grinder .....	\$107.00
SV12SA- 1/4" Shear Orbital Block Sander .....	\$56.00
SB75-3 x 21 Belt Sander .....	\$159.00
D13DS-1/2" Drill Stand .....	\$49.95
W6V1-Screwdriver, Variable Speed .....	\$64.00
F1000A -Planer/Joiner .....	\$1359.00
CB75F-Resaw Bandsaw .....	\$1729.00
PDM115-Heavy-Duty 4 1/2" Mini Grinder .....	\$94.95
G10SA-Heavy Duty 4" Disc Grinder w/clutch .....	\$79.95

## scheppach

TS4000 12"-14" Table Saw with Super Fence (4 HP, single phase- 4000 rpm) \$1495.00
HF3000 NEW Shaper/ Vertical Spindle Moulder (3 hp, 1 phase, 3000-6000-9000 rpm \$1195.00
HMT260 NEW 10 1/2" Planer/ Joiner \$925.00
HA26 Dust Extractor 3/4 HP, 5" Water Column, 1000m <sup>3</sup> /h \$499.00
HBS32 Vario Precision Band Saw \$864.00
DMV200 42" Heavy Duty Lathe \$1529.00
DMT175 35" Wood Turning Lathe \$689.00
Beechwood Workbench-Vises \$275.00

TOOLS-TO-GO inc  
15935 NW 57 Ave. Hialeah, FL 33014

To Place An Order:

Call Toll Free 1-800-445-1419 (USA)  
In Florida 1-800-330-5057  
Call for quotes on other products. Orders over \$50.00  
Shipped Freight PPD. Over 70 lbs FOB Hialeah  
Florida Residents add 6% sales tax.



## STAYER TTG 125



**125" SURFACE PLANER**  
The Ultimate Power  
Planer! It's the One You  
Waited For! Extended By  
Popular Demand.

**\$401**

F.O.B. HIALEAH Extra Blades \$20 (with purchase)—Planer Stand \$54

We accept MasterCard, Visa, Discover, Check, & Money Order. Prices subject to change without notice. Limited Quantities.

## AEG ALL PRO™



HBSE75S Variable Speed 3 x 21 Belt Sander with Dust Bag & Stand .....	\$149.95
Sanding Frame \$69.00 Right Angle Attachment \$21.00	
EZ 502 Cordless Screwdriver, adj. 2 Position Handle, 6 Position Clutch .....	\$59.95
EZ 506 Cordless Variable Speed Drill/Driver 7.2v .....	\$118.00
EZ 560 2 Speed Cordless Drill/Driver 7.2v .....	\$113.00
PC70-1 7 1/4" Parallel Shoe Circular Saw- The most POWERFUL .....	\$129.00
PC80-1 8 1/4" Parallel Shoe Circular Saw- EXTRA POWER .....	\$149.00
SSPE800 SABRETOOTH Reciprocating Saw in Steel Case .....	\$138.00
BSPE60 Electronic Top Handle Jigsaw ORBITAL in Steel Case .....	\$138.00
FSPE100 NEW Orbital Electronic Jigsaw with Full use of long blade .....	\$139.00
EH82S 3 1/4" Finish Planer - INCLUDES Carbide Blades & 800W Power .....	\$189.00
VS130 20,000 opm 1/3 sheet Sander .....	\$67.00
VSS280 Orbital Sander w/Dust Bag 1/2 Sheet .....	\$129.00
SBE401RL 3/8" Hammer Drill .....	\$79.00
SBE10RL 1/2" Hammer Drill .....	\$129.00
SCR I EI Screwdriver Variable Speed Rev. 0-2500 RPM .....	\$98.00
SCR I I EI Screwdriver Variable Speed Rev. 0-4000 RPM .....	\$98.00

# VAUGHAN

*For people who take pride in their work  
...tools to be proud of.*



Available at hardware stores and home centers

**VAUGHAN**

VAUGHAN & BUSHNELL MFG. CO.  
11414 Maple Ave. • Hebron, IL 60034

# Feed it just about anything.

Pick a board. Any board. With the 10" Motorized Table Saw from Delta, you can turn it into moulding, shelving and fine furniture.

**You can do a whole lot for only \$329.**

Rip to the center of a 4' panel. Crosscut stock 3 1/8" thick; 2 1/8" at 45°. Cut dados, moulding and tenons with our optional accessories.

And the standard features are anything but standard. A cast iron table with steel extension tables. Powerful 15 Amp. motor. And a self-aligning rip-fence with single control handle.

The rugged, versatile 10" Motorized Table Saw from Delta. At only \$329, you get a lot more than you pay for. Call toll-free for the name of your Delta dealer. Delta International Machinery Corp., 800/438-2486 (in PA, 800/438-2487).

Building  
On Tradition  
**DELTA**  
A Pentair Company

Model 34-670

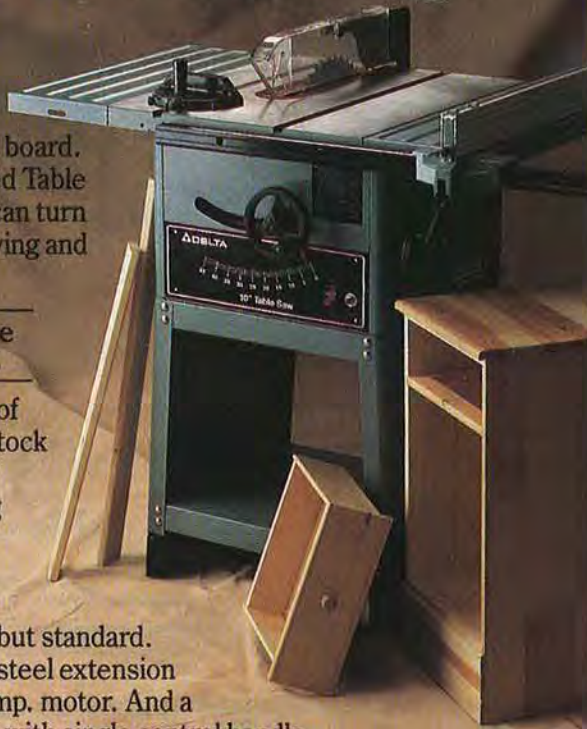

## LATHE

Continued from page 26

### PICK THE TOOL REST AND BASE THAT BEST FIT YOUR NEEDS

At the low end of the price spectrum, the Rockwell standard base (no. 46-831) retails for \$42. Both this unit and the deluxe Rockwell base require a custom-made height-adjustment adapter (\$25). The adjustment adapter is available only from the source listed below. The 12"-long rest (no. 46-692) sells for \$15, a 4" rest (46-690), \$13; and an outside French curl (no. 46-405), \$13. The gap between the steel strips measures 1 5/8" for both this base and the Deluxe model listed below. Our source: Puckett Electric, 1011 Keo Way, Des Moines, IA 50309; 800-544-4189.



Standard Rockwell Tool-Rest Base

Sturdier and more expensive, the Rockwell deluxe tool-rest base (no. 46-171) shown below retails for \$105. The attachments mentioned above for the standard base also fit this model. From Puckett Electric, address and phone number listed above.



Deluxe Rockwell Tool-Rest Base

Continued on page 30

### New Money-Making Possibilities!

## LATHE ART

### NEW TECHNIQUES ON THE WOOD LATHE

This new woodworking workbook offers nine new lathe projects, using small pieces of scrapwood, hardwood and plywood.

Simply written with photos and diagrams, showing how to make lamps, bowls and other decorative and useful items.

Described within are the Bethune Clamp, and the Bethune Rotary-rasp Technique, along with tips and ideas.

Make check or money order for \$9.95 - \$1.50 for shipping & handling for each book payable to:

**JAMES N. BETHUNE • BETHUNE WOODWORKING**  
165 Beckwith Rd. S., No. 98, Santa Paula CA 93060  
805-525-9394

## Furniture Restoration

### Big Money in Small Business

Stripping ★ Repairing ★ Refinishing  
Mirror Resilvering ★ Veneering

### Earn \$200-\$1000 a day!

At home or in shop ★ Spare time, full time  
★ Men or women ★ Complete training, no experience necessary  
★ Simple, fast, safe, fun.

### FREE CATALOG

Send \$2.00 for postage & handling to  
**MINUTEMAN, INC., Dept. 17,**  
115 N. Monroe St., Waterloo, WI 53594

## PLATE JOINER SALE!!!

Choose from two of the best names in plate joiner technology.

freud.



### JS100 JOINER SYSTEM

- Double Insulated
- High Density Plastic Storage Case
- Cast Aluminum and High Impact Plastic Housing
- Easy on-off switch
- Allows joining edge-to-edge or at 45° & 90°
- Fits all 3 sizes of standard splines

List Price \$259.00  
**SALE \$169.95**

PORTER+CABLE  
PROFESSIONAL POWER TOOLS



### MODEL 555 PLATE JOINER

- Super Torque PD™ belt drive
- Unique verticle handle
- Trigger switch
- Rotating depth adjustment with preset stops
- Exclusive miter fence
- Steel carrying case

List Price \$269.95  
**SALE \$179.95**

- WE HONOR ALL FREUD NATIONALLY ADVERTISED SPECIALS
- CALL OR WRITE TODAY FOR CURRENT PRICES ON OTHER TOOLS/ACCESSORIES
- PRICES QUOTED, DELIVERED PREPAID ON \$75 MINIMUM ORDER
- VISA, MASTERCARD ACCEPTED

**CALL TODAY FOR NEXT DAY SHIPPING**  
803-779-3131 Ext. 19



**YOUR WOODWORKING SPECIALIST IN THE SOUTHEAST**

## THE PERFORMAX S/T THE AFFORDABLE DRUM SANDER



A Space-saving  
Radial Saw  
Attachment  
or Stand  
Alone Unit.

Manual  
or Power  
Feed.

Affordable  
Accurate & Efficient

Wide  
Surface  
Drum Sander

### New Power Feed Option

Variable Speed Conveyor Unit For Effortless and Flawless Sanding

The Performax S/T Sander is the affordable drum sander with features that make sanding FUN!

Rigid open-end design insures precise thickness dimensioning over a 44" width—no more high and low spots.

22" wide sanding drum with built-in sandpaper fasteners make changing grits a snap—no adhesives required.

Attaches to a radial arm saw or to a stand. (Hardware Kit Available).

American made of strong, yet light, non-corrosive aluminum. Money Back Guarantee.

For a free brochure call or write  
**PERFORMAX PRODUCTS, INC.**

11975 Portland Avenue So., Suite 142

Dept. W, Burnsville, MN 55337

1-800-334-4910



Stand Hardware Kit

## World's Best Machinery Value

### Guaranteed!

If you're ready to trade up to real quality at an affordable price...you're ready for KITY.

KITY offers a full range of machinery, from precision independent machines to our economical combination, the K-5.

Our info kit includes pricing, specifications, and details on how you can use a new KITY in your shop for 30 days FREE!

Call or Write  
For More Info

**1-800-USA-KITY**

Mail Coupon to:

In MO Call (816) 229-3055



309 N. Tenth Street • Blue Springs, MO 64015

Yes, Send me information on the following KITY Woodworking Machines & Accessories

- 10" Table Saw     Jointer/Planer     3-Speed Shaper  
 K-5 Combination     V.S. Lathe     1-hp Band Saw

Name \_\_\_\_\_

Address \_\_\_\_\_

City \_\_\_\_\_ State \_\_\_\_\_ ZIP \_\_\_\_\_

## \$28.00 Woodworkers Package for Only



**•You Get:** 25 full size shaker pegs, 25 mini shaker pegs, 25 mug rack pegs, 25 tie rack pegs, plus a unique horse design coat rack plan, beautiful full size tie rack plan, and a full size mug rack plan.  
**•But That's Not All:** Patterns for 10 great items—a hanger for pot holders, note pad holder, napkin holder, muffin server, doughnut holder, pretzel holder, cleanser holder, knife rack, towel bar, and spice shelf. Plus: full size plans for four cars and garage. You'll also receive our woodworking catalog, loaded with professional power tools, hand tools, wood parts, books, plans and lots more. Order up to four of these packages. Add \$2.95 shipping and handling for each package.

**\$28.00 Woodworkers Pkg.—Just \$9.95!**

Name \_\_\_\_\_

Address \_\_\_\_\_

City \_\_\_\_\_ State \_\_\_\_\_ Zip \_\_\_\_\_

Quantity	Price Ea.	Total

TOTAL: Add \$2.95 Shipping/Handling Each Package. (MA residents add 5% each order for sales tax)

**TOTAL PRICE** \_\_\_\_\_

Mail To:  
**Trend-Lines, Inc.**  
375 Beacham St.  
Box 6447M  
Chelsea, MA  
02150

E8098

# Unfinished furniture... a beautiful product, a growing business.

The satisfaction of owning your own business becomes even greater when you sell a product you can take pride in. Our showrooms offer fine wood furniture in its natural state. We'll finish it, or provide the customer with the tools and know-how to do it himself.

An excellent retail operation. A satisfying way to spend your time. For franchise information, call Patrick V. Lippa at (800) 333-2402.

Exclusive territories available in major markets east of the Mississippi. Dozens of showrooms in operation, dozens more to come.

**NAKED  
FURNITURE**  
Sofas & more®

1099 Jay Street, Rochester, N.Y. 14611

This advertisement is not an offering. An offering can only be made by prospectus filed first with the Department of Law of the State of New York. Such filing does not constitute approval by the Department of Law.



## POWERMATIC



Call For Our Low Prices! We carry the entire Powermatic line at very attractive prices. Please call for our prices on the Model 66 and other Powermatic machines. You'll be glad you did!

Model 66 Table Saw with 50" Biesemeyer Rip Fence. 3HP, 1PH or 5HP, 3PH motor FOB our Warehouse

## Mini-Max

World's Best Jointer-Planer

FS35 Jointer-Planer \$2195

Length 63" Width 13 3/4" Weight 719 lbs  
3HP, 1PH or 3HP, 3PH Motor

Please call or write for more information on the FS35 jointer-planer. We stock the entire Mini-Max line. Please call for our prices. FOB our Warehouse. Call for discounted freight rates.



## MAKITA

B04510	4" finishing sander	\$ 59
1100	3 1/4" planer kit	\$209
1805	6 1/4" planer kit	\$309
2708	8 1/4" table saw	\$229
3612BR	plunge router	\$189
GUIDES for 3612BR		\$ 28
3601B	1/2" router	\$148
3700B	1/2" trimmer	\$ 95
4301BV	orbital nip saw	\$139
5007NB	7 1/2" circular saw	\$109
6000LR	1/4" clutch drill	\$119
6012HDW	1/4" cordless clutch drill	\$109
9900B	3x21 belt sander	\$129
998240B	3x24 belt sander	\$149
9401	4x24 belt sander	\$169
98202	blade sharpener	\$169

## RYOBI SPECIALS

S500A	3 x 4 1/4" Pad Sander	\$ 39
SU6200	1/2" Sheet Pad Sander	\$ 99
B7075	3 x 21 Dustless Belt Sander	\$105
B7100	3 x 24 Dustless Belt Sander	\$121
B7200A	4 x 24 Dustless Belt Sander	\$148
R151	1HP Plunge Router	\$ 95
R501	2 1/4HP Plunge Router	\$159
TR30U	Trimmer	\$ 77
TS380	14" Miter Saw	\$369



10" width of cut  
13 Amp, 110v  
Motor  
Powerfeed  
CALL FOR  
OUR PRICE!  
**AP-10 Thickness Planer**

## FREUD SPECIALS

TT-108	8 Pc. Turning Tool Set	\$ 59
90-100	15 Pc. Router Bit Set	\$138
92-100	26 Pc. Router Bit Set	\$284
94-100	5 Pc. Router Cabinet	\$159
FB-100	16 Pc. Forstner Bit Set	\$159
EC-900	5 Pc. Shaper Cabinet Set	\$264
EC-209-213	Raised Panel Cutters	\$85
EC-260	1/4" Cabinet Door Set	\$157

## Sawblades

LM72M	10", 24T, Rip Blade	\$38
LU73M	10", 60T, ATB Cutoff	\$38
LU84M	10", 50T, Combination	\$38
	Set of Three Above	\$107
LU82M	10", 60T, Triple Chip	\$42
LU85M	10", 80T, Super Blade	\$58
DS306	6" Dado	\$99
DS308	8" Dado	\$109
JS100	Plate Joiner	\$169
JS020	1000 Biscuits	\$29
F1100	Spare Cutter	\$ 34

## MAKITA STATIONARIES

2040	15" Planer	\$1275
2020	8" Jointer	\$775

## HITACHI

F-1000A	Jointer-Planer	\$1395
CB75F	Resaw Bandsaw	\$1645
C15FBP	15" Miter Saw	\$409
C101FB	10" Miter Saw	\$279
TR12	Plunge Router	\$173

## PORTER CABLE

518	3HP Speedtronic Router	\$323
630	1HP Router	\$ 93
690	1 1/2HP Router	\$124
310	Laminate Trimmer	\$124
312	Offset Laminate Trimmer	\$133
319	Tilt-Base Laminate Trimmer	\$138
330	Speed-Block Sander	\$ 64
352	3 x 21 Dustless Belt Sander	\$130
360	3 x 24 Dustless Belt Sander	\$185
362	4 x 24 Dustless Belt Sander	\$198
555	Plate Joiner	\$169
345	Saw Boss	Call

## JET POWER TOOLS

JBS-14MW	Metal/Wood Bandsaw	\$349
JJ-6	6" Jointer	\$339
JTS-10	10" Contractors Saw	\$439
CTAS-10	10" T/A Table Saw with 50" Biesemeyer Fence	\$1275
JJ-8	8" Long-Bed Jointer	\$899
JWP-15H	15" Thickness Planer	\$999
DC-610	1 HP Dust Collector	\$329
DC-1182	2 HP Dust Collector	\$449

JET Prices include delivery east of the Mississippi

## LEIGH

T0514L	24" dovetail jig with 1/2" bits for 1/2" dovetails	\$239
D1258-12	New 12" jig for through and half blind dovetails	\$255
D1258-24	New 24" jig for through and half blind dovetails	\$289

Optional Bits in Stock

# LATHE

Continued from page 28

Bowl turners will love General's extended base. It's 13 1/2"-length makes reaching the outside of a large bowl a breeze. The S-curve bowl rest shown *below*, makes turning the curved surfaces of bowls easier with less chatter. The rest allows you to support your turning tool next to the curved surface—something not always obtainable with a straight rest. The G-264 base sells for \$109 and the S-curve rest (BR500) with 5" shaft sells for \$47. The gap between the steel strips measures 1 7/8". Craft Supplies, 1287 E. 1120 S., Provo, UT 84601; 801/373-0917.



General's Extended Tool-Rest Base

The Conover tool-rest base shown *below* mounts to the ways without adding the steel strips. (Our lathe already had the strips permanently attached before we took the picture.) The base (CL16-300), which sells for \$75, tightens to the ways by the use of a handwheel located below the ways. The 12" rest (CL16-306, shown in the photo) sells for \$26. The 6" (CL16-307) rest sells for \$24 from Conover Woodcraft Specialties, 18125 Madison Rd., Parkman, OH 44080; 216/548-3481.



Conover Tool-Rest Base

Photographs: Bob Calmer

## The Xylophile's Company

138 E. Loudon Ave. • Lexington, KY 40505

1-800-354-9083 —M/C VISA— (606) 254-9823

Orders over \$35.00 include delivery unless otherwise noted. Prices subject to change without notice.



# Add big value to your home with a small investment in your home workshop!

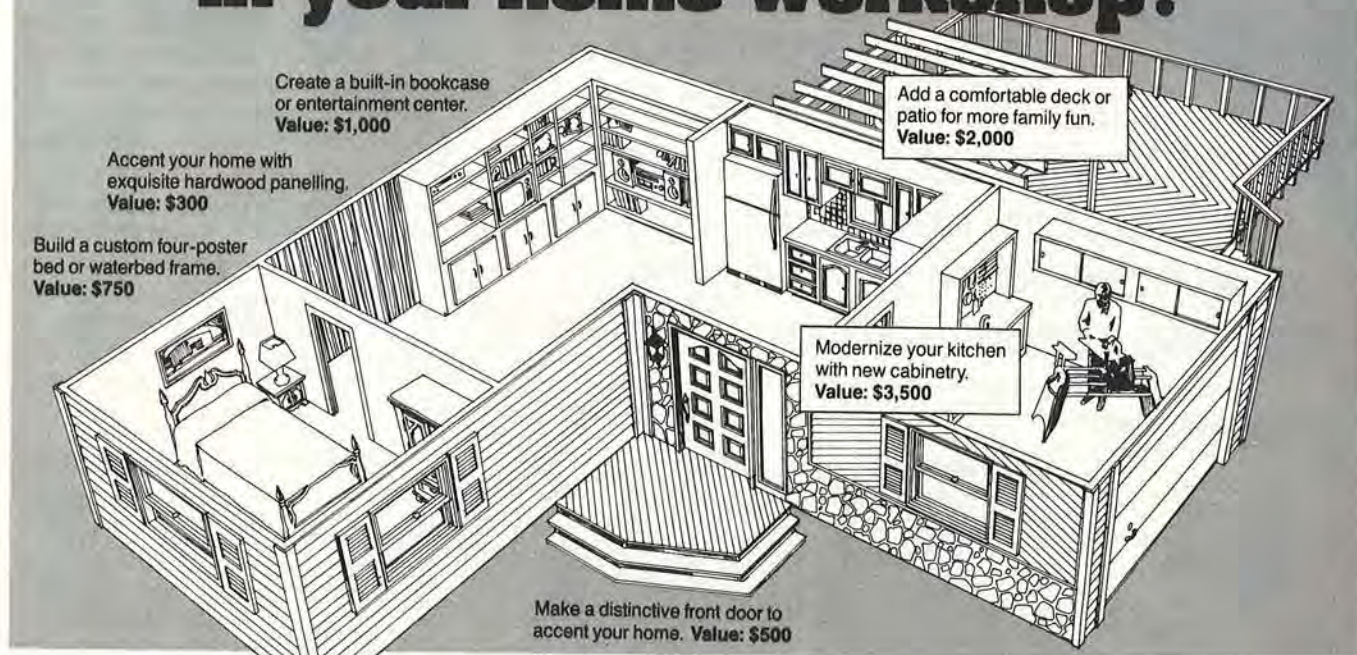

Create a built-in bookcase or entertainment center.  
Value: \$1,000

Accent your home with exquisite hardwood panelling.  
Value: \$300

Build a custom four-poster bed or waterbed frame.  
Value: \$750

Add a comfortable deck or patio for more family fun.  
Value: \$2,000

Modernize your kitchen with new cabinetry.  
Value: \$3,500

Make a distinctive front door to accent your home. Value: \$500

If you'd like to add to the value of your home by doing repairs or remodeling, you really only have three choices:

1. Hire an expensive professional to do the job for you.
2. Buy a workshop full of individual power tools that could cost you thousands.
3. Get your hands on a Shopsmith MARK V—the *affordable* all-in-one home workshop system that replaces the five most needed woodworking tools with a single, compact unit!

## The Shopsmith® MARK V does it all!

Whether you're building a set of kitchen cabinets, creating your own entertainment center, or just making a few repairs around the house, the MARK V is all you need to do it right. And by doing it yourself, you'll easily save enough to pay for your new MARK V...and have a lot of fun in the process.

## The MARK V can save you a bundle on equipment!

With the Shopsmith MARK V you'll have a table saw, drill press, horizontal boring machine, lathe and disc sander in a single unit that can be stored in the same amount of space as a bicycle. And with our special add-on accessories you'll be able to perform over 150

different operations at a fraction of what you'd expect to pay for separate tools. Now, *that's* value!

## All the support you could ask for.

As a MARK V owner, you receive complete operating instructions—plus you can learn more about woodworking through our classes, seminars, educational video tapes, catalogs and our special owners' magazine, "Hands On".

You can also call us Toll-Free for the answers to all your woodworking questions. And you'll have the confidence of dealing directly with Shopsmith, either by mail, Toll-Free phone or at one of our growing network of Shopsmith Stores.



Dept. 3749

## Ask for a FREE Information Kit—with No Obligation!

To find out more about woodworking with the Shopsmith MARK V, call Toll-Free or mail the coupon below. We'll rush you a FREE Information Kit in your choice of Full Color Brochure or VHS Videocassette and Color Brochure.

There's no obligation, so act NOW.

For your FREE Information Kit Call  
**1-800-445-3232**  
or mail the coupon below to:



## Shopsmith Inc.

The Home Workshop Company  
3931 Image Drive  
Dayton, Ohio 45414-2591

© 1988, Shopsmith, Inc.  
Shopsmith® is a registered trademark of Shopsmith, Inc.

**Yes!** I'd like to know more about how I can use the Shopsmith MARK V to add big value to my home. Please send me:

- FREE Color Brochure on the Shopsmith MARK V, or  
 FREE VHS Videocassette and Color Brochure. (128-3750)

Name \_\_\_\_\_  
Address \_\_\_\_\_  
City \_\_\_\_\_ State \_\_\_\_\_ Zip \_\_\_\_\_  
 I currently own Shopsmith Power Equipment.  
Send to: Shopsmith, Inc., 3931 Image Drive, Dayton, OH 45414-2591

**FREE!**  
2nd Day Air  
Delivery With All  
Router Bit & Shaper  
Cutter Orders of \$100 or more

**Cascade Precision Tool Co.**  
Box 848, Mercer Island, WA 98040

"Custom Grinding a Specialty"

**BEST FACTORY-DIRECT  
PRICES ON PROFESSIONAL**

**QUALITY CARBIDE-TIPPED S BRAND  
ROUTER BITS & SHAPER CUTTERS!**

**SEND \$1.00 (Refundable with first  
order) FOR OUR NEW 12-PAGE CATALOG  
FEATURING A GREAT SELECTION LIKE THESE:**



**CARBIDE TIPPED SHAPER CUTTER PANEL RAISER** —  
3 WING, 5 PROFILES, 3MM THICK CARBIDE  
• 4-5/8" O.D. with 3/4" BORE (1/2" BUSHING)  
• 5-1/2" O.D. with 1-1/4" BORE (1" BUSHING)

\$69.95



**6 PC CARBIDE TIPPED  
CABINET SETS**

• 3 mm CARBIDE  
• 3/4" BORE W/ 1/2" BUSHING

**ONLY \$179.95**

13 Great Cabinet Sets including these popular Profiles:



(1-1/4" Bore with  
1" Bushing—  
ONLY \$249.95)

**1/2" SHANK CARBIDE TIPPED CABINET DOOR SET**



• Big 3-1/2" O.D. PANEL RAISER

3 pc. set  
**ONLY \$179.95**

• RAIL/STILE CUTTER  
• RAIL END CUTTER  
• PANEL RAISER ALONE

**\$59.95**

• DRAWER GLUE JOINT \$35.00

• CORNER LOCK MITRE 3-3/8" O.D. \$49.95 For up to 1" material

**FOR THE SHAPER**

3 mm thick C-2 carbide, 3/4" Bore  
w/ 1/2" Bushing  
**Straight**



SY-1212-1 SY-1212-4  
1/4" \$24.95 3/4" \$32.95

SY-1212-2 SY-1212-5  
3/8" \$26.95 1" \$35.95

SY-1212-3  
1/2" \$28.95

**Flute**



SY-1223-1 SY-1223-4  
1/4" \$24.95 3/4" \$32.95

SY-1223-2 SY-1223-5  
3/8" \$26.95 1" \$35.95

SY-1223-3  
1/2" \$28.95

**Bead**



SY-1224-1 SY-1224-4  
1/4" \$24.95 3/4" \$32.95

SY-1224-2 SY-1224-5  
3/8" \$26.95 1" \$35.95

SY-1224-3  
1/2" \$28.95

**Dovetail**

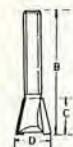

PART NO.	D	PRICE
B04	1/2	\$6
*B04 1/2	1/2	\$6
B06	9/16	\$8
B10	3/4	\$8
*B10 1/2	3/4	\$8
*B12 1/2	1	\$10

**Flush Trimming**

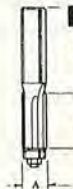

PART NO.	A	PRICE
S8012Y	3/8	\$7
S8016Y	1/2	\$8
*S8016Y 1/2	1/2	\$8
S8020	5/8	\$10
*S8020 1/2	5/8	\$10

**Vee Groove Bits**



PART NO.	A	PRICE
S112	3/8	\$10
S114	1/2	\$10
S128	3/4	\$12
*S128 1/2	3/4	\$18
S130	1	\$20
*S130 1/2	1	\$24

**Corner Round**



SY-1225-1 SY-1225-4  
1/4" R \$24.95 3/4" R \$35.95

SY-1225-2 SY-1225-5  
3/8" R \$26.95 1" R \$49.95

SY-1225-3 SY-1225-6  
1/2" R \$28.95 1 1/4" R \$49.95

**FOR THE ROUTER!**

**Cove Bits**

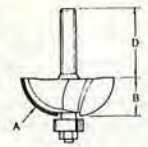

PART NO.	A	PRICE
S702Y	1/16	\$11
S704Y	1/8	\$11
S706Y	3/16	\$11
S708Y	1/4	\$12
S710Y	5/16	\$12
S712Y	3/8	\$12
S716Y	1/2	\$13
*S716Y 1/2	1/2	\$14

**Roundover**

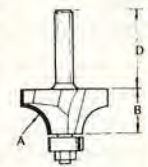

PART NO.	A	PRICE
S502Y	1/16R	\$10
S504Y	1/8R	\$10
S506Y	3/16R	\$10
S508Y	1/4R	\$10
S510Y	5/16R	\$11
S512Y	3/8R	\$13
S516Y	1/2R	\$15
*S516Y 1/2	1/2R	\$15
*S520Y 1/2	5/8R	\$18
*S524Y 1/2	3/4R	\$18
*S528Y 1/2	7/8R	\$30
*S532Y 1/2	1R	\$30
*S536Y 1/2	1-1/4R	\$38

**Core Box**

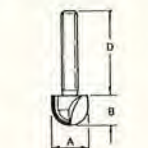

PART NO.	A	PRICE
S408	1/4	\$9
S412	3/8	\$10
S416	1/2	\$11
S420	5/8	\$12
S424	3/4	\$14
*S424 1/2	3/4	\$14
*S432 1/2	1	\$15

**Beading**

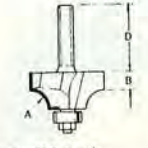

PART NO.	A	PRICE
S602Y	1/16R	\$11
S604Y	1/8R	\$11
S606Y	3/16R	\$11
S608Y	1/4R	\$12
S610Y	5/16R	\$13
S612Y	3/8R	\$15
S616Y	1/2R	\$15
*S616Y 1/2	1/2R	\$15
*S624Y 1/2	3/4R	\$18

\*Indicates 1/2" shank.

**Bull Nose**

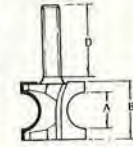

PART NO.	A	PRICE
SY9-1	1/4	\$12
*SY9-1 1/2	1/4	\$12
SY9-3	3/8	\$14
*SY9-3 1/2	3/8	\$14
SY9-4	1/2	\$14
*SY9-4 1/2	1/2	\$14
SY9-5	5/8	\$15
*SY9-5 1/2	5/8	\$15
SY9-6	3/4	\$15
*SY9-6 1/2	3/4	\$15
*SY9-8 1/2	1	\$17
*SY9-9 1/2	1-1/8	\$25
*SY9-10 1/2	1-1/4	\$30
*SY9-11 1/2	1-1/2	\$38

**Roman Ogee**

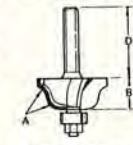

PART NO.	A	PRICE
S5705Y	5/32	\$15
*S5705Y 1/2	5/32	\$15
S5708Y	1/4	\$16
*S5708Y 1/2	1/4	\$16

**Slot Cutter - 4 Flutes**

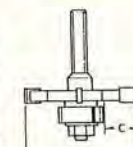

PART NO.	A	PRICE
SY7002	1/8	\$20
*SY7002 1/2	1/8	\$20
SY7004	5/32" (4mm)	\$20
*SY7004 1/2	5/32" (4mm)	\$20
SY7006	3/16	\$20
*SY7006 1/2	3/16	\$20
SY7008	1/4	\$20
*SY7008 1/2	1/4	\$20

**Slot Cutters/  
Rabbeting Bit**

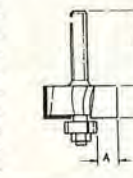

PART NO.	B	PRICE
S1702Y	1/16	\$10
S1704Y	1/8	\$10
*S1704Y 1/2	1/8	\$10
S1706Y	1/4	\$11
*S1706Y 1/2	1/4	\$11
S1708Y	3/8	\$11
*S1708Y 1/2	3/8	\$11
S1712Y	1/2	\$12
*S1712Y 1/2	1/2	\$12



MC / VISA / COD USERS **ORDER TOLL FREE 1-(800)-235-0272**  
IN WASHINGTON STATE CALL **1-236-0272**  
10 AM - 7 PM - Monday through Saturday

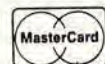

**N**ative Americans turned the bounty of the land into the essentials of life. The tree that the Narragansett Indians called *sasauaka-pamuch* was no exception. Long before European explorers landed on the continent, the tree yielded its roots, bark, and leaves for a medicinal brew believed to cure everything from sore eyes to diarrhea.

Colonists coined the word sassafras from the Indian's language. And from the tree's healing properties, they coined profits from export. Sassafras tea was touted across the ocean as a tonic to "thin the blood and purify the system."

To those pioneers who used the wood, sassafras became well known as long lasting. Because it resists rot in contact with the ground, farmers sunk it for fence posts and split it for rails. Since it was light and absorbed little water, sassafras also was ideally suited for canoes and cooperage.

In the woodshop, sassafras often becomes a substitute for chestnut. It also resembles ash, and mixes well with it in furniture manufacturing.

### Wood identification

Ancestors of sassafras (*Sassafras albidum*), a truly American species, grew across the continent during early geologic periods. Now, it's found from southern Maine south to central Florida and west to the Mississippi River Valley and eastern Texas.

# SASSAFRAS

## The look-alike wood better known as tea



Sassafras

In its northern range, sassafras rarely grows larger than shrub-size. But in favorable conditions in North Carolina and Tennessee, sassafras trees may reach 5' in diameter, 100' tall, and live 1,000 years.

Sassafras rarely grows in stands. Instead, it mixes with white oak, persimmon, and sweet gum. You can pick it out by its normally flat-topped crown or twisted branches sticking straight out from the trunk. Old trees have deeply furrowed, reddish-brown bark with flattened ridges, and appear as if

they had been washed with light gray. The bark of young trees looks reddish, but has cracks instead of furrows.

Sassafras leaves are a dead giveaway—they have three long lobes, often misshapen, and varying in size, even on the same branch. If you have any doubt, sniff. All parts of the tree have a pleasant, medicinal odor.

Although its coarse grain mimics ash or chestnut, sassafras wood weighs less. Dry, it weighs only about 30 lbs. per cubic foot. Wood from older trees has a red-brown color; from

younger ones, a yellow-tan. There's little color difference between heartwood and sapwood.

### Working properties

A soft hardwood, sassafras works easily with only hand tools. Planing, however, requires care so you don't lift the grain. And, you'll find the wood brittle and not very strong, characteristics that demand glue when joining. Fasteners alone won't hold in the wood.

Sanding sassafras poses no problem. It takes a fine finish.

### Uses in woodworking

When not required to bear weight, sassafras blends undetectably with ash in furniture and cabinetry. And due to its likeness to chestnut, the wood often imitates the long-lost classic in antique reproductions. Woodturners and carvers with sharp tools easily work sassafras' unusual grain patterns into eye-catching pieces.

### Cost and availability

The occasional sassafras sold by hardwood lumber outlets costs about \$1.75 per board foot. It rarely will be more than 1" thick and wider than 8". When mixed and sold with ash, it carries a higher price. To be sure what you're buying, scrape or abrade a fresh surface to release the unmistakable odor of sassafras in the wood. Very seldom will you find sassafras sold as plywood or veneer. 🌳

Illustrations: Steve Schindler  
Photograph: Bob Calmer

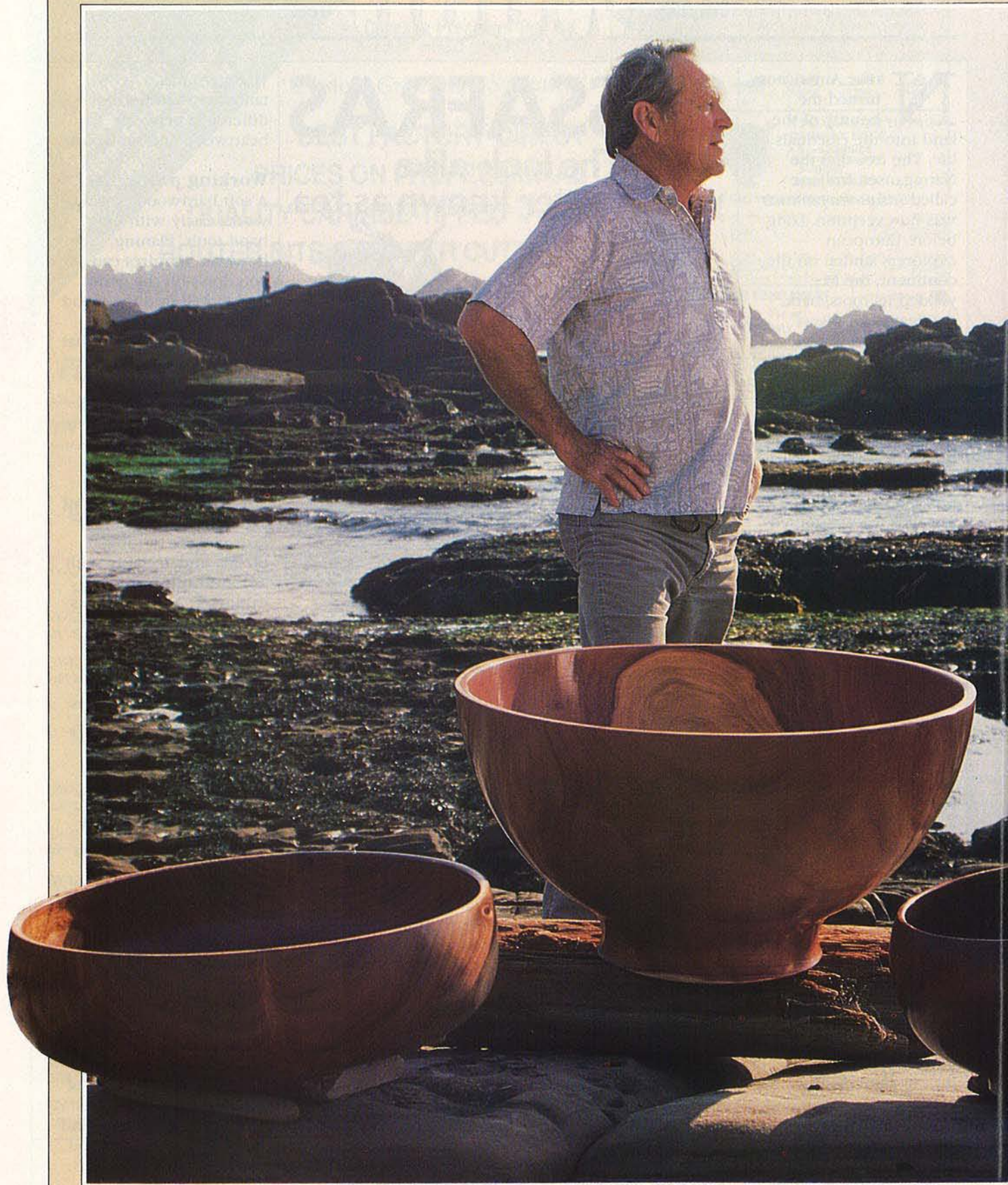

# TURNINGS

## BY THE SEA

With a view of Point Lobos and the Pacific beyond, California turner Neil Weston turns gargantuan bowls on his humongous lathe.

To photo buffs, the Weston name stimulates images of natural forms defined by the effects of changing, controlled light. Edward Weston was a photographer challenged by his environment—seashells strewn with kelp, twisted cypress roots on Point Lobos, endless sand dunes, and even garden-variety green peppers. In the thirties and forties, he recorded such scenes forever on film.

Neil Weston learned photography from his father. But, unlike his brothers, he chose not to pursue it. "I didn't like being couped up inside with chemicals," he remembers. "I was out building boats or sailing them, even as a boy." Boatbuilding actually introduced Neil to woodturning. When he turned all the belaying pins for one of his sailboats, he planted the seed that would sprout years later. As it happened, it wasn't until about eight years ago that Neil seriously began turning.

### SKILLS LEARNED IN PARADISE

A move made in 1981 for family health reasons took Neil and his wife, Ann, from the damp, cool Carmel climate to the big island of Hawaii. There, Neil finished his brother Brett's home, and he and Ann fell in love with the paradise: "We said, 'What the heck!' and decided to live there, too."

So, Neil built another home, where they resided for four years before returning to Carmel.

◀ Named after photographer Edward Weston, Carmel's Weston Beach backdrops Neil and his turnings.

Creativity just comes naturally to 70-year-old Neil Weston. His father, photographer Edward Weston, was at the forefront of the art world in the 1930s. Neil's brothers, Brett and Cole, took up the camera, too, and now have worldwide reputations. Neil's creativity, however, flowed from his hands through wood—first into sailboats he designed and built, then into housing. Now, at an age when most folks settle down to good books and golf at Pebble Beach, Neil pours himself and his talent into turning wood in a big way.



Neil Weston

At his secluded Carmel, California, home Neil turns huge bowls from native stock. He stalks wood along the rugged coast and in the nearby hills, saws it up, and turns it green on one of the most unusual lathes we have ever seen. Neil says he still has a lot to learn, but what he shared impressed us.

When they did, Neil carried a serious bite by the turning bug back to California.

"In Hawaii, I had watched a professional turner a few times and became fascinated. That was enough to make me want to get into it," Neil says. "But, I had to teach myself how to turn—and did—with the help of Dale Nish's books. I started with big bowls right off."

Neil makes no apologies for relying on a roundnose chisel for most of his finish-turning. "A shearing-type gouge is real tricky to use without any instruction, so I just got into scraping. I should use a shearing tool to smooth the wood more, but it's hard to teach an old dog new tricks," he says. "I do use a gouge, though, to rough out the bowl. When it gets down to the final finish, I find it more comfortable to scrape—with a light touch!"

In Hawaii, Neil learned more than how to use a lathe. He discovered how to buy wood for a pittance, turn it green, and dry it rough-turned.

Even now, past Hawaiian bargains represented by stacks of sealed, rough-turned bowls load up several shelves in his workshop. "That's *jenisero*," Neil explains. "It's a South American hardwood that naturalized in Hawaii. There, it grows into huge trees. I bought a whole pickup load of it from a wood wrecker—that's someone who removes trees—for \$5 a chunk. What a deal that was! It's all dated 1982, when I rough-turned it. Because we lived in a desert area, I painted the bowls with latex paint to slow down the drying time."

Continued

# TURNINGS BY THE SEA

In addition to the jenisero, Neil brought back 200 rough-turned koa bowls and an entire koa log.

Now Neil focuses on local hardwoods. "Mark, my son, is in tree removal," Neil explains. "He's alerted others in the wood-removal business here to keep their eyes open for trees that would make likely turning prospects for me, such as large-diameter, solid wood."

## MYRTLE, REDWOOD, AND ROQUEFORT CHEESE

Neil focuses on acacia, alder, bay laurel (myrtle), English and black walnut, and redwood. Plus, he trades some wood with other turners around the country.

Frequently, Neil goes right to a job site where his son has dropped a tree for a firsthand look at the wood. If he salvages it, the log ends up next to his workshop. "The sooner you can get a chunk of the tree on the lathe after it's cut down, the better," Neil says. "Otherwise, it starts to shrink as it dries out. But, I can't always do that. To protect the log—to keep it from cracking, checking, and drying—I put it in the shade, coat the ends with paint, and cover it with sheets of plywood until I can get to it. Never cover a log with clear plastic. It will burn out."

Local alder ranks among Neil's favorite turning woods. There's a handy supply, and he's learned to enhance the appearance. "I harvest alder in a canyon about six miles down the coast. And with some time and effort, I get it to spalt," he says. "It's like making Roquefort cheese."

Neil starts with a live tree ("I've found that a dead tree won't spalt") that he drops and cuts into logs 3' to 4' long. Instead of sealing the ends, he leaves them open so plenty of moisture enters the wood. "The fungus gets in, too, and it starts to go! I even take shavings from pieces of spalted

wood and sprinkle them on the logs. It's like infecting them," he says. "I set the logs on the north side of my shop, spray water on them occasionally to keep them relatively green, and in six months to a year, I've got spalted alder."

## MEET J. B. HUMONGOUS

When Neil got serious about bowl turning, he went at it in a big way. His outboard lathe, named "J. B. Humongous" after its builder, Jerry Blanchard, and its size, has an 8' swing with the toolrest removed.

Powered by a 2-hp., 220-volt motor meshed with two side-by-side automotive transmissions, Humongous provides Neil with 13 speeds from 33 rpm to 856 rpm, plus a slow speed—actually a reverse—for final sanding. It's bolted to the concrete floor for less vibration, and

Neil and his son, Mark, check out ►  
downed redwood logs that could end up as bowls in a gallery.



▲ A block and tackle is a standard tool when 150-pound bowl blanks aren't uncommon around the shop.

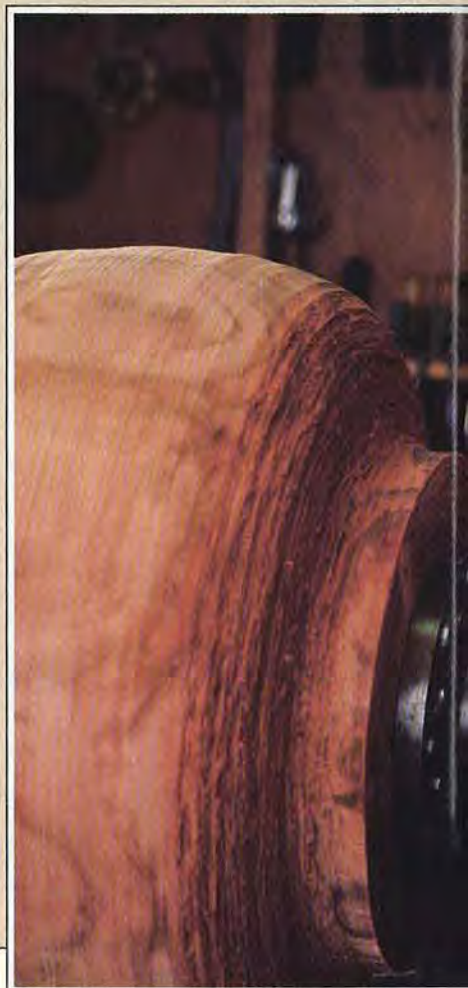

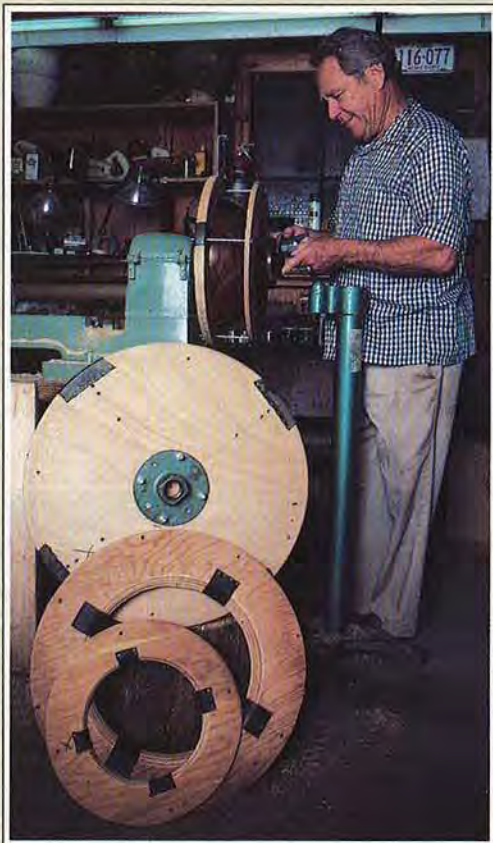

## THE FINAL FINISH

After final shaping of the bowl some six months later, Neil sands the work while it's still mounted to the faceplate. Next, he applies a slow-dry epoxy. After curing overnight, the bowl can be rubbed with 0000 steel wool to remove the high gloss. A buffing with flannel readies the work for the last bit of turning to craft the bottom rim. Neil likes to think of the distinctive addition as his personal signature.

"I read an article about how this turner shaped the bottom of his bowls," explains Neil. "It fired me up to try something like it myself." Neil tried, then perfected, the technique that gives his bowls a double-duty, liplike base. Creating the base ridges the bottom of the faceplate screw holes, and attractively

raises the bowl from any display surface. "If you finish the rest of the bowl first," Neil adds, "all you have to do is turn the bottom, finish that part, and you're done. It's great!"

Neil turns the base of the unfinished bowl with the help of a two-piece jig, photo *above*. He first chucks the 1½" thick, circular plywood mounting plate (one of three in various diameters for different-size bowls) into the headstock. Then, Neil centers the bowl, base out, on the plate and fits it with a collet of ¾" plywood.

To make sure he doesn't burst through the bowl bottom with his turning tool, Neil notes the bowl's inside depth so he knows exactly how deep to shape the recess in the base. After shaping the recess and base lip, and some sanding, Neil finishes the bottom to match.

For a final touch, Neil glues a personalized silver medallion to the base of his bowls. The motif reflects his past and present—a ship's anchor encircled by the words "Weston, Hawaii and Carmel." 🍵

Written by Peter J. Stephano  
Photographs: Jim Elder



▲ A base and collet of plywood hold the inverted, finished bowl for the final turning of the recessed, lip-shaped bowl base that marks Neil's work.

◀ The lathe's 8' swing hasn't been tested as yet, but Neil has turned bowls 28" in diameter. He can choose from 13 forward speeds and a reverse.

angled so that a fan blows turning dust right out the door.

"That lathe can swing really big stuff because it's built sturdy and geared low enough to handle it, but so far I've only turned a bowl about 28" in diameter," Neil points out. "That chunk of wood, though, weighed 500 pounds, and I had to use a block and tackle to hoist it up and get it mounted."

Once Neil mounts a block on his Humongous, he turns it down to a wall thickness of ½" to 1½", depending on the size of the bowl. Then, he sets it aside to dry for six months or so after marking its rough-turned circumference. The notation helps him keep track of different woods' stability. Depending on the species, some wood will dry out of round by as much as ¼", others only ⅛".

# CRAFTSMANSHIP BY THE CARLOAD

THOMASVILLE INDUSTRIES TURNS OUT \$1 MILLION  
IN HIGH-QUALITY FURNITURE EVERY DAY



**I**n the town square at Thomasville, North Carolina stands a 30'-high Duncan Phyfe-style chair. In bustling Thomasville, chairs are big. So are tables, bedroom sets, china hutches, and other distinctive furniture pieces. Every working day, more than \$1 million worth of furniture rolls off the assembly lines of Thomasville Furniture Industries.

What do a modern-day furniture plant and a home woodworker's shop have in common? Recently we visited Thomasville for a couple of days to find out.

We discovered that Thomasville's plants aren't as highly automated as we expected. There are conveyor belts and mega-machines, to be sure, but here, crafting furniture—from grading veneers to rubbing out remains a hands-on operation. The company's 6,000-plus employees take pride in a tradition of craftsmanship that goes back to 1904 when the original Thomasville Chair Company was founded.

## FURNITURE IS FASHION

One reason why Thomasville has no intention of turning its plants over to robots and computers lies

with the volatile furniture industry. For a week each spring and fall, retailers flock to Thomasville and nearby High Point to check out the latest styles and place orders for the furniture you'll eventually see in stores. One season Queen Anne might be a hot seller; buyers could bet heavily on country contemporary six months later. "Ours is very much a fashion-oriented business," observes Thomasville president Frederick B. Starr. "To keep up with changes in home fashion, we introduce about 100 pieces each year, and then adjust production as orders come in."





*Far left:* A Thomasville Furniture craftsman carefully carves a new chair-leg pattern from mahogany stock. When the pattern meets approval, a metal cast will be made for the factory.

*Left:* The routers on this machine simultaneously duplicate 24 table legs.

devours about a million board feet of lumber and 2.5 million feet of veneer each week.

### PEOPLE POWER

In 1987, Thomasville invested more than \$10 million in new equipment. The materials budget—primarily veneer and hardwood—soars even higher. The annual sandpaper budget alone adds up to a whopping \$2.5 million. But materials and machinery tell only part of the story. “Our greatest assets,” says president Starr, “are our workers. People at Thomasville do their jobs right the first time.”

Lots of men and women join the company just after completing high school and remain until they retire 45 or more years later. Why? Part of the answer lies with the quality of everyday life in North Carolina’s hills and hollows. The winters are mild, the hunting good, and the fishing even better. With a job or jobs at Thomasville Furniture, a family can also farm a few acres and remain close to the land.

But on-the-job satisfaction means a lot, too, as any home woodworker could guess. At Thomasville the number of pieces produced are big, but workers know that their skilled craftsmanship still counts more.

### CARVINGS BEGIN WITH A MASTER CARVER

We’ve often wondered how chair or table legs can look so highly detailed, yet each matches perfectly with its mate. We found the answer to this question in Thomasville’s Service Plant E. This plant supplies millions of carved bedposts, table and chair legs, headboards and more to the production plants. Here, one of the master carvers—who has been carving since he was four years old—painstakingly hand-tools a mahogany bedpost that will serve as a pattern for multiple-spindle carving machines similar to the one shown *above*. In the factory,

A new line of furniture begins in the design department with thumbnail sketches, renderings, and working drawings. Finally, Thomasville craftsmen handcraft a prototype. At this point, the piece is one of a kind, much like a project from any woodworker’s shop.

But from then on, the prototype runs a gauntlet no amateur design has to endure. First, it goes to product engineering, where costs, dimensions, and joinery are carefully analyzed. Next, the prototype moves to a tough workout in the Physical and Chemical Testing Laboratory. One machine simulates a

200-pound man rocking the piece 10,000 times to ensure sound joinery. Another machine subjects the prototype to extremes of temperature and humidity.

Finally, after a new design passes all its tests, it’s assigned to one of Thomasville’s 11 production plants sprinkled throughout hilly northern North Carolina and southern Virginia. Ten additional service plants feed the production plants with lumber, veneer, carvings, and other components.

As you might imagine, 11 production plants create a tremendous appetite for materials. Thomasville



At his bench, a Thomasville master carver adds detail to a bed post.

routers arranged in pantograph-fashion can simultaneously carve 24 table legs, for example.

### VENEER BY THE MILE

Veneer salesmen, familiar faces among the area furniture companies, travel the highways pulling trailers of veneer samples behind their cars. On the day we visited, a salesman laid out a forest of samples—one veneered log at a time—for Thomasville buyers at plant V. In less than an hour, the buyers purchased dozens of trees after examining three veneer samples from each log—a slice from the top of the log, one from the middle, and another from the bottom. Later, the salesman packed up the rejects to peddle to other furniture factories.

Thomasville primarily purchases  $\frac{1}{28}$ "-thick sliced veneer. Other species include pecan, hickory, cherry, oak, Carpathian elm burl, and olive ash burl. Workers processed more than 100 million surface feet of veneer last year.

To maintain an 8–10 percent moisture content, veneer flitches, as the sliced logs are called, go into storage areas where the temperature remains between 72 and 78 degrees Fahrenheit and the relative humidity at 35 percent.

Workers with trained eyes and skilled hands then match the flitches and pressure-tape them together into panels used to surface table tops, cabinets, headboards, and other case goods.

How do a furniture- and your home-production shop compare? Plenty of ways. Both place a premium on the quality of the finished product. And neither shop would undertake a shortcut that could lead to anything less than the finest possible piece of furniture.



Assembling an intricate veneer pattern can require up to 80 separate steps.

## THE BIRTH OF

Plant C, Thomasville's largest facility, produces more than 800 chairs during every eight-hour shift. To show you how they do it, we followed a Queen Anne chair, *below*, along the assembly line.

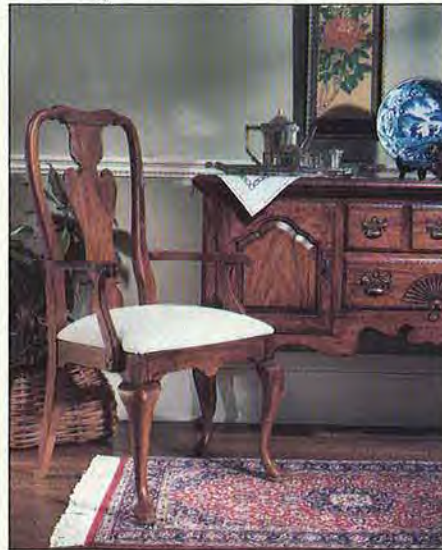

Doweling takes a two-step operation. One machine drills the holes, and another, shown *below*, injects glue into the holes and drives the dowels. The doweling occurs almost as fast as the operator can position the pieces. Later, these pieces will tie together the back posts at seat level.



# A CHAIR IN CHAIR CITY



Our chair begins at a series of band saws, where workers cut some of its various components from rough stock. Here, Angela Miller saws chair back posts on a machine that has a 48-inch throat. A pattern jig ensures that each piece will be identical.



Pecan chair legs, enough to seat a state dinner, roll down the production line to a team of workers who form round-overs on a double-spindle shaper. After shaping the leg, the parts are stacked onto a cart and wheeled to the sanding area.



Now, the chair-back posts get a good sanding. This brush sander uses 120-grit  $\frac{1}{4}$ "-thick scored cloth sandpaper. Fingerless gloves and fingertip caps protect workers' hands and still allow the operators to get a good feel for the job they're doing.

Finally, our chair begins to look like a Queen Anne chair. One worker hand-assembles the back components, which will then be clamped in the machine to her right. Workers in the background immediately scrape off the excess glue, and apply filler where necessary to the joints.



More hand assembly completes the Thomasville chair frame. This pneumatically powered machine can clamp 100 chairs an hour. After assembling each frame, the chair gets a ride on an overhead conveyer until the glue dries. Then, an inspector rigorously tests all the chair joints.



To ensure a uniformly colored chair, workers carefully match wood tones of all Thomasville furniture. First, an equalizing stain lightens the dark wood. Next, a sap stain darkens the light wood. After workers spray on a final stain coat, they seal the chairs with lacquer. 🌲

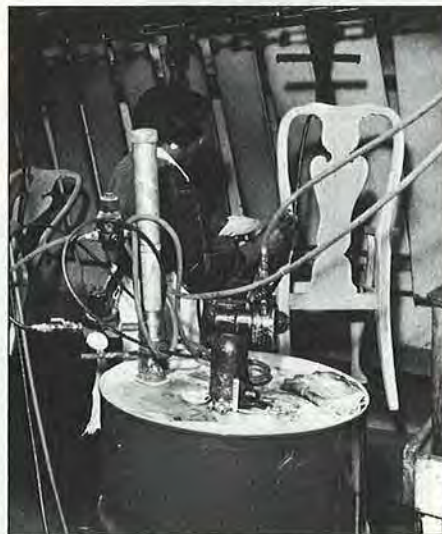

Written by Jim Hufnagel with Marlen Kemmet; photographs by Richard Hagerty

PICTURE THIS  
**YOU CAN FRAME  
LIKE A PRO**

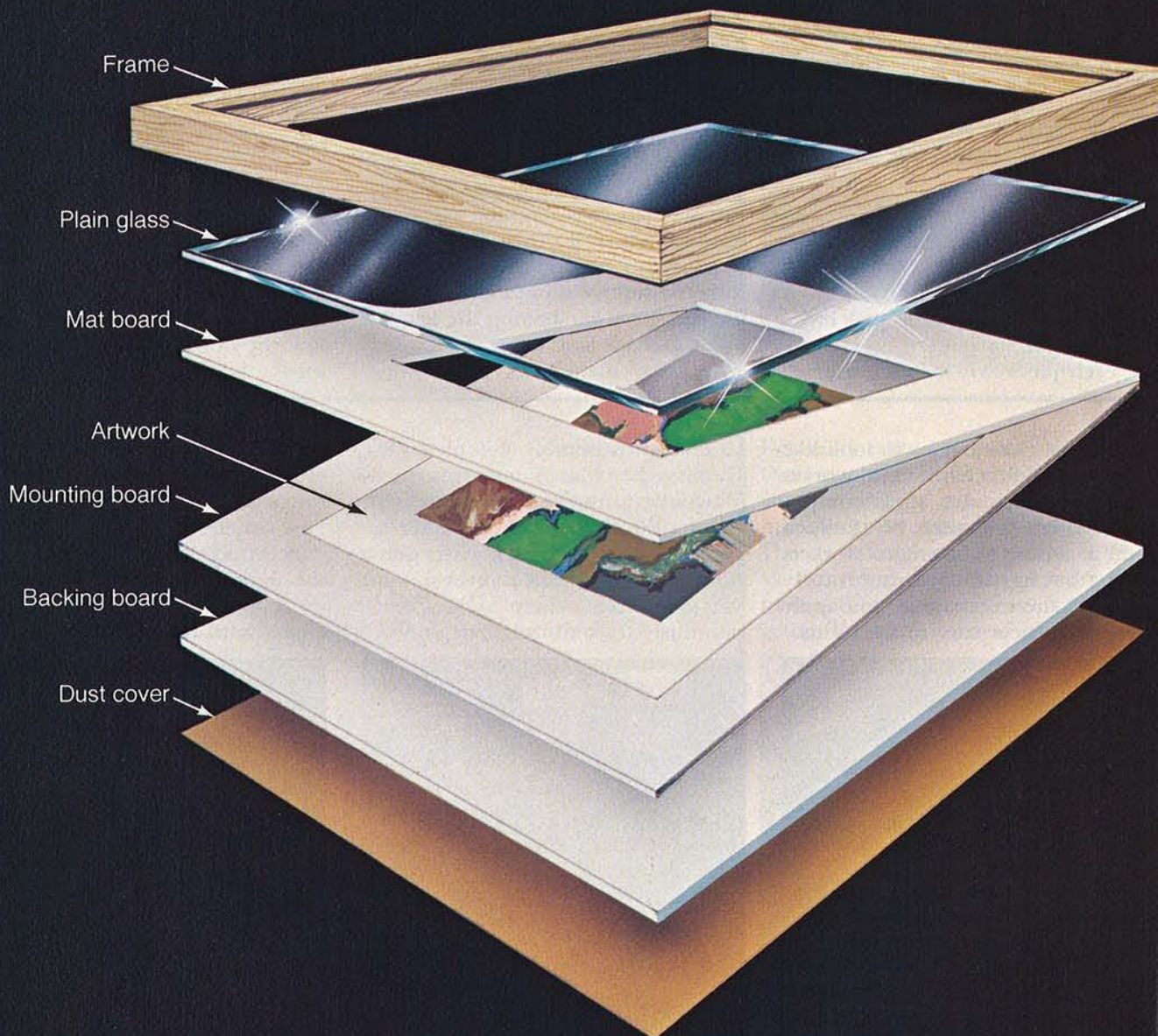

It's one thing to be able to accurately cut and join four pieces of wood into an attractive-looking frame. But preparing artwork for framing (and for posterity)—now that's another story. Read on and you'll learn the ins and outs of how to correctly mount photos, posters, needlework, and other types of artwork. It's not nearly as difficult as you might have imagined, and surprisingly, requires only a small investment in equipment.

**W**e don't have any resident framing experts on the *WOOD*® magazine staff, so for this article, we turned to a couple of professional framers for a helping hand.

Marlene Olson, owner of Olson-Larsen Galleries in Des Moines, has done framing for museums and individuals for more than nine years. She has a genuine interest in spreading the word about good framing procedure because, she says, "A lot of the pieces that come into our gallery for framing have been damaged by improper mounting."

Glenda Shaw, our other consultant, has framed hundreds of needlework projects for Dot's Frame Shop, also in Des Moines.

We spent some time watching these two ladies perform their feats—asking questions all the while—and we now have a better handle on this subject ourselves. First we'll go through mounting works of art on paper, then we'll show you how to mount needlework. Professional framers mount artwork first, then fit a frame to the mounted piece, so we'll look at frame dimensions last (see page 47).

## HERE'S WHAT YOU'LL NEED



### THE BASICS

No matter what your skill level, or the type of mounting project, you'll need these tools to do the job correctly: (1) metal straightedge with nonskid backing for guiding a mat cutter; (2) ruler; (3) mat cutter for making beveled and straight cuts; (4) glue stick for attaching the frame's dust cover; (5) kraft paper for a dust cover; (6) ¼" foam-core stock for making a rigid backing board; (7) rag board (acid-free mounting board) to make a mat and form an acid barrier; (8) adjustable-jaw pliers for squeezing brads into the frame; (9) picture-hanging wire; (10) rubber bump-

ers for cushion between the frame and wall; (11) ¼" screw eyes (¾" long) for fastening the picture-hanging wire to the frame; and (12) ⅝"×#18 brads for securing the picture package in the frame.

### ARTWORK EXTRAS

If you're working on a poster, photo, or other art on paper, you'll need: (13) linen tape for fastening the art, mat, and mounting boards together; (14) distilled water for wetting the linen tape; (15) marking gauge and pencil for drawing cutting lines; (16) dusting brush for keeping the workpiece clean; (17) 1" brush for applying distilled

water; and (18) burnishing bone for smoothing beveled edges.

### NEEDLEPOINT EXTRAS

And for needlework, get hold of (19) pushpins to stretch and temporarily attach the needlework to the backing board; (20) quilt batting to back the needlework and give it a three-dimensional look; (21) stapler for attaching the needlework; and (22) scissors for cutting the quilt batting.

You may already have many of these supplies. The mat cutter we use costs about \$15; a small roll of linen tape, about \$4. See the Buying Guide on page 47.

*Continued*

# FRAME LIKE A PRO



## HOW TO MOUNT PHOTOS, POSTERS, AND

To help in explaining the mounting process for all so-called works of art on paper, we selected the acrylic painting shown here. The painted area measures 6×6", and it's centered on a 9×9" piece of paper. The sizes we refer to from time to time apply to this particular painting, but the process will be the same no matter what paper project you're working on—just use your own dimensions.

### SIZING THE PICTURE PACKAGE

(Note: The picture package includes a backing board, mounting board, artwork, and mat board.)

Start by measuring the dimensions of the image area of your project. As stated above, ours measures 6×6". And since we wanted to include the artist's signature, we left a ¼" border around the painted area. As you can see by studying the illustration at right, this means that we will need to cut a 6½×6½" mat opening to frame our painting.

With this one dimension fixed, you now can determine the outside dimensions of the mat, mounting board, and backing board. Follow Marlene's advice and figure on a 3" border at the top and sides of the mat opening and 3½" at the bottom. "A 3" border is pretty standard, that is unless you're dealing with art that's either very small or very large. Make the bottom border 3½" to prevent the artwork from sinking," Olson advises. "Sinking" refers to the illusion of matted artwork appearing lower in a frame than it actually is.

Next, transfer these outside measurements to two pieces of rag board (one each for the mounting board and the mat board) and one

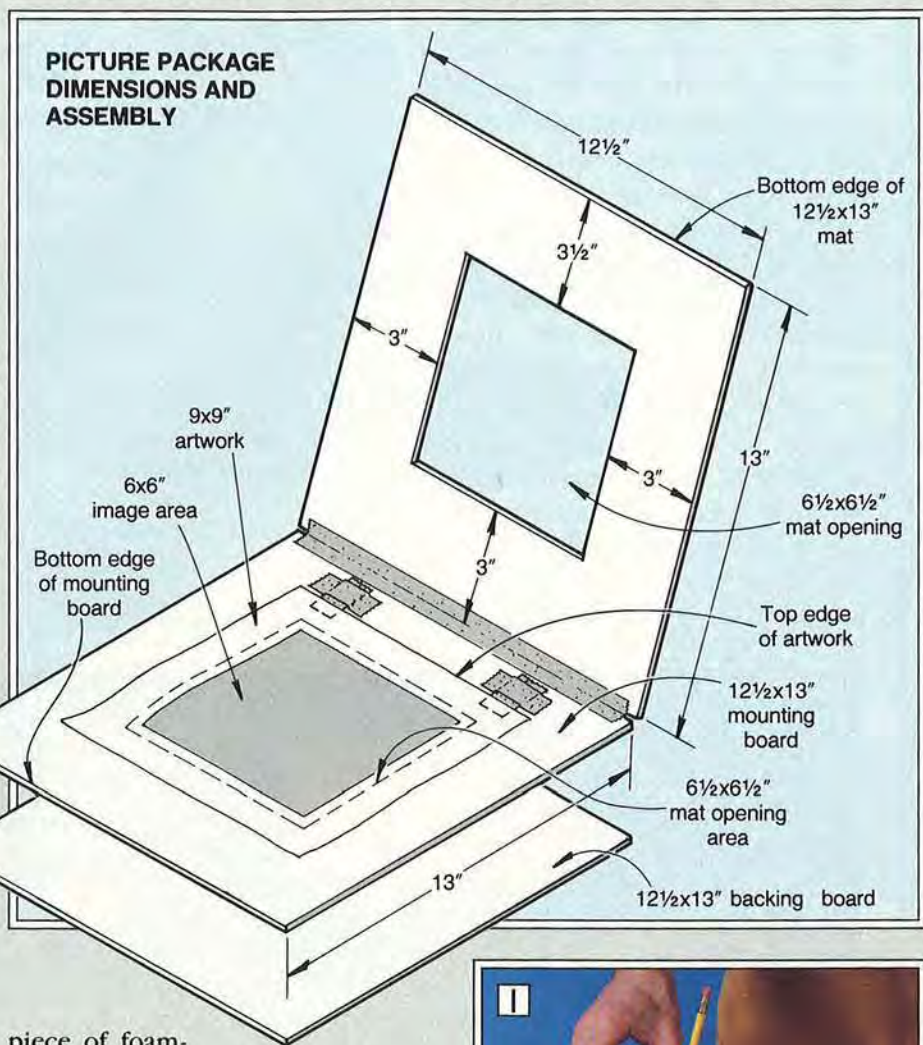

piece of foam-core stock (for the backing board). Using a mat cutter set for a straight (not beveled) cut, and a straightedge, cut all three boards to size.

And finally, to prepare the mat opening for cutting, lay the mat board front side down on a clean work surface. Then, set your marking gauge and outline the opening with faint pencil marks, as shown in photo 1.

### HOW TO CUT THE MAT OPENING

Learning to use a mat cutter takes a little time, so start by reading the instructions that come with the

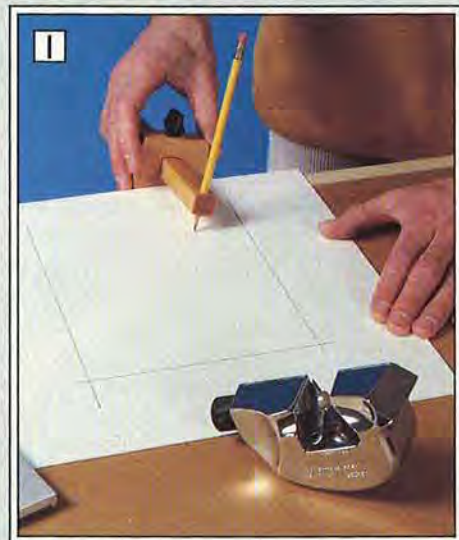

▲ A marking gauge helps pencil the mat opening (for photo purposes, we darkened the lines—faint lines work best).

# OTHER ARTWORK

tool. Then, make several practice cuts on scrap mat stock.

Now, with your thumb and the point of the blade facing the outside of the mat (see photo 2), begin the cut about 1/8" beyond the end of the intersecting lines. (Starting the angled blade beyond the corner on the back side of the mat makes the cut complete on the face side.) Next, line up your straightedge so the mat cutter follows the penciled line, and push the cutter 1/8" beyond the next intersecting line. Rotate the mat board 90°

counterclockwise, and repeat until you've cut all four sides.

After cutting, erase the pencil lines. Otherwise, they could transfer to the artwork.

## POSITIONING AND SECURING THE ART

To "hinge" the mat board to the mounting board, lay both boards down (mat board front side down, mounting board front side up), with their top edges touching and flush at the ends. Then, cut a piece of linen tape about the width of the

boards, wet its gummed surface with distilled water, and center the tape on the joint.

Now, lay your artwork in the center of the mounting board, and hold the mat just above the artwork with one hand. With your other hand, position the art so the desired image shows through the mat opening. Open and close the mat until you're satisfied with the positioning. Then, place a protective scrap piece of rag board on the image, and place a weight on the scrap to hold the image in position.

To attach the artwork to the mounting board, follow the process in the illustration at *left*. Wet the tape lightly—don't soak it.

If you have a glass-cutting tool, cut a piece of single-strength glass to the same dimensions as the backing board. Or, have the people at your local hardware store or glass shop cut the glass for you. Clean the glass with a mild water-vinegar solution.

Assemble the picture package by laying down the backing board and stacking on the mat assembly next. At this point, check the overall appearance of the mat. Brush away any dust or lint on the mat, then lay the glass on top. Place the frame over the package as shown in photo 3 at *left*.

Slide the package halfway over the work surface edge, hold the package together, and turn it over. To secure the package, squeeze brads in with an adjustable pliers, spacing them 3" apart and coming within 1" of the corners (see photo 4 for how to do this). Be careful not to drive the brads completely through the frame.

To make the dustcover, professional framers use brown kraft paper (grocery-bag-type paper), but any sheet of strong paper will work. Run a glue stick along the back edge of the frame, and apply the dustcover as shown in photo 5.



▲ With the straightedge held down firmly, push the mat cutter alongside it to cut the mat opening.

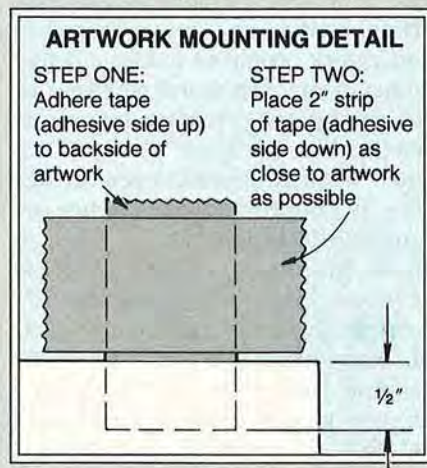

▲ Place the frame over the picture package as shown. Now, check for any lint or dust trapped under the glass.



▲ Apply an oversized dustcover to the frame's back, and trim to size with a razor blade or an X-acto knife.

◀ An adjustable pliers with its jaw padded with masking tape makes a great brad driver.

*Continued*

# FRAME LIKE A PRO



## MOUNTING NEEDLEWORK: A FEW POINTERS

Needlework projects present a different set of challenges to novice and professional framers alike. Glenda Shaw, our needlework consultant, said, "About 90 percent of the needlework I do is mounted with a quilt batting." Although some people mount needlework flat, we'll go through the more-popular method.

### PREPARING THE NEEDLEWORK PACKAGE

The section-view shown *below* depicts the parts of the needlework package. Note that you have a foam-core backing board topped by a mounting board, with a layer of quilt batting on top of that. The needlework rests on this cushion and attaches to the backing board. The batting serves two purposes. It gives the needlework a three-dimensional look and also helps disguise any lumps from large stitchery knots.

Once you have completed your needlework project, measure the dimensions of the image area, and decide how far you want its borders to be from the frame. You'll need at least 1" of fabric to wrap around the backing board and to attach the project.

Because this process doesn't require matting, cut the backing and mounting boards to the same size as the image area. See page 44 to find out how we cut these boards.

Use a glue stick to attach the white mounting board to the foam-core backing board. Avoid using colored rag board that may reflect through the batting and the needlework. In addition, mounting board blocks acid; see the tip on page 47

about the importance of blocking the travel of acid.

Now, cut a piece of quilt batting (available from fabric stores) to a size slightly larger than the two boards you just cut, and attach it to the mounting board with a glue stick. With scissors, cut a beveled 45° edge around the batting. The bevel allows the needlework piece to smoothly taper into the frame.

### STRETCHING THE NEEDLEWORK

Lay down the assembled package, batting facing up, and center the needlework on top of it. Use a ruler to check for even borders. Place a few pushpins into the backing board's corners (see photo 1 at *right*). You can precisely center the piece by counting fabric stitches or "squares," if desired.

Now, place pins into the edges of the foam-core board about ½" apart, gently stretching the fabric as you move around the piece in any direction (see photo 2). Don't distort the image by overstretching. Feel free to restretch the needlework during this stage; even pros remove and replace pins often.

### SECURING THE NEEDLEWORK

Next, flip the needlework over and staple it to the backing board. As shown in photo 3, putting the staples in at an angle will provide greater hold. We chose ¼" staples because larger sizes may penetrate the needlework.

You can now remove the pushpins, place the package in its frame, and assemble as we did for the artwork package on page 45.

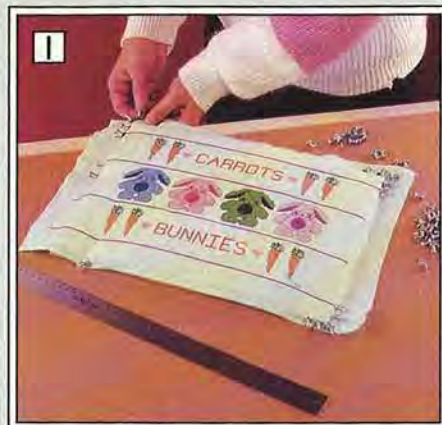

▲ We readjusted our corner pushpins to precisely center the piece.



▲ You'll do most of the stretching as you pin the last two edges.



▲ During stapling, pull the corners tight. Otherwise, the needlework package may not fit into the frame.

### NEEDLEWORK SECTION VIEW

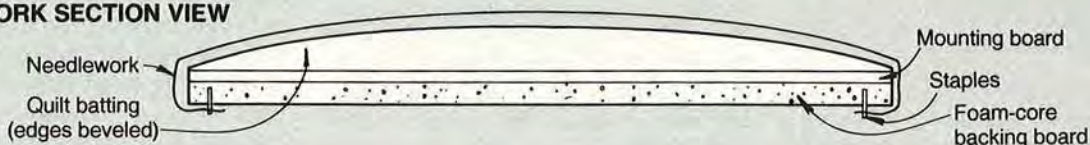

Produced with Marlene Olson and Glenda Shaw



# FITTING AND HANGING THE FRAME

With the artwork package completed, now you finally can get to use your woodworking skills. To determine the amount of frame stock you'll need, and where to cut the miters, first figure the rabbet opening by adding  $\frac{1}{8}$ " to each of the picture package dimensions (so the package fits comfortably). The drawing *below* shows this graphically. The  $12\frac{1}{2} \times 13$ " picture package from our first example requires a  $12\frac{5}{8} \times 13\frac{1}{8}$ " opening.

## FRAME AND RABBIT DIMENSIONS (BACKSIDE SHOWN)

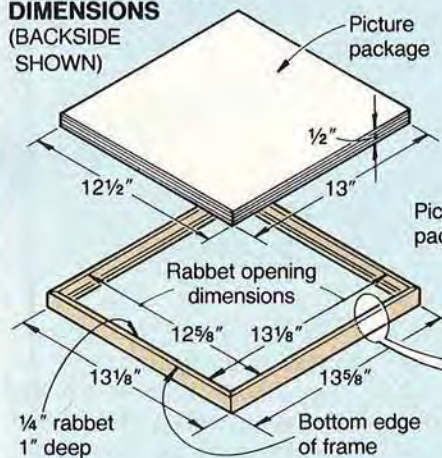

Then, measure the width of your frame material less the rabbet (see section view *below*). In our case, this equals  $\frac{1}{4}$ " ( $\frac{1}{2}$ " -  $\frac{1}{4}$ "). Now, multiply that number times 2 ( $\frac{1}{4}$ "  $\times$  2 =  $\frac{1}{2}$ "). Add that amount to the rabbet opening dimensions— $12\frac{5}{8}$ " +  $\frac{1}{2}$ " =  $13\frac{1}{8}$ " and  $13\frac{1}{8}$ " +  $\frac{1}{2}$ " =  $13\frac{5}{8}$ "—to calculate the outside dimensions of your frame.

## PUTTING YOUR PROJECT ON THE WALL

With the frame package together, drill pilot holes for the screw eyes (see illustration *below, right*, for positioning). Twist them in by hand, or gain added leverage by putting the point of an awl through the eye and then turning.

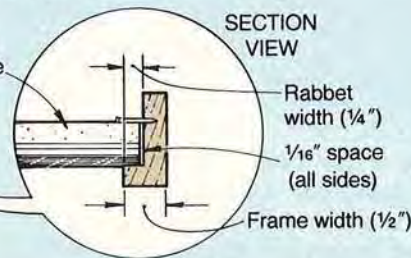

Fasten the hanging wire by looping it twice through the eyes, then twisting it back around itself. Wrap the loose wire ends with masking tape. Attach self-adhesive rubber bumpers to the bottom of the frame. Finally, use picture-hanging hooks rated for the weight of your frame to secure it to a wall.

Your tastes dictate where to you hang pictures, but follow these tips:

- Don't let direct sunlight hit the frame. Strong light fades pigments in the artwork and mat boards, and may even cause condensation on the inside glass surface.
- Avoid placing the artwork above a heater, cold air return, or fireplace, where it may dry out.

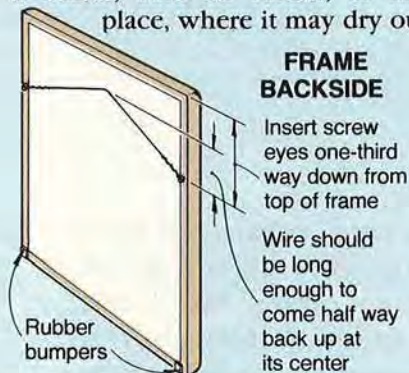

## FRAME BACKSIDE

Insert screw eyes one-third way down from top of frame  
Wire should be long enough to come half way back up at its center  
Rubber bumpers

# TIPS FROM OUR FRAMING EXPERTS

## 1 WORK CLEAN

Place a cardboard sheet over your work surface to keep it clear of anything that could soil or scratch your workpiece. The cardboard also will prevent your mat cutter from slicing into the workbench. Wash your hands to keep skin oil off the artwork and mat.

## 2 USE A THICK STRAIGHTEDGE

Mat cutters can jump over a yardstick or similar thin edge (less than  $\frac{1}{4}$ " thick), possibly causing injury. The straightedge should have a nonskid backing. If you have difficulty keeping the straightedge in position during long cuts, clamp it to the work surface.

## 3 ACCEPT NOTHING LESS THAN ACID-FREE

You may have never heard of acid-free rag board, but any framer worth his or her salt uses only acid-free materials for anything in contact with artwork. If given the chance, acid will contaminate adjoining materials, causing weakening and discoloration of fibers. Cardboard and kraft paper contain high amounts of acids, but can be used in the mounting process if separated from the artwork by an acid-free barrier, such as rag board.

You can purchase white acid-free rag board from most art stores. Buy multicolored acid-free rag board and linen tape from the Buying Guide source at *right*.

## 4 GIVE THE ARTWORK SOME SPACE

Like you, artwork needs space. Never place it directly against glass; doing so will promote mildew growth. Beyond aesthetic reasons, a mat serves as a spacer between the artwork and glass. If you don't use a mat, hide a  $\frac{1}{8}$ "-thick spacer behind the rabbet and between the artwork and glass.

## BUYING GUIDE

For a complete catalog of framing supplies, including all the materials used in this article, contact:

Light Impressions  
439 Monroe Avenue  
Rochester, NY 14607-3717  
716/271-8990

Written by Bill Krier

Photographs: Hopkins Associates; Bob Calmer

Illustrations: Bill Zaun; Advertising Art Studios, Inc.

# HOMEMADE OVAL MARKER

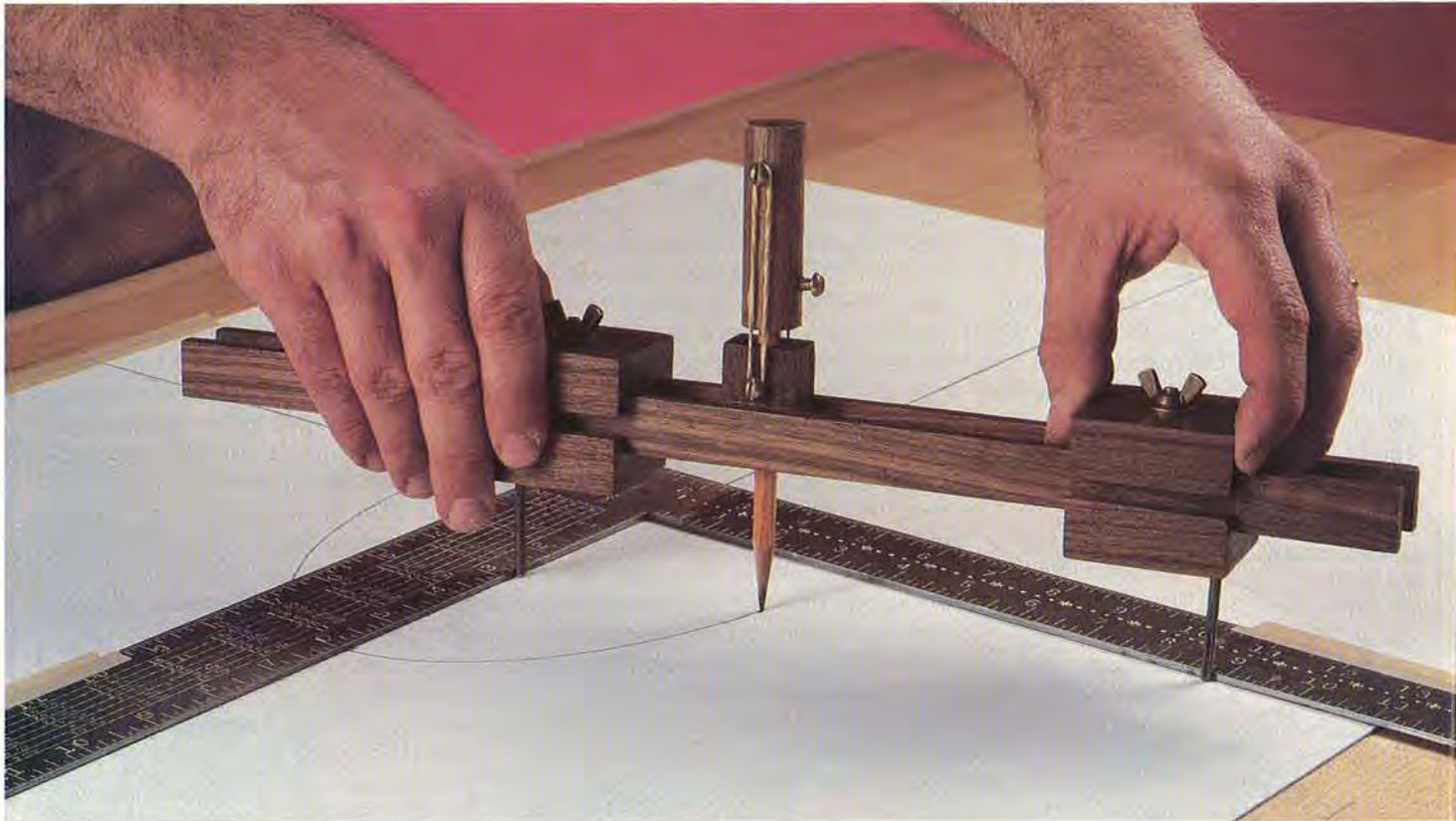

When Don Polson of Albia, Iowa, stopped by the *WOOD* magazine offices for a tour not long ago, he brought with him one of his favorite homemade tools—an oval marker. Don uses the device for marking mat board and laying out picture frames with oval cut-outs. We think you'll enjoy giving Don's ingenious tool a workout in your own shop.

*Note: For more information about picture framing, see our techniques article beginning on page 42.*

## FORM THE SLIDING BLOCKS

**1** Cut a piece of  $\frac{3}{4}$ "-thick walnut to  $1\frac{3}{4}$ " wide by 10" long. Later, you'll crosscut the strip into four sections for the sliding blocks (A).

**2** Mark the groove locations on one end of the walnut strip where shown on the Sliding Block Drawing. Cut or rout a pair of  $\frac{1}{4}$ " grooves  $\frac{1}{4}$ " deep along the bottom

face of the strip. (We cut ours on the table saw using a dado blade.)

**3** Crosscut four pieces, each 2" long, from the 10" strip. Using the dimensions on the Sliding Block Drawing, mark the center points, and drill holes in each block.

## NOW, CUT THE REST OF THE PIECES

**1** Cut a piece of  $\frac{3}{4}$ "-thick walnut to  $2 \times 16$ ". Position the rip fence  $\frac{7}{32}$ " away from the inside edge of the table saw blade, and rip a beam (B) to  $\frac{7}{32}$ " wide. Check that the beam slides easily in the  $\frac{1}{4}$ " grooves in the sliding block; reset the saw fence if necessary. Then, cut the second beam to width.

**2** Cut the pencil holder (C) to size. Mark the center point on the top end, and drill a  $\frac{5}{16}$ " hole through the piece. Now, mark the locations, and drill the  $\frac{5}{32}$ " holes for the pair of roundhead machine screws.

**3** Cut a piece of  $\frac{3}{4}$ " dowel  $2\frac{1}{2}$ " long for the pencil tensioner (D).

**4** Clamp a long piece of scrap stock to your drill press table, and drill a  $\frac{3}{4}$ " hole  $\frac{1}{2}$ " deep into it. Switch to a

$\frac{5}{16}$ " bit, and stick the  $2\frac{1}{2}$ "-long dowel in the hole in the scrap. Holding the dowel with a small handscrew clamp, drill a  $\frac{5}{16}$ " hole centered and through the dowel.

**5** Hold the pencil tensioner (D) in a handscrew clamp, and then drill the  $\frac{5}{32}$ " holes where shown on the Exploded-View Drawing.

**6** Sand all the walnut pieces.

**7** Cut off the heads of two #8 common nails, so the nails are the same length. Sand a round-over on each clipped end. With the rounded end protruding, epoxy one nail into each block (see the Sliding Block Drawing for reference). The length of the nail protruding from each block should be equal.

## ASSEMBLE THE MARKER

**1** Join two of the sliding block parts (A) with a  $\frac{3}{16} \times 2$ " flathead brass machine screw, flat washer, and wing nut. Repeat for the second sliding-block assembly. Position a sliding block on each end of the pair of beams.

**2** With the bottom edges of the beams and holder flush, glue and

# A SIMPLE TOOL THAT SIMPLIFIES A DIFFICULT TASK

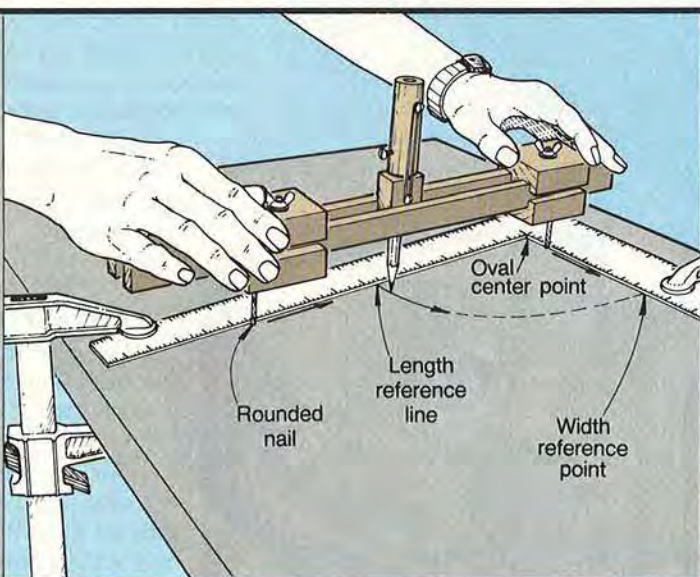
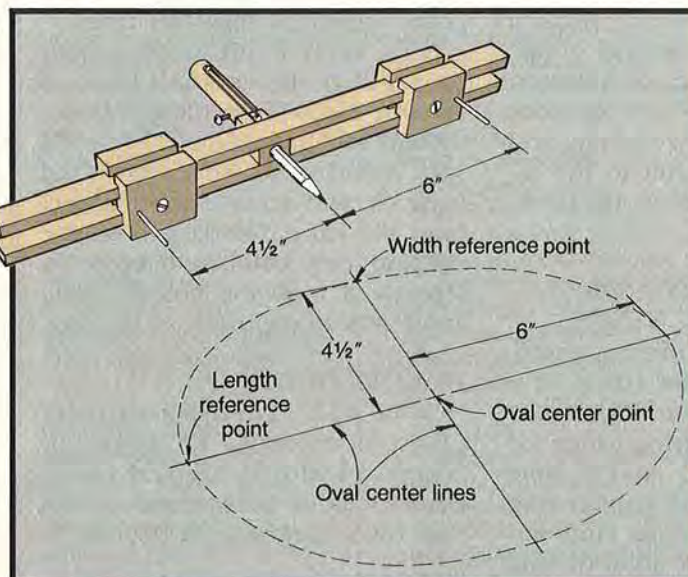
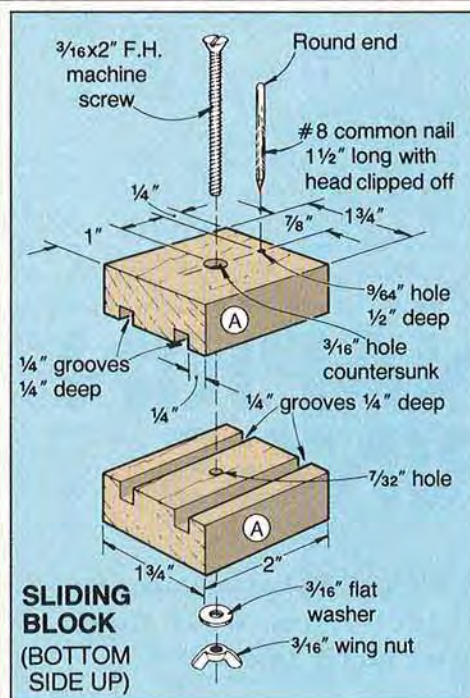
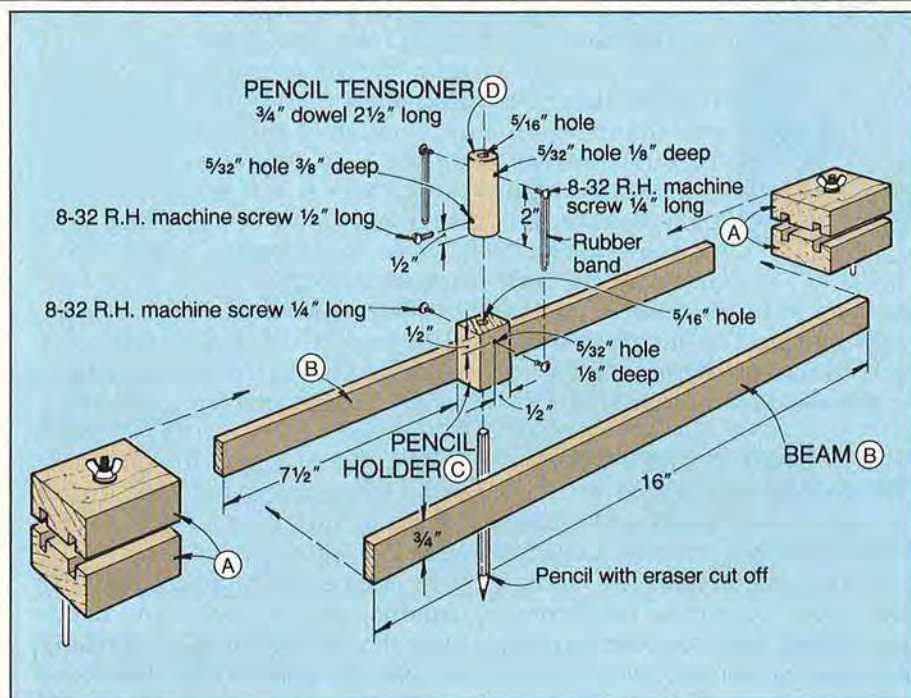

## HOW TO USE THIS HANDY TOOL

**STEP 1.** Mark the center of the stock, and draw perpendicular axis lines through the center. Measure and mark reference points on the axis lines for the oval length and width. Our oval measures 9×12", so we made our marks 4½" and 6" from the center. Position the sliding blocks so the distance from the pencil lead to the outside edge of the nails measures 4½" and 6" respectively. Tighten the wing nuts to hold the sliding blocks on the beams.

**STEP 2.** Align the inside edges of a framing square flush with the marked axis centerlines where shown above. Clamp the square in place. Position the oval marker where shown. Keeping the rounded nails firmly against the inside edges of the square, move the oval marker to form a quarter section of an oval. Reposition the square, clamp the square in place, and repeat the procedure three more times to complete the oval.

clamp the holder, centered from end to end, between the beams.

**3** Cut the eraser off a #2 lead pencil. Insert the pencil into the pencil tensioner. Then, insert the bottom end of the pencil through the pen-

cil holder. Position the pencil so the sharpened end protrudes about ⅛" lower than the rounded ends of the nails. Tighten the pencil in place in the pencil tensioner with an 8-32 machine screw.

**4** Finish; then fasten the screws to the pencil holder and tensioner. Attach the rubber bands. 🐿

Project Design: Don Polson  
Photographs: Hopkins Associates  
Illustrations: Kim Downing, Bill Zaun

# EXOTIC WOOD NAPKIN RINGS

An intriguing between-centers project from West Coast turner Mitch Talcove.



Another in a collection of patterns from the nation's top woodturners.



Mitch Talcove

Exotic hardwood from Latin America puts bread on the table for California lumber merchant Mitch Talcove. Mitch contracts for logs, harvested from Central America and Mexico, and

cuts them in his sawmill in Puerto Vallarta, Mexico. In his spare time, Mitch thinks up creative ways to use valuable sawmill scraps.

## FIRST, SHAPE A TAPERED, SOFTWOOD MANDREL

Cut a piece of softwood 1½" square by about 8" long for the mandrel. "A fir or pine 2×4 works well," Mitch notes. "A softwood will compress slightly and keep the napkin blank snugly attached when turning it to shape. Harder woods won't compress as well." Mark a center point on each end of the mandrel, and mount it between centers on the lathe. Turn the stock round with a ½" gouge, and taper the mandrel to the dimensions shown on the drawing below.

## HERE'S HOW TO TURN THE RINGS

For ease in turning round, bevel-rip the edges of a 2×2×12" turning square (see the Buying Guide for our source) on the table saw. Cut the napkin ring blanks to 1¾" long. Find and mark the center point on one end of each blank. Using a drill press and a Forstner bit, bore a

1¼" hole through the center of each napkin blank.

Remove the tapered mandrel from the lathe, and slide a napkin ring blank onto it until it fits snugly. Now, twist the blank clockwise to lock it in place. Turn the blank round with a ½" gouge and form the slight tapers on each ring with a skew. Mitch prefers a wall thickness of about ⅛".

To sand the inside of each napkin ring, Mitch makes his own sanding drums. Here's how to do it: wrap double-faced tape around a ½"-diameter piece of dowel stock 3" long. Then, adhere 100-grit sandpaper to the tape, chuck the dowel into your drill press, and sand the inside of each napkin ring. Now, slide one napkin ring back onto the mandrel, start the lathe, and hand-sand the outside of it, progressing to 400-grit paper. Stop the lathe and do the final sanding with the grain. Repeat for the other rings.

Now, apply finish to the napkin rings. Mitch likes to finish his with Liberon Black Bison Clear Wax, although any high-content carnauba wax would work. Next, loosen the tailstock, and remove the mandrel from the lathe. Carefully twist the napkin ring counterclockwise to separate it from the holder. Then, apply wax to the inside of the ring.

## BUYING GUIDE

• **2×2×12" Turning square.** Choice of cocobolo, \$5.75 ppd., or bocote, \$4.90 ppd. Tropical Exotic Hardwoods of Latin America, P.O. Box 1806, Carlsbad, CA 92008. 🌿

Photographs: Hopkins Associates, David Schwefel

Illustration: Kim Downing, Bill Zaun

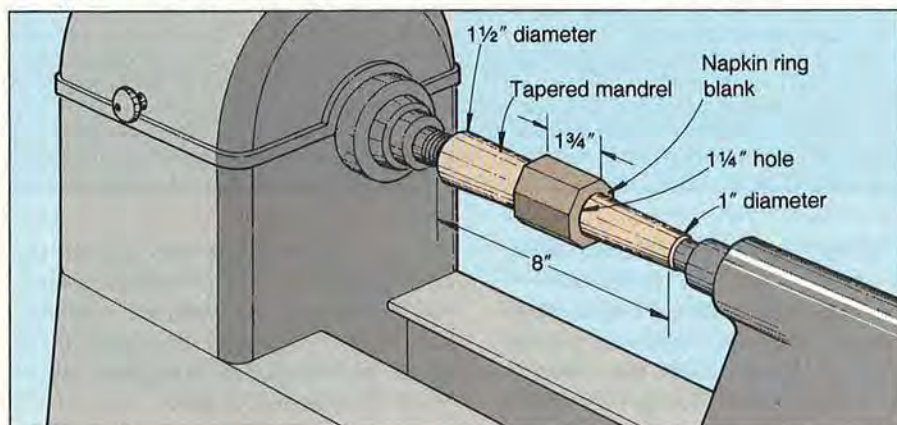

Issue 17  
June 1987



# WOOD

## I N D E X



Issue 21  
February 1988

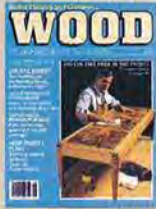

Issue 18  
August 1987



Issue 22  
April 1988

Issue 19  
October 1987



Issue 23  
June 1988



Issue 20  
December 1987



Issue 24  
August 1988

### Cumulative index for issues 17-24

If you save back issues of *WOOD*® magazine for future reference—as many of our readers do—save this index in a special spot. The index appears in the center of the magazine so you can remove it. We've tried to keep the index easy to use. For example, after the subject "Picture frame," you'll see the number 21:50-53. This means the article on pages 50 through 53 of issue 21. Because "Picture frame" happens to be a project, you also can find it listed in the "Project Index" on page 53.

The index for *WOOD* issues 1-8 appeared in issue 9 (February, 1986). The index for issues 9-16 appeared in issue 17 (June, 1987).

### A-C

Abrasives, kinds of, 20:50-53  
 Alder, red, 21:33  
 Amana furniture, 19:66-69  
 finish for, 19:70-71  
 Arts and crafts shows, 19:42-43  
 Aspen, 18:29  
 Axmaker, 19:96-98  
 Balsa, 23:83  
 Band saws:  
 blade honing, 17:16  
 blade installation, 21:18  
 boxes made with, 21:62-65  
 extension table for, 18:20  
 slick work surface for, 22:14  
 Belt buckles, 20:80  
 Bench dogs, 19:18  
 Bird feeder, 19:74-75  
 Bits, 17:26; 23:26  
 in drill press, 24:31  
 Forstner, 20:95-96  
 router, 17:36  
 tapering, 21:16  
 Blacksmith, 19:96-98  
 Blade-height gauge, 22:58-59  
 Boat, model 18:54-57  
 Bookcases:  
 barrister's, 21:66-71; 23:10  
 standards for, 21:58-61  
 Books, woodworking, 20:58-59  
 Bowls:  
 blanks for, harvesting, 20:44-49  
 compote, 19:56  
 stave, 23:30-39  
 Boxes:  
 jewelry, 23:53; 24:48  
 scallop, band-sawn, 21:62-65  
 toy, 18:52

Brads, setting, 21:18  
 Brushes, 23:25  
 foam, using parts of, 17:19; 22:14  
 Buckles, belt, 20:80  
 Bulldozer, toy, 20:78-79, 82  
 Burl-topped coffee table, 18:40-44  
 Buymanship:  
 abrasives, 20:50-53  
 carvers, power, rotary, 19:64-65;  
 attachments for, 19:30  
 combination woodwork-  
 ing machines, 22:52-57  
 dovetail jigs, 19:34-39  
 drill presses, 24:56-61  
 Forstner bits, 20:95-96  
 joiners, plate, 23:44-47  
 planers, power, hand-held, 18:70-75  
 routers, plunge, 21:34-39  
 safety glasses, 24:64-67  
 saw blades, circular, 20:60-62  
 saws, radial arm, 17:42-47  
 Cabinets:  
 corner, 23:52  
 file, 21:72-75, 88; 22:11  
 insect control under, 20:14  
 Candle holder, 20:67  
 Caning chairs, 23:48-49  
 Carving:  
 with chain saw, 23:40-43  
 figures, human:  
 French Louie, 17:78  
 Hillbilly Will, 24:76-77  
 Mrs. Todd, 19:57  
 proportion wheel for, 22:22  
 fish, 21:76-79  
 hand tools for, 20:21; 24:79  
 horse, 23:53

Carving (*Continued*)  
 lacquer finish, 22:48-51  
 power tools for, rotary, 19:64-65  
 attachments for, 19:30  
 safety rules for, 20:29, 31  
 serving board, 22:74  
 workstand for, 22:22  
 Carving board, 17:40-41  
 Cedar, western red, 19:33  
 Chain saws:  
 carver using, 23:40-43  
 sharpening, 20:99, 101-102  
 Chair rail (molding), 21:49  
 Chairs:  
 director's, teak, 23:65-69  
 leg-rail joinery for, 18:34-39  
 members, repairing, 24:16  
 recaning, 23:48-49  
 rockers, 19:40-43  
 Cheese board, art-deco, 24:54  
 Chests:  
 cedar, 24:49  
 tool, 19:44-47  
 Children's items. *See also* Toys  
 clothes rack, rabbit, 22:67  
 cradles, 19:58-62; 20:11; 23:52, 24:49  
 dinosaur mirror, 19:76-77  
 play structure, 23:72-76  
 toy box, 18:52  
 Chisels, 20:26; 21:24  
 Chucks:  
 adapter rings for, 17:24  
 three-jawed, tightening, 22:14  
 Clamps:  
 blocks for, holding in place, 20:16; 23:14  
 drill press as, 17:16; 24:30  
 frame, making, 21:16; 24:18  
 pipe, edge-joining with, 19:85  
 strap, 23:24

Clocks:  
 carved and sandblasted, 18:53  
 from kits, 19:50-53  
 mantel, 20:54-57  
 tall, contemporary, 22:40-47, 78  
 teddy bear, 22:64-65  
 turned teak, 19:78-79  
 Clothes rack, rabbit, 22:67  
 Clothing for woodworking, 20:27  
 Collectible tools, 18:50-51, 88  
 levels, 19:82  
 shaves, 19:100  
 Combination woodworking machines, 22:52-57  
 Compass, yardstick, 23:23  
 Contact cement, 18:81  
 Corner-block leg-rail joinery, 18:34-37  
 Cradles, 19:58-62; 20:11; 23:52; 24:49  
 Craftsman Close-ups:  
 chain-saw carvings: Pat Fushimi, 23:40-43  
 fish carvings: Rick Beyer, 21:76-79  
 marquetry: John Wilson, 17:74-77  
 miniature furniture: Noral Olson, 20:40-43  
 painting with wood: Judy Gale Roberts, 24:38-43  
 rockers: Hugh (Blow) and Jennie Vaughn, 19:40-43  
 shop teacher: Carmen Schifano, 18:30-33  
 timber-frame joinery, Samule Aaron, 22:36-39  
 Cutter, string and tape, 22:18  
 Cutting base, 19:29  
 Cutting boards:  
 Art-Deco, 24:54  
 sunburst, 24:50-53

*Continued*



**Leg-rail  
joinery**  
Issue 20  
Page 34



**Wisconsin  
fish story**

Issue 21  
Page 76



**Burl-topped  
coffee table**  
Issue 18  
Page 40



Cutting boards (*Continued*)  
Texas toast, 24:55  
tips for, 22:83-84  
Cypress, bald, 20:33

## D-F

Director's chairs, teak, 23:65-69  
Doll stroller, 20:71-73  
Dovetail jigs, 19:34-39, 48-49  
Dowel centers, use of, 20:14  
Doweling jig, 18:81  
Drawer pull, continuous, 21:47  
Drawer rattles, silencing, 19:14  
Drawing board, pantograph, 23:58-59  
Drawings and plans, reading, 18:46-49  
Drill presses, 24:56-61  
techniques with, 24:26-31, 74-75  
Drills and drilling:  
bits for. *See* Bits  
chuck adapter rings for, 17:24  
debris from, catching, 17:19; 23:14  
Drum sanders, 20:25; 23:14  
holder for, 17:57  
Dust control, 17:16; 22:12; 23:14  
equipment for, 17:48-51, 87; 18:90; 21:22  
Earrings, turned, 23:64  
Ebony, 20:104  
Epoxy, 19:24; 23:20  
Extension tables:  
for band saw, 18:20  
cushioning edges of, 18:24  
File cabinet, 21:72-75, 88; 22:11  
Filigree, laser-cut, 22:21  
Finishes and finishing:  
abrasives for, 20:53  
Amana varnish system, 19:70-71  
can lids, tight seal for, 20:18  
foam rubber for applying, 22:12  
lacquer, 18:66-69  
brushed, 22:48-51  
for pine, 19:93-94  
restorer, 17:22  
Sealacell system, 20:26  
wax, creme, 18:81  
for workshop floor, 20:85

Floor, workshop, finishes for, 20:85  
Football award, 21:56  
Forstner bits, 20:95-96  
Frame clamps, making, 21:16; 24:18  
Frames and framing, timber, 22:36-39  
Furniture. *See also* Chairs; Tables  
Amana Colonies, 19:66-69  
finish for, 19:70-71  
cabinets:  
corner, 23:52  
file, 21:72-75, 88; 22:11  
cradles, 19:58-62; 20:11; 23:52; 24:49  
from kits, 19:50-53  
miniature, 20:40-43  
settee, 17:68-73  
shelves and bookcases:  
barrister's, 21:66-71; 23:10  
standards for, 21:58-61  
wall system, 18:58-63, 76, 79

## G-I

Gauges:  
blade-height, 22:58-59  
miter, 19:18; 21:20; 22:12  
wire/screw/drill bit, 19:24  
Glass cutting, straightedge for, 20:23  
Glasses, safety, 24:64-67  
Gluing:  
break in wood, aligning, 20:14  
cracks, hairline, 17:16  
Gouges, bowl, 22:24  
Grinding jig, drill press, 24:74-75  
Gum, sweet, 23:29  
Handscrews, gripping, 24:16  
Hand tools: *See* Tools  
Harp, 18:52  
Height gauge, 22:58-59  
Herringbone table, 22:30-31, 34-35  
Hinge mortises, cutting, 24:37  
Holes, drilling, 17:24; 24:26-28  
Homemade tools:  
blade-height gauge, 22:58-59  
bow sander, 18:22  
drum sanders, 23:14  
frame clamps, 21:16; 24:18  
pantograph board, 23:58-59

Homemade tools (*Continued*)  
pin-routing attachment, 17:38-39, 81  
sawhorse, 24:62-63  
taper jig, 18:45  
tweezers, 18:20  
Hoods, dust collection, 17:87  
Horse, carved, 23:53  
Horse logging, 22:68-73  
Hourglass, 21:57  
Inlays, scroll-sawn, 20:36-37  
Insect control, 20:14; 22:18  
Intarsia, 19:56; 24:38-43

## J-M

Jarrah, 19:103  
Jars, spice, 21:80  
Jeep, toy, 18:53  
Jewelry:  
earrings, turned, 23:64  
necklace, swan, 22:66  
Jewelry boxes, 23:53; 24:48  
Jigs:  
dovetail, 19:34-39, 48-49  
doweling, 18:81  
for finger joints, 17:26  
grinding, for drill press, 24:74-75  
taper, 18:45  
Jointer/planer blades, sharpening, 24:31, 74-75  
Joints and joinery:  
dovetail, jigs for, 19:34-39, 48-49  
edge, with pipe clamps, 19:85  
finger, guide for, 17:26  
leg-rail, 18:34-39  
plate joiners, 23:44-47  
timber-frame, 22:36-39  
Key chain, 20:70  
Kit builders, 19:50-53  
Knives, pocket, 20:21  
Labels, gummed, removing, 21:18  
Lacquer, 18:66-69  
brushed, 22:48-51  
Lathe work. *See* Turning  
Leg-rail joinery, 18:34-39  
Legs, cylindrical, repairing, 21:16  
Letter opener, 21:54-55  
Levels, spirit, 19:82  
Logging, 19:54-55  
horse, 22:68-73  
Logs, sawing, 21:40-43  
Mantel clock, 20:54-57  
Manufacturing:  
plywood, 17:64-67

Manufacturing (*Continued*)  
saw blades, 22:60-63  
Maple bowl, 23:36-37  
Marquetry, 17:74-77  
Miniature furniture, 20:40-43  
Mirrors:  
dinosaur, 19:76-77  
hand, quilt-look, 20:76-77, 81  
Miter cutoff fixture, 22:21  
Miter gauges, 21:20  
loose bar, fixing, 22:12  
squaring up, 19:18  
Mixing jobs, 19:20  
Models:  
Rolls Royce, 21:56  
yacht, 18:54-57  
Moldings, 21:44-49  
picture frame, 21:46, 50-53  
Money clip, 20:68-70  
Mortise-and-tenon leg-rail joinery, 18:34-39  
Mortises, making, 24:28  
attachment for drill press, 24:60  
attachment for router, 22:22  
for hinges, 24:37  
Mosaic pictures, 19:56; 24:38-43  
Musical instruments, 18:52; 23:60-63

## N-P

Nails, holding, 21:18  
Nail set, offset, 19:24  
Necklace, swan, 22:66  
Notepad holder, 19:63, 81  
Oak:  
English, 18:25  
herringbone table, 22:30-31, 34-35  
The Old Hand Ways (Roy Underhill):  
The Blacksmith, 19:96-98  
The Woodlot, 21:82-84, 86  
Onlay technique, 22:28-33, 77  
Outdoor furniture:  
settee, 17:68-73  
teak table and director's chairs, 23:65-71  
Padauk, 24:25  
Paint, aerosol, touch-ups with, 20:14  
Painting with wood, 19:56; 24:38-43  
Paint remover, spray, 24:80  
Paint rollers, 3", 18:20



**Template routing techniques**  
Issue 17  
Page 32



**Barrister's bookcase**  
Issue 21  
Page 66



**Drawings and plans**  
Issue 18  
Page 46

**Harvest your own bowl blanks**  
Issue 20  
Page 44



Paldao, 24:23  
Pantographs, 23:56-59  
Paperweight, executive, 18:64-65  
Patch, flush, on old veneer, 18:86-87  
Patterns, project: materials for making, 18:22, 22:16 reproducing, 23:54-59  
Pegs, Shaker, 21:20  
Photographs of projects, 24:44-47  
Picture frames, 21:50-53 moldings for 21:46, 50-53  
Picture rail, 21:48  
Pine, finishing, 19:93-94  
Pin routing, 17:32-37 attachment for, 17:38-39, 81 project with, 17:40-41  
Pipe clamps, edge-joining with, 19:85  
Plane kit, 24:80  
Plane rack, 17:52  
Planer/jointer blades, sharpening, 24:31, 74-75  
Planers, power, hand-held, 18:70-75  
Plans and drawings, reading, 18:46-49  
Planters, 24:68-72  
Plaques: intarsia, 24:43 relief, 20:36-37, 74-75  
Plate joiners, 23:44-47  
Play structure, 23:72-76  
Plugs, dowel, making, 19:20  
Plunge routers, 21:34-39  
Plywood, manufacture of, 17:64-67  
Power tools. *See also* Routers and routing: Saws carvers, rotary, 19:64-65 attachments for, 19:30 combination woodworking machines, 22:52-57 drill presses, 24:56-61 techniques with, 24:26-31, 74-75 dust collection for, 17:48-51, 87; 18:90; 21:22 Forstner bits for, 20:95-96 joiners, plate, 23:44-47 keys, safekeeping for, 20:16 modular, 18:81 planers, hand-held, 18:70-75 swing-down storage for, 18:20

## R-S

**Racks:** clothes, rabbit, 22:67 plane, 17:52 record, in wall system, 18:79 wine, 20:64-66 in wall system, 18:76  
Radial arm saws, 17:42-47  
Rail-leg joinery, 18:34-49  
Record rack in wall system, 18:79  
Repair of old veneer, 18:86-87  
Rockers, Texas, 19:40-43  
Rolls Royce model, 21:56  
Rotary-cut softwood plywood, 17:64-67  
Router Master pad, 24:79  
Routers and routing: dovetail jigs for, 19:34-39, 48-49 moldings made with, 21:44-49 mortise attachment for, 22:22 plunge, 21:34-39 template, 17:32-37 attachment for, 17:38-39, 81 project with, 17:40-41  
Rules, folding, 21:91, 93  
Rust prevention, 20:18  
Safety: carving, 20:29, 31 clothing, proper, 20:27 glasses for, 24:64-67 lacquer, 18:67 radial arm saws, 17:44  
Safety glasses, 24:64-67  
Sailboat, model, 18:54-57  
Sanders and sanding: abrasives, 20:50-53 block, 23:23 bow, 18:22 with drill press, 24:29 drum, 20:25; 23:14 holder for, 17:57 dust from, blowing away, 22:12 in grooves, 23:16 of miniature parts, 23:20 pads, foam brushes as, 17:19 sleeves, tungsten-carbide, 24:80  
Satinwood, 21:30  
Sawhorse, 24:62-63  
Sawmills, home, 21:40-43  
Saws and sawing. *See also* Band saws; Table saws

**Saws and sawing (Continued)**  
blades, 20:60-62; 23:26 cleaning, 20:21 holders for, 19:14 maintenance of, 22:80 manufacture of, 22:60-63  
chain: carver, using, 23:40-43 sharpening, 20:99, 101-102

**Saws and sawing (Continued)**  
panel, 20:25  
radial arm, 17:42-47  
sawdust buildup, preventing, 17:16  
scroll, using, 19:14; 20:34-39, 74-75  
Scrapers: for finishes, 19:23 for wood, 17:22

## PROJECTS

Belt buckles, 20:80  
Bird feeder, 19:74-75  
Blade-height gauge, 22:58-59  
Bowls, stave, 23:36-39  
Boxes, scallop, band-sawn, 21:62-65  
Bulldozer, 20:78-79, 82  
Candle holder, 20:67  
Carved figures: French Louie, 17:78 Hillbilly Will, 24:76-77  
Carving board for meat, 17:40-41  
Chairs, director's, teak, 23:66-69  
Cheese board, Art-Deco, 24:54  
Clocks: mantel, 20:54-57 tall, contemporary, 22:40-47, 78 teddy bear, 22:64-65 turned teak, 19:78-79  
Clothes rack, rabbit, 22:67  
Cradle, 19:58-62; 20:11  
Cutting boards: Art-Deco, 24:54 sunburst, 24:50-53 Texas toast, 24:55  
Doll stroller, 20:71-73  
Drum-sander holder, 17:57  
Earrings, turned, 23:64  
File cabinet, 21:72-75, 88; 22:11  
Grinding jig, drill press, 24:74-75  
Inlays, scroll-sawn, 20:36-37  
Key chain, 20:70  
Letter opener, 21:54-55  
Mirrors: dinosaur, 19:76-77 hand, quilt-look 20:76-77, 81 Money clip, 20:68-70  
Necklace, swan, 22:66  
Notepad holder, 19:63, 81  
Pantograph drawing board, 23:58-59  
Paperweight, 18:64-65  
Picture frame, 21:50-53  
Plane rack, 17:52  
Planters, 24:68-72  
Plaques: intarsia, 24:43 relief, scroll-sawn, 20:36-37, 74-75  
Play structure, 23:72-76  
Puzzles, scroll-sawn, 20:35  
Routing attachment, 17:38-39, 81  
Sawhorse, 24:62-63  
Sculptured pictures, 20:38-39  
Serving board, 22:74  
Settee, 17:68-73  
Shelves: arched-top system, 18:58-63, 76-79 barrister's bookcase, 21:66-71; 23:10  
Spice jars, 21:80  
Stack-cut ornaments, 20:38-39  
Tables: coffee, burl-topped, 18:40-44 dining: herringbone, 22:30-31, 34-35 sunburst, 17:58-63 teak, 23:70-71  
Taper jig, 18:45  
Tool chest, 19:44-47  
Trucks, toy, 20:78-79, 82; 24:32-36  
Vases: onlay, 22:33, 77 turned, 19:80  
Wine rack, 20:64-66  
Yacht, model, 18:54-57

*Continued*



**Woodworker's tool chest**  
Issue 19 Page 44



**12-Meter racing yacht**  
Issue 18  
Page 34



**Contemporary tall clock**  
Issue 22  
Page 40



**Scroll-saw techniques**  
Issue 20  
Page 34

**Screws:**

- broken, removing, 19:14
- slots in, deepening, 20:23
- Scroll saw, use of, 19:14; 20:34-39, 74-75
- Sealant, silicone-type, 19:29
- Serving board, carved, 22:74
- Settee, 17:68-73
- Sharpening:
  - chain saw, 20:99, 101-102
  - jointer/planer blades, 24:31, 74-75
- Sharpening stones, diamond, 23:50-51
- Shaves (spokeshaves), 19:100
- Shelves:
  - arched-top wall system, 18:58-63, 76,79
  - barrister's bookcase, 21:66-71; 23:10
  - standards for, 21:58-61
- Spice jars, 21:80
- Spinning wheel, 24:48
- Spruce, Sitka, 17:31
- Stack cutting, 20:38-39
- Stave bowls, 23:30-39
- Stones, sharpening, diamond, 23:50-51
- Stop blocks, 22:16
- Storage bins from cans, 23:18

**T-Z**

**Tables:**

- coffee:
  - burl-topped, 18:40-44
  - with stained glass, 21:57
  - stump-based, 19:57
- dining:
  - herringbone, 22:30-31, 34-35
  - sunburst, 17:58-63
- leg-rail joinery for, 18:34-39
- teak, 23:70-71
- Table saws:
  - aligning stock on, 22:12
  - blade-height gauge for, 22:58-59
  - cushioning edges of, 18:24; 21:16
  - miter-gauge squaring for, 19:18
  - protectant for, 21:22
- Tall clock, contemporary, 22:40-47, 78
- Tape measures:
  - 4-in-1, 19:23
  - line drawn with, 18:24
  - wasing, 24:18

**Taper jig, 18:45**

- Taping:
  - stick-free, 20:18
  - for trial assembly, 23:16
- Teak, 22:27
- table and chairs, 23:65-71
- wall clock, 19:78-79
- Techniques:
  - chain saw, sharpening, 20:99, 101-102
  - chair caning, 23:48-49
  - dovetails, routing, with jig, 19:48-49
  - drill press, 24:26-31, 74-75
  - edge-joining with pipe clamps, 19:85
  - hinge mortises, cutting, 24:37
  - leg-rail joinery, 18:34-39
  - moldings, router, 21:44-49
  - onlay, 22:28-33, 77
  - photographing projects, 24:44-47
  - scroll-saw, 20:34-39, 74-75
  - stave-bowl construction, 23:30-35
  - template routing, 17:32-37
  - vener, patching, 18:86-87
- Template routing, 17:32-37
- attachment for, 17:38-39, 81
- project with, 17:40-41
- Timber:
  - harvesting, 19:54-55; 20:44-49; 22:68-73
  - identifying, 19:91
  - sawmilling, 21:40-43
- Timber-frame joinery, 22:36-39
- Tool buymanship. *See* Buymanship
- Tool chest, 19:44-47
- Tools. *See also* Homemade tools; Power tools; Sanders and sanding
  - as, making of, 19:96-98
  - carving, 20:21; 24:79
  - chisels, 20:26; 21:24
  - clamps:
    - frame, 21:16; 24:18
    - pipe, edge-joining with, 19:85
  - strap, 23:24
- collectible, 18:50-51, 88
- levels, 19:82
- shaves, 19:100
- dovetail jigs, 19:34-39, 48-49

**Tools (Continued)**

- gouges, bowl, 22:24
- miter gauges, 21:20
- maintenance of, 19:18; 22:12
- nail set, offset, 19:24
- planes:
  - holder for, 17:52
  - kit for, 24:80
- rules, folding, 21:91, 93
- saw, panel, 20:25
- scrapers, 17:22; 19:23
- sharpening stones, diamond, 23:50-51
- tape measures, 19:23
- line drawn with, 18:24
- wasing, 24:18
- Toy bos, 18:52
- Toys:
  - bulldozer, 20:78-79, 82
  - doll stroller, 20:71-73
  - jeep, 18:53
  - puzzles, scroll-sawn, 20:35
  - trucks, 24:32-36
- Tracing materials, 22:16; 23:18
- Tree harvesting, 19:54-55; 20:44-49; 22:68-73
- Tree quiz, 21:94, 96
- Tree species. *See* Wood species
- Trucks, toy, 24:32-36
- Turning:
  - blanks for, harvesting, 20:44-49
  - bowl gouges for, 22:24
  - candle holder, 20:67
  - clock, 19:78-79
  - earrings, 23:64
  - paperweight, 18:64-65
  - spice jars, 21:80
  - stave bowls, 23:30-39
  - vase, 19:80
- Tweezers, homemade, 18:20
- Varnish, Amana system of, 19:70-71
- Vases:
  - onlay, 22:33,77
  - turned, 19:80
- Vener:
  - coffee table with, 18:40-44
  - patching, 18:86-87
- Wall plaques:
  - intarsia, 24:43
  - scroll-sawn, 20:36-37, 74-75
- Wall system, arched-top, 18:58-63, 76, 79
- Was, creme, 18:81
- Wine rack, 20:64-66

- Woodcarving. *See* Carving
- Wood harvesting, 19:54-55; 20:44-49; 22:68-73
- Woodlot, 21:82-84, 86
- Wood movement, 18:83-84
- Wood production:
  - plywood manufacture, 17:64-67
  - sawmilling, 21:40-43
- Wood quiz, 21:94, 96
- Wood scraper, 17:22
- Wood species:
  - aspens, 18:29
  - bald cypress, 20:33
  - balsa, 23:83
  - Carpathian elm burl, 18:40
  - ebony, 20:104
  - English oak, 18:25
  - identifying. *See* Identification of wood
  - jarrah, 19:103
  - for musical instruments, 23:60-63
  - padauk, 24:25
  - paldao, 24:23
  - red alder, 21:33
  - satinwood, 21:30
  - Sitka spruce, 17:31
  - sweet gum, 23:29
  - teak, 22:27
  - western red cedar, 19:33
- Woodturning. *See* Turning
- Woodworkers. *See also* Craftsman Close-ups
  - carvers:
    - Bigton, Else, 22:74
    - Butz, Rick, 17:78; 24:96
    - Enlow, Harold, 24:76-77
    - Weber, Fern, 22:48-51
  - sawyer: Darrell Mattson, 21:40-43
  - turners:
    - Bernson, Bruce, 19:80
    - blank harvesting by, 20:48-49
    - Brennon, Phil, 21:80
    - Klein, Bonnie, 23:64
- Woodworker's standards:
  - bookcases and shelves, 21:58-61
  - drawings and plans, 18:46-49
  - patterns, reproducing, 23:54-57
- Woodworking books, 20:58-59
- Workstand, multiposition, 22:22
- Yacht, model, 18:54-57



# GET SMOOTH RESULTS FROM YOUR BELT SANDER

A belt sander makes fast work of smoothing down rough stock. But if you're not careful, you can end up with ridges and gouges that seem to take forever to sand away. Here's how to do a perfect job every time.

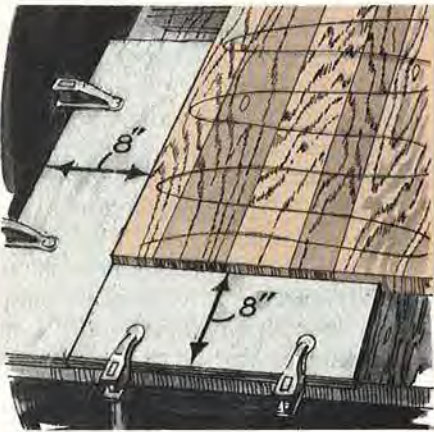

**I** Belt sanders cut aggressively, so you've got to secure the workpiece to the bench before you start. Try this method: Clamp short, narrow stock in a vise, so it projects about 1/4" above the clamp jaws.

To secure wide stock, clamp 6"- to 8"-wide plywood stops where shown on the drawing *above*. Again, you want the top surface of the workpiece to project above the stop strips so they don't interfere with the sander.

An alternative method is adhering the workpiece to the work surface with double-faced carpet tape. If you don't mind sanding away the tape residue, you can save time and clamping materials this way.

Using a pencil, draw a wavy line across the surface of the stock, as shown on the drawing. This provides you with a visual reference while sanding—after you've completely sanded away the mark, it's time to switch to a finer-grit paper.

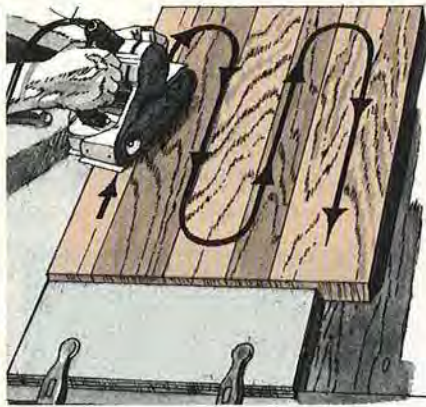

**2** Starting with 120-grit sandpaper, set the sander on the stock midway between both ends as shown in the drawing *above*. Keep the sander perfectly flat to the wood surface when you turn it on. Hold the sander at a 15° to 20° angle to the direction you're sanding. Belt-sand up and down the length of the stock, moving to the right about 1" at the end of each pass. Let the machine's weight do the work.

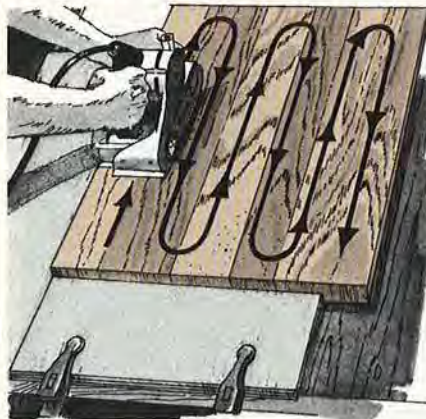

**3** After you've sanded away the wavy line, switch to a finer-grit belt. Draw a second wavy line, and make straight passes, holding the machine parallel to the grain as shown *above*. Move to the right about 1" after each pass. When the pencil line vanishes again, switch to a finer grit for finish sanding.



**4** No matter how carefully you sand, there's always the chance that you'll accidentally gouge the wood. So, each time you finish sanding with a particular grit, check your work before moving to the next grit. We suggest you clamp a small light to your bench, as shown *above*, so that it illuminates the stock from a low angle. By standing behind the light and sighting down the length of the wood, you'll be able to see even the slightest gouges.



**5** Sanding a narrow board or edge can be especially difficult because the sander tends to rock from side to side, rounding over the corners. Here's how to keep the corners sharp: Clamp a piece of scrap, called a *ledger*, to one side of the board (align both surfaces). Make the combined width of the ledger and board approximately equal to the width of the sanding belt. Draw a wavy line on the board and sand it, following the steps *above*.

Written by Jim Barrett Illustrations: Jim Stevenson

# UNCOMMON STOCKS

There's plenty of talk about the stock market in tiny Warsaw, Missouri. Not the Wall Street variety, though. Local folks, as well as sportsmen and firearms collectors the world over, prize the work of Reinhart Fajen, Inc., gunstock makers, as functional investments.



Anyone in the Missouri Ozark's town of Warsaw can direct you to Reinhart Fajen, Inc. "It's on Gunstock Drive, near Walnut."

No signs identify this world-renowned operation. And Reinhart Fajen doesn't even *look* like a factory. Production split among six widely dispersed buildings on the 7½-acre, tree-covered site reduces loss in the event of fire.

Despite this company's unassuming facade, a glimpse within reveals about 50 employees producing 35,000 to 45,000 gunstocks per year—making Reinhart Fajen, Inc. the world's largest producer of strictly gunstocks. Customers range from the person looking for a replacement stock for an inexpensive rifle or shotgun to the serious gun collector willing to part with equally serious amounts of money.

A semifinished stock, which requires the owner or a gunsmith to fit it to the action, starts at \$40 for a rifle and \$50 for a shotgun. An all-



out custom stock with ornate hand-carving and checkering can cost the princely sum of \$5,000—or lots more.

Customers don't even have to visit Warsaw. In fact, the company does most of its business by mail, with gunowners or gunsmiths.

◀ Hand-checkering a gunstock 32 lines to the inch demands patience and precision from a Reinhardt Fajen craftsman. The reward is a sure grip.



◀ Shotgun with stump-figured walnut thumb-hole stock and matching forearm

▼ Classic double-barrel shotgun restocked with feathered-crotch walnut

### IMPROVING ON MOTHER NATURE

A gunsmith by trade, Reinhart Fajen began making custom replacement gunstocks by machine in 1939 with a partner, John Bishop. Until that time, gun owners had only two choices: the mass-produced stock supplied with the gun from the factory, or prohibitively expensive stocks made entirely by hand. Their new business was an immediate success—one that carried over to Fajen after he bought out Bishop in the fifties, and later to John Beringer, who purchased the company in 1987.

Natural differences in wood make each gunstock special. But the company improves that uniqueness with custom checkering, carving, and laminating dyed woods. New owner Beringer says matter-of-factly: "We offer over 100,000 choices."

Walnut is the most popular

Not surprisingly, such highly figured wood couldn't possibly fall under traditional hardwood lumber grading standards. That's why the company applies its own. Here's just a sample of the grades they apply to walnut alone: *Utility* grade to *Supreme Deluxe* (four levels in plain walnut), *Semi-fancy* to *AAA Fancy* (another four levels in the lowest category of figured walnut), and *AAA Fancy Grade, Special Selection* (the cream of the crop in highly figured gunstock wood).

Sometimes, the customer supplies the gunstock blank for Fajen to turn and customize. Probably never, though, will they have another customer like the Georgia gun enthusiast who collects wood and combines both interests in a dramatic collection.

A few years ago, the Georgian, a

can identify the company's work easily by the styling and the quality of the wood-to-metal fit.

Says Marty Fajen, sales manager and daughter-in-law of the founder, "I can be watching a movie and spot one of our stocks right away." That's because even Fajen stocks for factory replacements don't slavishly duplicate the originals, but include subtle changes.

"We don't make our stocks from blueprints," explains Fred Wenig, a 33-year Fajen veteran, "we make them from patterns." Wenig, who his boss calls the best gunstock maker in the country, points to rows of full-sized walnut patterns lining walls like silent sentries.

The apparent random storage of the pattern stocks doesn't seem to bother anyone, though. "Most of our fellas have worked here a long time," Wenig says. "They know

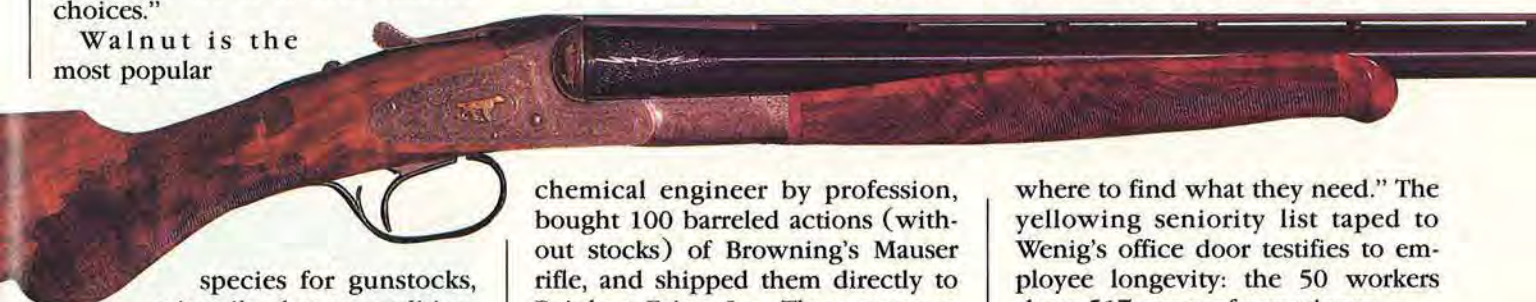

species for gunstocks, primarily due to tradition, but also because it absorbs shock well. In fact, walnut accounts for 90 percent of Fajen's production. Within the walnut family, though, fall American black walnut, California claro walnut, French walnut, and Bastogne walnut! Birch, maple, mesquite, myrtle, pecan, and sycamore round out the readily available species. But, within those woods you can choose from varieties of fiddleback, stump, crotch, or just plain fancy figure. Add to those choices camouflage and the light-dark contrasts possible with laminated wood, and you'll see how the company one-ups Mother Nature.

chemical engineer by profession, bought 100 barreled actions (without stocks) of Browning's Mauser rifle, and shipped them directly to Reinhart Fajen, Inc. Then, every so often, unusual pieces of wood—acquired during world travel—arrived to be made into gunstocks. The most unusual arrival to date: a rare blank of pink ivory. At last count, the well-traveled collector had 60 custom-stocked rifles, identical except for the species of wood. Forty actions remain in the company's vault, awaiting whatever wood arrives next.

### UNSIGNED WORKS OF ART

"Our people are artists in a business climate," Beringer states. Although these works of art leave the factory unsigned, most gun dealers

where to find what they need." The yellowing seniority list taped to Wenig's office door testifies to employee longevity: the 50 workers share 517 years of experience.

Eighty percent of Fajen's business (primarily mail order; see catalog note at the end of this article) comes from gun shops, and the remainder from individual gun owners. However, Fajen representatives do attend the nation's largest gun shows and sportsmen's conventions to offer personalized attention. For instance, they offer a custom-fitting service. Once Fajen knows all dimensions, they custom-tailor a stock. According to Wenig, a dedicated shooter sees custom-tailoring guns and rifles as no more extravagant than a businessman's made-to-order dress shirts.

*Continued*

# UNCOMMON STOCKS

## NO-STRESS BLANKS FOR RUGGED USE

End-coated at the suppliers' sawmills to prevent premature drying, the rough-cut stock blanks arrive in Warsaw with about 40 percent moisture content. To ensure uniform drying, the first part of the drying process in the two Fajen kilns (each holds 22,000 gunstock blanks) adds steam to bring every piece of wood to the same moisture content level.

"Then," notes Wenig, "we start drawing the water out... slowly." For the 2¼"-thick blanks, slowly means up to six months to reach 8 percent moisture content. Even under these carefully controlled conditions, Fajen loses 3-6 percent of its blanks to splitting.

If a blank doesn't split in the kiln, Fajen craftsmen see to it that it won't split under the rigors of use, either. This insurance begins with laying out a pattern on the stock blank. Grain direction in the grip area behind the trigger—the thinnest part of the stock—becomes especially critical. The shock of recoil will surely split the stock if the grain doesn't run straight "downhill" to the butt. That also holds true for the forearm section. Fajen orders its gunstock blanks slightly oversize to allow accurate grain orientation in layout.

After being marked for grain direction, blanks proceed to the 36" band saw, where they take on a rough shape. Further rough-shaping on a duplicating lathe removes the corners of the blank.

## FINE-TUNING FOR FIT BEGINS 24 AT A TIME

Lew Massey runs duplicating carving machines that simultaneously produce up to 24 imitations of a pattern stock. "I've made a lot of sawdust since I started here in 1961," he quips.

Each of the spindle heads, connected to a single motor with flat

drive belts, has a high-speed steel cutter. When Massey flips the switch, the machine whirrs to life. With the prod of a 4'-long guide bar, he slowly moves the unsharpened stylus toward the master pattern. As cutters contact the blanks, Massey directs a cut less than ¼" deep on each.

When he shifts his grip for the next cut, the blanks gradually begin to take the pattern's shape. In an hour and forty-five minutes, the 24 stocks have been carved to completion, and move on to the next craftsman for more processing.

Fajen employees pride themselves on their gunstocks' wood-to-metal fit. Duane Kindle's 23 years of experience makes the intricate cuts in the stock for the barrel and receiver look effortless.

Kindle clamps an unfinished stock in a padded-leg vise, then brushes the underside of a gun barrel with "inletting black," a black marking powder. He then eases the barrel into position, gives it a tap with the heel of his hand, and takes the barrel out again. Where the powder leaves its mark, he removes a few thin curls with a gouge.

The wood-to-metal fit means more than appearance. If not fitted just right, the barrel can tear apart a stock with force from the recoil.

## SAWDUST MIX FOR UNDETECTABLE REPAIRS

Gene Coffey collects sawdust. His workbench boasts nearly two dozen jars filled with the sawdust of different-colored wood. He mixes it with epoxy to fill pin knots and other small defects in gunstocks before finishing.

For larger repair jobs, he inserts solid wood patches made from scrap wood. He looks first for color match, not species. He freely intermixes the different varieties of walnut, and will even insert a maple patch into walnut sapwood. "As long as it looks right," he says.



◀ An irregular stump figure stock, plus carving, fits this Winchester rifle.

▼ With a carving gouge, Duane Kindle removes wood from the stock to match the gun's action. A bad fit could splinter the stock.



Some repairs require an inlay technique. Coffey shapes the bed of the area of the patch with a 1/8"-diameter bit in a Dremel Moto-Tool. Then, he completely covers the area with masking tape. After cutting tape out of the patch area for a pattern, he searches for a scrap piece that will match the color and figure of the stock. A bit of final whittling gives the wood a snug fit.

### FINE FINISHES FOR FIELD OR FANCY

Bobbie Park fills grain and sands wood. With an air-powered Sears pad sander and a circular motion, he sweeps over convex curves and concave hollows. He uses 100-grit sandpaper for initial smoothing, then dampens the wood with water to raise the grain before switching to 180-grit sandpaper for the final go-over.

Walnut has open grain. For a smooth finish, Park fills it with a creamy, walnut-colored paste wood filler slathered on with a brush. He doesn't wait for the solvent to "flash off" and lose its sheen before scrubbing the filler into the pores and off the surface with a burlap

rag. After the filler dries, Park again machine-sands with fine 180-grit sandpaper.

Stocks marked to receive the pattern of tiny diamonds called checkering get all of Darrell Smith's attention. For 15 years he has produced the carved, low-relief designs that provide a better grip in the most-handled areas of the stock.

Smith has mastered standard patterns, and usually lays them out by

▲ Cherry and maple in alternate laminations create a tough and stable stock.

◀ A sanding swirl never shows on a Reinhart Fajen stock, even though Bobbie Park constantly moves his pad sander against the grain. A once-over with 180-grit preps the stock for finishing.

eye. With a few quick pencil strokes, he outlines the checkering on a custom stock. He then grabs a checkering tool. With a few deft strokes of its carbide cutter, he replaces the pencil marks with V-cuts. The bite of a Foredom flexible-shaft power tool featuring a serrated cutting wheel follows this.

Smith refines the pattern by hand. Fajen offers variety in the spacing of their checkering, from 18-32 lines per inch—the higher the number the greater the cost. Smith can also carve detailed outlines and floral accents around checkered areas.

At Reinhart Fajen, custom gun-stocks traditionally receive two coats of a Sherwin Williams' dull-sheen, sprayed-on catalyzed (two-part) lacquer called Sher-Wood Super Kemvar C. It has a close-to-the-wood look with little gloss.

Still, many collectors prefer traditional oil because it highlights wood figure without the buildup of a surface finish—even though it isn't weatherproof. "The oil is used only to finish filling the pores of the wood," Wenig explains, "and we wipe every bit we can from the



surface." Fajen's finishing is labor-intensive: A stock may receive as many as 15 coats, with drying time of 18 hours and scuffing with 500-grit sandpaper between coats.

For a high-gloss finish, the company relies on a product called Fullerplast. The sprayed-on, catalyzed alkyd varnish builds up an abrasion and moisture-resistant, deep-gloss that performs as well in the field as it looks in the gun cabinet. ●

For a copy of Reinhart Fajen's color catalog, send \$5 to:  
Reinhart Fajen, Inc., Box 338,  
Dept. WM, Warsaw, MO  
65355; 816/438-5111.

Written by Robert Settich  
Photographs: Richard Mansur

# SHOWCASE YOUR CHERRY

At first glance, our curio cabinet may seem like a major undertaking. But, if you'll take a good look at the drawings, you'll notice the entire project consists of just four subassemblies that form identical top and bottom cabinets. Come on; give this project a try. We know that you'll be pleased with the results.

## START WITH THE FOUR SIDE FRAMES

*Note:* For ease in construction, the side frames for the top and bottom cabinets match except for the rail placement. For a well-balanced design, we placed the wider rails (C) on the bottom of the bottom frames and along the top edge of the top frames. Study the drawings carefully before beginning construction of the side frames.

■ Cut the side frame stiles (A, B) and rails (C, D) to the sizes listed in the Bill of Materials on page 63.

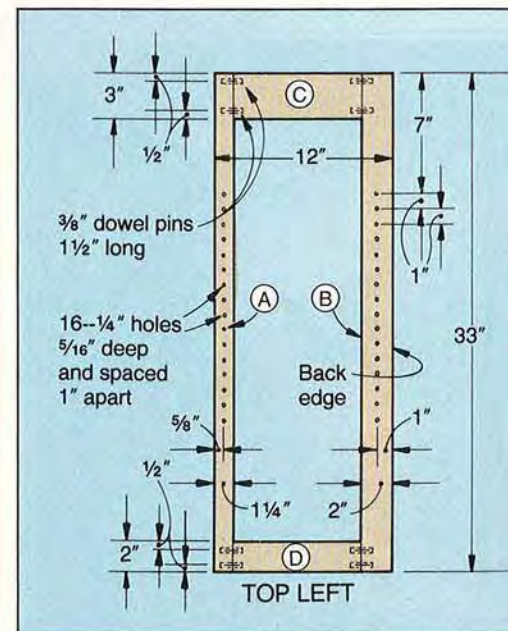

# COLLECTIBLES IN THIS STUNNING CURIO CABINET

**2** Clamp each frame together in the configurations shown on the Side Frames Drawing. Make marks for a pair of dowel holes at each glue joint. Remove the clamps. Using a doweling jig for alignment, drill  $\frac{3}{8}$ " holes  $\frac{13}{16}$ " deep at each mark.

*Note: When working with cherry, immediately remove all excess glue to prevent light-colored marks from appearing after staining. We wiped off all the glue squeeze-out with a damp cloth after clamping.*

**3** Glue, dowel, and clamp each side frame, checking for square.

**4** Mark the center points, and drill the  $\frac{1}{4}$ " shelf holes  $\frac{5}{16}$ " deep where dimensioned on the Side Frames Drawing. Sand the frames smooth.

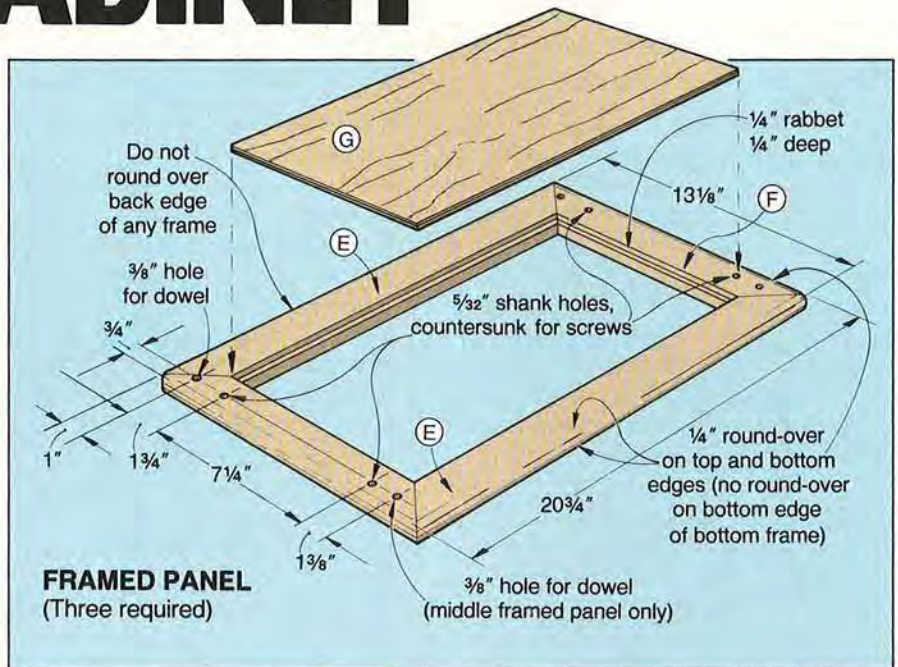

## NOW, BUILD THE THREE FRAMED PANELS

**1** Miter-cut the framed panel fronts and backs (E) and the sides (F) to length from  $\frac{3}{4}$ "-thick stock 2" wide.

**2** Using a dado blade or dado set mounted to your table saw, cut a

$\frac{1}{4}$ " rabbet  $\frac{1}{4}$ " deep along the top inside edge of each frame member.

**3** Using band clamps, glue and clamp each frame together, checking for square. Later, remove the clamps, and sand each of the three frames smooth.

**4** Measure the openings, and cut the insert panels (G) to fit from  $\frac{1}{4}$ " cherry plywood. (See the Buying Guide on page 65 for our source of cherry plywood.) Glue and clamp the insert panels into place.

**5** Rout  $\frac{1}{4}$ " round-overs along the edges of the framed panels where noted on the Framed Panel Drawing. Sand each assembly smooth.

## SIDE FRAMES

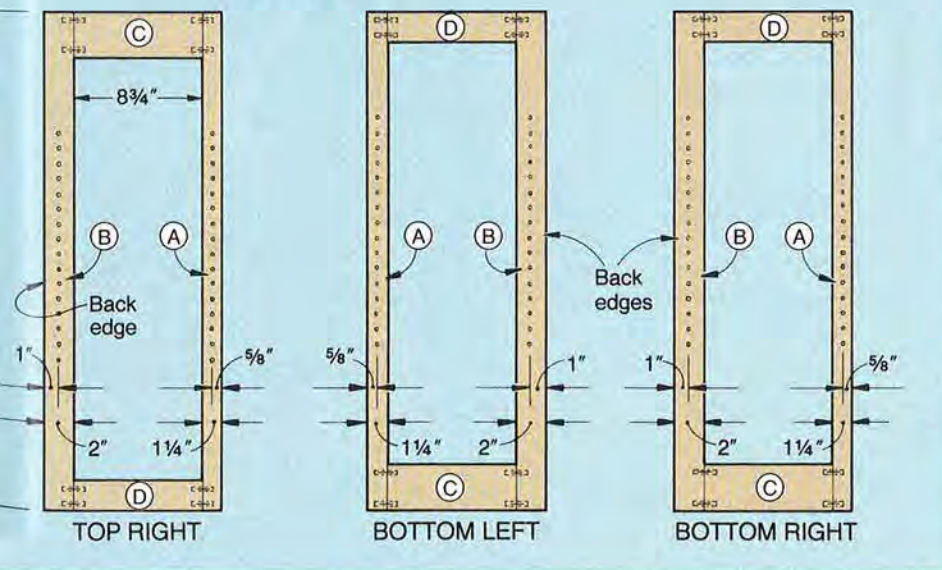

## ATTACH THE SIDE FRAMES TO THE FRAMED PANELS

**1** Using the Framed Panel Drawing for reference, mark center points for the four screw locations on the top face of each framed panel. Drill the  $\frac{5}{32}$ " shank holes. Next, countersink the shank holes in the top and middle framed panels from the *top* side; then, countersink the bottom framed panel from the *bottom* side.

**2** Mark the four dowel-hole center points on the top face of the middle framed panel (see the Framed Panel Drawing for locations). Drill the  $\frac{3}{8}$ " dowel holes where marked.

**3** With the back edges flush, clamp the two bottom frames between

*Continued*

# CHERRY CURIO CABINET

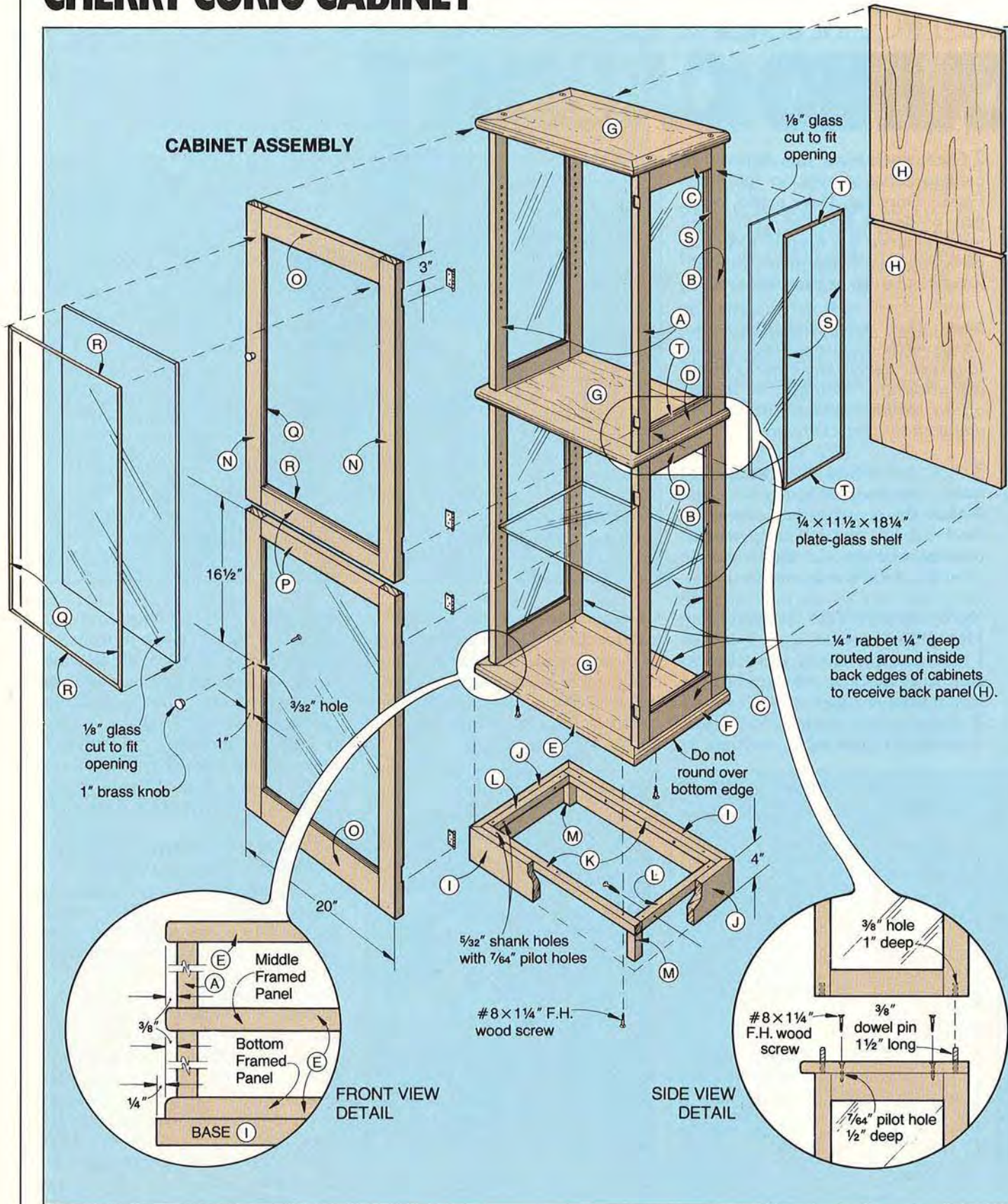



### Bill of Materials

Part	Finished Size*			Materials	Qty.
	T	W	L		
<b>FOUR SIDE FRAMES</b>					
A	¾"	1¼"	33"	cherry	4
B	¾"	2"	33"	cherry	4
C	¾"	3"	8¾"	cherry	4
D	¾"	2"	8¾"	cherry	4
<b>THREE FRAMED PANELS</b>					
E	¾"	2"	20¾"	cherry	6
F	¾"	2"	13½"	cherry	6
G	¼"	9⅝"	17¼"	cherry ply.	3
<b>TWO BACK PANELS</b>					
H	¼"	19"	33½"	cherry ply.	2
<b>BASE</b>					
I	¾"	4"	21¼"	cherry	2
J	¾"	4"	13⅜"	cherry	2
K	¾"	¾"	19¾"	cherry	2
L	¾"	¾"	10⅜"	cherry	2
M	¾"	¾"	3¼"	cherry	4
<b>TWO DOORS</b>					
N	¾"	2"	32⅞"	cherry	4
O	¾"	3"	16"	cherry	2
P	¾"	2"	16"	cherry	2
<b>GLASS STOPS</b>					
Q*	¼"	¼"	27⅞"	cherry	8
R*	¼"	¼"	16"	cherry	8
S*	¼"	¼"	28"	cherry	16
T*	¼"	¼"	8¾"	cherry	16

\*Parts marked with an \* are cut larger initially, and then trimmed to finished size. Please read the instructions before cutting.

**Supplies:** #8×1¼" flathead wood screws, #4×½" flathead wood screws, #18×½" brads, ⅜" dowel pins 1½" long, ¼" plate glass for the shelves, 4—⅜" glass for the side frames, stain, finish.

“With a display case such as this, the focus should be on the items being showcased rather than on their enclosure. That’s why I specified cherry throughout; it has rich-looking, yet subtle grain that’s quite easy to live with. I can certainly see why generations of furniture makers have turned to cherry for their creations.”

*Jim Downing, Design Editor*

the bottom and middle framed panels, checking for square. (See the Front View Detail accompanying the Cabinet Assembly Drawing for frame location.) Using the previously drilled shank holes in the framed panels as guides, drill ⅞" pilot holes ½" deep into the side frames (see the Side-View Detail for reference). Now, remove the clamps, and glue and screw the two side frames between the two framed panels.

**4** Lay the bottom cabinet assembly on its back. Insert dowel centers into the ⅜" dowel holes in the top face of the middle framed panel. Clamp the top side panels in position between the top framed assembly and bottom cabinet assembly to transfer the dowel hole center points onto the bottom edge of the upper side frames. Now, using the previously drilled shank holes in the top framed assembly as guides, drill ⅞" pilot holes ½" deep into the top of the upper side frames.

**5** Remove the top cabinet assembly, and drill the mating dowel holes in the bottom edge of the upper side frames where indented.

**6** Install the dowel pins into the dowel holes in the middle framed panel. Next, glue the top cabinet to the bottom cabinet assembly.

**7** Carefully lay the cabinet face-down on a work surface covered with a blanket to prevent scratching the cabinet. Then, rout a ¼" rabbet ¼" deep around the inside edge of the upper and lower cabinet assemblies for the ¼" plywood back panels (H). Finally, chisel the rounded corners square.

**8** Cut the two back panels (H) to fit the rabbeted openings. Glue and

brad the ¼" back panels into place (we used #18×½" brads).

### CONSTRUCT THE BASE

**1** Miter-cut the exterior base parts (I, J) to size. Now, cut the base cleats (K, L) and glue blocks (M) to size. Drill and countersink screw holes into the cleats.

**2** Glue and clamp the exterior parts together with a band clamp, checking for square. Then, glue and screw the cleats into place flush with the top edge of the exterior base parts. Add the glue blocks, and sand the base smooth.

**3** Set the cabinet upside down on a blanket. With the back edges flush, center the base (also upside down) from side to side on the bottom framed panel. Glue and screw the base to the lower framed panel.

### BUILD THE DOOR FRAMES

**1** Rip and crosscut the door stiles (N) and rails (O, P) to size. Clamp each door frame together and make marks for a pair of dowel holes at each joint line. Then, with a doweling jig, drill ⅜" holes ⅛" deep.

**2** Glue, dowel, and clamp each door frame together, checking for square. Later, remove the clamps and sand the door frames.

**3** Place the cabinet on its back. Check the fit of the doors on the cabinet front. The sides of the doors should fit flush with the sides of the cabinet; plane the edges of the doors if necessary. You also want a ⅛" gap between the top and bottom of the doors and the framed panels. (When fitting the doors we marked one door as “upper” and the other as “lower” for ease in final assembly later.

*Continued*

# CHERRY CURIO CABINET

## CUT AND INSTALL THE GLASS STOPS

**1** Cut nine pieces of  $\frac{3}{4}$ "-thick cherry to  $1\frac{1}{2}$ " wide by  $36$ " long. Rout a  $\frac{1}{4}$ " round-over along all four edges of each piece.

**2** As shown in the two-step drawing below, cut four quarter-round cherry stops from each  $1\frac{1}{2} \times 36$ "-long strip. (We used a push stick for safety when cutting the long, thin stops.)

**3** Starting with one side panel, measure the opening and miter-cut the long glass stops (S) to length.

**4** Construct the jig shown below. Snip the head off a  $18 \times \frac{1}{2}$ " brad and chuck it into your drill. Use the jig to position the stops in the front of the frame. Drill through the stop as shown in the photo below right. Tap a brad into place in the hole just drilled. Fasten the *outside* stops on each side frame and the *front*

stops on both door frames; space the brads about  $7$ " apart. Set the brads, and fill the holes with putty. (You'll need the remaining stops later when installing the glass.)

## HERE'S HOW TO HANG THE DOORS

**1** Mark the hinge locations on the front of the right-hand side frames where shown on the Hinge and Mortise Drawing.

### FORMING THE GLASS STOPS

#### STEP 1

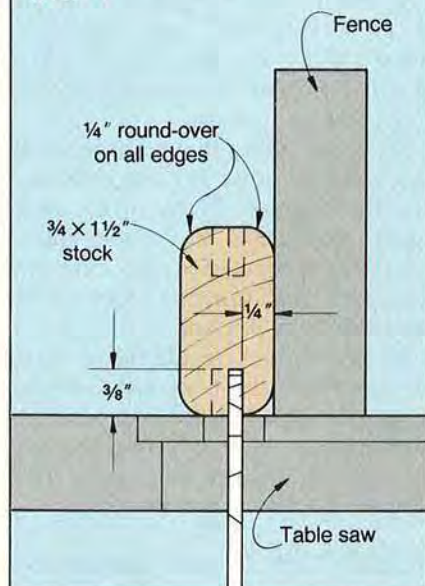

#### STEP 2

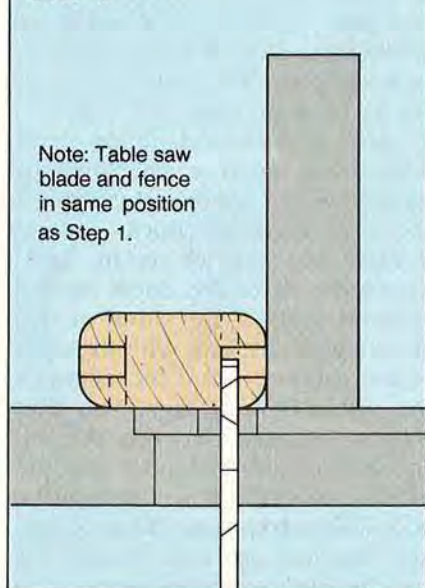

### GLASS STOP POSITIONING JIG

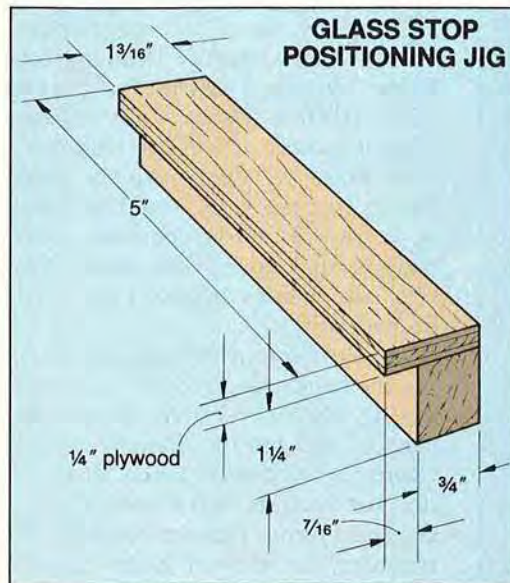

Use the jig to position the glass stops. Then, drill pilot holes and brad the stops into place.

### HINGE AND MORTISE

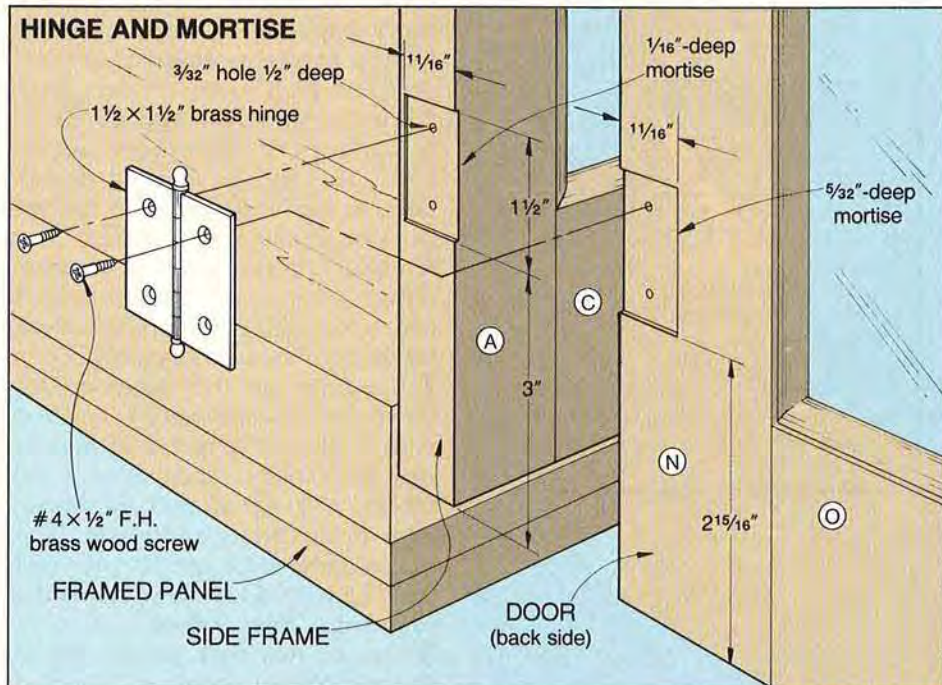

**2** Position the hinge on the marked outline, mark the screw hole locations, and drill the pilot holes.

**3** Screw the brass hinges to the side frames and score their outline into the frames as shown in the photo below. Remove the hinges.

**4** Chuck a  $\frac{3}{8}$ " or  $\frac{1}{2}$ " straight bit into your router. Clamp a piece of scrap stock to the inside edge of one of the side frames, making sure the top edges of the scrap stock and

the frame are flush. The scrap stock helps support and level the router when routing the hinge mortise. Next, routing just *inside* the marked lines, rout  $\frac{1}{16}$ "-deep mortises as shown in the photo below. Use a sharp chisel to finish cutting to the scribed-hinge outline.

**5** Clamp the doors into position in the cabinet front openings, and transfer the hinge locations onto the doors. Remove the doors from

the cabinet, and finish marking the hinge outline. Using the routing and chiseling method just described, rout  $\frac{5}{32}$ "-deep mortises on the back side of each door frame.

## FINAL ASSEMBLY

**1** Measure the openings and order glass cut to size for the four side panels, the two doors, and the three shelves. (We had the glass cut  $\frac{1}{16}$ " less in length and width for the doors and side frames to allow for movement of the wood.)

**2** Locate and drill the holes for the door knobs where shown on the Cabinet Assembly Drawing. Follow the two-step drawing below left to attach the catches and strikes.

**3** Position the glass, and then carefully drill the holes and brad the remaining cherry glass stops to the back side of each glass panel. Set the nails and fill the holes.

**4** Remove all the hardware from the cabinet and doors. Sand the wood parts smooth. Mask off both sides of the glass. Stain the cabinet and doors (we used cherry stain), and apply the finish.

**5** Attach the two doors to the cabinet, place the cabinet against a wall, and add the glass shelves.



Screw the hinges to the cabinet. Next, scribe the hinge locations into the front of the side frame.



Clamp a piece of scrapwood to the front of the side frames for additional support, and rout the hinge mortises.

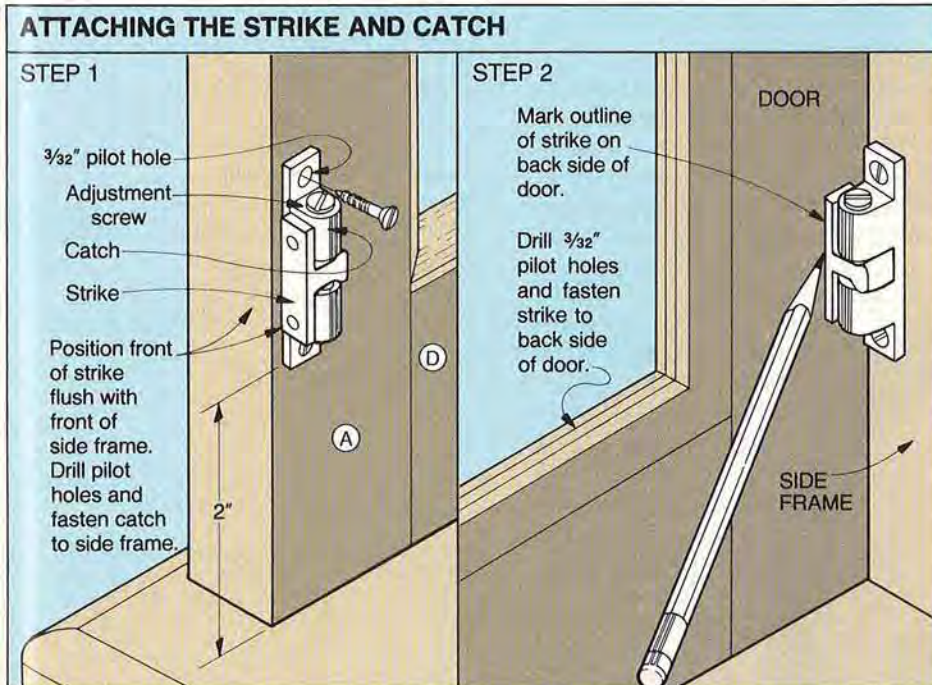

## BUYING GUIDE

• **Hardware.** Two pairs of  $1\frac{1}{2} \times 1\frac{1}{2}$ " solid brass hinges, catalog no. D1910, \$10.95/pair. Brass ball catch, catalog no. D3910, \$2.10 each (two required). Brass shelf supports, catalog no. D5736, 14 cents each (12 required). Brass knobs, catalog no. E1136, \$4.10 each (two required). Add \$3.50 per order for postage and handling. The Woodworkers' Store, 21801 Industrial Blvd., Rogers, MN 55374.

•  **$\frac{1}{4}$ " cherry plywood.** Four pieces  $24 \times 48$ " for parts G and H. \$53 ppd. from The Woodworker's Dream, 510 Sycamore St., Nazareth, PA 18064; 800-247-6931 (in Pennsylvania 215/759-2837). 🌲

Produced by Marlen Kemmet  
Project Design: James R. Downing  
Photographs: Bob Calmer  
Illustrations: Mike Henry, Bill Zaun

*French Curves: Draw smooth curves for scroll saw patterns with these drawing tools.*



*Mechanical Pencil: This 5-mm model picks up where wood pencils leave off and fits the compass shown below.*

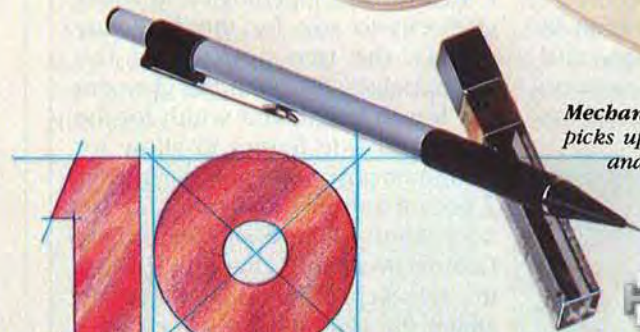

 Print this article

# LAYOUT TOOLS

*No woodworker should be without*

Many woodworking projects call for the woodworker to “mark a radius,” “scribe a circle,” “trace a pattern,” or any number of other operations. And yet, many woodworkers haven’t purchased the drafting tools shown here—items that will increase your accuracy and make marking and measuring chores routine.

**D**raftsmen rely on specialized layout tools to produce top-quality work. In their business, it’s not good enough to be “almost-on.” They’ve got to be exact. And so do woodworkers.

### THE BASIC SEVEN

**Mechanical Pencil.** For precision in tracing patterns and marking cutoff lines, it’s tough to beat the consistent, fine line of a mechanical pencil.  
**Plastic Eraser.** Not all erasers are created equal. Plastic erasers won’t abrade paper or leave a fuzzy line behind. On wood, a plastic eraser gets into the grain without leaving a mark or residue.

**French Curves.** These ingenious tools have nearly all the curves you’ll ever need to enlarge a pattern onto a grid. Just transfer the pattern’s grid intersection points to a larger grid,

and use a french curve to connect the points. We suggest you purchase three sizes—the Alvin 351, 352, and 353 set works well—so you’ll always have the radius you need.

**Adjustable Triangle.** Because this versatile tool adjusts from 0 to 90°, it saves you the cost of buying numerous triangles, while guaranteeing accurate angle cuts every time. We like the Mars Staedtler 6” model for its quality and convenient size.

WOOD® magazine Design Editor Jim Downing knows all about the versatility of this tool. “I keep one in my shop for adjusting the table saw, band saw, radial arm saw, and drill press for precise angle cuts. I



*Compass: This model will also accept an X-acto knife for cutting thin materials, such as paper or veneer.*

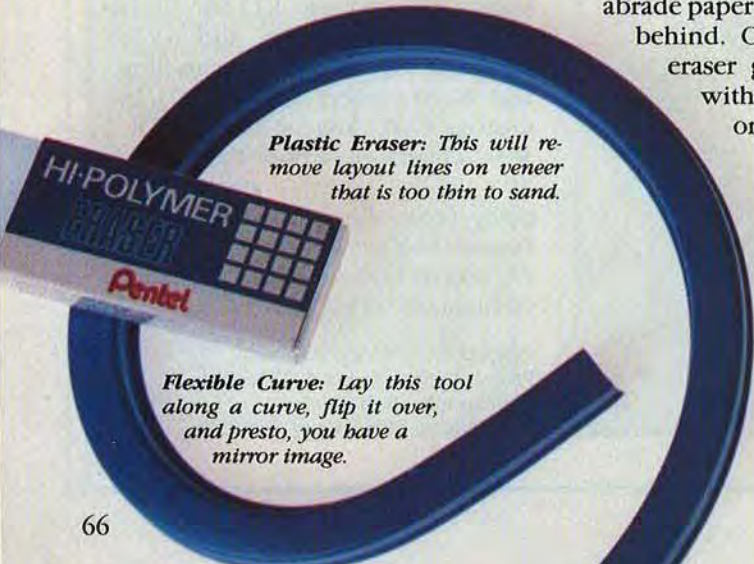

*Plastic Eraser: This will remove layout lines on veneer that is too thin to sand.*

*Flexible Curve: Lay this tool along a curve, flip it over, and presto, you have a mirror image.*

**Protractor:** Adjust a sliding bevel from 90° to 180° with a protractor to set the angle of your jointer fence.

never rely solely on the machine's angle markings."

**Circle Templates.** How many times have you searched for a jar lid to draw a circle? Next time, use a circle template in combination with a mechanical pencil to get premeasured, perfectly round circles. With these two templates, you can make any of 50 different circles from 1/16 to 3".

These make drawing corner radii easy, too. If a plan calls for a 1" radius, select the 2"-diameter circle, nestle it in a corner until two edges make contact, and draw the radius.

**Protractor.** Inexpensive, but handy, a protractor provides an easy and accurate way to set a sliding bevel and check other angles.

You also can use a protractor to divide a circle into segments by dividing the necessary number of parts

into 360° (an entire circle). For example, plot the hours on the face of a clock by dividing 360° by 12; then mark hours every 30° around a circle.

**Parallel Spacer.** Making parallel lines along a straight edge is simple, but this device also allows you to parallel a curve. Place your mechanical pencil in the correct hole, and you can draw a parallel line .025 to .5" (1/40 to 1/2") from any edge.

### THREE NICE-TO-HAVE TOOLS

**Compass.** The Mars Staedtler model we've chosen draws circles up to 14" in diameter.

With a compass, you can create an infinite number of circle sizes and perform many more advanced geometric functions such as dividing an angle or drawing an ellipse.

**Flexible Curve.** You can bend this model to nearly any shape up to 20" long. Because it will retain its shape, you can transfer exact curves easily by lifting the tool and moving it.

**Matte Acetate.** Copy a pattern onto this material as with tracing paper and enjoy these advantages:

- Acetate is more durable and transparent than tracing paper.

- You can use acetate over and over to transfer patterns onto wood surfaces. Just sandwich a sheet of carbon paper between the acetate (on top) and the wood. Follow the pattern with a burnishing point to transfer a carbon image to the wood.

### HOW TO ORDER

The basic kit (mechanical pencil, \$1.98; lead refills, 80¢; eraser, 60¢; adjustable triangle, \$11; three french curves, \$6.50; two circle templates,

**Circle Templates:** The center lines on these tools make it easy to find the center of a dowel.

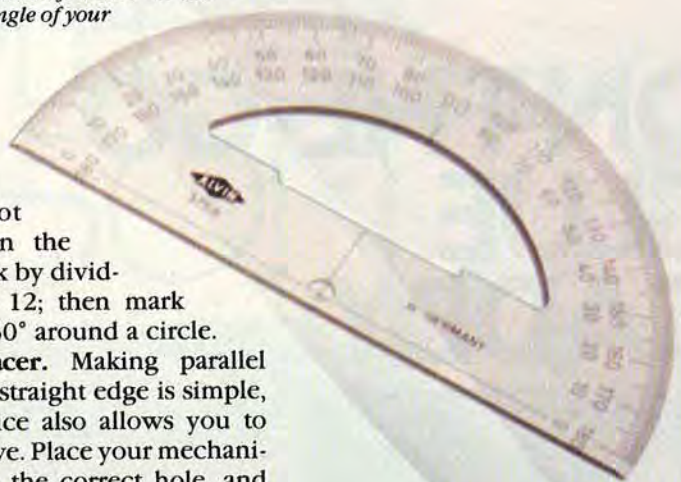

### Matte

**Acetate:** The pad in this kit contains 25 sheets (14x17") of .003-gauge material.

\$8.45; protractor, \$1.25; and parallel spacer, \$2.50—list price of \$33.08) is available to WOOD magazine readers for \$27 ppd.

The deluxe kit (basic kit plus compass, \$11; flexible curve, \$6.50; and matte acetate, \$13—list price of \$63.58) is discounted for WOOD readers to \$54 ppd. To order individual items, add 10 percent for shipping and handling.

Mail your check or money order (VISA and MasterCard also accepted) to the address below, and tell them WOOD magazine sent you. Items shipped via UPS.

Standardblue Artworld  
924 Grand Avenue  
Des Moines, IA 50309  
Phone: 515/288-1927

Written by Bill Krier  
with James R. Downing  
Photograph: Bob Calmer



**Parallel Spacer:** You can expand this tool's use by drilling holes into it for any distance you need (up to the tool's radius).

**Adjustable Triangle:** Get perfect results every time when you measure and transfer angles with this tool.

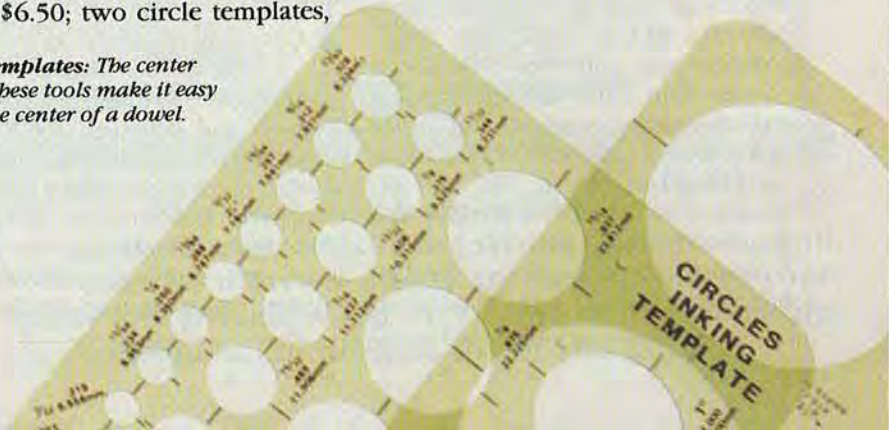



# ON-THE-GO GLUE CADDY



Need to get your shop better organized? If so, there's no better place to start than by making our handy glue caddy. It's a cinch to build, and it won't even put a dent in your scrap pile.

## FORMING THE DISKS

**1** Cut two pieces of  $\frac{3}{4}$ " stock (we used a pine 1x12) to 11" square. If you don't have stock this wide, laminate narrower pieces.

**2** Find the center of one of the squares by marking diagonals. Mark a 10"-diameter circle at the center.

**3** Stick the two squares together, marked circle up, with double-faced tape. Cut the disks to shape.

**4** Arrange your glue bottles and accessories on top of the disks. Trace around each container. (We added 35-mm film canisters for holding cotton swabs, brushes, and other items used to apply glue into those hard-to-get-at places. We also included a foam cup for soaking the glue brushes after each use.)

**5** To prevent drilling into your drill press table, mount a piece of scrap

material to it. Drill a  $\frac{3}{4}$ " hole through the center of both disks. Then, if you plan on using the film canisters as shown in the photograph, switch bits, and drill  $1\frac{1}{4}$ " holes through the first disk and  $\frac{1}{2}$ " deep into the second (we used a Forstner bit). Separate the disks, and remove the tape.

**6** With the  $1\frac{1}{4}$ " bit still chucked to your drill press, drill holes through the top disk for additional film canisters. Now, using a circle cutter or hole saw, bore the larger holes as shown in the photo at *right*. Bore through the top disk and just a fraction into the scrap top mounted to your drill press table. Sand both disks and the openings smooth.

## FINISHING UP

**1** Cut a piece of  $\frac{3}{4}$ " dowel stock  $11\frac{1}{4}$ " long for the handle.

**2** Slide the top disk onto the  $\frac{3}{4}$ " dowel, and position its top face  $7\frac{1}{4}$ " down from the top end of the dowel. Mark the position of the disk (top and bottom) on the dowel. Slide the disk away from the marked lines, and apply glue between the marked lines on the dowel. Now,

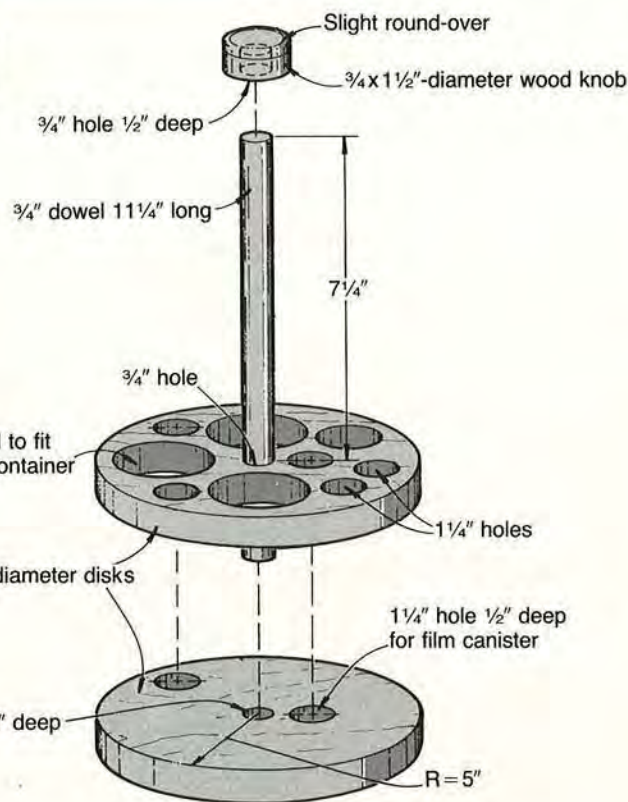

We used a circle cutter for cutting the larger-diameter holes.

slide the disk back onto the glued area, turn it upside down, and run a small bead of glue around the dowel below the top disk. Later, after the top disk is firmly glued in place, glue the dowel into the  $\frac{3}{4}$ " hole in the base disk, aligning the holes in the disks.

**3** Mark a  $1\frac{1}{2}$ " circle on a piece of  $\frac{3}{4}$ " stock for the knob. Bore a  $\frac{3}{4}$ " hole  $\frac{1}{2}$ " deep at the center point. Cut the knob to shape on a band saw, sand smooth, and glue it to the top end of the dowel. Apply a clear finish to all the parts. ♣

Project Design: Jim Boelling

Photographs: Bob Calmer

Illustrations: Kim Downing; Bill Zaun

LOOK  
AHEAD  
TO THE

# HOLIDAY SEASON



This year, take a tip from these busy little elves. Start building your gifts now, and you'll be done in plenty of time to enjoy your family and friends when they come calling. Here are six people-pleasing projects to get you going.

# ROLL OUT THE WHEEL

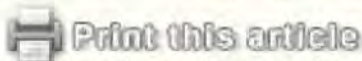

Children have carted everything from sand to dollies in our wee wheelbarrow. In fact, kids don't even mind picking up their playthings when they can push toys back to the toybox in this pint-sized hauler. Grown-ups have found this an excellent display for potted plants, too.

*Note: If you plan to use the wheelbarrow outdoors, we recommend using a slow-set epoxy and an exterior paint for durability.*

## BUILD THE FRAME AND BOX

1 Rip and crosscut two pieces of  $\frac{3}{4}$ "-thick pine to  $2\frac{1}{2} \times 23\frac{1}{2}$ " for the handles (A). Stick the handles together face to face with double-faced tape, keeping the edges and ends flush. Using the dimensions on the Handle Drawing below, lay out the handle outline on one of the pieces. Cut and drum-sand the

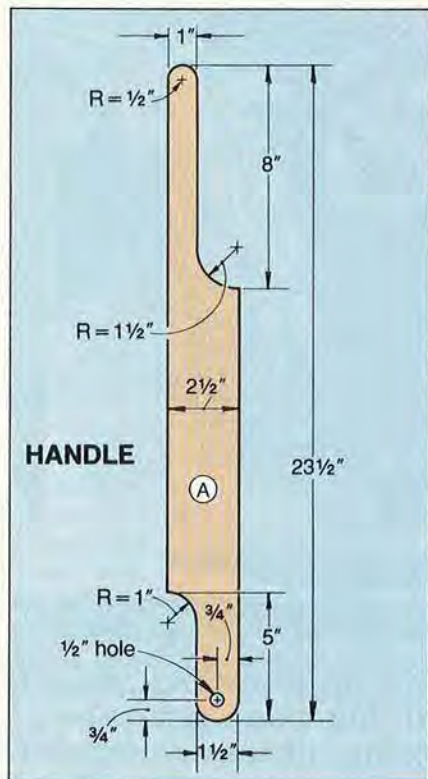

handles to shape. Separate the two handles and remove the tape.

2 Cut a piece of  $\frac{3}{4}$ "-thick pine  $7\frac{1}{2}$ " wide by at least 12" long for the leg brace (B). Tilt your table saw blade  $10^\circ$  from center, and bevel-rip both side edges of the leg brace. Cross-cut the leg brace to finished length ( $7\frac{1}{2}$ "). Rout a  $\frac{1}{4}$ " round-over along the bottom edge of the brace.

3 Using the dimensions on the Leg Brace Drawing, mark the location of the U-shaped opening and handle notches. Cut the opening to shape. To cut the angled notches, mark a line for the notch width ( $\frac{3}{4}$ ") and length ( $2\frac{1}{2}$ "). Align a sliding T-bevel against the  $10^\circ$  bevel cut earlier. As shown in the photo below, use a T-bevel to mark the angle of each notch. Clamp the leg brace in a vise. Cut the notches to shape with a handsaw.

4 Cut the front brace (C) to size, bevel-cutting the ends at  $10^\circ$ . Glue and nail the frame together, using the dimensions on the Exploded-View Drawing to locate the braces.

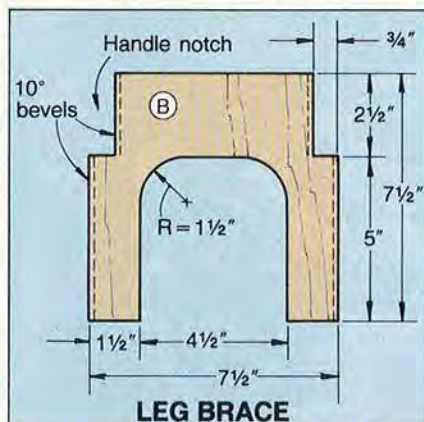

Mark the angled notches on top of the leg brace with a sliding T-bevel.

5 Cut the box bottom (D), front (E), and sides (F) to size. Lay out the 2" radius on the back upper corner of each side piece, and cut both pieces to shape. Glue and nail the box together.

6 Glue and nail the box to the frame, checking that the back edge of the box is flush with the back edge of the leg brace and centered from side to side on the handles.

7 Set the nails, fill the nail holes with putty, and sand smooth.

## FORM AND FIT THE WHEEL

1 To make the wheel (G), cut a  $7 \times 7$ " square from  $\frac{3}{4}$ " pine stock. Mark diagonals to find center. With a compass, mark a 6"-diameter circle on the stock. Now, using a band saw or jigsaw, cut slightly outside the marked outline, and then sand to the line for finished shape.

2 Rout a  $\frac{1}{4}$ " round-over along both of the wheel edges. Bore a  $\frac{9}{16}$ " axle through the wheel center. Cut a  $\frac{1}{2}$ " dowel 2" long for the axle.

3 To minimize chip-out, position a piece of scrap between the handles, and drill the  $\frac{1}{2}$ " axle hole through the handles where located on the Handle Drawing.

4 To enlarge the wheel opening between the handle, position a piece of  $\frac{3}{4}$ "-thick stock against the front of the box and centered between the handles as shown below.



Mark the wheel opening on the top edge of the handle fronts.



# BARROW OF FUN

Mark the wheel opening onto the handle tops.

**5** Using a handsaw, cut the handle fronts where marked to allow wheel clearance. Slip a sanding belt over the  $\frac{3}{4}$ " scrap, and sand between the handle ends as shown *below*. Sand until the wheel and two flat washers fit loosely in the opening.



After cutting, hand-sand the opening to accommodate the washers and wheel.

**6** Finish-sand, and apply a coat of sanding sealer to all the parts. Then, paint or stain as desired.

**7** Later, position the wheel (G) and washers between the handle ends, and nail the axle in place. 🌲

Project Design: Dave Ashe  
Photographs: Bob Calmer, Hopkins Associates

Illustrations: Kim Downing, Bill Zaun

## Bill of Materials

Part	Finished Size*			Material	Qty.
	T	W	L		
A	$\frac{3}{4}$ "	$2\frac{1}{2}$ "	$23\frac{1}{2}$ "	pine	2
B*	$\frac{3}{4}$ "	$7\frac{1}{2}$ "	$7\frac{1}{2}$ "	pine	1
C	$\frac{3}{4}$ "	$2\frac{1}{2}$ "	3"	pine	1
D	$\frac{3}{4}$ "	6"	$9\frac{3}{4}$ "	pine	1
E	$\frac{3}{4}$ "	6"	6"	pine	1
F	$\frac{3}{4}$ "	6"	$10\frac{1}{2}$ "	pine	2
G*	$\frac{3}{4}$ "	6" diameter		pine	1

\*Parts marked with an \* are cut larger initially, and then trimmed to finished size. Read the instructions before cutting.

**Supplies:** double-faced tape, #4 finish nails,  $\frac{1}{2}$ " dowel, two  $\frac{1}{2}$ " brass flat washers, #17x1" brad, wood putty, glue or slow-set epoxy, stain or paint.

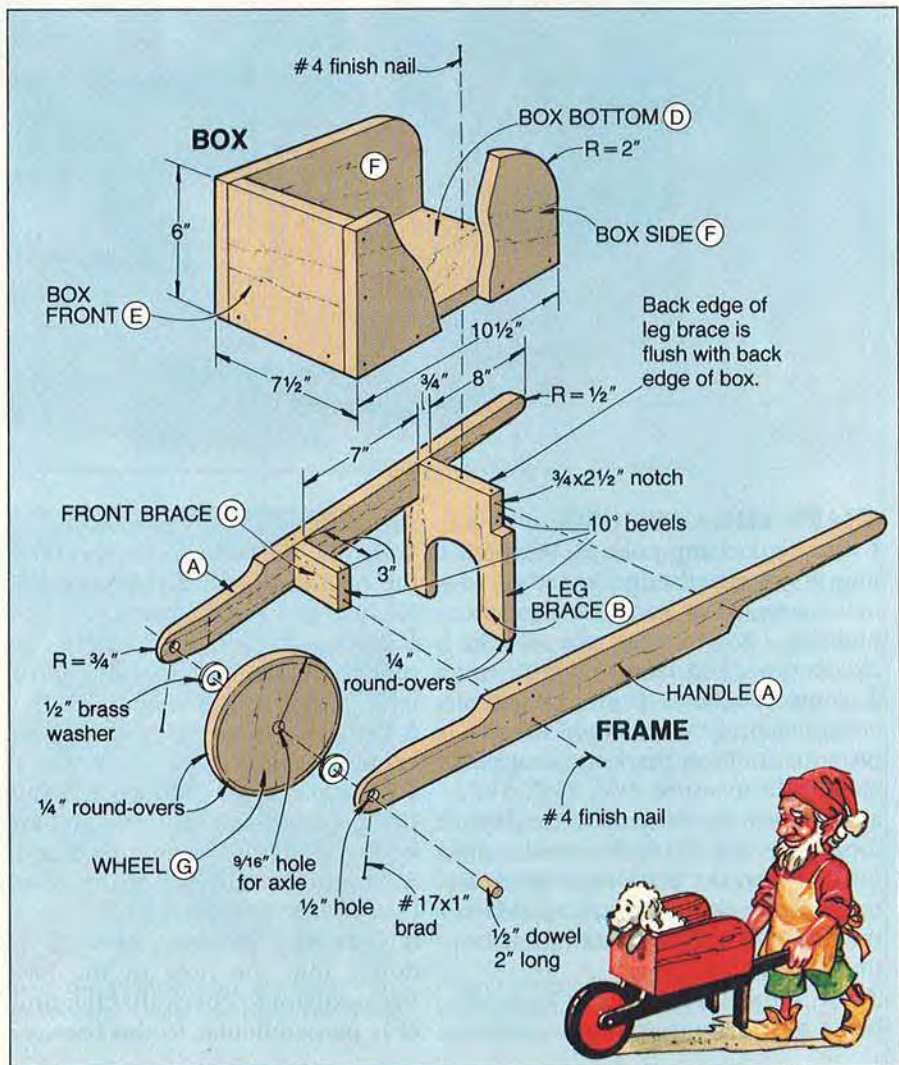
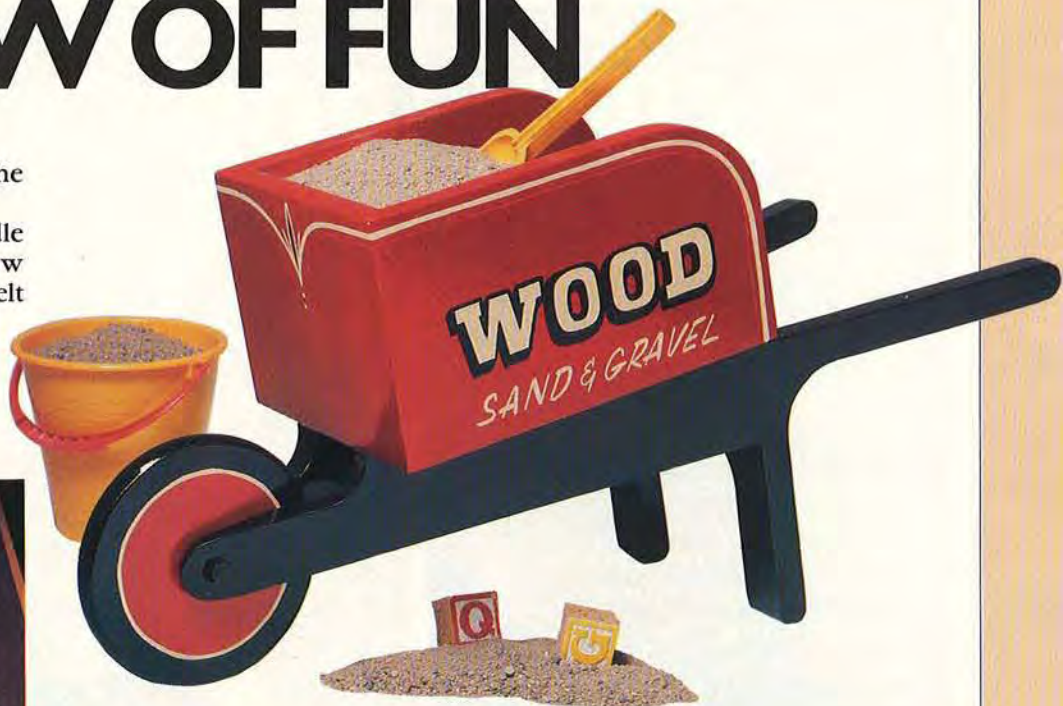

# WHIRLING WORLD OF WILD ANIMALS FANCIFUL ZOO CAROUSEL

Oh my! We don't have any lions, and tigers, and bears. But we do offer a giraffe, zebra, rhino, and elephant to adorn our spinning zoo carousel. Wind the platform by hand and then watch it twirl around and rewind itself time and time again.

**Warning:** This activity may be wonderfully habit-forming for children and adults.

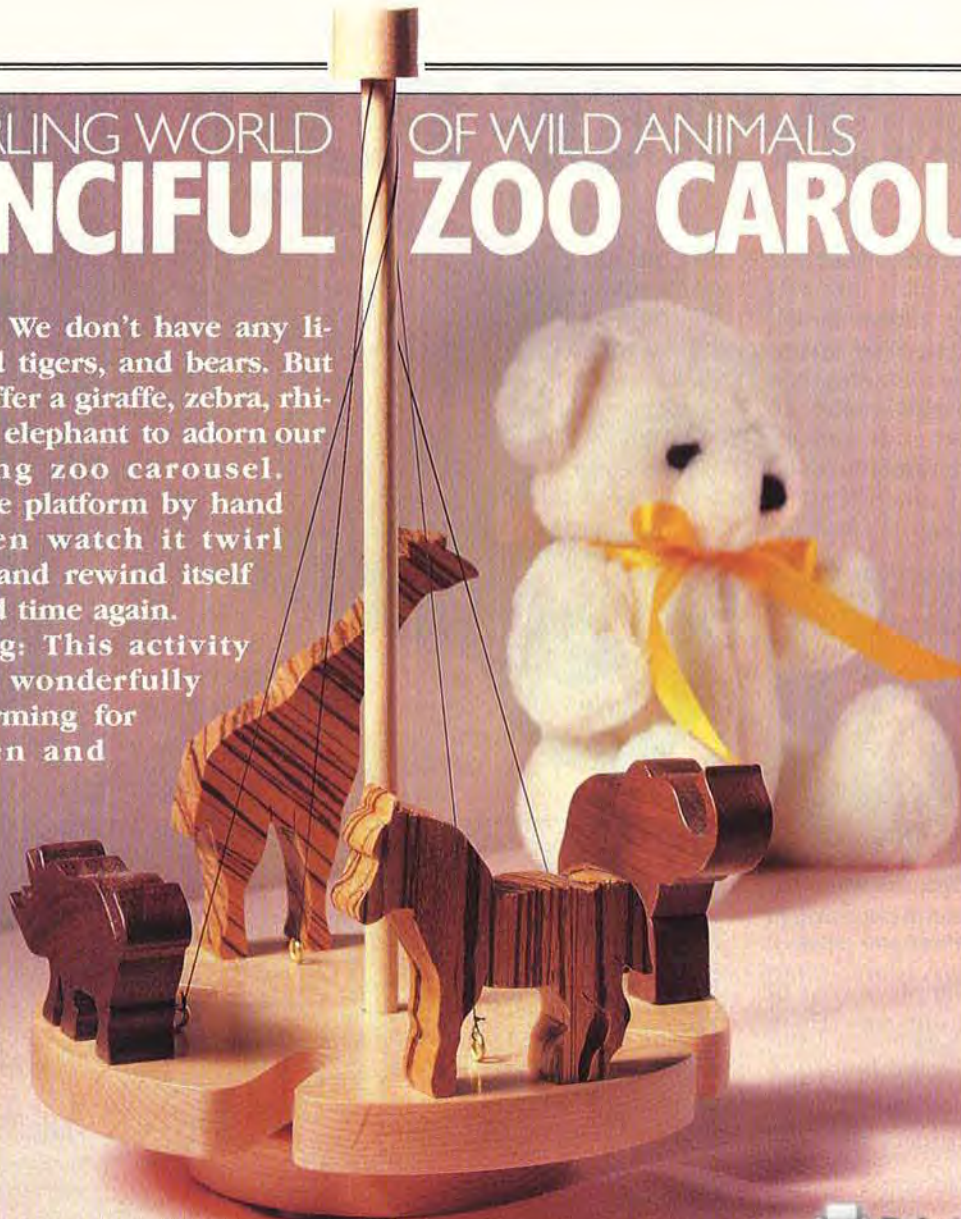

 [Print this article](#)

## SHAPE THE CAROUSEL

**1** Glue and clamp enough  $\frac{3}{4}$ "-thick maple together edge to edge to make a board at least  $9 \times 9$ " for the platform (A). Later, scrape off the excess glue, and trim to  $9 \times 9$ ".

**2** Draw diagonals from corner to corner to find the center of the maple square. Then, mark the four circles (radii measure  $2\frac{1}{4}$ ",  $2\frac{1}{2}$ ",  $3\frac{1}{4}$ ", and  $4$ " where shown on the Platform Drawing. Mark the small radii ( $\frac{1}{4}$ ",  $\frac{3}{4}$ ") on the platform where dimensioned on the drawing. Mark the four screw eye center points on the  $2\frac{1}{2}$ " radius.

**3** Use a band saw fitted with a  $\frac{1}{8}$ " blade to cut the platform to shape.

Drum-sand the curves smooth.

**4** Drill a  $\frac{7}{16}$ " hole in the center of the platform. Drill a  $\frac{1}{16}$ " pilot hole  $\frac{3}{8}$ " deep for each screw eye.

**5** Mark a  $4\frac{1}{2}$ "-diameter circle on a piece of  $\frac{3}{4}$ "-thick maple for the base (B). Cut it to shape.

**6** Drill a  $\frac{3}{8}$ " hole  $\frac{1}{2}$ " deep into the center of the base.

**7** Cut a piece of  $\frac{3}{8}$ " dowel 12" long. Using a band saw, cut two  $\frac{1}{16}$ " saw kerfs  $\frac{1}{4}$ " deep, perpendicular to each other in the end of the dowel (see the Dowel Detail).

**8** Glue the unkerfed end of the dowel into the hole in the base. Use a square to check that the dowel is perpendicular to the base.

**9** To make the knob (C), mark a 1"-diameter circle on a piece of  $\frac{3}{4}$ "-thick maple. Drill a  $\frac{3}{8}$ " hole  $\frac{1}{2}$ " deep at the center of the marked circle. Now, cut the circle to shape. Sand a slight round-over along the top edge of the knob.

## AND NOW, THE ANIMALS

**1** Using tracing paper, transfer the full-sized animal patterns on page 91 to  $\frac{3}{4}$ "-thick stock, noting the grain direction on the patterns. (We used walnut for the elephant and rhino, and zebrawood for the zebra and giraffe for contrast.)

**2** Cut the animals to shape. Sand the band-sawed animal edges.

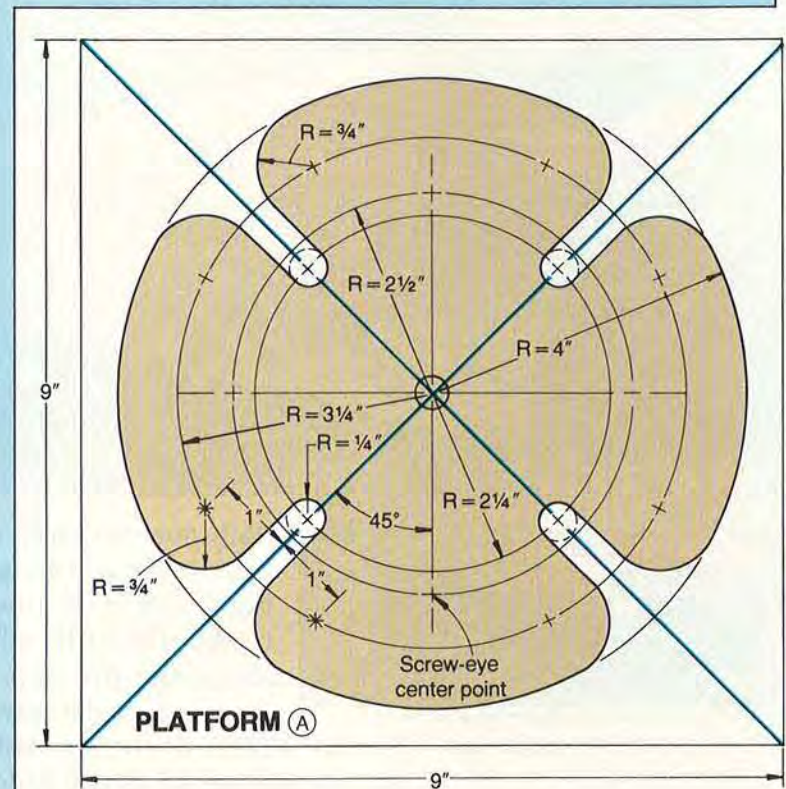
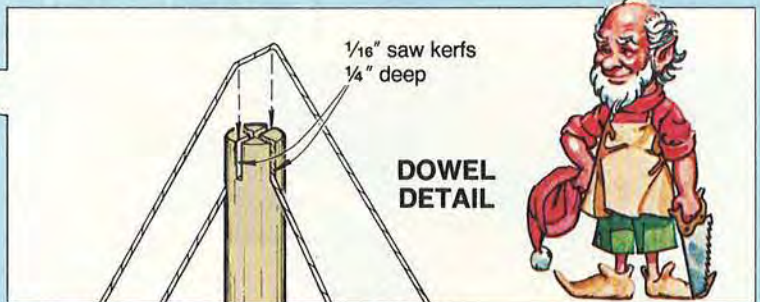
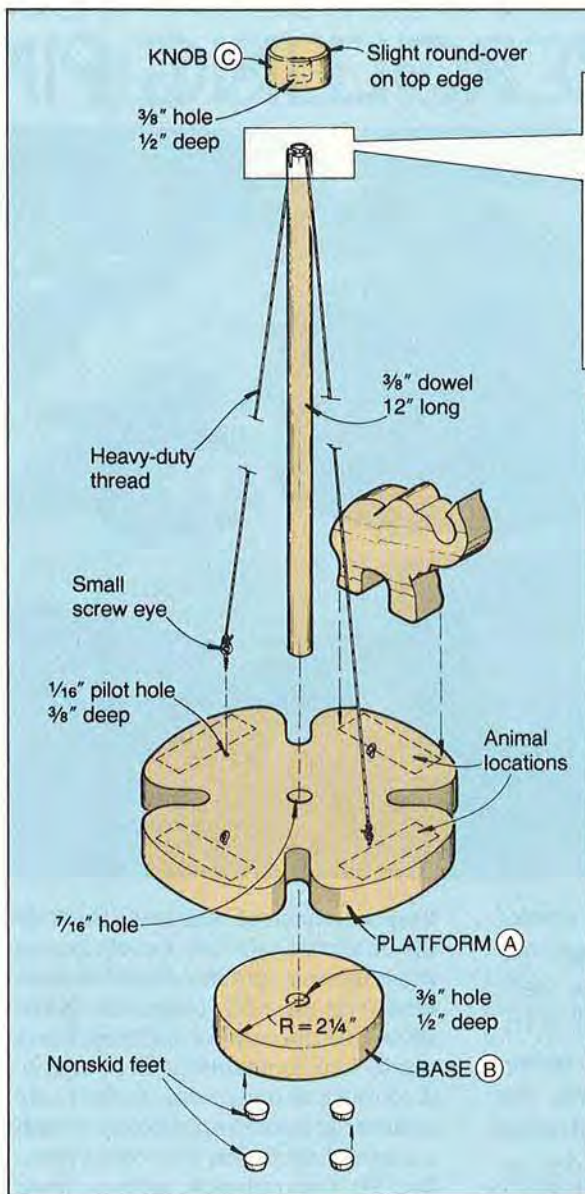

### FINAL ASSEMBLY

**1** Sand all parts of the project. Mix and place a dab of epoxy on the bottom of the feet of all the animals. Position the animals on the platform, and let the epoxy cure.

**2** Apply self-adhesive rubber or cork feet (also called bumpers) to the bottom of the base to prevent the base from slipping when the platform is wound up. Apply finish.

**3** Position two 1/4"-thick spacers on the top of the base, and slide the platform down the dowel onto the spacers. Using heavy-duty thread, tie the thread to one screw eye. Pull the thread through a saw kerf in the top of the dowel, snug it up,



Support the platform on the base with scrap spacers. Hang the platform from the center dowel.

and tie it to the opposite screw eye. As shown in the photo at left, repeat for the second thread, keeping an equal tension on both threads.

**4** Remove the spacers, and add the knob to the top of the dowel. Rotate the platform several revolutions and let it twirl. After you're done playing with it, call the kids.

**Supplies:** 4-small screw eyes (we used Stanely 8450-212 1/2 eyes, 1 3/16" long with a 3/16" inside eye diameter), heavy-duty thread or nylon fishing line, nonskid feet. 🪵

Project Design: William Warrick  
Photographs: Bob Calmer, Jim Kascoutas  
Illustrations: Kim Downing, Bill Zaun

# YOU'LL BE ROLLIN' IN THE DOUGH WITH OUR TURNED ROLLING PIN



Roll out pastries, cookies, or bread dough in high style with this hefty maple rolling pin adorned with easy-rotating walnut handles. As an added bonus, build our wall-mounted maple holder to display your lathe skills and keep the rolling pin within arm's reach.

*Note: You'll need thick stock to make this project. You can either laminate thinner stock to the sizes listed in the Bill of Materials or use the Buying Guide on page 76. We've called the folks at Constantine's, and they've put together a rolling-pin kit for you.*

## ROUGH-SHAPE THE BARREL

- 1 Cut a 3x3" maple turning square to 11½" long for the barrel (A).
- 2 Mark diagonals on each end of the barrel to locate centers. On one end, draw a 2¾"-diameter circle.

Remove most of the stock *outside* the marked circle by bevel-ripping the edges using a table saw with its blade set at 45°. (Use the circle drawn on the end of the barrel as a guide when trimming the waste.)

3 Remove the spur center from the lathe headstock, and replace it with a chuck fitted with a ½" brad-point bit. Fit the tailstock with a cone center. Move the tailstock next to the barrel, and align the marked center point on the end of the barrel with the brad-point bit. Using a handscrew clamp, clamp the barrel level as shown below.



Drill a ½" hole 2½" deep centered in each end of the maple barrel.



# AND STORAGE RACK

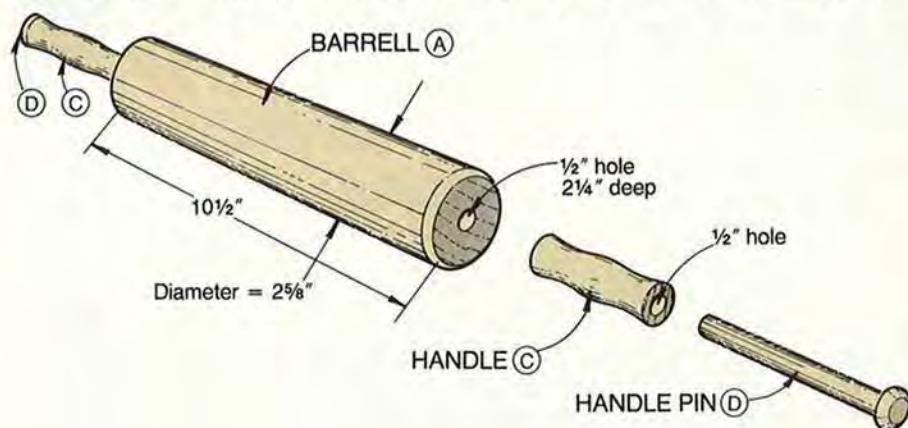

Bill of Materials					
Part	Finished Size*			Materials	Qty.
	T	W	L		
<b>ROLLING PIN</b>					
A*	2 5/8" diam.	10 1/2"		maple	1
B	3/4"	3/4"	2 3/4"	hardwood	2
C*	1 1/8" diam.	4"		walnut	2
D*	1 1/8" diam.	6 1/4"		maple	2
<b>STORAGE RACK</b>					
E	3/4"	2 5/8"	18"	maple	1
F	3/4"	2 5/8"	3 1/4"	maple	2

\*Parts marked with an \* are cut larger initially, and then trimmed to finished size. Please read the instructions before cutting.  
Supplies: nontoxic finish.

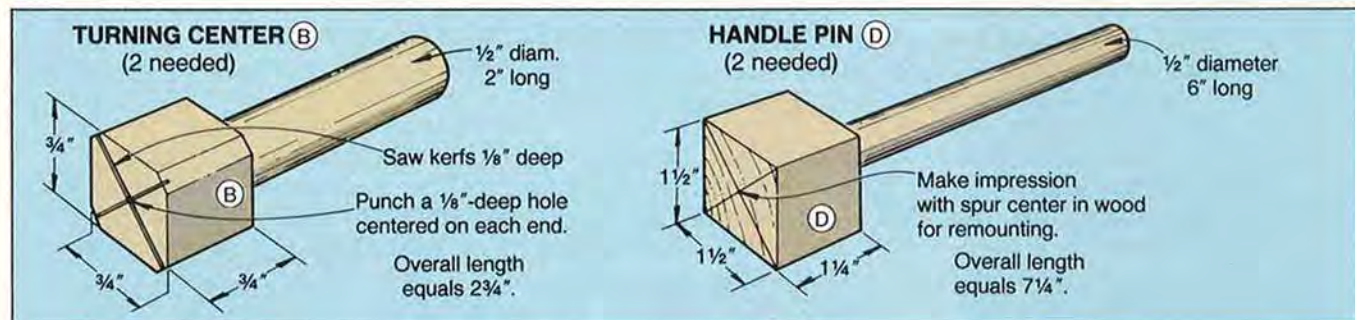

**4** With the lathe set at its slowest speed, drill a 2 1/2"-deep hole in the barrel. You'll need to turn the lathe off periodically, remove the shavings, and then resume drilling. (We wrapped tape on the bit to ensure drilling to an accurate depth.) Turn the barrel-clamp assembly around, and fit the hole just drilled onto the cone center. Check that the bit aligns with the marked center point, and drill a second 2 1/2"-deep hole. Set the barrel aside for now.

## MAKE 2 TURNING CENTERS

**1** Cut two pieces of 3/4" hardwood to 3/4" square by 2 3/4" long for the turning centers (B). Mark diagonals on both ends of each piece to locate centers. On *one* end of each turning center, cut kerfs 1/8" deep along each marked diagonal with a hand saw. Punch a hole about 1/8" deep in the center of each end of each turning center with an awl or center punch.

**2** Mount one of the turning centers between centers on the lathe, and turn the stock to the shape and size

shown on the Turning Center Drawing. Now, sand the shank portion of the turning center to 1/2", checking the diameter often with an outside caliper to make sure you end up with a snug fit in the 1/2" hole in the barrel. Repeat for the second turning center.

## FINISH-TURNING THE MAPLE BARREL

**1** Push the turning centers into the holes in the barrel. Mount the assembly between centers. Start the lathe, and turn the barrel to a cylinder 2 5/8" in diameter.

**2** Trim each end of the barrel with a parting tool for a finished-barrel length of 10 1/2". Be careful to stop the cut once the parting tool makes contact with the turning center.

**3** Using a sanding block, sand the barrel to remove any waviness. Sand the ends smooth, sanding a slight round-over on the corners.

**4** Apply a liberal coat of cooking oil to the barrel, and let the oil soak in for a few minutes. Wipe off any excess oil with a clean rag. Turn

your lathe on, and polish the barrel to a high luster by holding a clean white rag against the wood. Repeat with a second coat of oil.

## SHAPE THE WALNUT HANDLES AND MAPLE PINS

**1** Cut two pieces of 1 1/2"-thick walnut to 1 1/2" wide by 4 1/8" long for the handles (C). Mark diagonals on each end of each handle to locate centers. Clamp one of the handle blanks in a handscrew clamp. Check that the handle blank is square with the drill press table. Then, center and drill a 1/2" hole through the length of each handle. (To keep the bit from wandering, we used a brad-point bit.)

**2** Cut two pieces of 1 1/2"-thick maple to 1 1/2" wide by 7 1/4" long for the pin blanks (D).

**3** Mount one of the pin blanks between centers, and mark a reference line 1/4" from the headstock end. Turn the pin to the shape shown *above*. Spot-glue one of the handle blanks onto a handle pin (we used hot-melt glue).

*Continued*

# ROLLING PIN AND STORAGE RACK

**4** Mount the handle and pin assembly between centers using the marks on the drive center and pin to locate their original position. Turn the handle to the shape shown on the Handle Drawing *below*. True up the end of the handle nearest the tailstock. Sand the handle, and apply an oil finish.

**5** Separate the handle from the pin by cutting the glue joint with your parting tool. Stop the cut as soon as you cut through the walnut.

**6** Remove the handle from the pin and remount the handle pin between centers. Sand the handle-pin shaft so the handle will turn easily on the pin shaft. (We stopped the lathe several times to check the fit of the handle on the handle pin.) Shape the end of the handle pin where shown on the Exploded-View and Handle drawings.

**7** Place the handle on the pin, and remount them between centers.

Sand the head of the pin to the same diameter as the end of the handle (see the Handle Drawing). Finally, use your skew to cut the pin free. Sand the rounded end of the pin smooth.

## FINAL ASSEMBLY

**1** Apply oil to the inside of the hole in each handle (C) and to the ends of the handle. Apply oil to all but the 2" of the pin (D) that will be glued into the barrel.

**2** Spread a light coat of glue in the holes in the barrel (we used a cotton swab). Slip the handles on the pins, and carefully tap the pins in place, leaving just enough play for the handles to turn freely. Immediately back out slightly if too tight.

## BUILDING THE MAPLE STORAGE RACK

We were so impressed with the good looks of the rolling pin, we

decided to add a wall-mounted storage rack. To make the maple rack, cut the back (E) and supports (F) to the sizes listed in the Bill of Materials. Mark the radii on the back piece, and cut it to shape. Now, mark the location, cut two dadoes, and drill the holes in the back where shown on the Storage Rack Drawing *below*. Use carbon paper to transfer the full-sized pattern onto the two support pieces (F). Cut the supports to shape, sand smooth, and glue them into the dadoes. Finish-sand, apply the finish, and hang.

## BUYING GUIDE

• **Rolling pin kit.** 1½x1½x12" walnut, 3x3x12" maple, 1½x1½x18" maple. Kit no. WD988, \$10.50 ppd.. Constantine's, 2050 Eastchester Rd., Bronx, NY 10461. To order, call 800-223-8087 (800-822-1202 in New York).

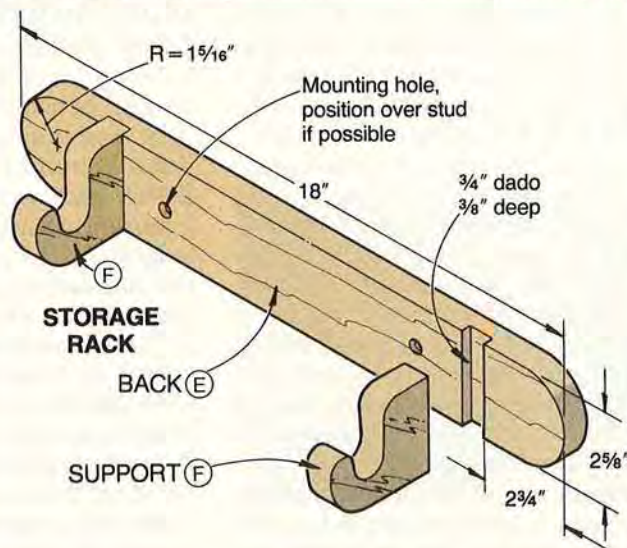
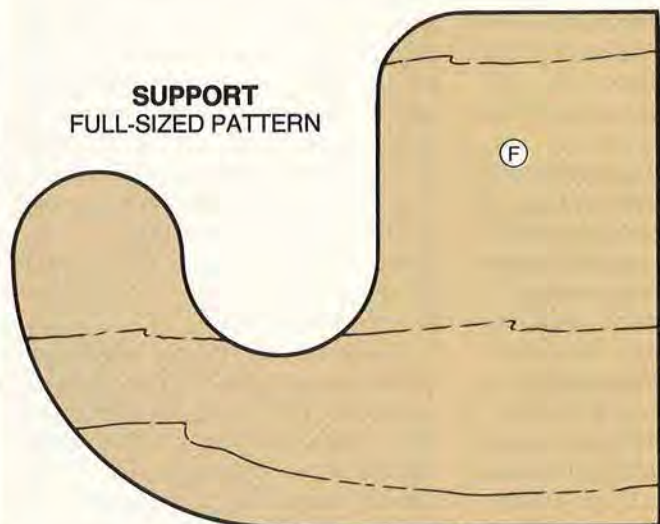
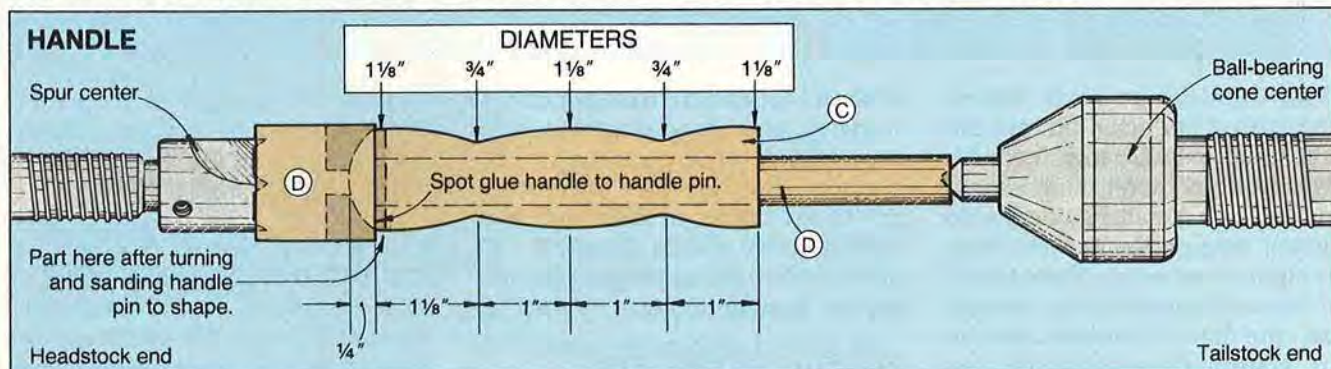

Project Design: Walt Becker

Photographs: Hopkins Associates

Illustrations: Mike Henry, Bill Zaun

# HERE'S A "ONE-TWO COMBINATION" THAT'S A REAL KNOCKOUT

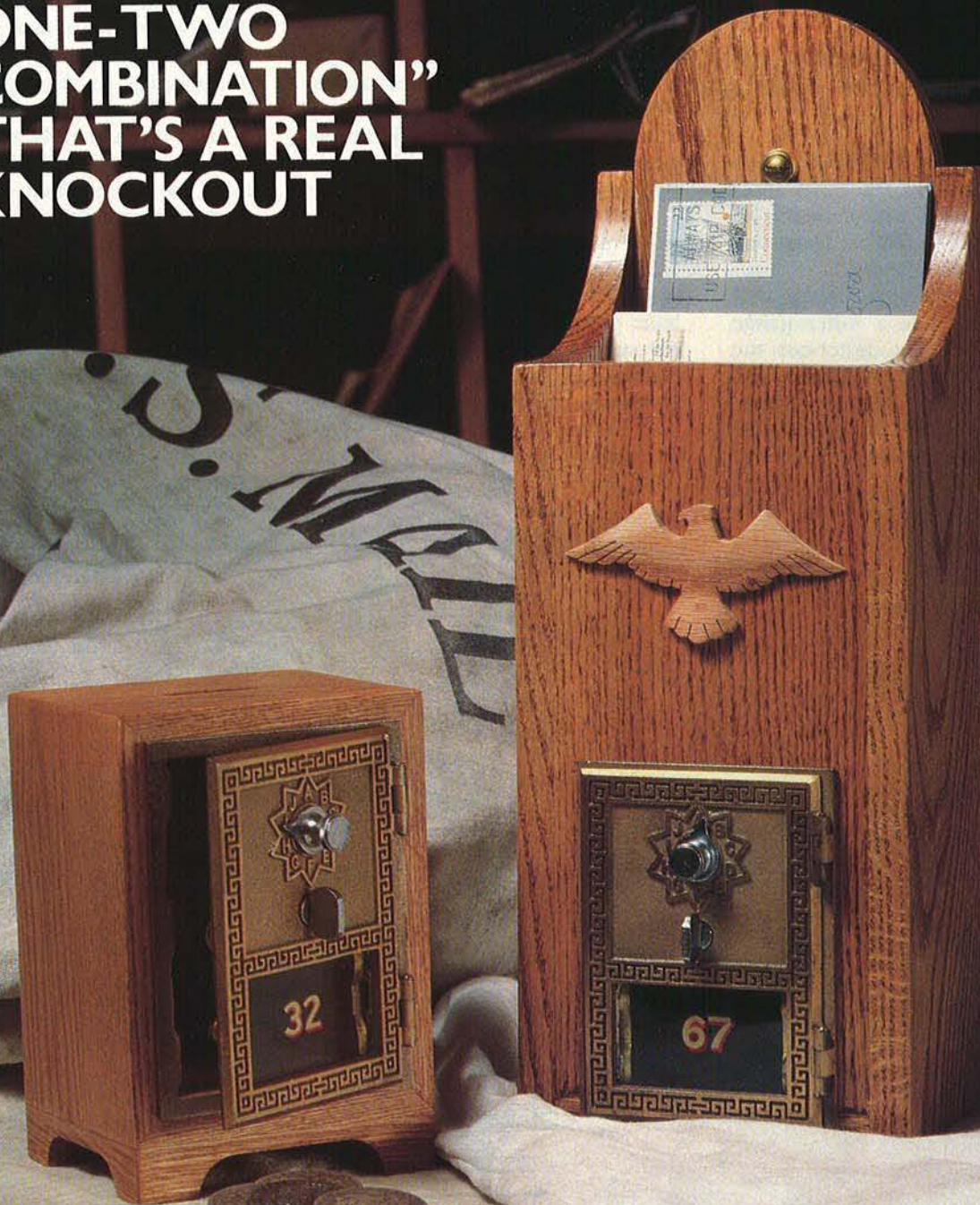

Refurbished post office lockbox doors add just the right amount of nostalgia to these handsomely useful projects. On the following two pages, we'll show you how to build the safe and letter box.

 [Print this article](#)

# THE MINI SAFE A PROJECT YOU CAN BANK ON

Kids will love saving for tomorrow in an oak safe highlighting one of yesteryear's treasures—a genuine brass lockbox door. The restored brass door—salvaged from one of America's post offices—comes complete with a working combination.

## FIRST, MAKE A BASIC BOX

**1** Cut a piece of 1/2"-thick oak to 4" wide by 24" long. Cut or rout a 1/4" groove 1/4" deep and 1/4" from one edge of the oak strip.

**2** Tilt your table saw blade 45° from center. Using a miter gauge fitted with a fence, miter-cut the sides (A) and top and bottom (B) to length from the 24"-long strip

**3** Using the dimensions on the drawing, mark the slot on the top

face of the top piece (B). Drill a 1/4" hole at each end of the slot. Using a 3/16" bit, drill out the waste material between the two 1/4" holes. Then, chisel the slot to shape, or cut it to shape with a scroll saw.

**4** Cut the box back (C) to size from 1/4" oak or lauan plywood.

**5** Glue and clamp the box assembly together. (We used masking tape to hold the mitered joints together, and then pulled the joints tight with a band clamp.)

## ADD A BASE

**1** Cut a piece of 1/2"-thick oak to 3/4" wide by 24" long. Miter-cut the base pieces (D, E) to length from the strip. Mark the opening on the four pieces to form the feet where shown on the drawing below.

**2** Cut the base pieces to shape. (We cut ours on a band saw fitted with

a 1/8" blade.) Sand the rounded corners smooth with a 1"-diameter drum sander.

## PUTTING IT ALL TOGETHER

**1** Glue and clamp the base pieces to the bottom of the box.

**2** Position the door and drill 3/8"-deep holes in the opening. The holes will be slightly angled.

**3** Sand the assembly smooth. Stain and finish as desired. Screw the door in place. Then, empty your pocket change into the bank.

## BUYING GUIDE

• **Post office lockbox door.** Grecian style with two-digit decal. Reconditioned doors shipped with three-letter combination. \$19 ppd. for one door, \$36 ppd. for two. Streeter Company, P.O. Box 241, Sturgeon, MO 65284.

Part	Finished Size			Material	Qty.
	T	W	L		
A	1/2"	4"	4 1/2"	oak	2
B	1/2"	4"	4 3/16"	oak	2
C	1/4"	3 5/8"	3 15/16"	oak ply.	1
D	1/2"	3/4"	4 3/16"	oak	2
E	1/2"	3/4"	4"	oak	2

**Supplies:** #4x3/8" flathead wood screws, stain, finish.



# BILL BOX AND KEY KEEPER THE RIGHT COMBINATION

Staying organized in this day and age isn't easy. But with this project, you'll at least know the whereabouts of those ever-present bills, and be able to keep track of otherwise-elusive car keys that always seem to wander off.

*Note: See the Buying Guide on the opposite page for our source of refurbished lockbox doors.*

## CUT AND ASSEMBLE THE LETTER BOX

- 1 Rip and crosscut the back (A), front (B), two sides (C), shelf (D), and bottom (E) to the sizes listed in the Bill of Materials.
- 2 Mark, cut, and a 2¼" radius on the top of the back piece. Rout a ⅜" round-over on the top back edge of the front piece.
- 3 Using a try square, mark the door-opening location on the front

piece, and cut it to shape. Check the fit of the door in the opening.

- 4 Using double-faced tape, fasten the two side pieces (C) together face to face with the edges flush. Mark a 2¾" radius on one piece where dimensioned on the drawing, and cut and sand both pieces to shape. Remove the tape.
- 5 Mark the location, and cut a ½" rabbet ¼" deep along the bottom edge of the back (A). Using the dimensions on the drawing, mark the locations and cut a ½" dado ¼" deep in the front and back pieces. Check the fit of the shelf and bottom in the dadoes and rabbet.
- 6 Mark the location and drill pilot holes for the two cup hooks and two mounting holes for attaching the box to the wall after assembly.
- 7 With the bottom edges of the sides and back flush, glue and clamp them together. (We positioned the shelf and bottom in place to hold the assembly

square.) Glue and clamp the shelf, bottom, and front to the assembly.

- 8 Transfer the eagle pattern below to ¼" oak stock, and cut it to shape. (We planed down a piece of ½" stock for the ¼"-thick eagle.)

## NOW, MOUNT THE DOOR AND ADD THE FINISH

- 1 Sand the box smooth. Hold the bronze door in place, and drill the angled pilot holes in the opening in the front piece. Remove the door.
- 2 Stain and finish the box. Mount the door and hang the box, centering it over a stud if possible.

*Note: If you don't want to use the combination each time you open the door, remove the lock mechanism from the back of the door. Then, remount the dial.*

Project Design: Sam Criswell  
Photographs: Jim Kascoutas  
Illustrations: Kim Downing, Bill Zaun

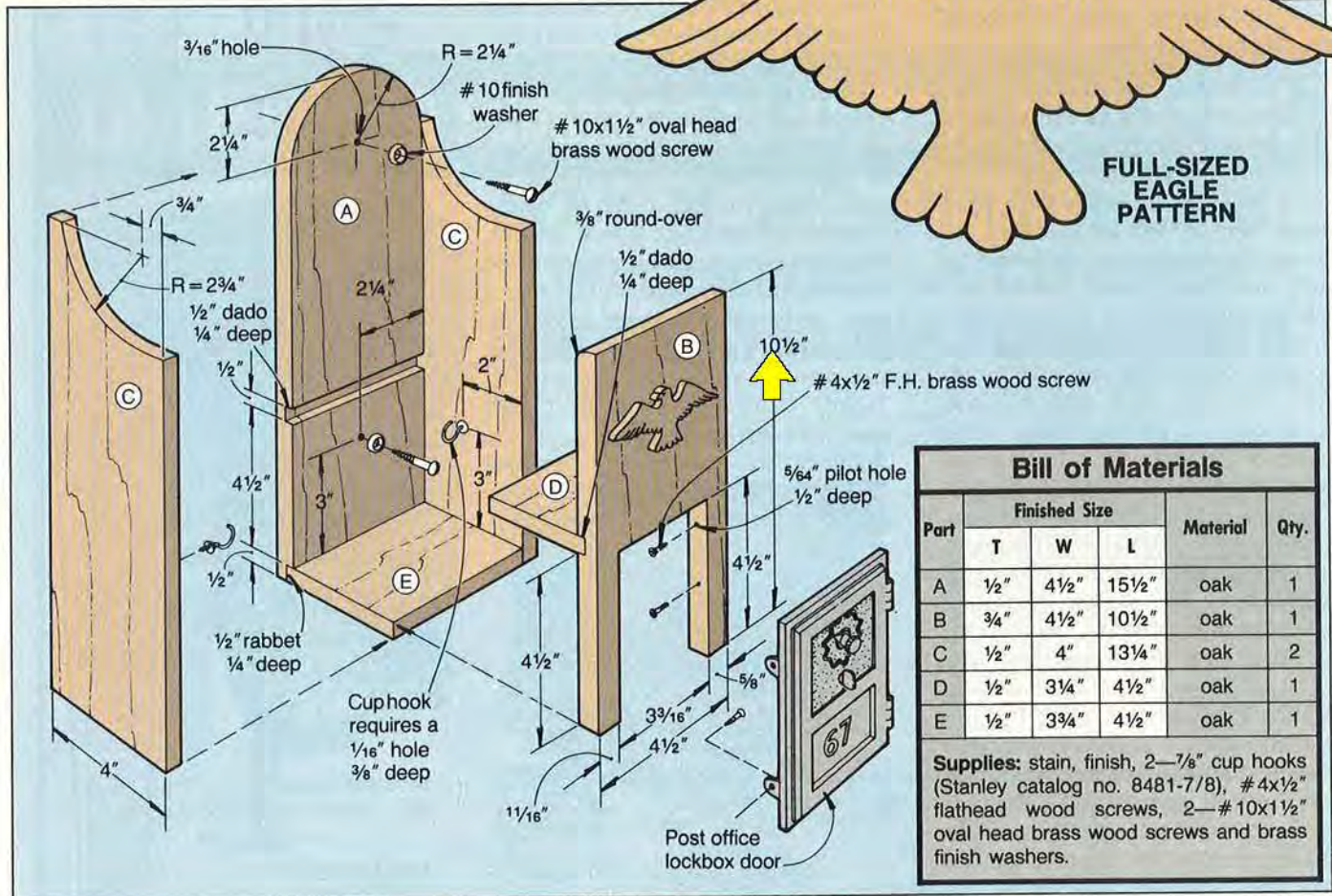

Part	Finished Size			Material	Qty.
	T	W	L		
A	1/2"	4 1/2"	15 1/2"	oak	1
B	3/4"	4 1/2"	10 1/2"	oak	1
C	1/2"	4"	13 1/4"	oak	2
D	1/2"	3 1/4"	4 1/2"	oak	1
E	1/2"	3 3/4"	4 1/2"	oak	1

**Supplies:** stain, finish, 2—7/8" cup hooks (Stanley catalog no. 8481-7/8), #4x1/2" flathead wood screws, 2—#10x1/2" oval head brass wood screws and brass finish washers.

# A FUN-TO-DO FREE-FORM WOOD SCULPTURE HANDCRAFTED CATTAILS AND REEDS



If you're looking for a one-of-a-kind project, you just can't miss with these cattails and reeds. Strips of birch veneer and lengths of  $\frac{1}{2}$ " and  $\frac{1}{8}$ " dowel combine to make one interesting arrangement. Use it as a centerpiece or decorative accessory.

## MAKING THE CATTAILS

*Note: The number of cattails and reeds will depend upon the size of arrangement desired.*

**1** Cut 2"-long pieces from  $\frac{1}{2}$ "-diameter dowel stock for the fruit spikes. You can use walnut dowel stock, or try birch and stain it later.

**2** To drill the holes in the fruit spikes, use an awl to make an indentation centered on each end of each dowel segment. Drill a  $\frac{1}{2}$ " hole  $\frac{1}{2}$ " deep through a scrap piece of 2x4 stock. Insert a fruit spike in the hole, center it under a  $\frac{1}{8}$ " brad-point drill bit, and drill  $\frac{1}{2}$ " into each end of each spike. (We clamped the spike in a handscrew clamp to prevent it from turning.)

**3** To round the ends of the spikes, hold a dowel segment at an angle against a belt or drum sander and rotate the spike. Adjust the angle and continue sanding. Repeat for the other end. Hand-sand smooth.

**4** Cut  $\frac{1}{8}$ " dowel stock to  $9\frac{1}{2}$ " long for the stem and 1" long for the stem tip. Sand a point on one end of each stem tip. For easy insertion into the fruit spike, sand a chamfer on the bottom end of the stem tip and top end of the stem. Glue the stem parts into the fruit spikes.

## SHAPING THE REEDS

**1** Cut  $\frac{3}{4}$ "-wide strips  $10\frac{1}{4}$ " long from birch veneer. (We used a utility knife to cut the  $\frac{1}{28}$ " veneer.)

**2** Hold 3 strips together face to face, and sand to shape (we used a belt sander clamped in a vise). See the full-sized reed pattern at right.

**3** Immerse seven (that's all the jig will hold) of the reeds in water, and let them soak for 2 hours. While the reeds soak, construct the twisting jig shown below. One at a time, twist the wet strips into position in the jig as shown below. Let the veneer strips dry overnight. Lightly hand-sand each reed (we used 220-grit sandpaper).

**4** Repeat the soaking and bending procedure with more strips, twisting them in the opposite direction

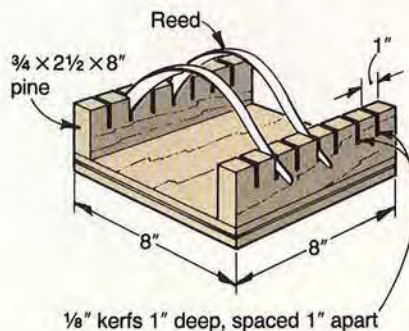

so that the completed veneer reeds curve in different directions.

**5** Leave the cattails and reeds unfinished or spray on a clear finish (we used Deft aerosol lacquer). For a more colorful effect, you might try painting the reeds with a light-green watercolor. 🌿

Project Design:  
D. A. Callaway



FULL-SIZED  
REED  
PATTERN

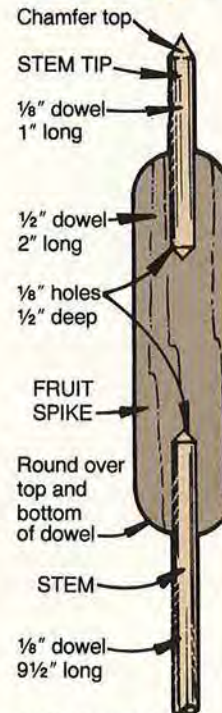

FULL-SIZED  
PATTERN

**NEW**  
from  
Penn State  
Industries... a  
supplier of quality products  
for over 40 years

**Professional quality, precision . . .  
Super 15" Scroll Saw**

Comparable value over \$500  
Only ~~\$199.95~~ shipped complete ready to run

**ON SALE  
\$129.95**

This versatile machine makes cutting intricate wood patterns easy — great for making toys, jewelry, puzzles, fretwork, etc. The blade is driven on both up and down stroke with a smooth cutting parallel rocker arm system. This system avoids blade breakage and creates a smooth finish that virtually eliminates sanding. Our saw is easy to use and is made with a cast construction that insures durability. We fully support our product with replacement parts and repairs if needed. Thousands of satisfied customers use our saw world-wide.



**Dear Penn State:**  
"My SUPER Scroll Saw was delivered two days ago and it performs like the neighbor's \$700 one. I'm delighted."

Mrs. S.A. Swartz  
White Cloud, KS

"I recently received one of your 15" Scroll Saws as a gift and was impressed with its construction and other features. I'd say it can be compared favorably with such saws as Escaliber and the Hegner line."

Mr. E. L. Brendza  
San Bernardino, CA

"I am thrilled with the performance as is my wife who has operated it more than I have. As a special automatic machine designer for the last 40 years, I feel that I am qualified to compliment you on a well-designed machine."

C.M. Smeigh  
Ft. Worth, TX

**The Editor  
The Woodworker's Journal**  
"Kudos for the folks at Penn State Industries for value and customer service! When I contacted them concerning a minor problem, replacements were rushed out to me the same day."

As an amateur woodworker, I was pleased to find that lower priced, well made equipment is available from people who are willing to stand behind their products.

A. Mortenson  
New Milford, CT

**SPECIFICATIONS:**

- Cast iron construction
- Throat depth — 15"
- Max. depth of cut — 2"
- Cuts per minute — 1725
- Weight — 43 lbs
- Motor — Heavy duty totally enclosed fan cooled 110V - 120V  
UL listed, ball bearing — induction motor

**NEW!**

- \* **Dust Blower**  
(Optional - Add \$15.00)
- Use standard 5" blades
- Stroke length — 3/4"
- Table Tilt — 0 - 45°
- Table Size — 8" x 17"

30 Day Money Back Guarantee—1 year warranty parts/labor  
**FREE: 12 Blades & Extra Blade Holder Set with purchase. \$12 value.**

**PENN STATE INDUSTRIES -W**  
2850 Comly Road • Philadelphia, PA 19154  
1-215-676-7609 (Ext. 15)

\* Add \$15.00 for Blower Option • Visa, MasterCard, Check or Money Order Accepted  
Add \$10.00 for shipping in Continental U.S. • Pennsylvania residents add 6% sales tax

**Like Having A Lumberyard Right In Your Shop!**



**FREE  
30-DAY  
TRIAL**

**NOW! PLANE, MOLD & SAND  
with the Precision Control of  
Infinitely Variable Power-Feed!**

Just a twist of the dial gives you from 70 to over 1000 cuts per inch . . . you can sail through even the toughest oak at higher speeds, or slow down to surface stock that is virtually impossible on any other machine. Slower speeds turn out glass smooth molding . . . no sanding needed!



Woodmaster's Quick-Change Molding Head lets you create custom moldings from any stock. Choose from over 250 standard trim and picture frame patterns . . . or design your own!



Power-fed sanding speeds production and improves the quality of your work. No more waves or crossgrain scratches. Separate Sanding head installs in just minutes.

Now choose from two powerful models! Woodmaster introduces the first 18 1/2" Planer/Molder . . . The "BIG 18" . . . with all the features that have made the 12-in. model the most versatile Planer/Molder on the market! Send for Free Facts today!



**WOODMASTER TOOLS, INC., DEPT. PW26 • 2908 Oak Street  
KANSAS CITY, MO 64108 • Or Phone: 1-800-538-4200 Ext. 2326**

**YES!** Please rush me your **FREE** Information Kit plus details on your **30-DAY FREE TRIAL GUARANTEE!**

NAME \_\_\_\_\_  
ADDRESS \_\_\_\_\_  
CITY \_\_\_\_\_  
STATE \_\_\_\_\_ ZIP \_\_\_\_\_

## FACTORY DIRECT CLOCKS AND FURNITURE



Do-It-Yourself Kits or Assembled and Finished

- Grandfather Clocks, Mantel and Wall Clocks
- Cabinets, Chests, Tables, Chairs, Desks...and more!
- Solid 3/4" Black Walnut, Cherry, or Oak
- Heirloom Quality
- Solid Brass West German Movements and Dials
- Money Back Guarantee

**Kit Prices Starting at \$89.50.**



SEND \$1 FOR COLOR CATALOG

### EMPEROR CLOCK COMPANY

World's Largest Manufacturer of Grandfather Clock Kits  
Dept. 2804, Emperor Industrial Park  
Fairhope, Alabama 36532 • Phone 1-205-928-2316

I am interested in

Do-It-Yourself Kits  Finished Clocks  Finished Furniture

Name \_\_\_\_\_

Street \_\_\_\_\_

City \_\_\_\_\_

State \_\_\_\_\_ Zip \_\_\_\_\_

(Please Print)

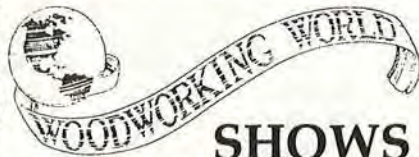

## SHOWS

### THE NEW YORK SHOW

September 23 - 25

Westchester County Center  
White Plains, New York

### THE CAROLINA SHOW

September 30 - October 2

The Merchandise Mart  
Charlotte, North Carolina

### THE CHICAGO AREA SHOW

October 7 - 9

The Metro Center  
Rockford, Illinois

### THE NEW ENGLAND SHOW

October 21 - 23

Eastern States Exposition (The Big E)  
Springfield, Massachusetts

### THE CLEVELAND SHOW

October 28 - 30

International Exposition (IX) Center  
Cleveland, Ohio

★ FREE SEMINARS ★

ADMISSION \$6.00

For more information:

WANA, P.O. Box 706, Plymouth, NH 03264

Toll Free 1-800-521-7623 Mon.-Thurs.

or (603) 536-3768

## THE ONLY CORRECT WAY TO PREDRILL FOR WOOD SCREWS



**New single twist tapered bits cut cleaner, faster**  
Tapered bits allow screws to grip their whole length for added holding power. Tapered bits outlast conventional bits in this kind of work. Single twist permits efficient chip ejection and reduces clogging. Adjustable countersinks leave a clean hole for plugging. Sets include drills, countersinks, and stop collars for each bit within the set. Production quality for long service life.

801-429 Four-piece set (#6, 7, 8, 10) \$24.95

801-431 Seven-piece set (#5, 6, 7, 8, 9, 10, 12) \$42.50

Please add \$4.50 for packing and insured delivery.

Please enter my FREE two-year subscription to Woodworker's Supply catalog.

## Woodworker's Supply



OF NEW MEXICO

5604 Alameda Place, NE • Dept. WM3  
Albuquerque, NM 87113  
1-800-645-9292

### HOW TO WORK WITH LATTICE

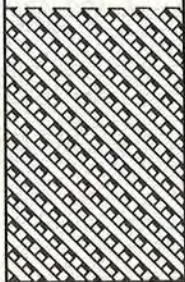

## HOW TO WORK WITH LATTICE

This fully illustrated 32-page idea book shows inside & outside uses of lattice. Contains wall & ceiling designs, furniture trim, doors, boxes, screens, trellises, room dividers, fences, deck & porch trim and much more, plus alternative moulding profiles. To receive your copy send 75¢ to

Wood Moulding & Millwork Producers, Assn.,  
Dept. W88, Box 25278  
Portland, OR 97225.



\* U.S. funds only. Canadian purchasers add 50¢ for handling & postage.

## BUILD THIS EXQUISITE HARP FROM A KIT!



Send \$1.00  
for catalog

ST. CROIX KITS  
423-B South Main  
Stillwater, MN 55082  
(612) 439-9120

## Wood-Mizer®

World's Largest  
Manufacturer  
Of Portable  
Sawmills



## OWN YOUR OWN SAWMILL

Four Models To Choose From  
**SAVE MONEY—**

**CUT YOUR OWN LUMBER**

- Remote hydraulic log handling
- Capacities up to 32" in dia. by 33' long
- Portable—precise—rugged
- Efficient—more lumber per log

CALL FOR FREE CATALOG

**1(800)553-0219**

In Indiana call: (317) 271-1542  
**FREE** 44-page catalog or use your MasterCard or VISA to order our 50-minute demonstration video—\$10.00

Wood-Mizer Products, Inc. • Dept. QQ26  
8180 W. 10th St., Indianapolis, IN 46214-2430

**MATCH OLD MOLDING WITH THIS BIT**

Bosch engineers have designed a hard-working cutting head to match many traditional molding cuts. This makes the bit an invaluable tool for remodeling jobs that require certain molding styles no longer made.

The first thing I noticed while routing with the bit was its incredible sharpness; the result, Bosch says, of diamond honing. For the

serious remodeler, carbide-steel composition guarantees that the bit's sharpness will hold up through many, many projects.

—Steve Oswalt

(Steve Oswalt, a Des Moines woodworker, frequently contributes to WOOD magazine.)

*Bosch Edge-Beading Router Bit, sold at hardware stores nationwide. The bit we tested, No. 85631M, carries a \$28.25 suggested retail price.*



**FINISHING THE FUN AND EASY WAY**



Woodsheen, a new Minwax product, applies easily and dries quickly in two hours as advertised—two points to consider in any finish.

Minwax bills the item as a “one-step finish.” The gelled product combines a stain with a wax-like coat. However, the instructions clearly recommend two coats.

The squeeze bottle is a big plus for me—no lid to pry off and ham-

mer back on—and the gel made the product easier to apply than a normal stain. The resulting finish has a nice sheen to it, but only after applying a second coat.

—Steve Oswalt

*Woodsheen, a product of Minwax Co., available in six colors plus natural, at hardware and home supply stores nationwide. The 12-ounce bottle retails for \$4.99.*

Continued on page 84

**YELLOW SHOPHELPERS**



**MODEL G1630**

**SPECIAL \$69<sup>95</sup> PPD. TO YOU**

**DOWEL CRAFTER JIG**



**MODEL G1662**

**ONLY \$39<sup>95</sup> PPD. TO YOU**

**MINI LIGNO MOISTURE METER**



**MODEL G1491**

**ONLY \$98<sup>50</sup> PPD. TO YOU**

**RADI-PLANE**



**MODEL G1522**

**ONLY \$18<sup>95</sup> PPD. TO YOU**

**MULTI-FORM ROUTER BIT**



**MODEL G1099**

**ONLY \$39<sup>95</sup> PPD. TO YOU**

**REVERSIBLE STILE & RAIL ASSEMBLY ROUTER BIT**

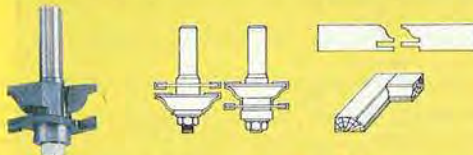

**MODEL G1629 1/4" SHANK - ONLY \$37<sup>50</sup> PPD. TO YOU**

**MODEL G1612 1/2" SHANK - ONLY \$37<sup>50</sup> PPD. TO YOU**

**ALSO AVAILABLE:**

**REVERSIBLE STILE & RAIL SHAPER CUTTER FOR 3/4" STOCK.**

**MODEL G1658**

**ONLY \$49<sup>95</sup> PPD. TO YOU**

**QUICK SETTING WOOD VISES**



**MODEL G1091 7"x8" - \$42<sup>50</sup>**

**MODEL G1092 9"x10" - \$59<sup>95</sup>**

BOTH PREPAID TO YOU



IMPORTS, INC.

East of the Mississippi contact:  
2406 Reach Road  
Williamsport, PA 17701  
(717) 326-3806

**2 LOCATIONS TO SERVE YOU BETTER:**

West of the Mississippi contact:  
P.O. Box 2069  
Bellingham, WA 98227  
(206) 647-0801



**MINIMUM ORDER \$20<sup>00</sup>**

88-156



**25 PC. SANDING DRUM SET**



**MODEL G1280**

**ONLY \$13<sup>95</sup> PPD. TO YOU**

# "Jorgensen" AND "Pony"

## CLAMPS

Dependable extra hands for all types of clamping and work-holding jobs:  
Woodworking Projects, Home Maintenance, and Furniture Repair.

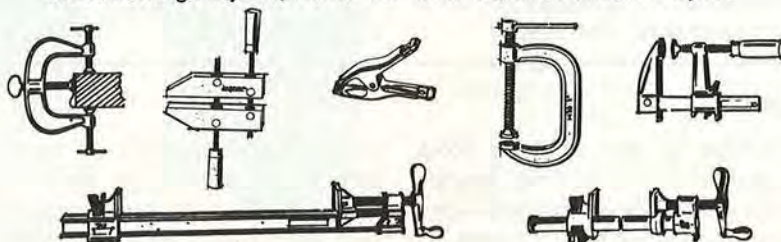

Write for FREE LITERATURE.

For big 32-page "how-to-clamp-it" catalog, send \$1.00.

ASK YOUR DEALER

**ADJUSTABLE CLAMP COMPANY**

THE CLAMP FOLKS

410 N. Ashland Avenue • Chicago, IL 60622

## PRODUCTS THAT PERFORM

Continued from page 83

### THESE BLOCKS KEEP THEIR COOL



This inexpensive investment cuts wear and tear on band-saw blades and nerves. Cool Blocks, made of a tough, self-lubricating, non-metallic substance, replace standard factory-supplied metal guides. The dry lubricant in Cool Blocks will not stain wood.

Because they won't heat up the way metal guides do, they can be fitted closer to the blade, reducing wobble and producing a smoother cut. Set the distance between the blocks and the blade between .003" and .005" (a dollar bill is .004" thick).

The high-tech plastic also reduces blade friction, extends blade life, and dampens noise. Softening my saw's high-pitched whine made it easier to concentrate on critical cuts.

The guides appear to be durable. After 90 minutes of solid use, my Cool Blocks hardly showed any signs of use. When wear does occur, the manufacturer says they can be refaced with a file.

—Steve Oswalt

Cool Blocks come in sizes to fit most band saws; all cost \$9.95 a set. The guides we tested were for a 14" Delta, order No. 33K0901, from Garrett Wade Company, the exclusive U.S. distributor. For more information write the company at 161 Avenue of the Americas, New York, NY 10013.

Continued on page 88



## THE ALL-NEW Scroll Mate

14" 3-SPEED SCROLLSAW

You Owe It To Yourself To  
COMPARE BEFORE YOU BUY!

**3 Speeds**—To handle all types of materials from soft woods and delicate veneers through plastics and non-ferrous metals.

**Ample Capacity**—14" throat. Generous 2" depth-of-cut.

**Built-In Blower**—(Standard) Keeps the cutting line clear of debris.

**Smooth, Quiet Operation**—Delivers the sound and feel of quality.

**Powerful Enclosed Induction Motor**—Tackles even the toughest jobs.

**Built To Last**—Made of rugged, cast aluminum for a lifetime of dependable service.

**Compact**—Small enough for the utility room or garage with room to spare.

**CALL TOLL-FREE  
FOR MORE INFORMATION  
1-800-533-3728**

OR, send your mail-in inquiry to the address below:

Get Your  
**FREE**  
FACT KIT TODAY!  
LIMITED 2-YEAR WARRANTY  
**MADE IN U.S.A.**

NAME: \_\_\_\_\_  
ADDRESS: \_\_\_\_\_  
CITY: \_\_\_\_\_ STATE: \_\_\_\_\_  
ZIP: \_\_\_\_\_ PHONE: \_\_\_\_\_

DEALER INQUIRIES INVITED



SAKURA U.S.A.  
P.O. Box 710-R  
Xenia, Ohio 45385

From the Editors  
of WOOD® Magazine!

# BUYER'S GUIDE TO WOODWORKING POWER TOOLS

FACTS, FEATURES, AND SPECS  
FOR MORE THAN 150  
MODELS

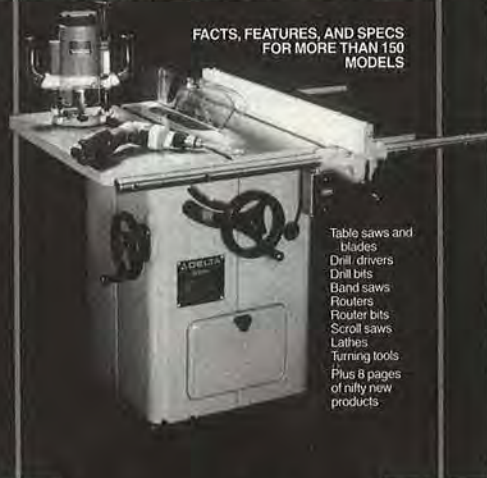

Table saws and  
blades  
Drill drivers  
Drill bits  
Band saws  
Routers  
Router bits  
Scroll saws  
Lathes  
Turning tools  
Plus 8 pages  
of nifty new  
products

**SUPPLIES  
ARE LIMITED -  
ORDER  
TODAY!**

This comprehensive power tool guide is a "must-have" for your woodworking shop. Consult it before you buy - and save yourself time and money! It features the very best in ...

- \* Routers and router bits
- \* Cordless drills and drivers
- \* Scroll saws
- \* Band saws
- \* Table saws and blades
- \* Lathes and lathe tools
- \* New product information

DETACH HERE

HERE'S THE COMPLETE  
POWER TOOL BUYING GUIDE  
YOU'VE BEEN WAITING FOR ...

*Reserve Your  
Copy Now!*

**TO ORDER:** detach coupon below, fill it out, enclose it with payment (or credit card information) & mail to: WOOD®, Locust at 17th, Box 10617, Department 210013, Des Moines, Iowa 50336. We'll deliver the buying guide right to your door - and pay all postage costs!

**OR, FOR FASTER SERVICE  
CALL TOLL FREE  
1-800-678-2666**

DETACH HERE ✂

**ONLY  
\$3<sup>95</sup>**

**YES!** Please send me The 1988-89 Buyer's Guide to Woodworking Power Tools for just \$3.95.

Name \_\_\_\_\_

Address \_\_\_\_\_ Apt. # \_\_\_\_\_

City \_\_\_\_\_

State \_\_\_\_\_ Zip \_\_\_\_\_

**CHECK ONE**  I'm sending a check or money order

Please bill my  MASTERCARD  VISA

Card # \_\_\_\_\_

Exp. Date \_\_\_\_\_

Cardholder's Sig. \_\_\_\_\_

*Get Your Order in right away!*

210013

# CONTEMPORARY FURNITURE PLANS

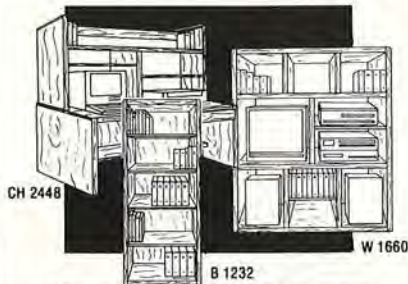

Order now and build your own stylish contemporary furniture with easy to follow blueprints and instructions. Includes helpful tips for many types of cabinet making.

Order No.	Item	Price
CH 2448	Computer Desk & Hutch	11.95
B 1232	Bookcases	11.95
W 1660	Wall Unit	11.95
TS 1630	T.V. VCR Stands	11.95
SC 1625	Stereo Cabinets	11.95
NH 1618	Nightstands & Headboard	14.95
DM 1632	4, 5 & 6 Drawer Dressers & Mirrors	14.95
CE 2720	Coffee Tables & End Tables	14.95

Add \$2.00 shipping and handling.

Complete set of all plans listed above: **\$76.95!**

Add \$4.00 shipping and handling.

Utah residents add 6% sales tax.

For orders only call **TOLL FREE: 1-800-541-8147**  
In Utah: **1-800-338-3474**

For information only call: **1-801-785-4300**

To order by mail send check or money order/Visa or MasterCard

Card Information to:

Fisher Wood Designs

384 E. State Rd. Suite A

Pleasant Grove, Utah 84062



Please send this portion for credit card mail orders:

Card # \_\_\_\_\_

Expiration Date \_\_\_\_\_

Signature \_\_\_\_\_

# MAKE TOYS

CLOCKS & WHIRLIGIGS

Make wooden toys, whirligigs, clocks, dollhouses, autos, music boxes, weather instruments, games, crafts & furniture with our plans, parts (hardwood & metal), kits (for all skill levels), books, tools and supplies. Bulk prices. Catalog \$1. (614)484-4363  
Cherry Tree Toys, Bx 369-409, Belmont, OH 43718



**FISHERMAN**  
Precut Kit: \$29.95  
Just sand & assemble

22" long  
Visa/MC  
Uncut Kit: \$24.95  
Just cut, sand & assemble

# STOP WASTING WOOD!

## GAUGE-IT

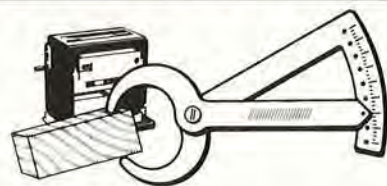

**NEW!**

Fast, accurate, durable aluminum, direct reading thickness gauge (no dials or conversions required) for determining wood thicknesses for planers. 0-2" with stops at 1/4" intervals. Guaranteed. \$14.95 + \$1.00 for postage.

E. F. Boerder  
4514 Cole Avenue, Dallas, Texas 75205  
or order direct

214/521-4099



# WOODCARVER

## MACHINES

Make:

- SIGNS IN WOOD
- PICTURES
- ARTS/CRAFTS



PATENTED - TABLE TOP SIZE



T.M. WATSON, M.D.

A.C. WILSON, ATTY.



Sigs Any Size or Thickness

MAKE MONEY THE VERY FIRST DAY AS A SMALL BUSINESS, HOBBY, WEEKENDS, CRAFT SHOWS.

\$85 per hour return to you.

Send \$1.00 for info pack.



**KIMBALL WOODCARVER CO.**



2602-A Whitaker Street - Savannah, Georgia 31401

Visitors Welcome. Call Ahead.



WINDOWSILL CAT PATTERNS

12 DIFFERENT PATTERNS FOR WOOD CUTOUTS ALL FOR \$6

**DAKOTA WIND**

DEPT. W108

BOX 866

JAMESTOWN, ND 58402

# SPECIAL OFFER

## BRANDING IRON

For hard and soft wood

**\$2600**

Plus \$2.00 for shipping and handling

Nebr. residents add correct sales tax

SATISFACTION GUARANTEED or your money back

HAND CRAFTED BY YOUR NAME HERE



- Shipped in 1 week
- Solid brass head - deep cut letters
- First Line: HAND CRAFTED BY - as above
- 2nd line: Your choice - 20 characters/spaces max.
- Compact size
- As above but with 3rd line - \$37.00 + \$2.00

ORDER TOLL FREE 1-800-826-7606 (except Nebraska)  
In Nebraska 1-402-484-0511

For free brochure, write or call (402) 464-0511

Order by mail from: **NOVA TOOL CO.**

12500 Finigan Rd., Dept. BH

P.O. Box 29341, Lincoln, NE 68529



**Carousels**

4 HORSES 14" TALL X 11"    8 HORSES 15 1/2" TALL X 18"

Childhood memories of warm summer nights come alive with our exclusive CAROUSELS. A perfect scroll saw project. FULL SIZE PLAN PLUS solid brass rods, lazy susan bearing, screws and flag; Small: \$6.50, Large: \$9.50, only \$14.00 for both. Fast FREE Shipping. \$1.00 subscription Plan and Tool catalog. FREE with order. Send order today to:



RJS Custom Woodworking  
P.O. Box 12354, Dept. N  
Kansas City, KS 66112



**PORTER-CABLE**  
PROFESSIONAL POWER TOOLS

555 **\$159**



081 **\$249**



**Elu**  
HORIZONTAL TOOL LTD.  
BLACK & DECKER

3380 **\$367**



**Lamello**

Top **\$527**

**We've got the latest in plate joiners**

Biscuits #0, #10, #20  
or assorted pack of 1000.....\$25.95

Glue bottle.....\$18.00

Free Freight    Quantities limited



**THE SOURCE**

7305 Boudinot Drive

Springfield, VA 22150

(703) 644-5460

Send \$3.00 for our complete catalog

**US 800 452-9999**

**VA 800-468-1778**

# HORTON BRASSES

Nooks Hill Road, P.O. Box 120J  
Cromwell, CT 06416    (203) 635-4400

**HORTON BRASSES** are authentic copies of 17th, 18th, 19th & early 20th century pulls



Mfrs. of Cabinet & Furniture Hardware for Homes & Antiques.  
Send \$3.00 for a Catalogue.

# WOODWORKER'S CATALOG

There are over **4,000** money-saving reasons why woodworkers rely on Constantine.

4,000 woodwork items - to help you Build-Restore-Repair-Refinish! Over 200 different woods... 150 veneers... 500 plans... cabinet hardware... 96 How-To Books... 118 carving tools and chisels... 76 inlay designs... and lots more for One-Stop, Right-Price Shopping without leaving home!

116 Page Catalog-Only \$1.00

**CONSTANTINE** Est. 1812  
2054S Eastchester Road, Bronx, NY 10461

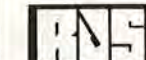



## SCROLL SAW LETTERS EASILY...



...with **Lettering Layout Guides!**

- Excalibur Scroll Saws
- Scroll Saw Accessories
- Foredom Tools
- Mill—Route System

Make Name Plates, Signs, Gifts and more.

Our unique Lettering Guides are available in many styles and sizes to suit your needs. Upper and Lower Case Script and Block Styles...and numbers too. Send \$1.00 for brochure and prices to:

**SEYCO SALES**

1414 Cranford Drive  
Box 472749  
Garland, Texas 75047

## BAND SAW BLADES

WELDED TO YOUR EXACT LENGTH

Complete Band Saw Blade Line Including Saw Mill Blades

We also carry:

- Scroll Saw Blades
- Hand Saws
- Circular Saw Blades
- Hole Saws
- Hack Saws
- Sanding Belts
- Sanding Disks
- Router Bits
- Files
- Rasps
- Scrapers

SEND \$1.00 FOR CATALOG or TO ORDER PHONE OR WRITE TO:

## BUCKEYE SAW COMPANY

P.O. BOX 14794  
CINCINNATI, OHIO 45250-0794  
1-800-543-8664 (Except Ohio)  
1-513-621-2159 (In Ohio)

# Make Signs?

If you make or are interested in wood signs, you'll want SignCraft — the magazine for the sign artist. You'll see creative wood signs in every issue — carved, routed and sandblasted — plus how to's, pricing, technical help and more! Your satisfaction is guaranteed.

- 1 yr. (6 issues) ..... \$24
- 1 yr. Outside U.S. (U.S. funds) ... \$31

**SignCraft Magazine**  
P.O. Box 06031-W, Ft. Myers, FL 33906

# MAKE MONEY

WITH FURNITURE RESTORATION

SAFE, DEPENDABLE, EASY stripping and refinishing systems and products, featuring **HYDROCOTE™** water-base finishes.

## AMITY

Quality Restoration Systems

Wisconsin: 608-837-8484  
Nationwide: 800-334-4259

## Wood Moisture Meter

- Avoid Moisture Problems
- Protect your Masterpiece

### MINI LIGNO

Incl. Case, Batteries and Pins for 3/8" and 7/8" Measuring Depth.

only **\$110**

also from Lignomat:  
**MINI-LIGNO E**  
Range: 6%

Easy-to-use, sturdy instruments for the professional woodworker or serious hobbyist. Great for lumber, veneer, fiberboards. Ask for free catalog on the complete line of moisture meters and accessories for kiln drying.



**Lignomat USA Ltd.** P.O. Box 30145bh  
503-257-8957 800-227-2105 Portland, OR 97230

## National Carvers Museum

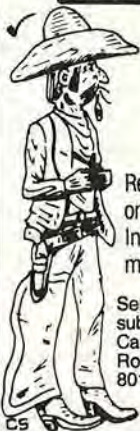

LEARN  
WOODCARVING  
AT HOME

Receive sample instructional pack on whittling and woodcarving. Includes copy of *Mallet* monthly magazine.

Send \$2.00—deductible upon subscription payment to The National Carvers Museum, 14960 Woodcarver Road, P.O. Box 389, Monument, CO 80132.

(719) 481-4737

## Full-Size Professional Plan ADIRONDACK CHAIR



Make this classic American design. Our special version may be folded for storage by using ordinary hardware available at your local store. Be ready for Summer and get your plan now!

CATALOG 200 full-size professional furniture plans — \$2.00

Plan #700 . . . . \$12.00  
(Catalog free with order)

**FURNITURE DESIGNS, INC., Dept. BA-108**  
1827 Eimdale Ave., Glenview, IL 60025  
(312) 657-7526

# The Japan Woodworker's Catalog is . . .

loaded with the best tools you can get your hands on. In our catalog you will find a complete selection of Japanese tools for the woodcarver, carpenter and cabinetmaker. Send \$1.50 for our catalog and supplements during the next two years.

**THE JAPAN WOODWORKER**  
1731 Clement Ave., Alameda, CA 94501  
Phone (415) 521-1810

FUN-PROFITABLE-EASY TO MAKE PROJECTS

## WOODCRAFT

-full size patterns-

- A. 10 Exciting Patriotic Projects
- B. 17 Country Feline Projects
- C. 9 Exclusive Folk Art Horses
- D. 45 Country Folkart Figures
- E. 8 Old Fashioned St. Nicka
- F. 11 Fun & Easy Vehicles
- G. 24 New Shelf Gritter Designs
- H. 12 Country Shelf Designs
- J. 14 Folk Art Shelf Sitters
- K. 10 Country "DAWG" Projects

\$5.00 EACH  
**3 FOR ONLY \$13.00**

The Winfield Collection, DEPT. W1  
12044 Parkin Lane, Fenton, MI 48430  
CATALOG \$1.00—FREE WITH ORDER

## Make Profitable Wood Projects at home with a personal computer-driven lathe



### EMCO MAIER COMPACT 5 PC Woodworker

- Part repeatability for look-a-like parts
- Complex contouring, I.D. boring, etc., can all be easily programmed
- Simple menu-type software with color graphics simulation print/plot, editing capabilities

Emco Maier Corporation  
2757 Scioto Parkway  
Columbus, Ohio 43026  
**1-800-841-0626**  
(In Ohio 614/771-5991)

## QUARTZ CHIME CLOCK MOVEMENTS



Large selection of Westminster and strike movements. Hand painted dials with kits for home assembly. Quartz fitups and LCD movements. Numbers, letters, hardware. Hundreds of items to build clocks.

Send \$1.00 for Catalog and Sales Plan.

**NEWPORT ENTERPRISES INC.**  
2313 W. Burbank Blvd.  
Burbank, California 91506

**NEW**  
Optional Hooks

## Thomas Clamp Assembly Aid

ADJUSTABLE ASSEMBLY CLAMP NUMEROUS USES  
NATURAL RUBBER STRAP ZINC-PLATED STEEL  
HARDWARE/STAINLESS STEEL SPRING  
WHAT EVERY WOODWORKING SHOP NEEDS

MADE IN USA	EACH	FOR 6
4 1/2 TO 30" STRAP CLAMP	4.95	26.00
4 1/2 TO 45" STRAP CLAMP	5.45	28.00
4 1/2 TO 60" STRAP CLAMP	5.95	30.00
2 EACH OF ABOVE		28.00
SET OF 2 HOOKS	.95	5.00
POSTAGE & HANDLING	2.00	2.00

ORDER FROM:  
THOMAS CLAMP CO., BOX 237, ARAB, AL 35016

# WOODWORKS

## American Made Woodturnings

	Qty.	Total
Shaker Peg		
Mug Peg		
3-1/2" Economy Shaker Peg	\$14.00/100	
3-1/2" Maple Shaker Pegs	20.00/100	
Medium Shaker Peg	15.00/100	
1-3/4" Mini Shaker Pegs	7.00/100	
3-3/8" Kitchen Mug Pegs	20.00/100	
2-7/16" Tie Rack Pegs	7.00/100	
Bean Pot Candle Cup	17.00/100	
Medium Bean Pot	15.00/100	
Small Bean Pot	12.00/100	
Mini Bean Pot	10.00/100	

## LOW PRICES

Dia. x Thick	(24 Sizes)	
3/4" x 1/8" Hearts	\$3.00/100	
3/4" x 1/4"	4.00/100	
1" x 1/8"	4.00/100	
1" x 1/4"	6.00/100	
1" x 1/2"	6.50/100	
1-1/4" x 1/8"	8.00/100	
1-1/4" x 1/4"	9.00/100	
1-1/4" x 1/2"	11.00/100	
1-3/4" x 1/8"	3.50/25	

*American Made Hearts*

## HIGH QUALITY

3/4" Full Round Balls	\$8.00/100	
1" Full Round Balls	10.00/100	
3" Wooden Balls	2.50/Each	
Large Egg 1-7/8" x 2-1/2"	35.00/100	
Small Eggs 1-3/8" x 2"	25.00/100	
1" Toy Wheel	6.50/100	
1-1/4" Toy Wheel	6.80/100	
1-1/2" Toy Wheel	10.00/100	
Axle Peg	4.50/100	

## FAST SERVICE

3/8" Maple Buttons	\$2.15/100	
1/2" Maple Buttons	2.25/100	
3/8" x 2" Dowel Pins	2.20/100	
1-1/2" Maple Spindles	9.00/100	
1-1/2" Oak Spindles	12.00/100	
2-1/8" Maple Spindle	14.00/100	
2-1/8" Oak Spindle	18.00/100	
Picture Hanger	1.50/100	
1-5/8" Sawtooth Hanger	4.50/100	
Nailless Sawtooth Hanger	8.00/100	

## MONEY BACK GUARANTEE

1/2" x 5/8" Wooden Spools	\$5.00/100	
5/8" x 3/4"	6.00/100	
3/4" x 1"	9.00/100	
7/8" x 1-3/16"	10.00/100	

## WOOD PARTS ORDER NOW

#B J8	
TOTAL FOR GOODS	
TEXANS ONLY ADD 6% SALES TAX HANDLING AND INSURANCE	\$3.00
32 PAGE 1988 CATALOG \$1.00 (Free With Order)	FINAL TOTAL

MC OR VISA  CHECK ENCLOSED

ACCOUNT # \_\_\_\_\_

EXPIRES \_\_\_\_\_ PHONE \_\_\_\_\_

NAME \_\_\_\_\_

SHIP TO \_\_\_\_\_

CITY/STATE/ZIP \_\_\_\_\_

817/281-4447



WOODWORKS

4500 ANDERSON • FT. WORTH, TX 76117

# PRODUCTS THAT PERFORM

Continued from page 84

## A DOWEL JIG WITH ALL THE ANGLES



This dowel jig rates as one of the most expensive and most versatile that I have come across. It not only looks nice and solid with excellent

castings, it also adjusts easily and mounts firmly. The device's unequaled ability to enable drilling at angles from 0° to 45° is undoubtedly its strongest point.

The jig's quick-release toggle clamp adjusts simply and will easily apply 200 pounds pressure. A 3/2" rubber pad on the clamp prevents marring of the work piece. The jig mounts easily on a work bench or in a bench vise.

—Steve Oswalt

*Kaufman's Dowel Jig, available in some hardware stores, retails for \$129.95. For a list of distributors in your area, write to: Quality Craft Tool, 1703 East Monroe St., Goshen, IN 46526.*

## A PLANE TO RALI AROUND

I don't normally like woodworking tools made of plastic. But in this case, I'll make an exception.

The molded plastic handles of the Swiss-made Rali plane provide good leverage and feel comfortable. The plane stakes its fame on its replaceable blade, but I liked the depth adjustment even more. A flick with an index finger moves the single lever that adjusts blade depth. Once set, the blade—factory sharpened on two sides—did not slip. Because of the holding mechanism, I never needed to worry if the cutting edge was parallel.

—Steve Oswalt



*The Rali 220 replaceable-blade plane can be ordered direct from H. Hirschmann Ltd., Oxbow Rd., Pittsford, VT 05763 for \$81.16 ppd. Replacement blades sell for \$2.20 each or \$19 for a pack of 10.*

## COTTON WHEEL SHINES FOR LATHE BUFFS



This cotton buffing wheel works well and its #2 Morse-tapered shank fits most lathes, except Sears, Myford, and Shopsmith.

Altering the lathe speed changes the rigidity of the buffing wheel. One caution: Do not use the wheel on raw wood.

—Marlen Kemmet

*The Arbor buffing wheel kit, including arbor unit, buffing wheel and compound bar (No. AB110); \$29.95 ppd. from Craft Supplies, 1287 E 1120 S, Provo, UT 84601.*

# Your workshop can PAY OFF ...BIG!

SAVE ... convert low  
cost rough lumber  
for use in your  
home projects

OR

EARN EXTRA  
INCOME by supplying  
custom Planed Lumber,  
trim, and molding to  
lumberyards ...  
contractors ...  
cabinetmakers ... home  
hobbyists and others ...



## FOUR BIG ADVANTAGES ...



PLANE



MOLD



SAW



SAND

### You can plane, mold, saw & sand All with Automatic Power Feed!

From the Day It Arrives ... the Planer will make and save you money. With shortages and inflation driving lumber prices sky-high, this versatile power feed tool quickly pays for itself by easily converting low cost rough lumber into high value finished stock. In just one pass turn out your own quarter round, door and window stop, casing, tongue-and-groove ... all popular patterns. Other operators are making cases for grandfather clocks, furniture, picture frames, bee hives, bed slats, surveying stakes ... all kinds of millwork.

**Built For Pros ... Priced For Home Craftsmen ...** it is engineered and built to industrial standards, but factory-direct selling keeps the price low. Handles tough oak and walnut as easily as pine, and so simple to operate even beginners with no experience can use it.

**Start Your Own Business ...** with just this one low cost power feed machine in a corner of your garage or basement, you're set up to supply lumberyards, cabinetmakers, carpenters, remodelers, contractors and hobbyists in your area with custom-planed lumber, trim, molding ... All of their millwork requirements. You can supply picture frame moldings to art shops, hardware and department stores, or sell direct to framing shops. All standard patterns are available from stock, or we'll custom grind a knife to your own special design or sample.

**FREE  
BOOKLET!**

Get **FREE  
BOOK** with  
facts and  
full details

... RUSH COUPON TODAY!



Just Mail Coupon ...  
**30-DAY FREE  
TRIAL OFFER!!!**  
**ACT NOW!**  
Coupon  
Brings  
Full Details!

**SAVE!!! FACTORY PRICES DIRECT TO YOU!**



**FOLEY-BELSAW CO.**  
6301 EQUITABLE RD., DEPT. 91348  
KANSAS CITY, MO. 64120  
Established in 1926

YES, please send me the FREE Booklet that gives me complete facts about your Planer-Molder-Sander-Saw and full details on how I can qualify for a 30-Day FREE Trial right in my own shop. I understand there is No Obligation and that No Salesman will call.

Name \_\_\_\_\_  
Address \_\_\_\_\_  
City \_\_\_\_\_ State \_\_\_\_\_ Zip \_\_\_\_\_

# The Discerning Craftsman

(ADVERTISEMENT)

# LUMBER YARD

- Select a wood species that's compatible with the project you're planning to build (there are several good reference books that list various species' characteristics and preferred uses).
- If you're planning to build several projects in the near future, consider ordering what you need for all of them at one time. That way, you'll have the stock you need when you're ready to build.
- If you or someone you know has a planer, and if you are willing to surface your own lumber, you can save money by ordering stock that's undressed (rough sawn).
- Figure your lumber needs, then add 15% for waste. As you do this, think in terms of the number of boards of a certain size it will take to yield the parts for your project. Make a cutting diagram showing how you plan to cut each of the boards.
- Send along a copy of the cutting diagram with your order, and explain the type of project you're planning to build. Both of these things help us in filling your order.
- Send for our product brochures, and keep them on file in your shop. That way, when you need a particular type of stock, you'll have ready reference.
- Buying in bulk lowers the cost per board foot. Consider going together with some of your woodworking friends, and take advantage of the savings. Some of us have minimum orders.
- Be aware of shipping costs. Is the price quoted a shipped price? How will it be sent? UPS? Trucking firm? Etc.? Ask.
- Upon receipt of your order, please inspect it and report any damaged material to the carrier immediately.

## HARDWOOD CATALOGUE

Only \$2.00. Refunded with order.

White oak, cherry, walnut . . . nothing compares in texture, grain and quality to Appalachian hardwoods.

■ Order your catalogue today. We offer 21 species of domestic hardwoods, softwoods and hard-to-find imports. ■ All wood is kiln-dried and personally selected. We'll finish at no charge. All prices include delivery. ■ Write today.

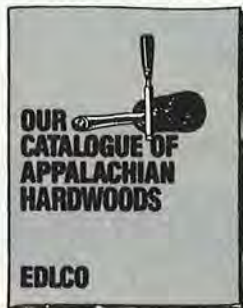

### EDLCO

P.O. Box 5373-C, Asheville, N.C. 28813 • 1-704-255-8765  
Hardwood specialists since 1952.

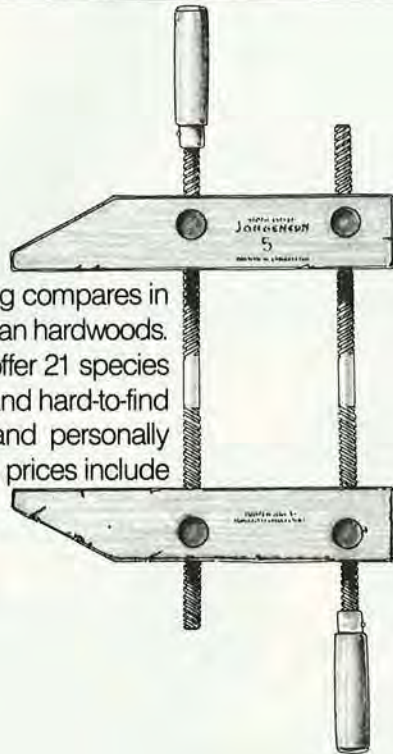

## Quality EXOTIC WOOD TURNERS

Burls / Thick Planks / for Bowls / Squares

### CABINET MAKERS

Individually Selected Lumber for Furniture / Boxes / Inlays  
OVER 70 SPECIES

All Inquiries Welcome - Call or Write

### The Berea Hard Woods Co.

125 JACQUELINE DRIVE, DEPT. 10  
BEREA, OHIO 44017  
216-243-4452

"It's a Matter of Pride for Both of Us"

## The Sawmill

FOR WHOLESALE INQUIRIES

EXOTIC AND DOMESTIC HARDWOODS  
CUSTOM CUTTING, RESAWING, ABRASIVE PLANING  
MUSICAL INSTRUMENT WOODS  
EBONIES, ROSEWOODS, MAHOGANIES, PADAUK,  
PLUS ALL OTHER EXOTIC WOOD SPECIES

TOLL FREE

### 800 345-3103

PA RESIDENTS CALL (215) 759-2064

## Woodworker's Dream

FOR RETAIL INQUIRIES

NO MINIMUM ORDER  
GUITAR KITS

DIVISIONS OF

THE MARTIN GUITAR CO., NAZARETH, PA 18064

### Thin HARDWOOD—Priced Right

Clear • Kiln Dried • 2 Sides Surfaced  
3" to 10" Widths • 3' to 7' Lengths  
20 Sq. Ft. Packs • Random Widths & Lengths

1/8" & 3/16" is 18" to 48" L.

	1/8"	3/16"	1/4"	3/8"	1/2"	3/4"
Red Oak	\$32	\$33	\$34	\$38	\$42	\$62
Pecan	28	29	30	32	34	---
White Oak	32	33	34	38	42	66
Walnut	34	36	38	46	50	68
Cherry	34	36	38	46	50	68
Hard Maple	32	33	34	40	44	56
Basswood	30	31	32	38	42	52
Poplar	29	30	31	32	36	40
Hond. Mahogany	37	39	41	52	57	71
Teak	62	64	67	72	100	130
Aro. Red Cedar # 1 com.-light knots	32	33	34	40	42	46

Price includes UPS delivery in Continental USA

To order circle dollar amount above.

Check or Money Order to:

HARDWOODS OF ILLINOIS

R.R. 4, Box 618 Mt Vernon, IL 62864

## ATTENTION FLORIDA WOODWORKERS

We have Florida's largest and most unbelievable selection of exotic imported and native hard and soft woods, table slabs, veneers, etc. We also stock Ashley Isles carving tools.

Send \$1 for complete price list.

### HENEGAN'S WOOD SHED

7760 Southern Boulevard  
West Palm Beach, FL 33411  
Call (305) 793-1557

Open Tues.-Sat. 9:00-5:30



## Exotic Hardwoods

Ebony & others. For serious woodworkers & turners.

FREE CATALOGUE

Phone or write:

ART EISENBRAND  
4100 Spencer Street  
Torrance, CA 90503  
(213) 542-3576

**DOMESTIC & FOREIGN  
HARDWOODS**

Quality stock for Cabinet Work  
Most all sizes from 1" to 4" in thickness

**HARDWOODS**

ASH—BASSWOOD—BIRCH  
BUTTERNUT—CHERRY  
CHESTNUT—EBONY—MAPLE  
OAK—POPLAR—ROSEWOOD  
TEAK—WALNUT  
Also hardwood plywoods

**SOFTWOODS**

SUGAR PINE—CYPRESS—CEDAR  
SPRUCE—DOUGLAS FIR etc.  
**MAURICE L. CONDON CO., INC.**  
242 Ferris Ave., White Plains, NY 10603  
914-946-4111  
Monday through Friday 8 AM to 4:30 PM

**WOODWORKERS**

Save on Wood - Tools - Supplies!

**OVER  
4000  
ITEMS**

Finest Dimensioned  
**HARDWOODS** and  
Quality **VENEERS**  
**42 VARIETIES**

1/64" to 4" Thickness

Send for  
New 1989  
148 Page  
Money Saving

**CATALOG**



Fast service on choice kiln dried  
Wood and Veneers, Moldings, Trim,  
Hand and Power Tools, Lamp Parts,  
Upholstery Supplies, Clock Move-  
ments and Kits, Hard-to-Find Hard-  
ware, Finishing Materials, Books  
... over 4000 items in stock! Craftsmen—  
Woodworker's best friend.

**CRAFTSMAN** WOOD SERVICE

Dept. WM-108, 1735 W. Cortland Ct., Addison, IL 60101  
Please enclose \$1.00 to help pay postage and handling.



**NORTHEASTERN  
HARDWOODS**

RED OAK  
WHITE OAK  
CHERRY  
HARD MAPLE  
WALNUT  
and other species

COMPARE  
THE  
**FINEST QUALITY**  
AT THE  
**RIGHT PRICE**

TURNING STOCK  
THIN STOCK  
FLITCH CUT LUMBER  
SPALTED LUMBER  
VENEER  
CARVING STOCK

\$2—20 page catalog  
WHOLESALE PRICES  
NO MINIMUM ORDER

**NORTHEASTERN HARDWOODS**

P.O. BOX 365 SALAMANCA, N.Y. 14779  
716-945-1510

**SHAKER PEGS  
CANDLE CUPS  
MUG PEGS**

\$17.95 per 100, prepaid.  
Wide selection of other  
wood products.

Catalog \$2.00 or free with order.

**Benny's Woodworks**

P.O. Box 656, Dept. WD11  
Antioch, TN 37013  
1-800-255-1335



Shaker Peg

Mug Peg

**ZOO CAROUSEL**

See project on page 72

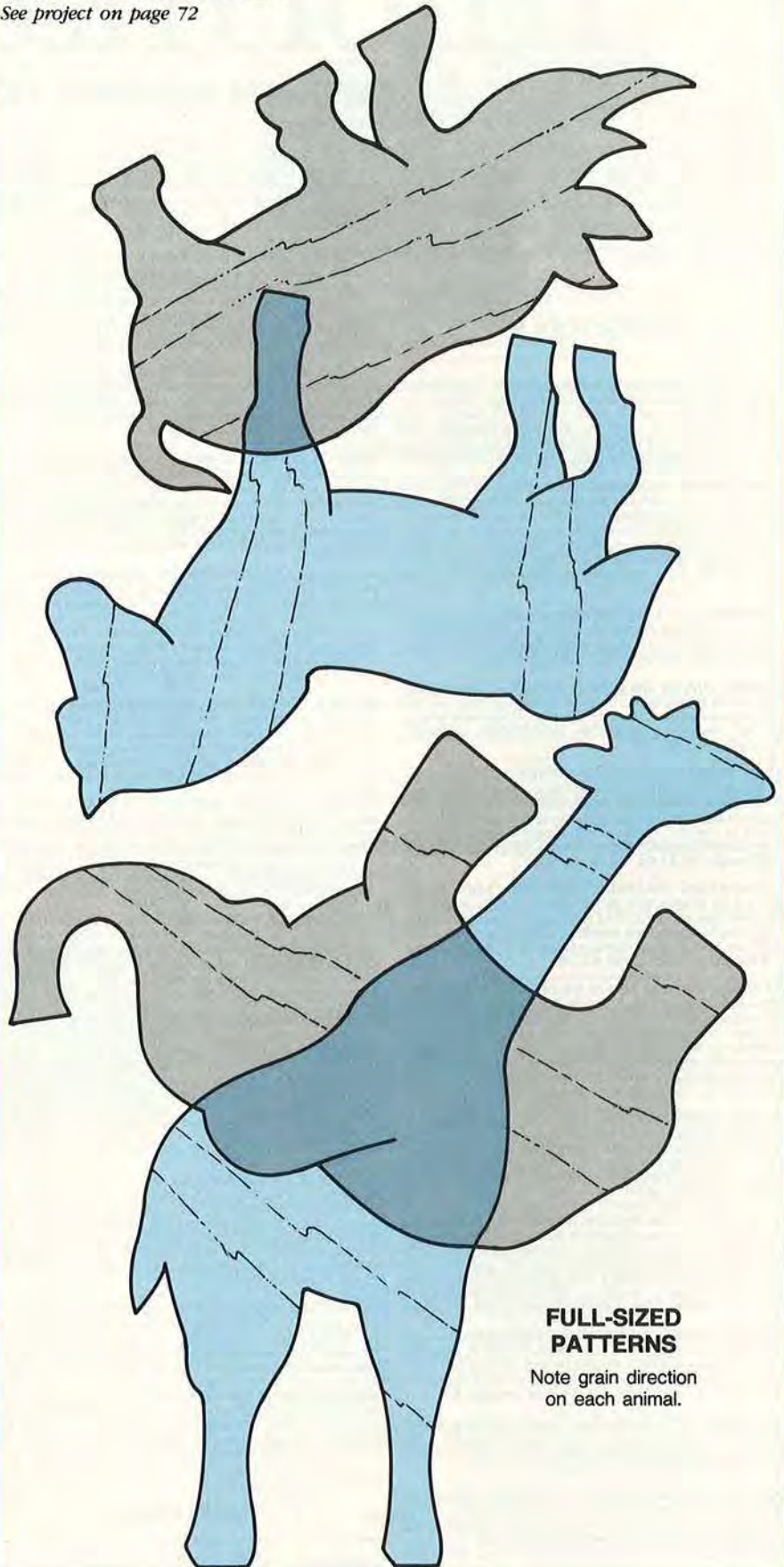

**FULL-SIZED  
PATTERNS**

Note grain direction  
on each animal.

# Information



## WORTH WRITING FOR

You can get useful ideas and product information by mail. Use the coupon in this section to order your choice of literature listed below.

### POWER TOOLS

**SCROLL SAW AND LATHE INFORMATION** — More than 20 pages of information, including full-color photos, on HEGNER precision scroll saws, HEGNER lathes, and HEGNER duplicators. Find out why these machines are considered state of the art, and what to look for when shopping for scroll saws or lathes. AMI, LTD. \$1.00. *Circle No. 3.*

**WOODWORKING PROFESSIONALS ONLY** — Now save 50% on machinery, 70% on operating costs! How? By using the world's finest production quality universal machine. Commercial durability, utmost precision, set-up in seconds. No other tool combines usable capabilities like FELDER. Thousands sold all over the world. Now available in America through AMI. Send for brochure. AMI LTD. \$1.00. *Circle No. 4.*

**POWER TOOLS AT AFFORDABLE LOW PRICES**—We are the warranty service center for Black and Decker, Bosch, and Sioux. We also carry many other brands. Send for catalog. ALCO TOOL SUPPLY INC. 25¢. *Circle No. 6.*

**THE FIRST LINE IN JIG SAW** — BOSCH — Bosch gives professionals a selection of top-of-the-line jig saws as well as an impressive selection of blades. Wholesale prices. Send for literature. AVIATION INDUSTRIAL SUPPLY. \$2.00. *Circle No. 12.*

**DREMEL GUIDE TO COMPACT POWER TOOLS** — Contains 266 pages of charts, project plans, "quick fixes", and over 425 photos on how to use all Dremel power tools. Also contains detailed information on how to use the Moto-Tool, which bit to use to cut, carve, grind, polish, sand, engrave, etc., and correct speed for best results. DREMEL, Div. Emerson Electric Co. \$7.95. *Circle No. 33.*

**WOODWORKING MACHINE CATALOG AND PRICE LIST**—2.5 hp shaper with 3/4" spindle with sleeve to 1 1/4". Planing/thicknessing machine with add-on attachments for sawing, slot mortising and molding. 3-speed bandsaw with disc sander built-in. Woodturning Lathe 39.4" between centers. EMCO USA. 15¢. *Circle No. 36.*

**FREE SUBSCRIPTION TO FOLEY-BELSAW NEWS BULLETIN**—For a limited time Foley-Belsaw will be giving away a 1-yr. subscription to their 64-page color publication. This publication includes stories and shop tips on all types of woodworking, tool sharpening, upholstery, engine repair, and locksmithing. The magazine, published six times a year, includes many special offers on Foley-Belsaw Co. FOLEY-BELSAW. Free. *Circle No. 41.*

**BEAT INFLATION AND HIGH LUMBER YARD PRICES**—Turn trees into valuable lumber with the world famous One-Man Portable Sawmill. Goes right to the trees—turns out smooth, truecut lumber every time. No crew needed, no experience necessary. Send for booklet. FOLEY-BELSAW CO. Free. *Circle No. 42.*

**POWER TOOLS FOR WOODWORKING** — Sold for 40 years. Plans & kits of metal parts to build sturdy power tools that last for years. 5-yr. warranty on parts. Kits & plans \$39-\$189. Simplified step-by-step plans with full sized patterns for wood base may be ordered separately. Parts & accessories sold individually. Send for descriptive brochure & prices. GILLIOM MFG. INC. \$1.00. *Circle No. 47.*

**IF YOU ARE INTERESTED IN FINE WOODWORKING** — you will not find better machinery than that sold by J.P. Humfrey Ltd. For example, we have 10-in. general table saws (3 HP, magnetic switch, available at FOB New York. Send for brochure. J. PHILIP HUMFREY INT. \$1.00. *Circle No. 51.*

**LOBO POWER TOOLS**—surprise the industrial fine wood-working machines with true value. Free 1988 catalog. Listed are all items we sell. Order today and see what we offer. LOBO POWER TOOLS. Free. *Circle No. 57.*

**MAKITA U.S.A. INC.**—offers all new 86-page catalog on their professional line with special emphasis on the entire cordless line. Catalog provides complete information along with available accessories, practical applications at suggested retail prices. MAKITA U.S.A. INC. Free. *Circle No. 61.*

**MULTI-FUNCTION MACHINE**—Super Woodbuilder multi-function tool will challenge any wood crafter's creative horizons. Fully accessorized, the Super Woodbuilder becomes

11 precision tools, each performing the most demanding woodworking functions. Master Woodcraft Machine Co. is a division of Republic-Lagun Group, builders of high precision industrial machine tools. Send for literature. MASTER WOODCRAFT. \$1.00. *Circle No. 63.*

**VERTICAL PANEL SAW/PANEL ROUTER**—Now even working alone you can make extremely accurate rip and cross cuts up to 5 ft. wide in plywood and most sheet goods. Cut V grooves, dados, and more quickly, easily and accurately. Utilizing your saw and router, build mobile unit for about \$185, wall unit approx. \$125. Send for plans and parts list. BRAD O'CONNOR. \$14.95. *Circle No. 70.*

**SCROLL SAW**—Information package available from Penn State Industries describing the specifications and applications of its super 15-inch scroll saw. Special discount pricing available on current winter promotion. PENN STATE INDUSTRIES. Free. *Circle No. 76.*

**QUALITY AMERICAN-MADE SCROLL SAWS**—The RBI Hawk family of Precision Scroll Saws with 5 models, one to fit your needs. Patent pending Camover Quick Blade Change system, 2 way tilting tabletop, 2 speed or variable speed motor, all add up to make the Hawk the best value on the market today. Virtually end sanding forever! Send for the facts. RB INDUSTRIES, INC. Free. *Circle No. 84.*

**AMERICAN WOODWORKING EQUIPMENT**—Over 57 years of experience manufacturing first quality woodworking machinery. The RBI Woodplaner a leader in versatility and durability featuring planing, moulding, sanding and gang ripping capabilities all in one space saving machine. The RBI Joint Machine makes most precision joints simple to make in just seconds. Send for fact filled brochure. RB INDUSTRIES, INC. Free. *Circle No. 85.*

**SAKURA SCROLL SAW INFORMATION**—You owe it to yourself to compare the value-priced 14-inch 3-speed ScrollMate with other units before you make your buying decision. It offers a built-in air bellows; stand; quick, safe speed changes; and a full 2-year limited warranty—all at a price that's tough to beat. SAKURA USA. \$1.00. *Circle No. 87.*

**SCHPEPPACH #1 NAME IN STATIONARY EQUIPMENT**—Scheppach from Europe has a full line of stationary equipment and combination machines considered #1 in Europe for quality, design, and lasting value. Price of full color catalog is refundable with first purchase. Dealer inquiries welcome. SCHPEPPACH AMERICA. \$2.00. *Circle No. 88.*

**THE VERSATILE TOOLMAX T310**—woodworking machine solves the common "too small a shop" problem by combining a 10" table saw, 1" spindle shaper, 12" jointer, 12" planer and fully adjustable mortising table. Saves 90% on space and 60% on investment. Send for complete color information pack. TOOLMAX. \$1.00. *Circle No. 90.*

**MOLDER-PLANERS FROM WILLIAMS & HUSSEY**—Mold, plane, and edge, convert from moulder to planer in less than 2 minutes. The W-7 series is available in 3 models for manual, power in feed, or power in feed/out feed. The units plane to a satin, almost sanded finish, produce doll house to crown sized mouldings, raised panels, and virtually any shape profile. Custom knives available up to 7" wide and 3/4" depth of profile. Rugged, well-made, dependable, and transportable. Complete with sturdy movable stand. Send for catalog. WILLIAMS & HUSSEY. \$1.00. *Circle No. 93.*

**PORTABLE SAWMILLS**—Our new 44-page full color catalog describes each of our 5 sawmill models for 1988, from the compact LT20, that disassembles in 8 light weight pieces, to our largest sawmill, the LT40-HD, with hydraulic log handling capabilities. In addition, dry kiln, carving machines, and shop band saws complete our line of progressive woodworking equipment. WOOD-MIZER PRODUCTS. \$1.00. *Circle No. 94.*

**IS THIS THE WORLD'S BEST JOINER-PLANER?** — We think so and invite you to take a closer look! MiniMax's new FS-35 joiner-planer combines industrial quality with an affordable price that will appeal to professionals and amateurs alike. THE XYLOPHILES CO. \$1.00. *Circle No. 97.*

**WOODWORKING MACHINES**—New designs that allow you to build accurate, rugged, vibration free machines. 1/4 the cost of their industrial counterparts. 10" tilting arbor table saw, 18" bandsaw, 15" inboard-outboard lathe. Send for brochure. J. M. WISE & CO. Free. *Circle No. 98.*

### HAND TOOLS

**WISE-GRIP® QUICK-LOCKING C-CLAMPS**—Self-leveling, swivel pads protect wood surfaces, while famous quick-locking action saves time and effort while clamping on any project. Brochure details 5 sizes from 4-24 in. AMERICAN TOOL CO., INC. 25¢. *Circle No. 105.*

**MAR-WOOD HARDWOODS**—In addition to our wide selection of domestic and imported hardwood lumber, we also offer a world-class selection of quality hand tools at great prices. Send for catalog. MAR-WOOD, INC. \$1.00. *Circle No. 138.*

**PERSONAL BRANDING IRONS** — Brochure describes branding irons that enable you to put your name on you work quickly and easily. Made especially for branding wood, they are available with 1, 2, or 3 lines of copy or with your logo. Changeable date also available. NOVA TOOL CO. \$1.00. *Circle No. 160.*

**THE JAPAN WOODWORKER'S 1987 CATALOG** — is loaded with the best tools you can get your hands on. In our catalog you will find a complete selection of Japanese tools for the woodcarver, carpenter, and cabinet maker. Send for catalog plus supplements for next two years. WOODLINE-THE JAPAN TOOL & SUPPLY. \$1.50. *Circle No. 190.*

### STAINS/FINISHES

**SIMPLE SYSTEMS FOR WOOD STAINING AND FINISHING** — A 24-page, 4-color booklet gives plenty of helpful tips for better results. Included are tips on how to apply a bartop finish in one day, prevent wood from yellowing, create stain colors, apply water clean up stains and finishes, and more. DEFT, INC. 50¢. *Circle No. 215.*

**PEG-1000 WHOLESALE** — Polyethylene glycol green wood stabilizer, 10 lbs. \$19.00 plus \$3.20 shipping. Send for additional information. GENERAL FINISHES. 25¢. *Circle No. 226.*

**ARTI ANILINE DYES**—Color chart features 28 aniline colors and 8 toymaker's colors. Price list and ordering instructions included. HIGHLAND HARDWARE. \$1.00. *Circle No. 232.*

**TIPS ON WOOD FINISHING** — A comprehensive, 30-page booklet includes numerous tips that save time and trouble for do-it-yourselfers. Information ranges from small repairs to restoring the finish of a priceless antique. Also included is a chart showing the full range of colors available. The name of your nearest dealer is provided. MINWAX CO., INC. Free. *Circle No. 250.*

### PLANS

**OVER 500 WOODWORKING DESIGNS** — We now offer thirty-nine packets of blueprint plans and full-size patterns with both the home and commercial craftsman in mind. Enjoy making toys, games, children's items, whirligigs, folk art, plaques, magazine racks, shelves, kitchen and household items, birdhouses, plant stands, and more. Simple enough for the beginner, fun and profitable for the pro. Send for illustrated brochure plus sample pattern. ACCENTS IN PINE. \$2.00. *Circle No. 310.*

**WOODWORKERS' PLANS AND SUPPLIES** — Wood projects are simplified with the high quality plans, specialty hardware and other supplies offered by Armor Products. Over 100 plans are available for making toys, desks, clocks, pool tables, lamps, chests, and other furniture. Movements, dials, mouldings, ornaments, and hardware also available. ARMOR PRODUCTS. \$1.00. *Circle No. 315.*

**CRAFTPLANS CATALOG**—Wide selection of ideas, plans, patterns for woodworkers. Simple bird houses, toys, weather vains, furniture, entertainment centers, computer desks and much more. CRAFTPLANS CO. 50¢. *Circle No. 325.*

**BUILD MINIATURE HORSE-DRAWN VEHICLES**—The Concord Stagecoach symbol of the Old West, the Conestoga Covered Wagon, and the Prairie Schooner are some of the vehicles you can build using our plans in 1/12 and 1/8 scale. Concord Coach and Conestoga are available in full size 1" scale cutting patterns. Also English vehicles, some in 1/20 scale cutting patterns excellent for beginners. Ready-made plastic wheels available for 1/20 scale vehicles. Also books featuring from England, "Making Horse-Drawn Vehicles" by John Thompson, who has done extensive work in this area. CRISS-CROSS CREATIONS. \$1.00. *Circle No. 332.*

**PATTERNS BY DESIGN GROUP** — Hundreds of interesting, useful and fun items to create for personal use or profitable sale. Our newest catalog contains plans for toys, games, plaques, puzzles, birdhouses, planters, furniture, and much more! All Design Group patterns are professional, "same size" blueprints. No enlarging or reducing is necessary. Simply trace outline of item onto wood and create! Started in 1977, Design Group has sold thousands of patterns to thousands of satisfied customers. Prices start at



## Our 10th ANNIVERSARY Gift To You!

ACT NOW! Buy 1-Doz. Belts at 1986 Prices.

# 12 Get 6 Belts FREE!

(OFFER GOOD ONLY UNTIL DEC. 31, 1988. NOT VALID WITH OTHER COUPONS OR SPECIALS.)

Available in 36, 40, 50, 60, 80, 100, 120, 150, 180, 220, 240, 320 grit sizes. Please specify when ordering. We will ship an assortment of 24 Fine, Medium and Coarse unless otherwise specified.

- 1" x 30" ..... \$13.70/doz.
- 1" x 42" ..... \$13.75/doz.
- 1" x 44" ..... \$13.80/doz.
- 2 1/2" x 16" ..... \$14.50/doz.
- 3" x 18" ..... \$14.75/doz.
- 3" x 21" ..... \$15.25/doz.
- 3" x 23 3/4" ..... \$15.70/doz.
- 3" x 24" ..... \$15.75/doz.
- 3" x 27" ..... \$16.25/doz.
- 4" x 21 3/4" ..... \$17.75/doz.
- 4" x 24" ..... \$18.25/doz.
- 4" x 36" ..... \$21.95/doz.
- 6" x 48" ..... \$27.95/1/2 doz.

(6 FREE)

**STIKY DISC, Rugged Cloth,** available in 50, 60, 120, 180, 240 grit size.

- 6" diameter ..... \$1.00 each
- 8" diameter ..... 1.25 each
- 9" diameter ..... 1.50 each
- 12" diameter ..... 2.00 each

### 9" x 11" PAPER SHEETS

A/O Cabinet Paper

- |       |                                   |                                   |
|-------|-----------------------------------|-----------------------------------|
|       | 50/pk.                            | 100/pk.                           |
| 40-D  | <input type="checkbox"/> \$17/pk. | <input type="checkbox"/> \$31/pk. |
| 50-D  | <input type="checkbox"/> 16/pk.   | <input type="checkbox"/> 28/pk.   |
| 60-D  | <input type="checkbox"/> 15/pk.   | <input type="checkbox"/> 26/pk.   |
| 80-D  | <input type="checkbox"/> 14/pk.   | <input type="checkbox"/> 24/pk.   |
| 100-C | <input type="checkbox"/> 13/pk.   | <input type="checkbox"/> 22/pk.   |
| 120-C | <input type="checkbox"/> 13/pk.   | <input type="checkbox"/> 22/pk.   |
| 150-C | <input type="checkbox"/> 13/pk.   | <input type="checkbox"/> 22/pk.   |

No Load Finishing Paper

- |       |                                   |                                   |
|-------|-----------------------------------|-----------------------------------|
|       | 50/pk.                            | 100/pk.                           |
| 180-A | <input type="checkbox"/> \$11/pk. | <input type="checkbox"/> \$19/pk. |
| 220-A | <input type="checkbox"/> 11/pk.   | <input type="checkbox"/> 19/pk.   |
| 280-A | <input type="checkbox"/> 11/pk.   | <input type="checkbox"/> 19/pk.   |
| 320-A | <input type="checkbox"/> 11/pk.   | <input type="checkbox"/> 19/pk.   |
| 400-A | <input type="checkbox"/> 11/pk.   | <input type="checkbox"/> 19/pk.   |

Wet or Dry S/C Paper

- |       |                                   |                                   |
|-------|-----------------------------------|-----------------------------------|
|       | 50/pk.                            | 100/pk.                           |
| 220-A | <input type="checkbox"/> \$15/pk. | <input type="checkbox"/> \$25/pk. |
| 320-A | <input type="checkbox"/> 15/pk.   | <input type="checkbox"/> 25/pk.   |
| 400-A | <input type="checkbox"/> 15/pk.   | <input type="checkbox"/> 25/pk.   |
| 600-A | <input type="checkbox"/> 15/pk.   | <input type="checkbox"/> 25/pk.   |



Our thank you for your support. We are celebrating our 10th Year supplying Belts and Sanding Accessories direct to the Woodworker.

- MONEY BACK GUARANTEE
- PROMPT DELIVERY FROM STOCK

**INDUSTRIAL  
BRASIVES CO.**  
643 N. 8th STREET  
READING, PA 19612

For Fast Delivery Call Toll Free  
1-800-428-2222 (U.S.A.)  
1-800-222-2292 (PA only)

SEND FOR FREE CATALOG

SHIPPING CHARGES -

Under \$35 add \$2.50. \$35 or more add \$4.00. PA residents add 6% sales tax.

MONEY ORDER  MASTERCARD  VISA  CHECK

Acct. # \_\_\_\_\_ Exp. Date \_\_\_\_\_

Name \_\_\_\_\_ PLEASE PRINT

Street \_\_\_\_\_

City \_\_\_\_\_ State \_\_\_\_\_

Zip \_\_\_\_\_ DAYTIME PHONE ( ) \_\_\_\_\_

## MANNY'S WOODWORKER'S PLACE LEXINGTON, KY

has

SALE  
ON

## WOODWORKING BOOKS & VIDEOS

All Prices Post Paid  
Toll Free 1-800-243-0713  
VISA, MC, Checks, add \$3 C.O.D.  
Catalog only \$2



Tips & Techniques for Builders \$9  
Technique 1-9 \$18 ea; All 9 for \$155  
Fine Woodworking On - (Series of 20 books)  
\$7 ea; All 20 for \$135  
Tape Frid Teaches Woodworking - Book 1-3  
\$19 ea; All 3 for \$48  
Workbench Book \$22; Timberframe Hse. \$22  
Construction Techniques 1 or 2 \$23 ea  
Understanding Wood (Hoadley) \$22  
Setting Ceramic Tile (Byrne) \$17  
Design 4 \$16; Design 3 \$13; Design 2 \$12  
Biennial Design \$11; All 4 Design Books \$50  
Turning Wood (Raffan) \$16  
Turned Bowl Design \$16  
How to Carve Wood (Butz) \$13  
Making Kitchen Cabinets-NEW (Levine) \$17  
Building Your Own Kitchen Cabinets  
(Cary) \$13  
Japanese Woodworking Tools (Odate) \$22  
Building a Houseful of Furniture (Watts) \$18  
Federal Furniture (Dunbar) \$13  
Soul of a Tree (Nakashima) \$58  
Sam Maloof, Woodworker \$58  
Roy Underhill - The Woodwright's Shop  
Woodwright's Companion or Woodwright's  
Workbook \$12 ea; All 3 for \$35

Contemporary American Woodworkers \$28  
Cabinetmaking, Professional Approach.  
(Peters) \$28  
Cabinetmaking & Millwork - New Edition  
(Feirer) \$43  
James Krenov Books - Call for Availability  
Router Jigs and Technique (Spielman) \$14  
Router Handbook (Spielman) \$10  
Scroll Saw Pattern Book 12: Scroll Saw  
Handbook \$12  
Encyclopedia of Furnituremaking (Joyce) \$28  
Wood Finishing (George Frank) \$19  
Projects for the Router (Chaffin) \$9  
The Router (Rosenthal) \$14  
200 Original Shop Aids (deCristoforo) \$14  
Stationary Power Tool Tech  
(deCristoforo) \$14  
Table Saw or Radial Armsaw Tech  
(Cliffe) \$14 ea.  
Making Woodworking Aids & Devices \$9  
Precision Machinery Techniques \$9  
Gluing and Clamping (Spielman) \$12  
Making Wood Boxes with Bandsaw \$9  
Making Small Wooden Boxes \$9  
Making Wood Banks \$7  
Guilmaking (Cumbiano) \$55

Sculpting Wood (Lindquist) \$28  
Woodturning, A Designer's Notebook  
(Key) \$12  
Woodturner's Project Book (Jones) \$12  
Small and Unusual Woodturning Projects  
(Jacobson) \$12  
Dale Nish - Creative Woodturning \$14:  
Artistic Woodturning \$17; Master  
Woodturners \$19; All 3 by Nish \$48  
The Practices of Woodturning (Darlow) \$21  
The Craft of Woodturning (Sainsbury) \$11  
Polychromatic Assembly for  
Woodturning \$16  
How to Make Animated Toys \$12  
Toymaker's Wooden Vehicles  
(Buckland) \$12  
Blizzard's Dazzling Wooden Toys \$12  
How to Make Shaker Furniture (Moser) \$12  
Measured Shop Drawings of American  
Furniture (Moser) \$14  
Thos. Moser's Windsor Chairmaking \$9  
Antique Country Furniture of North America  
(Shea) \$18  
Masterpiece Furniture Making  
(Gottshall) \$27  
101 Projects for Woodworkers \$14  
World Woods in Color (Lincoln) \$37  
Know Your Woods (Constantine) \$13  
Handcrafted Shelves & Cabinets  
(Rowland) \$14  
Handcrafted Doors & Windows  
(Rowland) \$14  
A Treatise on Stairbuilding and  
Handrailing \$21  
Building Ship Models \$8  
Computer Furniture, Plans & Projects \$15

## VIDEOS VHS Only

Levine - Making Kitchen Cabinets \$28  
Roger Cliffe - Faceplate Cabinetmaking  
Series of 5 tapes \$30 ea; All 5 for \$135  
Call for information.  
Cliffe - Table Saw or Radial Arm Saw  
Tech. \$29 ea.  
Krenov - Wooden Planes & Cabinetmaking  
Scrapers \$38  
Maas - Router Jigs & Techniques \$28  
Rosenthal - Router Basics; Router Jigs &  
Accessories; Table Mounting Your Router  
\$38 ea; 3 for \$110  
Raffan - Turning Wood \$38  
Stubbs - Bowl Turning \$38  
Bush - Carving Techniques & Projects \$28  
Barton - Chip Carving \$28  
Byrne - Tiling Countertops; Tiling Walls;  
Tiling Floors \$28 ea; 3 for \$80  
Roy Underhill - Shop Planes; Chairmaking;  
Log & Timberframe Building \$38 ea.  
Klausz - Mortice & Tenon Joints \$28  
Klausz - Dovetail & Drawer \$28  
Klausz - Wood Finishing \$38  
Cummins - Small Shop Tips & Tech. \$28  
Flexner - Repairing Furniture \$28  
Lowe - Carve a Ball & Claw Foot \$38  
Erpelding - Radial Arm Saw Joinery \$38  
Parko - Learn Woodworking, Make a Blanket  
Chest \$37  
Rogers - Molding & Picture Frames \$22  
Rogers - Building Bookcases - \$22  
Rogers - Building Cabinets \$22  
Rogers - Building Tables \$22  
Rogers - Furniture Refinishing \$22

Foreign Orders Welcome, Canada add 5%; Japan, Europe, etc. add 10% for Shipping

**MANNY'S WOODWORKER'S PLACE**  
602 S. Broadway, Lexington, KY 40508

Inquiries (606) 255-5444  
Hours 9-5:30 Mon.-Sat.

The Cutting Edge by  
**DRI-COTE™**



DRI-COTE is the finest lubricant ever developed for the wood working industry. It is a superb lubricant for lead screws, worm gears and other moving parts. It will protect cutting tools and steel table tops from corrosion as well as bond to saw blades to prevent resin build up. The result is finer cuts and prolonged blade life without contaminating the wood. DRI-COTE is by far the ideal product for any wood shop as it satisfies the needs of any amateur or professional.

DRI-COTE, 10 oz. spray bottle \$9.95 + \$2 shipping from Sandaro Industries, 20 Galli Dr., Suite J, Novato, CA 94949. CA residents add sales tax. 1-800-999-7009

**RING MASTER**

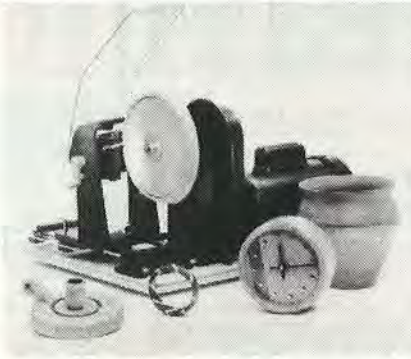

**TEST YOUR IMAGINATION**

Create Any Hollow Cylindrical Shape up to 12" dia. Cut flat wood into straight or angle rings, stack rings, glue, sand, & finish, All on your Ring Master.

Now Ring Master Attaches To Your

- SHOPSMTIH MARK V
- CRAFTSMAN 12" LATHE

ORDER YOUR **FREE BROCHURE TODAY**

We accept Master Card, Visa, & C.O.D.  
Call 800 894-9815 in NC 919 762-6334



Porta-Nails, Inc., P.O. Box 1257, Wilmington, NC 28402

**BYROM™**



1/2" SHANK 12 PIECE  
CARBIDE ROUTER  
BIT SET WITH SOLID  
BLACK WALNUT WOOD CASE



CALL FOR THE PARTICIPATING  
DEALER NEAREST YOU

**800-722-5447**

38" High  
Solid Wood



**Rocking Horse Kit**

Build this beautiful 38" rocking horse yourself, and have a family heirloom. Our rocking horse kit includes solid wood parts cut and shaped, with all trim included, for only \$69.00 ppd. Check or M.O. accepted.

Tampa Wood Products, Inc.  
P.O. Box 14427, Tampa, Florida 33690  
Phone: (813) 251-6583

**Woodworking Tools  
of Exceptional  
Quality**



You can buy woodworking tools in any hardware store that will help you cut, shape, join and finish almost any project — but they'll be items that are mass-produced by companies whose only concern is producing a product as cheaply as possible. Yet when you want a chisel of Sheffield steel that holds a fine edge you can shave with... a gouge that obeys your hands like your fingers, bringing out all your skill... a truly balanced plane that fairly sings through the work — where do you look?

Since 1928, we have searched the world for tools you don't just buy, but adopt; tools made by craftsmen for craftsmen, classics of lifetime quality for people who love to work with their hands...carvers, cabinetmakers, finishers, hobbyists, builders, teachers. Our catalog details over 4,000 tools; our stores have even more.

For your Free copy of the Woodcraft catalog write:



WOODCRAFT SUPPLY CORP.  
Dept. WBH98  
41 Atlantic Avenue, Box 4000  
Woburn, Massachusetts 01888

**CALL TOLL FREE!!**



Learn all about combination machine woodworking. Free color catalog and other material available. Tremendous Savings. Expands your workshop area by 90 percent.



1-800-535-4788 USA  
1-800-325-8330 CA

Sleeveless  
**DRUM SANDER**

Uses regular sandpaper — no pre-made sleeves to buy!



**Lifetime Guarantee**

USE ON:  
Drill press, motor, lathe,  
combo-tools, radial saw, drills.

Twist of key tightens sandpaper to drum. Rubber backing insures long sandpaper wear.	
1" x 3" long	\$13.95
2" x 3" long	\$15.95
2 1/2" x 3" long	\$16.95
3" x 3" long	\$17.95
1" and 2 1/2" above	\$27.95
Set of 4 above	\$56.95
3/4" x 3" long	\$14.95
2 1/2" x 4 1/2" long	\$21.95
3" x 4 1/2" long	\$23.95
2 1/2" x 6" long	\$25.95
3" x 6" long	\$27.95
Add \$2.50 per order for shipping.	

AVAILABLE WITH:  
\* 1/2" bore with 1/2" or 1/4" shaft  
\* 1/2-20 RH thread (except 3/4" x 3")  
\* 5/8" bore (except 3/4" x 3" and 2" x 3")

MC, Visa, Check or Money order to:  
**SINGLEY SPECIALTY CO. INC.**  
P.O. BOX 5087B, GREENSBORO, NC 27403  
CALL: (919) 852-8581

**WOOD TOY**



- ★ Patterns
- ★ Parts
- ★ Wheels
- ★ Many New Patterns to Choose from.
- ★ Executive toys

SEND \$1.00 FOR NEW CATALOG & RECEIVE COUPON FOR FREE WHEELS & AXLE PEGS.

**toys and joys**

Box 628W Lynden, Wash. 98264



\$1.00, all patterns come with a full money-back guarantee. Wholesale and bulk prices are available on request. Fully illustrated catalog. DESIGN GROUP, \$1.00. Circle No. 340.

**FULL-SIZE FURNITURE PLANS CATALOG** — Illustrates and describes over 200 plans for making furniture of quality found in museums and fine furniture stores. Plans include rolltop desk, cradles, dining tables, chairs, buffets, chests, gun cabinets, poker table, children's furniture, rocking horse, spinning wheels, and more. Bill of materials exploded drawings assist the woodworker. FURNITURE DESIGNS, INC. \$2.00. Circle No. 345.

**STICKLER FOR DETAIL?**—At last an exciting new line of realistic wood block models that you can build with your own scrap wood and dowels and my easy-to-follow instructions. Highly detailed plans for a 20x8¾-in. dump truck. GATTO PLAN SUPPLY. \$8.00. Circle No. 355.

**COUNTRY FURNITURE PLANS** — Our catalog features 30 designs—from a corner cupboard to an icebox. Our new book on finishing and refinishing will show you how to finish projects like the pros. Also included are various products for the home workshopper. Send for our latest catalog (price of catalog deductible from first order). HAMMER-MARK ASSOCIATES. \$1.00. Circle No. 370.

**WOODWORKING PLANS** — Catalog of full-size plans printed on heavy paper for toys, gifts, novelties, action windmills, shelves, birdhouses, garden furniture, Dutch windmill, lawn ornaments, old-fashioned lawn swing, jigsaw projects for children, and more. MASTERCRAFT PLANS WEST. \$1.00 (refunded with first order). Circle No. 390.

**ANIPUZZLE ONE-OF-A-KIND, CHALLENGING WOODWORKER'S PROJECT**—Plans, full-size assembly drawing, and construction and finishing tips to build multi-piece, three dimensional animal puzzles. Plans for bear and pig puzzles available. These unique puzzles are built from standard dimension lumber and the approximate finished size is 12¾" L x 4½" W x 7¾" H. Perfect for display or play! Send for price list and descriptions. PKR CORP. Free. Circle No. 410.

**FULL SIZE PLANS**—for fine furniture, home accessories, and toys featuring *Plan Plus*—the plan complete with hardware and hard-to-find components. "All American Tool Collection" spotlights shop-tested tools made in USA. 16-page catalog; price refunded with first order. RJS CUSTOM WOODWORKING. \$1.00. Circle No. 424.

**CREATE FUN & PROFITABLE WOODCRAFTS**—Popular folk-art, toys, decorative country items, old fashioned St. Nicks. 20-page catalog is overflowing with over 400 original projects for all skill levels. Full size blueprint patterns eliminate tedious enlarging—giving you more time to enjoy actual woodworking. THE WINFIELD COLLECTION. \$1.00. Circle No. 480.

**PROJECT PLANS FOR WOODWORKERS** — We have expanded our line. By special arrangement with Meredith Corp. and Better Homes and Gardens® magazine, we have added a series of plans originally designed by David Ashe. These plans have appeared in Better Homes and Gardens® magazine and are a proven favorite among woodworkers across the country. All of our plans are designed using readily available materials, keeping in mind standard sizes of lumber. Instructions are clear and concise, and occasionally include tips that will make your job easier. Order our catalog now and get started! THE WORKSHOP BLUE-PRINT CO. \$2.00. Circle No. 485.

## LUMBER

**QUALITY EXOTIC LUMBER/TURNING WOODS**—We offer a comprehensive selection of fine quality exotic woods: Ebony, Kingwood, Tulipwood, Snakewood, African Blackwood, Cocobolo, Bloodwood, Figured Maple, Spalted Maple, Padauk, etc. Unique and unusual turning woods and burls are also available. Send for catalog. BÉREA HARDWOODS. \$1.00. Circle No. 510.

**WOODWORKERS! HELP CELEBRATE OUR 58TH YEAR OF SERVICE** — Send for our new 148-page Craftsman 1987-88 Catalog #54. 42 varieties of choice hardwoods 1/64 in. to 4-in. thickness. Fine hardwood veneers, tools, moldings, trim, marquetry inlays, upholstery and lamp supplies, finishes, clock kits, and hard-to-find hardware. 4,000-plus items for your projects. CRAFTSMAN WOOD SERVICE CO. \$1.00. Circle No. 520.

**EdLco — WE KNOW OUR LUMBER** — Educational Lumber Company is pleased to offer you our new catalog, stacked with excellent buys at delivered prices. Available to you are over 21 species of imported as well as domestic hardwoods, softwoods, turnings, shorts, veneers. All our lumber is kiln dried. As school shop suppliers for 35 years, we know our lumber. It is top-grade. Send today and receive your BONUS GIFT: 4 new furniture designs. EDUCATIONAL LUMBER CO., Inc. \$2.00. Circle No. 530.

**RARE AND EXOTIC TROPICAL HARDWOODS**—for the serious turner and woodworker. Largest commercial selection of hard-to-find heavyweight dimensions in the U.S. Includes rare Macassar Ebony as well as Bocote, Brazilwood, Cocobolo, Primavera, Courbaril, Paldao, Lignum Vitae, Ziricote, Kingwood, and others. Turning Stock and some lumber. Wholesale and retail. Best prices from Direct Importer. Color catalogue with prices, description and inventory. ART EISENBRAND, INC. \$1.00 (refundable). Circle No. 535.

**THIN LUMBER** — Approximately 20 species of thin lumber, widths vary up to ¾-in. Kiln dried. Turning squares. Send for price list. HARDWOODS OF ILLINOIS. 50¢. Circle No. 545.



## FREE CLOCK KIT CATALOG!

FROM

**VIKING**  
Quality Clock Kits

**SAVE XTRA 10%**  
BUY ANY 3 or MORE KITS

- Factory Direct Grandfather Clocks
- Assembled Clocks
- Clock Kits

Our catalog is filled with factory direct clocks and clock kits, now you can have our catalog ABSOLUTELY FREE. Just call our toll free number or fill in this coupon and mail it today! To: Viking Quality Clock Kits, P.O. Box 1139, Dept. WD108, Fairhope, AL 36533.

CALL TOLL FREE  
For Customer Service

**1-800-321-1089**

If Busy: 205/928-3466

Please Print Clearly

NAME.....

ADDRESS.....

CITY.....

STATE.....ZIP.....

**Van Dyke's**

Presents a  
Catalog

with supplies for  
upholstery, antique  
restoration, wood  
working, caning,  
brass hardware,  
carvings and many  
related trades!

36 Years in Creative Arts & Trades

Many Hard-To-Find Items!

SEND \$1.00 FOR CATALOG TO:

**Van Dyke's Restorers**

Dept. D55 · Woonsocket, SD 57385



**FULL SIZE  
WOODCRAFT  
PATTERNS**

SIMPLE TO MAKE ★ FUN ★ PROFITABLE

- 200 pattern packet for scroll, band & jigsaws
- "Country Critters"-100 patterns, unique projects
- 6 enjoyable "Wind-Action" whirligigs
- "Country Classics" - best selling country projects
- 100 yard ornaments, animals, birds and more
- 17 "Show Stoppers" - craft show best sellers

Send \$7.00 per blueprint packet or  
choose any 3 FOR ONLY \$14.00.

Fast Service • Satisfaction Guaranteed!

**ACCENTS** Dept. MA98, Box 7387, Gonic, NH 03867

Catalog of 1000 patterns - \$1.00 (Free with order)

# WHY NOT?

Why not shop a full line of planes, jigs, handsaws, sharpening materials, stunning workbenches of tropical woods, and more?

We have tools for every budget as well as for most user preferences, and woodworkers coast-to-coast rave about our periodic closeout sales!

*the Fine Tool Shops*

Send the coupon below along with \$1. We'll rush a current Fine Tool Shops catalog and a coupon worth \$5 off your next order.

NAME

ADDRESS

CITY / STATE / ZIP

Mail To: P.O. Box 7091  
Dept. BHG9  
Portsmouth, NH 03801

## OLSON Saw Blades And Woodworking SUPPLIES

There's only one source that delivers the finest quality woodcutting supplies. For over 60 years the Olson Saw Company has been the choice of smart professionals everywhere.

Send for our FREE mail order catalog and SAVE on a complete selection of band, scroll, fret, carbide tipped circular saw blades, wood bits and sanding accessories.



Name \_\_\_\_\_

Address \_\_\_\_\_

City \_\_\_\_\_

State \_\_\_\_\_ Zip \_\_\_\_\_



**Olson Catalog Sales**  
Dept. WM  
Bethel, CT 06801  
203-792-8622

## MAKE BEAUTIFUL RAISED PANEL DOORS . . . WITH YOUR 1/4" ROUTER!

Professional production quality bit makes it quick and easy to produce matching rails and stiles — the panel raising bit with ball bearing guide makes the raised panel perfect every time.

Regular value Over \$150.00

SALE PRICE **\$69<sup>95</sup>** FOR COMPLETE SET

ORDER ITEM #054 for 1/4" Shank Set  
(Includes all bits shown)

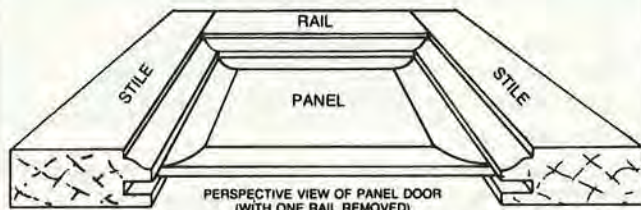

PERSPECTIVE VIEW OF PANEL DOOR  
(WITH ONE RAIL REMOVED)

**RAISED PANEL BIT**  
SUPPLIED WITH  
BALL BEARING

2" Large Diameter

CARBIDE TIPPED  
1/4" Shank

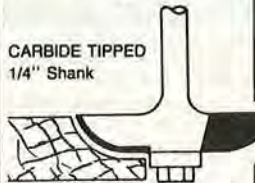

**REVERSIBLE  
COMBINATION  
RAIL and STILE BIT**

(For making matching rails and stiles in  
raised panel doors, etc.)  
Works with stock from  
11/16" to 7/8" thick

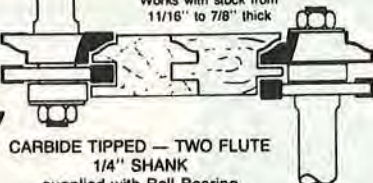

CARBIDE TIPPED — TWO FLUTE  
1/4" SHANK  
supplied with Ball Bearing

To order by Mastercard or Visa Toll Free  
7 Day—24 Hour Order Service, Call  
1-800-533-9298

or send check to: **MLCS, Ltd., P.O. Box 4053D, Rydal, PA 19046**

**LARGEST SELECTION EXOTIC HARD AND SOFT WOODS**—When in Florida come see us or send for our price list of Florida's largest and most unbelievable selection of exotic imported and native hard and soft woods, table slabs and veneers. We also stock Ashley Isles carving tools, Watco danish oil finishes, and a complete line of Deft products. **HENEGAN'S WOODSHED**. \$1.00. *Circle No. 547.*

**THE BEST LUMBER AT THE RIGHT PRICE**—Located in close proximity to some of the most ideal growing ranges for Red Oak, Pennsylvania grade Cherry, Hard Maple, Ash, Poplar, and other hardwoods, we can supply your needs with the highest quality hardwoods. Our experience in hardwood purchasing and our dedication to keeping our overhead low is your guarantee of low prices. No minimum order. Retail and wholesale. Send for 20-page catalog. **NORTH EASTERN HARDWOODS**. \$2.00. *Circle No. 563.*

**LUMBER DRYING**—Nyle Corp., the largest manufacturer in the United States of dehumidification Dry Kiln Systems, offers *Introduction to Dehumidification Lumber Drying*. **NYLE CORP.** Free. *Circle No. 565.*

**RARE IMPORTED EXOTIC AND DOMESTIC HARDWOODS**—The world renowned Martin Guitar Co. sells wholesale and retail exotic wood (4/4, 6/4, 8/4) and sawn veneers (1/4" & 3/4" Sanded Stock), plus guitar parts, kits, accessories and second quality guitars. Send for catalog. **SAWMILL/WOODWORKER'S DREAM**. \$1.00. *Circle No. 578.*

## GENERAL WOODWORKING CATALOGS

**TOOL CATALOG**—Available from Anglo American Enterprises, the world famous Record Marples Tool Catalog featuring the finest woodworking tools available. Send for catalog and price list. **ANGLO AMERICAN ENTERPRISES CORP.** \$2.00. *Circle No. 803.*

**EVERYTHING FOR THE WOODWORKER**—Wide selection of woodworking supplies, including candle cups and shaker pegs. Price of catalog is refundable with order. **BENNY'S WOODWORKS**. \$1.00. *Circle No. 810.*

**FROM HAND TOOLS TO SMALL MACHINES**—from power tools to complete shops. We have the woodworking machines, tools and supplies for amateur-professional woodworkers! Minimax, Ryobi, DML, Vega, Paralok Fences, and Bosch are just a few. Send for 70-page catalog and literature. **M. CHANDLER & CO.** Free. *Circle No. 818.*

**FINE WOODS AND WOODWORKING SUPPLIES**—Constantine's catalog for woodworkers offers 116 pages, many in full color, of 150 kinds of veneers, over 250 sizes of

fine cabinet woods. Decorative inlays, mouldings, cabinet hardware, caning materials. Specialty woodworking tools, wood finishes, plans and books. Serving the woodworker since 1812. **ALBERT CONSTANTINE AND SON, INC.** \$1.00. *Circle No. 820.*

**FREE WOODWORKING CATALOG**—Buy planers, table saws, scroll saws. Direct from the factory and save. Plus portable tools, hand tools and accessories. Send for free catalog. **FOLEY-BELSAW CO.** Free. *Circle No. 852.*

**WOODWORKING MACHINERY CATALOG**—Planers, jointers, tablesaws, shapers, drill presses, sanders and much, much more. Buy direct from importer at super low prices. Full color catalog. **GRIZZLY IMPORTS, INC.** Free. *Circle No. 860.*

**PLANERS**—Heavy duty 15x6 in. planers with 2 hp. single-phase motors. Other woodworking equipment at low, low prices. Send for full color catalog. **GRIZZLY IMPORTS, INC.** Free. *Circle No. 861.*

**DUST COLLECTORS**—for the small/medium size shop. Capable of handling from 1 to 3 machines at the same time. Priced within the home shop budget, yet capable of handling cabinet shopwork. Other woodworking machinery and tools — low prices. Send for full color catalog. **GRIZZLY IMPORTS, INC.** Free. *Circle No. 862.*

**THE 1987 HILLER HARDWARE CATALOG**—is a comprehensive collection of tools & accessories for you. Selected from the best quality tools in the business at a price only a volume supplier can provide. Power tools, hand tools, cutters, blades, & accessories. 24 pages, over 240 tools! **HILLER HARDWARE**. \$1.00. *Circle No. 875.*

**WOODWORKING TOOLS, MACHINERY, & SUPPLIES**—W. S. Jenks & Son's new 128 page source book is packed with a full range of tools for the serious woodworker, from hand tools, to portable power tools, to woodworking machinery. Includes many imported and hard to find tools, from the best manufacturers at the most competitive prices. Send for catalog. **W. S. JENKS & SON**. \$2.00 (refundable with first order). *Circle No. 877.*

**LEICHTUNG WORKSHOPS**—Discover fine woodworking and cabinet-making tools and hardware in our 102-page color catalog. For example: Our exclusively-designed 4-way Equi-Pressure Clamp, Cabinet Maker's Vice, plus Brad-Point and Forstner Bits. **LEICHTUNG WORKSHOPS**. \$1.00. *Circle No. 878.*

**FINE WOODWORKING TOOLS CATALOG**—Lee Valley Tools catalog of fine woodworking tools and accessories has become a standard reference for woodworkers. It is a superb production containing over 400 professional photographs complemented by objective, straight-forward product designs and technical information on woodworking tools of all kinds. 232 pages, 8 1/2 x 11 size. **LEE VALLEY TOOLS LTD.** \$5.00. *Circle No. 879.*

## Have a problem with your subscription?

We want to solve it to your complete satisfaction, and we want to do it fast. Please write to: Robert Austin, *Better Homes and Gardens*® WOOD, P.O. Box 10628, Des Moines, Iowa 50336.

You can help us by attaching your magazine label here, or copy your name and address as it appears on your label. Send this along with your correspondence.

Name \_\_\_\_\_  
Address \_\_\_\_\_ Apt. # \_\_\_\_\_  
City \_\_\_\_\_ State \_\_\_\_\_ Zip \_\_\_\_\_

## Moving?

Simply attach the mailing label from this magazine and write in your new address below. (Please allow 4-8 weeks.)

Name \_\_\_\_\_  
Address \_\_\_\_\_ Apt. # \_\_\_\_\_  
City \_\_\_\_\_ State \_\_\_\_\_ Zip \_\_\_\_\_

## For Fast Service...

...it is better to write us concerning your problem and include the magazine label. Also, address changes are handled more efficiently by mail. However, should you need to reach us quickly the following toll-free number is available:

1-800-678-2666

## Subscription Rate:

6 issues — 1 year — \$18. Add \$6 for  
Canadian or foreign orders.

Renewal  New Order

# WOOD

P.O. Box 10628 • Des Moines, Iowa 50336

**WOODWORKING BOOKS AT DISCOUNT PRICES**—Most complete listing of books for woodworkers. Each book is discounted from 10 to 25% off the cover price. There is absolutely no shipping and handling charge. Woodworking, carving, turning, project books by authors such as Krenov, Frid, Spielman, Nish, Tangerman, and Hoedley are listed along with many hard-to-find titles. **MANNY'S WOODWORKER'S PLACE**. \$2.00. *Circle No. 880.*

**WOODWORKING SUPPLIES CATALOG**—Send now for new 68 page color catalog hardwoods, carving & turning stock, thin lumber, foreign and domestic veneers, flexible veneers, pressure sensitive veneers and edgings, patterns, spindles, dowels, wheels, domestic and imported tools and supplies, cane, books, candle cups, mug pegs, shaker pegs, inlays custom made veneers and plywoods, small box hardware, reproduction brass hardware, doweling jigs, forstners, Brad bits, dovetailing and mitering accessories, handtools, etc. **BOB MORGAN WOODWORKING SUPPLIES**. \$1.00. *Circle No. 890.*

**WOODWORKING TOOL CATALOGS**—R.A. Ness & Co., the Woodworkers Emporium, offers a 2-year subscription, a total of eight huge sale catalogs. Thousands of industrial quality items — machinery, hand tools, portable electric tools, and supplies — are featured at super sale prices. The fee is refundable with purchase. **R. A. NESS & CO.**, the Woodworkers Emporium. \$4.00. *Circle No. 900.*

**WOODWORKING TOOLS! POWER & HAND TOOLS AT DISCOUNT PRICES**—Blades & accessories. Portable sawmills. Tool cabinets & chests. Substantial savings on Dremel, Milwaukee, Delta, Skil, Makita, Ryobi, Shop-Vac & other famous brands. Send for 132-page catalog. **NORTHERN HYDRAULICS**. \$1.00. *Circle No. 903.*

**ATTENTION WOODWORKERS**—You can have a catalog on new woodworking tools with big discounts on top name tools and accessories. We stock these items for immediate delivery. **PUCKETT ELECTRIC TOOLS**. 50¢. *Circle No. 912.*

**RENOVATOR'S SUPPLY**—America's Number One source for elegant, old-style reproductions at factory-direct prices! 48 colorful pages of door, window and cabinet hardware; lighting and bathroom fixtures; and gifts for the home in brass, oak, porcelain and wrought iron. **RENOVATOR'S SUPPLY**. \$3.00. *Circle No. 915.*

**TOOLS ON SALE**—A division of Seven Corners Ace Hardware Inc. offers a comprehensive catalog featuring over 350 pages of the most competitive prices in the industry. If you're looking for savings and fast delivery on over 3000 items, request our catalog. This catalog offers one of the most complete selections of power tools available anywhere from the most respected manufacturers in the industry: Milwaukee, Makita, Porter-Cable, Black & Decker, Freud, Bosch, Delta, and many more. **SEVEN CORNERS ACE HARDWARE**. \$1.00. *Circle No. 920.*

**THE SOURCE, FOR ALL YOUR CABINET MAKING NEEDS**—New 170-page catalog of fine hand and power

tools for cabinet makers and serious woodworkers. Features 3 sections on hardware, supplies, and cutting tools. This catalog takes the mystery out of using European hardware. A must reference for the woodworker. THE SOURCE, \$3.00. Circle No. 935.

**TOOL CITY CATALOG HAS THE TOOL OR ACCESSORY FOR YOU**—The 500-page 1987-88 Tool City Catalog is the most complete mail order catalog. It features a comprehensive selection of stationary & portable power tools; hand tools, tool accessories, hardware parts, woodworking books, and shop equipment. Priced to save you money in all categories. TOOL CITY. \$5.00. Circle No. 945.

**FREE CATALOG** — For woodworkers and carvers—it's one of the best sources for quality woodworking and carving tools. You'll find everything from bit braces to wood borers, from saws to sharpening stones. Every product is sold postage-paid and satisfaction guaranteed. WOODCRAFT SUPPLY CORP. Free Circle No. 955.

**THE WOODWORKERS STORE**—A hundred and fourteen pages of hardwoods, veneers, wood parts, specialty hardware, kitchen accessories, finishing supplies, tools, books, and plans. Orders shipped within 48 hours. Customer satisfaction guaranteed. WOODWORKERS STORE. \$1.00. Circle No. 965.

**WOODWORKERS SUPPLY** — Offers high quality tools and supplies for skilled, amateur, and professional woodworkers. Our complete catalog includes machinery, hand tools, plans, router bits, shaper cutters, wood specialties, and more. For your two year subscription send to WOODWORKERS SUPPLY OF NEW MEXICO. Free. Circle No. 975.

## KITS

**CANOPY BEDS, WINDSOR CHAIRS, PLUS SHAKER AND QUEEN ANNE**—museum reproductions lavishly presented with coordinated fabrics, paints, lighting, pewter, and brass. Furniture available assembled finished or ready to assemble kits. Since 1949, Cohasset Colonials is the oldest and largest manufacturer of reproduction furniture kits. State-of-the-art joinery insures easy assembly. Custom curtains, bed hangings, quilts, fishnet canopies. Color catalog subscription. COHASSET COLONIALS. \$2.00. Circle No. 1015.

**MODEL BOATS**—Our colorful catalog illustrates an extensive line of radio-controlled sailboats, speedboats, and scale models. Descriptions also include running hardware kits, motors, accessories, and information about radio-controlled clubs and associations. Plus how to get an 11-min. video cassette which captures the speed and beauty of our most popular models. DUMAS PRODUCTS. \$1.00. Circle No. 1023.

**FACTORY DIRECT GRANDFATHER CLOCKS**—Build a magnificent grandfather clock kit from world's largest manufacturer. Clocks are made of solid 3/4" hardwoods, primarily walnut, oak and cherry. West German-made solid brass movements. Send for color catalog showing our selection of grandfather clocks, furniture and home accent pieces. Buy direct from factory and save. EMPEROR CLOCK CO. \$1.00. Circle No. 1030.

**QUALITY CLOCK KITS AND PLANS** — Handmade and semi-assembled of carefully selected 3/4 in. cherry, oak, or walnut with beveled glass. Or build from "scratch" using our detailed plans and trim pieces. Choice of quality movements. Established in 1916. KUEMPEL CHIME CLOCK WORKS. \$2.00. Circle No. 1050.

**WOODEN SHIP MODELS** — Discover the world's hobby — building fine-quality, historic wooden ship models. Described are true-to-life scale replicas, lifelike in every detail. A 64-page color catalog introduces you to this fascinating hobby. MODEL EXPO, INC. \$3.00 (Refunded with first order). Circle No. 1060.

**CLOCK COMPONENTS**—Quartz movements of all types. Quartz, Westminster chime, fit-ups, bezel, and flat dials. Hand-painted clock dials with kits for you to assemble and sell. Clock hardware and hundreds of items to build clocks. Send for catalog and sales plan. NEWPORT ENTERPRISES. \$1.00. Circle No. 1065.

**MUSIC MAKER'S KEEP BOOK**—a 36-page resource catalog for building and learning to play handmade musical instruments. This source book contains plans, blueprints, kits, books, hardware, strings and accessories for building such instruments as guitars, banjos, dulcimers, harps, violins, pipes, and more. ST. CROIX KITS. \$1.00. Circle No. 1080.

**SOLID WOOD CLOCK KITS** — Full-color catalog of beautiful, easy-to-make clocks. All solid wood with solid brass movements. All parts hand cut for perfect assembly, even by beginners. VIKING CLOCK CO. Free. Circle No. 1090.

## PUBLICATIONS

**WOOD CARVING** — You can obtain information on learning woodcarving by sending for our literature. The offer includes sample copy of *The Mallet Magazine* and two lesson sheets on carving. NATIONAL CARVERS MUSEUM. \$2.00. Circle No. 1140.



**This VET Did It - and YOU Can Do It Too!**

"War injuries left me badly handicapped, but now I'm a financial success as a Locksmith, thanks to your training. Besides, the work is fascinating. If I can do it anybody can." — Glen Johnson, Larned, Kan.

Make Up to \$26.00 an Hour — even while learning!

Train FAST at Home!

# Be a LOCKSMITH!

If you enjoy fixing things, you're a "natural" to make hundreds of EXTRA DOLLARS a year in the fascinating business of Locksmithing. Rising crime has increased demand for service a thousandfold. Yet there's only one Locksmith for every 17,000 people!

**COLLECT CASH PROFITS ALMOST AT ONCE!**

You're "in business" ready to make \$10 to \$26.00 an hour a few days after you begin Foley-Belsaw's shortcut training. Easy illustrated lessons complete with ALL practice equipment PLUS

- ALL TOOLS YOURS TO KEEP
- KEY MACHINE YOURS TO KEEP
- EXPERT PERSONAL ASSISTANCE
- BUSINESS-BUILDING HELP



MAIL THIS COUPON • NO SALESMAN WILL CALL

**FOLEY-BELSAW INSTITUTE**  
6301 EQUITABLE RD. DEPT. 11463  
KANSAS CITY, MO. 64120



Rush FREE book, "Keys to your Future."

Name \_\_\_\_\_

Address \_\_\_\_\_

City \_\_\_\_\_ State \_\_\_\_\_ Zip \_\_\_\_\_

**THIS DO-ALL PRO KEY MACHINE YOURS TO KEEP!**

Can add \$50 to \$100 a week to your income... and doesn't cost you a penny extra!

**FREE**

Now you can get Perfect Dovetails in Minutes and Cash Back with the Keller System

Up to \$25 back on the easiest, most accurate and foolproof router dovetail system available -- **The Keller Dovetail System.** Now with a twenty year warranty!

"In a class by itself... made exceptionally clean cuts. It has several advantages over the other jigs." **Wood Magazine**

"By far the simplest to use." **Fine Woodworking**

"Produces through dovetails with an absolute minimum of setup fiddling -- less than any other jig tested." **American Woodworker**

Money back offer good on purchases between September 1st and December 15th, 1988. See the dealer nearest you today for details.

**Acton Moulding & Supply, Inc.**  
6140 County Rd. 17  
Helena, AL 35080  
1-800-228-0474  
205-663-0130

**AAA Wholesale Tool & Supply**  
17302 Roscoe Boulevard  
Northridge, CA 91325  
818-996-1500

**Atlas American Tool Co.**  
869 N. Hollywood Way  
Burbank, CA 91505  
818-954-9427

**Nemy Electric Tool Co.**  
7635-A Auburn Blvd.  
Citrus Heights, CA 95610  
916-723-1088

**Tool City 8**  
14136 E. Firestone Blvd.  
Santa Fe Springs, CA 90670  
1-800-423-7839  
1-800-828-7819 (CA)

**Whole Earth Access**  
2990 7th Street  
Berkeley, CA 94710  
415-848-3500

**Wisnoms Hardware**  
Corner 1st & Delaware  
San Mateo, CA 94401  
415-348-1082

**Schlosser Tool & Machinery**  
301 Bryant St.  
Deer, CO 80219  
303-922-8244

**Brian's Tool Sales**  
9 Moody Road  
Enfield, CT 06082  
203-623-6282

**Jacksonville Woodworkers Supply, Inc.**  
2535 Powers Ave.  
Jacksonville, FL 32207  
904-737-7508

**R.A. Nass & Co.**  
8888 N. Milwaukee Ave.  
Niles, IL 60548  
312-824-0565

**The Tool Haus**  
630 N. Silverdale  
Gladwin, MI 48624  
1-800-828-0001  
313-743-9300 (MI)

**Diversified Equipment & Supply**  
11223 Blair Road  
Charlotte, NC 28212  
704-545-5198

**Woodworking Machinery & Supplies**  
294 Besty Dr.  
Belmont, NC 28012  
704-827-3190

**The Tool Chest**  
45 Emerson Plaza East  
Emerson, NJ 07630  
201-261-8665 (261-Tool)

**Hedeler Hardware Inc.**  
3 No. Main St.  
Pearl River, NY 10965  
914-735-2066

**Northland Woodworking Supply**  
1 Lee @ N. Genesee Sts.  
Lima, NY 13502  
315-724-1299

**The Woodworkers' Store at Brewer's**  
161 E. Boston Post Road  
Mamaroneck, NY 10543  
914-698-3232

**Lehman Hardware**  
4779 Kidron Rd.  
Kidron, OH 44636  
216-857-5441

**Molt Masler Power Tools**  
5228 Market Street  
Youngstown, OH 44512  
216-783-2130

**Quality Saw & Tool, Inc.**  
328 S. Main St.  
Mansfield, OH 44903  
419-525-4221  
1-800-523-6927 (OH)

**Woodcrafters Supply Co.**  
20 Arcadia Avenue  
Columbus, OH 43202  
614-262-8095

**Woodcrafters**  
212 N.E. Sixth  
Portland, OR 97232  
503-231-0226

**Mar-Wood Hardwoods**  
406 A Huntington Pike  
Rockledge, PA 19111  
1-800-255-8363  
215-663-9446 (PA)

**Old Mill Cabinet Shoppe**  
Rd#3 Box 547-A  
Camp Batty Washington Rd.  
York, PA 17402  
717-755-8884

**Cherokee Lumber Company**  
1410 Sevierville Pike  
Maryville, TN 37802  
615-982-8250

**Wood World**  
13550 Floyd Rd. Suite 101  
Dallas, TX 75243  
214-668-9130

**Western Woodcraft Supply**  
3149 South State Street  
Salt Lake City, UT 84115  
801-485-5523

**The Source**  
7305 Boudinot Dr.  
Springfield, VA 22150  
800-452-9999  
703-544-5460

**Madison Builders Supply, Inc.**  
2021 E. Madison  
Seattle, WA 98122  
206-328-2984  
800-426-1164

**The Wooden Boat Shop**  
1007 NE Boat St.  
Seattle, WA 98105  
206-634-3600

**Reinhold Brothers Company**  
2402 West Lisbon Avenue  
Milwaukee, WI 53205  
414-344-5230

For other areas contact: **Robert Larson Company, Inc.** Dealer inquiries welcomed.  
33 Dorman Ave., San Francisco, CA 94124 • (415) 821-1021

# BRANDING IRON

FALL SALE  
**\$24.00**

CALL TOLL FREE  
TO ORDER YOUR  
BRANDMARK  
**1-800-323-2570**  
(ORDERS ONLY)  
8:00 - 5:00 EASTERN TIME

### Your Satisfaction Guaranteed

- Convenient torch heating
- Solid Brass—lasts years
- 1st line as shown
- 2nd line—19 letters/spaces max.
- 1/4" letters
- distinctive border
- Add \$2.50 shipping & handling
- OH res. add \$1.44 tx



Order by mail from  
**BrandMark**



462 Carthage Dr. • Dept. W-5 • Beavercreek, OH 45385  
513-426-6843

# TWO EXCITING NEW WOODWORKING ACCESSORIES

CUT PERFECT CIRCLES (without a pivot hole)      TURN PERFECT SPINDLES on your drill press



with RADIAL ARM, TABLE or BAND SAW.  
"Circ-L-Cut" (patented) device locks in miter groove or clamps to table. Cut circles from 3 to 48" in diameter from any thickness wood or plastic without a center pivot hole. Circ-L-Cut is only \$17.95 PPD



Special Combo Offer Both Items **\$35.00 PPD**  
Convert your DRILL PRESS to a VERTICAL LATHE in minutes! "DriL-Lathe" permits professional wood turning... up to 1 1/2" diameter and a 12" length. Uses Double Sealed Ball Bearing for high speed and long life. DriL-Lathe is only \$21.95 PPD

**HEPP INDUSTRIES, INC.**  
687 Kildare Crescent, Seaford, NY 11783 (Dept W9)



Solid Cherry Commode Table \$169.00. Ready to assemble, 20" x 27" x 22" high. Also available in walnut, oak and mahogany with matching coffee table. Shipped from stock.

"FREE BROCHURE" Dept. "M4"



**Adams Wood Products, Inc.**

974 Forest Dr., Morristown, TN 37814

DAVID J. ADAMS  
President

TELEPHONE  
(615) 587-2942

# WOODCARVING IS FUN & PROFITABLE!

Want to carve decoys, statues or gun stocks?

It's easy when you use the Dupli-Carver Series wood carving machines. A patented five axis carving action allows these machines to complete difficult undercuts and contours as no other machine can. Complete machines are available starting as low as \$359.00

SEND \$1.00 FOR OUR FULL LINE BROCHURE AND PRICE LIST AND START PLANNING YOUR FULL OR PART-TIME BUSINESS.

**MARLIN INDUSTRIES, INC.**

Rt. 70, Box 191, Dept. D810  
Cashiers, NC 28717  
(704) 743-5551



If you would like more information about advertising in *WOOD*, contact:

Terry McIntyre  
**WOOD Magazine**  
750 Third Avenue  
New York, NY 10017

212-551-7130

# NEW! Fall Catalog



112 PAGES  
PACKED WITH  
NEW IDEAS  
AND PRODUCTS

Veneers, Wood Parts,  
Specialty Hardware,  
Tools, Knobs, Pulls,  
Finishing Supplies,  
Books, Kits & Plans.

Please Enclose  \$1 (3rd Class)  \$2 (1st Class)

Name \_\_\_\_\_

Address \_\_\_\_\_

City/State/Zip \_\_\_\_\_

**The Woodworkers' Store**  
21801 Industrial Blvd., Dept. 1205  
Rogers, MN 55374

# WOODWORKERS

**Milwaukee**

CORDLESS SCREWDRIVER  
HEAVY DUTY REVERSING



**6539-1**

1 HOUR FAST CHARGE

With Battery Pack & Charger

**SALE \$69.95 ppd**

FREE CATALOG SUBSCRIPTION  
WITH PURCHASE.

CATALOG ONLY.

2 year subscription (8 issues) \$4.00.  
Free \$5.00 gift certificate with catalog order.

R. A. NESS & CO.

**THE WOODWORKERS  
EMPORIUM**

8888 N. MILWAUKEE AVE.

NILES, IL 60648

(312) 824-0565



# 101 GIFT & NOVELTY PATTERNS

This wonderful packet contains 101 FULL SIZE PATTERNS of Giltts, Novelties, Lawn Figures, Bird Houses, Shelves, Action Windmills, Alphabets, and many more things. Just trace and saw out. Plus "Make Money Jig Sawing". Only \$7.00 Prepaid 1st Class for this big packet.

MASTERCRAFT PLANS WEST, DEPT. 95H  
P.O. Box 625, Redmond, WA 98073



# 90 PATTERNS LAWN ORNAMENTS · NOVELTIES

FULL SIZE patterns up to 20" high of Dutch boy and Girl, Dwarf, Penguin, Fishing Boy, Animals, Birds, Novelties and many other popular items. Easy to make and sell. Just trace, cut out and paint. Send \$7 today for the LAWN ORNAMENT PACKET containing all 90 patterns. Prepaid, 1st Class.

MASTERCRAFT PLANS WEST, Dept. 92H  
PO Box 625, Redmond, WA 98073



# CREATE A FAMILY TREASURE WITH KUEMPEL CHIME Red-i-Kut Kits



Each case is carefully handcrafted by grandfathers in 3/4" walnut cherry or oak. Precision West German movements, handcrafted pendulums, and individually handpainted moonwheels.

Write or Call for  
Catalog \$2  
1-800-328-6445  
**Kuempel Chime**  
Dept. 020

21195 Minnetonka Blvd.  
Excelsior, MN 55331  
Serving clockmakers for 65 years.

## SHOP ACCESSORIES

**RIPSTRATE SAVES FINGERS** — for table saw and radial arm saw users. Brochure describes the RIPSTRATE and shows how it gives straighter cuts, speeds, the work, prevents kickbacks, and keeps hands away from the blade. FISHER HILL PRODUCTS. 25¢. Circle No. 1235.

**EASY DOES IT** — with HTC'S power tool accessories. Discover many unique items, designed only with you, the dedicated woodworker, in mind. Make your machinery safer, increase the working area of your shop and accomplish nearly impossible tasks easily, quickly, accurately. Full-line catalog and price list. HTC PRODUCTS, INC. \$1.00. Circle No. 1245.

**BUY YOUR SANDING BELTS DIRECT FROM THE MANUFACTURER** — Industrial Abrasives is the company that gives you six free belts with every dozen ordered. But, sanding belts are not the only product we have to offer. In our catalog you will find many specialty items not readily available in your hardware store. Price of catalog refunded with first order. INDUSTRIAL ABRASIVES CO. \$1.00. Circle No. 1248.

**WOOD MOISTURE METER** — Avoid moisture problems such as cracking, warping, splitting, delamination etc. by using a moisture meter, as described in the latest brochure. Moisture Meter Mini-Ligno is designed for serious hobbyists and woodworkers. Attachments for depth measurements and remote reading during air and kiln drying are available. Available Moisture Range 6-20%, 6-36% or 4-30%, 4-60%. Catalog describes complete line of moisture meters. LIGNOMAT USA, LTD. Free. Circle No. 1250.

**ROUTER SPEED CONTROL** — Reduces speed electronically without reducing torque. Route at the speed that gives best results with the wood and bit you are using. Speed adjustable from full speed to 0 RPM. Less tear out—stops burning—less wear on bits—easy to use. Send today for information. MLCS LTD. Free. Circle No. 1251.

**DRUM SURFACE/THICKNESS SANDER** — Now a radial arm saw accessory providing inexpensive, space saving surface/thickness sanding capability. Product features include: instant attachments to all radial saws, 44 in. sanding width, sanding drum with sandpaper fasteners, and vacuum dust collection. Send for information. PERFORMAX PRODUCTS. \$1.00. Circle No. 1253.

**WHOLESALE SANDPAPER, SANDING BELTS, SANDING DISCS** — SUPERGRIT offers its quality line of abrasive products at wholesale prices directly to the consumer. Full or partial box orders welcomed. \$25 minimum order. Prompt, free UPS shipment to most areas. Literature, price list. RED HILL CORP. 50¢. Circle No. 1267.

**PROFESSIONAL SANDING EQUIPMENT** — Sand-Rite's Brush Head sands moldings and intricate carvings without losing detail or shape of the part. Pneumatic drum gives quick and excellent results on contoured shaped parts. Everything we sell is industrial quality. Send for brochure. SAND-RITE. Free. Circle No. 1275.

## BITS, BLADES CUTTING TOOLS

**BANDSAW BLADES FOR ALMOST ANY TYPE BANDSAW** — both wood and metal cutting. Also circular saw blades, router bits, sanding belts and discs. Send for catalog. BUCKEYE SAW CO. \$1.00. Circle No. 1307.

**OVER 600 ROUTER BITS** — are now available. The all-new 1988 Byrom catalog features 1/8" to 3/4" shank in high speed steel, carbide and carbide tip. Over 20 pages, 80 new items, and over 80 technical drawings. "Industrial Information Kit" includes catalog, industrial price list, name of nearest dealer, and 2-yr. subscription to special sales and new product introductions. Dealer inquiries invited. BYROM INTERNATIONAL. \$3.00 (refundable). Circle No. 1308.

**CARBIDE TIPPED ROUTER BITS AND SHAPER CUTTERS** — Over 400 router bits and shaper cutters displayed in catalog featuring 6 piece cabinet sets, 3 piece 1/2-in. shank router bit panel raising system, and 3 wing industrial shaper cutters. An outstanding selection of top quality shaper cutters available in 1/4-in. - 1 1/4-in. bore, and router bits offered in 1/4-in. and 1/2-in. shank at the industry's best factory direct prices. CASCADE PRECISION TOOL CO. \$1.00. Circle No. 1315.

**INDUSTRIAL QUALITY CUTTING TOOLS** — Three large, colorful wall posters keep DML's huge line of carbide-tipped cutting tools close at hand for easy reference. Separate posters for saw blades, shaper heads (with diagrams of each cut), and router bits. Each features graphic displays of the tools, capabilities, and sizes. DML, INC. \$3.00. Circle No. 1319.

**WOODWORKING TOOLS** — Freud provides the finest in hand tools, carbide cutting tools, and hand held power tools. From drills and sanders to carbide saw blades and router bits. Send for catalog. FREUD. \$1.00. Circle No. 1321.

**PRODUCTION QUALITY CARBIDE TIPPED ROUTER BITS** — MLCS Ltd. offers a full line of professional production quality carbide tipped router bits at 50-70% lower than retail prices. We sell through the mail and only direct to craftsmen. Send today for information. MLCS LTD. Free. Circle No. 1350.

# Call 1-800-223-7297 (SAWS) for a copy of DML's quarterly promotions and your closest DML distributor.

1988 QUARTERLY SPECIALS

DML

DML, Inc., 1350 S. 15th St., Louisville, KY 40210-1861

## NEW "Quad-Drive" DRUM SANDER with Infinitely Variable Power Feed!



**At last! A complete power-feed Drum Sander at an affordable price! Choose from 12" and 26" models SAVES TIME...IMPROVES RESULTS.** Use this high-tolerance machine for light dimensioning as well as the finest finish work.

Now you can add new beauty to each woodworking project, save hours of tedious hand sanding! In a matter of seconds you can produce a satin-smooth finish impossible to duplicate with hand methods or hand-held power sanders...no more low spots, waves or cross-grain marks! Check these advantages...

### FREE FACTS!

Send for complete facts on how you can try this low-cost tool in your own shop for one full month without risk. See how the sander can dimension and finish-sand cabinet pieces, resawn stock, paneling, toys, tabletops, knees, burls, crotches and much, much more! You'll soon find it's one of the most valuable tools in your shop! Made in U.S.A. Easy Terms.

Call Toll-Free 1(800) 538-4200, Ext. 2426



**YES!** Please rush my **FREE INFORMATION KIT** and details on your 30-Day Free Trial Guarantee.

**Woodmaster Tools, Dept. RW26**  
2908 Oak, Kansas City, MO 64108

NAME \_\_\_\_\_

ADDRESS \_\_\_\_\_

CITY \_\_\_\_\_ STATE \_\_\_\_\_ ZIP \_\_\_\_\_

**NEW INFINITELY VARIABLE FEED RATE** gives you total control in any sanding situation!

**EXCLUSIVE QUAD-DRIVE FEED SYSTEM**...four, power-feed rollers for maximum traction. Eliminates oversanding at first and last few inches of a board!

**NEW FELT-BACKED ABRASIVE** mounts in just seconds to Velcro covered drum. The harder you sand, the tighter it stays! Eliminates stretching...allows fast removal and re-use!

# Building Tiny Dreams . . .

- Swiss Chalet
- Lake Home
- Elizabethan Victorian
- Cape Cod
- Colonial

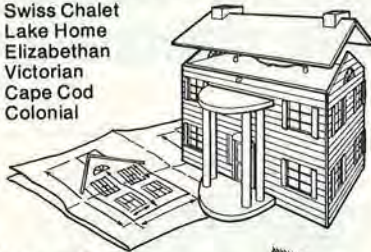

**One Plan Builds All Models just \$3.00**

or send for Craftplans catalog only 50¢ Offer expires 1/1/89



Please Enclose: 50¢ Catalog  
\$3.00 Dollhouse Plan  
\$1.00 Handling charge when ordering plans.

Name \_\_\_\_\_

Address \_\_\_\_\_

City/State/Zip \_\_\_\_\_

**Craftplans®**

21801 Industrial Blvd., Dept. 1301  
Rogers, MN 55374

# MAKE CLOCKS

TOYS & WHIRLIGIGS

Make wooden clocks, toys, whirligigs, dollhouses, classic cars, music boxes, weather instruments, desk sets, games, crafts & furniture with our plans, parts (hardwood & metal), kits (for all skill levels), books, tools, finishes and supplies. Bulk prices available. (614)484-4363. Sixty-page color catalog subscription \$1.

## Peter Rabbit Clock

- Uncut Kit: \$14.95  
Just cut, sand, assemble & paint
- Precut Kit: \$19.95  
Just sand, assemble & paint
- Visa/MasterCard accepted

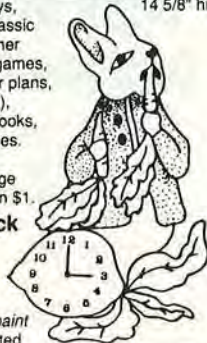

CHERRY TREE TOYS, Bx 369-9, Belmont, OH 43718

## BAND SAW OWNERS!

A NEW TOOL is now available so you can make or repair any length Band Saw Blade in minutes!

This patented tool was developed for use in our own shop and has proven itself with thousands of high quality, true running splices.

Our splicer enables any craftsman to make up any length blade from economical coil blade stock QUICKLY and EASILY. The resulting silver brazed joint normally outlasts the service life of the blade.

Three models are currently available:  
 1C-001 1/2" to 3/4" Blades . . . . . \$ 49.95 ppd  
 1C-002 1/2" to 3/4" Blades . . . . . 49.95 ppd  
 1C-003 3/8" to 1 1/2" Blades . . . . . 150.00 ppd  
 The tool comes complete with detailed instructions and supplies for approximately 100 splices.

We also carry additional supplies and OLSON band saw stock at reasonable prices.

Send L.S.A.S.E. for FREE information to:  
**NEW MILFORD SPECIALTIES CO.**  
 Dept. BH, P.O. Box 241  
 Botsford, CT 06404-0241  
 (203) 426-4276

DEALER INQUIRIES INVITED

# FREE ROUTER BIT CATALOG

Pro Quality Router Bits & Accessories  
 Cast Router Table  
 Flat Ground Top

CARBIDE TIPPED • VALUE PRICED  
 over 50 shapes • 350 sizes  
 • 48 shaper cutters 1/2" to 1 1/4" Bore

Write Today For Free Catalog

CHQ/CE PRECISION TOOLS, INC.

P.O. Box 560993  
 Orlando, FL 32856

# FREE



48 page catalog for  
 decoy carvers  
 wood carvers  
 wood turners

ORDER TODAY  
 1-800-221-9474 OR WRITE TO:

**P.C. ENGLISH, INC.**  
 P.O. Box 580, Dept FD12, Thornburg, VA 22565

## Build Power Tools You Can Be Proud Of... And SAVE!!!

Remember when "quality craftsmanship" meant something? With GIL-BILT tools it still does.

Construct your own:

- 12-in BAND SAW
- 18-in BAND SAW
- 10-in. TILT/ARBOR SAW
- LATHE/DRILL PRESS COMB.
- 9-in TILT TABLE SAW
- 6-in BELT SANDER
- SPINDLE SHAPER
- CIRCULAR SAW TABLE

GIL-BILT kits include step-by-step plans, full scale patterns and all necessary metal parts and components except wood and motor. Made in America with pride by Gilliom Manufacturing, Inc. since 1946.

Send \$6 per plan or \$24.50 for plans for all eight tools listed above or send \$1 for descriptive brochure only. Satisfaction Guaranteed.

**GILLIOM MANUFACTURING, INC.,**  
 Dept. WD98  
 P.O. Box 1018,  
 St. Charles, MO 63302  
 Phone (314) 724-1812



Featured here: 18-in. Band Saw

- Specs:** Throat capacity 18 in.  
 Thickness capacity 12 in.  
 Table size 26 in. x 28 in.  
 Table tilt 0° to 45°  
 Blade furnished 124 in. x 1/4 in. x 6T  
 Table height 39 1/2 in.  
 Overall dimensions 33 1/2 in. wide  
 29 in. deep  
 71 1/2 in. high  
 Speed (w/1,725 rpm motor)  
 425 rpm 2000 b/rev  
 Order No. 451-K only \$189.99 (less cost of plan, if previously purchased) plus shipping  
 Speed reduction kit available for cutting steel.

## PATTERNS \$100



SAME SIZE OUTLINE DRAWINGS  
 NO ENLARGING NECESSARY  
 TRACE & CREATE

FREE CATALOG WITH ORDER

SEND THIS AD & \$1.00 FOR EACH PATTERN  
 (Plus 50¢ postage per order)  
 DESIGN GROUP, Box 514-JJ, Miller Place, NY 11764

## BUILD THIS ROLLTOP DESK



Order plans for this detailed replica

The generous size of our Rolltop Desk--30" deepx44" highx51"wide--permits plenty of drawer and desktop space. We built ours of cherry, for the sheer luxury of it, but you can use oak, if you like. To order plans send \$12.00 ppd. to: HAMMERMARK ASSOCIATES, P.O. Box 201-ABW9, Floral Park, NY 11002. Canadian residents remit postal money order in US funds; NY residents add sales tax. Now available: our new Finishing & Refinishing book, 96 pp. illus., \$10.75 ppd. Catalog \$1. Prices guaranteed to 6/89.

## Where Do Ohio's Serious Woodworkers Shop?

**WOODCRAFTERS SUPPLY®**

5331 Sinclair Road  
 Columbus, Ohio 43229  
 (Off I-71)  
 (614) 436-6900

# U-CAN-BUILD

WOODWORKING MACHINES

ACCURATE • RUGGED • VIBRATION FREE

DESIGNS: HUGE BEARINGS & WORK ARBORS  
 FEATURE: AMERICAN MADE INDUSTRIAL MOTOR  
 HEAVY-STRONG MD FIBERBOARD  
 CONSTRUCTION

• 10" TILT ARBOR  
 TABLESAW

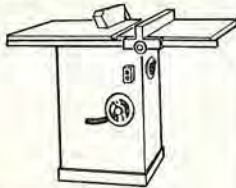

• 18" BANDSAW  
 (RESAWS 12" HARDWOODS WITH EASE)

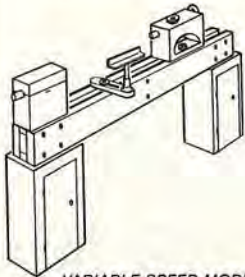

• 15" INBOARD  
 24" OUTBOARD  
 WOODLATHE

• 16" SCROLL  
 SAW

VARIABLE SPEED MODELS AVAILABLE

## FREE BROCHURE

CALL: (314) 838-8644

WRITE: J.M. WISE & CO.  
 BOX 598  
 FLORISSANT, MO 63032

**SAW BLADE VALUES**—are only part of Olson Saw's free literature package. A huge selection of resin-on-resin abrasives, wood/forstner bits, and "giant killer" professional carbide tipped circular saw blades are offered, in addition to our standard line of band, scroll, fret, jewelers, spiral, and coping saw blades. OLSON CATALOG SALES. Free. Circle No. 1365.

## HARDWARE/WOOD PARTS

**ELIMINATE THE GUESSWORK**—and inconvenience of buying random size lumber. Our new wood parts mail order program allows you to purchase your kiln dried wood from a complete selection of lengths, widths, and thicknesses, including turning squares and glued up panels, in many fine cabinet woods. To complete the program we have available drawersides, carved Queen Anne legs, turned legs, and complete Queen Anne chairs ready to assemble. ADAMS WOOD PRODUCTS. 50¢. Circle No. 1401.

**SPECIALTY WOODEN PARTS** — Hundreds of turned wooden parts in maple, birch, oak, cherry, walnut, and colors for toys, furniture, games, and crafts. Included are Shaker pegs, mug pegs, gallery spindles, wheels, axles, balls, finials, smokestacks, plugs, buttons, people, pegs, cargo, game pieces, knobs, handles, candle cups, stool legs. Bulk prices available. Send for color catalog subscription. CHERRY TREE TOYS, INC. \$1.00. Circle No. 1415.

**SQUARE DRIVE SCREWS**—Once you try them, you will never want to use anything else! The square drive recess virtually eliminates work-damaging driver bit "cam-out," the "lo-root" thread design results in superior holding power; and they are heat treated for strength. Sizes from #6 x 1/2" to #12 x 3", with brass plated, solid brass, and zinc plated available. Quantity discounts. Send for literature. McFEELY HARDWOODS. 25¢. Circle No. 1450.

**WOODWORKER'S SPECIALTIES** — 48-page catalog of plans and hard-to-find hardware for woodworkers. Dozens of wood toy plans & accessories, including wood wheels, fenders & decals. Also wood turnings, brass hardware, canister liners, stencil supplies, & wood cutouts. MEISEL HARDWARE SPECIALTIES. \$1.00. Circle No. 1455.

**WOOD TOY PATTERNS** — Patterns for all ages including children's patterns and executive toys. New catalog has many new patterns to choose from including parts and wheels. Send for new catalog and receive a coupon for free wheels and axle pegs. TOYS AND JOYS. \$1.00. Circle No. 1480.

**QUALITY AMERICAN-MADE WOOD TURNINGS** — such as shaker pegs, spindles, toy wheels, toy parts, craft items, and dowel rods in birch, oak, walnut, and cherry. Send for complete 32-page catalog. WOODWORKS. \$1.00. Circle No. 1490.

# SAVE MONEY! KILN DRY LUMBER



## MAKE MONEY!

Kiln Dry for others.  
 As the nation's largest manufacturer of dehumidification Dry Kilns, we can supply you with the same type equipment used by many of the major firms.

Call or write today for free facts that will help you make and save money.



1-800-648-9200

207-989-4335 Nyle Corporation  
 P. O. Box 1107, Bangor, Maine 04401

## INCOME OPPORTUNITIES

**AMITY, NATION'S #1 QUALITY FURNITURE RESTORATION CO. SINCE 1971**—New 1988 product catalog featuring: Complete restoration systems, Hydrocote non-flammable water based stains and finishes, Permatuse repair products, stripping solvents, chemicals and supplies. Amity 1-2-3 wipe-on finishes and much more. Regional workshops in your area. AMITY. \$1.00. Circle No. 1605.

**START SMALL BUSINESS WITH NEW SCROLL SAW** — The Excalibur precision scroll saw from Canada can turn your workshop into a profit center. Make toys and puzzles, do intricate marquetry work or detailed cabinet work with these "operator friendly" machines. Hundreds sold in the U.S. already. Save, buy direct, from \$495. up. Send for brochure. J. PHILIP HUMFREY INT. \$1.00. Circle No. 1655.

**WOODCARVER MACHINES**—Make signs in wood, pictures in wood, arts and crafts. Make money the very first day. Use as a small business, hobby money, week-end craft shows. Our machines are template guided, easy to use, table top size. Return \$50 per hour to you. Dust collector, self centering. Visitors welcome. Send for info pack. KIMBALL WOODCARVER CO. \$1.00. Circle No. 1656.

**\$20 PER HOUR/PART TIME!**—Sell Mason Shoes in your spare time. We'll help you turn Saturday mornings into big money. No risk! No investment! It's easy! Send for free catalog and sales kit. MASON SHOE MFG. CO. Free. Circle No. 1658.

**MARLIN WOODCARVING AND ACCESSORIES**—make all types of wood carving easy, fun and profitable. The machines do the work. Whether for sign carving, flat 3-D, decoys, panels, gun stocks or furniture, we have the proper machine for the job. Professional woodcarving for the hobbyist and superior quality for the professional. Begin your hobby or full or part-time business by ordering our catalog and price list. MARLIN INDUSTRIES. \$1.00. Circle No. 1659.

**MASS PRODUCTION FURNITURE REFINISHING**—a revolutionary new concept from Master Finishers System™. Totally new, tremendously profitable! The old hand process is now done automatically with Master Finishers Furniture Refinishing Factory. Send for audio tape and brochure. MASTER FINISHERS. \$1.00. Circle No. 1660.

**MAKE MONEY IN FURNITURE RESTORATION THE MINUTEMAN WAY**—Earn \$200-\$1000 per day stripping, repairing, refinishing, mirror resilvering, and/or veneering, at home or in shop, spare time or full time. We provide complete free training; no experience necessary. Free workshop teaches you latest in furniture restoration. You have to see it to believe it! Send for catalog. MINUTEMAN. \$2.00. Circle No. 1661.

12 SHOWS IN FALL 1988!

• Free Workshops  
 • 100 Exhibits • Door Prizes

★THE  
**WOODWORKING  
 SHOWS★**  
 machinery  
 tools—supplies



See the Widest Variety of Woodworking  
 Products All Under One Roof

**Hundreds of Items**

Machinery • Power & Hand Tools • Supplies

Sept. 9-10-11 Greater Cincinnati	Oct. 14-15-16 Pittsburgh Tri-State
Sept. 9-10-11 Twin Cities	Oct. 28-29-30 So. California
Sept. 16-17-18 Baltimore/Washington	Nov. 4-5-6 Metro-Detroit
Sept. 23-24-25 San Diego	Nov. 11-12-13 Western Washington
Sept. 30-Oct. 2 Greater Boston	Nov. 18-19-20 Oregon
Oct. 7-8-9 No. California	Dec. 2-3-4 Delaware Valley

Seminars by Ian Kirby - Roger Cliffe  
 - Bob Rosendahl - Rude Osolnik  
 - and other Master Craftsmen

1-800-626-8257, In California 213-477-8521  
 Call for free brochure, 8:30-5 Pacific Time

Save \$1 off regular \$6 admission  
 with this ad

**BUILDING CONSTRUCTION**—Learn how to profit as an independent contractor or save thousands building your own home...with NRI at-home training in Building Construction. 70 lessons, plus over 100 practical hands-on projects cover the full spectrum of construction—from site selection to exterior finishing & landscaping. Send for catalog. NRI SCHOOL OF BLDG. CONSTRUCTION. \$1.00. Circle No. 1665.

## MISCELLANEOUS

**SAVE 25-85% ON MAJOR BRAND**—do-it-yourself tools, home and car alarms, telephones, paint sprayers, pressure washers and more. Order your 100-page catalog packed with savings now! BURDEN'S SURPLUS CENTER. \$1.00. Circle No. 1905.

**MAKE WOODEN TOYS** — Whirligigs, doll houses, classic autos, clocks, music boxes, weather instruments, desk sets, games, crafts & furniture with our plans, parts (hardwood and metal), kits (for all skill levels), books, tools, finishes and supplies. Bulk prices available. Send for 60-page color catalog subscription. CHERRY TREE TOYS, INC. \$1.00. Circle No. 1918.

**MAKE WOODEN CLAMPS** — Save 60%. Kits and plans for 8, 10, and 12 in. wooden handscrew clamps. Acme threaded steel rods, components, handles and full-sized plans provided. Kits also available with uncut and pre-cut maple jaws. You decide how much you want to save. Also available are hundreds of plans, kits, parts, and supplies for wooden toys and whirligigs in our beautiful color catalog. CHERRY TREE TOYS, INC. \$1.00. Circle No. 1919.

**THE CUSHION COUNTER SANDER** — is a new concept in pneumatic drum sanding. Sanding sleeves are slid over an air bag (inflated with a hand tire pump) on an arbor to mount it between centers on a wood lathe. Drum effectively takes on profiles, curves, and bevels practically eliminating flat spots and chatter marks. INDUSTRIAL ABRASIVES CO. Free. Circle No. 1976.

**BANDSAW OWNERS** — A new tool is now available so you can make or repair any length bandsaw blade in minutes. Our splicer enables craftsmen to make up any length blade from economical coil blade stock quickly and easily. Three models are currently available to accommodate blade widths from 1/2" to 1 1/2". The tool comes complete with detailed instructions and supplies. We also carry OLSON bandsaw stock at reasonable prices. Send for literature. NEW MILFORD SPECIALTIES CO. 50¢. Circle No. 2025.

**SLEEVELESS DRUM SANDERS**—Economic—simply cut sandpaper from standard size sheets. Unique way of holding sandpaper to drum—a twist of the key tightens. Sponge rubber backing insures long wear of sandpaper. Sanders can be used on drill press, small motor, lathe, combo-tools,

# NOW! Get in on the PROFITS in

# SMALL ENGINE REPAIR!



Start your own money making business!

Work part time, full time—right at home—we help you every step of the way.

No doubt about it... as a small engine pro, you can cash in on the huge demand for qualified men in one of America's fastest growing industries. You'll be able to command top hourly rates of from \$25.00 to \$30.00 per hour—and that's just for labor. A simple tune-up earns as much as \$49.95 for less than an hours work, and parts, engines and accessories will add even more to the profits.

Plenty of business waiting for qualified men.

65,000,000 Small Engines Are In Use Today!

That's the official count from the Engine Service Assn., and one-million new engines are being built each month. With fully accredited Foley-Belsaw training, you can soon have the skills and knowledge to make top money servicing these engines. People will seek you out and pay you well to service their lawnmowers, tillers, edgers, power rakes, garden tractors, chain saws, minibikes, snowmobiles, generators, go-carts, paint sprayers, snowblowers... the list is almost endless.



Professional Tools and Equipment, PLUS 4 H.P. Engine ALL YOURS TO KEEP... All at No Extra Cost. NO EXPERIENCE NECESSARY!

You don't need to be a 'born mechanic' or have any prior experience. You can master this profitable trade right at home in your sparetime. Lessons are fully illustrated... so clear you can't go wrong, and with our famous 'learn-by-doing' method you get practical 'hands-on' experience. We also show you how to get business, what to charge, where to get supplies wholesale... all the inside tricks of the trade you need to assure success right from the start.

Send for FREE Facts—Do It TODAY!

NO Obligation—NO Salesman Calls!

You risk nothing by accepting this offer to see how easily you can learn the skills you need to increase your income in a high-profit business of your own. Just fill in and mail coupon below (or send postcard with name and address) to receive full information by return mail.

RUSH COUPON TODAY

Foley-Belsaw Institute  
6301 Equitable Rd.  
Dept. 51490  
Kansas City, Mo. 64120



FREE BOOKLET!

Send for your copy today!

FOLEY-BELSAW INSTITUTE  
6301 Equitable Rd., Dept. 51490  
Kansas City, Mo. 64120



YES, please send me the FREE booklet that gives full details about starting my own business in Small Engine Repair. I understand there is No Obligation and that No Salesman will call on me.

NAME \_\_\_\_\_  
ADDRESS \_\_\_\_\_  
CITY \_\_\_\_\_  
STATE \_\_\_\_\_ ZIP \_\_\_\_\_

radial saw, hand drill, and other revolving devices. Send for brochure. SINGLEY SPECIALTY CO., INC. 50¢. Circle No. 2063.

**TOOLMARK CO.**—We offer a complete line of wood lathe accessories including safety shields, duplicator systems, bowl turners, steady rests, and more. Send for brochure. TOOLMARK CO. \$1.00. Circle No. 2073.

**IF YOU ARE INTERESTED IN RESTORING ANTIQUES**—this 176-page catalog packed with unusual, hard-to-find items is just for you. Included are hundreds of essential items for antique restoration including top quality brass reproduction hardware, oil lamps and accessories, numerous wood component repair parts and kits, caning and basketry supplies, everything needed for wood refinishing, related tools, books, and a complete line of upholstery equipment and supplies. All at wholesale prices. Send for this informative catalog. VAN DYKE' SUPPLY CO. \$1.00. Circle No. 2077.

**SERIOUS WOODWORKERS**—In our shop we offer the finest: INCA machinery, Konig lathes, RBI scroll saws, Ryobi, Apollo, Virutex, Mill-Route, Keller, Leigh, Excalibur; DML, Freud, Onsrud; 3M products, Watco, Behlen, Sutherland Welles; imported & domestic hand tools; hardwood lumber—domestic & exotic; veneer; scroll-saw plywood; accessories; books & magazines. Quality products, service & competitive prices. Send for brochure. WOODCRAFTERS SUPPLY CO. 50¢. Circle No. 2080.

**WOODWORKING ASSOCIATION OF NORTH AMERICA**—First international association for woodworkers. Benefits include our quarterly magazine *International Woodworking*, specials from selected manufacturers, group health and life insurance, access to the woodworking network. WOODWORKING ASSOC. OF NORTH AMERICA. 50¢. Circle No. 2092.

## CARVING SUPPLIES

**DECOY AND WOOD CARVERS WISHBOOK**—48-page catalog features wide selection of tools and supplies for decoy carvers, wood carvers, wood turners. Chisels, gouges, sharpening stones, precision grinding tools, Fore-

dom tools, Fire Brush burners, pneumatic sanders, glass eyes, pewter feet, patterns, paints, reference books. P. C. ENGLISH, INC. Free. Circle No. 2115.

**CARVERS' & ARTISTS' SUPPLIES**—Now you have a sourcebook for the most sought-after supplies for your pursuits! Thousands of decoy carving patterns; kolinsky sable artist brushes; acrylic, alkyd, and oil paint; carving knives and gouges; Fordom & Dremel moto tools; hundreds of moto tool cutters and accessories. New 1988 catalog; 80 pages, over 4500 items! C. J. HUMMUL CO. Free. Circle No. 2130.

**WOODCARVING TOOLS**—Whittlers and carvers—Warren Tool Co. offers a catalog for you full of whittling and carving hand/power tools, books, stones, wood, and supplies. Since 1927, the finest in woodcarvers tools. WARREN TOOL CO., INC. \$1.00. Circle No. 2185.

**WOOD CARVERS SUPPLY INC.**—offers you the widest array of wood carving supplies in the USA. We offer products for turning, checking, cabinet making, log building, instrument making, and more. Everything is backed by a 32-year reputation for service and our famous 30-day money-back guarantee. Send for 2-year subscription to our color catalog. WOOD CARVERS SUPPLY INC. \$2.00. Circle No. 2190.

## CLAMPS

**MERLE ADJUSTABLE CORNER CLAMP**—Quick & easy to use. Fully adjustable from 2 1/2" to 69x69 in. Perfect for clamping picture frames, cabinets, or anything that requires 90° corner clamping. The Merle Clamp is cast aluminum & steel construction, a true industrial quality tool. Send today for information. MLCS LTD. Free. Circle No. 2250.

**PERFECT EDGE-JOINING EVERYTIME**—"Duo-Clamp" holds your boards flat while applying uniform yet firm pressure to squeeze out excess glue. Bowing totally impossible. The need for a surface planer is eliminated; a light belt sander finishes your job. Pat. 4,671,500. Easily assembled and unconditionally guaranteed. Made of sturdy maple. Send for information. MARK PRODUCTS. 25¢. Circle No. 2255.

# Information

WORTH WRITING FOR

Better Homes and Gardens®  
WOOD MAGAZINE, October, 1988  
Dept. SOW088  
P.O. BOX 5103  
Pittsfield, MA 01203-5103

TO ENSURE PROMPT HANDLING OF YOUR ORDER FOLLOW THESE INSTRUCTIONS:

- Circle your choice
- Enclose check or money order for cost of booklets plus \$2.00 service charge (no stamps/foreign)
- Send coupon and remittance to address above
- U.S. FUNDS ONLY
- ALLOW 4-6 WEEKS FOR DELIVERY
- Coupon expires October 16, 1989

## WOOD SUBSCRIPTION

1. A 1 year WOOD subscription (6 issues) for \$18.00 — a \$3.00 savings off newsstand rate. Allow 6-8 weeks for first issue. Add \$6.00 outside U.S. Be sure to include payment with total below.

## FREE LITERATURE

Circle numbers below corresponding to items in this issue. Please include \$2.00 for handling charge

41.	84.	565.	862.	1251.	1976.
42.	85.	818.	955.	1275.	2115.
57.	98.	852.	975.	1350.	2130.
61.	250.	860.	1090.	1365.	2250.
76.	410.	861.	1250.	1658.	

## PRICED LITERATURE

Numbers below refer to items on which there is a charge. Please include proper remittance.

3....\$1.00	97....\$1.00	370....\$1.00	820....\$1.00	1015....\$2.00	1315....\$1.00	1665....\$1.00
4....\$1.00	105....25¢	390....\$1.00	875....\$1.00	1023....\$1.00	1319....\$3.00	1905....\$1.00
6....25¢	138....\$1.00	424....\$1.00	877....\$2.00	1030....\$1.00	1321....\$1.00	1918....\$1.00
12....\$2.00	160....\$1.00	480....\$1.00	878....\$1.00	1050....\$2.00	1401....50¢	1919....\$1.00
33....\$7.95	190....\$1.50	485....\$2.00	879....\$5.00	1060....\$3.00	1415....\$1.00	2025....50¢
36....15¢	215....50¢	510....\$1.00	880....\$2.00	1065....\$1.00	1450....25¢	2063....50¢
47....\$1.00	226....25¢	520....\$1.00	890....\$1.00	1080....\$1.00	1455....\$1.00	2073....\$1.00
51....\$1.00	232....\$1.00	530....\$2.00	900....\$4.00	1140....\$2.00	1480....\$1.00	2077....\$1.00
63....\$1.00	310....\$2.00	535....\$1.00	903....\$1.00	1235....25¢	1490....\$1.00	2080....50¢
70....\$14.95	315....\$1.00	545....50¢	912....50¢	1245....\$1.00	1605....\$1.00	2092....50¢
87....\$1.00	325....50¢	547....\$1.00	915....\$3.00	1248....\$1.00	1655....\$1.00	2185....\$1.00
88....\$2.00	332....\$1.00	563....\$2.00	920....\$1.00	1253....\$1.00	1656....\$1.00	2190....\$2.00
90....\$1.00	340....\$1.00	578....\$1.00	935....\$3.00	1267....50¢	1659....\$1.00	2255....25¢
93....\$1.00	345....\$2.00	803....\$2.00	945....\$5.00	1307....\$1.00	1660....\$1.00	
94....\$1.00	355....\$8.00	810....\$1.00	965....\$1.00	1308....\$3.00	1661....\$2.00	

Name (please print) \_\_\_\_\_  
Address \_\_\_\_\_ \$ \_\_\_\_\_ for priced items  
City \_\_\_\_\_ \$ 2.00 for handling  
State \_\_\_\_\_ Zip Code \_\_\_\_\_ \$ \_\_\_\_\_ total remittance





## TOUGH ENOUGH

As winter comes on, a lumberjack adds layers of clothing to keep warm, but how does a tree fight the cold? Researchers have found that some species have a conservative strategy—they tolerate minimum temperatures no lower than the minimums they're likely to face where they put down roots. Oregon white oak, for instance, survives when the thermometer reads about  $-4^{\circ}\text{F}$ , but sustains injury if the mercury dips any lower.

Other species possess a much greater freezing tolerance than seems at all necessary. In experimental conditions, the northern white cedar, the white spruce, and the



balsam poplar defy a staggering  $-112^{\circ}\text{F}$ !

Some trees adjust to whatever fate gives them. The eastern white pine can't stand temperatures lower than  $-38^{\circ}\text{F}$  in Tennessee, yet shrugs off a bark-numbing  $-128^{\circ}\text{F}$  standing in Minnesota.

## CARVERS CONVERGE

Gas up the car. The National Woodcarvers Showcase '88 opens at Silver Dollar City, Branson, Missouri, on September 16. For two weeks, carvers meet, eat, talk, show, sell, and share. A juried competition pits carvers in two divisions and 14 categories. For more information, call 417/338-8188, or write: *National Woodcarvers Showcase, Miss Sue, Entertainment Division, Silver Dollar City, Inc., Branson, MO 65616.*

## THINNER IS BETTER

In Washington State, thinned plots of Douglas fir produced trees that yielded 7% more board feet of lumber and 22% more total wood than unthinned plots.

## GIVE HER A SAWDUST BOUQUET

How do you describe the smell of wood? In most cases, "nice" or "not so hot" prove adequate. A few types of wood, however, can be compared to scents most everyone knows. Freshly cut rosewood smells like roses. Teak smells like old shoe leather. West Indies satinwood will remind you of coconut oil, and an African species called Dahoma reeks of pure ammonia.



Don't bother with essia, another African wood. It smells like rotten cabbage.

## BUT WHEN DO THEY GO ON SALE?

When you want to show the world you have fine taste in automobiles, and the bank account to match, you might buy a Rolls-Royce. A status-conscious woodworker, however, could opt for a Reinhard table saw, a handcrafted, detailed machine definitely in the luxury class.

The 1988 price for this Swiss manufacturer's top-of-the-line table saw: \$26,950. Of course, that's with the electronic fence. If you settled for a regular fence, you could snap up the PKS350 from the U.S. importer for a mere \$20,950 (shipping not included).

Mahogany Masterpieces, the Suncook, New Hampshire-based distributor for the U.S. and Canada, sold just two Reinhard table saws last

year—one to a Wall Street executive and one to a West Coast computer company owner. However, both saws were the smaller, more economically

priced, tilt-table PKS250 model, which sells for \$15,950.

At the small Reinhard firm in Huttwil, Switzerland, Old World precision craftsmen build the saws one at a time. In addition to the no more than 10 table saws produced per year, Reinhard also makes drill presses and other wood-working machinery, and industrial equipment.

Don't wait too long to place your order. Prices of these Swiss saws shot up by as much as \$4,000 from 1987 to 1988. And, allow for an extended delivery date—limited production means a wait of 6 to 12 months. ♣



The Swiss-made Reinhard PKS250 table saw. Price: \$15,950.

# MORE POWER TO YOU.



With Makita cordless power tools anything is possible. You can turn raw lumber into finished furniture. Add a new room to your house. Even build a new house.

Because Makita tools do more than free you from a power cord. They connect you to two heavy-duty cordless systems. An extensive 15-tool, 7.2VDC system. And a versatile 10-tool, 9.6VDC system. Each with an interchangeable battery that gives you more than enough power to get the job done.

In fact, more professional builders use Makita power tools than any other cordless. Maybe they're impressed by the quality of our tools. Maybe it's their power.

Maybe it's because we have the industry's broadest cordless tool line.

Or maybe they know that the most impressive thing about Makita cordless tools is what they build. Reputations.

**Makita**  
IT'S ALL THE POWER YOU NEED.™

Makita U.S.A., Inc., 14930-C Northam St., La Mirada, CA, 90638-5753, (714) 522-8088

# What harm can a little water do?



Ordinary Paint: Water pools and soaks in.



New Rust-Oleum Wood Saver: Water beads and runs off.

Ordinary paint can't defend against the damaging effects of water and time. Fortunately, now there's new Rust-Oleum Wood Saver™ paint. A special wood formula with TEFLON\* for twice the moisture protection of ordinary paint. To prevent cracking, peeling and warping.

Try new Rust-Oleum Wood Saver paint. In convenient brush sizes. Handy aerosols. And wonderful colors. Let Rust-Oleum Wood Saver go to work on your wood. Before water does.

**New Rust-Oleum Wood Saver.™**  
**If it's going to get wet, get Rust-Oleum.™**



**RUST-OLEUM**  
CORPORATION