

Better Homes and Gardens®

# WOOD

Send your best  
**SHOP TIPS**  
Tools, prizes galore! Page 14

THE MAGAZINE FOR HOME WOODWORKERS

\$3.95

APRIL 1989 • ISSUE NO. 28  
Display until April 11

## STACK 'EM UP LAMINATED BOWLS

A dynamite technique  
that produces fantastic  
results for woodturners

## TOOL BUYER'S BONUS SCROLLSAWS PRICED UNDER \$150

Are they a good value?

## WE TEST STATIONARY BELT SANDERS

Nitty-gritty on 14 tools

## TRY THESE PROJECTS

Filigree plant stand  
Southwest-style bowl  
Fine-finish scraper  
Turned birdhouse  
Cowboy boot bookends

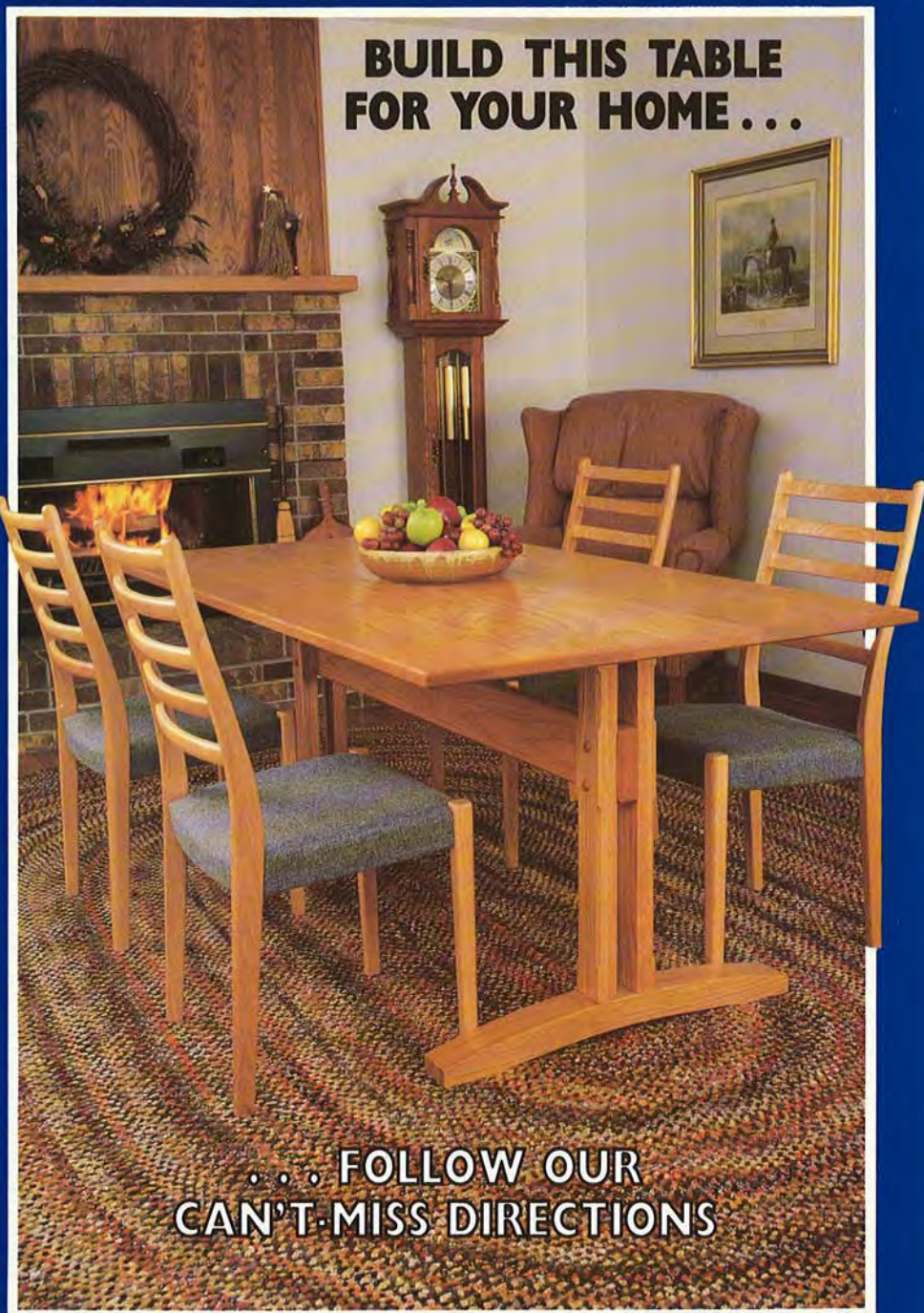

**BUILD THIS TABLE  
FOR YOUR HOME...**

... FOLLOW OUR  
CAN'T-MISS DIRECTIONS





89 A

los Ortega

PS.

SERIES  
1985

WASH



FRANKLIN

## Buy one of these Delta tools and we'll send someone to thank you.

Someone once said, "A penny saved, is a penny earned."

And along that same line of thinking, a hundred bucks saved is a hundred bucks to spend on wood. Or possibly a second Delta tool. A tool that could save you a *second* hundred dollars. That's right, every time you buy one of these three Delta Quality machines, we'll rebate you \$100.

So what's our angle? Simple. We're fairly certain that once you've had your first taste of Delta Quality, it'll be tough to work with anything less.

Let's say you've been looking for a good 10" Tilting Arbor Saw. This one has a cast iron table and wings. It'll make a cut up to 3 7/8" deep and rip to the center of a 50" panel. And with its self-aligning Jet-Lock, Micro-Set® rip fence you've got both capacity and precision in one tool.

You've also got an extra \$100 in your pocket that you might want to put toward the 14" Band Saw. With its 6 1/4" capacity, and micrometer adjustment blade guides, it's perfect for contours, straight cuts, even resawing. And, you've got it. Another hundred.

We could go on about our 6" Jointer, with its extra long 55 1/2" table and its parallelogram support system, for uniform chip breaking and smoother finishes. But the best way to introduce you to Delta Quality tools is to put the first one into your shop. Along with a hundred dollars. Or two. Or three.

Call toll-free for the name of your participating Delta dealer.  
Delta International Machinery Corp.,  
800/438-2486 (In PA, 800/438-2487).

Offer good on 6" Jointer/Model 37-154, 14" Band Saw/Model 28-283, and 10" Tilting Arbor Bench Saw/Model 34-429 only from participating dealers in continental U.S., Alaska and Hawaii from January 1 to June 30, 1989.



Building  
On Tradition  
**DELTA**  
A Pentair Company



# Our 10th ANNIVERSARY Gift To You!

**ACT NOW! Buy 1-Dozen Belts**

# 12 Get 6 Belts FREE!

We are celebrating our 10th Year supplying Belts and Sanding Accessories direct to the Woodworker.



### SANDING BELTS

Available in 36, 40, 50, 60, 80, 100, 120, 150, 180, 220, 240, 320 grit sizes. Please specify when ordering. We will ship an assortment of 24 Fine, Medium and Coarse unless otherwise specified. BELTS - x weight, a/o, cloth.

- 1 1/2" x 21" .....\$13.50/doz.
  - 1" x 30" ..... 15.50/doz.
  - 1" x 42" ..... 15.75/doz.
  - 1" x 44" ..... 15.75/doz.
  - 2" x 48" ..... 19.50/doz.
  - 2 1/2" x 16" ..... 16.50/doz.
  - 3" x 18" ..... 16.75/doz.
  - 3" x 21" ..... 17.75/doz.
  - 3" x 23 3/4" ..... 17.90/doz.
  - 3" x 24" ..... 18.00/doz.
  - 3" x 27" ..... 18.50/doz.
  - 4" x 21" ..... 19.95/doz.
  - 4" x 21 3/4" ..... 20.00/doz.
  - 4" x 24" ..... 20.50/doz.
  - 4 1/2" x 26" ..... 20.95/doz.
  - 4" x 36" ..... 23.95/doz.
  - 4 1/2" x 52 1/2" ..... 34.95/1/2doz.\*
  - 6" x 48" ..... 32.95/1/2doz.\*
  - 6" x 89" ..... 57.95/1/2doz.\*
  - 4" x 132" ..... 59.95/1/2doz.\*
- \* (6 FREE)

### STIKY DISC

Stiky Disc, Rugged Cloth. Buys, get 1 FREE. Available in 50,80,120,180,240 grit size.

- 6" diameter .....\$5.00/pk.
- 8" diameter ..... 6.25/pk.
- 9" diameter ..... 7.50/pk.
- 12" diameter ..... 10.00/pk.

### PRO'S BEST

- 0000 Steel Wool .....\$3.95/pk.
  - 000 Steel Wool ..... 3.95/pk.
- 1 Pack contains 16 pads.

### "Wooden Memories" PLANS

- Bessie the Cow ..... \$9.00
  - Bill E. Goat ..... 9.00
  - Beezer the Burro ..... 9.00
  - Ole Grey Mare ..... 7.00
- Build an heirloom today!  
Life like, full size rockers.

### 9" x 11" PAPER SHEETS

#### A/O Cabinet Paper (Brown)

- |                 |                                   |
|-----------------|-----------------------------------|
| 50/pk.          | 100/pk.                           |
| 40-D...\$17/pk. | <input type="checkbox"/> \$31/pk. |
| 50-D... 16/pk.  | <input type="checkbox"/> 28/pk.   |
| 60-D... 15/pk.  | <input type="checkbox"/> 26/pk.   |
| 80-D... 14/pk.  | <input type="checkbox"/> 24/pk.   |
| 100-D... 13/pk. | <input type="checkbox"/> 22/pk.   |
| 120-D... 13/pk. | <input type="checkbox"/> 22/pk.   |
| 150-D... 13/pk. | <input type="checkbox"/> 22/pk.   |

#### Garnet Paper (Red)

- |                 |                                   |
|-----------------|-----------------------------------|
| 50/pk.          | 100/pk.                           |
| 40-D...\$17/pk. | <input type="checkbox"/> \$31/pk. |
| 50-D... 16/pk.  | <input type="checkbox"/> 28/pk.   |
| 60-D... 15/pk.  | <input type="checkbox"/> 26/pk.   |
| 80-D... 14/pk.  | <input type="checkbox"/> 24/pk.   |
| 100-C... 13/pk. | <input type="checkbox"/> 22/pk.   |
| 120-C... 13/pk. | <input type="checkbox"/> 22/pk.   |
| 150-C... 13/pk. | <input type="checkbox"/> 22/pk.   |
| 180-A... 12/pk. | <input type="checkbox"/> 20/pk.   |
| 220-A... 12/pk. | <input type="checkbox"/> 20/pk.   |

#### No-Loading Finishing Paper (White)

- |                 |                                   |
|-----------------|-----------------------------------|
| 50/pk.          | 100/pk.                           |
| 80-C...\$16/pk. | <input type="checkbox"/> \$28/pk. |
| 100-C... 14/pk. | <input type="checkbox"/> 24/pk.   |
| 120-C... 14/pk. | <input type="checkbox"/> 24/pk.   |
| 150-C... 14/pk. | <input type="checkbox"/> 24/pk.   |
| 180-A... 11/pk. | <input type="checkbox"/> 19/pk.   |
| 220-A... 11/pk. | <input type="checkbox"/> 19/pk.   |
| 280-A... 11/pk. | <input type="checkbox"/> 19/pk.   |
| 320-A... 11/pk. | <input type="checkbox"/> 19/pk.   |
| 400-A... 11/pk. | <input type="checkbox"/> 19/pk.   |

#### Wet or Dry S/C Paper (Black)

- |                 |                                   |
|-----------------|-----------------------------------|
| 50/pk.          | 100/pk.                           |
| 220-A... 15/pk. | <input type="checkbox"/> \$25/pk. |
| 320-A... 15/pk. | <input type="checkbox"/> 25/pk.   |
| 400-A... 15/pk. | <input type="checkbox"/> 25/pk.   |
| 600-A... 15/pk. | <input type="checkbox"/> 25/pk.   |

### "SANDVIK"



- HAND SCRAPER** ..... \$5.95  
6" x 2 1/2" x .030 high quality steel cabinet scraper.

- BELT CLEANING STICK** ..... \$6.95  
2" x 2" x 6" - Makes your Belts, Discs, Sleeves last 3 x as long.

### Bench Top CUSHION CONTOUR SANDERS

Simply . . . chuck into your drill press or hand drill, inflate to desired hardness and you're ready to go. You receive 4 FREE asst. sleeves with purchase of sander!

- 2" x 4 1/2" Sander w/3/8" shaft ..... \$34.95
  - 1 1/2" x 4 1/2" Sander w/3/8" shaft ..... 33.95
  - Pk. of 5 Replace. Sleeves\* 2" x 4 1/2" ..... 4.75
  - Pk. of 5 Replace. Sleeves\* 1 1/2" x 4 1/2" ..... 4.25
- \*Choose from 80,100,120,150 grit.



### SAND-O-FLEX UNIT

- Metal SAND-O-FLEX ..... \$18.00
  - Plastic SAND-O-FLEX ..... 14.95
  - 3/8" Shank Adapter for Metal Sand-O-Flex . . . 2.00
  - Sand-O-Flex Abrasive Re-fills\* ..... 4.35
- \*Available in 80, 120, 180 grits.



### BOWL SANDING KITS

Kit includes 1 each, 2" dia. and 3" dia. sanders with 1/4" shaft. Sander conforms to the contour of the bowl.

- Kit comes with 3 flexible discs/sander.  
1 each, Fine, Medium and Coarse ..... \$9.95
  - 25 2" PSA FLEX DISCS ..... 7.00
  - 25 3" PSA FLEX DISCS ..... 9.95
- Choose from 80, 120, 180 & 220 grits. All 25 pcs. same grit.



### MITCHELL'S ABRASIVE CORDS/TAPE

- Abr. Cord (.055 dia. x 25 yds., 150 grit) . . . \$9.95
  - Abr. Tape (9/32" x 25 yds., 150 grit) ..... 10.95
- Reaches those "near to impossible places" with ease!



SEND FOR FREE CATALOG

**FREE!** WITH ANY ORDER OVER \$50.00, CHOOSE A BELT CLEANING STICK OR A "Wooden Memories" PLAN.



- Belt Cleaning Stick
- Bill E. Goat
- Ole Grey Mare
- Bessie the Cow
- Beezer the Burro

- **MONEY BACK GUARANTEE!**
- **SHOP OUR OUTLET STORE IN READING, PA.**  
"The Outlet Capital of the World"
- **PROMPT DELIVERY FROM STOCK!**

### Singley "Sleeveless" DRUM SANDERS

No pre-made sleeves to buy. Cut your 9 x 11 sandpaper, lock into drum and begin sanding.



- 3/4" x 3" ..... \$13.95
- 1" x 3" ..... 13.95
- 2" x 3" ..... 15.95
- 2 1/2" x 3" ..... 16.95
- 3" x 3" ..... 17.95



- 12 Piece Extra Length SANDING DRUM KIT** ..... \$9.95  
Included are 1 Fine and 1 Coarse abrasive band for each size drum. 1/2", 3/4", 1", 1 1/2" dia. x 2" long.

- RE-FILL PACK.**  
16 pc. asst., 1 Fine, 2 Medium, 1 Coarse per drum ..... \$5.95

## INDUSTRIAL ABRASIVES CO.

For Fast Delivery Call Toll Free  
**1-800-428-2222 (U.S.A.)**  
**1-800-222-2292 (PA only)**

643 N. 8th STREET  
READING, PA 19612

SHIPPING CHARGES - MIN. ORDER \$25.00

Under \$35 add \$2.50. \$35 or more add \$4.00. PA residents add 6% sales tax.

- MONEY ORDER
- MASTERCARD
- VISA
- CHECK

Acct. # \_\_\_\_\_ Exp. Date \_\_\_\_\_

Name \_\_\_\_\_ DAYTIME PHONE ( ) \_\_\_\_\_

PLEASE PRINT

Street \_\_\_\_\_

City \_\_\_\_\_ State \_\_\_\_\_ Zip \_\_\_\_\_

USE THIS AD TO ORDER

USE THIS AD TO ORDER

**NOW!  
REDUCE THE  
RISK AT YOUR  
TABLE SAW**



folds down neatly

WITH THE **MOBILE™  
NEW SAWING CENTER**

**OUTFEED ROLLERS**

- safe, accurate sawing
- available in 15" and 37" widths
- handle panels with ease
- dual-position table

**AND INCREASE FLOOR SPACE**

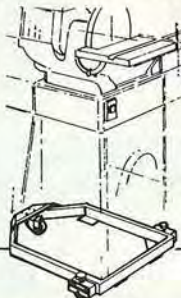

**MOBILE MACHINE BASES**

- increase shop working area
- maximize usable floor space
- 3 point base will not rock
- locking wheels
- makes machine so easy to use and store
- over 80 standard models

**PLANER STAND WITH ROLLERS**

- raises planer to proper working height
- provides machine mobility
- five-fold increase in workpiece support
- storage is a snap



**NEW**



**ROLLERTABLE  
Rock Solid Support**

- adjustable
- portable
- use at any machine

PEDESTAL  
ROLLER

Discover HTC's many unique products designed only with you, the dedicated woodworker in mind. Find out how you can make your machining safer, increase working area of your shop and accomplish nearly impossible tasks easily, quickly and accurately - **all by yourself!**

**CALL TODAY!**

HTC PRODUCTS, INC.  
120 E. HUDSON S-8  
ROYAL OAK, MI 48067  
(313) 399-6185



**1-800-624-2027 ext. 108**

Better Homes and Gardens®

**WOOD**

THE WORLD'S #1 WOODWORKING PUBLICATION

*This issue's cover wood grain: red oak*

APRIL 1989

ISSUE NO. 28

WOOD PROFILE

**DOUGLAS FIR: THE GLOBE-TROTTING HE-MAN OF AMERICAN SOFTWOODS 25**

Early loggers felled Douglas fir as tall as 400' in the Pacific Northwest. Even today, this sturdy giant makes its mark in the lumber industry.

SHOP-TESTED TECHNIQUES

**STACK-LAMINATED BOWLS 26**



You'll pile up compliments when you try our recipe for one of the most creative turning projects imaginable. Our staff teamed up with a respected stack-laminated turner to produce this article.

NOW YOU CAN BUILD IT

**A SOUTHWEST-INSPIRED BOWL 32**



Once you get the feel of stack-bowl techniques, put your talents to good use on a 12"-diameter bowl that features two traditional Navaho patterns.

IN SEARCH OF THE PERFECT FINISH

**COAXING A GLOW FROM WOOD 36**

Find out how a furniture-design professor cooks up a hard-to-beat finish by blending a marine coating and beeswax.

SCROLLSAWS UNDER \$150:

**A GOOD DEAL FOR THE MONEY? 38**



Low prices on Taiwan-manufactured scrollsaws have created a lot of interest in this benchtop machine. Read what we found about them in our shop.

**TALES OF THE TIMBER TRADE 40**

Deep in the jungles and rain forests, wood buyers still encounter an occasional spine-chilling adventure while searching out exotic imports.

**ALL DECKED OUT WITH FILIGREE PLANT STAND 42**



Blending laser technology and a traditional pattern, we've designed an accessory that deserves a place in your home. Check this out; you'll like what you see.

## TRESTLE TABLE 48

Trestle tables have been around for centuries, but you'll appreciate some updated solutions to solving assembly problems for our Shaker version. How-to photos make the difference.



## A SUREFIRE TECHNIQUE FOR PLEASING BOWL DESIGN 54

Don't leave form to chance! You can solve some vexing bowl-design problems by applying our easy-to-understand advice.



## TOOL BUYMANSHIP STATIONARY BELT SANDERS 58

We examine the true grit of 14 models and point out some important differences you should consider before buying one for your shop.



## CRAFTSMANSHIP CLOSE-UP CREOLE CRAFTSMANSHIP 64

Creole isn't just a heritage or a cooking style in George Olivier's life. Our featured woodworker toils at re-creating "Big House" plantation furniture made from sturdy, distinctive cypress that surrounds his Louisiana city.



## HOMEMADE TOOL FINE-FINISH SCRAPER 68

Jim Boelling, our project builder, shares the design of a favorite tool he relies on to smooth his best work.



## ACORNY KIND OF BIRDHOUSE 70

You'll be whistling happy tunes when a pair of busy wrens occupies this nutty new home you can turn on the lathe.



## CARVE A PAIR OF COWBOY BOOTS 72

Don't be surprised if Arizona carver Dave Rushlo looks you right in your boots. The pattern he shares with *WOOD* magazine readers makes a handsome pair of bookends.



## SHORT FEATURES

Editor's Angle . . . . .	6	Project Showcase . . . . .	46
Talking Back . . . . .	10	Sanding Belt Care . . . . .	76
Tips from Your Shop (And Ours) . . . . .	14	Birdhouse Facts & Figures . .	78
Wood Anecdote . . . . .	23	Products That Perform . . . .	83
		Tool Industry Insider . . . . .	86
		Finishing Touches . . . . .	96

DELTA

**REBATE! REBATE! REBATE!**

**13" RC-33 Planer \$1049** 22-651

37-150 6" jointer w/stand 879\*  
34-429 10" tilting arbor saw 889\*  
31-730 6" belt/12 disc 929\*  
34-995 3 ph. stock feeder 599\*  
34-985 1 ph. stock feeder 449\*  
\* Price includes rebate.

**1-1/2HP Unisaw with Unifence \$1199** 34-781

34-782 3hp unisaww/unifence 1429  
43-375 3hp H.D. shaper 1449  
33-890 12" radial saw 1149  
31-380 4"X132" edge sander 1299  
37-350 8" jointer w/stand 1269  
34-897 DELTA unifence 299

**13" RC-33 Planer \$1049** 22-651

37-150 6" jointer w/stand 879\*  
34-429 10" tilting arbor saw 889\*  
31-730 6" belt/12 disc 929\*  
34-995 3 ph. stock feeder 599\*  
34-985 1 ph. stock feeder 449\*  
\* Price includes rebate.

**1-1/2HP Unisaw with Unifence \$1199** 34-781

34-782 3hp unisaww/unifence 1429  
43-375 3hp H.D. shaper 1449  
33-890 12" radial saw 1149  
31-380 4"X132" edge sander 1299  
37-350 8" jointer w/stand 1269  
34-897 DELTA unifence 299

**14" Enclosed Band Saw w/ rip fence \$599** 28-283\*

34-444 10" contr. saw compl. 599  
33-990 10" radial arm saw 599  
33-150 8-1/4" Sawbuck 499  
34-080 10" miter saw 179  
50-179 3/4hp dust coll. w/drum349  
\* Price includes rebate.

**18" V.S. Scroll Saw \$659** 40-601

40-150 15" bench scroll saw 139  
23-700 wet/dry grinder 139  
28-160 10" 3-wheel band saw 139  
31-460 4" belt/6" disc sander 139  
31-050 1X30 belt sander 69

**Elu**

**PORTER-CABLE**

**Plate Jointer With Case \$159** 555

352 3X21 sander w/bag 119  
360 3X24 sander w/bag 179  
362 4X24 sander w/bag 189  
330 Speed Bloc finish sander 59  
505 1/2 sheet finish sander 109  
503 3X24 wormdrive w/bag 335

**Saw Boss \$95** 345

9647 Tiger Cub w/ case 119  
9629 VS Tiger saw w/case 135  
7548 VS top-handle jig saw 119  
9118 Porta-Plane w/c cutter 189  
7511 3/8" VSR drill 109

**1-1/2 HP Router \$119** 690

691 1-1/2hp D-handle router 129  
518 3hp 5-speed router 319  
696 router shaper table 109  
9850 12 V. cordless drill kit 129  
5116 Omni-Jig 279

**RYOBI**

**Portable Planer \$338** AP-10

RA200 8-1/4" port. radial saw 238  
TS251U 10"mitersaw w/accykit 199  
RE600 3hp VS plunge router 199  
R500 2-1/4hp plunge router 159  
BE321 3X21VS belt sander 119  
JP-155 6-1/8" jointer planer 329

**Mill-Route \$279** MR1/MR-R1

**freud**

**Jointing System with Case \$154** JS100

FB-100 16pc Forstner bit set 159  
90-100 15pc router bit set 159  
94-100 5pc router cabinet set 159  
91-100 13pc1/2" router bit set 199  
EC-900 5pc shaper cabinet set 279

**2-1/4 HP V.S. Plunge Router \$269** 3338

3304 1hp VS plunge router 199  
3375 3-1/8" universal planer 209  
3380 jointer /spliner 349

**LEI**

**24" Dovetail Jig \$279** D1258-24R

**BIESEMEYER**

**50" Commercial \$290** 50-B

528 52" homeshop fence 229  
408 40" homeshop fence 209  
288 28" homeshop fence 199

**Milwaukee**

**V.S. Sawzall with Case \$129** 6507

6368 7-1/4 saw w/case,ct blade129  
0234-1 1/2 VSR Magnum drill 109  
0222-1 3/8 VSR 3.5 A drill 99  
5397-1 3/8 hammer drill kit 139  
6753-1 VSR drywall driver 89

**BOSCH**

**4X24 V.S. Belt Sander \$189** 12730VS

1273D 4X24 sander w/bag 179  
1272D 3X24 sander w/bag 169  
3270D 3X21 sander w/bag 139

**V.S. Top Handle Jig Saw \$124** 1581VS

1582VS barrel grip jig saw 119  
1654 7-1/4" saw w/c.l. blade 99  
3258 3-1/4" power plane 139

**3 HP Plunge Router \$195** 1611

1604 1-3/4 hp router 119  
1609K 3 in 1 trimmer kit 169  
921VSRK 9.6Vcrdis w/clutch 139

a c m e Electric

TOOL CRIB OF THE NORTH SINCE 1948

CALL TOLL FREE FOR MIKE OR TOM  
1-800-358-3096

Box 1716 • Grand Forks, ND • 58206  
Send \$2.00 For 120 Page Catalog

# POWERMATIC



Call For Our Low Prices! We carry the entire Powermatic line at very attractive prices. Please call for our prices on the Model 66 and other Powermatic machines. You'll be glad you did!

Model 66 Table Saw with 50" Biesemeyer Rip Fence. 3HP, 1PH or 5HP, 3PH motor FOB our Warehouse.

# Mini-Max

World's Best Jointer-Planer

FS35 Jointer-Planer \$2195

Length 63" Width 13 1/4" Weight 719 lbs. 3HP, 1PH or 3HP, 3PH Motor

Please call or write for more information on the FS35 jointer-planer. We stock the entire Mini-Max line. Please call for our prices. FOB our Warehouse. Call for discounted freight rates.



## MAKITA

804510	4" finishing sander	\$ 59
1100	3 1/2" planer kit	\$209
1805	6 1/2" planer kit	\$309
2708	8 1/2" table saw	\$229
3612BR	plunge router	\$189
GUIDES for 3612BR		\$ 28
3601B	1/2" router	\$118
3700B	1/2" trimmer	\$ 95
4301BV	orbital jig saw	\$139
5007NB	7 1/2" circular saw	\$109
6000LR	1/4" clutch drill	\$119
6012HDW	1/4" cordless clutch drill	\$109
9900B	3x21 belt sander	\$129
99824DB	3x24 belt sander	\$149
9401	4x24 belt sander	\$159
98202	blade sharpener	\$169

## RYOBI SPECIALS

S500A	3 x 4 1/2" Pad Sander	\$ 39
SUG200	1/2" Sheet Pad Sander	\$ 99
B7075	3 x 21 Dustless Belt Sander	\$105
B7100	3 x 24 Dustless Belt Sander	\$121
B7200A	4 x 24 Dustless Belt Sander	\$148
R151	1HP Plunge Router	\$ 95
R501	2 1/4HP Plunge Router	\$159
TR30U	Trimmer	\$ 77
TS380	14" Miter Saw	\$369



AP-10 Thickness Planer

## FREUD SPECIALS

TT-108	8 Pc. Turning Tool Set	\$ 59
90-100	15 Pc. Router Bit Set	\$138
92-100	26 Pc. Router Bit Set	\$284
94-100	5 Pc. Router Cabinet	\$159
FB-100	16 Pc. Forstner Bit Set	\$159
EC-900	5 Pc. Shaper Cabinet Set	\$264
EC-209-213	Raised Panel Cutters	\$85
EC-260	3/4" Cabinet Door Set	\$157

### Sawblades

LM72M	10", 24T, Rip Blade	\$38
LU73M	10", 60T, ATB Cutoff	\$38
LUB4M	10", 50T, Combination	\$38
	Set of Three Above	\$107
LU82M	10", 60T, Triple Chip	\$42
LU85M	10", 80T, Super Blade	\$59
DS306	6" Dado	\$99
DS308	8" Dado	\$109
JS100	Plate Joiner	\$169
JS020	1000 Biscuits	\$29
F1100	Spare Cutter	\$ 34

## MAKITA STATIONARIES

2040	15" Planer	\$1275
2020	8" Jointer	\$775

## HITACHI

F-1000A	Jointer-Planer	\$1395
CB75F	Resaw Bandsaw	\$1645
C15FBP	15" Miter Saw	\$409
C101FB	10" Miter Saw	\$279
TR12	Plunge Router	\$173

## PORTER CABLE

518	3HP Speedtronic Router	\$323
630	1HP Router	\$ 93
690	1 1/2HP Router	\$124
110	Laminate Trimmer	\$124
312	Offset Laminate Trimmer	\$133
319	Tilt-Base Laminate Trimmer	\$138
330	Speed-Block Sander	\$ 64
352	3 x 21 Dustless Belt Sander	\$130
360	3 x 24 Dustless Belt Sander	\$185
362	4 x 24 Dustless Belt Sander	\$198
555	Plate Joiner	\$169
345	Saw Boss	Call

## JET POWER TOOLS

JBS-14MW	Metal/wood Bandsaw	\$349
JJ-6	6" Jointer	\$339
JTS-10	10" Contractors Saw	\$439
CTAS-10	10" T/A Table Saw	\$1275
	with 50" Biesemeyer Fence	
JJ-8	8" Long-Bed Jointer	\$899
JWP-15H	15" Thickness Planer	\$999
DC-610	1 HP Dust Collector	\$329
DC-1182	2 HP Dust Collector	\$449

JET Prices include delivery east of the Mississippi.

## LEIGH

TD514L	24" dovetail jig with 1/2" bits for 1/4" dovetails	\$239
D1258-12	New 12" jig for through and half blind dovetails	\$255
D1258-24	New 24" jig for through and half blind dovetails	\$289

Optional Bits in Stock

Orders over \$35.00 include delivery unless otherwise noted. Prices subject to change without notice.

# Better Homes and Gardens®

# WOOD®

THE WORLD'S #1 WOODWORKING PUBLICATION

April 1989 • Vol. 6, No. 2 • Issue No. 28

### Editorial/Art Staff

Editor LARRY CLAYTON  
Managing Editor CARL VOSS  
Art Director C. L. GATZKE  
Design Editor JAMES R. DOWNING  
Features Editor PETER J. STEPHANO  
How-To Editor MARLEN KEMMET  
Products/Techniques Editor BILL KRIER  
Project Builder JAMES E. BOELLING  
Senior Graphic Designer PERRY A. MCFARLIN  
Administrative Assistant DARLENE REYNOLDS  
Business Office Clerk JODI DOWNING

Technical Consultants: Product Testing GEORGE GRANSETH;  
Wood Technology PAUL L. McCLURE; Collectible Tools PHILIP WHITBY

Publisher JERRY KAPLAN  
National Advertising Manager TERRY McINTYRE  
Advertising Representatives ROBERT NEWKIRCHEN, NEIL A. ORNE, ERIC VERCH  
Promotion/Research Director THOMAS R. TROLAND  
Marketing Research Manager EILEEN SULLIVAN  
Marketing Services Manager NANCY DALY  
Circulation Director CLEM SEVDE; Circulation Manager BILL REED; Newsstand Circulation Director MICHAEL SENIOR  
Production Director ROBERT C. FURSTENAU  
Editorial Research Director C. RAY DEATON

### Weekend Woodworking Projects™

Managing Editor JIM HARROLD

### Magazine Group Officers

Group President JAMES A. AUTRY  
Senior Vice President, Publishing Director ADOLPH AUERBACHER  
Group Vice Presidents: Publishing Directors MYRNA BLYTH, BURTON H. BOERSMA, CHRISTOPHER M. LEHMAN;  
Controller MAX RUNCIMAN; Editorial Director DORIS EBY;  
Operations DEAN PIETERS

Chairman of Executive Committee E. T. MEREDITH III

### Corporate Officers

Chairman of the Board ROBERT A. BURNETT  
President JACK D. REHM  
Group Presidents: Book JERAMY LANIGAN; Broadcasting WILLIAM McREYNOLDS; Magazine JAMES A. AUTRY; Real Estate ALLEN SABBAG; Vice Presidents: Administrative Services GERALD D. THORNTON; Corporate Relations LEO R. ARMATIS; Finance JAMES F. STACK; General Counsel and Secretary THOMAS G. FISHER; Product Development NEIL KUEHL; Treasurer MICHAEL A. SELL; Controller and Assistant Secretary LARRY D. HARTSOOK

Better Homes and Gardens® WOOD® — the magazine for home woodworkers (ISSN-0743-894X) is published bimonthly in February, April, June, August, October, and December by Meredith Corporation, Locust at 17th, Des Moines, IA 50336. Second-class postage paid at Des Moines, Iowa. Better Homes and Gardens trademark registered in Canada and Australia. Marca Registrada en Mexico. ONE-YEAR SUBSCRIPTION PRICES: United States and its possessions, \$18; Canada, \$24; other countries, \$30. POSTMASTER: Send address changes to WOOD, Locust at 17th, Des Moines, IA 50336. April 1989, Vol. 6 No. 2, Issue No. 28. CUSTOMER SERVICE: For service on your magazine subscriptions, including change of address, write to Customer Service Manager ROBERT AUSTIN, P.O. Box 10628, Des Moines, IA 50336. Please enclose your address label from a recent issue. If you wish to phone, call toll-free 800-678-2666.  
©COPYRIGHT MEREDITH CORPORATION 1989. ALL RIGHTS RESERVED. PRINTED IN U.S.A.

# Be Your Own Boss and Make

**\$18.00**  
to  
**\$30.00**  
AN HOUR!



Your FREE Lifetime Security Fact Kit tells you how to make \$18.00 to \$30.00 an hour in your own Foley-Belsaw Full-Service Saw and Tool Sharpening Business. Your FREE Fact Kit explains how you can:

- be your own BOSS!
- work full time or part time, right at home.
- do work you enjoy and take pride in.
- operate a CASH business where 90¢ of every dollar you take in is clear CASH profit.

And it is so easy to learn. Foley-Belsaw gives you all the facts and instructions. No experience or special training is necessary. Foley-Belsaw tells you everything you need to know to be successful.

And there's plenty of business available in your area. You will be able to sharpen all types of saws, garden and shop tools for home, farm and industry.

You will be able to set your own hours and not have to worry about layoffs and strikes. And there are no franchise fees. Any age person can succeed.

But you've got to get the FACTS before you can get started. So write NOW for your FREE Lifetime Security Fact Kit. It's yours to keep with NO OBLIGATION.

... send NOW for your FREE Lifetime Security Fact Kit!



FREE LIFETIME SECURITY FACT KIT

Foley-Belsaw Co.  
6301 Equitable Rd., Dept. 20807  
Kansas City, Mo 64120

YES, I want to know more!

Please rush my FREE Lifetime Security Fact Kit.

Name \_\_\_\_\_

Address \_\_\_\_\_

City \_\_\_\_\_

State \_\_\_\_\_

Zip \_\_\_\_\_

( Area Code ) Phone \_\_\_\_\_



# From Penn State Industries... Professional Quality Woodworking Machines At Affordable Prices

## Super 15" Scroll Saw

Comparable value over \$500 • Shipped complete & ready to run • Includes \$37 Free accessory package !!!  
**On Sale..... \$129.95**

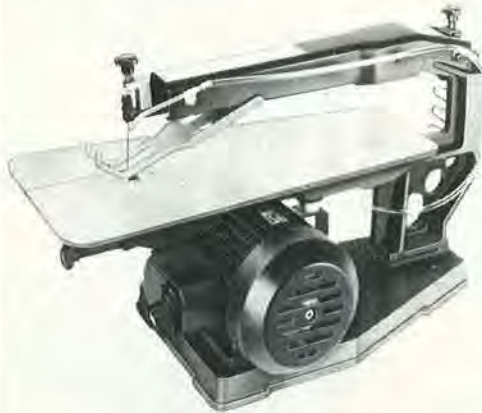

This versatile machine makes cutting intricate wood patterns easy - **Its great for making toys, jewelry, puzzles, fretwork, etc.** The blade is driven on both up and down stroke with a smooth cutting parallel rocker arm system that avoids blade breakage and **creates a smooth finish that eliminates sanding.** The Super 15" Scroll Saw is easy to set-up and use and is made with a **cast construction that insures durability.**

### SPECIFICATIONS:

- Construction ..... Cast Iron
- Throat depth ..... 15"
- Max depth of cut ..... 2"
- Machine weight ..... 43 lbs
- Motor - Heavy duty totally enclosed fan cooled 110-120V, UL listed, ball bearing induction motor
- Blades - uses 5" standard & pinend
- Stroke length ..... 3/4"
- Table tilt ..... 0 - 45° to left

### OPTIONS:

- Dust Blower • 37" Saw Stand

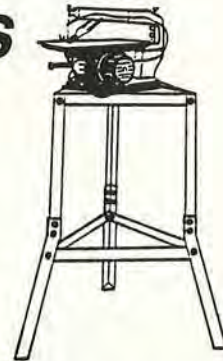

**Free with Purchase of Saw**  
12 Blade Assortment ..... \$ 3.50 value  
Extra Blade Holder set ..... 8.50 value  
Plastic Lettering guide set  
& patterns..... 25.00 value  
**FREE ... \$37.00 VALUE**

### Saw & Accessories Price List

	PRICE (UPS)
Super 15" Scroll Saw .....	\$129.95 (10.00)
Dust Blower .....	15.00 (*)
Saw Stand - 37" high .....	39.00 (4.00)
4 dz blades (2dz pin, 2dz #9) .....	14.00 (*)
2 dz Spiral blades (size #2)..	10.00 (*)

(\*) No freight charge if ordered with Saw; \$3 for any combination of these accessories ordered separately

## Super 125 Planer

Portable with "Power Feed" • Shipped assembled • Retail value over \$600.00  
**On Sale ..... \$349.95**



This machine will pay for itself time and again by planing your own lumber. At 65 lbs, you can carry this Planer to a job site or mount it permanently in your workshop like any stationary machine. **You'll spend hundreds of dollars less for this 12-1/2" power feed Planer than for a traditional stationary model of a similar capacity - with comparable results.**

### SPECIFICATIONS:

- Knives.... 2ea, 12-1/2" wide, HSS
- Motor - 14 Amp, 115V, 8000 RPM
- Auto Feed rate ..... 26.2 FPM
- Cutting speed ..... 16000 Cuts/min
- Thickness of stock ..... 3/16" to 6"
- Size ..... 15-1/2"H X 22"W X 21" Bed
- Max Depth of cut ..... 3/16"
- Machine Weight ..... 65 Lbs



### Planer & Accessories Price List

	PRICE (UPS)
Super 125 Planer.....	\$349.95 (15.00)
Extra Set of 2 Knives .....	25.00 (*)
Dust Chute for vacuum .....	24.00 (4.00)
Planer Stand .....	44.00 (6.00)
Heavy Duty, 27-1/2"high	
Roller Stand - variable ht.....	35.00 (5.00)
Hvy duty, ball bearing, ht 25-45"	

(\*) No frt chg if ordered w/Planer, otherwise add \$3.00

## Dust Collector

Keep your shop clean and safe from sawdust with our large capacity, commercial style system. This collector has up to **10 times more air flow** than most Industrial Vacuums. We include over \$15.00 of free hose and adapters with your purchase.

### SPECIFICATIONS:

- 4" inlet • 1hp, 110/220V (pre wired 110V)
- 610 CFM air flow • 2 Bags 15"dia X 22"
- Casters on base for maneuverability
- Weight 75lbs • Size - 26"X15"x57"H

**On Sale ... \$189.95**

Add \$17.00 UPS Freight

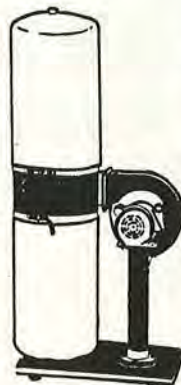

## Penn State's Commitment

*Our company has been in business for over 50 years. We unconditionally guarantee your satisfaction with our fine machines. All of our machines carry a Thirty day Money Back Guarantee and One year Warranty for Parts and Labor.*

**Penn State Industries-W**  
2850 Comly Road • Phila, Pa 19154  
Order Toll Free 1-800-288-7297 (Ext 28)

For information 1-215-676-7609 (Ext 15) • Visa/Mc accepted Pa residents add 6% Sales Tax • **Add UPS Shipping Charges as noted** (Continental U.S. only)

## WHY DO WE SHOP-TEST OUR TECHNIQUES?

BECAUSE THE PROOF IS IN THE PUDDING!

I have to chuckle every time I think about the Fisher Nut Company's television commercial of a few years back—the one in which the highly proper chairman of the board announces at a board meeting: "At Fisher, we take the nut very seriously."

We at *WOOD*® magazine approach our task much the same way. And nowhere does our intent show more clearly than in the way we develop our shop-tested techniques articles. Take, for example, this issue's piece on stack-laminated bowls, which begins on page 26. Because we first learned about this technique from *WOOD* magazine reader Bill Lovelace, I asked Bill Krier, our products/techniques editor, to fly to Phoenix, Arizona. His assignment: To learn firsthand about how the process works.

After spending two solid days with Bill Lovelace in his Phoenix workshop, Bill returned to Des Moines with all kinds of bowl scraps and more than 100 photos depicting every conceivable step of the process from every imaginable angle.

With all this raw data in hand, our techniques team (shown above) huddled in the conference room to share thoughts about the technique and to plot their testing strategy. Then it was off to our shop, where each and every technique we feature in *WOOD* magazine must prove itself workable.

One week later, after cutting and assembling lord only knows how many stacked bowls, our trio of technique testers emerged with



Our team met for hours before giving its approval on the stove-bowl article. From left are: Jim Boelling, Bill Krier, and Jim Downing.

some good news. "Yes, Bill Lovelace's techniques work, and we've even found a few ways to make the process less time-consuming for our readers." For example, our team developed a clamping platform and a system of clamping that speed the glue-up of segments, a guide-pin system that allows you to glue several bowl layers together at one time, and several other improvements you can read about in the article.

My point is this: At *WOOD* magazine, we're not content to just repackage old information that you've read about time and time again. We actively search out new and improved ways of doing things—and put conventional woodworking wisdom to the test—in our on-site shop.

Then and only then does a technique receive the Shop-Tested stamp of approval you see here. ♣

*Larry Clayton*



# BOSCH



## Woodworking



### Trimming Laminates or Veneers?

Bosch 1608 Laminate Trimming System includes 5.6 amp motor and complete set of accessories for virtually all shop, installation tasks. Includes standard, tilting and offset bases.



### Bosch Jig Saws Set Performance Standards

Model 1581VS. Run it through its 6 speeds and 4 blade orbits. Virtually vibration-free, its controls, blade lock and guide, tilting foot-plate, blade options and 4.8 amp motor let you meet all sawing requirements.



### 3 HP Plunge Base Router

Ergonomics, superior safety with lever and switch on handle for easy and total control mark the Bosch 1611. Collet capacity to 1/2".





lets you take advantage of the power of a belt sander on jobs you might not have thought possible. Choose a lower speed with a fine grit for finishing sanding—or with a coarse grit to reduce heat build-up and clogging. Combine the higher speeds with a coarser grit for faster stock removal, no matter what the material. The speed selector dial is conveniently located just under the trigger. And the on-board sanding guide helps you select the right speed for your job.

SOLID WOOD	4-6
VENEER	3-5
CHIP BOARD	5-6
PLASTICS	3-5
STEEL	3-6
PAINT REMOVAL	3-6

The powerful 10.5 amp motor gives you power—even for heavy-duty production sanding. And this sander's fine balance lets

you control that power with minimal effort.

Use the 1273DVS with its own dust collection bag—or connect it to the Bosch Air Sweep™ Dust Extraction system. Change belts with the snap of a lever. And the unique belt tensioning system makes sure belts stay centered through all kinds of work.

So check out what a world class variable speed belt sander can do for the quality of your sanding. See your Bosch Distributor today—he's listed in the Yellow Pages "Tools—Electric." Let him show you how this belt sander gives you more control with one finger than others do with two hands.

## Bosch Variable Speed Belt Sander: As Good At Fine Finishing As It Is At Finishing Fast.

One Finger Control Lets You Dial-In The Speed You Need.

Now you can rely on more than just the grit of your sandpaper—and the muscles of your arms—to

control the quality of your sanding. Believing is getting your hands on the versatile Model 1273DVS variable speed belt sander by Bosch.

With six different speed ranges to choose from, the 1273DVS



**BOSCH**

"Quality You Can Hold On To."

©1988 Robert Bosch Power Tool Corporation

Take any

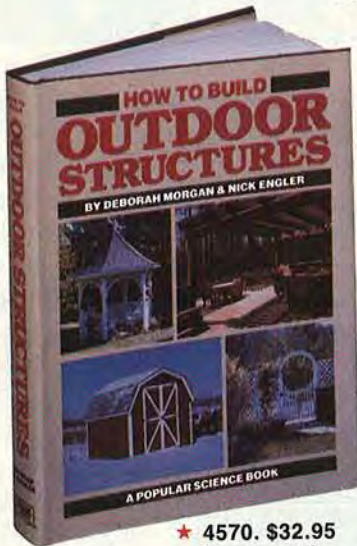

★ 4570. \$32.95 (counts as 2)

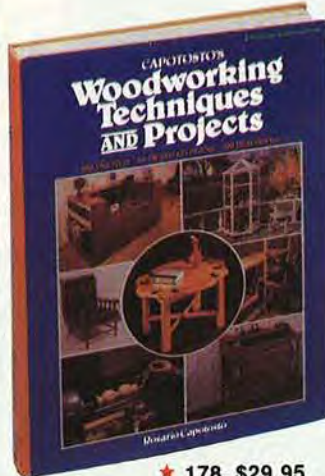

★ 178. \$29.95

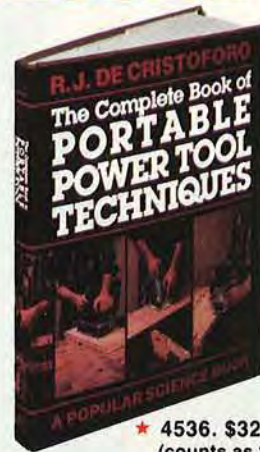

★ 4536. \$32.95 (counts as 2)

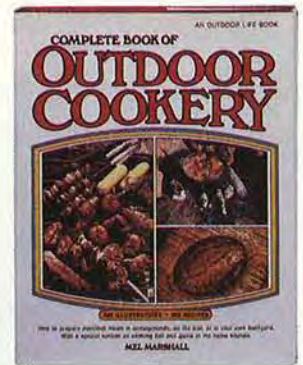

★ 166. \$26.50

# Popular Science BOOK CLUB

A Service of Grolier Book Clubs, Inc.  
P.O. Box 1763, Danbury, CT 06816

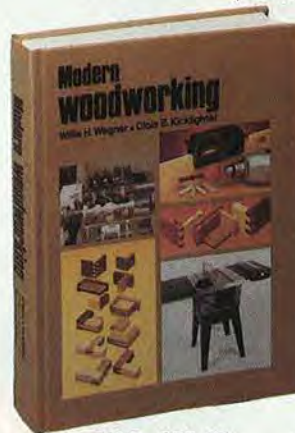

6107. \$39.95

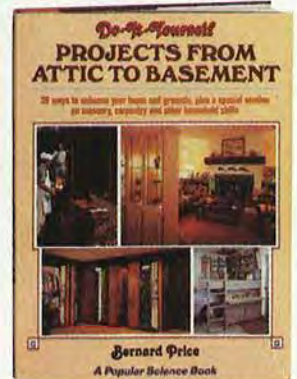

★ 4508. \$29.95

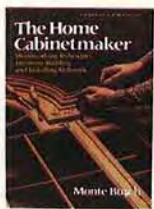

153. \$27.95



5753. \$11.95



★ 89. \$19.95



★ 97. \$19.95



★ 105. \$17.95



6148. \$29.95



★ 113. \$15.95



★ 1978. \$17.85 Paperbound



3 Books—count as 1

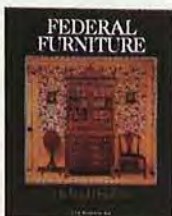

6085. \$24.95

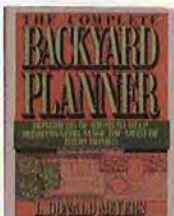

6056. \$17.50



5831. \$19.95



193. \$28.95

## The #1 DO-IT-YOURSELF BOOK CLUB

**The Best How-To Authority...** Popular Science Book Club is the largest and oldest special-interest book club serving successful do-it-yourselfers for more than 25 years!

**The Best Do-It-Yourself Books...** PSBC editors comb the country searching for the newest, finest and often hard-to-find books on today's important homeowner subjects: HOME REPAIR & IMPROVEMENT • HOME REMODELING, RENOVATION • RESIDENTIAL CARPENTRY • BASIC & ADVANCED WOODWORKING • HOME WORKSHOPS • HOUSE BUILDING • HOUSE WIRING, PLUMBING, HEATING, MASONRY & CONCRETE • APPLIANCE REPAIR and much more.

**Exclusive "Popular Science Books"...** PSBC serves its members best by commissioning the top how-to writers-photographers to produce definitive books on important Club subjects. See titles with ★. These are cream-of-the-crop, do-it-yourself books available nowhere else at Club discount.

**Big Bargains—UP TO 75% DISCOUNT...** PSBC cuts prices on hundreds of special book bargains offered throughout the year to the membership.

**Quality Production Control...** PSBC selections are printed with careful attention to detail on paper, printing, binding. You'll use these books for years!

**NO-RISK GUARANTEE...** PSBC guarantees your complete satisfaction—or you may return the books at our expense.

Mail card today!

offers you super savings up to \$100.90

**3** for just **\$4.95** Values up to \$105.85!

with No-Risk Free Trial Membership  
in Popular Science Book Club

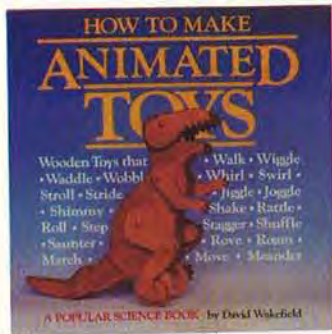

★ 4538. \$29.95 (counts as 2)

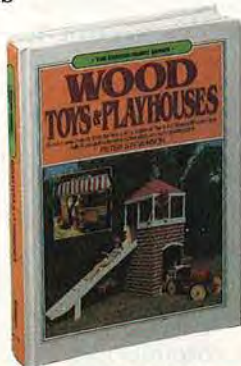

6023. \$16.95

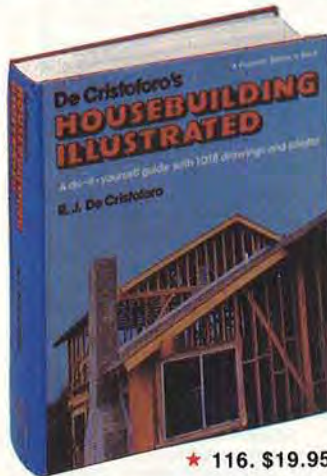

★ 116. \$19.95



5878. \$21.95

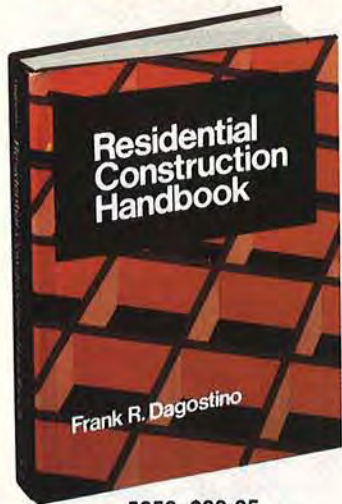

5858. \$39.95

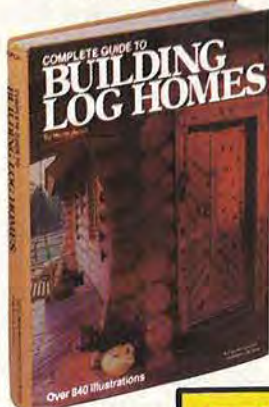

★ 190. \$29.95 (counts as 2)



★ 4569. \$14.95 Paperbound

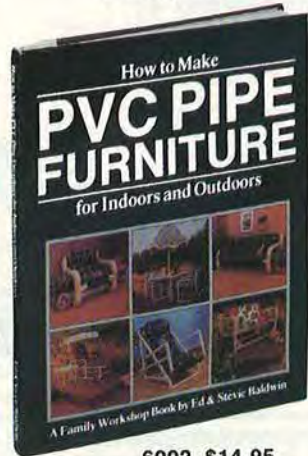

6002. \$14.95

**FREE** when you join

The **BENCHTOP REFERENCE** gives you instant answers to hundreds of do-it-yourself questions on Woodworking, Joinery, Dowels, Veneers, Laminates, Fasteners, Sharpening, Grinding, Concrete, Electrical work, more! 48 big 8 x 10<sup>3</sup>/<sub>4</sub> pages. All illustrated! Super handy and indispensable.

**HOW Popular Science BOOK CLUB WORKS**

**ENJOY SAVINGS UP TO \$100.90 NOW...** When you take any 3 selections here for just \$4.95 plus delivery and handling. Simply indicate your choices on the attached postage-free card and mail.

**CLUB MEMBERS' BULLETINS...** Fifteen times a year (about every 4 weeks), you'll receive a Club Members' Bulletin package describing the coming Main Selection and nearly 100 additional books you may choose from. If you want the Main Selection only, do nothing; it will be sent to you automatically. If you want another book—or no book—indicate your wishes on the form provided and return by date shown. You will always have at least 10 days to do this. Should the bulletin arrive late and you receive an unwanted selection, you may return it at our expense.

**UP TO 75% DISCOUNTS...** Club prices range from \$5.99 for special book bargains offered at super savings up to 75% and even more... all the way to richly-produced, very special books that list as high as \$50 and more—all offered to members at exclusive Club discounts.

**FREE GIFT with cancellation privilege...** You may cancel your membership at any time after buying just two more selections of *your choice* within a year. To try us with no obligation, simply mail the attached card—a valuable FREE GIFT is yours to keep just for looking. *Mail the card now!*

PS/S93D



6140. \$32.95



2 Books—count as 1

1988. \$11.90 Paperbound



5985. \$17.95



★ 109. \$15.00



5882. \$19.95



★ 84. \$31.95 (counts as 2)



★ 194. \$32.95



6033. \$27.95 (counts as 2)

## MAKE BEAUTIFUL RAISED PANEL DOORS . . . WITH YOUR 1/4" ROUTER!

Professional production quality bit makes it quick and easy to produce matching rails and stiles — the panel raising bit with ball bearing guide makes the raised panel perfect every time.

Regular value Over \$150.00

SALE PRICE **\$69<sup>95</sup>** FOR COMPLETE SET

ORDER ITEM #054 for 1/4" Shank Set  
(Includes all bits shown)

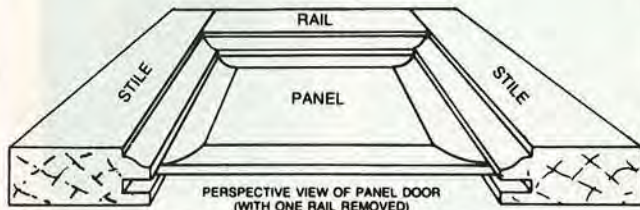

**RAISED PANEL BIT**  
SUPPLIED WITH  
BALL BEARING

2" Large Diameter

CARBIDE TIPPED  
1/4" Shank



**REVERSIBLE  
COMBINATION  
RAIL and STILE BIT**

(For making matching rails and stiles in  
raised panel doors, etc.)  
Works with stock from  
11/16" to 7/8" thick

CARBIDE TIPPED — TWO FLUTE  
1/4" SHANK  
supplied with Ball Bearing

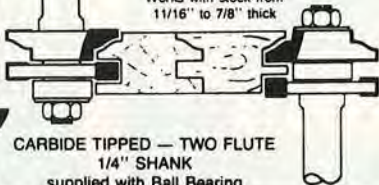

To order by Mastercard or Visa Toll Free  
7 Day—24 Hour Order Service, Call  
1-800-533-9298

or send check to: MLCS, Ltd., P.O. Box 4053D, Rydal, PA 19046

## FINGER JOINT ROUTER BIT #161

a professional production quality bit makes better edge and end grain joints by increasing the glue surface area

- Ideal for joining particle and composition board, as well as solid wood
- Makes super strong mitre joints
- Replaces mortise and tenon in many cases
- Quick and accurate set ups
- Joins 1/2" — 1" in one pass; 1" and up with multiple passes

FULL SCALE



Three 3-wing carbide cutters on arbor

Actual  
Size  
Bit #161  
1/2"  
Shank

- The 3 cutters have 1/2" bore and can be used on a shaper with 1/2" spindle.
- An additional cutter can also be added to the arbor for use on a router
- Individual cutters cost \$20.00 each Order #161-C for cutter only

To order by Master Charge or Visa Toll Free  
7 Day — 24 Hour Order Service, Call  
1-800-533-9298 or send check to:  
MLCS Ltd., P.O. Box 4053D, Rydal, PA 19046

## TALKING BACK Print this article

We welcome comments, criticisms, suggestions, and even an occasional compliment. The volume of mail we receive makes it impossible to answer every letter, but we promise to do our best. Send your correspondence to: Letters Editor, Better Homes and Gardens® WOOD® Magazine, Locust at 17th, Des Moines, IA 50336.

### ALL YOU NEED TO KNOW ABOUT STAVES

The stave-angles chart in your stave-bowl construction article in the June 1988 issue fascinated me. Readers might be interested in knowing the equation for the basics of this table:

$$\text{Cut angle} = 180^\circ \div \text{number of staves}$$

This formula might be helpful in other cylindrical projects. One that comes to mind is building an old-fashioned wooden bucket.

—Robert A. Miller, Altamonte Springs, Fla.

### A BETTER LETTER OPENER

In your February 1988 issue, you published an article about making a laminated letter opener. Since reading the article, I have made approximately a dozen of these openers. Thanks to your fine directions, they all came out beautifully.

However, I found it difficult to safely cut the last 2" or 3" of the 1/2" laminated part. To solve this problem, I glued a piece of white pine to the end of the lamination. Now I can cut at a 45° angle—even down to the last 1/2".

—J.R. DeHoney, Lansing, Mich.

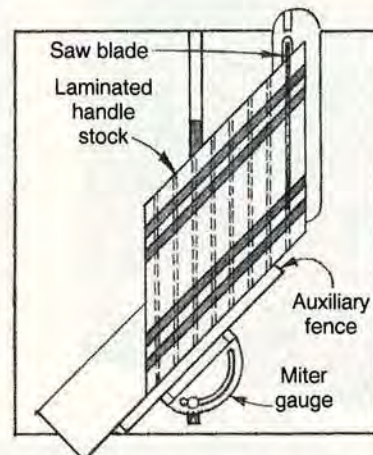

### NEW SPINS ON CAROUSEL PROJECT

I originally ordered WOOD magazine for my husband, but I enjoy it as much or more. I made the animal carousel in the October issue. The beautiful wood grain aside, I painted one in nursery colors for a shower gift. Since then, I've made 11 other carousels for my friends.

My husband is into the big stuff—cabinets, furniture, and so forth. I do sign work with the router and just enjoy being in the shop. Thank you so much for many clever ideas and for instructions a layperson can understand. You make your magazine something to look forward to.

—Cecelia Deuel, Kernville, Calif.

I have tried a few of your projects and my favorite is the animal carousel. I like it so much that I have made six to date. I made two with your original animal patterns. Then, I made others with clowns, a Christmas theme, and carousel horses. My latest carousel: Santa on a sleigh with four reindeer.

—Niki Gilbert, Odessa, Fla.

## ANOTHER WAY TO SHARPEN JOINTER KNIVES

In the August 1988 issue of *WOOD* magazine, the article on sharpening jointer and planer knives on page 74 suggests to raise the

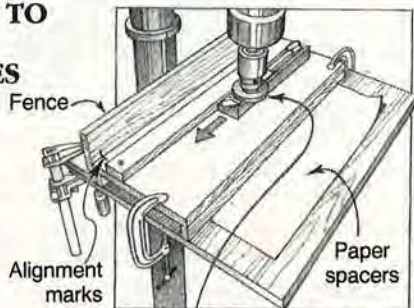

Note: Grinding wheel guard not shown

table slightly after the first pass or two. A better method is what I describe as the "turning over a new leaf" technique. Place the jig on one or two layers of manila file folders on the drill-press table. Instead of manually moving the table, you control the amount of steel being removed by inserting a file folder beneath the jig after each pass. This technique increases your control of the cut and reduces the danger of taking off too much steel at one time.

—William Brousseau, Lower Sackville, Nova Scotia

Thanks for the suggestion, Bill. Your method simplifies the calibration process.

## TRY THESE WOODS FOR RELIEF CARVING

Since our "Step-By-Step Relief Carving" article appeared in the February 1989 issue, some beginning carvers have asked us what woods to use for relief carving. Jim Rose, our source on relief carving, tells us these popular woods carve easily: butternut (the wood used in the article), sugar pine, jelutong, basswood, redwood, and tupelo. More-experienced carvers may want to try black walnut—a harder, but beautiful, wood.

## DISC SANDING

In your stave-bowl construction article in June 1988, you mention fitting a tablesaw with a disc-sanding attachment. I have inquired about this item in our local stores, but no one has heard of this arrangement. Where can I buy this setup for my tablesaw?

—Kris Kransberg, Tavernier, Fla.

On page 136 of their 1988-89 Power Tool Guide, Sears shows an 8" sanding disc (item no. 9R22741) for \$6.99 plus postage and shipping. And, good luck with your bowls, Kris.

Continued on page 12

# WILLIAMS Tool

SALES COMPANY, INC. EST. 1946

<b>DELTA</b>	15" Scroll Saw	\$129	#40-150
34-761	10" Unisaw 1-1/2 hp.....	Call	
34-782	Unisaw with Unifence	Call	
34-444	10" Contractors' Saw.....	588	
34-670	10" Table Saw.....	319	
43-122	Wood Shaper.....	549	
33-150	Sawbuck Trim Saw.....	525	
34-995	Prod. Stock Feeder 3hp	*739	
34-994	Prod. Stock Feeder.....	*829	
28-283	14" Band Saw 3/4 hp...	*588	
28-243	14" Band Saw 1/2 hp...	519	
28-160	10" 3 Wheel Band Saw.	139	
33-990	10" Radial Saw.....	568	
37-350	8" Precision Jointer.....	1288	
37-150	6" Jointer DJ-15.....	*928	
22-651	13" Planer.....	1069	
14-040	14" Bench Drill Press...	244	
11-950	8" Bench Drill Press.....	118	
17-900	16-1/2" Drill Press.....	298	
31-730	6" Belt Finish. Mach.....	979	
31-050	1x30 Belt Sander.....	72	
	*AFTER REBATE		

<b>PORTER CABLE</b>	\$54	#330
Speed Bloc® Sander		
690 Router, 1-1/2 hp.....	114	
100 Router, 7/8 hp.....	90	
518 5-Sp Elec. Router, 3 hp...	324	
309 Laminate Trimmer.....	83	
555 Plate Joiner.....	157	
Biscuits pkg.....	25	



**1-800-338-6668**  
2017 White Settlement Rd.  
Fort Worth, TX 76107

<b>BOSCH</b>	1-3/4 hp Router	\$118	#1604
1581VS	VS Orb. Jig Saw.....	\$128	
1611	3 hp Plunge Router...	198	
1198VSR	1/2" VSR Ham. Drill....	124	
1196VSR	3/8" VSR Ham. Drill....	107	
1609K	Laminate Kit.....	155	
1582VS	VS Orb. Jig Saw.....	118	



<b>HITACHI</b>	12' Planer Jointer	\$1389	#F1000A
TR12	1/2" Super Duty Router	\$168	
C15FB	15" Hvy Duty Miter Saw	368	
C8FB	8" Compnd Miter Saw...	479	
TR8	1/4" Hvy Duty Router...	118	
CB75	Band Saw.....	1575	



<b>RYOBI</b>	10" Surface Planer	\$347	#AP10
S500A	1/8 Sheet Finish Sander	\$28	
RE600	3 HP Router.....	195	
BE321	3x21" VS Belt Sander....	119	
TS251U	10" Miter Saw	167	
R500	2-1/4 HP Plunge Router	155	



<b>ELU</b>	2-1/4 hp Elec. Plunge Router	\$266	#3338
3337	2-1/4 hp Plunge.....	247	
3304	1 hp Electronic Plunge..	180	
3303	1 hp Plunge.....	145	
4024	3x21 Electmc Belt Sndr..	206	
4023	3x21 Belt Sander.....	192	
3375	Universal Planer.....	195	
3380	Jointer/Splinter.....	325	
4029	4"x24" Belt Sander.....	325	
40900	Router Access. Kit.....	135	



## New "Quad-Drive" DRUM SANDER with Infinitely Variable Power Feed!



**At last! A complete power-feed Drum Sander at an affordable price! Choose from 26" and 38" models. SAVES TIME... IMPROVES RESULTS.**

Use this high-tolerance machine for light dimensioning as well as the finest finish work. Now you can add new beauty to each woodworking project... save hours of tedious hand sanding! In a matter of seconds you can produce a satin-smooth finish impossible to duplicate with hand methods or hand-held power sanders... no more low spots, waves or cross-grain marks! Check these advantages...

**FREE FACTS!**

Send for complete facts on how you can try this low-cost tool in your own shop for one full month without risk.

See how the sander can dimension and finish-sand cabinet pieces, resawn stock, paneling, toys, tabletops, knees, burls, crotches and much, much more! You'll soon find it's one of the most valuable tools in your shop! Made in U.S.A. Easy Terms.

Call Toll Free 1(800)538-4200, Ext. 2430

**30-Day Free Trial!**

**NEW INFINITELY VARIABLE FEED RATE** gives you total control in any sanding situation!

**EXCLUSIVE QUAD-DRIVE FEED SYSTEM** four power-feed rollers for maximum traction. Eliminates oversanding at first and last few inches of a board!

**NEW FELT-BACKED ABRASIVE** mounts in just seconds to Velcro covered drum. The harder you sand, the tighter it stays! Eliminates stretching... allows fast removal and re-use!

**FREE FACTS**  **YES!** Please rush my **FREE INFORMATION KIT** and details on your 30-Day Free Trial Guarantee.

Woodmaster Tools, Dept. RW30  
2908 Oak, Kansas City, MO 64108

NAME \_\_\_\_\_

ADDRESS \_\_\_\_\_

CITY \_\_\_\_\_

STATE \_\_\_\_\_ ZIP \_\_\_\_\_

# Another breakthrough tool only from Garrett Wade.

As the industry innovator we don't let sawdust grow under our feet. Years ago we introduced a whole new kind of catalog that went on to pioneer INCA Machinery, Chamfering Planes, Horizontal Wet Grinders, and countless other breakthrough tools. And our 1989, 212-page Catalog is no exception. It's new from start to finishing.

It has dozens of new woodworking hand tools, machines, accessories and finishing supplies that are the finest available. Anywhere. It's packed with detailed photographs, honest specifications, reliable descriptions, all divided into easy-to-find, easy-to-use sections.

But offering quality tools isn't all that sets our catalog apart. There's quality advice. On current woodworking techniques. On choosing the right tool. On sharpening, clamping, finishing and more.

Just send us the coupon with \$4.00 or call for your 1989 Garrett Wade Catalog—plus free handy supplements throughout the year. It could be just the kind of breakthrough tool your workshop needs.



## Our 1989 Catalog.

Garrett Wade Dept. 624  
161 Avenue of the Americas  
New York, NY 10013



Name \_\_\_\_\_  
Address \_\_\_\_\_  
City \_\_\_\_\_  
State \_\_\_\_\_ Zip \_\_\_\_\_

Toll Free  
800-221-2942

New York State Residents (212) 807-1757

## TALKING BACK

Continued from page 11

### WASTE SOME WOOD, SAVE SOME FINGERS

I have some questions about the baja buggy project published in the December 1988 issue of *WOOD* magazine. First, why do you need two 12" pieces of 2x4 stock

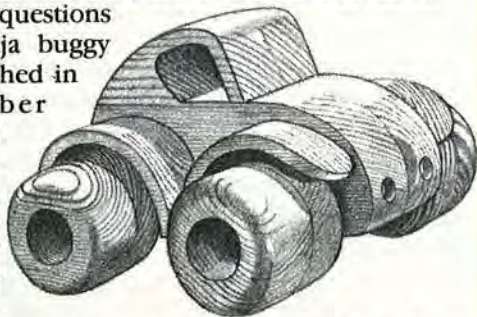

planned to 1 1/16"? If I follow this, I will have 6" of stock left over; I thought the remaining stock would be for the fenders, but I later found out the fenders required another piece of 2x4. I feel one 12" piece planed to 1 1/16" and crosscut into two 6" pieces would do.

Second, wouldn't it look better to plane or resaw a 6" or 12" piece of 4x4 to 2 1/8" for the body and wheels? This eliminates a glue line and mismatched grain when the buggy is stained or finished clear.

Third, the windows are easier to cut with a 1/4" start hole and a scrollsaw. This way, you eliminate the access cut made by the bandsaw.

I used these methods to make a buggy for my grandson. And, thank you for the plans; they give me ideas to use on other toys I make.

—Harry Osborne, New Castle, Va.

*Harry, you're not the first reader to ask these questions. For safety reasons, we never recommend planing or resawing any stock shorter than 12". Even though our method wastes a little bit of stock, safety always remains our first concern.*

*On your second point, it's tough for some of our readers to find good-quality 4x4 pine or fir for projects. Also, we've experienced fewer stability problems when laminating 2x4 stock than when planing 4x4 stock. In comparison to 2x4 stock, we've noticed a slightly higher moisture content and lower quality with 4x4 stock. We believe that even by planing down 4x4 material, you're likely to end up with a piece of stock that will twist or warp; laminated stock tends to be much more stable.*

*Third, we hope readers will realize there is more than one way to build a project. Yes, a scrollsaw would be great to eliminate one cut mark. But, we suggested the bandsaw because nearly 60 percent of our readers own bandsaws (38 percent of our readers own a scrollsaw). In addition, some scrollsaws have a 2" maximum depth of cut.*

*Space limitations dictate that we can't list all the hand- and power-tool alternatives for assembling our projects. We applaud our readers who use our plans as a springboard to customize our projects to their needs—or as you've done—use alternate machines to achieve the same results. ♣*

# "Jorgensen"® AND "Pony"® CLAMPS

Dependable extra hands for all types of clamping and work-holding jobs: Woodworking Projects, Home Maintenance, and Furniture Repair.

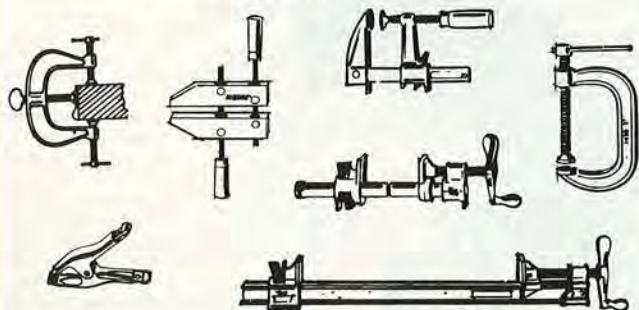

Write for FREE LITERATURE.

For big 32-page "how-to-clamp-it" catalog, send \$1.00.

ASK YOUR DEALER  
ADJUSTABLE CLAMP COMPANY

THE CLAMP FOLKS

410 N. Ashland Avenue • Chicago, IL 60622

## More New Items for '89



### Dust Collector

- 1 hp, 110v
- 4" inlet
- Commercial quality
- Compact size

Reg. \$348.00  
**\$209.00**  
 (Shp. & Hdlg. \$30.00)

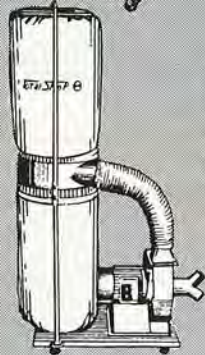

### Industrial Dust Collector

- 2 hp, 110v
- Two 4" inlets
- 1185 CFM
- 125 lbs.

\$499.00 Value  
**\$339.00**  
 (ships freight collect)

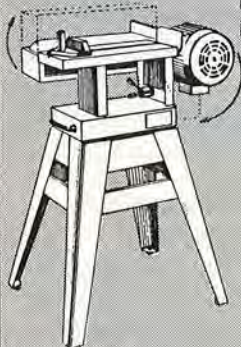

### MS-648 Sanding Machine

- Table tilts 2 ways for horizontal or vertical sanding
- ¾ hp
- 6" x 48" Band
- 17¾" Table

Reg. \$369.00  
**\$269.00**  
 (ships freight collect)

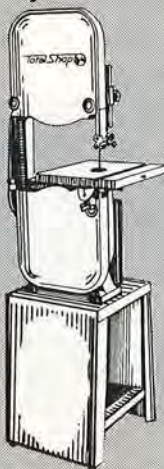

### TS 14-56 14" Bandsaw

- Blade size up to ¾" wide
- Cast iron construction
- 180 lbs.
- ¾-hp

**\$259.00**  
 (ships freight collect)



List \$1315

**\$915**

In less than a minute The Total Shop Multipurpose machine can be converted into any of five basic power tools necessary for any building project, yet it takes up less space in your shop than a couple of old trunks. The Total Shop multipurpose machine is strong, precise and versatile, not to mention priced so that owning your own woodworking shop is a real possibility and not a problem.

Call Toll Free ☎ **1-800-845-9356**

or in S.C. **288-4174**

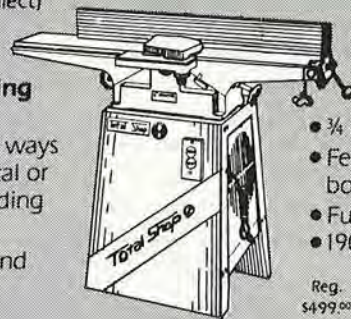

### 6" Long Bed Jointer

- ¾ hp, 110v
- Fence tilts 45° both ways.
- Fully adjustable
- 190 lbs.

Reg. \$499.00  
**\$299.00**  
 (ships freight collect)

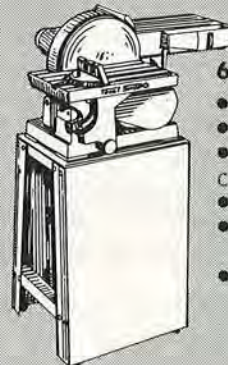

### 6" Belt Sander

- ¾ hp
- 6" x 48" belt
- Cast iron construction
- 152 lbs.
- 9" Sanding Disc Included
- Ball Bearings

**\$199.00**  
 (ships freight collect)

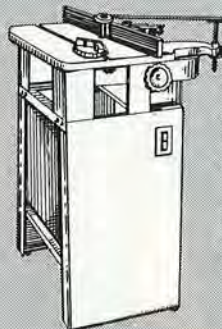

### Wood Shaper

- ½" Spindle
- 1 hp
- Cast iron construction
- Precision fence
- 160 lbs.
- Ball bearings

Reg. \$499.00  
**\$239.00**  
 (ships freight collect)

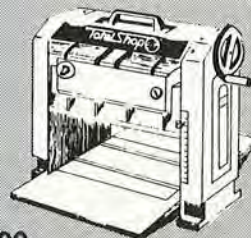

### 12" Thickness Planer

- Depth of cut ⅛"
- Feed rate 26 fpm
- 69 lbs.
- Safety Switch
- All ball bearing

**\$395.00**  
 (Shp. & Hdlg. \$20.00)

15" and 20" Planers also available

### 1 Hour Video Brochure



- YES! Please send me your free 24 page catalog.
- YES! Please send me your 1 hour video brochure (Enclose \$10.00 refundable deposit - specify VHS or Beta)

**TotalShop®**

Dept. 3

P. O. Box 25429, Greenville, SC 29616

Name \_\_\_\_\_  
 Address \_\_\_\_\_  
 City \_\_\_\_\_  
 State/Zip \_\_\_\_\_  
 Phone \_\_\_\_\_

**FREE 24 PAGE CATALOG**

Call Toll Free or Write for our newest catalog today **1-800-845-9356**

**CLEVER WAY TO SURFACE THIN STRIPS**

*Surfacing the faces of thin or narrow lengths of exotic woods is simple enough if you have the luxury of owning a thickness planer. But what if you have only a 6" jointer?*



**TIP:** With hotmelt adhesive, spot-weld the strip to be surfaced to the square edge of a board that's approximately as wide as each piece. Now feed the material safely through the jointer until you reach the desired thickness. You can separate the pieces with a wooden wedge, provided you apply the hotmelt adhesive in small spots, not long beads.

—John A. Byer,  
Vancouver, B.C., Canada

WIN A POWER TOOL  
**TOP SHOP-TIP CONTEST**

Often without realizing it, we've all discovered techniques around the shop that help us work more efficiently. But now, you have a better reason than ever to get those tips into **WOOD®** magazine!

Starting with this issue, our editor's panel will award a power tool and our own Woody Award to the reader who submits the top shop tip (you'll find this issue's winner on page 16). So get busy and think of your most useful and original tips, because we'll be giving away more power tools! Everyone can't win the top prize,



of course, so as always, we'll pay \$25 for each published submission. Also, Woodcraft Supply Corp. will award a \$25 gift certificate for all the tips in this issue. We try not to use shop tips that have run in other magazines, so please send your tip to only one magazine. We cannot return shop tips.

Mail your tips, address, and daytime phone number to:

**Shop Tips**  
**Better Homes and Gardens®**  
**WOOD® Magazine**  
**Locust at 17th**  
**Des Moines, IA 50336**

**SOFTEN THE BLOW FROM SHARP CORNERS**

*The corners of the tables on stationary power tools can inflict painful bumps, particularly on the heads of children.*

**TIP:** Cover these sharp metal corners with lengths of pipe insulation tubing slit open on one side. Glue in place using hotmelt adhesive. Then trim the padding flush with the top of the table.

—Ak Lallas, Viroqua, Wis.

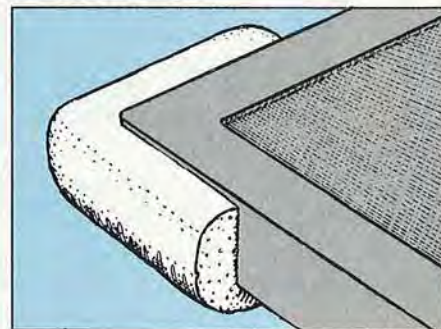

**FAST METHOD OF RESCALING PLANS**

*Reducing or enlarging patterns usually means spending hours at the drawing board to replot the pattern on graph paper.*

**TIP:** Photocopy several increased and decreased copies of a 12" ruler, scaled at various ratios such as 25, 50, 75, 100, 125, and 150 percent. Glue the photocopies to pieces of wood as shown at right. Then, use the full-sized ruler to measure the original object or pattern. Next, determine the increase or decrease in size needed. For example, we measured the original 10½"-high candlestick shown at right, and laid out a larger proportioned candlestick using the 175 percent ruler.

—Kenneth A. Storey,  
Chattanooga, Tenn.

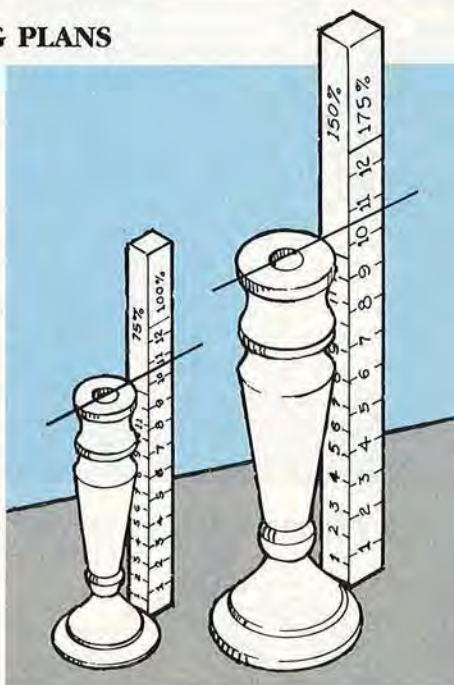

**FINISH GOES ON SMALL PARTS—NOT FINGERS**

*Applying practically any kind of finish to small wooden pieces often turns into a messy process. Whether you spray or brush the finish, keeping the parts in one place can be difficult.*

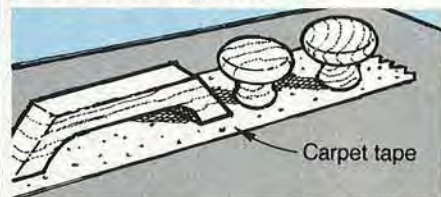

**TIP:** You'll find it a snap to finish small items such as knobs and pulls if you press them onto strips of double-faced cloth-backed carpet tape attached to a sheet of corrugated cardboard.

—Dixie Thorne, Ojai, Calif.

Continued on page 16



# DUST COLLECTOR STAMPEDE CONTINUES



G1031

G1028/G1029

G1030

We have negotiated a multi-million dollar deal with the factory and are pleased to inform you of a huge promotional price-break on all the dust collectors we carry. This is a time-limited special and prices are subject to change without notice.



IMPORTS, INC.

**WE WILL NOT BE UNDERSOLD - PERIOD!**

**MODEL G1031:** Mini Dust Collector, features 2 bags, 1/2 H.P. motor. Stands 58" high, intake hole is 4", base measures 15" x 26". **Beware!** A lot of importers are selling this model as 1 H.P.! Weighs 75 lbs. **ONLY \$189<sup>95</sup>** Prepaid to you!

**MODEL G1028:** Features 2 bags, 1 H.P., 12 amp. motor. Stands 76" high, 610 ft.<sup>3</sup> min., base measures 20" x 35", one 4" intake hole. Weighs 185 lbs. **ONLY \$265<sup>00</sup>** F.O.B. Bellingham, WA or Williamsport, PA

**MODEL G1029:** Features 2 bags, 2 H.P. motor that draws 10 amps at 110V and 20 amps at 220V, 1182 ft.<sup>3</sup> min., base measures 20" x 35", two 4" intake holes. Weighs 210 lbs. **ONLY \$295<sup>00</sup>** F.O.B. Bellingham, WA or Williamsport, PA

**MODEL G1030:** Features 4 bags, 3 H.P. single phase motor that draws 18 amps at 220V or 36 amps at 110V, 1883 ft.<sup>3</sup> min., three 4" intake holes, base measures 21" x 46". Weighs 270 lbs. **ONLY \$410<sup>00</sup>** F.O.B. Bellingham, WA or Williamsport, PA

## NEW TOLL FREE LINES

(FOR ORDERS AND CATALOG REQUESTS ONLY)

**EAST OF THE MISSISSIPPI:** 1-800-523-GRRR  
(717) 326-3806

← (For Orders & Catalogs Only) →  
← (For Inquiries & Customer Service) →

**WEST OF THE MISSISSIPPI:** 1-800-541-5537  
(206) 647-0801

88-160A

### The Yield House Butler's Table Kit

Precision-cut, pre-sanded pine parts; all hardware; furniture glue; and illustrated, step-by-step instructions.  
Finished price: \$179.

**Only \$99**



**"I saved \$80 by building this table myself. Don't tell my wife how easy it was!"**

*A Butler's Table under \$100 and solid wood? Couldn't be done, my wife said. So, I pointed out the Yield House kit: over 40% off the finished price and the same high quality, solid pine parts. Directions were easy to follow, and the table went together with simple household tools. I got to finish it just the way I wanted, and now I get to boast about it to all my friends."*

**Yield House™**  
America's leader in furniture kits since 1947.

Call toll-free:  
**1-800-258-4720**

Check  Visa  MC  AMEX

Card # \_\_\_\_\_ Expires \_\_\_\_\_

Name \_\_\_\_\_

Address \_\_\_\_\_

City \_\_\_\_\_

State \_\_\_\_\_ Zip \_\_\_\_\_

\_\_\_\_ Please ship Butler's Table Kit at \$99 + \$7 ship./hand. *Satisfaction guaranteed.*  
\_\_\_\_ Send free 1989 Yield House Catalog.

Mail to: Yield House, Dept. DW93 North Conway, NH 03860

# Go Ahead, Make My Day, Easier!



## HOT MELT GLUE GUNS

Make repairs a snap with the most comfortable and versatile Hot Melt Glue Gun going. The unique design keeps heat flow away from handle so it doesn't get too hot to handle as others do.

Bond almost anything permanently in 60 seconds without the need of mixing or clamping. You can replace bathroom tile, repair leather goods, toys, seal packages, fix furniture, glue picture frames, and it's the ideal tool for arts and craft projects.

**ARROW FASTENER COMPANY, INC.**  
271 Mayhill Street, Saddle Brook, NJ 07662

In Canada: Jardel Distributors, Inc., 6505 Metropolitan Blvd. East, Montreal H1P 1X9 Quebec.

© Copyright 1988 Arrow Fastener Company, Inc.

### INDUSTRIAL QUALITY BAND SAW BLADES

- 72"** 1/8 - \$7.57 3/16, 1/4 - \$7.11 5/16, 3/8 - \$7.31  
**93 1/2"** 1/8 - \$9.04 3/16, 1/4 - \$8.43 5/16, 3/8 - \$8.69
- 1/8 - 9S SCROLL-WOOD     1/8 - 14R WOOD/PLASTIC/METAL  
 1/8 - 14R SCROLL-WOOD/PLASTIC     1/8 - 4PRX RESAWING  
 3/16 - 4S WOOD     3/16 - 10R WOOD/PLASTIC/METAL  
 3/16 - 10R FINE CUT-WOOD/PLASTIC     3/16 - 4PRX RESAWING  
 1/4 - 10R FINE CUT-WOOD/PLASTIC  
 1/4 - (10R, 14R, 18R, 24W) WOOD/PLASTIC/METAL

**ALSO FOR 93 1/2"** 3/4 - \$10.76  
 3/4 - 2PRX RESAWING     3/4 - 6R WOOD/METAL

BAND SAW BLADES WELDED TO ANY LENGTH. FULL LINE IN STOCK -  
 Other widths - teeth and Bi-metal available.

**BUY 5  
GET 6TH  
FREE\***

**CHANDLER BAND SAW, INC.**  
 3498 N. SAN MARCOS PL. - #3  
 CHANDLER, AZ 85224  
 1-800-THE-BLADE  
 AZ 602-892-0120 (No collect calls)

S & H \$2.75. AZ res. add 6 1/2% sales tax. For prompt shipment send money order, cashiers check. Personal checks allow 2-3 weeks. C.O.D. \$2.20 additional (cash, money order, cashiers check).

\* FREE BAND SAW BLADE OF EQUAL OR LESSER VALUE.

## WOOD TOY

- ★ Patterns
- ★ Parts
- ★ Wheels
- ★ Many New Patterns to Choose from.
- ★ Executive toys

SEND \$1.00 FOR NEW CATALOG & RECEIVE COUPON FOR FREE WHEELS & AXLE PEGS.

**toys and joys**

Box 628W Lynden, Wash. 98264



## TIPS FROM YOUR SHOP (AND OURS)

Continued from page 14

### STATIC CLING CURE WINS READER A BISCUIT JOINER

*Powder-fine sawdust that accumulates and sticks to face shields, goggles, and glasses can interfere with a safe, clear view of your work when using power tools. The culprit: static electricity.*



**TIP:** Put the kibosh on static electricity by cleaning your safety eyewear with a

used sheet of fabric softener. Fresh pieces contain a heavier chemical layer and are not as soft as those that have been through the clothes dryer at least once. The soft sheet will remove both dust and static without scratching the lenses. If you don't have any fabric softener sheets, a thin film of Armor All brand automotive vinyl protectant rubbed in with a soft cloth also works well.

You can also use this trick to clean and treat clear plastic shields on power tools. Repeat the treatment as necessary.

—Anita K. Booth,  
Lakewood, Calif.



For her winning tip, Anita receives the Freud model JS-100 biscuit joiner shown above. For information on how you can win a power tool, see contest details on page 14.

Continued on page 18



**"Get your home improvement project off to a great start for only \$1.99"** *Bob Vila*

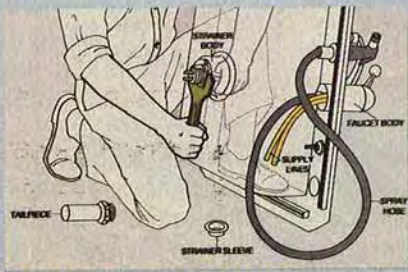

Even Bob Vila doesn't go it alone. He relies on the know-how of specialists to make sure every job is done right. He says, "Why go it alone? It's so easy to get expert advice from HOME REPAIR AND IMPROVE-

month, we'll send you other books, including *New Living Spaces*, *Outdoor Structures* and *Adding On*, all on the same free 15-day examination basis. Each is just \$11.99 plus shipping and handling. Keep only those you want. Cancel anytime with no obligation.

Bob Vila sets himself up to do the job right, and you can too. Your first step: mail in the attached card. HOME REPAIR AND IMPROVEMENT will help you do the rest.



MENT from TIME-LIFE BOOKS. And they'll get you off to a great start for only \$1.99."

Everything is explained in these how-to books, from foundations to skylights, planning to classy finishing touches—always with a craftsman's attention to detail.

You see it all in clear-cut step-by-step diagrams and instructions. Everything from the stale bread trick that takes the sweat out of sweating copper pipe...to setting your circular saw to cut jack rafters at the perfect angle for a new addition on your home.



Your HOME REPAIR AND IMPROVEMENT library will be easy to build, too.

Check out *Kitchens and Bathrooms* for 15 days free with no obligation to buy. Pay only \$1.99 plus shipping and handling! That's a full \$10.00 savings off the regular price! Then, about every other

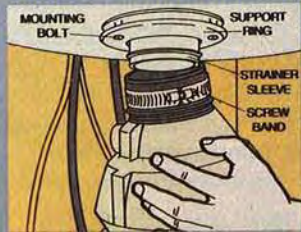

**Try Kitchens and Bathrooms for 15 days free!**

If card is missing, mail to: TIME-LIFE BOOKS, Box C 32066, Richmond, VA 23261-2066.



YES. Please send me *Kitchens and Bathrooms* for 15 days free examination as my introduction to the HOME REPAIR AND IMPROVEMENT series. Also, send me future volumes under the terms described in this ad. CDB3W0

Name \_\_\_\_\_ Apt. \_\_\_\_\_  
Address \_\_\_\_\_

City \_\_\_\_\_ Zip or \_\_\_\_\_  
State or \_\_\_\_\_ Postal Code \_\_\_\_\_  
Province \_\_\_\_\_

All orders subject to approval. Prices subject to change.

**Home Repair and Improvement**  
We help you in a big way.

## DUST COLLECTOR

UFO-102B

- 4 Bags. 2 centrifugal.
- 2 filtering
- 3 hose connections
- 3HP motor



## 12" PORTABLE PLANER

- WP-3012.....\$379.00
- WP-12 ST.....\$39.00
- 2H P 6" Thickness
- 65 lb.



## DOUBLE DRUM SANDER

- SK-15DS 15" width....\$1545.00
- SK-20DS 20" width....\$1875.00
- Excellent Sanding Machine.
- Two different grit.
- Precision contact drum.
- 3 HP sanding motor.
- 1/4 HP auto feeding motor.

# TRUE VALUE

Customer Satisfaction Guaranteed  
One year parts Warranty.



## LOBO POWER TOOLS

10922 Klingerman St. #3, So. El Monte, CA 91733  
(818)350-1096 Canada:(604)299-0911

All Prices FOB. - L.A.

Write or call for Free catalogue

# HIGH QUALITY



## 12" TILTING ARBOR TABLE SAW

- HTS-0012A.....\$795.00
- With cast aluminum guide rail
- 3 HP Motor

## SPINDLE SHAPER

- SP-0034.....\$319.00
- 3/4" and 1/2" spindle
- 1 HP with forward and reverse control



## STROKE BELT SANDER

- SK-1500BS.....\$1095.00
- 60"x21 1/4 sliding table
- 5" sanding belt width. 2 HP motor

# TIPS FROM YOUR SHOP (AND OURS)

Continued from page 16

## SMOOTH REPAIRS ARE A MATTER OF A CLOSE SHAVE

The success of making inconspicuous finish repairs depends on achieving as smooth a surface as possible with a putty stick of the correct color.

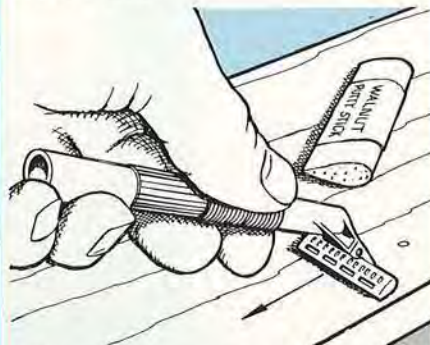

**TIP:** Make sure the touch-up material is about body temperature so it lays on an adequate layer easily. For a really smooth surface, remove the excess putty with a disposable razor or one-sided razor blade as shown above.

—Paul C. Krueger III, Wharton, N.J.

## FAST AND ACCURATE WAY TO FIND CENTER

Locating the center between two points often involves a lot of guesswork or math.

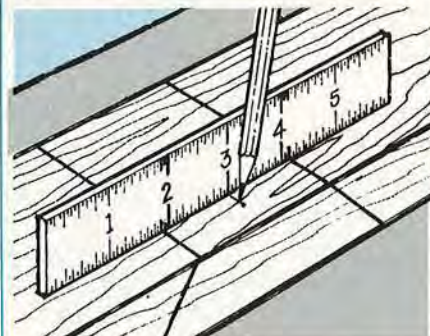

**TIP:** Here's a way to mark a center quickly and accurately. As shown above, just set a rule between the two points so two different inch marks fall equal distances from the two points. The inch mark that falls halfway between the points indicates the center. In this example, we've positioned the 2" and 4" marks 1/2" inside the two points. The center falls at the 3" mark.

From the WOOD® magazine shop

Continued on page 20

# STEVE WALL LUMBER CO.

Quality Hardwoods and Woodworking Machinery For  
The Craftsmen and Educational Institutions



Call for best prices on  
RBI Scroll Saws &  
Planes.

## Special Hawk

- H-14 \$499
- H-16 \$599
- H-20 \$699



CEDAR: (Aromatic Red)	4/4 1C & Btr.	\$ 1.10
CHERRY:	4/4 FAS	2.25
OAK: (Red or White)	4/4 FAS	1.80
MAPLE: (Hard)	4/4 FAS	1.45
MAHOGANY (Genuine)	4/4 Select	2.50
WALNUT	4/4 FAS	2.35

Above Prices are for Kiln Dried Rough Lumber Sold by Bd. Ft. FOB  
Mayodan, NC - Quantity discounts available. For other sizes  
and species send \$1.00 for Lumber & Machinery Catalog.

Route 1  
BOX 287  
MAYODAN  
N.C. 27027  
919-427-0637  
1-800-633-4062

# New Feet-Inch Calculator Solves Woodworking and Home Building Problems—In Seconds!

Amazing Pocket Handyman™ Lets You Work Like a Pro for Only \$39.95!

**N**ow you can solve all your woodworking and do-it-yourself problems right in feet, inches and fractions—with the new Pocket Handyman feet-inch calculator.

This new amazing calculator will save you hours upon hours of time on any project dealing with dimensions.

And best of all, it puts an end to costly errors caused by inaccurate conversions using charts, tables or regular calculators.

## Adds, Subtracts, Multiplies and Divides in Feet, Inches and ANY Fraction

You never need to convert to 10ths or 100ths because the Pocket Handyman works with all dimensions just like you do.

Plus, it lets you work with any fraction— $1/2$ 's,  $1/4$ 's,  $1/8$ 's,  $1/16$ 's,  $1/32$ 's, even down to  $1/64$ 's—or no fraction at all.

You enter a feet-inch-fraction number just as you'd say it—7 [Feet], 6 [Inches], 1 [ $\frac{1}{2}$ ]. What's more, you can mix all fractions ( $3/8 + 11/32 = 23/32$ ) and all formats (Feet + Inches + Yards + Meters) in your problems.

In addition, you can easily figure square and cubic measurements instantly. Simply multiply your dimensions together and the Pocket Handyman does the rest.

## Converts Between All Dimension Formats

You can also convert any displayed measurement directly to or from any of the following formats: Feet-Inch Fraction, Decimal Feet (10ths, 100ths), Inches, Yards and Meters.

It also converts square and cubic.

Plus the Pocket Handyman actually displays the format of your answer right on the large LCD read-out—"Square Feet," "Cubic Yards," etc.

## Comes Complete

The Pocket Handyman also works as a standard math calculator with Memory (which also handles dimensions) and battery-saving Auto Shut-Off.

And the Pocket Handyman is

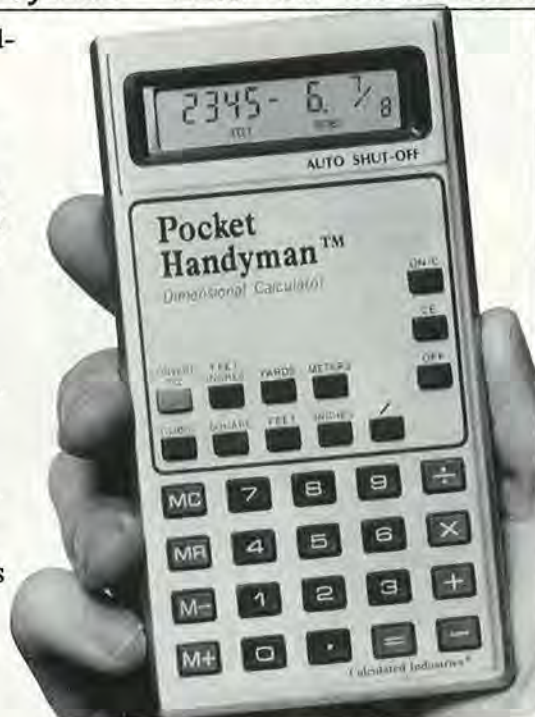

## New Pocket Handyman™ feet-inch calculator solves home improvement problems with the touch of a button.

compact ( $2\text{-}3/4 \times 5\text{-}1/8 \times 1/4$ ") and lightweight (3.5 oz.), so it fits easily in your pocket. You can take it with you anywhere!

What's more, it comes with easy-to-follow User's Guide, full 1-Year Warranty, replaceable 2-Year batteries and vinyl carrying case—an optional custom-fitted leather case is also available.

## Order Risk-Free Today!

To order your Pocket Handyman at the discounted price of just \$39.95,

Use the new Pocket Handyman™ to solve all these problems:

- Dimension Checks
- Furniture Making
- Roofing Projects
- Cement & Concrete (Volume)
- Cabinets & Woodworking
- Estimating All Materials
- Spacing Problems
- Carpeting (Sq. Yards)
- Stairs & Decks
- Wall Paper/Paint (Area)
- Brickwork
- Foundations
- Tile Flooring
- Skylight Installation
- Windows & Other Glass
- And much, much more

or 2 for \$74.95, complete and return the coupon below (to Calculated Industries, 22720 Savi Ranch Parkway, Yorba Linda, CA 92686).

Or better yet call Toll-Free 24 hours every day:

**1-800-854-8075**

And if for any reason you're not completely satisfied with your new Pocket Handyman, simply send it back within 30 days of delivery for a full refund.

So you can't go wrong!

Start saving time and put an end to costly errors, order your Pocket Handyman feet-inch calculator now!

**ONLY \$39.95**

**100% 30-Day Money-Back Guarantee**

If for any reason you are not 100% delighted, return your calculator within 30 days for a full, no-questions-asked refund. Your satisfaction is our #1 concern.

© Calculated Industries, 1989. All rights reserved.

Clip & Mail Today!

Calculated Industries, Inc.  
22720 Savi Ranch Parkway  
Yorba Linda, CA 92686

Toll-Free 24 Hrs. 7 Days  
**1-800-854-8075**

Qty.	Price	Shipping*	Total
1 Pocket Handyman	\$39.95	\$3.95 each calc.	\$
2 Pkt. Handyman. <small>Saved \$7.40</small>	\$74.95	\$5.45 each pair	\$
Leather case	\$10.00	<input type="checkbox"/> Brown <input type="checkbox"/> Burgundy	\$
Gold Initials	\$1.50 per initial		\$
* Add \$1.50 shpg. for ea. additional unit ordered.			In CA add 6% tax \$
			<b>TOTAL \$</b>

Name \_\_\_\_\_

Address \_\_\_\_\_

City/St/Zip \_\_\_\_\_

Check  VISA  MasterCard  Am/Exp

Account # \_\_\_\_\_

Exp Date \_\_\_\_/\_\_\_\_/\_\_\_\_

Sign Here \_\_\_\_\_

BHWM-389

Qty. Discounts  
5+ \$37.50 ea.

Please Note: Leather cases with initials are, of course, not returnable.

# FREE 64 PAGE CATALOG



**LOWEST  
PRICES**

Let us introduce you and your family to the exciting hobby of clockmaking. It's easy - fun - and a great source for extra income. You'll find our service is fast and friendly, so send for your free catalog today!

(Over 17 years the leader)

Name \_\_\_\_\_  
Address \_\_\_\_\_  
City \_\_\_\_\_ State \_\_\_\_\_ Zip \_\_\_\_\_

**KLOCKIT**™ Dept. WD49  
P.O. Box 542, Lake Geneva, WI 53147



## WE AREN'T FINISHED... UNTIL YOU'RE SATISFIED!

Since 1928, WOODCRAFT has been an industry leader in supplying quality products to woodworkers. Our services and guarantee are the best, our quality control program, second to none. Buying from WOODCRAFT gives you that kind of commitment . . . plus a whole lot more.

Why not give us a try, you won't be disappointed!

To receive a free copy of WOODCRAFT's tool catalog, please call toll free **1-800-225-1153** or write:



**WOODCRAFT**

Dept. WBH39  
41 Atlantic Avenue, Box 4000  
Woburn, MA 01888

## TIPS FROM YOUR SHOP (AND OURS)

Continued from page 18

### RIP NARROW STRIPS SAFELY

Ripping short, narrow strips of wood on a tablesaw can be dangerous. Once you complete the cut, the loose strip rattles around between the blade and the rip fence, creating a kickback hazard.

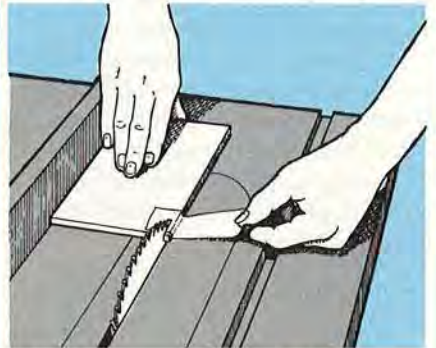

**TIP:** Set up your saw so you can cut the strip on the outside of the blade rather than between the blade and the rip fence. Stabilize the strip by adding a 6-8"-long piece of at least 3/4"-wide masking tape or duct tape so you can snatch the piece away from the blade when you finish the cut. **CAUTION:** Be sure the blade guard is in place when making this kind of cut; we omitted it from the drawing only for the sake of clarity.

If you need several strips the same size, make a pencil mark on the table. Then, align the outside edge of the piece being cut and move the fence for each cut.

—From the WOOD® magazine shop

## ENERGY-SAVING SUN-PORCH™ CONVERTIBLE SUNSPACE

More value for less money!

**INSULATED  
WINTER SUN SPACE CONVERTS  
TO A SUMMER SCREEN ROOM!**

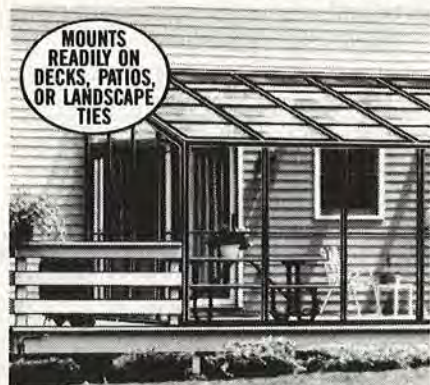

**MOUNTS  
READILY ON  
DECKS, PATIOS,  
OR LANDSCAPE  
TIES**

- Bronze aluminum  Shatter-resistant 1" thick double-wall glazing
- Do-it-yourself assembly
- Ideal greenhouse, spa/hot tub room, entry way.

Send \$2 for Color Catalogues, Prices, SENT FIRST CLASS MAIL.

Dealer Inquiries Welcome



VEGETABLE FACTORY, INC.  
P.O. Box 2235, Dept. WOO  
New York, NY 10163

## MAKE THESE ON YOUR WORKSHOP DRILL PRESS OR RADIAL ARM SAW



Quality Planers  
Since 1956

Model DP-1  
for Drill Press  
**\$35.00**



Model RS-1  
for Radial Saw  
**\$40.00**  
(State Make,  
Model, Shaft Dia.)

(Outside U.S. Pay \$1.00 More)  
OKLA. Pay 7% State Tax  
\$2.50 Shipping & Handling Chg.

Wagner

## SAFE-T-PLANER

. . . Absolutely Safe!  
**IMPOSSIBLE TO GRAB  
OR KICK BACK!**

Planes, Rabbits, & Tenons, makes  
Picture Frames and Rosettes

. . . make picture frames, drawer fronts, panels, tapered legs, rosettes, in hundreds of variations! Planes parallel with micrometer precision producing a satin smooth surface. Units include 3 lifetime hi-speed steel cutters, grinding wheel, arbor, wrench and complete photo instructions. Satisfaction guaranteed or your money back.

—SHOP TESTED BY PROFESSIONALS—  
Order Direct—Write for FREE LITERATURE

**G & W TOOL CO.**  
P.O. BOX 691464—TULSA, OK 74169  
918-486-2761

### MORE HELPFUL TIPS

You'll find other useful shop tips scattered throughout this issue of WOOD® magazine:

- A surefire mixture for home-made wood putty, page 42
- How to make an oil finish shine, page 66.
- The trick to making rounded corner moldings, page 67.
- A tip on staining end grain without darkening, page 72.
- Keep your sanding belts in like-new condition with these suggestions, page 76. ♣

# Your workshop can PAY OFF ...BIG!

SAVE ... convert low  
cost rough lumber  
for use in your  
home projects

OR

EARN EXTRA  
INCOME by supplying  
custom Planed Lumber,  
trim, and molding to  
lumberyards ...  
contractors ...  
cabinetmakers ... home  
hobbyists and others ...



## FOUR BIG ADVANTAGES ...



PLANE



MOLD



SAW



SAND

### *You can plane, mold, saw & sand All with Automatic Power Feed!*

From the Day It Arrives ... the Planer will make and save you money. With shortages and inflation driving lumber prices sky-high, this versatile power feed tool quickly pays for itself by easily converting low cost rough lumber into high value finished stock. In just one pass turn out your own quarter round, door and window stop, casing, tongue-and-groove ... all popular patterns. Other operators are making cases for grandfather clocks, furniture, picture frames, bee hives, bed slats, surveying stakes ... all kinds of millwork.

**Built For Pros ... Priced For Home Craftsmen ...** it is engineered and built to industrial standards, but factory-direct selling keeps the price low. Handles tough oak and walnut as easily as pine, and so simple to operate even beginners with no experience can use it. **Start Your Own Business ...** with just this one low cost power feed machine in a corner of your garage or basement, you're set up to supply lumberyards, cabinetmakers, carpenters, remodelers, contractors and hobbyists in your area with custom-planed lumber, trim, molding ... All of their millwork requirements. You can supply picture frame moldings to art shops, hardware and department stores, or sell direct to framing shops. All standard patterns are available from stock, or we'll custom grind a knife to your own special design or sample.

**FREE  
BOOKLET!**

Get **FREE  
BOOK** with  
facts and  
full details  
... *RUSH COUPON TODAY!*



Just Mail Coupon ...  
**30-DAY FREE  
TRIAL OFFER!!!**  
**ACT NOW!**  
**Coupon  
Brings  
Full Details!**

**SAVE!!! FACTORY PRICES DIRECT TO YOU!**



**FOLEY-BELSAW CO.**  
6301 EQUITABLE RD., DEPT. 91429  
KANSAS CITY, MO. 64120  
*Established in 1926*

YES, please send me the FREE Booklet that gives me complete facts about your Planer-Molder-Sander-Saw and full details on how I can qualify for a 30-Day FREE Trial right in my own shop. I understand there is No Obligation and that No Salesman will call.

Name \_\_\_\_\_  
Address \_\_\_\_\_  
City \_\_\_\_\_ State \_\_\_\_\_ Zip \_\_\_\_\_



**It Works!**

**Cascade Precision Tool Co.**  
 Box 848, Mercer Island, WA 98040  
 Call Toll-Free: 1-800-235-0272

**Unique Right Arm Clamp replaces a whole set of special clamps and vises**

Dear Woodworker: Cascade is continually on the lookout to find the absolutely best value in tools to complement our SY brand router bits and shaper cutters. We believe we have found a real gem in "The Right Arm Clamp." This new clamp does it all! Its secret is its pivoting arm, which, when positioned, squares the work for perfect joining, gluing, and fastening.

Lifetime manufacturer's warranty. Instructions included. Suggested retail - \$179<sup>95</sup>

**Cascade price - \$10<sup>00</sup> - or 6 for \$55<sup>00</sup>**

Write or call for our **NEW 1989 Catalog!!** Great **SALE** prices!! Exciting new profiles!! Super selection of top-quality carbide-tipped router bits and shaper cutters at terrific factory-to-you prices like:

**CARBIDE TIPPED SHAPER CUTTER PANEL RAISER -**  
 3 WING, 5 PROFILES, 3MM THICK CARBIDE  
 • 4-5/8" O.D. with 3/4" BORE (1/2" BUSHING)  
 • 5-1/2" O.D. with 1-1/4" BORE (1" BUSHING)

**\$699<sup>95</sup>**

**5° FACE CUT**   **15° FACE CUT**   **CONCAVE**   **12° FACE & QTR RD**   **CONVEX**

**6 PC CARBIDE TIPPED CABINET SETS**  
 • 3 mm CARBIDE  
 • 3/4" BORE W/1/2" BUSHING  
**ONLY \$179.95**

13 Great Cabinet Sets including these popular Profiles:

SY 1280   SY 1283

**(1-1/4" Bore with 1" Bushing - ONLY \$249.95)**

SY 1281   SY 1284

**1/2" SHANK CARBIDE TIPPED CABINET DOOR SET**  
 • Big 3-1/2" O.D. PANEL RAISER   3 pc. set  
**\$179<sup>95</sup>**   **Now \$149**

• RAIL/STILE CUTTER  
 • RAIL END CUTTER  
 • PANEL RAISER ALONE  
**\$59<sup>95</sup>**   **Now \$50**

**BEX AIR STAPLER OR NAILER** with 5,000 staples or nails **\$99.95**

**SOLID CARBIDE SPIRAL BITS** **\$15.00** each

**FOR THE SHAPER**  
 3mm thick C-2 carbide, 3/4" Bore w/1/2" Bushing  
**Straight**



SY-1212-1	SY-1212-4
1/4" \$24.95	3/4" \$32.95
SY-1212-2	SY-1212-5
3/8" \$26.95	1" \$35.95
SY-1212-3	SY-1212-6
1/2" \$28.95	1-1/2" \$36.95
	SY-1212-8
	2" \$59.95

**Flute**



SY-1223-1	SY-1223-4
1/4" \$24.95	3/4" \$32.95
SY-1223-2	SY-1223-5
3/8" \$26.95	1" \$35.95
SY-1223-3	
1/2" \$28.95	

**Bead**



SY-1224-1	SY-1224-4
1/4" \$24.95	3/4" \$32.95
SY-1224-2	SY-1224-5
3/8" \$26.95	1" \$35.95
SY-1224-3	
1/2" \$28.95	

**FOR THE ROUTER!**  
**Dovetail**

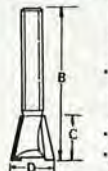

PART NO.	D	PRICE
802	3/8	\$7
804	1/2	\$7
* 804-1/2	1/2	\$7
806	9/16	\$8
810	3/4	\$9
* 810-1/2	3/4	\$9
* 812-1/2	1	\$12

**Flush Trimming**

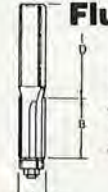

PART NO.	A	PRICE
S8012Y	3/8	\$7
S8016Y	1/2	\$8
* S8016Y 1/2	1/2	\$8
S8020	5/8	\$10
* S8020 1/2	5/8	\$10

**Cove Bits**

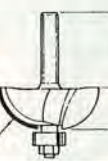

PART NO.	A	PRICE
S702Y	1/16	\$12
S704Y	1/8	\$12
S706Y	3/16	\$12
S708Y	1/4	\$13
S710Y	5/16	\$13
S712Y	3/8	\$13
S716Y	1/2	\$14
* S716Y-1/2	1/2	\$14
* S724Y-1/2	3/4	\$28

**Corner Round**



SY-1225-1	SY-1225-4
1/4" R \$24.95	3/4" R \$35.95
SY-1225-2	SY-1225-5
3/8" R \$26.95	1" R \$49.95
SY-1225-3	SY-1225-6
1/2" R \$28.95	1 1/4" R \$49.95

**NOW A Choice of Edge Beading Bits**

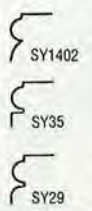

**\$16 each**

**NEW Concept in Router Bit Cabinet Door Construction!!**

The SY brand 3" Panel Raiser with undercutter in 5 profiles automatically provides a 1/4" tongue, and your panels and rail & stile are at the same height. Complete with bearing for template and freehand cutting.



**\$599<sup>95</sup>**

2-5/8" O.D. Panel Raisers in the 5 profiles above - **\$299<sup>95</sup> each.**

**Roundover**

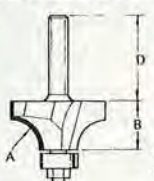

PART NO.	A	PRICE
S502Y	1/16R	\$11
S504Y	1/8R	\$11
S506Y	3/16R	\$11
S508Y	1/4R	\$11
S510Y	5/16R	\$12
S512Y	3/8R	\$15
S516Y	1/2R	\$16
* S516Y-1/2	1/2R	\$16
* S520Y-1/2	5/8R	\$20
* S524Y-1/2	3/4R	\$20
* S528Y-1/2	7/8R	\$34
* S532Y-1/2	1R	\$34
* S536Y-1/2	1-1/4R	\$40

**Core Box**



PART NO.	A	PRICE
S408	1/4	\$10
S412	3/8	\$10
S416	1/2	\$12
S420	5/8	\$14
S424	3/4	\$15
* S424-1/2	3/4	\$15
* S432-1/2	1	\$18
* S450-1/2	1-1/2	\$30

**Beading**

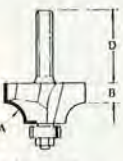

PART NO.	A	PRICE
S602Y	1/16R	\$11
S604Y	1/8R	\$11
S606Y	3/16R	\$11
S608Y	1/4R	\$12
S610Y	5/16R	\$13
S612Y	3/8R	\$15
S616Y	1/2R	\$16
* S616Y-1/2	1/2R	\$16
* S624-1/2	3/4R	\$20

\* Indicates 1/2" shank.

**Bull Nose**

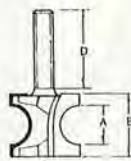

PART NO.	A	PRICE
SY9-1	1/4	\$14
* SY9-1 1/2	1/4	\$14
SY9-3	3/8	\$15
* SY9-3 1/2	3/8	\$15
SY9-4	1/2	\$15
* SY9-4 1/2	1/2	\$15
SY9-5	5/8	\$16
* SY9-5 1/2	5/8	\$16
SY9-6	3/4	\$16
* SY9-6 1/2	3/4	\$16
* SY9-8 1/2	1	\$18
* SY9-9 1/2	1-1/8	\$30
* SY9-10 1/2	1-1/4	\$35
* SY9-11 1/2	1-3/8	\$38
* SY9-12 1/2	1-1/2	\$40

**Roman Ogee**

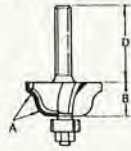

PART NO.	A	PRICE
S5705Y	5/32	\$16
* S5705Y 1/2	5/32 (4mm)	\$16
S5708Y	1/4	\$17
* S5708Y 1/2	1/4	\$17

**Slot Cutter - 4 Flutes**

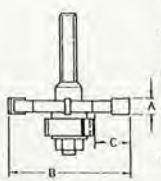

PART NO.	A	PRICE
SY7002	1/8	\$20
* SY7002 1/2	1/8	\$20
SY7004	5/32 (4mm)	\$22
* SY7004 1/2	5/32 (4mm)	\$22
SY7006	3/16	\$22
* SY7006 1/2	3/16	\$22
SY7008	1/4	\$24
* SY7008 1/2	1/4	\$24

**Only \$495**

**Frt. Incl.**

**CAS-15 WOODSHAPER**

- 1 1/2" HP, 2 speed, Reversible
- 3/4" and 1/2" spindles
- 1.2" vertical spindle travel • Holddown clamps
- Individual fence assembly adjustment
- 1/2" and 3/4" router collets
- Mitre dovetailed into table

**MC/VISA/COD USERS ORDER TOLL FREE**  
 1-800-235-0272  
**IN WASHINGTON STATE CALL 1-236-0272**  
 7AM - 7 PM Monday through Friday (P.T.)





# SAPELE

FIGURE THAT  
MADE A REBOUND

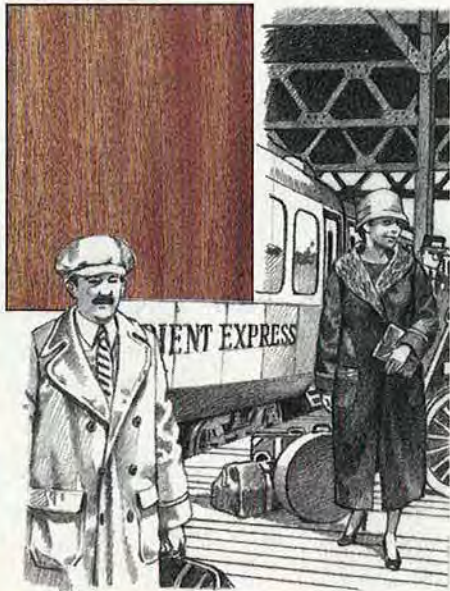

Rare is the sapele (sap-EE-lee) log without figure. In fact, mahogany's light-brown cousin from West Africa offers perhaps the greatest variety of any species—quilted, mottled, rope, ribbon-stripe, and more. Yet, the same irregularity of grain that produces sapele's incredible array once made it highly unpopular with craftsmen.

Believe it or not, woodworkers shunned sapele lumber when it was first imported to the U.S. in the early thirties. But, for a very logical reason. It seems that sapele has a terrible tendency to warp unless quarter-sawed.

Quarter-sawing, however, would have increased production time and raised the price for a wood that already was unwanted. Faced with the dilemma, some enterprising lumbermen experimented, and discovered that the large, straight trunks of sapele make perfect candidates for slicing or peeling into

thin sheets. And, like the kiss that turned a frog into a prince, veneering transformed sapele into an exquisitely beautiful wood.

As veneer, the wood no one wanted became famous, and demand grew. The Columbia Broadcasting Company (CBS) covered the corridor walls of its Los Angeles studios with it in 1938. WNYC Radio in New York followed suit, and paneled 1,700 square feet of audience and reception rooms. But, the lustrous, many figured wood had already achieved its highest honor. As the opulent decor in the private compartments of Europe's famed Orient Express, sapele was the crowning touch of elegance in rail travel during the decades that spanned two world wars. Today, stunningly restored, sapele-clad cars ride the rails between Boulogne and Venice or Vienna. 🌲

Illustration: Jim Stevenson  
Photograph: Bob Calmer



IMPORTS, INC.

## THE OBVIOUS CHOICE!!

G1026



### 3 H.P. Shaper

2 spindle speeds, precision ground table, magnetic switch and weighs a husky 500 lbs. Comes with 3 spindles - 1", 3/4" and 1/2".

Regularly \$850.

**SALE PRICE \$825**

G1182

Weights  
260 lbs.!



### 6 x 47" Jointer

All ball bearing, 3-blade cutterhead, 1 HP single phase motor, precision ground beds with an exclusive 47" bed length. This is the nicest 6" Jointer on the market.

Regularly \$335

**SALE PRICE \$310**

G1018

Weights  
500 lbs.!



### 8 x 65" Jointer

Another winner! All ball bearing, 3-blade cutterhead, magnetic switch 1 1/2 HP single phase motor and precision ground cast-iron beds.

Regularly \$665

**SALE PRICE \$625**

G1033



### 20" Planer

20" x 8" capacity, 2 automatic feed rates, 3 HP single phase motor, 4-blade all ball-bearing cutterhead, built in stand, extension rollers and dust chute. Weighs 950 lbs.

Regularly \$1295

**SALE PRICE \$1175**

All above prices are F.O.B. Williamsport, PA or Bellingham, WA

## NEW TOLL FREE LINES

(FOR ORDERS AND CATALOG REQUESTS ONLY)

EAST OF THE MISSISSIPPI: 1-800-523-GRRR (717) 326-3806

← (For Orders & Catalogs Only) →  
← (For Inquiries & Customer Service) →

WEST OF THE MISSISSIPPI: 1-800-541-5537 (206) 647-0801

# RAW TALENT.



# RAW POWER.



No matter how much ability is at hand, something's missing without the right tool.

Today, many professionals are finding that something in Skil's aggressive 4580 Jigsaw.

Its vari-orbit action adjusts in 6 positions to zip through a wide range of materials. Saw strokes can also be matched to the job with a variable speed trigger control.

Plus there's a vibration dampened drive train. Durable ball and roller bearing construction. And a fan that clears the line of sight.

As for price, no professional jigsaw cuts a better deal. And that's the raw

**SKIL**<sup>®</sup>

  
EMERSON • Skil Corporation,  
Subsidiary of Emerson Electric Co.,  
4300 W. Peterson Avenue,  
Chicago, IL 60646. © 1989 Skil Corp.

**D**iarists claim that early loggers in what came to be Oregon and Washington often felled 400'-tall trees, each containing enough high-grade lumber to build seven houses! The lofty tree was the Douglas fir, and it still dominates the great forests of the Pacific Northwest.

In 1827, English botanical explorer David Douglas recognized the fir's resource potential. Hoping that the easily grown tree could adapt to his country's reforestation efforts, he shipped seed cones from the Columbia River basin back to the British Isles.

From that introduction, the fir found favor as fast-growing timber first in England, then throughout western Europe. Now, even the adopted habitats of Australia, New Zealand, and South Africa boast Douglas fir forests.

### Wood identification

In the U.S., Douglas fir (*Pseudotsuga menziesii*) naturally ranges from the Mexican border north to Alaska, and from the Pacific coast east to the Rocky Mountains. Often found in pure stands, Douglas fir can attain an average mature height of about 300' and diameters from 10' to 17'.

On older trees, the rough bark may be 12" thick. Younger trees have a smooth bark with frequent blisters filled with a pungent resin.

Tiny winged seeds, released from cones as large as a man's fist, quickly germinate in sufficient sunlight.

# DOUGLAS FIR

## The globe-trotting he-man of American softwoods



Plain-sawn Douglas fir



Vertical-grain Douglas fir



Rotary cut Douglas fir veneer

Because of this, Douglas fir quickly takes over and reforests burned or clearcut areas.

Douglas fir's pinkish-yellow to orange-red heartwood provides a distinct contrast in the growth rings. On flatsawed boards and rotary cut veneer, this translates to an abrupt color change. The thin

band of sapwood is often nearly pure white.

### Working properties

In comparison to its weight, Douglas fir ranks as the strongest of all American woods. It is also stiff, stable, and relatively decay resistant.

Douglas fir's coarse texture can't easily be worked with hand tools.

And to avoid tearing grain, even power tool blades must be sharp. Yet, the wood grips nails and screws securely, and readily accepts all types of adhesives.

Because Douglas fir contains fewer resins than many other softwoods, count on success with paint and clear finishes. Staining, however, becomes a problem due to the light-to-dark variation between growth rings that causes uneven coloration.

### Uses in woodworking

Vast quantities of Douglas fir provide dimension lumber for the construction industry and veneers for plywood. The wood's appearance and easy-working properties have earned it a spot in the manufacturing of windows, doors, and moldings.

Flatsawed, Douglas fir makes attractive, serviceable cabinets and paintable furniture. Sawn as vertical grain, Douglas fir performs well as flooring and looks stunning as cabinetry.

### Cost and availability

Found across most of the nation as common construction lumber, Douglas fir falls in the inexpensive price range of about \$1 per lineal foot. However, sawed for vertical grain and graded for "superior finish," the cost rises by at least three times. Douglas fir plywood in all grades is readily available. 🌲

Illustration: Steve Schindler  
Photographs: Western Wood Products Assn.

YOU'LL PILE UP COMPLIMENTS WHEN YOU TRY THESE

# STACK-LAMINATED



Borrowing a reader's technique for making stack-laminated bowls, we've turned some of the best-looking bowls to come out of the *WOOD*® magazine shop. With our step-by-step instructions, you can do the same—even if you're a newcomer to woodturning. Then, sit back and watch your friends marvel at your latest accomplishment.



Bill Lovelace

We've been dying to do this article ever since we met woodworker and retired pilot Bill Lovelace in Phoenix three years ago. At the time, we were so amazed by the looking-glass finish on his stack-laminated bowls that we published a finishing-technique arti-

cle on page 52 in the December 1986 issue of *WOOD* magazine. Our readers also were impressed, because shortly after that story appeared, Bill had requests from across the country wanting to know more about his bowls. Soon, he was teaching classes to these fellow readers. It's no wonder. At \$250-450

# BOWLS



We thoroughly test and refine every technique in WOOD® magazine before presenting it to you.

## PLANNING: LIKE MAKING CUTTING BOARDS

If you've ever assembled a cutting board of your own design, you've already made many of the same types of decisions that go into planning a stack-laminated bowl. First of all, determine the size (diameter and height) of your bowl by considering its use (decorative or functional) and placement in your home. Bill Lovelace turns only 12" diameter bowls because "people love big bowls—they sell great."

Just as you have a lot of flexibility in the size of a bowl or cutting board, you also can choose any profile or laminate design for your bowl. To give you an idea of the possibilities, Design Editor Jim Downing drew up a few options shown *below*.

Once you've decided on the bowl's look, it's time to determine the thickness of the bowl's profile.

First, draw a side profile (see three examples on the next page). Then, measure the thickness of the profile and refer to the chart on the next page to determine the width of the bowl blank segments. As shown in the top view of bowl blank layers on the next page, every layer above the bottom layer consists of two long segments of equal size and two equally sized short segments. The length of the long segments equals the diameter of your bowl. When you place the short segments between the long segments, the short segments should be long enough to form a square layer.

## CUT, CLAMP, AND STACK: MAKING SIMPLE LAYERS

Simple layers, such as the bottom three and top two tiers in the photo *opposite*, have one wood species, with edge-to-end joints, and only five segments for the bottom layer

and four segments for the other laminates. Feature layers, such as the one shown third from the top in the photo *opposite*, may consist of several types of wood, with face-to-face, face-to-edge, edge-to-end, and edge-to-edge joints, and an unlimited number of wood pieces in several species. We'll talk about feature layers later.

Before cutting any stock, use a square to set your tablesaw blade to exactly 90°. This step, more than any other, will lead to the tight joints that distinguish a great bowl from a so-so effort. Also, to ensure tight joints between layers, plane all the stock for each layer to the same thickness before making any cuts. Don't be in a rush as you cut the parts—your patience will lead to segments with flat, perpendicular surfaces and crisp corners—key ingredients for tight joints.

*Continued*

apiece, he sells every masterpiece he makes. As Bill says, "They're winners." And, we can't argue with that.

To let all of you in on Bill's secrets, we made another pilgrimage to his shop late last year. Then, we spent several days in our own shop, learning how to assemble and turn these exquisite bowls, and adding a few techniques of our own.

Not surprisingly, the process begins with planning the appearance of your bowl. Then, you build all the necessary layers and laminate them into a square blank. After you bandsaw the blank to a nearly round form, you mount it to your lathe and proceed to turn one gem of a bowl, complete with shiny facets of various-colored woods.

Just keep this bit of advice in mind: When your lathe screams "uncle" because you're turning so many of these bowls, give it a short break while you assemble another one.

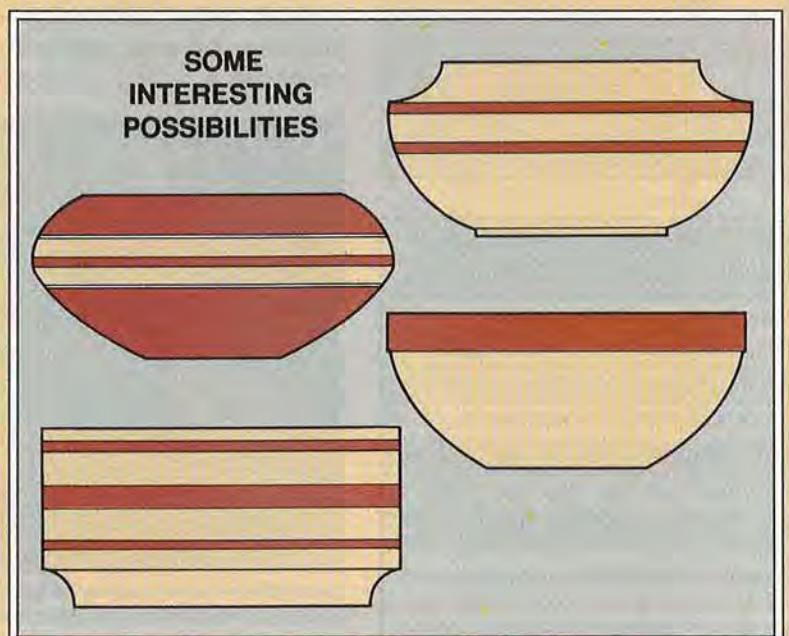

# STACK-LAMINATED BOWLS

## PROFILE THICKNESS

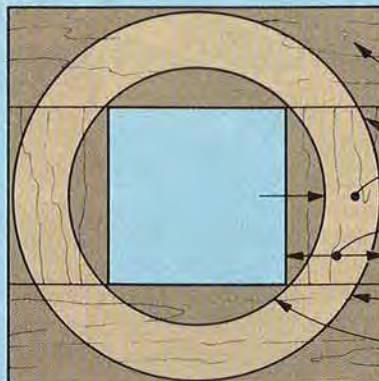
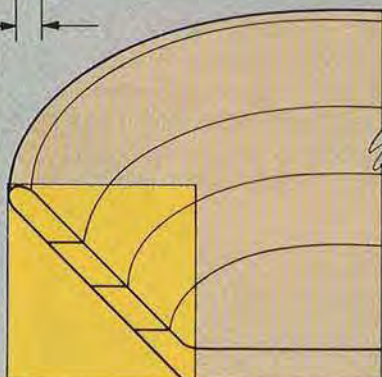
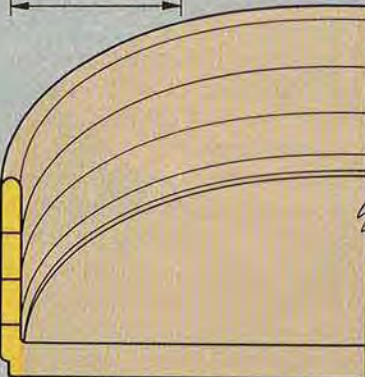
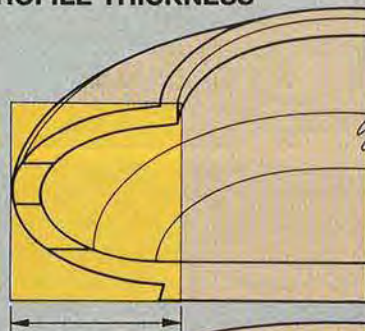

## TOP VIEW OF BOWL BLANK LAYER

- Long segment
- Short segment
- Maximum profile thickness
- Width of bowl blank segment
- Outside diameter of bowl
- Inside diameter of bowl

## A HANDY DEVICE FOR QUICK CLAMPING

To take some of the hassle out of clamping, we suggest you build the platform shown at *right* from polyester or melamine-coated particleboard. This "lily pad," or "toadstool" as it came to be known around our shop, provides an elevated surface that dried glue and laminated segments easily separate from without waxed paper. For all the gluing operations, you can make perfectly flat

layers by clamping segments between the toadstool and another piece of coated particleboard. A 4×8' sheet of this material costs about \$30 at lumberyards. If you want to avoid this expense, clamp your layers between waxed paper and particleboard. We suggest you make at least one platform; and if you want to work fast, you'll use as many as three at once.

## LET'S BUILD THE BOWL

With the steps on the previous page done, it's time to get to the fun part—assembling your bowl. Starting at the bottom and working up, use yellow woodworker's glue to join the three bottom segments as shown in photo A.

Now, clamp them together as shown in Clamping Setup 1 on the next page. No matter how straight you try to line up these pieces, they won't set flush enough to form a tight joint to adjacent long segments as shown in photo B. To solve this

## DETERMINING WIDTH OF BOWL-BLANK SEGMENTS

Bowl Diam.	Profile thickness						
	¼"	⅝"	1"	1½"	2"	2½"	3"
4"	1"	1¼"	1½"	1¾"			
6"	1¼"	1½"	1¾"	2¼"	2½"	2¾"	
8"	1½"	1¾"	2¼"	2½"	2¾"	3¼"	3½"
10"	1¾"	2¼"	2½"	2¾"	3¼"	3½"	4"
12"	2¼"	2½"	2¾"	3¼"	3½"	4"	4½"

To determine the width of your bowl-blank segments, find the figure in the chart that corresponds to the diameter and profile thickness of your bowl design.

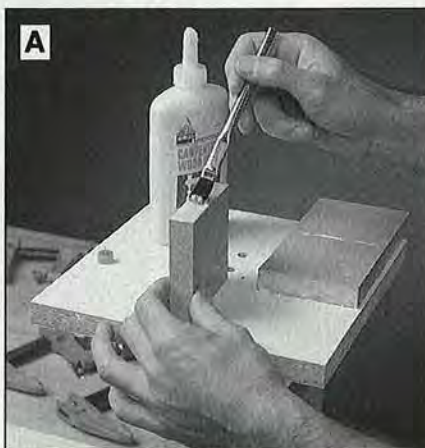

Spread liberal amounts of glue on both surfaces wherever you join two pieces. Here, we're gluing the middle segment of the bowl's bottom.



Since it's nearly impossible to glue the middle segment of the bowl's bottom perfectly straight...

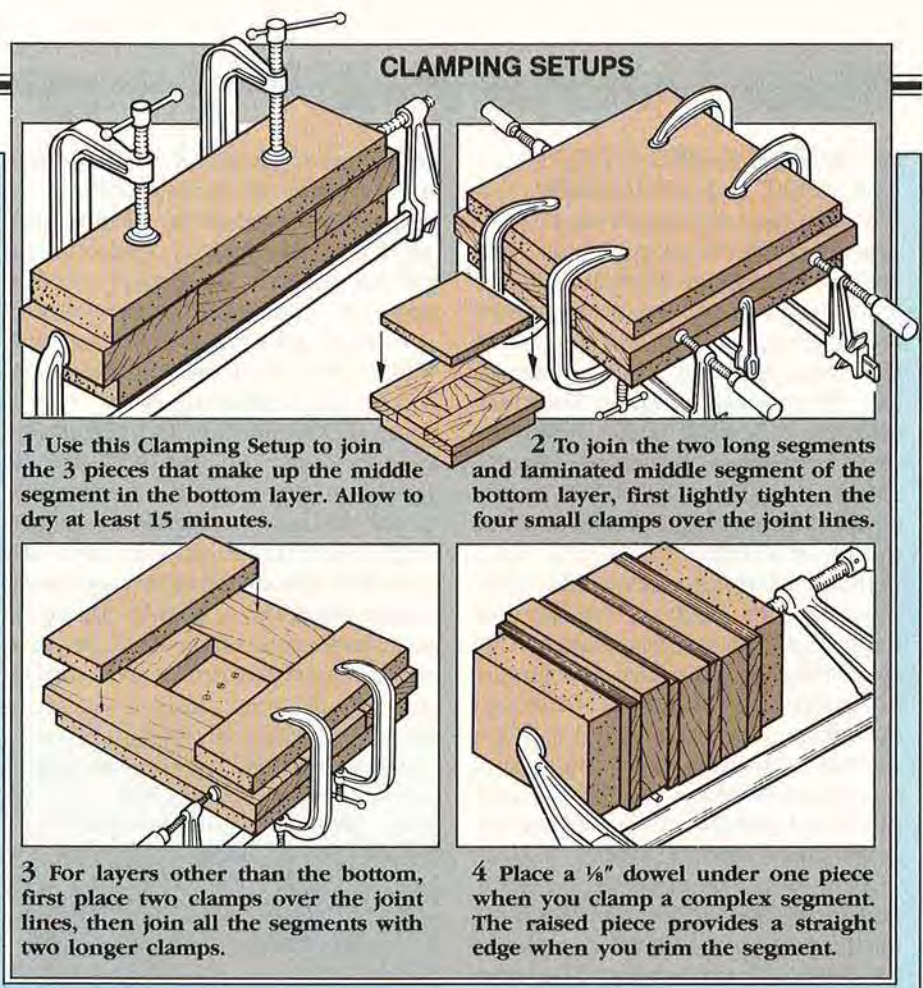
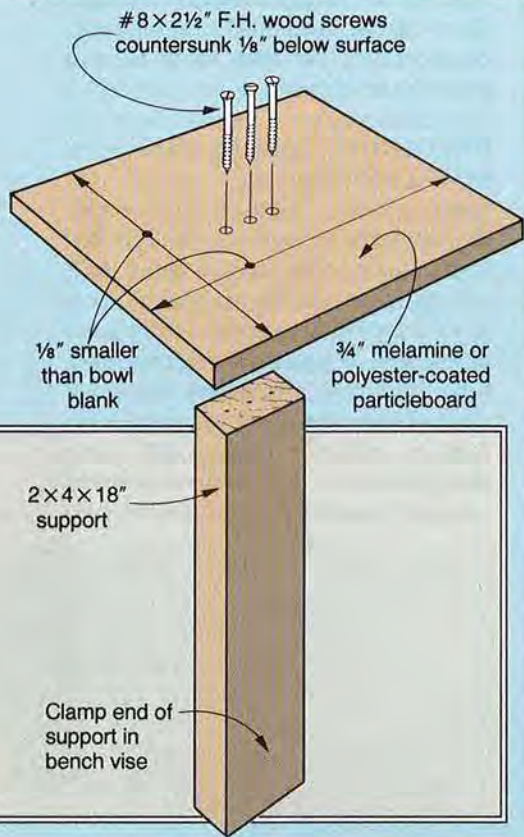

problem, pass one side through your tablesaw as shown in photo C, taking off just enough to straighten that side (usually not more than 1/8"). Now, flip the segment over and do the same for the other side.

Once you've squared-up this piece, glue and clamp it to two longer segments to form the bowl bottom as shown in Clamping Setup 2 above. After this layer dries, use a finishing sander with 60-grit paper as shown in photo

D to smooth out the surface. Remove a minimum of stock and don't gouge the wood. Now, assemble the remaining layers as shown in Clamping Setup 3 above. Sand these layers smooth just as you did the bottom.



... take off a minimum amount of stock on both sides with your tablesaw to square the segment.



To hold the layers in place while you sand them, lay them on a sheet of sandpaper attached to your bench with double-faced tape.

After these layers dry, round-out their center hole for ease of turning later. To do this, make a scrap block just big enough to fit in the hole. With the scrap block in the hole, find its center by drawing two lines connecting opposite corners of the layer—their intersection marks the center. Use a compass as shown in photo E to draw a circular center. Remove the scrap block and cut along this line with either a scrollsaw or jigsaw.

If you're not interested in making a bowl with a feature layer, jump ahead to the section **Preparing the Blank For Turning** on the following page.

*Continued*

# STACK-LAMINATED BOWLS

## FEATURE LAYERS: NOT ALL THAT COMPLICATED

You can try almost anything design-wise when making feature layers, just remember these guidelines:

- Although made of many more pieces, feature layers still consist of two long and two short segments, just like the other layers. The only difference: Several pieces make up these assemblies. The four segments should match the width and length of the long and short segments of the other layers.

- If one of the segments has horizontal pieces, such as the one in our sample feature layer shown at *right*, the thickness of that segment determines the thickness of the layer. For example, the bowl on page 26 has a feature layer with two pieces of  $\frac{3}{4}$ "-thick stock and one piece of  $\frac{1}{4}$ "-thick stock, making for a  $1\frac{3}{4}$ "-thick feature layer.

After you determine the width and length of the four segments in the feature layer, cut all the pieces for them  $\frac{1}{2}$ " too long and  $\frac{1}{2}$ " too wide. This extra stock allows you to square the pieces later by trimming them to finished size. To clamp these segments, follow Clamping Setup 4 on page 29. Note that we placed a  $\frac{1}{8}$ " dowel under one piece so it can serve later as a ripping guide.

For our example, we cut the segments made of vertical pieces to the right thickness by setting our rip fence as shown in photo F. To do this yourself, snugly squeeze the segment composed of horizontal pieces between the blade and fence. Lock the fence there and remove the segment. Now, cut a scrap piece and check your accuracy by comparing the thickness of the scrap stock and the horizontal-piece segment on a flat surface such as the table of your saw. Repeat this process until the thickness of the pieces matches. In photo G, we show you how to safely saw short segments to match the thick-

ness of the long segment. Finally, glue, clamp, sand, and cut out a circular center for this layer as you did for the others.

## PREPARING THE BLANK FOR TURNING

Once you've finished the layers, dry-stack them together in their finished order. For appearance and strength, stack them just as you would lay bricks, with as little joint alignment as possible. For example, note how we alternated the position of the layers in the photo on page 26. After you're satisfied with the alignment, dry-clamp the layers and drill holes for guidepins in two

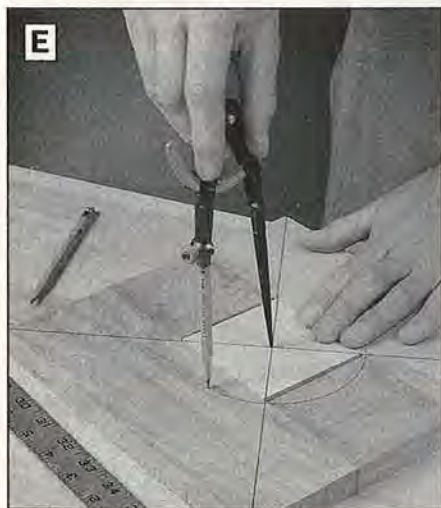
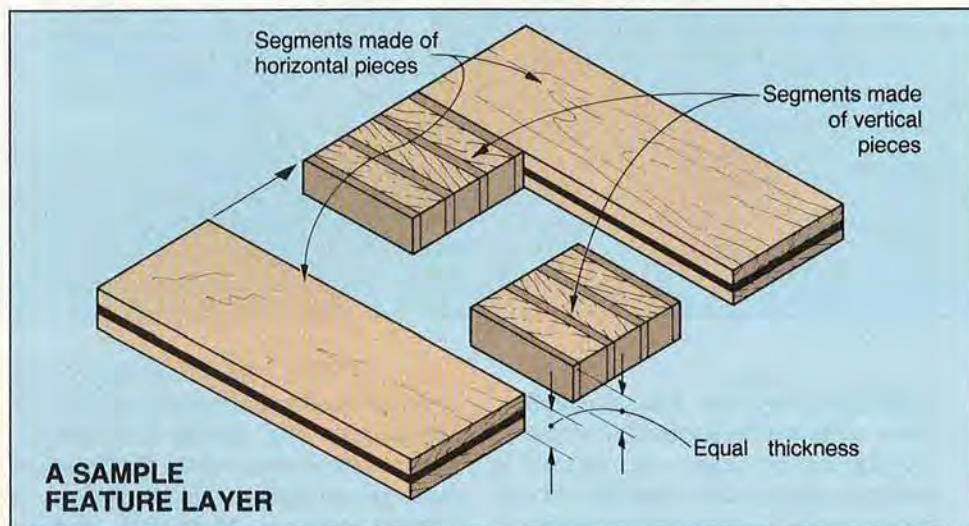

Use a scrap block and compass to draw the circular cutaway hole in the center of each layer. This makes for easier turning later.



With the power OFF, set the rip fence to the height of one segment, test the setting with a scrap piece, and then ...

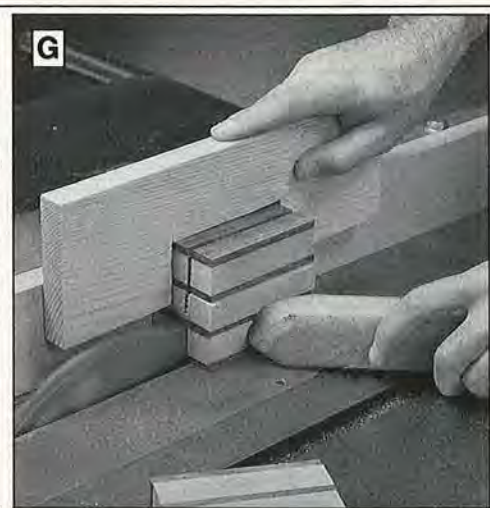

... pass the other segments through the blade. We're using a pushstick and abrasive belt cleaner to safely hold the segment.



opposite corners. You want the pins (nails or waxed dowels) to fit snugly. Then, draw a line down the height of any side of the stack as a reference mark for reassembling the layers during gluing.

Next, unclamp the stack and place the guidepins in the bottom layer. Working fast, apply glue to both sides of the joining layers and stack them one-by-one on top of another as shown in photo H. If you don't feel you can assemble the blank in 15 minutes, switch to a slower-drying white woodworker's glue. When you're finished gluing, put a sheet of coated particleboard over the stack and clamp it together, spacing the clamps 2" apart around the blank. For a solid lamination that won't come apart on the lathe or separate at the joint lines after finishing, allow this assembly to dry overnight (at least eight hours).

Next, determine the center of the bottom of the blank with two intersecting lines just as you did for each layer. With a compass centered on the bottom, draw a circle as large as possible without going off the side of the blank. Finally, follow this line with your bandsaw to make the blank round.

To get your bowl mounted on the lathe, we recommend using a

hardwood or Baltic birch auxiliary faceplate at least one-half the diameter of your bowl blank. To apply the auxiliary faceplate, draw a centered circle on the bottom of the bowl that's the diameter of your auxiliary faceplate and apply as shown in photo I.

### HOW THE STACKED BOWL TURNS

By now, you've probably invested 15-30 hours in constructing your bowl, so you don't want to botch the turning job. Because of the likelihood of chip-out along the joint lines, and the many directions that the grain runs, turning these bowls poses special problems. As Design Editor Jim Downing puts it, "Cutting against the grain is like petting your dog from his tail to his head—in the same way, your turning tools will ruffle the grain just as your hand ruffles his hair." Here's how to avoid these problems or handle them as they occur:

- First, start with a sharp set of tools and keep them sharp as you go. Now, set your lathe for 500-600 rpm, and rough the outside of the bowl round with a bullnose scraper. Next, do the same for the inside.

- Increase the lathe speed to 900-1,000 rpm, and use the bullnose

scraper to shape the outside profile. With the same scraper, slowly and carefully scrape the inside profile, keeping the wall 1/2" thick (you'll sand away 1/4" later, finishing with a 1/4"-thick bowl). If you try to remove too much wood quickly on the inside, your tool will catch on the stock, gouging your bowl.

- Now, use a skew scraper to smooth the outside walls and inside base of the bowl. Smooth the inside with a bullnose or roundnose scraper—we found that 1/2" tools catch less frequently than larger scrapers. Again, go slowly on both the outside and inside to minimize grain tear-out, and you'll save yourself some sanding later.

- To speed up sanding, use a power drill and a 50-grit sanding disc to power-sand the inside bottom and outside walls of the bowl while it's turning at 900-1,000 rpm as shown in photo J. Unless you have an angle drill, you'll have to sand the inside walls by hand. After you've removed all the tear-out, sand the bowl through a succession of grits. Finish the bowl with sanding sealer and polyurethane or lacquer while it's on the lathe. ♣

Written by Bill Krier  
with James R. Downing  
Photographs: Hopkins Associates  
Illustrations: Mike Henry



We used waxed 1/4" dowels as guidepins and lowered the successive layers on them as we glued. We sanded the ends of the dowels to round them off.

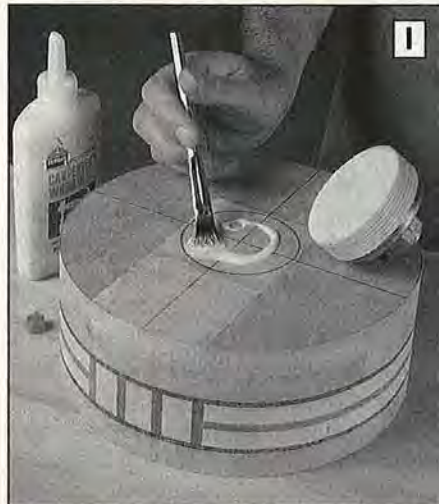

Apply glue to both the auxiliary faceplate and bowl-blank bottom. You also can use 5-minute epoxy to speed this process and spare the clamping.

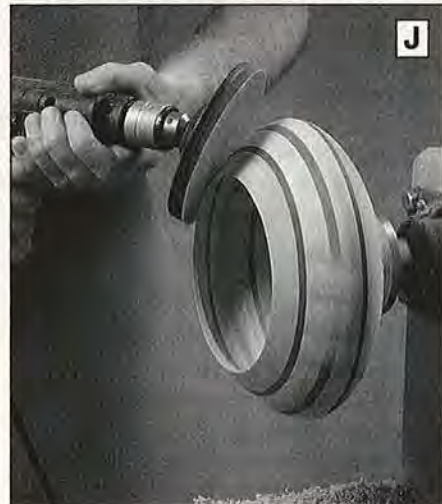

You can sand the bowl by hand, but you'll save yourself a lot of time by power-sanding. An angle drill works well on the inside wall of the bowl.

# A SOUTHWEST- BORROWING FROM PATTERNS WOVEN IN HISTORY



You won't make this bowl in an evening, in fact, it took us almost 30 hours to cut the pieces to size, glue them together, and then turn the bowl. But, you'd be hard-pressed to find a bowl of this quality for under \$400.

To shave a few hours off the process, we've coaxed a wood dealer into supplying all the wood needed for the bowl. They've agreed to plane all boards to the correct thickness. See the Buying Guide on page 74 for our source.



**NOTE:** Stack-laminated bowls require more planning than most turnings, but the spectacular results make them worth the effort. It's essential to read the stack-lamination techniques article beginning on page 26 for in-depth information on the cutting, clamping, and turning processes needed to produce these stunning bowls. To avoid duplication, we frequently refer to photos in the techniques article.

You'll need some thin stock for this project. You can plane or resaw thicker stock to the thicknesses stated in the Bill of Materials, or see the Buying Guide for our source.

## CUT AND GLUE THE PARTS FOR LAYERS 1 THROUGH 6

**1** Cut parts A-F to the sizes listed in the Bill of Materials. (Cut three of the seven Bs to length plus 1/4".)

**2** Position edge to edge the three Bs cut 1/4" extra in length. Now, cut two pieces of plywood to 11 1/2 x 4" to form the plywood clamping boards used to hold these three pieces flush while clamping. (As

## Cutting Diagram

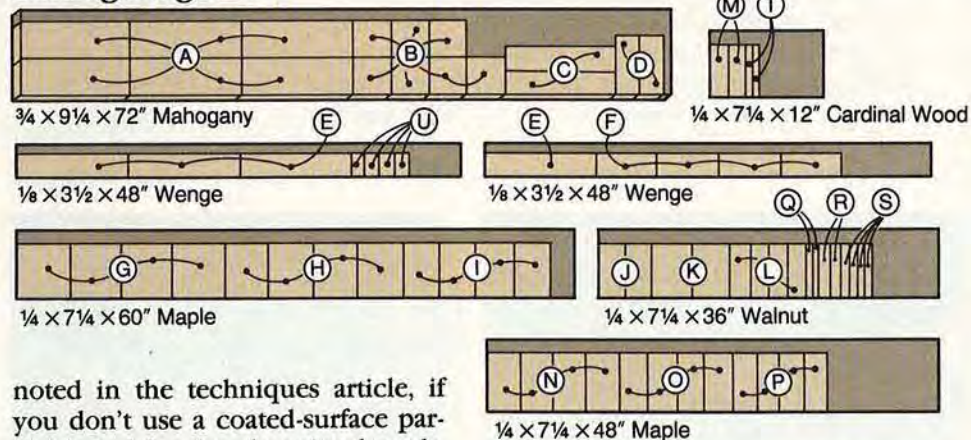

noted in the techniques article, if you don't use a coated-surface particleboard for the clamping boards, place waxed paper between the plywood and the pieces being clamped.) It is important that the pieces being laminated don't stick to the clamping boards.

**3** Spread glue on the mating edges of the three pieces. Then, clamp the pieces edge to edge between the two pieces of plywood. (Refer to photos A, B, and C in the techniques article for help with this and the following step.)

**4** Remove the clamps, and trim both ends of the three-piece lamination to 4" in length (remember, measure length *with* the grain; the three-piece lamination should measure 4" long by 12" wide.)

**5** To form Layer 1, glue the three piece lamination between two A pieces where shown on the Bowl Lamination Drawing. Later, sand Layer 1 flat as shown in photo D on page 29.

# INSPIRED BOWL

Bill of Materials					
Part	Initial Size of Pieces			Material	Qty.
	T	W	L		
Layers 1 thru 6					
A	3/4"	4"	12"	mahogany	6
B	3/4"	4"	4"	mahogany	7
C	3/4"	2 3/4"	12"	mahogany	2
D	3/4"	6 1/2"	2 3/4"	mahogany	2
E	1/8"	2 3/4"	12"	wenge	4
F	1/8"	2 3/4"	6 1/2"	wenge	4
Serrated Pattern					
G	1/4"	6"	5 3/8"	maple	4
H	1/4"	6"	4 3/4"	maple	4
I	1/4"	6"	3 7/8"	maple	4
J	1/4"	6"	2 3/4"	walnut	2
K	1/4"	6"	4"	walnut	2
L	1/4"	6"	2 1/4"	walnut	4
M	1/4"	6"	1 3/4"	cardinal wood	2
Block Pattern					
N	1/4"	6"	3 3/8"	maple	4
O	1/4"	6"	3"	maple	4
P	1/4"	6"	2 5/8"	maple	4
Q	1/4"	6"	1/2"	walnut	2
R	1/4"	6"	1 1/4"	walnut	2
S	1/4"	6"	3/4"	walnut	4
T	1/4"	6"	1/2"	cardinal wood	2
U	1/8"	2 15/16"	1 1/2"	wenge	4
Supplies: coated plywood for clamping boards, plywood for auxiliary faceplate, 1/4"-diameter dowel stock for guide pins, lacquer sanding sealer, polymerized tung oil, paste wax.					

**6** To form layers 2 and 3, glue, clamp, and sand the pieces as just described. Note the grain direction shown on the Bowl Lamination Drawing when cutting and clamping. Use the same procedure to form layers 4, 5, and 6.

**7** As described and shown in Photo E on page 30, and dimensioned on the Bowl Lamination Drawing, use a compass to mark a circle on the inside of each layer except for the

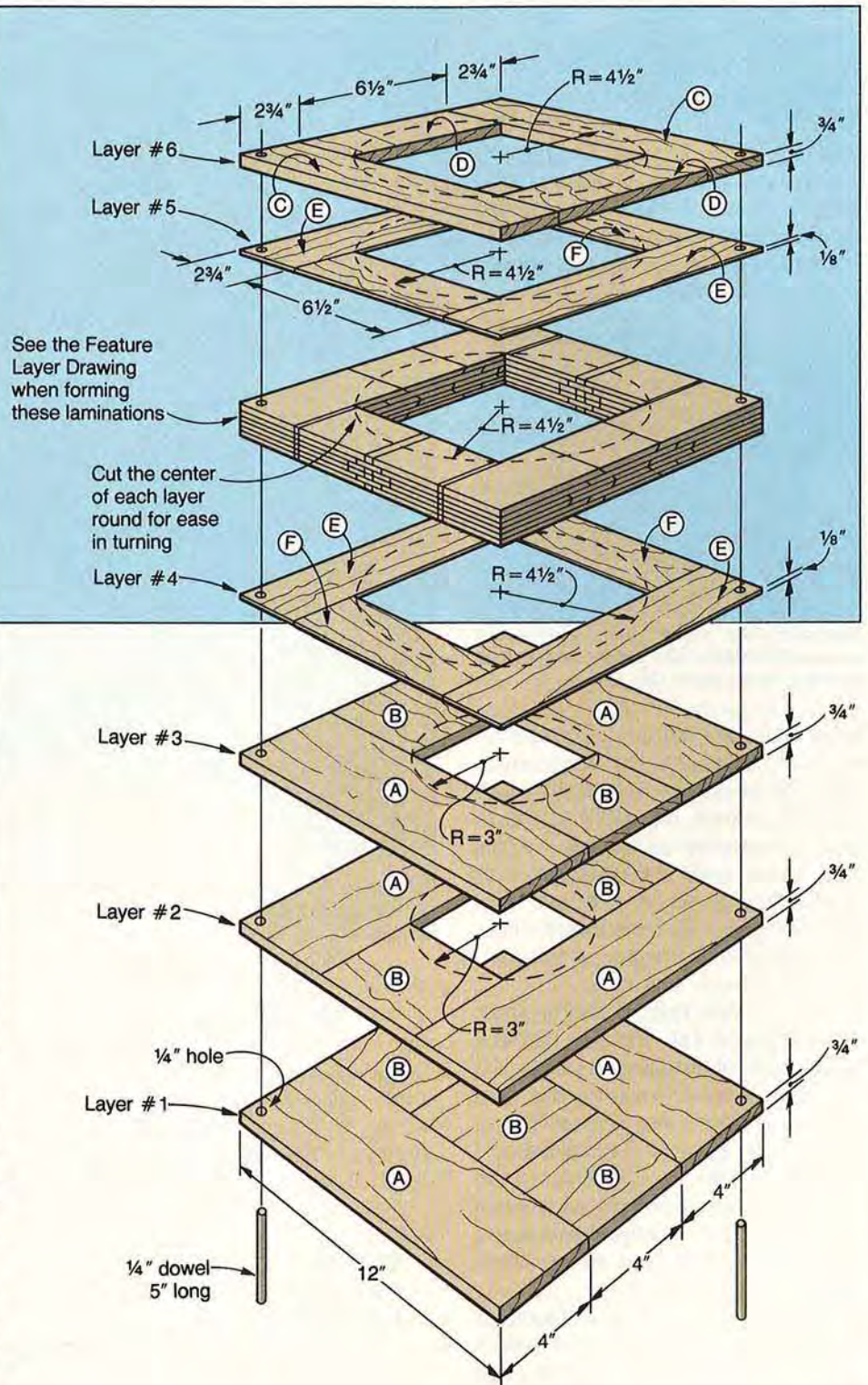

Continued

# A SOUTHWEST-INSPIRED BOWL

bottom layer. Cut the circles to shape with a scrollsaw or portable jigsaw. Cutting the inside of the layers round reduces the amount of stock you'll need to remove when turning the inside of the bowl.

## NOW, TACKLE THE FEATURE LAYER

Fit a miter gauge with an auxiliary fence, and tilt your tablesaw blade 45° from vertical. Cut parts G through M from 1/4"-thick stock to the sizes listed in the Bill of Materials. Glue and clamp each of the six individual layers together as shown in the photo below.



Sandwich the parts being glued and clamped between two pieces of particle-board to keep them flat.

2 Let each lamination dry for about an hour. Then, remove the clamps and lightly sand each layer with 100-grit paper. Be careful not to sand depressions at the glue joints or to round-over the edges or ends of the layers when sanding. (To keep the layers flat, we found that a half-sheet finish sander works better than a palm sander.)

3 Mark a centerline on the top face of each layer, and transfer the line to both front and back edges. (If you have trouble locating the centerlines, refer to our center-finding shop tip on page 18 for assistance.) Align the centerlines and clamp the layers in the arrangement shown on the Serrated Pattern Lamination Drawing. Check that the pattern aligns on both edges.

4 Measure 6" in both directions from the centerline and use a square to mark a line across each end of the stack. Using 3"-wide

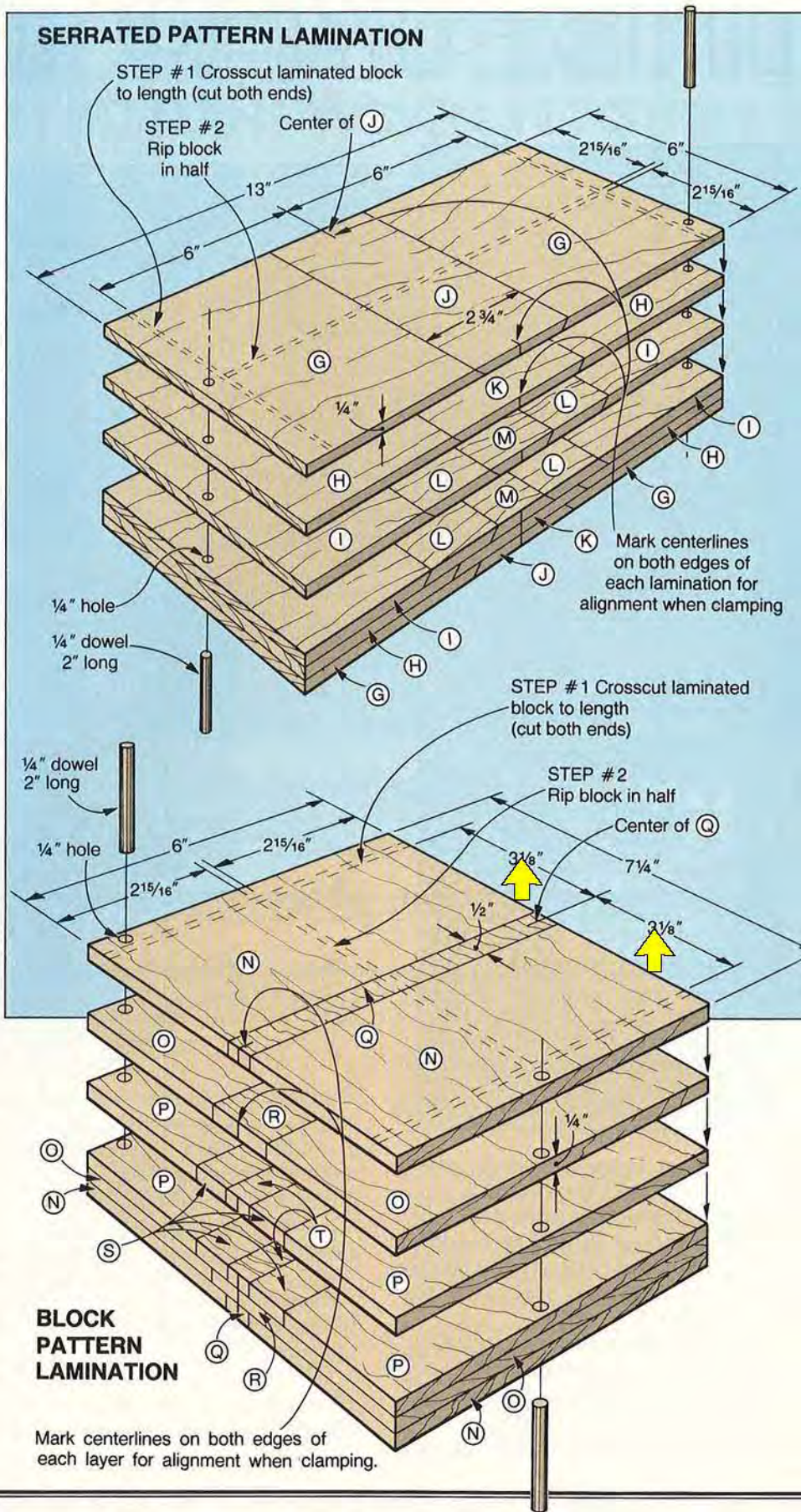

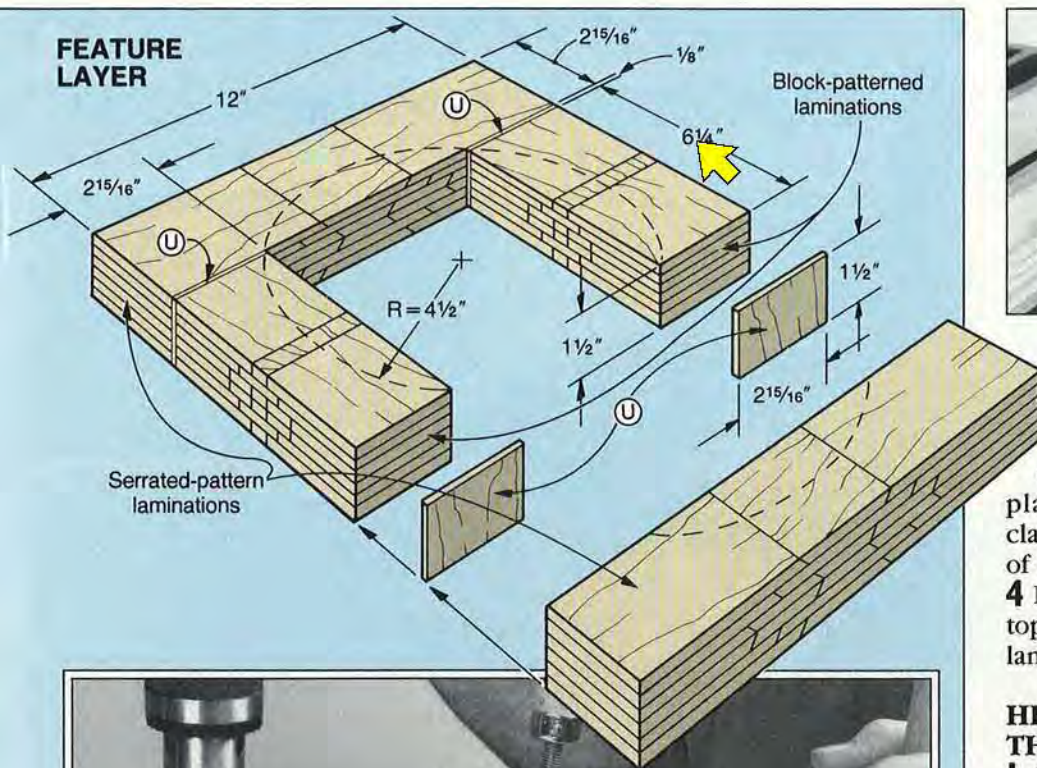

For safety, use a thin push block when cutting to length the narrow block-pattern pieces.

pieces in place where shown on the drawing at left. (We placed the pieces between two clamping boards to keep the faces of all the pieces flush.)

**4** Remove the clamps and sand the top and bottom faces of the feature lamination smooth and flush.

#### HERE'S HOW TO FORM THE BOWL BLANK

**1** Align the individual layers in the order shown on the Bowl Lamination Drawing. Once in position, dry-clamp the layers.

**2** As you did earlier with the feature layers, drill a pair of guide-pin holes through the dry-clamped assembly where shown on the Bowl Lamination Drawing. Remove the clamps. Next, cut two pieces of 1/4" dowel to 5" in length.

**3** Spread an even coat of glue on all mating surfaces. Then, clamp the layers together, using the dowel guide pins to realign the pieces. See photo H on page 31 for help.



After marking reference lines 6" from the marked centerline, drill two guide-

pin holes in the patterned pieces to assure precise alignment when gluing.

blocks for support, drill a 1/4" guide-pin hole on the outside of each marked line as shown in the photo above. Remove the clamps, and cut two 1/4"-diameter dowels to 2" long.

**5** Spread an even coat of glue on the mating faces of the six layers. Insert the 2" dowels into the 1/4" holes to realign the pieces, and clamp together the six layers.

**6** Remove the clamps, and trim each end of the lamination where marked in Step 1 on the Serrated Pattern Lamination Drawing. Using Step 2 on the same drawing for reference, rip the block in half.

#### NEXT, MAKE THE BLOCK-PATTERN LAMINATION

**1** Using a thin push block (ours measured less than 1/2" thick) as shown in the photo above right, cut to size parts N through T for the block-pattern lamination. Laminate each layer and then glue and clamp the individual layers to form the block, using the same process just described in steps 1 through 6.

**2** Cut four wenge parts (U) to the size listed in the Bill of Materials.

**3** Glue and clamp the block-pattern laminations between serrated-pattern laminations with the wenge

#### TURN THE LAMINATED-BOWL BLANK TO SHAPE

**1** With a compass, mark a 6" radius centered on the bottom of the bowl blank. Next, mark a 6 1/4" radius on a piece of 3/4" plywood (we prefer Baltic birch) for the auxiliary faceplate. Bandsaw the bowl blank and auxiliary faceplate to shape.

**2** Fasten the auxiliary faceplate to your 6" metal faceplate. Turn the auxiliary faceplate to a 6" diameter. Center and glue the bowl blank to the auxiliary faceplate. Let the project stand for 24 hours.

*Continued on page 74*

# COAXING A

## CALIFORNIAN T.C. MacMICHAEL MIXES



**Homemade finishes frequently stir up thoughts of secret ingredients and images of bubble, bubble, toil, and trouble. But, in fact, these finishes often outperform commercial concoctions. Here, San Diego furnituremaker and educator T.C. MacMichael demystifies his finishing process.**

**W**hen T.C. MacMichael studied furniture design at Central Washington University in the mid-70s, he experimented with various finishes. "I didn't like surface finishes such as lacquer and varnish—I felt I had to look through them to see the wood," he explains. "Oil finishes alone lacked the luminous quality I like. But, by working an oil and wax mixture into the wood, I achieved exactly the right finish."

T.C.'s finishing process includes three separate coats of Daly's SeaFin Teak Oil followed by two coats of a teak oil and beeswax mixture. Although each step requires a great deal of handwork, the results reflect the effort.

The finished piece not only has visual appeal, but it's a delight to

touch. And, T.C.'s finish stands up to water and alcohol. In fact, this craftsman has so much confidence in his finishing process that he not only applies it to all his custom furniture, he also *teaches* the technique at San Diego State University, where he heads the furniture design program.

### SETTING UP FOR TEAK OIL

According to Kyle Peterson, factory sales representative for Daly's, their SeaFin Teak Oil contains tung oil, phenolic (plastic) resins, and dryers. Daly chemists formulated the finish for marine use. Today, though, it is widely applied to furniture, and for good reason. T.C. has discovered that the teak oil he uses protects the natural color of wood—such as the orange of padauk that traditionally darkens rather quickly—far longer than any other oil.

T.C. has the following supplies on hand when he starts a finishing project, see photo, *above right*: plenty of paper towels, 0000 steel wool, cheese cloth, clean cotton cloths, 400–600-grit wet-dry sandpaper, SeaFin Teak Oil, and beeswax. "The beeswax works easier than carnuba, and the results are equal," T.C. notes.

### STEP-BY-STEP TO A GLOWING FINISH

**1** In preparation for finishing, T.C. sands all surfaces smooth with 220-grit paper, then blows off the sanding dust with compressed air or wipes it clean with a tack cloth. He next uses a soft cloth to heavily flood the surface with the first of three coats of plain teak oil. While the wood is wet, T.C. sands with the grain with 400-grit wet/dry paper.

**2** After a five-minute wait, T.C. removes all traces of oil on the wood's surface with soft cloths or paper towels. "When I finish porous woods, such as oak, droplets of oil will continue to come up for an hour or longer. These all have to be wiped off," advises T.C.

**3** The teak oil takes a minimum of 12 hours for the first heavy coat to dry. When it is dry, T.C. rubs the wood with 0000 steel wool, also with the grain. Next comes a thorough cleaning of the wood with air or a tack cloth.

The procedure for the two subsequent coats follows that of the first, except that T.C. relies on 500-grit wet/dry paper to apply the second coat and 600-grit the third. "The fine sandpaper removes the tiny wood-grain hairs that the oil raises," notes T.C. "The paper also 'pushes' the oil into the grain and fills the pores with fine wood particles at the same time."

**4** Because the oil/beeswax mixture is flammable, T.C. uses a doubleboiler to keep it away from direct heat. In this arrangement, T.C. heats the teak oil to between 120–140° F. (read with a candy thermometer) and adds beeswax at the rate of ¾-ounce (dry weight)



# GLOW FROM WOOD

## OIL, BEESWAX, AND ELBOW GREASE



◀ For his homemade finish, T.C. requires paper towels, 0000 steel wool, cheese cloth, cotton cloths, 400–600-grit wet-dry sandpaper, SeaFin Teak Oil, and a block of beeswax.

▼ A final pass down the grain with a cheesecloth pad removes excess oil and beeswax from the wood. Says T.C., “For this finish, you don’t need any special equipment.”



If you or one of your friends use a finishing system you’d like to crow about, why not drop us a line? Write to: “In Search of the Perfect Finish,” 1716 Locust Street, Des Moines IA 50336. Who knows, maybe you’ll be featured in the next article.



to 8 ounces of oil. Frequent stirring blends the mix, but it’s the one-day curing time that really does the trick. Says T.C., “The standing time, and the subsequent reheating before use, allows the mixture to blend much better than any simple stirring I could do. It’s like the taste of stew the second day—much improved with age.”

**5** T.C. applies his hot oil/wax solution with a soft cotton cloth. He works on only a few feet of surface at a time.

**6** After T.C. covers the entire project, he goes back over the wood

cross-grain with cheesecloth pads to remove any unabsorbed mixture. To keep a fresh cloth surface working, he frequently turns the pads inside-out. A final pass goes with the grain.

T.C. repeats the whole process after the first oil/wax coat has completely dried (up to 24 hours). To complete his finish, T.C. adds two coats of a good quality paste wax, such as Minwax, and buffs.

“The final finish has a glow you can’t obtain by simply putting paste wax over oil,” the craftsman comments. “Although this process is lengthy, you don’t need any special

equipment. And, if the finish gets damaged, you can renew it easily with two coats of the oil/wax mix. Occasional buffing with a soft cloth, and a coat of paste wax once a year, is all the maintenance normally required.”

### Buying Guide

● **SeaFin Teak Oil.** Daly’s, 3525 Stoneway No., Seattle, WA 98103. Call 800-521-0714, ext. 276 for nearest dealer. About \$9 per quart.

● **Beeswax.** At most hardware stores, about \$1.50 per 2x3” block.

● **Cabinetmaker’s Paste Finishing Wax.** T.C. has had equal results with several brands. ♣

Written and photographed by Gary A. Zeff

# SCROLLSAWS UNDER \$150

## ARE THEY A GOOD VALUE FOR THE MONEY?

If you occasionally need a scrollsaw, but haven't bought one because you think a high-quality machine costs a lot, stay tuned. Because of low-cost Taiwanese machines and some good old-fashioned American competition, you now can buy a well-made scrollsaw at a very down-to-earth price.

Five years ago, you had to spend at least \$200 to buy a scrollsaw capable of making high-quality cuts. Then, American Machine and Tool (AMT) introduced its 15" model 4390 at a price of \$149 and the market changed overnight. The Taiwan-made AMT saw resembled the Hegner Multi-max 2, a finely machined German-made scrollsaw that performed exceptionally well but listed at \$894. Today, you can buy this Hegner machine for less than \$600. In the last two years, other companies have introduced similar versions of the AMT model, bringing down the price of the machines to about \$130. The three models we tested were nearly identical, and it's no coincidence, since all of them originate from the same Rexon plant in Taiwan. We also put AMT's new 15½" machine to the test—a beefier, slightly more expensive model that may lead the way into the next round of inexpensive scrollsaw wars.

### LOW PRICE, BUT SOLID PERFORMANCE

All these machines have a sound scrollsaw principle behind them: constant-tension parallel arm construction. This design produces fast, smooth cuts with less blade breakage than rigid-arm scrollsaws for two main reasons.

First, the parallel arms pull evenly on the blade in both the up and down motions. Rigid-arm scrollsaws, which pull the blade only in the downstroke and rely on a spring to return the blade, create more blade fatigue and breakage.

Second, the parallel arms pull the blade in a motion that brings it slightly forward in the downstroke, allowing it to cut more quickly than a rigid-arm saw. But, fast cuts don't mean much if they're not smooth, and we found that these saws also yield very smooth cuts.

### SHOULD YOU BUY ONE?

If you only use a scrollsaw for small projects on a sporadic basis, these saws represent a good value. On the other hand, if you do a lot of scrollwork, or intricate jobs involving metal materials or veneers, you'll be better off with a more-expensive variable-speed machine.

For their low price, these saws also require you to make a few more trade-offs in ease of use and quality of construction. Changing blades proved to be time-consuming, because we had to secure both blade clamps in the upper arm holder before inserting the blade and tightening the clamp screw. These machines had the lower-quality castings typical of Taiwanese machines, but this didn't affect cuts during our tests. All the ma-



▲ The sleeve bearing holding the arm to the casting of the AMT model 4600 on the left supports the arm on both sides as shown.



▲ The AMT model 4600 shown above has a pin-type blade holder, but you can install a pivoting blade clamping device that holds standard blades and comes with every unit.

chines share the same plastic guard that proved to be more irritating than protective, while providing no control over the workpiece.

### THE MODELS: WHAT WE FOUND

All of the machines performed to our expectations. However, we appreciate the extra heft of the AMT model 4600 (it weighs 6½ pounds more than the others) and the added support surrounding its arms. As shown in the photo above top, a piece of casting supports the arm's





**“The AMT 15½” scrollsaw cuts as well as any fixed-speed scrollsaw I’ve used. The 15” models work well, but with a little more vibration.”**

*J. R. Cowling*

Design Editor

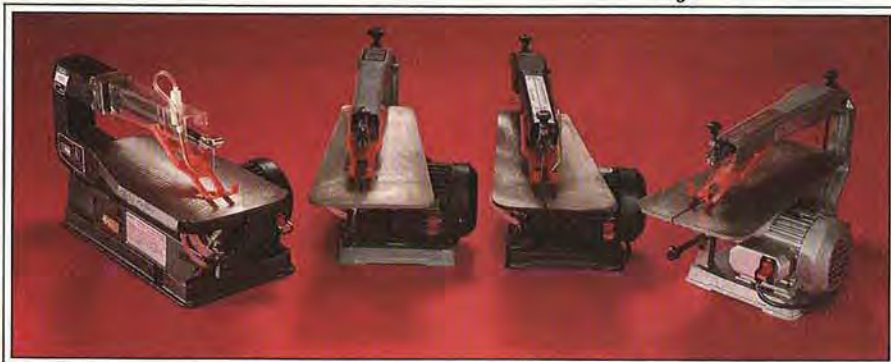

▲ We took a look at four scrollsaws representing two types of inexpensive machines. From left, AMT’s 15½” model 4600, and these nearly identical 15” machines: Delta, Penn State, and Total Shop.

whereas the similar bearing on the 15” models such as the Delta on the right receives support on only one side.

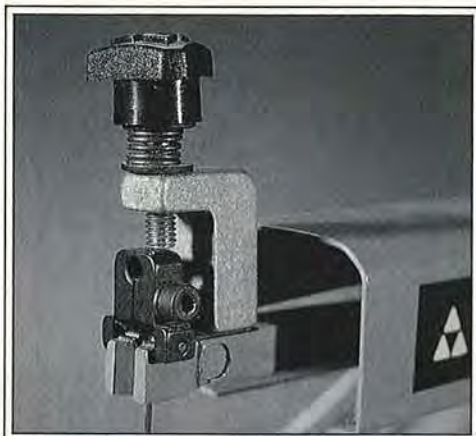

▲ When using a clamp-type holder such as the one shown above, make sure you leave a 1/16” gap between the locking screw and clamp to prevent excessive blade breakage.

**SCROLLSAWS UNDER \$150: TAKE YOUR CHOICE**

MANUFACTURER AND MODEL	THROAT DEPTH (INCHES)	STROKE LENGTH (INCHES)	STROKES PER MINUTE	MAX. CUTTING DEPTH (INCHES)	TABLE SIZE (INCHES)	TABLE BEVEL TO LEFT	SPEED CONTROL (Y, N)	Motor		Bearings <sup>1</sup>			WEIGHT (LB.)	COUNTRY OF ORIGIN	PRICE
								TYPE <sup>2</sup>	AMPS	MOTOR	ARM PIVOTS	TIE ROD TO MOTOR			
Various <sup>1</sup>	15	¾	1,725	2	17×7½	45°	N	TEFC	1.4	B	S	B	37.5	Taiwan	\$130*
AMT 4600	15½	¾	1,725	2	14¾×7½	45°	N	TEFC	1.4	B	S	B	44	Taiwan	169**

1. Similar machines sold by AMT, Delta, Grizzly, Jet, Penn State, and Total Shop

3. (S) Sleeve bearings  
(B) Ball bearings

2. TEFC= Totally enclosed, fan cooled

(\*) Prices vary

(\*\*) Includes \$50 of free merchandise

**MANUFACTURERS LIST:**

American Machine & Tool Co.  
Fourth Avenue and Spring Street  
Royersford, PA 19468  
215/948-0400

Jet Equipment & Tools  
1901 Jefferson Avenue  
P.O. Box 1477  
Tacoma, WA 98402  
800-426-8402

Delta International Machinery Corporation  
246 Alpha Drive  
Pittsburgh, PA 15238  
800-438-2486

Penn State Industries  
2850 Cornly Road  
Philadelphia, PA 19154  
215/676-7609

Grizzly Imports  
P.O. Box 2069  
Billingham, WA 98227  
206/647-0801

Total Shop  
P.O. Box 16297  
Greenville, SC 29606  
800-845-9356

sleeve bearing on both sides, giving this bearing greater stability. The saw sells for \$169, but you can pick out \$50 worth of free merchandise from the AMT catalog with every purchase.

Among the 15” machines, you’ll need to make a purchase decision based on price, warranty, dealer network (if any), and any specials offered at the time. Warranties range from 10 to 30 days for full refunds, from 1 to 2 years for the motor, and from 1 to 10 years for the machine excluding the motor. 🐞

Photographs: Hopkins Associates

“It is a dog-eat-dog world”

# TALES OF THE TIMBER TRADE

*Too quickly, the canoe glided out of the river's blackness to scrape the bank. From its prow, a figure rose, then alighted on the dank sand. Other figures, darker than even the jungle night, followed the first.*

*Yards back from the river, the man clad in khaki paused, unsure. Pulling on his slouch hat, he studied them.*

*Were these the men he'd been promised to lead him? His right hand palmed his revolver, just for assurance. In his years of searching the global jungles, he'd only fired it as a last resort. Like the time up from Brazzaville, on the Congo. In the end, he'd gotten out the treasured ebony. But it wasn't, as they say, a fun trip. With luck, he could trust these men, and he'd have rare wood to deal.*

**D**espite the thrills and danger home woodworkers might associate with the trade in expensive woods of the world, today's import buyers seeking exotic stock rarely resemble movie adventurer Indiana Jones. Nor do they regularly run reptile-ridden rivers pursuing the trail of rare logs. Yet, adventure and the unexpected still stalk the world's wood markets.

## STEP INTO THE WORLD OF THE EXOTIC TIMBER TRADE

“One time, in Guatemala looking for rosewood, mahogany, and plantation teak, my contact had a pistol stuck in his belt and an Uzi machinegun in the back seat of the car,” recalls Bud Mikelonis, 53, manager of Frank Paxton Lumber Company's New Orleans facility. “Down there, *bandidos* roam the jungles. If you're traveling to a sawmill by vehicle—they think you might be carrying the payroll. My escort said he had shot eight or

nine men! It came to mind that maybe I shouldn't have gone on that trip.”

Bud has sought hardwood in Central and South America for three decades. Most of his travels came when he worked for a company specializing in exotic woods. Now, Bud only takes two trips a year to Brazil and Guatemala to buy species such as mahogany, Spanish cedar, rosewood, and interesting exotics from respected dealers in the larger cities. He still gets occasional rushes of adrenaline, though.

“A few years ago, I was in the interior of the Amazon, watching the Indians fell timber,” recalls Bud. “By the way, that's when the exotics are found—when other trees are being cut. Anyway, I saw them drop some huge trees they called *jatoba*. The Indians drank the sap, saying it was medicine. They wanted me to give it a try, but I could see they were getting intoxicated, so I said, ‘No way.’ I didn't want to stay there, hooked on jungle juice!”



In the Port of New Orleans, a freighter unloads imported wood located and purchased by a buyer in a distant land. Often, the trail of such exotics as ebony, rosewood, wenge, and others from around the globe leads to adventure, chicanery, and frustration.



Bud looked at the wood, however, and brought samples back. Now, he sells "Brazilian cherry" as a popular hardwood flooring.

English-born Geoff Dodd, 49, carries the title of a senior vice president at Craig Lumber Corporation in Memphis. Of his 30 years in the wood business, he spent seven in Africa as an import wood buyer.

Geoff remembers a colleague's close call. "The chap barely escaped the bloodbath of an African revolution. With gunfire all around and flames lighting up the night, he lashed some logs together and floated down river to safety. The raft could have been made of ebony, it mattered little to him at the time."

Although buying wood on the scene can result in some surprising turn of events, dealing in some countries only proves frustrating due to the delays involved.

#### MAÑANA MAY BE SOON ENOUGH FOR MOST

"It's not unusual to have some species delivered 15 months late," Geoff says. "In Africa, the mills play up severe weather conditions as excuses. Granted, they have their problems working in the jungle, such as lack of transportation. But they don't understand maintenance—their mills

go to heck, most of their roadways nev-

er get repaired in time. That is, where there *are* roads!" Geoff chuckles.

"In Zaire, the logs have to come maybe 1,500 miles down the Congo River to the sawmill. When the river is low, the logs get hung up until it rains."

When the order does arrive in port, there's likely to be another hitch. In some places, according to the globe-trotting Englishman, even the government interferes.

"It's called 'gazumping.' When the goods finally arrive in port, the government body decides that the minimum price should be 'X' for a certain species," says Geoff. "They try to make the seller get that price. It makes a contract a valueless piece of paper."

#### IN ALL LANGUAGES, IT'S BUYER BEWARE

Unlike shopping at your favorite retail store, transactions to buy hardwoods in a foreign country aren't usually based on trust. For instance, many world governments pass laws forbidding the export of goods not paid for in advance. To comply, wood buyers often rely on a "letter of credit." A seller presents the letter of credit given to him by the buyer, along with documents evidencing that the goods were shipped, to the local bank. He gets his money before the buyer receives the goods.

Canadian David Coleman, 41, import manager for Theodore Nagel Co., a West German specialty hardwood supplier,

recalls an unwary wood buyer that came away empty-handed. "A company bought a container [semi-trailer load] of rosewood based on samples shown them and paid for it with a letter of credit for about \$50,000," David relates. "But, the seller had bribed the port authorities. The container was actually filled with sandbags."

David bought wood for 16 years, primarily in Indonesia, and heard many a story of international chicanery. "I know of one company that bought a large amount of Indian rosewood. Unfortunately, when they went to kiln-dry it, they discovered that the boards were all sapwood that had been dyed red!"

Experienced in three continents, Bud Mikelonis, Geoff Dodd, and David Coleman agree that the most success comes from dealing with men of integrity. In this belief, they have followed the advice given by a lumberman of an earlier time:

*"Granted that there are many honorable men everywhere, the fact remains that in international commerce, it is a dog-eat-dog world."*

—Floyd Miller (1904–1978), lumber buyer, Frank Paxton Lumber Co., Kansas City. ♣

Written by Peter J. Stephano  
Photograph: Richard Mansur  
Illustrations: Jim Stevenson



## ALL DECKED OUT WITH FILIGREE

# PLANT STAND

We were amazed by the laser-cut filigree samples we recently received. But, how could we use this product, with its scrollsaw-like pattern, in a furniture project? Then, Jim Boelling, our project builder, starting experimenting with it and came up with this classic-looking stand. We've placed plants on it and we've used it for displaying items. Now, what are you going to do with yours?

### SHAPING UP YOUR LEGS

**1** Cut the legs (A) to the size listed in the Bill of Materials. We used 1 1/4"-thick birch (commonly called 5/4 stock) for the legs. If you have trouble locating stock this size, you can laminate 3/4" stock face to face, and then resaw or plane the laminations to the correct thickness. Be sure to plane or resaw an equal amount off each face so the glue line remains centered.

**2** Rout a 3/16" round-over along all four edges of each leg. (We did this on a table-mounted router fitted with a fence to avoid routing the top and bottom ends of the legs—the ends need to remain flat.)

**3** Sand a slight round-over on the bottom of each leg to prevent the leg from later snagging the carpet. Now, sand each leg smooth.

### CONSTRUCT THE FOUR APRON FRAMES

**1** Crosscut a 3/4"-thick piece of birch to 24" in length. Now, rip four 1/2"-wide strips from the 24"-long piece. Each strip should measure 1/2 x 3/4 x 24" for the apron-frame members (B, C).

**2** To form the 1/2" bullnose, rout 1/4" round-overs on the top and bottom

corners of one edge of each 24" strip. See the Rail Detail accompanying the Apron Frame Drawing for details.

**3** Cut a 1/8" groove 1/8" deep along each 24"-long strip where shown in the Rail Detail to house the laser-cut filigree. Sand the four strips.

**4** Set a stop for consistent lengths, and miter-cut eight rails (B) to length from the 24"-long strips. Reposition the stop and cut eight stiles (C) to length. (For minimum waste, we cut two rails and two stiles from each strip.)

**5** Cut the filigree to length, being sure to center the laser-cut pattern in each apron frame. To do this, start by marking a centerline across one frame rail (B). Insert the filigree into the 1/8" groove in the rail, and center one of the filigree circles directly over the marked line as shown in the photo *above right*. Mark the ends of the filigree where shown on the photo, and crosscut the four filigree strips to length. (Our strips measured 7 3/8" long.)

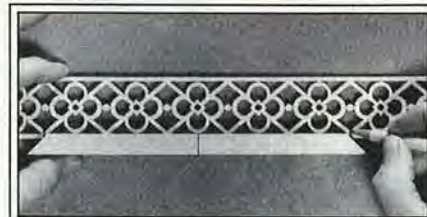

Center the filigree over the marked centerline, and mark cut lines for matching patterns at each end.

**6** Tape together (no glue just yet) each apron frame (with the filigree in place in the grooved opening) to check the fit of all the pieces. (When clamping small parts such as this, we found that masking tape works better than clamps.) Remove the tape, and trim any parts if necessary. Glue and tape each frame,

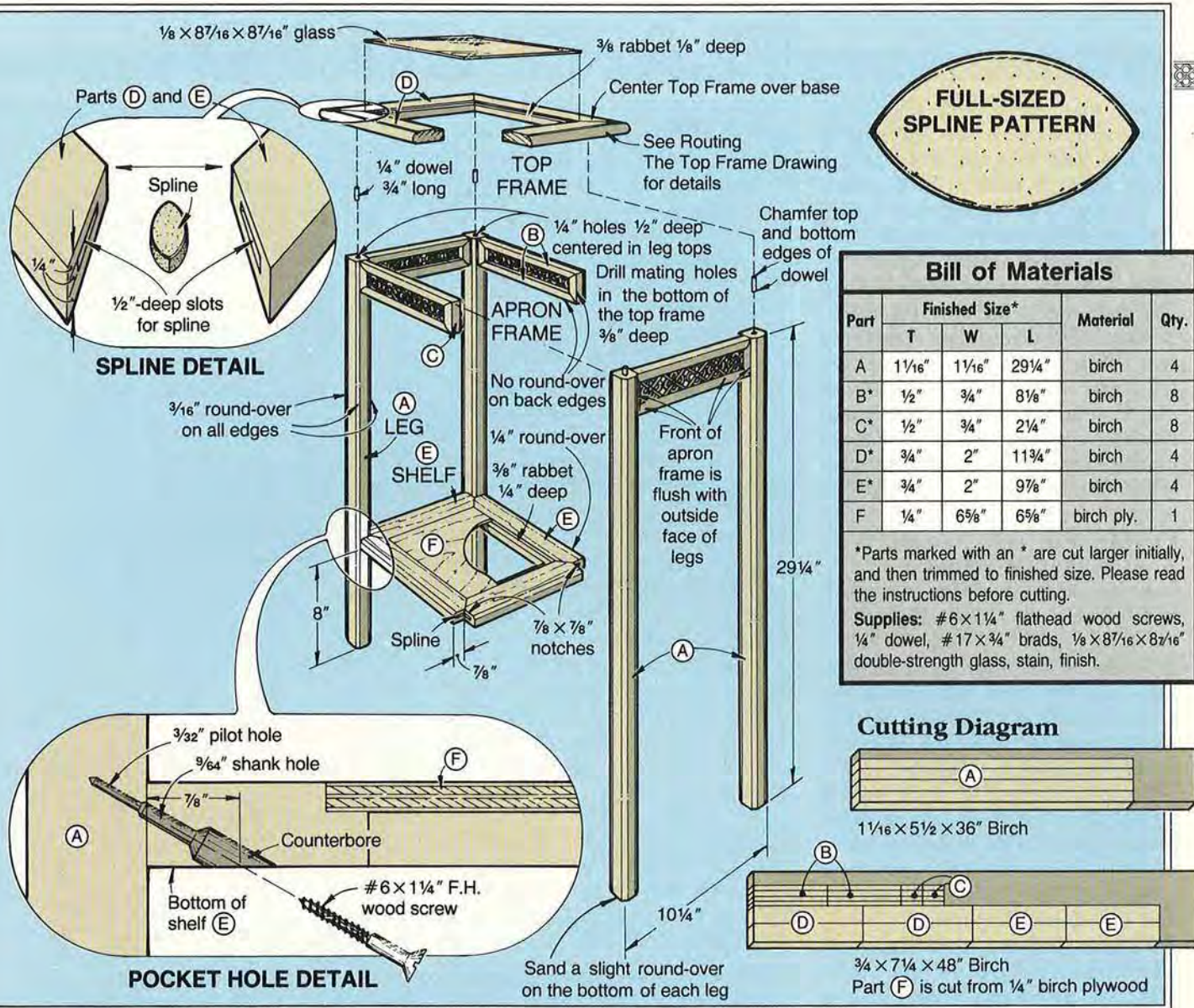

checking for square and tight joints. Wipe off any excess glue with a damp cloth.

**7** Snip the head end off a #17 x 3/4" brad, and chuck it into a portable drill. Now, use the brad "bit" to drill pilot holes where shown on the Apron Frame Drawing. Finally, drive #17 x 3/4" brads into the pilot holes to strengthen the miter joints.

### ASSEMBLE THE LEGS AND APRON FRAMES

**1** Cut two pieces of scrap stock to the same length as the apron rails.

**2** As shown in photo A (next page), lay the legs and apron frame facedown. Glue and clamp the pieces, using the scrap piece at the opposite end of the legs as a spacer.

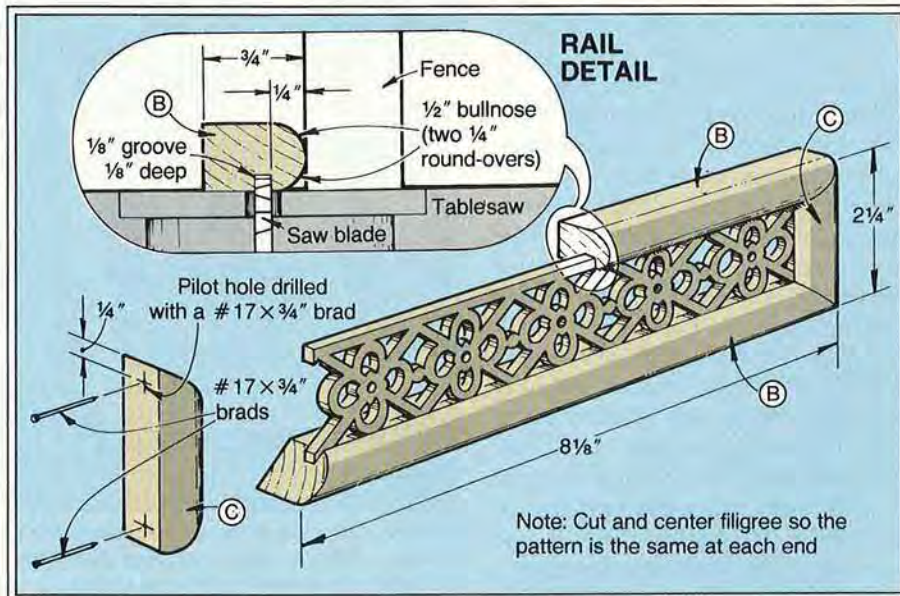

Continued

# PLANT STAND

Check that the top of the apron frame is flush with the top ends of the legs and that the front of the apron frame is flush with the front of the legs. (We found that laying the pieces facedown helped keep the front edges flush.) Repeat the process with the two remaining legs and one of the apron frames.

**3** Glue and clamp the remaining two apron frames between the two leg-frame assemblies. Check that the tops and fronts are flush, and that the assembly is square. Immediately wipe off any excess glue with a damp cloth.

## BUILD THE TOP FRAME AND BOTTOM SHELF

**1** From  $\frac{3}{4}$ "-thick birch stock, rip and crosscut two strips 2" wide by 48" long.

**2** Miter-cut the four top members (D) and the four shelf members (E) to length, setting stops for consistent lengths. (Cut two Ds and two Es from each 48" strip.)

**3** To form the guide block shown in Step 1 on the three-step drawing *above right*, cut an 8"-square piece of  $\frac{3}{4}$ "-thick scrap stock. Now, draw a diagonal line (corner to corner), and cut the square in half.

**4** To make the stop block shown in Step 2, cut a piece of  $\frac{3}{4}$ " stock to 2" wide by 11" long. Miter-cut one end at a 45°.

**5** Mount a  $\frac{1}{4}$ " slot cutter and fence to your table-mounted router. Raise the slot cutter to cut a slot centered on the edge of the  $\frac{3}{4}$ " stock. Position the router-table fence so the slot cutter bearing is flush with the front face of the fence where shown in Step 1. Finally, mark the three reference lines on the fence where dimensioned in Step 1 on Routing the Slots Drawing.

**6** Clamp the guide block and stop block to the router table, aligning the pieces with the marked reference lines where shown in Step 2. Cut a test strip of  $\frac{3}{4}$ "-thick stock to 2" wide, and miter-cut one end at 45°. Cut a  $\frac{1}{4}$ " slot  $\frac{1}{2}$ " deep in the mitered end of the test strip. Check that the slot is centered from left to

## ROUTING THE SLOTS

Position and clamp corner of guide block with reference line

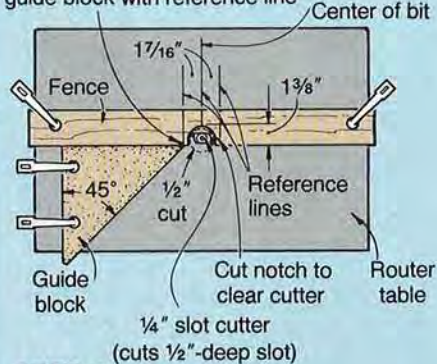

STEP 1

Cut stock face down

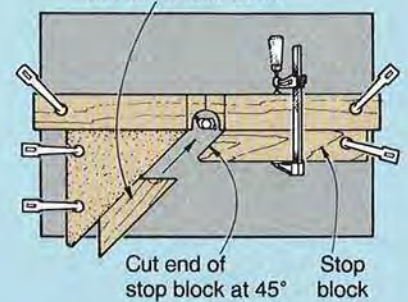

STEP 2

## ROUTING THE TOP FRAME

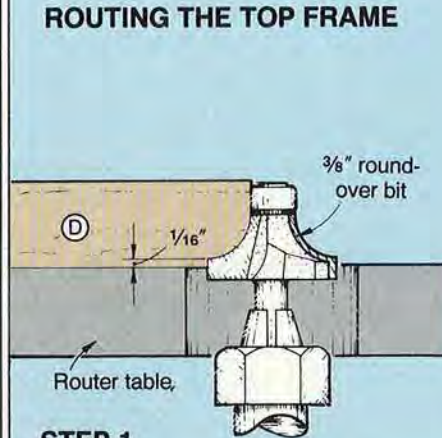

STEP 1

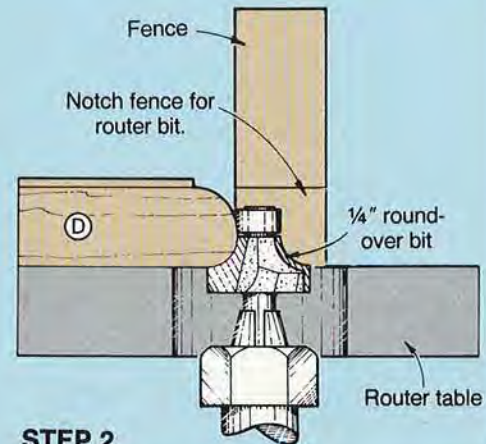

STEP 2



Glue and clamp an apron frame between two legs, using a spacer to keep the legs parallel. Check the assembly for square.

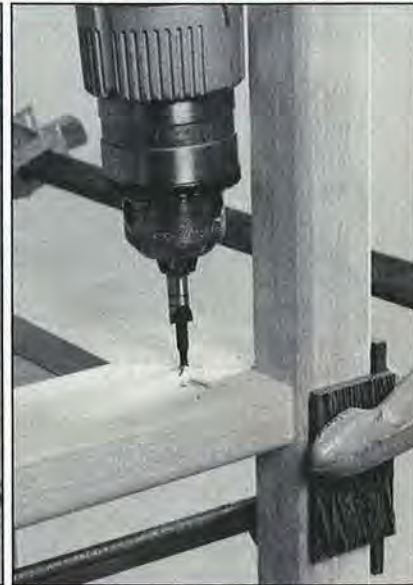

Mark a centerpoint  $\frac{1}{8}$ " from the notch on the miter-joint line, and drill  $\frac{1}{8}$ " deep.

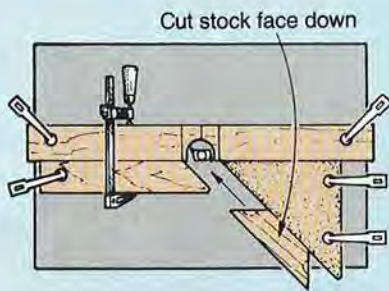

### STEP 3

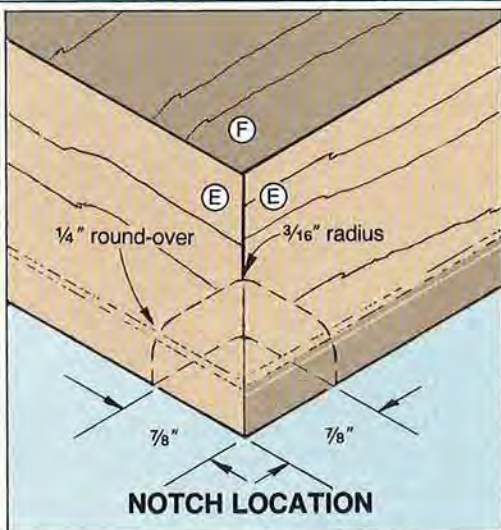

Angle the drill and drill a counterbored hole through the shelf and into the plant stand leg.

right and top to bottom as shown on the Spline Detail accompanying the Exploded-View Drawing. Make adjustments as necessary. Cut a slot on one end of each birch frame member (D, E) where shown in Step 2 of the drawing at *left*. For flush-fitting joints, keep the same face down and rout the opposite end of each frame member where shown in Step 3.

**7** Using the full-sized spline drawing as a guide, mark and cut one spline to shape from  $\frac{1}{4}$ " hardboard. Test-fit (no glue) the spline between two frame members. Adjust the spline if necessary. Now, using this first spline as a template, mark and cut 7 more splines to shape. Sand a slight chamfer along the top and bottom edges of each spline.

**8** Dry-clamp the top frame together to check for square and tight-fitting joints. Trim if necessary. Then, glue and clamp the top frame pieces together, checking for square. Remove the clamps, and sand the frame smooth. Repeat the process to form the shelf.

**9** Now, following the two-step drawing at *left*, rout the top and bottom edges of the top frame.

**10** Rout a  $\frac{1}{4}$ " round-over along the top edges of the shelf. Switch to a rabbeting bit, and rout a  $\frac{3}{8}$ " rabbet  $\frac{1}{4}$ " deep along the top inside edges of the shelf frame. Next, reset the depth of the cut, and rout a  $\frac{3}{8}$ " rabbet  $\frac{1}{8}$ " deep into the top inside edge of the top frame.

**11** Square the inside corners of the shelf frame and top frame with a chisel. Cut a piece of  $\frac{1}{4}$ " birch plywood (F) to fit the rabbeted recess in the shelf. Glue and clamp the plywood panel in the shelf. Later, sand smooth, being careful not to sand through the thin veneer on the plywood panel.

**12** Using a square, mark a  $\frac{7}{8} \times \frac{7}{8}$ " notch on each corner of the bottom side of the shelf. Then, mark a  $\frac{3}{16}$ " radius on the inside corner of each notch where shown on the Notch Drawing. (We used the end of a  $\frac{3}{8}$ " dowel to mark the radius.) Cut the notches to shape.

### ATTACH THE SHELF AND TOP TO THE LEGS

**1** Turn the plant stand upside down. Make a mark on each leg 8" from the bottom end of each leg. Position the shelf so that the bottom face of the shelf aligns with the marked lines. Clamp the shelf (also upside down) in position as shown in the photo B. Check that the shelf is flush with the marked lines.

**2** Using the Pocket Hole Detail accompanying the Exploded-View Drawing as a guide, mark an X on the miter joint  $\frac{7}{8}$ " from the inside corner of each notch. To start the pocket hole, drill straight down  $\frac{1}{8}$ " as shown in photo B. (We used a Stanley 1"  $\times$  #6 Screw Sink).

**3** Tilt the drill, and drill into the leg (A) as shown in the photo C. Install the screw. Repeat the drilling and screwing operation at each corner. Remove the clamps.

**4** Mark diagonals and drill  $\frac{1}{4}$ " holes  $\frac{1}{2}$ " deep into the top end of each leg. Place a  $\frac{1}{4}$ " dowel center in each hole. Center the top frame on the legs, and press down to transfer the dowel-hole centers to the bottom side of the top frame. Drill  $\frac{1}{4}$ " holes  $\frac{3}{8}$ " deep into the bottom face of the top frame where marked.

**5** Cut four  $\frac{1}{4}$ " dowels to  $\frac{3}{4}$ " in length. Sand a chamfer on each end of each dowel. Glue and dowel the top frame to the leg assembly. Immediately remove any excess glue.

### SAND AND FINISH

**1** Finish-sand the entire stand and apply the stain. Brush on two coats of clear finish.

**2** Take the stand to a glass dealer, and order the glass top.

### BUYING GUIDE

- **Laser-cut filigree.**  $\frac{1}{8}$ "-thick, white maple ply with a poplar core, 36" long. Catalog no. FIL8-WD, \$13.95 ppd. Constantine's, 2050 Eastchester Rd., Bronx, NY 10461. Or, call 800-223-8087 to order. 🌳

Produced by Marlen Kemmet  
Project Design: Jim Boelling  
Photographs: Jim Kascoutas  
Illustrations: Kim Downing; Bill Zaun



Ist Place  
Caricature Group  
"Have Ya Tried Feed?"  
Chris Hammock, Ft. Worth, Tex.

Ist Place Realistic  
Human Figure  
(15" and under)  
"Deep South,"  
Janet Cordell, Fayetteville, Ark.

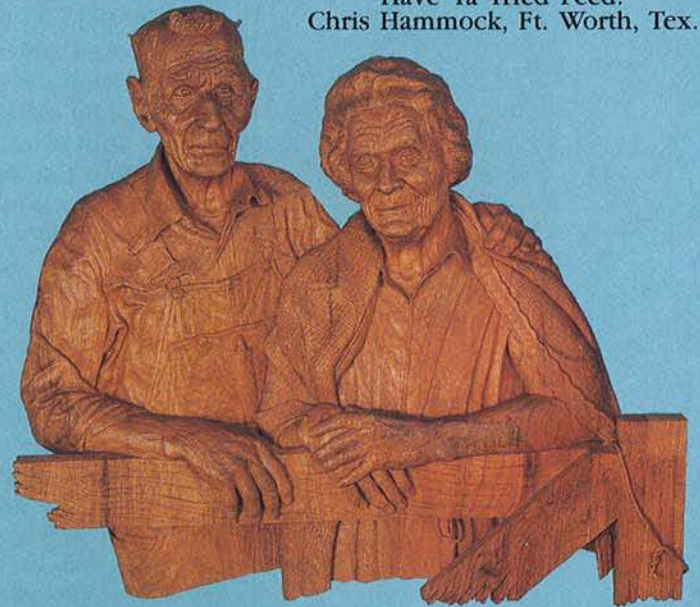
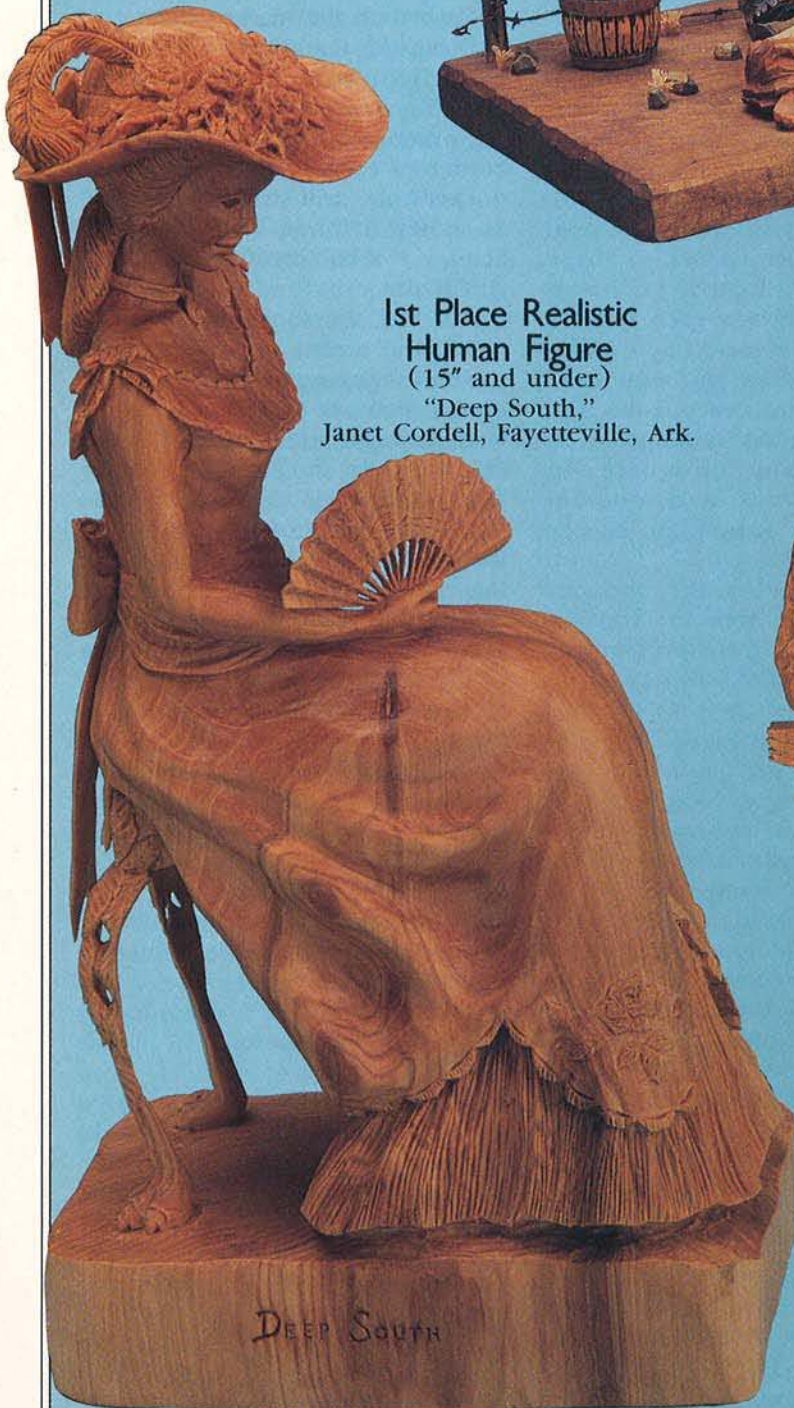

Best of Show, Ist Place Relief  
"Married in '33"  
Fred Cogelow, Willmar, Minn.

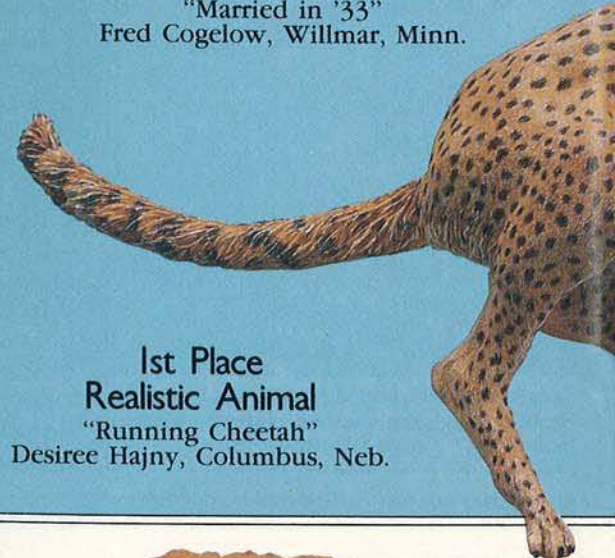

Ist Place  
Realistic Animal  
"Running Cheetah"  
Desiree Hajny, Columbus, Neb.



## Special Edition

### PROJECT SHOWCASE



**1st Place Realistic Group**  
"Bronco Buster"  
Lester Geiger, Flippin, Ark.

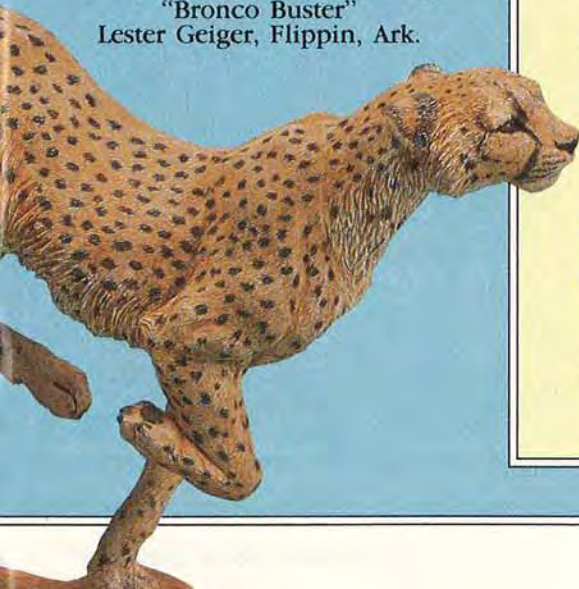

In this special edition of our regular Project Showcase feature, which traditionally highlights readers' projects, we proudly present a photographic sampling of winners from the National Wood Carvers Showcase '88. Held last September, the event attracted carvers from across the nation to Silver Dollar City, in Branson, Missouri, to meet, share techniques, and show their work.

The open competition drew 52 carvers from 17 states, and their 138 carvings were in competition for prizes in 14 subject categories. *WOOD*® magazine sponsored the \$3,000 Best of Show award.

In addition to the competition, 13 consignment carvers offered more than 300 works for sale in a public exhibition. At show's end, consignment carvers and competitors had sold 374 wood carvings. Fred Cogelow's Best of Show carving, shown on the facing page, commanded a sale price of more than \$6,000.

For information concerning dates, attendance, and entry in the 1989 National Wood Carvers Showcase, write: *National Wood Carvers Showcase, Miss Sue Pratt, Merchandise Division, Silver Dollar City, Inc., Branson, MO 65616. Or, call 417/338-2611.*

Our congratulations to the winners, a salute to all the fine carvers who participated, and best wishes to those who will compete this year.

The *WOOD* Editors

Other blue-ribbon winners, not pictured on these pages, included:

**1st Place Realistic Human Figure**  
(over 15") "The Defendant,"  
Fred Cogelow, Willmar, Minn.

**1st Place Figure—Human Bust**  
"I've Grown Old Believing"  
Janet Cordell, Fayetteville, Ark.

**1st Place Caricature Human Figure**  
"It's Times Like This I Wish I'd  
Taken Up Golf"  
Chris Hammock, Ft. Worth, Tex.

**1st Place Caricature Animal**  
"Day Dreams," Donald Rinehart, Drumright, Okla.

**1st Place Decoys**  
"Pintail Hen"  
James and Carolyn Cushing, Mountain View, Ark.

**1st Place Birds, Game and Prey**  
"Redtail Hawk and Copperhead"  
Allen Gibson, Dexter, Mo.

**1st Place Birds, Song**  
"Cardinal," Wanda Penny, Pine Bluff, Ark.

**1st Place Aquatic**  
"Sycamore Sun Perch"  
Ron Ladner, Mountain View, Ark.

**1st Place Original Christmas Ornaments**  
"Christmas Ornaments"  
Joseph Wannamaker, Godfrey, Ill. 🌲

A HANDSOME RENDITION OF A FURNITURE CLASSIC

# TRESTLE TABLE

“The simple, clean lines of this table allow it to blend with country and contemporary settings. Wooden pins securely join the stretcher to the uprights for lasting durability and classic looks. To complete the set, look for Shaker chairs in our August 1989 issue.”

*A. R. Downing*

Design Editor



Svegaard ladderback chairs courtesy of Workbench Modern Furniture, Des Moines

**T**restle tables date back hundreds of years, and were common in the Middle Ages. The early tables consisted of loose boards temporarily set on trestles—open, braced frames. The table has undergone many changes in design to meet the needs of those who built it. The Shakers, for instance, designed and constructed many variations—some up to 20' long—for communal dining.

**START WITH THE UPRIGHTS**

**1** Rip and crosscut eight pieces of  $\frac{3}{4}$ "-thick oak to  $2\frac{7}{8}$ " wide by  $24\frac{1}{2}$ " long for the four uprights (A).

**2** With the best surfaces facing out, glue and clamp two pieces together for each upright. Check that the ends and edges are flush. Later, scrape off the excess glue, and plane or joint  $\frac{1}{16}$ " off each edge to ensure flatness. Trim both ends of each upright for a  $23\frac{1}{2}$ " length.

**ADD THE FEET AND TABLE SUPPORTS**

**1** Cut eight pieces of  $\frac{3}{4}$ " oak to  $3\frac{1}{8}$ " wide by 29" long for the two feet (B). For each foot, laminate four pieces together face to face, keeping the ends and edges flush and the best sides facing out.

**2** Scrape the excess glue off the edges (not the ends) of each foot. Plane or joint  $\frac{1}{16}$ " off each edge for a 3" finished width.

*Continued*

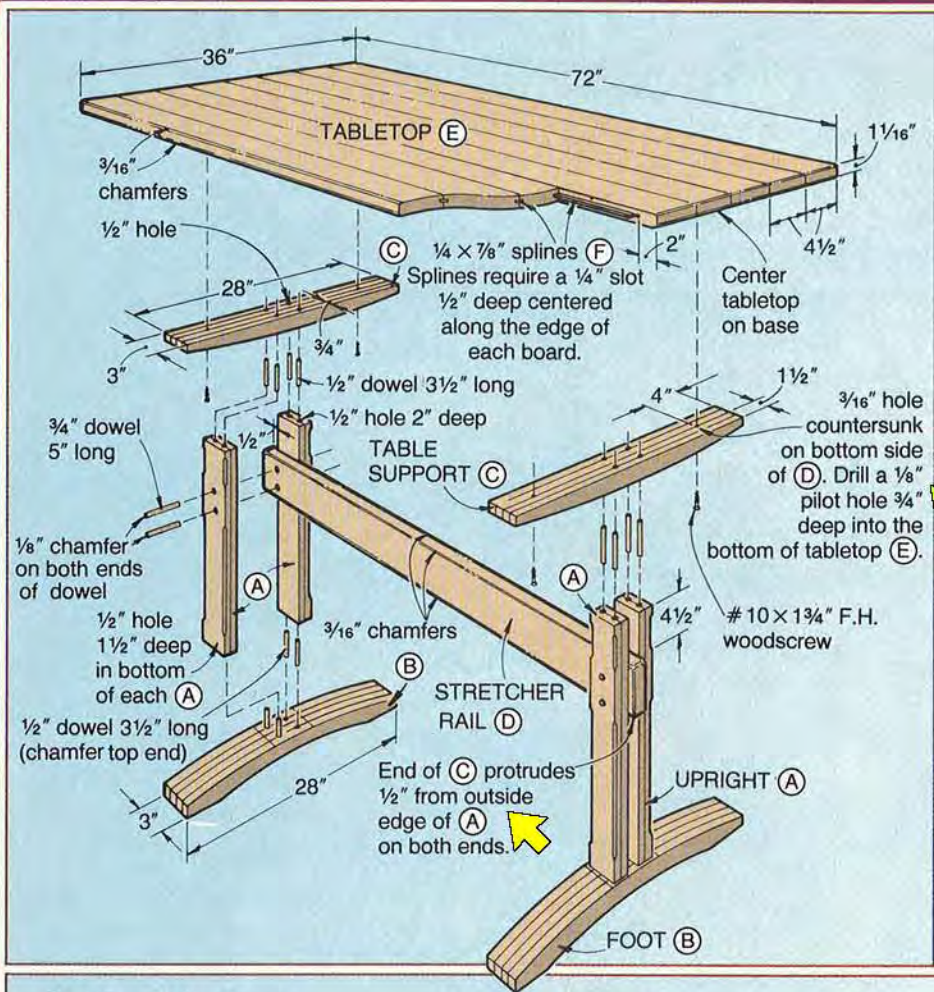

Part	Finished Size*			Material	Qty.
	T	W	L		
A*	1½"	2¾"	23½"	oak (laminated)	4
B*	3"	3"	28"	oak (laminated)	2
C*	3"	1½"	28"	oak (laminated)	2
D*	1½"	5"	57"	oak (laminated)	1
E*	1½"	36"	72"	oak (laminated)	1
F	¼"	7½"	67½"	hardboard	7

\*Parts marked with an \* are cut larger initially, and then trimmed to finished size. Please read the instructions before cutting.

**Supplies:**  $\frac{1}{2}$ " dowel stock,  $\frac{3}{4}$ " oak dowel stock, #10 x  $1\frac{3}{4}$ " flathead wood screws, stain, polyurethane sanding sealer, polyurethane, 0000 steel wool, paste furniture wax.

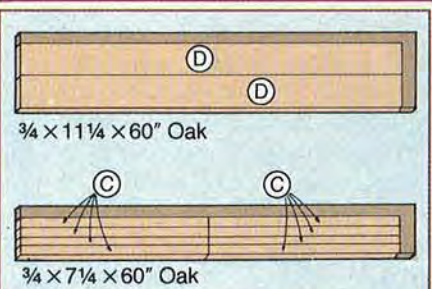

**Cutting Diagram**

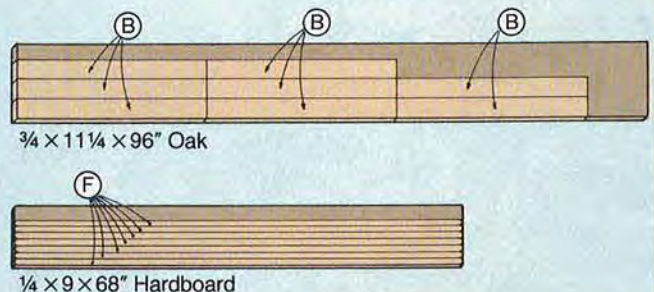
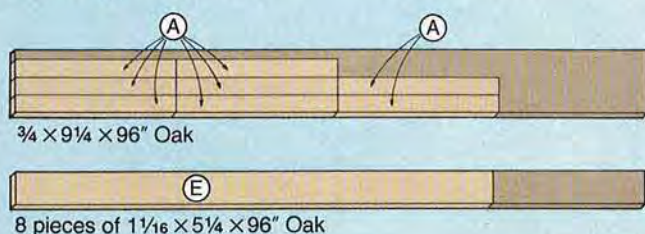

## TRESTLE TABLE

**3** Using the Foot Grid Drawing at *right*, make a paper template for the side profile. To do this, start by cutting a piece of paper to  $3 \times 14$ ", and draw a 1" grid on the paper. Now, lay out the shape of half of one foot on the marked grid. Mark the points where the foot-pattern outline crosses each grid line. Then, draw lines to connect the points. Cut the paper template to shape.

**4** Find and mark a centerline across each foot lamination (see the Foot Grid Drawing for reference). Position the inside edge of the paper template against the marked centerline, with the bottom edge of the template flush with the flat, bottom edge of the lamination. Carefully trace the foot outline onto each foot lamination. (You'll need to trace the half template twice to mark each complete foot.)

**5** As shown in photo A at *right*, cut each foot to shape on a bandsaw fitted with a  $\frac{1}{4}$ " or larger blade. To ensure a level-sitting table, do not cut the three flat areas of the foot (see the Foot Grid Drawing for reference). Finally, use a radialsaw or tablesaw and cross-cut both ends of each foot square for a 28" finished length.

**6** To make the table supports (C), cut eight pieces of  $\frac{3}{4}$ " oak to  $1\frac{5}{8}$ " wide by 29" long. Glue and clamp four pieces together face to face for each support. Later, scrape off the excess glue and plane  $\frac{1}{16}$ " off each edge for a  $1\frac{1}{2}$ "-finished width.

**7** Using the procedure described in steps 3, 4, and 5 *above*, make a  $2 \times 14$ " paper template, cut the template to shape, and align with the top, flat edge of the lamination. Trace its outline onto each lamination. Now, cut the supports to shape on the bandsaw.

**8** Sand the edges on all the pieces smooth to remove saw marks.

### AND NOW, FOR THE STRETCHER RAIL

**1** Cut two pieces of  $\frac{3}{4}$ "-thick oak to  $5\frac{1}{8}$ " wide by 58" long for the stretcher rail (D). Glue and clamp the pieces together face to face, with the edges and ends flush.

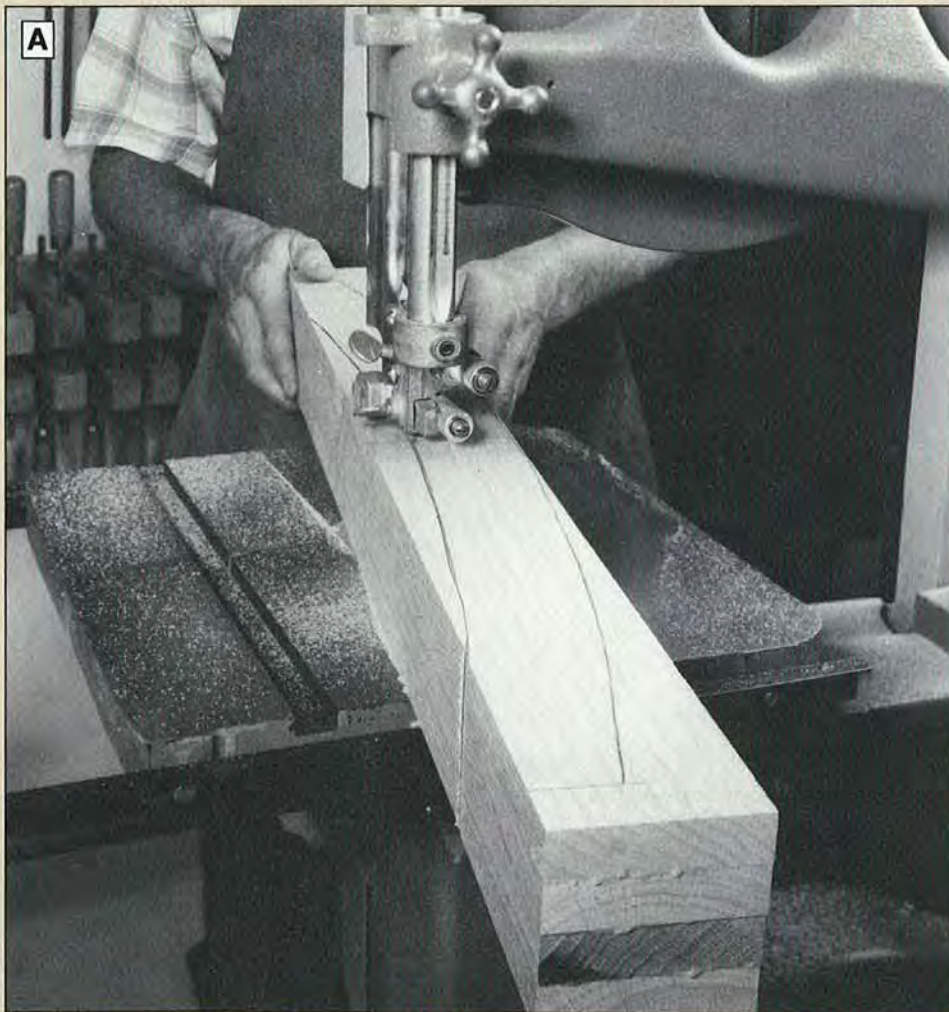
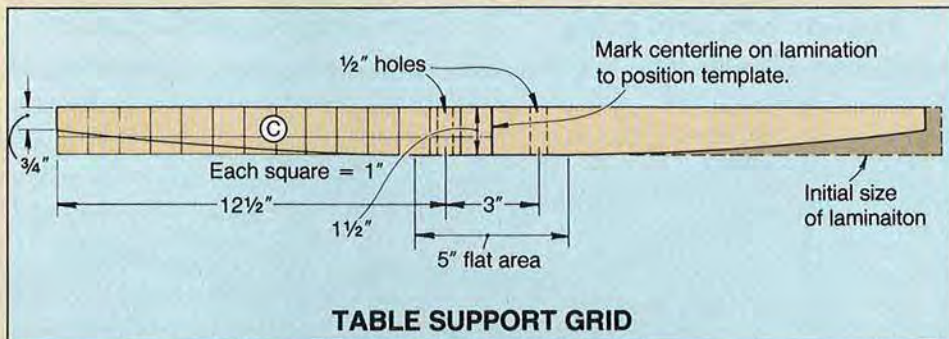
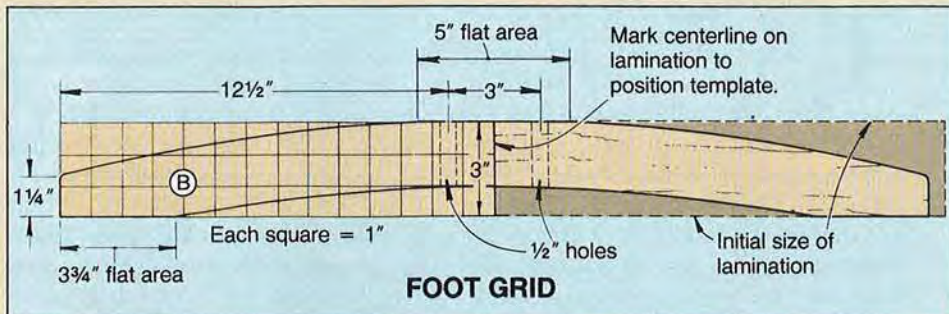

Trace the template outline onto the foot lamination, and then cut the foot to shape on the bandsaw. Later, trim the ends square on a radialsaw.

**2** Later, remove the clamps and scrape off the excess glue. Plane  $\frac{1}{16}$ " off both edges to ensure flatness, and then trim the ends for a 57" finished length.

**3** Rout  $\frac{3}{16}$ " chamfers along all edges and ends of the stretcher rail.

### NEXT, LAMINATE THE TABLETOP

**1** Rip and crosscut eight pieces of  $\frac{1}{4}$ "-thick oak (five-quarter stock) to  $4\frac{5}{8}$ " wide by 73" long for the tabletop (E). Plane  $\frac{1}{16}$ " off each edge to remove the saw marks and to ensure even joints when laminating.

**2** Position the pieces, best side up, on a work surface. Arrange the pieces for the best grain pattern, and number them one through eight for ease of assembly later.

**3** Chuck a  $\frac{1}{4}$ " slot-cutting bit into your router. Rout a  $\frac{1}{4}$ " slot  $\frac{1}{2}$ " deep, centered from top to bottom, along mating edges of the tabletop pieces. Stop the slots  $2\frac{1}{2}$ " from each end.

**4** Cut seven splines (F) to size from  $\frac{1}{4}$ " hardboard. Sand the spline ends to a tapered shape. With the splines in place, dry-clamp the first

four pieces of the tabletop together to check for tight-fitting joints. Repeat with the other four pieces for the other tabletop half.

**5** Glue, spline, and clamp the first four pieces together, keeping the edges, ends, and surfaces flat. Repeat with the second four pieces. Later, glue, spline, and clamp the two tabletop halves together as shown in photo B below.

**6** Remove the clamps and scrape off the excess glue. Crosscut each end for a finished length of 72". (To minimize chipping the good face of the tabletop, we placed it upside down on saw horses. Then, we clamped a straightedge square with the sides, and trimmed  $\frac{1}{2}$ " off each end with a portable circular saw fitted with a carbide-tipped blade.) Belt-sand the tabletop.

### ROUT THE CHAMFERS

**1** Using the Upright Drawing as a guide, mark chamfer start-and-stop lines across each upright (A). Then, rout  $\frac{3}{8}$ " chamfers between the marked lines. (When routing the chamfers, we wore a full-face shield. The shield allowed us to

keep a close look at the rotating bit for starting and stopping at the marked lines.)

**2** Now, rout a  $\frac{3}{16}$ " chamfer on top and bottom edges of the tabletop.

**3** Using a palm or finish sander, finish-sand the tabletop and uprights. Then, finish-sand the remaining pieces.

### ASSEMBLE THE BASE

**1** To attach the uprights to the stretcher, start by building a pair of supports to the size shown in the drawing below. (We found the jigs extremely helpful in holding the stretcher rail in position when clamping it between the uprights.)

**2** Measure in  $\frac{1}{2}$ " from each end of the stretcher rail, and mark a line across both sides of each end (four

*Continued*

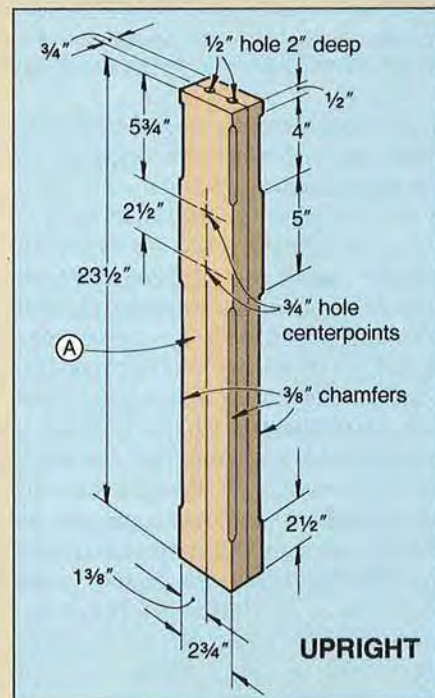
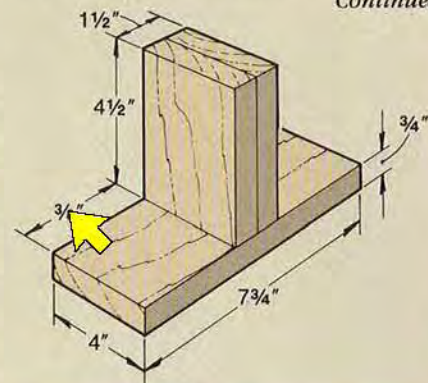

Glue, spline, and clamp the two tabletop halves together, clamping long scrap pieces to the top and bottom to ensure flatness.

## TRESTLE TABLE

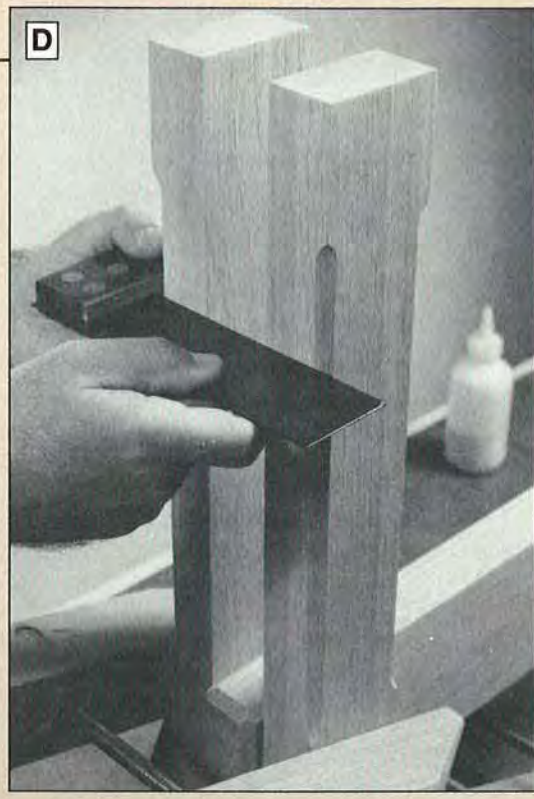

Position and clamp the uprights and stretcher on a support jig. With a framing square, check that both uprights are square with the stretcher.

Use a small square to check that the uprights are square and parallel.

lines in all). The lines will help you align the rail with the uprights in the next step.

**3** Apply glue to the mating surfaces, and position the stretcher rail on the two support jigs and between the two uprights as shown *above* in photo C. With the stretcher rail protruding  $\frac{1}{2}$ " beyond the outside edge of the uprights (use the lines drawn in the previous step for this), clamp the stretcher rail in place. Check that the stretcher is square with the uprights as shown in photo C. Also make sure that the uprights are square with each other as shown in photo D. Immediately wipe off any excess glue dry, and then repeat the pro-

cedure on the opposite end with the two remaining uprights.

**4** Locate and mark the center-points of the two  $\frac{3}{4}$ " holes on each upright (see the Upright Drawing for location). As shown in photo E, clamp the stretcher rail-upright assembly to your workbench, and clamp a scrap block onto the bottom face of the lower upright where shown in the photo. (The scrap block helps prevent chip-out when boring through the bottom upright.) Bore a pair of  $\frac{3}{4}$ " holes where marked through the uprights and stretcher. Repeat this procedure for the other end.

**5** Cut four 5" lengths of  $\frac{3}{4}$ " oak dowel. Chamfer each end of each dowel (we used a belt sander). Ap-

ply glue in the  $\frac{3}{4}$ " holes in the stretcher-upright joint, and drive the dowels in place with a rubber mallet so  $\frac{1}{4}$ " of dowel protrudes from each surface. Immediately wipe off any excess glue.

**6** As shown in photo F, position the base upside down and resting on the supports. Position the flat, center portion of a foot on the ends of the uprights and clamp the assembly to your workbench.

**7** Use a square to transfer each upright joint line (the glue line between the two individual pieces that form each upright) up the outside face and across the bottom of the foot. (The line is just to the right of the clamp in photo F.) Next, transfer the second line



**E** Mark the centerpoints and bore a pair of  $\frac{3}{4}$ " holes through the upright-stretcher rail assembly, backing the stock to prevent chip-out.

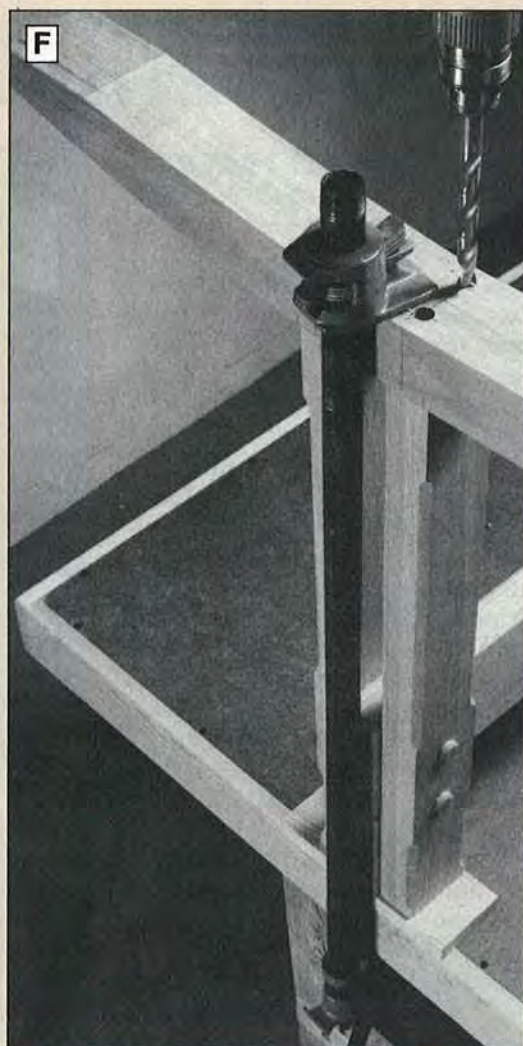

**F** Clamp the foot to the uprights. Mark the centerpoints, and bore the holes for the dowels.

across the bottom of the foot. Mark centerpoints at the first and third glue line on the bottom of the foot. Bore four  $\frac{1}{2}$ " holes through the foot and  $1\frac{1}{2}$ " deep into the upright. Repeat the marking and boring procedure with the other foot.

**8** Cut eight pieces of  $\frac{1}{2}$ " dowel to  $3\frac{1}{2}$ " long. Sand a chamfer on one end of each dowel.

**9** One at a time, clamp a dowel in a bench vise, and cut a  $\frac{1}{8}$ "-deep glue groove (kerf) the length of the dowel. (We used a dovetail saw to cut each kerf.)

**10** Spread glue in the dowel holes, and glue and drive the dowels through the bottom of the feet and into the uprights. Drive the dowels until the bottom of the dowels are

flush with the bottom surface of the feet. Trim or sand any protruding dowels flush if necessary. Repeat for the other foot on the opposite end.

**11** Use the process just described in steps 5, 6, and 7 to join the oak table supports to the top ends of the uprights.

#### APPLY THE FINISH

**1** Apply the stain of your choice. Apply two coats of polyurethane sanding sealer to all surfaces (including the bottom of the tabletop), sanding with 320-grit paper between coats.

**2** Apply two coats of clear polyurethane. (We used satin polyurethane. After the final coat dried, we

applied paste furniture wax to 0000 steel wool, and rubbed the surface down for a smooth finish.)

#### ASSEMBLE THE TABLE

**1** Lay the tabletop facedown on a blanket. Center the base, also upside down, on the bottom of the tabletop. Being careful not to drill too deep, drill a  $\frac{3}{16}$ " shank hole through the table support, and a  $\frac{1}{8}$ " pilot hole  $\frac{3}{4}$ " deep into the bottom side of the tabletop, where located on the Exploded-View Drawing. Fasten the base to the tabletop with  $\#10 \times 1\frac{3}{4}$ " wood screws. 

Produced by Marlen Kemmet. Project Design: James Downing. Photographs: Hopkins Associates; Bob Calmer. Illustrations: Kim Downing; Bill Zaun

# DON'T LEAVE FORM TO CHANCE! A SUREFIRE TECHNIQUE FOR

Frustrated from figuring out what your bowl should look like? Here's help.

Dale Nish, the well-known woodturner, author, and educator from Provo, Utah, says that "You could paint a good-looking, turned bowl black, and it would still be attractive." According to Dale, that's because a bowl's form should be appealing enough to stand by itself, yet display the wood to its maximum potential. But, coming up with great-looking bowl shapes that meet this standard perplexes even the best woodturners.

"I once attended a woodturning seminar taught by Bob Stockdale," Dale notes, "and someone asked him, 'Where do you get your ideas for shapes?' He said, 'I checked out a book on oriental porcelain from the library one time, and found out they had been copying me for 2,000 years!'"

That tongue-in-cheek reply actually was sound advice (see sidebar, *right*, for design tips from the experts). Pleasing-to-the-eye pottery shapes show up in civilization after civilization throughout history. And, most all can be adapted from the potter's wheel to the lathe. But, unlike a potter, who has the luxury of shaping and reshaping as long as the clay remains wet, a woodturner seldom can change his mind. In bowlturning, advance planning becomes all-important.

## GOOD BOWL DESIGN BEGINS WITH PROPORTION

Some people possess a natural eye for shape and proportion. If you don't, there's plenty of hope. That's because—believe it or not—you can mathematically calculate pleasing-to-the-eye proportions.

The ancient Greeks perfected the "Golden Mean," a formula that utilizes the ratio 1:1.618 to find the

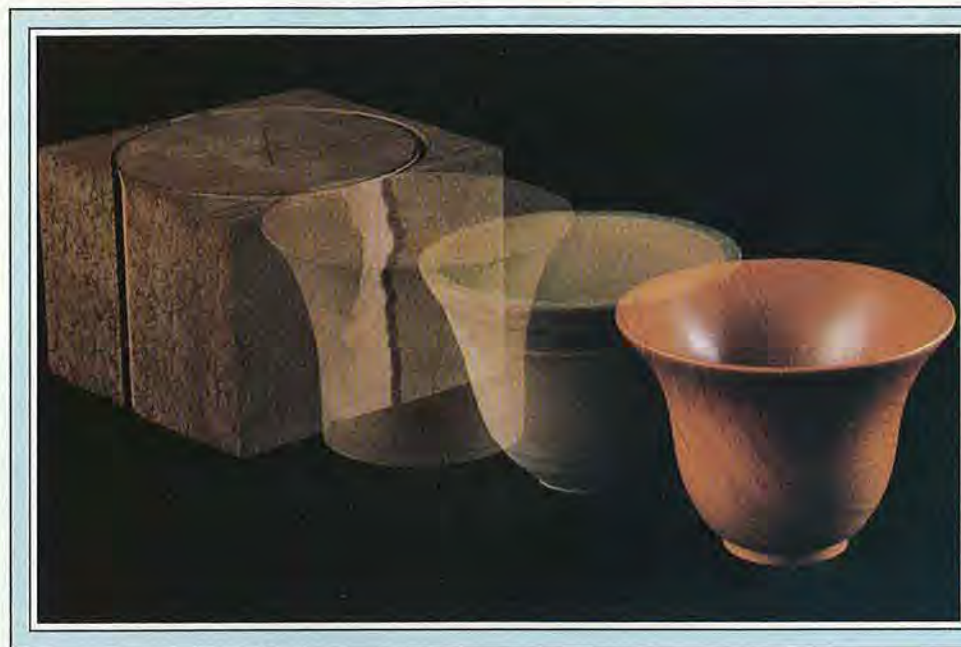

length of the long side in relation to the short side of a rectangle. Furnituremakers have long relied on the formula.

But how does the Golden Mean help in bowlturning? With it, you can figure out such troublesome relationships as the diameter of the rim to the height of the bowl or the base diameter to the height.

Here's an example: Let's say you have a bowl blank 4" thick and 8" square. You know the height cannot exceed 4", but to what diameter should you turn the bowl to maintain a pleasing proportion? Simply multiply  $4 \times 1.618$  to find the diameter, which, in this case, equals about 6½". For the diameter of the base, *divide* the 4" bowl height by 1.618. The result: about 2½" (see drawing, *above right*).

These dimensions give you a beginning for a bowl with proportionate dimensions, at least as preferred by the ancient Greeks. With the technique shown on the following pages, you'll be able to draw from an inventory of curves that open endless choices of form.

## DESIGN TIPS FROM

Noted woodturners/authors Richard Raffan, from Australia, and Dale Nish, from Provo, Utah, teach novice turners. Here's their advice on bowl form:

**Q** *What are the most common mistakes a beginning turner makes with form?*

**A** Raffan: Novice turners try to be too complicated when it pays to be as simple as possible. I made a great leap forward when I decided that I was getting too involved with reverse curves and such. When I started to do simple curves, I began to appreciate form. Beginners jump ahead too fast. They become so pleased with all the shapes gotten so quickly that they tend to make more use of the technique than the design.

**A** Nish: Most beginning turners make the foot for the base of a bowl too large. The base, or the foot, diameter doesn't have to be



# PLEASING BOWL DESIGN

## PROPORTIONING A BOWL WITH THE GOLDEN MEAN

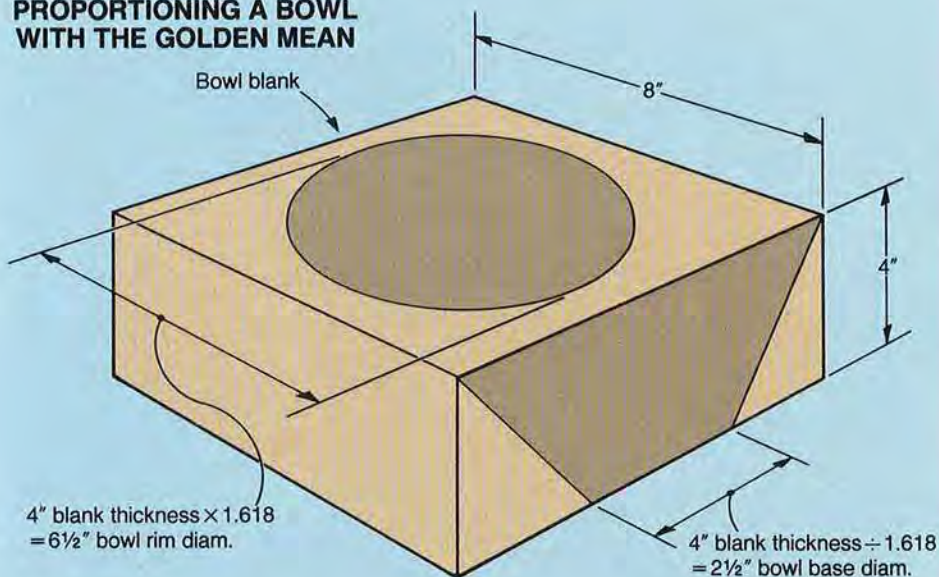

## HOW TO DESIGN WITH A CHAIN

Proportioning a bowl's dimensions with the Golden Mean gives you the rough outline for your bowl-to-be. To find out the next step—how to come up with an attractive form—we called on Nancy Briggs, an experienced potter, artist, and photo stylist, who helps with project photography in *WOOD*® magazine's studio.

On the potter's wheel, Nancy has fashioned thousands of bowls, vases, cups, mugs, and platters. Form comes quite naturally to her. But, explaining how to create good form was another matter. Even after hours of research on the subject, Nancy could only report, "Nothing concrete." Then, we got our heads together and went over all the types of curves and arcs you'll find in bowls. What architects call a "catenary" intrigued us.

## TWO TOP TURNERS

any more than one-quarter to one-third of the bowl's maximum diameter. If it's a functional piece, the base can go to half the maximum diameter. That gives it stability.

**Q** Should beginners avoid some types of forms?

**A** Raffan: Go for open shapes. They're much, much easier to turn. It's far more difficult to create a tight curve that comes up and out from the base, then back in again, than an outflowing curve.

Study ceramics, especially Japanese pottery. The forms won't always be symmetrical, but you'll gain a sense of proportion. Remember, forms are pretty universal. You just learn to adapt.

**A** Nish: Find a good shape and copy it! You'll be better off than to try and invent a new one. Seriously, though, forms are timeless. Look at pottery through the centuries, read books on art history,

check out what others are doing. But, I do have some rules of thumb regarding form.

A good piece should feel as it looks—that is, its appearance should reflect its actual weight. For instance, a sturdy-looking bowl should have heft. And, visually, the maximum diameter of a turned bowl should never be in the center. It should divide a bowl horizontally into 2/5, 3/5 or 1/3, 2/3.

Another rule: The more colorful the wood, the more exciting the form you need to show it off. However, that doesn't mean someone should neglect form altogether and rely on only the wood to make the bowl attractive. A good-looking bowl has to have the right balance.

**For more information on form, read, *Turned-Bowl Design*, by Richard Raffan, 1987, The Taunton Press, Inc., 63 S. Main St., Newtown, CT 06470, \$17 ppd.**



Bowl profile drawn with the aid of a hanging chain. Mahogany, 5¼ × 4".

Imagine a jewelry chain hanging freely around the neck. That's a catenary curve. Without tension, the chain forms a flowing, natural contour "perfect for the shape of a bowl," Nancy declared. She then offered to work on some variations.

Later, Nancy brought in a simple-to-do technique for designing bowl shapes. "It offers so many great possibilities that I plan to use it in designing some of my own work in

*Continued*

# SUREFIRE BOWL DESIGN

clay," she said. "Besides, it's easy as well as fun to do."

Begin by finding your bowl's basic proportions with the principle of the Golden Mean. Then, draw its full-sized, rough outline on a piece of paper. Now, tape a large piece of cardboard to a wall and fasten an 18-22" length of neck chain to it with a straight pin at both ends. The chain should drape without any tension.

To find a pleasing form for your bowl, slip the paper with the bowl outline behind the draped chain, then move the paper around. Change the shape of the chain's curve by repinning the ends. Try dipping the loop below the bowl's base outline and raising it above. The loop formed by the chain doesn't have to meet the base of your bowl. Experiment! Even turn

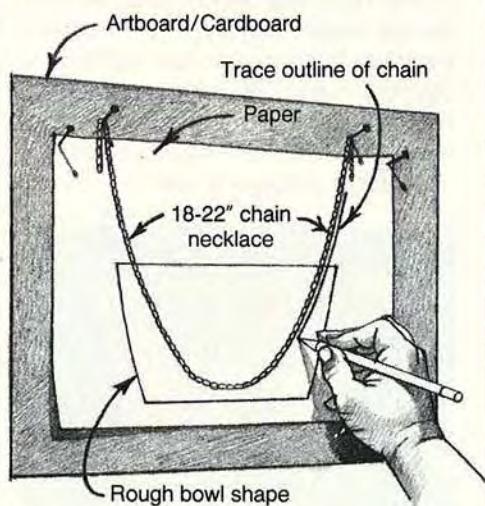

your paper upside down to get convex shapes or tilt it to combine curves for more complex profiles.

When you've found the form you want to pursue, tape or pin the paper to the cardboard and track the chain's outline on your pattern with pinpricks through the links. Join the dots later with a continuous pencil line.

Nancy says that designing with this method not only sharpens your eye for form, but it's fun. The 13 different bowl profiles on these pages represent only a portion of the many she uncovered. 🌲

## A BAKER'S DOZEN BOWL SHAPES

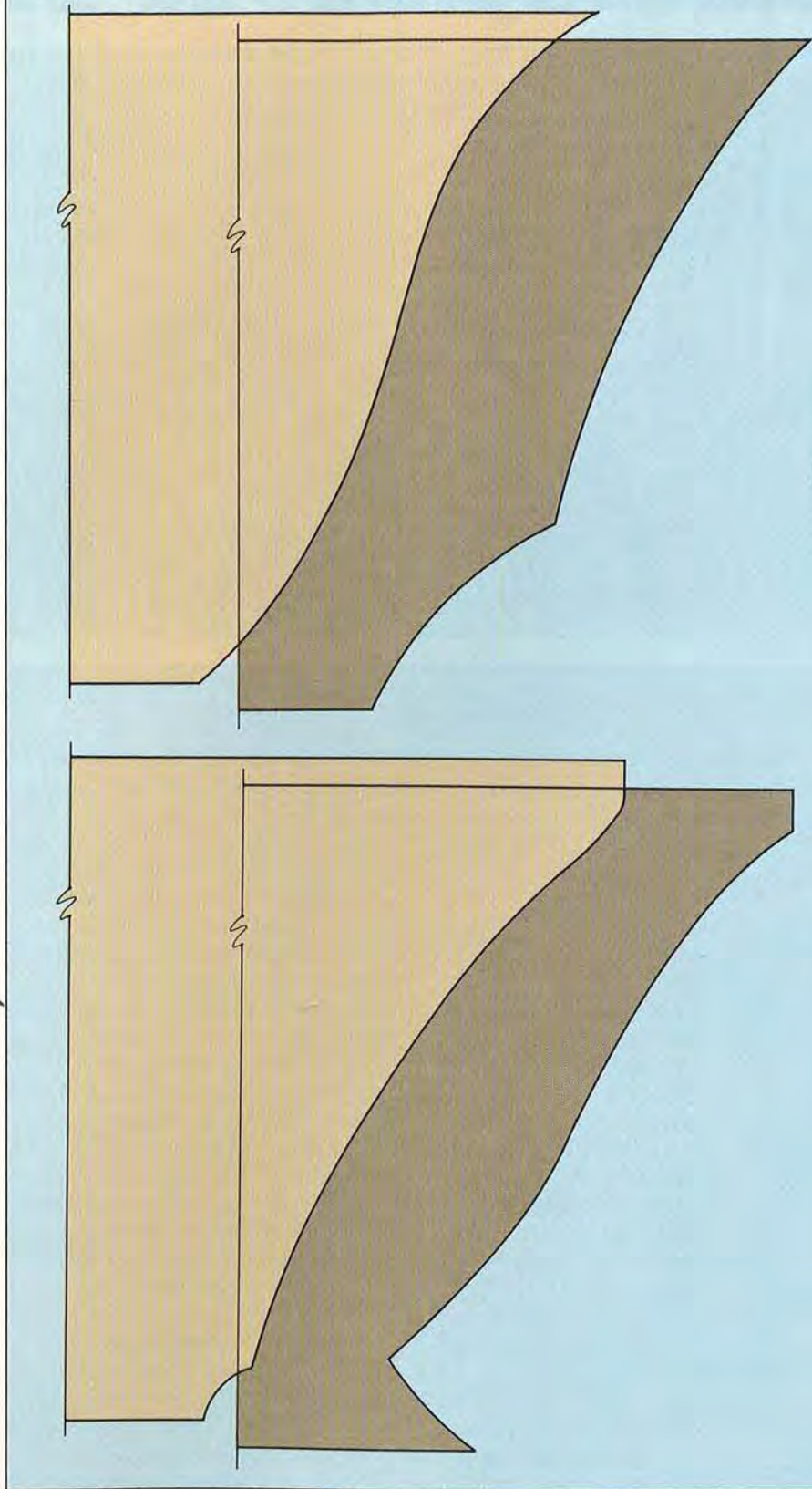

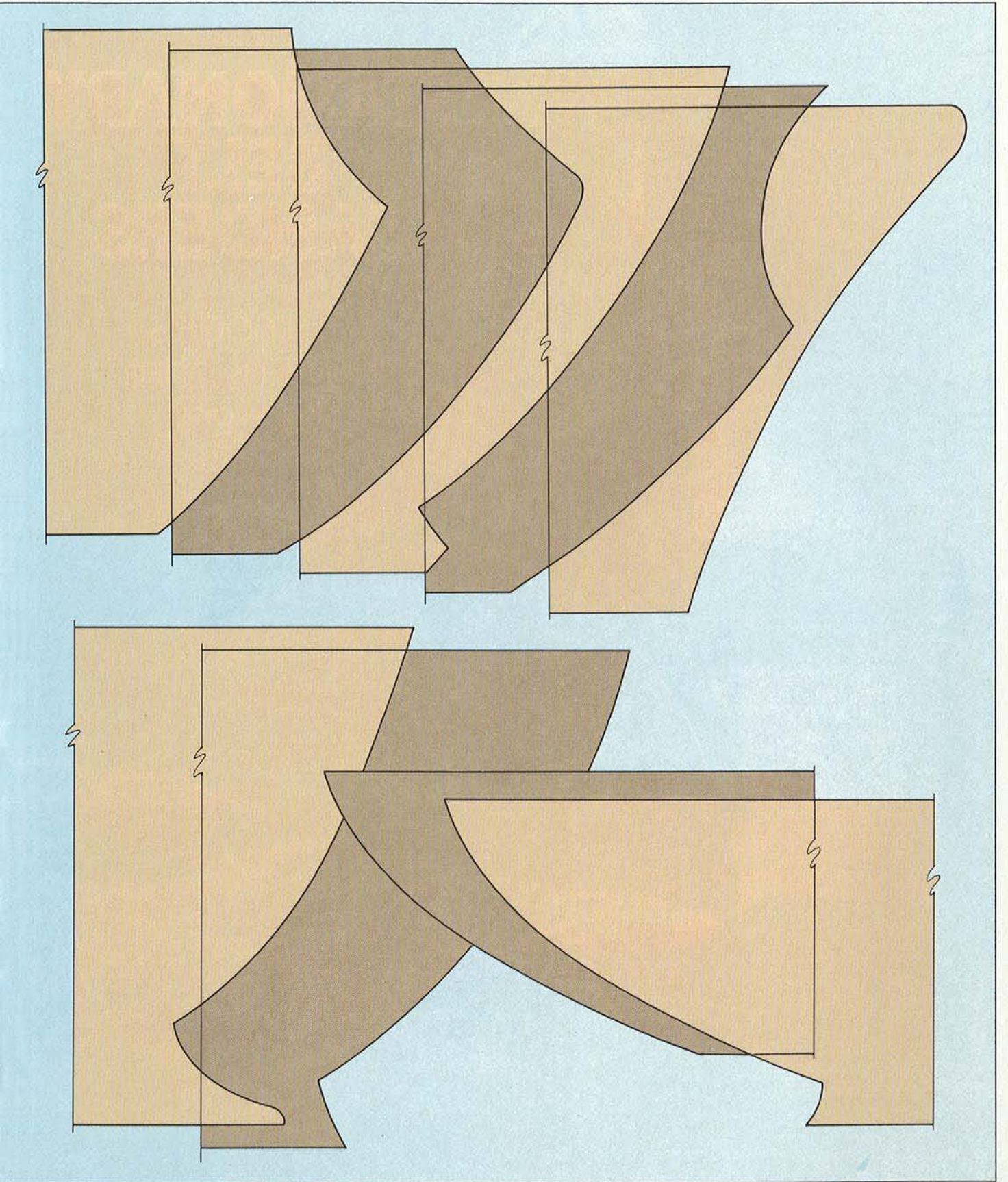

Photographs, Bob Calmer; Illustrations: Jim Stevenson; Mike Henry

# STATIONARY BELT SANDERS

14 models  
show us their  
true grit

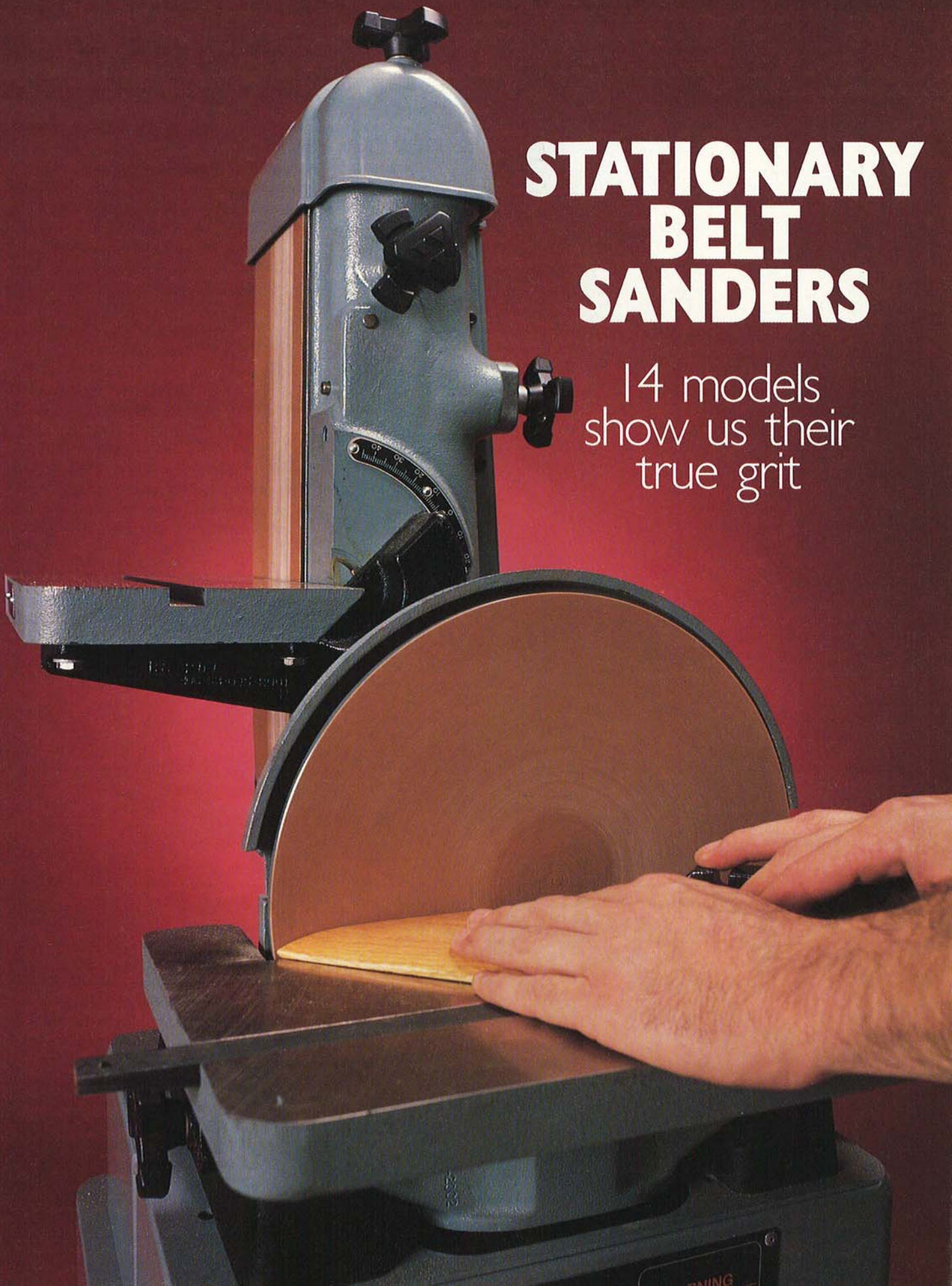

If you think all stationary belt sanders consist of an endless sanding belt and disc, you're right. Sort of. Today, however, you can spend as little as \$250 or more than \$1,000 for machines that, at first glance, appear to do the same work. But do they? In this article, we'll answer that question and examine some interesting edge, strip, and benchtop sanders.

 Print this article

A stationary belt sander may be the simplest woodworking machine you'll ever own. Basically, all of them consist of a sanding belt (6×48" on most machines) backed by a flat surface called a platen, and two rollers that move the belt (one turning freely and one powered by a motor). They also have one or two work tables that give you a solid surface to steady your workpiece as you sand it. Thanks to the large surface area of their belts, these machines remove a lot of stock quickly, and one belt may last you months if you're a light user. Although simple in their operation and construction, we found big differences in the design, purpose, and features of the machines we tried out.

### WHAT TYPE OF SANDER IS RIGHT FOR YOUR SHOP?

No matter what size or type of projects you take on, there's a machine suited to your needs. As shown below, sanding machines work in five different modes: disc sander, vertical and horizontal belts, edge sander, and strip sander. Since most machines combine two or three of these functions, the key to choos-

ing the right machine lies in determining the modes you need and finding a machine at an affordable price with a combination of your desired modes.

Strip sanders resemble vertical belt sanders, but the belt never exceeds 1" in width. Except for the edge sander, most sanding machines will have a disc sander in combination with the belt.

For example, the Grizzly model



A locking lever atop the Grizzly model G1531 edge sander loosens the tension on the belt in a snap. Elevating tables help you use the belt's full surface.

G1531 edge sander shown at left, doesn't have a disc, but does have a table that wraps around one roller for half-drum sanding of concave edges. Also, a crank elevates the work table, allowing you to use the full width of the belt without piling boards under your workpiece.

If a disc and vertical/horizontal belt combination fits your needs, then you're in luck, because more sanders sell in this combination than any other. Two widely available types in this combo, the Lobo model SD-0069 and Jet model JSG-96 shown on page 68, have vertical and horizontal positive stops for the platen. You also can lock either machine at some in-between point, such as 45°, as we did with the Lobo pictured. Sears sells a machine nearly identical to the Jet unit, while Black & Decker markets an improved version of this Taiwanese machine. We'll fill you in on the key differences between these sanders later.

On the other hand, you may need a machine with a belt that flips from horizontal to edge sanding, such as the Foley-Belsaw model 4130901 or Total Shop model

*Continued*

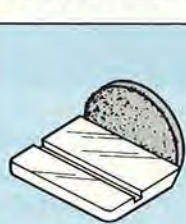

#### DISC SANDER

- USES:**
- Touching up miter joints
  - Working small parts
  - Chamfering dowel ends
  - Sanding a perfectly flat surface

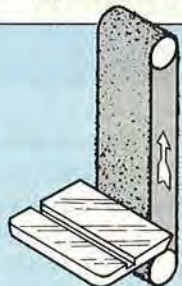

#### VERTICAL BELT

- USES:**
- Rapid removal of material
  - Sanding back to a line
  - Touching up miters and compound angles
  - Short edge sanding



#### HORIZONTAL BELT

- USES:**
- Sanding face grain stock with stop removed
  - Hand-held sanding of irregular stock

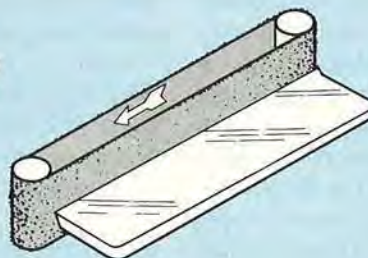

#### EDGE SANDER

- USES:**
- Smoothing and straightening long edges
  - Concave sanding on the open roller
  - Edge sanding of flat stock with convex curves

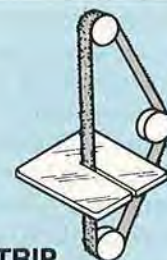

#### STRIP SANDER

- USES:**
- Metal sharpening
  - Sanding tight and inside areas (belt must be removed and looped through inside areas)

# STATIONARY BELT SANDERS



▲ The Foley-Belsaw 6×89" model 4130901 on the left and its near-twin, the Total Shop 6×48" model 943 on the right, operate as horizontal or edge sanders. Both units have the miter gauge shown on the Foley-Belsaw and the fence mounted on the Total Shop.

943 shown above. Although different in size—the Foley-Belsaw unit has a 6×89" belt and the Total Shop model has a 6×48" belt—the machines have nearly identical construction. These models, as well as other edge sanders on the market, do not have sanding discs.

If all these machines seem too large or expensive for your shop, you can buy a benchtop sander such as those shown top right. These versatile performers will help you prepare small projects, such as toys, or shape tiny parts for models or carvings. On the other hand, they don't have the belt capacity or power to handle larger projects, such as cabinets. You'll find strip sanders only in benchtop machines, and these handy machines will do jobs belt sanders can't, such as metal sharpening and sanding of narrow areas inaccessible to larger sanders. Delta's model 31-050 strip-sanders and accepts optional flexible-shaft attachments for cutting, grinding, and sanding.

The discs on benchtop sanders range from 5" to 8" in diameter. Although you can buy industrial-size disc sanders larger than 12", the

discs on stationary belt/disc sanders for the home shop range from 9" to 12" in diameter. When you're considering the disc size of a sander, remember that you can only use half of a disc for sanding. In other words, a 12" disc yields 6" of sanding surface. A benchtop sander will yield only 2½–4" of usable disc surface.

## DUST COLLECTION: A MUST IN OUR BOOK

No woodworking machine throws off more fine sawdust than a stationary belt sander. Nevertheless, we came across several machines without dust collection capability, such as the Lobo unit shown above (check the chart on page 63 for a listing). We found the Grizzly model G1183, shown on the next page to be a well-made and user-friendly machine, but the omission of a dust-collection port disappointed us. However, as an example of how



▲ These benchtop machines serve the small-project maker. From left: Delta model 31-050 strip sander, AMT model 4150 strip/disc sander, and the Delta model 31-460 belt/disc sander.

▼ The Lobo model SD-0069 on the left appears similar to the Jet model JSG-96 on the right, but the Lobo lacks a dust collection port and has a lightweight aluminum work table.



different importers modify similar Taiwanese machines, Jet sells a nearly identical version of this machine with a dust collection port.

Although we applaud all sanding machines with dust collection capability, it's easier to sand long stock on some machines because of better-positioned dust ports. For example, although the dust ports on most of the machines we tested stayed well out of our way when sanding long stock, the ports on other machines jut above the sanding surface. Both the Foley-Belsaw

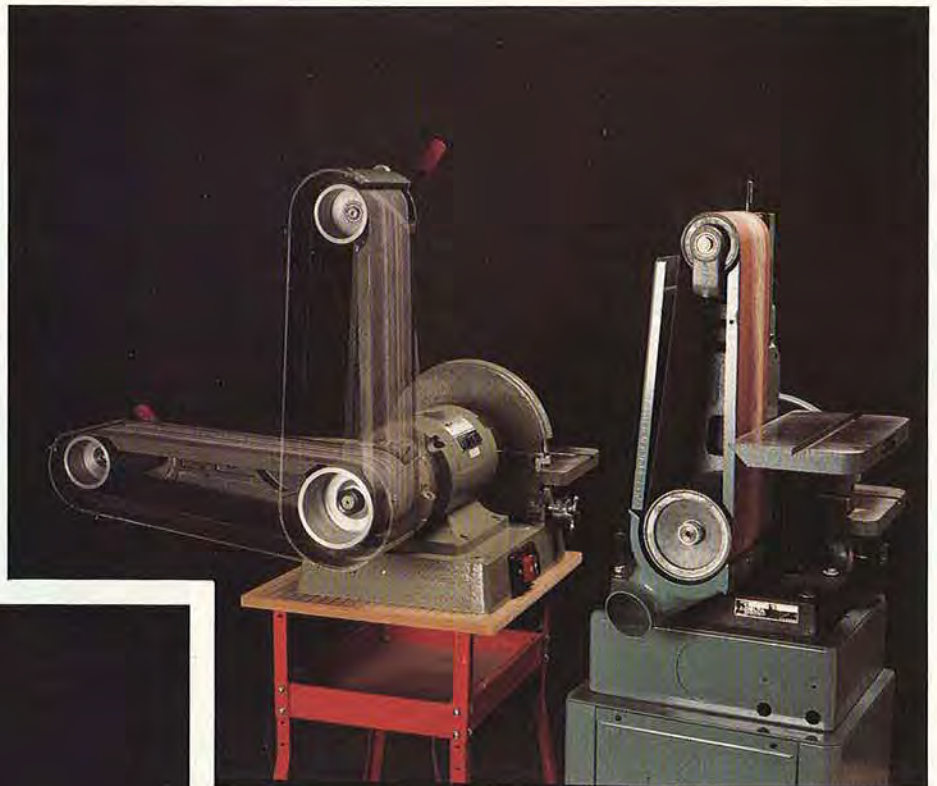
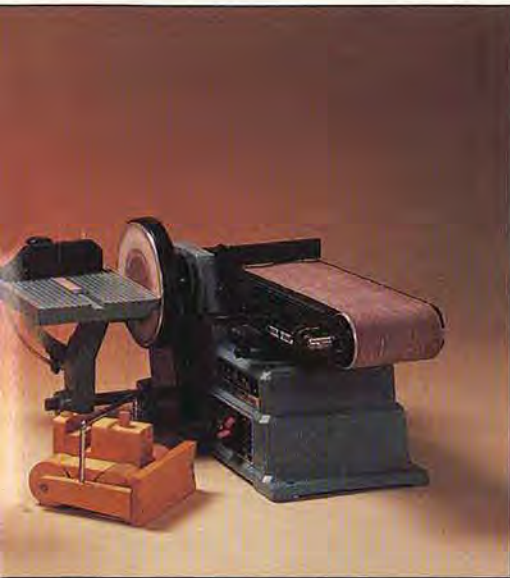

▲ We removed the belt guards for an inside look at the Grizzly model G1183 on the left, and Delta model 31-730. Our inspection revealed a more-sturdily mounted upper roller on the Delta.

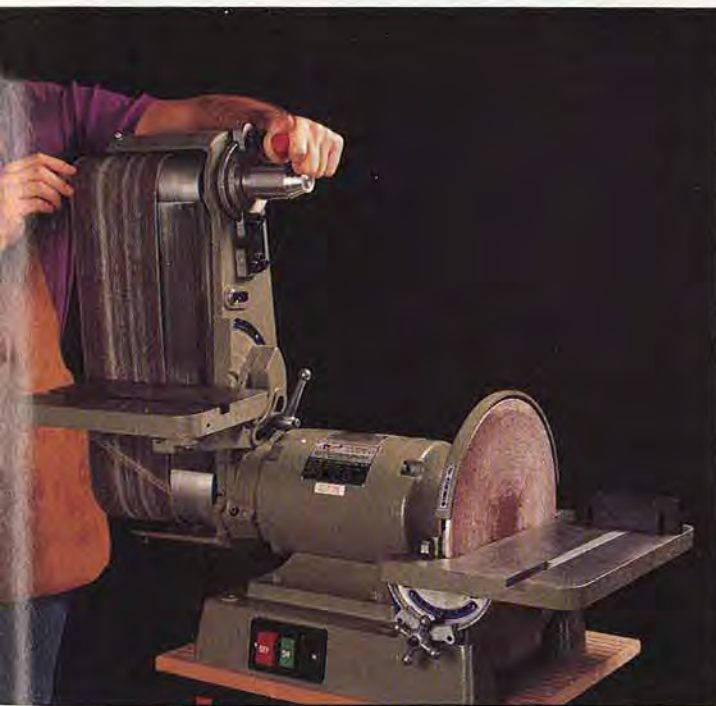

◀ After removing the belt guard on the Grizzly model G1183, you only need to push a lever to relax the belt for removal. However, the lever doesn't lock in the loosened position.

changing belts and adjusting belt tracking. The two with the same system, the Foley-Belsaw and Total Shop models, received high marks in this area, along with the DeWalt model

or right while it's turning. When properly adjusted, the belt will move neither left nor right, staying on the center of the rollers as the machine sands.

Both of the Grizzly machines make this operation a breeze, because you only twist one knob to quickly make a tracking adjustment. For the Foley-Belsaw and Total Shop sanders, you must insert a special ground-down screwdriver into the tracking knob and turn it to make the adjustment. That sounds easy, but we think many woodworkers could easily misplace the screwdriver-like device.

Our study of these tracking mechanisms revealed something about the reasons why similar-looking sanders can be hundreds of dollars apart in price. As shown in the photo above of the Grizzly model G1183 and Delta model 31-730, the less-expensive Grizzly has an upper

and Total Shop edge sanders on the previous page fall into this group. We asked Tom Stratton of Foley-Belsaw why, and he said his company will explore the possibility of lowering the dustport. "We're looking into it, but we want to be certain we can maintain good dust removal while lowering the port," he said.

### BELT ADJUSTMENTS: THEY SHOULDN'T BE A CHORE

Of the 14 machines we looked at, we found 13 different methods for

1765 shown on the next page, and the Grizzly models G1183 and G1531. With these machines, you can change belts by simply pushing a tension-release lever.

However, both the Jet and Lobo units require you to completely loosen the tracking adjustment controls to release the belt. In addition, you must remove a screw from Jet's dust collection port before replacing the belt.

For any sander, the tracking adjustment works by tilting one drum so the belt either moves to the left

*Continued*

## STATIONARY BELT SANDERS



You can release, tilt, and lock the tables on the Powermatic 30B by turning one large knob on each end of the tables.

roller supported on only one end, while a cast-iron yoke on the Delta machine supports the roller on both ends. This extra support makes the Delta roller less prone to continual tracking adjustments.

### PLATENS AND TABLES: CONVENIENCE COUNTS

For both platens and tables, we appreciate those that pivot with little effort, lock into place easily, and stay in place once secured. Although it's not inexpensive at \$1,049 list, the Powermatic 30B sander shown *above* has the kind of platen and table-tilting mechanisms that make the machine a pleasure to use. An easy twist of one large knob locks or loosens the tables, and the platen moves after an easy tug on one knob with positive stops at 0°, 45°, and 90°.

The Powermatic machine also has perfectly flat cast-iron tables and platens—another quality we like. On any sander, cast iron provides a surface that's less prone to flexing and denting than stamped steel or aluminum.

Before you buy a sanding machine, make certain that the platen rises above the rollers. Under the reverse situation, when the rollers sit above the platen, you will not

be able to sand a flat surface on stock that's longer than the platen because the rollers will create a hump in the workpiece. We discovered this problem on the Total Shop unit, so we asked Wayne Preston of Total Shop about it. "We recognized that problem on some of the first units we received, and it's been corrected—the platen is above the rollers on all the units we're shipping now," he said.

### SOME FINAL THOUGHTS

If you can afford them, machines such as the Delta 31-730 and Powermatic 30B have every desirable quality you can ask for in a stationary belt sander. As you move down in price among these machines, you'll find fewer and fewer conveniences. For instance, the Lobo machine has few convenience features, but it's also the only 6×48" machine available for under \$300.

We feel that the DeWalt model shown *above right* strikes the best balance between price and features of the sanders we tested. Although the Black & Decker-backed DeWalt machine lists for \$88 more than the similar Jet sander, the extra money seems well worth it. Here's why. Black & Decker started with basi-



Convenience features and an edge-sanding fence make the DeWalt model 1765 stand out from the crowd.

cally the same sanding machine as the Jet, but they made a number of modifications that eliminated most of the drawbacks of the Jet unit. For instance, the Black & Decker sander has a handy edge-sanding fence, one-knob tracking control, and a tension-release lever.

Whatever machine catches your fancy, follow these words of advice:

- Don't buy a machine without dust collection or flat, sturdy platens and tables.
- If you have the opportunity, test any machine before buying it.
- Don't buy a stationary belt sander that stalls when you apply firm pressure to the workpiece.
- If you change belts frequently, consider the amount of work needed to remove and adjust the belt before you purchase any machine.
- Stay away from any sander without a totally enclosed-fan cooled motor. Sanders throw off a lot of dust, and any open motor may become damaged from that dust.

*Note: For information on buying and caring for abrasive belts, see the article on page 76.*

Written by Bill Krier  
Technical Consultant: George Granseth  
Photographs: Jim Kascoutas  
Illustrations: Mike Henry



# STATIONARY BELT SANDERS: LET'S GET TO THE NITTY-GRITTY

MANUFACTURER	MODEL	BELT SIZE (WIDTH X LENGTH, INCHES)			DISC SIZE (DIAMETER IN INCHES)	TYPE <sup>1</sup>	MOTOR				BELT ADJUSTMENTS				TABLE MATERIAL				WEIGHT (LBS.)	SUGGESTED PRICE <sup>2</sup>
		WIDTH	LENGTH	TYPE			RPM	AMPS	VOLTS	TYPE <sup>3</sup>	FEET PER MINUTE (BELT)	TRACKING <sup>4</sup>	REMOVAL <sup>5</sup>	LOCKING TENSION RELEASE (Y/N)	PLATEN MATERIAL <sup>6</sup>	BELTS	DISC <sup>6</sup>	DUST COLLECTION (Y/N)		
AMT*	4150	1x42	8	S		MOTOR NOT INCLUDED <sup>2</sup>				K	B/G	N	S	S	CI	N	T	45	88	
Delta	31-050	1x30	None	S	3450	2	120	T	3150	K	K/G	N	S	A	None	Y	T	13	93	
Delta	31-460	4x36	6	V/H	3450	4	120	T	2000	K	S/G	Y	S	A	A	Y	T	42	173	
Delta	31-730** 52-612	6x48	12	V/H	3450	20/10	115/230	T	3030	K	K/G	Y	CI	CI	CI	Y	U	288	1651	
DeWalt (Black & Decker)	1765	6x48	10	V/H	3450	10	115	T	2700	K	S/G	Y	CI	CI	CI	Y	T	120	427	
Dremel	730	1x30	5	S	4400	2	115	O	2700	S	K/G	N	S	S	S	N	U	15	139	
Foley-Belsaw	4130901	6x89	None	E/H	3600	20/10	110/220	T	3900	K	K/G	Y	S	CI	None	Y	T	231	569	
Grizzly*	61183	6x48	12	V/H	3450	12	110	TE	5000	K	L/G	N	CI	CI	CI	N	T	160	395	
Grizzly	61531	6x80	None	E/HD	1720	18/9	110/220	T	2000	K	L/G	Y	CI	CI	None	Y	T	300	395	
Jet*	JSG-96	6x48	9	V/H	1720	10	115	T	2174	B	S/G	N	CI	CI	CI	Y	T	119	339	
Lobo*	SD-0069	6x48	9	V/H	1720	12	110	T	N/A	K	K	N	CI	A	A	N	T	130	259	
Powermatic	30 B	6x48	12	V/H	1800	22/11	115/230	T	2850	K	K/G	Y	CI	CI	CI	Y	U	315	1049	
Shopsmith	505642*** 505993	6x48	None	V/H	1150-1900 1725	8.8	115	O	900-1500 900-1350	K	K/B	Y	A	CI	None	Y	U	36 61	299 159	
Total Shop	943	6x48	None	E/H	3600	7	115	T	N/A	K	L/G	Y	S	CI	None	Y	T	145	369	

\*Similar machines available from other manufacturers.  
\*\*31-730 is the sanding machine; 52-612 is the steel stand, including motor.

\*\*\*505642 is the sanding machine, attachable to the Shopsmith Mark V; 505993 is the power stand that allows the machine to operate as a stand-alone unit. Top figures in boxes refer to sander when attached to Mark V. Bottom figures are for sander attached to power stand. Weight and prices refer to the separate units.

- (S) Strip; (V) Vertical; (H) Horizontal; (E) Edge; (HD) Half-drum
- Several motors available
- (T) Totally enclosed-fan cooled  
(O) Open-drip proof  
(TE) Totally enclosed
- (K) Knob-controlled; (S) Screw-controlled; (B) Bolt-controlled

- Parts that you'll have to remove or manipulate in order to remove belt: (B) Bolts; (G) Belt guard; (S) Screws; (K) Knob; (L) Lever
- (S) Steel; (CI) Cast iron; (A) Aluminum
- (T) Taiwan; (U) U.S.A.
- Prices often discounted 10-30% below list

**MANUFACTURERS LISTING:**  
American Machine & Tool Co. (AMT)  
Fourth Avenue and Spring Street  
Royersford, PA 19468  
215/948-0400

Black & Decker Inc.  
P.O. Box 857  
Hampstead, MD 21074  
301/239-5300

Delta International Machinery Corp.  
246 Alpha Drive  
Pittsburgh, PA 15238  
Outside PA: 800-438-2486  
PA residents: 800-438-2487

Dremel Corp.  
4915 21st St.  
Racine, WI 53406  
414/554-1390

Foley-Belsaw  
6301 Equitable Road  
Kansas City, MO 64141  
Outside MO: 800-468-4449  
MO residents: 800-892-8789

Grizzly Imports  
P.O. Box 2069  
Bellingham, WA 98227  
206/647-0801

Jet Equipment & Tools  
1901 Jefferson Ave.  
P.O. Box 1477  
Tacoma, WA 98402  
Outside WA: 800-426-8402  
WA residents: 206/572-5000

Lobo Power Tools  
10922 Klingerman St., #3  
South El Monte, CA 91733  
818/350-1096

Powermatic  
Morrison Road  
McMinnville, TN 37110  
Outside TN: 800-248-0144  
TN residents: 615/473-5551

Shopsmith  
3931 Image Drive  
Dayton, OH 45414  
800-445-4040

Total Shop  
P.O. Box 16297  
Greenville, SC 29606  
Outside SC: 800-845-9356  
SC residents: 803/288-4174



Print this article

## IN LOUISIANA, GEORGE OLIVIER WORKS CYPRESS WITH

Some kids work their way through college by busing cafeteria tables, sweeping classroom floors, or, if they're lucky, doing some tutoring. But back in the '60s, George Olivier figured he could defray his tuition costs by repairing furniture.

When George left New Orleans to study agriculture at Northwest Louisiana State University in Natchitoches, he packed \$75 worth of mail-order woodworking tools. With them, he repaired homes as well as furniture, and built study desks and chairs to sell. Before long, George's spare-time woodworking turned into a full-time love affair with wood and Natchitoches.

A half-dozen plantations sprawl the banks of the Cane River for 20 miles or so south of Natchitoches, Louisiana. Their immense, multiroomed "Big Houses"—like those shown on postcards depicting the Old South—attract visitors with displays of furnishings and finery from luxuriant days gone by. Giant armoires and heavily carved mahogany canopy beds, solid-cherry clawfoot tables, rosewood grand pianos, and massive sofas represent the elegance of pre-1860s plantation life.

Natchitoches (pronounced NAKATISH), the oldest settlement in the Louisiana Purchase, is as much a landmark to grandeur as the outlying plantations. Formal plantings frame imposing town homes trimmed with filigreed ironwork. Many of the balconied buildings in the business district claim nearly two centuries of heritage. And a good percentage of the 16,000 people who call Natchitoches home bear names traceable to the town's founding in 1714.

On Second Street, a rambling brick building of uncertain lineage

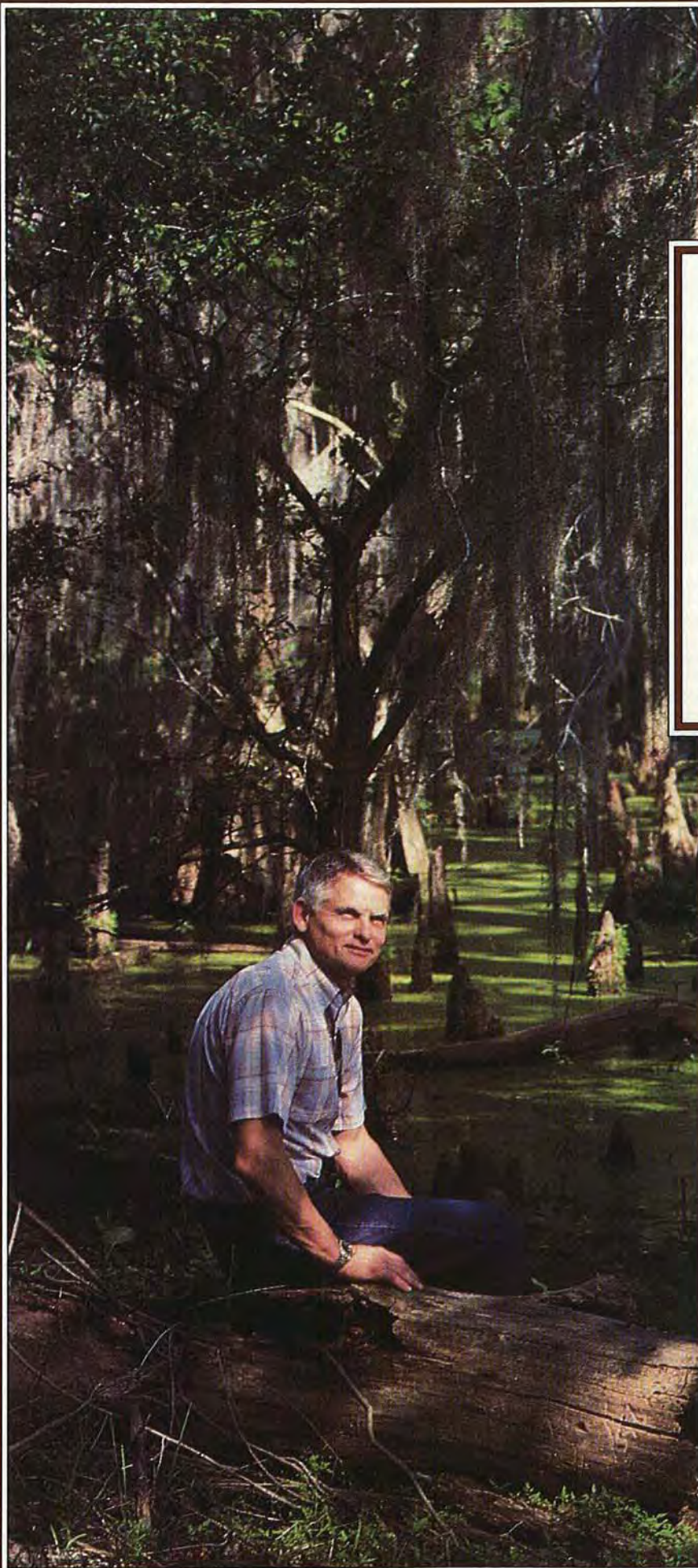

# CREOLE CRAFTSMANSHIP

Now, more than 20 years later, George has made everything from armoires to chests, chairs to historic replications of doors and windows, and four-posters to cabriole legs. Along the way, the self-taught, 49-year-old craftsman has earned himself a trusted local reputation. On his daily fitness walks, "Hi, George" rings out from friends in every block.

George's fascination for woodworking has only grown over the years. He practically lives in his shop. Even his visits to a nearby bayou are wood-working oriented. There, George marvels at the wild majesty of the cypress from which he creates furniture.



▲ In Louisiana's climate, George often chooses to bring work out in the sunshine. To shape the bombé chest, George takes off cypress with an "in-shave" or scorp. Under his attack, the chips really fly.

carries the sign "Olivier's Creole Cypress Furniture." Locals find nothing unusual in its phrasing. But to visiting Yankees, the words usually require some explanation.

First, as George Olivier will proudly tell you, he's a genuine Creole—a direct descendent of Louisiana's first French settlers. A peek into the showroom confirms that the term also describes his distinctive furniture's pedigree—born of French Quarter refinement yet as down home as file gumbo. And cypress. To George, no other wood reflects the haunting beauty of the bayous he so loves to wander.

## FURNITURE AS COMFORT-ABLE AS AN OLD RUG

George knows well the southern Empire-style furniture the plantation owners favored. He has browsed the tall-ceilinged rooms of the Big Houses and closely noted the furniture's lines and details.

More than curious, he intends to peer back through history to the early 19th century and look over the shoulders of those who shaped the now-priceless pieces. Today, in

his workshop, he reassembles much of the past, and employs the knowledge to craft—in native cypress—his own style.

"Originally, Empire furniture was done in mahogany and fancy veneers," George explains as he runs a hand through his closely cropped hair. "I can't reproduce in cypress everything early furniture makers did. Many pieces, though, look better to me made in native cypress."

Why, then, when George so keenly appreciates the furniture of yesterday's masters, does he use cypress? Stimulating thought with a brush of the stubble on his chin, he explains. "It's not so much what wood you use, but how you use it. What a craftsman sells is craftsmanship. Wood is only the vehicle. And, cypress has gone down the road with me—I can tell where it grew by how it smells."

George bills his basic product, a pleasing-to-look-at pencil-post bed, as "Country style in Cajun cypress." Yet other pieces of George's cypress furniture, although they carry the herculean lines he admires, also cast a casual, friendly image. "My

pieces are mighty comfortable to be with, not so fine that you think you're livin' in a museum."

Again, he pauses to study the satiny top of a bombé chest. "You can make something so fine you can't enjoy it. Furniture has to be functional, laid back, like a good ol' rug. It has craftsmanship, historic lines, and the material makes it real."

## SHAPING CHARACTER IN STOUT SWAMP STOCK

"All kiln-dried, select-grade lumber looks like plastic to me," says George. "I like No. 2 grade with the knots, splits, pecks, worm holes—all the little surprises."

The furniture industry calls the surprises George finds in cypress "character marks." George arranges them in his furniture as an artist would place color in a painting.

"When I make a headboard, for instance, I try to balance its beauty. If I put a board with a knot on the left side, I try to balance that with good graining on the right," he explains. "The piece has to have a nice soothin' flow of visual activity, you might say."

*Continued*



## CREOLE CRAFTSMANSHIP

George's palette of character marks sometimes show up in the least expected places. "I like to have a knot in my moldin's. You never see a knot in anyone else's moldin's. But doin' it takes a little bit more care," he advises. "If I knock the knot out, I gotta put it back in, fill it, and sand it."

To fill cracks, holes, and star-cracked knots, the Creole craftsman mixes powdered tempera colors with powdered water-base putty. By varying the amount of colored powder, George blends the filler with any of the wood's varying tones.

### FRESH-AIR WOODWORKING, NATCHITOCHEs STYLE

Woodworkers north of the Mason-Dixon line would envy George's working conditions. Instead of a confining basement or half of a two-car garage, this warm-weather woodworker spreads his machines and tools on the floor of a 50x60' tin-roofed, open-sided shop.

Vine-laden lattice forms the back wall. It provides privacy without blocking airflow. There isn't a front wall. So, George can take a work-piece outside under the big pecan tree when the spirit moves him. Inside, long spans of laminated beams mean few interfering posts. The expanse of concrete floor allows George to prowl like a lion in his lair from one project to another.

In racks at a far end of the shop, thousands of board feet of rough-sawed cypress lay waiting their turn through the planer. The boards are 1" or 2" thick and no wider than 8". "I can get cypress boards 2' wide, but I stick to 1x8s and 2x8s," says George.

"Consistency is important. I don't want to make one tabletop with

two boards in it and come 'round the next time with eight! It's like sellin' eggs: You don't put one big egg in with 11 regular ones."

### TUNG OIL WITH A BLOOM

A small and tidy backyard separates George's shop from the brick building facing the street. Across the path from the young cypress he planted a few years ago stands a small palmlike tree. "That's a tung oil tree [*Aleurites fordii*] from China. I wanted to see where my finish comes from, too!" George laughs, but the remark only characterizes his driving curiosity, a trait that led him away from the spray gun.

"For 20 years I sprayed lacquer because I didn't know how to work with an oil finish. But when I made up my mind, I finally figured out how to get tung oil to bloom," he says.

In George's workshop, bloom means shine. And he has the technique down pat. After a final sanding of his furniture with 220-grit paper "to polish it," he darkens the cypress with a walnut oil stain. "Then," he says, "I put pure tung oil (cut 50/50 with mineral spirits) on three times, each time wiping the excess off with a rough rag before it dries. For the finish to work, you can't let the oil dry completely between coats, and never wipe it off across the grain! Once you get enough on, let it dry until you can sand it and get dust. Now, here's how to make that finish bloom: Apply a paste wax, let it dry, and then buff it. It'll look better than hand-rubbed varnish."

### TODAY'S SOLUTIONS FOR YESTERDAY'S PUZZLES

George's constant search to solve some of the woodworking puzzles posed by last century's craftsmen often proves frustrating. Disassembling a piece of furniture worth thousands is impossible. Instead, he relies on his intuition and trial-and-error. And, he's found satisfaction.

In the same manner that he finally mastered a tung-oil finish,

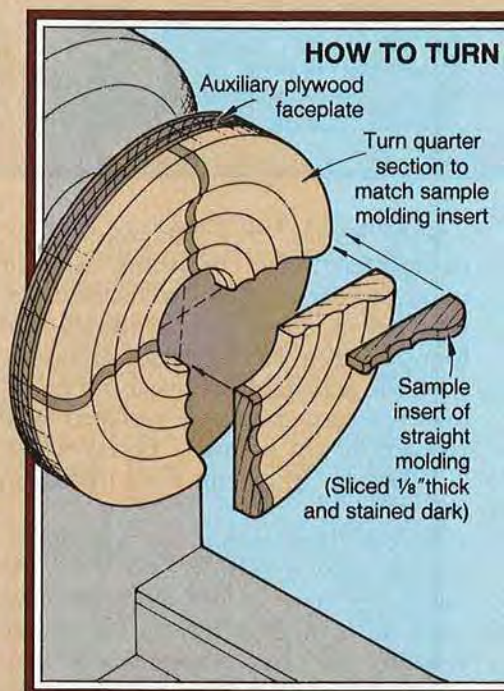

▲ Knots in No. 2 cypress are some of the little surprises that give visual interest to George's furniture, even though these character marks mean extra finishing work. "My pieces have a soothin' flow of visual activity, you might say," he proudly remarks.

George thought out and tried all the possibilities to make perfectly matched radius moldings. These pie-shaped pieces complete the corners on massive, rounded mirror frames and the cornice trim on Empire beds and armoires. George found the solution on the lathe.

To craft four matched corners, George first attaches an auxiliary plywood disc to the faceplate. He divides the disc into equal quarters exactly from center and marks the divisions with a pencil. George then cuts four pieces of stock to fit into the quarters.

## PERFECTLY MATCHED RADIUSSES

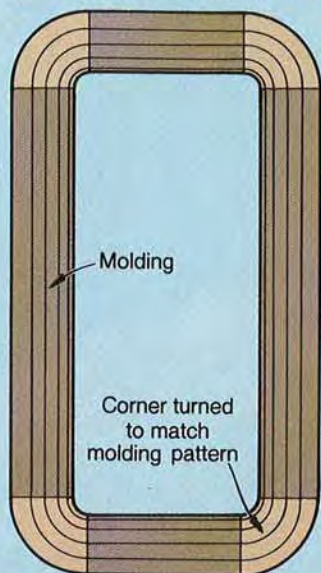

▲ This 8' bedpost almost fills the 9' lathe bed. George sands concave areas with a sandpaper-wrapped dowel.

With canopy, this queen-sized, ► southern Empire-style bed stands 8'8" tall and sells for \$3,800.

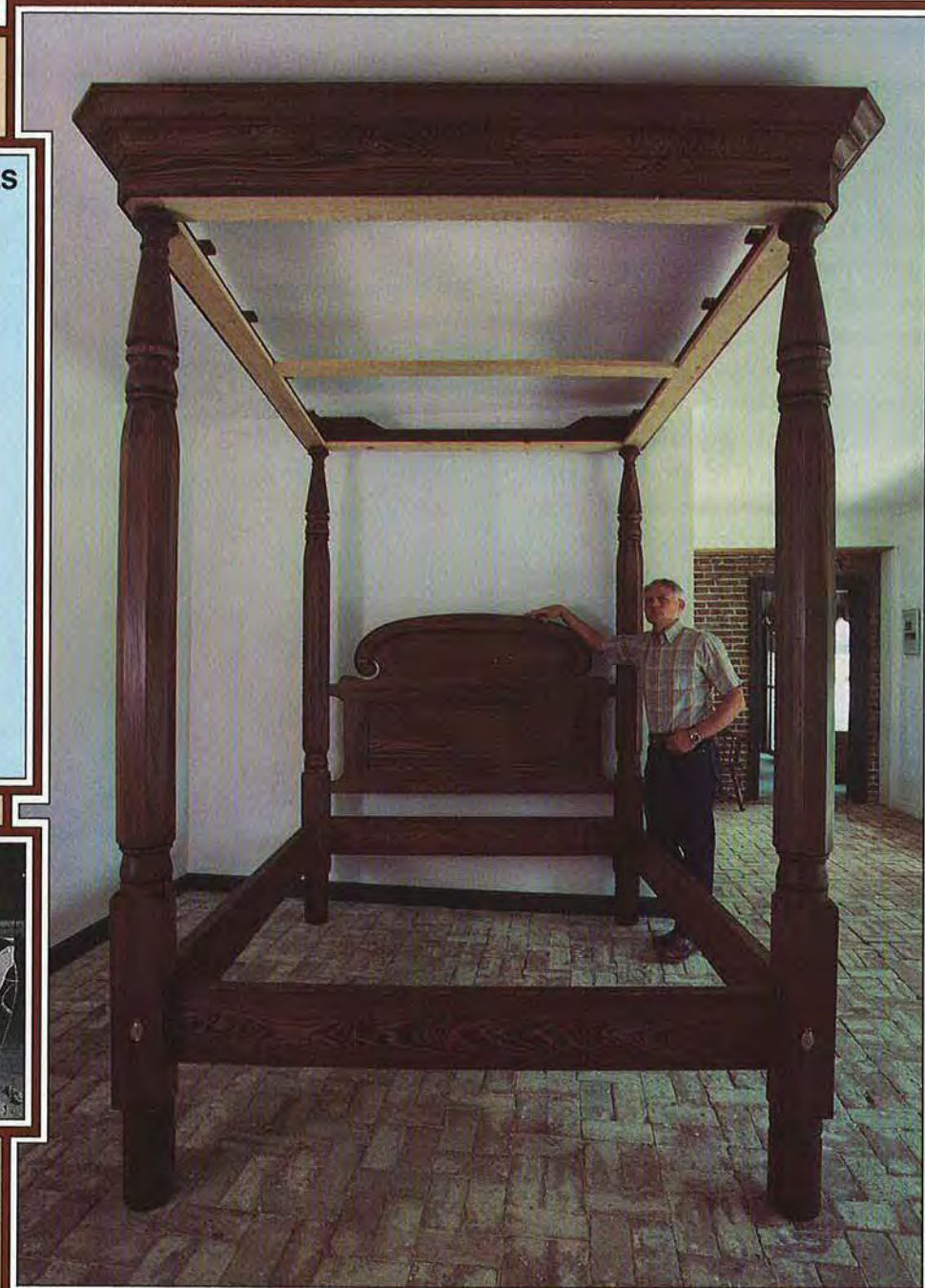

From a straight section of the original molding, he slices off four  $\frac{1}{8}$ "-thick pieces and darkens them with stain. Next, George assembles the quarter sections on the faceplate with the slices of molding separating each quarter, as illustrated *above*. A web clamp helps hold the pieces together while he centers them. George then clamps the centered assembly to the faceplate, flips it over, and secures the four parts with screws from the back side. George shapes the moldings on the lathe with a gouge, stopping occasionally to see how close he's

coming to the originals. Sanding completes them. "Those little slices of dark moldin' help you tell where you're at," he notes.

### AN ACTIVE MIND TO HELP HANDS SHAPE WOOD

Idleness occupies little time in George's shop. When his hands aren't shaping wood, his mind is. For instance, the partial solution to his next woodworking mystery lies on a tabletop in his living room.

Sketches and detailed drawings, many erased and repenciled, re-create on paper the probable assembly

of a southern Empire bedpost. Standing 8'7½" tall, the post was first created in the shop of Prudent Millard, a furnituremaker who established himself in New Orleans' French Quarter in 1838.

Made of two dozen intricately laid-up pieces, the post dwarfs even the giant bed in George's showroom. George doesn't know when he'll be able to re-create the huge post in cypress. "The only key to buildin' this post was thrown away 100 years ago. But I'll get it, and when I do, it'll be like openin' a new vault of knowledge." ♣

Written by Peter J. Stephano Photographs: Jim Elder Illustration: Kim Downing

Before coming to **WOOD**® magazine and building all our projects, Jim Boelling spent 10 years as a furniture machinist. One of Jim's fellow cabinetmakers, Marvin Barsness, often made his own tools for scraping surfaces prior to finishing and for removing glue squeeze-out. Now, Jim has improved on Marvin's design for a scraper that's as comfortable as it is good looking. The adjustable blade makes getting into tight corners a snap.

### HOW TO GET A HANDLE ON THIS PROJECT

**1** Cut a ½"-thick piece of walnut to 2½" wide by 17" long for the handle parts (A, B). (We resawed a piece of ¾" walnut to ½" thick; you also could plane or joint a thicker piece to ½".) Crosscut the 17" walnut strip in half.

**2** Cut or rout a ¼" groove ¼" deep down the center of part A where shown on the Exploded-View Drawing. (We used a dado blade on the tablesaw to cut the groove.)

**3** Using a dado blade on either the tablesaw or radialsaw, cut a 1¼" rabbet ⅜" deep across the grooved face of the handle bottom (A).

**4** Tilt your saw blade 40° from vertical, and bevel-cut the front end of each handle part.

**5** Glue and clamp the handle pieces together with the edges flush. Align the mitered ends where shown on the Side View Detail.

**6** Using carbon paper or a photocopy, transfer the full-sized handle pattern shown on page 77 to heavy paper or posterboard. Cut the paper template to shape, and trace its outline onto the *bottom* face of the walnut handle lamination. Bandsaw the handle to shape. Drumsand the contours smooth to remove the saw marks.

**7** Chuck a ⅜" round-over bit into your table-mounted router. Rout the handle where shown on the

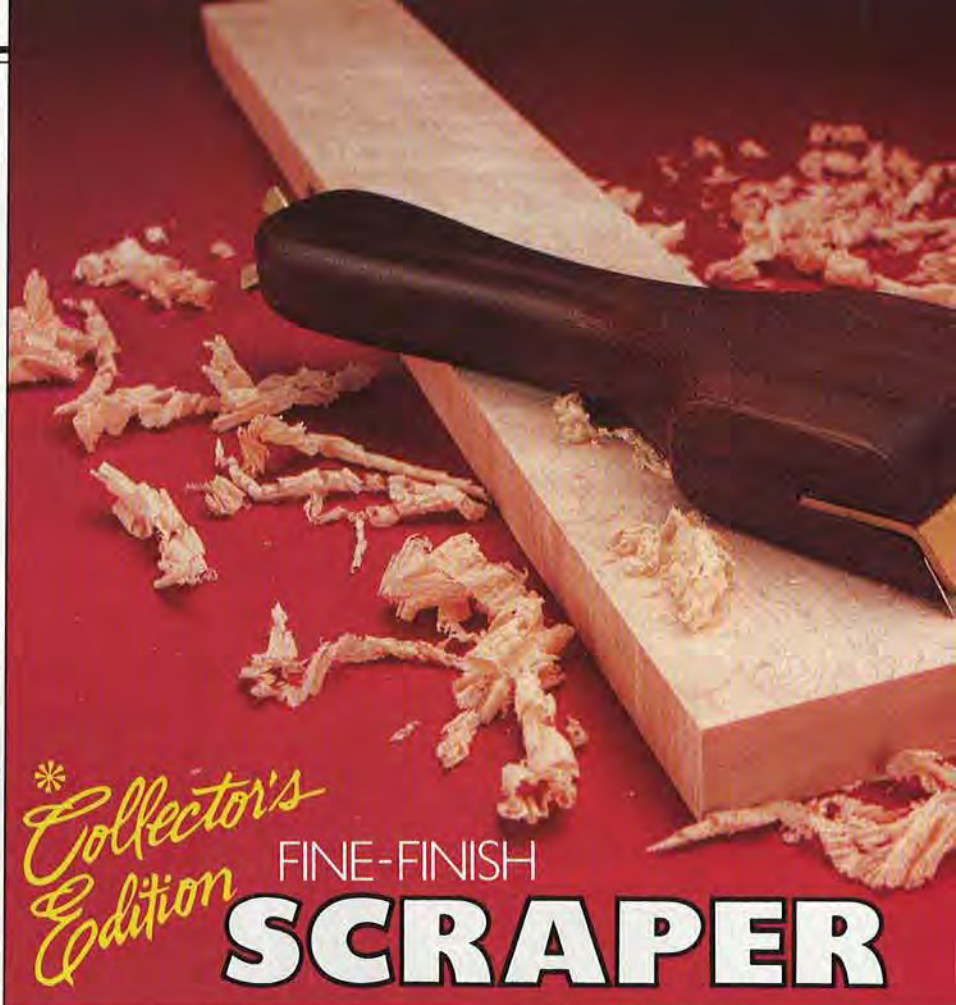

*Collector's Edition*

FINE-FINISH

# SCRAPER

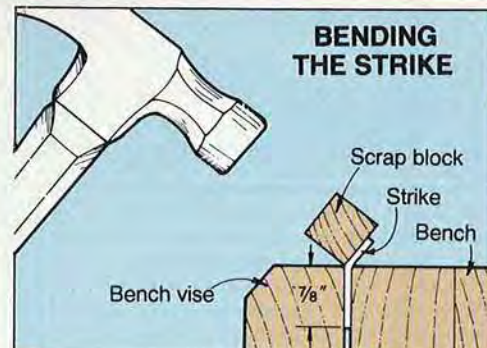
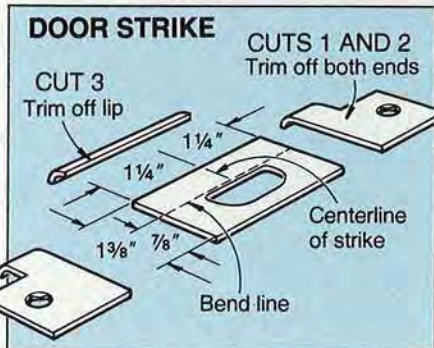

Exploded-View Drawing. Sand a ½" round-over on the front top end of the handle where shown on the same drawing. Sand the handle smooth and apply the finish.

### CUT, SHAPE, AND ADD THE HARDWARE

**1** Apply masking tape to the polished side (the top face) of a solid-brass door strike. (We used a Schlage ANSI 10-025605 polished-brass strike; see the Buying Guide for our hardware kit.) The tape is easy to mark cutlines on, and helps prevent the polished brass from being marred when cutting.

**2** Mark a centerline across the strike where shown on the Door Strike Drawing. Using the dimensions on the drawing, trim the strike ends and front lip. File the cut edges to remove burrs.

**3** Clamp ⅞" of the strike in a vise and bend the exposed portion as shown on the drawing above. Place the strike in the handle to check the angle; continue bending until the angle is the same as the front of the handle. (See the Side View Detail accompanying the Exploded-View Drawing for reference.)

**4** Cut a 7½" length of ¼" all-thread rod. As shown in photo A, use a

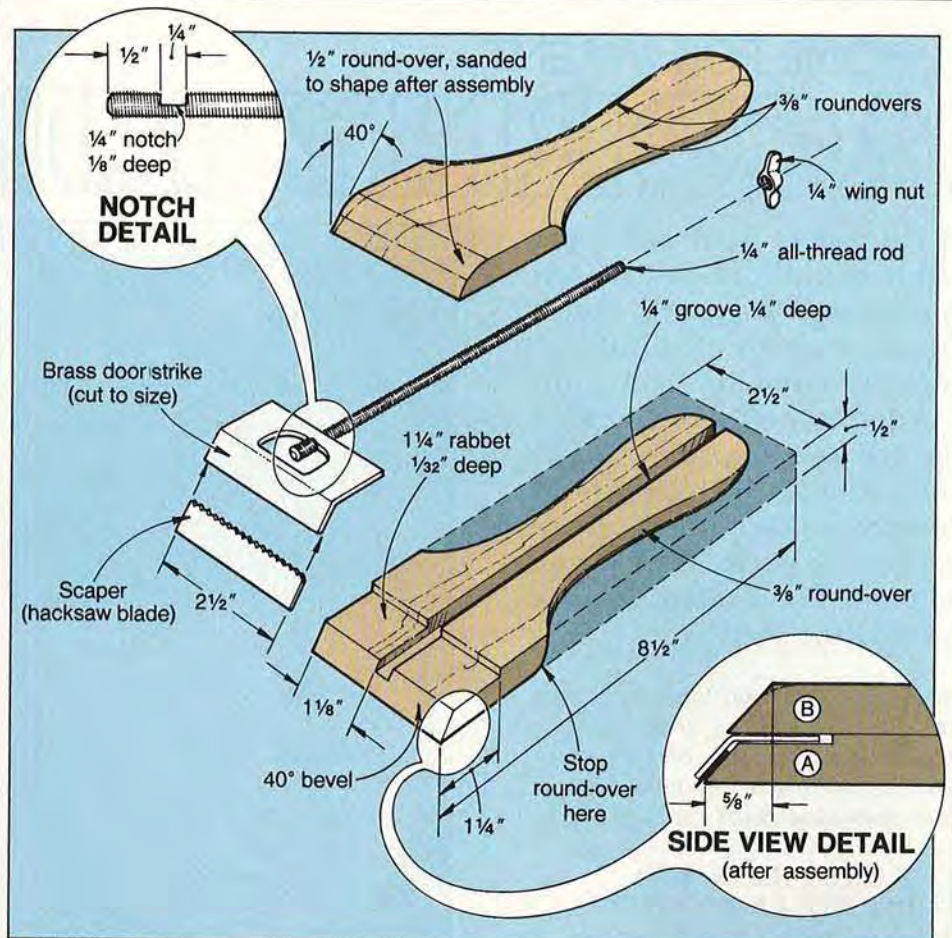

**A** Secure the all-thread rod in a vise or handscrew clamp, and file a  $\frac{1}{4}$ " notch  $\frac{1}{8}$ " deep  $\frac{1}{2}$ " from the end.



**B** Scribe marks every  $2\frac{1}{2}$ " on the hacksaw blade. Then, shear scraper blades to length with a cold chisel.



**C** Angle the scraper slightly less than  $45^\circ$ . Using straight strokes, file the blade with a mill bastard file.

#8 mill bastard file to cut a notch in the threaded rod. See the Notch Detail for dimensions. (We wrapped masking tape around the rod to mark the notch location on the rod and to prevent marring the rod threads in the vise.)

**5** To make the scraper blades, mark increments every  $2\frac{1}{2}$ " on a used or dull hacksaw blade. Clamp the blade in a vise. Using a cold chisel, shear off the blade segments where marked as shown in the photo B. Hammer the corners of each blade

flat—they tend to bend slightly when chiseling to length.

**6** Assemble the scraper, and slip the scraper blade into position. Tighten the wing nut on the all-thread rod to hold the scraper blade firmly in position. (We keep about  $\frac{1}{8}$ " of the blade exposed).

#### TIME TO SHARPEN

To sharpen the scraper blade, angle the scraper as shown in photo C, and sharpen with a mill bastard file. As you move the file back and

forth, keep the file in contact with the total length of the blade to avoid curving the blade. (We held our scraper slightly less than  $45^\circ$  when sharpening.)

#### BUYING GUIDE

● **Scraper hardware kit.** Brass strike plate,  $\frac{1}{4}$ " brass wing nut,  $\frac{1}{4}$ " all-thread rod  $7\frac{1}{2}$ " long, \$6.50 ppd. from Kurtz Hardware, 1473 Keo Way, Des Moines, IA 50314. 🌳

Photographs: Bob Calmer  
Illustrations: Kim Downing; Bill Zaun

# HOME FOR WRENT ACORNY KIND OF

If chickadees or wrens could talk (they do, of course, but not in our language), they'd thank you for this not-so-humble domicile. We've included everything a bird desires—nesting space, ventilation, and drainage—and omitted a perch at the advice of bird experts. Here's one nut you won't mind hanging around the yard.

*Note: For information on sizing, finishing, hanging, and cleaning birdhouses, see our birdhouse requirement article on page 78 and our birdhouse chart on page 80.*

## CUT THE PIECES AND FORM THE LAMINATION

**1** From 2×10 stock (we used spruce), cut five pieces measuring 7½×11½" for parts A, B, and C. Now, as dimensioned on the Lamination Drawing, lay out the openings in parts B and C. Drill a ⅜" blade-start hole, and cut each opening to shape with a jigsaw.

**2** With the edges and ends flush, glue and clamp the five pieces. (We used plastic-resin glue—an inexpensive, water-resistant adhesive. See the Buying Guide for our source.) Let the glue dry overnight.

## MAKE THE TEMPLATE AND TURN THE ACORN TO SHAPE

**1** Cut a piece of poster board to 6×12". Starting at the bottom, draw a 1" grid on the paper. Lay out the shape of half of the birdhouse on the marked grid, using the Grid Half Pattern as a guide. To do this, mark the points where the pattern outline crosses each grid line. Draw lines to connect the points. Cut the template to shape.

**2** Draw diagonals on both ends of the birdhouse lamination to find centers. Using a center punch and a

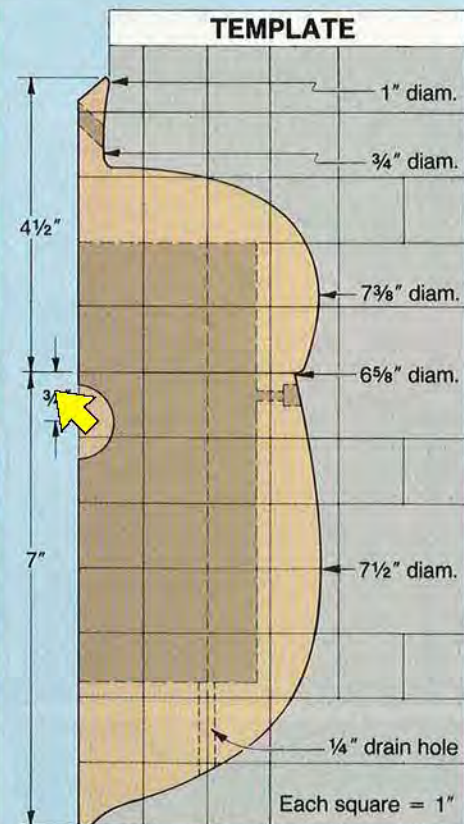
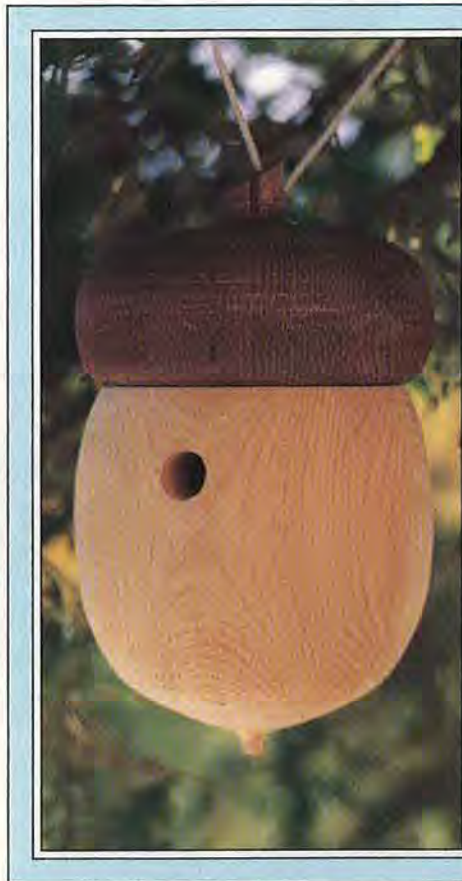

mallet, make an indentation at each marked centerpoint.

**3** For ease in turning round, use a compass to draw a 7½"-diameter circle on one end of the lamination. Then, chamfer each corner of the lamination, cutting outside of the marked circle.

**4** Mount the lamination between centers, centering the headstock and tailstock points at the indented centerpoints.

**5** With a 1" gouge, turn the lamination round. Now, turn the lamination to shape, using the template as a guide. Turn the top and bottom of the acorn last; you'll want plenty of stock at both ends when turning the profile to shape. (We used a 1" and a ½" gouge, as well as a parting tool, to do the shaping.) For a natural texture, we left our project rough and did not sand it.

## DRILL THE ENTRANCE HOLE AND CUT OFF THE LID

**1** As shown in the photo below, clamp the spur center with a hand-screw clamp. Position the bottom of the clamp on the lathe bed to prevent the acorn from turning. Drill a 1½" hole where dimensioned on the Grid Half Pattern.



Clamp the spur center to hold the birdhouse firmly in position, and drill a 1½" hole into the cavity.



# BIRDHOUSE

## LAMINATION

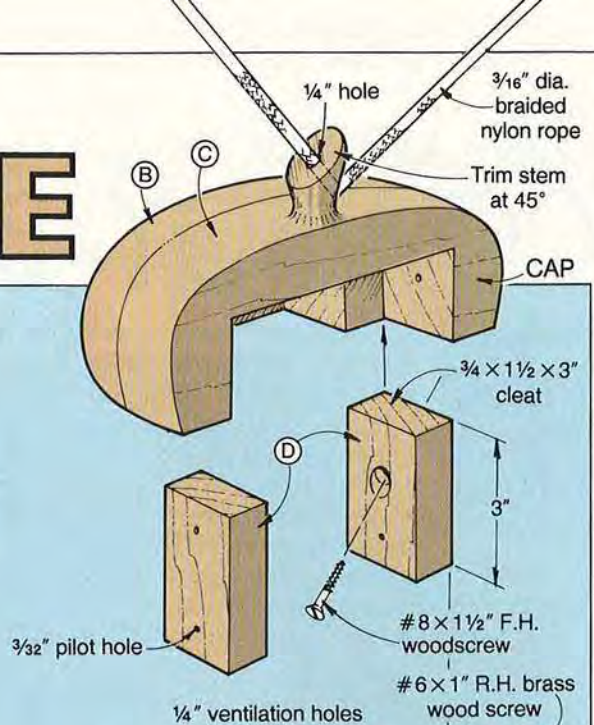
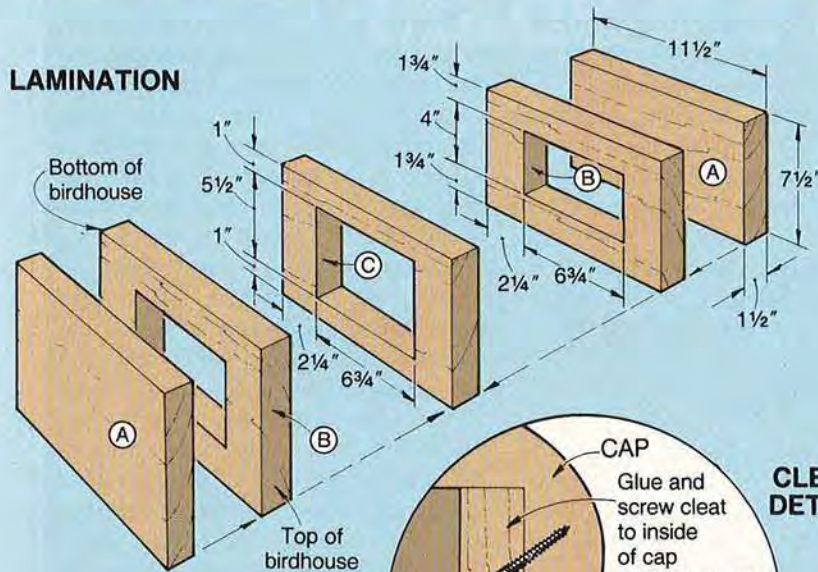

## CLEAT DETAIL

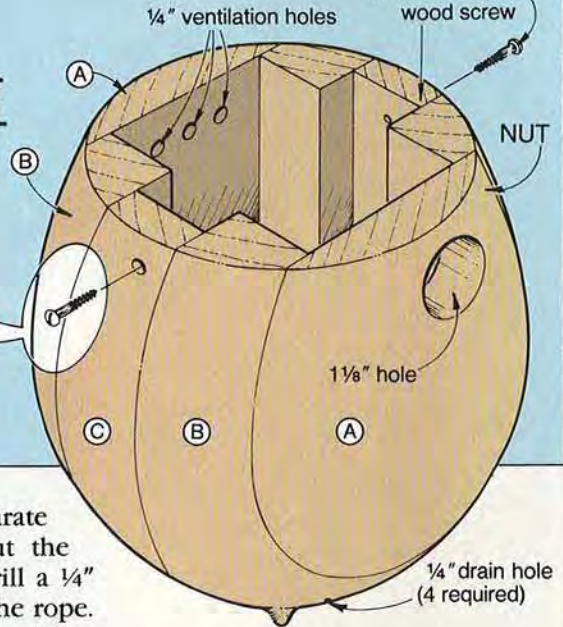
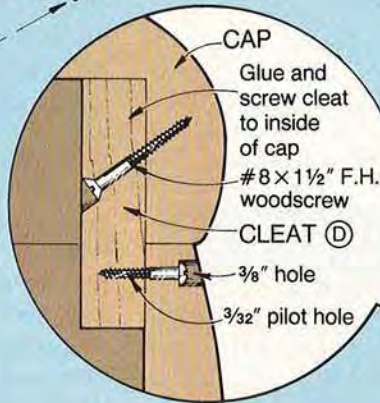

**2** Using a handsaw, cut the cap from the nut as shown in the photo below. (To prevent the saw from binding, we made a few cuts, loosened the clamp, and rotated the acorn a quarter turn. Then, we re-tightened the clamp, made a few more cuts, and rotated again.) Remove the acorn from the lathe. Fin-



Using a handsaw, make cuts all the way around the laminated turning to separate the cap from the nut.

ish making the cut to separate the cap from the nut. Cut the stem at a 45° angle, and drill a 1/4" hole through the stem for the rope. **3** Drill three 1/4" ventilation holes and four 1/4" drainage holes (see the Grid Half Pattern and Exploded-View Drawing for reference).

## ADD THE CLEATS, APPLY THE FINISH, AND HANG

**1** Cut two cleats (D) to 3/4 x 1 1/2 x 3". Glue and screw them to the inside of the cap (see the Exploded-View Drawing and accompanying Cleat Detail for reference). Let the glue dry overnight.

**2** To attach the cap, position the cap on the nut and drill the two holes as dimensioned on the Cleat Detail. Fasten the cap to the nut.

**3** Finish the outside but not the inside of the birdhouse. (We stained

the cap, and then applied two coats of clear water sealant to both the cap and the nut.)

**4** Run a 3/16"-diameter braided nylon rope through the hole and hang from a limb. To prevent the birdhouse from spinning in the wind, double the rope as shown in the opening photograph and on the Exploded-View Drawing.

## BUYING GUIDE

- **Plastic-resin glue.** Mixes with water for a smooth-spreading, tan-colored glue. Catalog no. N1201, one pound for \$10.35 ppd. The Woodworkers' Store, 21801 Industrial Blvd., Rogers, MN 55374.

Illustrations: Kim Downing; Bill Zaun Photographs: Bob Calmer

# CARVE A PAIR OF COWBOY BOOTS

**Kick up your heels with this western pattern from Arizona's Dave Rushlo.**



Dave Rushlo

Woodcarver Dave Rushlo and his whittling wife, Joan, live in Scottsdale, Arizona. But, they're admittedly snow-

birds. The Rushlos spend the summer and early fall months in the North attending carving shows and teaching how-to seminars, then head

back to Arizona for the winter. There, the Rushlos carve, as well as sell tools and books by mail.

Dave gets ideas for carvings from his travels. He never passes by a small-town rodeo, outdoor auction, cafe, or truck stop. His trained eyes record what he sees, such as the boots shown here. They represent a "go-to-town" style, but not quite "Saturday-night kickers," he says.

## Tips on carving a Rushlo cowboy boot

Transfer the full-sized pattern to a 2x4½x6½" chunk of basswood, sugar pine, or butternut, then saw the blank to shape on your bandsaw.

Drill a ⅝" pilot hole in to the top of the boot as indicated by the dotted lines. Next, draw a vertical centerline all the way around the boot from the center of the toe to the center of the heel. Do the same thing on the boot sides where the seam will be.

Start the carving by rounding the boot shaft (from the ankle up) from centerline to centerline. Then, draw in the sole pattern and remove wood from the sole and heel. "I draw in the sole close to ¼" thick the first time, otherwise it will end up too thin. With a V-tool lying on its side to get a straight line, I outline the sole first," says Dave. With the shaft and sole established, you can now shape the boot's toe and instep.

When you have shaped the boot, remove all saw marks from the sole and heel with shaving cuts. Now, begin detailing. "I clean up the stop cut around the sole with a sharp-pointed knife, then thin out the sole," says the cowboy carver. "Next, detail the seams and pull straps on your boot."

Carve out the inside of the boot so the walls taper from ¼" thick at the bottom to ⅛" thick at the top. According to Dave, you can add the boot stitches by dotting with an awl or a needle point on a wood-burning tool.

## Stains bring your boots to life

"I don't sand my woodcarvings, and it's not necessary to first apply a sealer under the Carver Tripp brand stains I use," notes Dave. "To eliminate the possibility of a dark stain on endgrain, I saturate the entire boot with turpentine before staining. You may have to stain more than once to get the exact color you want and still let the woodgrain show through," advises the carver. 🌲

Design: Dave Rushlo  
Photograph: Jim Kascoutas

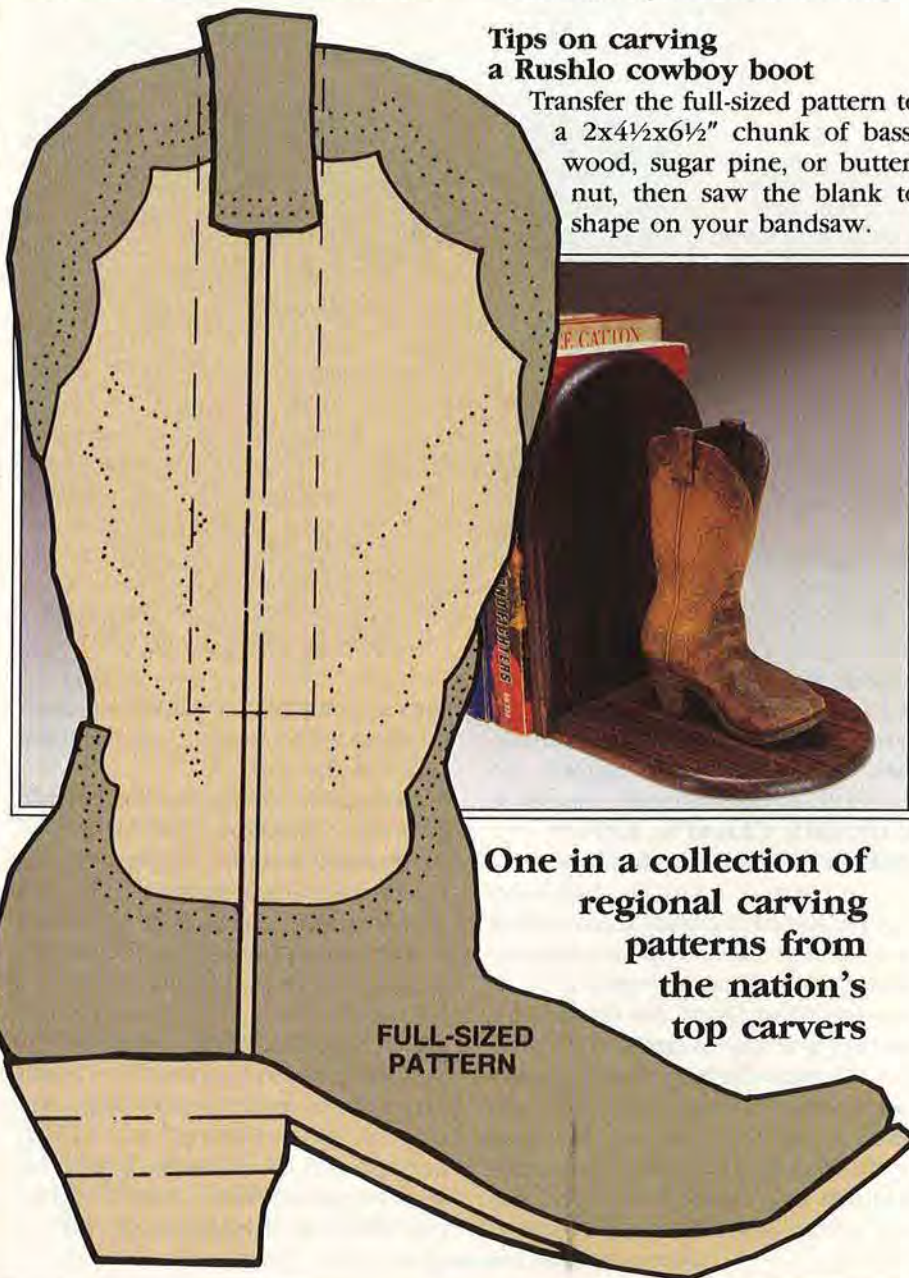

**One in a collection of regional carving patterns from the nation's top carvers**

**FULL-SIZED PATTERN**

# Imagine hearing her say, "My Daddy Made It For Me."



With woodworking, there's a lifetime of magic moments just waiting for you to discover. Like the pride you feel when your daughter shows off the special doll buggy you made just for her.

And whether you're crafting a toy for one of your children, building a new deck for some great family fun or remodeling your kitchen, Shopsmith can help you do it better and more affordably.

## Begin with the affordable Shopsmith® MARK V.

The multi-purpose MARK V gives you the five most-needed woodworking functions in a single compact unit. You get a table saw, drill press, horizontal boring machine, lathe and disc sander—and it's yours for far less than the five single-purpose tools it replaces.

## The MARK V grows with your skills.

After you've had a little practice and find that you're ready to move on to more involved projects, Shopsmith is ready to help with a full assortment of specialized accessories to make quick work of almost any job you can imagine!

For bigger projects, you can even add five Major Accessories, including a Bandsaw, Jointer, Scroll Saw, Belt Sander and Thickness Planer. And each can be powered by your MARK V to save you even more space and expense.

## We'll show you how to do it!

As a MARK V owner, you receive complete operating instructions—plus you can learn more about woodworking through our classes, seminars, educational video tapes, catalogs and "Hands On", our special magazine for owners.

You can also call us Toll-Free for the answers to all your woodworking questions. And you'll have the confidence of dealing directly with Shopsmith, either by mail, Toll-Free phone or at one of our growing network of Shopsmith Stores.



Dept. 3770

## Ask for a FREE Information Kit!

To find out more about woodworking with the Shopsmith MARK V, call Toll-Free or mail the coupon below. We'll rush you a FREE Information Kit in your choice of Full Color Brochure or VHS Videocassette and Color Brochure. There's no obligation, so act NOW.

For your FREE Information Kit Call

**1-800-228-1303**

or mail the coupon below to:



**Shopsmith Inc.**

3931 Image Drive  
Dayton, Ohio 45414-2591

© 1988, Shopsmith, Inc.  
Shopsmith® is a registered trademark of Shopsmith, Inc.

**Yes!** I'd like to know more about creating my own "magical moments" with the Shopsmith MARK V. Please send me:

- FREE Color Brochure on the Shopsmith MARK V, or  
 FREE VHS Videocassette and Color Brochure. (3771)

Name \_\_\_\_\_

Address \_\_\_\_\_

City \_\_\_\_\_ State \_\_\_\_\_ Zip \_\_\_\_\_

I currently own Shopsmith Power Equipment.

Send to: Shopsmith, Inc., 3931 Image Drive, Dayton, OH 45414-2591

# A SOUTHWEST-INSPIRED BOWL

Continued from page 35

**3** Using the drawing at *right* as a guide, make a full-sized template on heavy paper or thin cardboard.

**4** With your lathe running at about 500 rpm, shape the outside of the bowl, frequently checking the shape of the bowl against the template. (We used a 1 3/8" bullnosed scraper.) Then, shape the inside of the bowl. (We turned the bowl wall to a 1/2" thickness and then sanded the wall to 3/8" thick. Finally, we power-sanded the bowl as shown in photo J on page 31.)

**5** Finish the bowl. (We applied two coats of lacquer sanding sealer followed by several coats of polymerized tung oil.)

**6** Now you're ready to part the bowl from the auxiliary faceplate by splitting the plywood one or two plies away from the bowl. We suggest you ask a helper to steady the bowl while you carefully tap a 1" chisel with a mallet. Don't try to split a ply in the auxiliary faceplate

by driving the chisel at just one point. Rather, tap the chisel, rotate the bowl and tap again. Repeat this operation at about four different locations around the faceplate until it splits easily.

**7** Sand the bottom of the bowl smooth. Finish the bottom.

## BUYING GUIDE

• **Hardwood for bowl.** Same-sized pieces and type of wood as shown in the Cutting Diagram. \$89.95 ppd. from Woodworker's Dream (Martin Guitar Co.), 10 W. North Street, Nazareth, PA 18064; or call 800-345-3103 to order. 🌲

Produced by Marlen Kemmet

Project Design: Jim Downing

Photographs:

Jim Kascoutas;

Bob Calmer

Illustrations:

Kim Downing;

Mike Henry

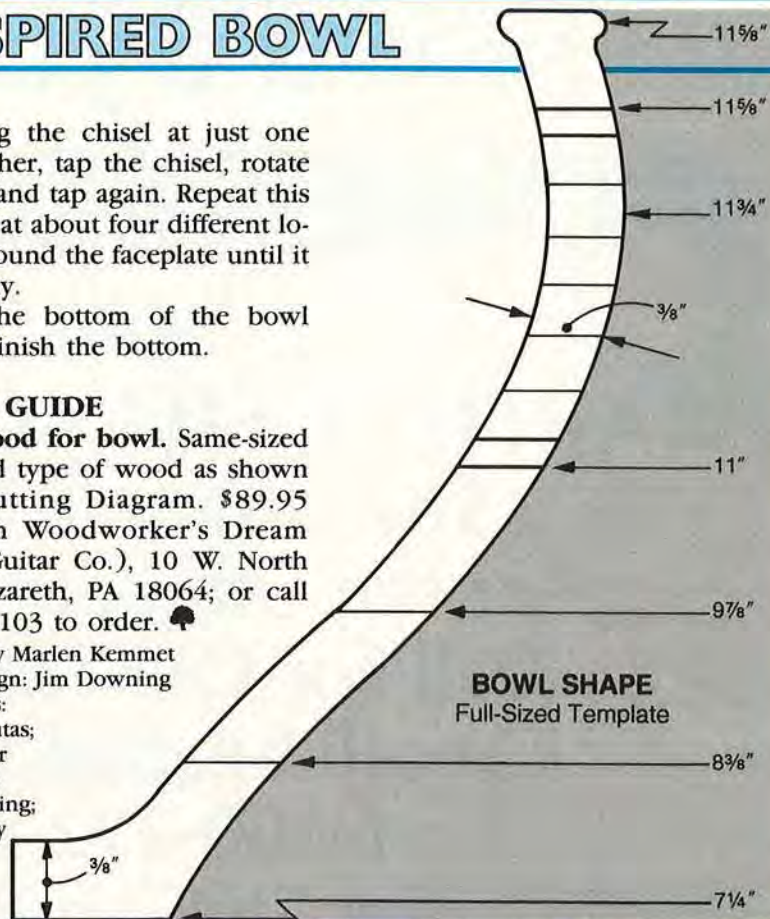

## ROBLAND

### The intelligent one-man shop.

- 10" Table Saw
- 12" Jointer
- 12" Planer
- Shaper
- Mortiser
- 50" Sliding Table

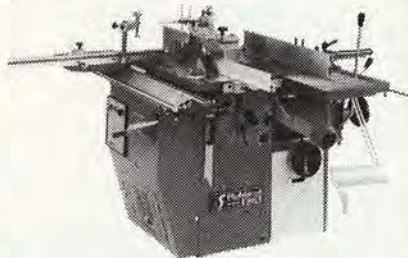

The ideal tool for a small workshop.

For Information and your nearest dealer call

### LAGUNA TOOLS

2081 Laguna Canyon Road  
Laguna Beach, California 92651

1-(800) 234-1976

## IF YOU VALUE YOUR FINGERS..... YOU NEED A

# RIPSTRATE®

The RIPSTRATE holds the work tight against the fence with no hands near the blade. Makes perfect, straight cuts. Wheels lock to prevent kickbacks. *Requires no adjustment for stock width or thickness.*

Over 30,000 now in use in amateur, professional, school, government, military, and corporate maintenance shops.

One year guarantee, 30 day money back trial. \$69 plus \$3.50 for shipping. Check, M.O., Visa or M.C. Free Brochure.

Write or call our toll free number: 800-421-0256.

Fisher Hill Products 4 Fisher Hill Fitzwilliam, NH 03447

Dealer inquiries invited.



# The Discerning Craftsman

(ADVERTISEMENT)

# LUMBER YARD

- Select a wood species that's compatible with the project you're planning to build (there are several good reference books that list various species' characteristics and preferred uses).
- If you're planning to build several projects in the near future, consider ordering what you need for all of them at one time. That way, you'll have the stock you need when you're ready to build.
- If you or someone you know has a planer, and if you are willing to surface your own lumber, you can save money by ordering stock that's undressed (rough sawn).
- Figure your lumber needs, then add 15% for waste. As you do this, think in terms of the number of boards of a certain size it will take to yield the parts for your project. Make a cutting diagram showing how you plan to cut each of the boards.
- Send along a copy of the cutting diagram with your order, and explain the type of project you're planning to build. Both of these things help us in filling your order.
- Send for our product brochures, and keep them on file in your shop. That way, when you need a particular type of stock, you'll have ready reference.
- Buying in bulk lowers the cost per board foot. Consider going together with some of your woodworking friends, and take advantage of the savings. Some of us have minimum orders.
- Be aware of shipping costs. Is the price quoted a shipped price? How will it be sent? UPS? Trucking firm? Etc.? Ask.
- Upon receipt of your order, please inspect it and report any damaged material to the carrier immediately.

**Thin HARDWOOD—Priced Right**  
Clear • Kiln Dried • 2 Sides Surfaced  
3" to 10" Widths • 3' to 7' Lengths  
20 Sq. Ft. Packs • Random Widths & Lengths

	1/8" & 3/16" is 18" to 48" L.	1/8"	3/16"	1/4"	3/8"	1/2"	3/4"
Red or White Oak	\$32	\$40	\$41	\$42	\$44	\$62	
Walnut or Cherry	34	42	43	46	50	68	
Poplar or Pecan	29	30	32	34	36	40	
Basswood	30	34	36	38	42	52	
H. Map. or Locust	32	38	39	42	46	56	

Micro Lumber - S4S - Sanded - sold and prices in quantities of 10 boards only - order 2 or more for prepaid UPS del. - or order 1 w/any order of thin 1 br. 4" x 24" boards - Pack of 10

	1/8"	3/16"	1/4"	3/8"	1/2"
Red or White Oak	14	17	20	24	27
Walnut or Cherry	17	20	24	27	31
Poplar or Pecan	10	13	16	19	23
H. Map., Birch or Locust	14	17	20	24	27

Price includes UPS delivery in Continental USA  
To order circle wood & dollar amount.  
Check or Money Order to:  
**HARDWOODS OF ILLINOIS**  
R.R. 4, Box 618 Mt Vernon, IL 62864

## READY TO ASSEMBLE



**SOLID CHERRY  
WALNUT  
MAHOGANY  
OAK**

matching coffee table available

"FREE BROCHURE" DEPT "M5"  
(615)587-2942  
*Adams Wood Products, Inc.*  
974 Forest Dr., Morristown, TN 37814

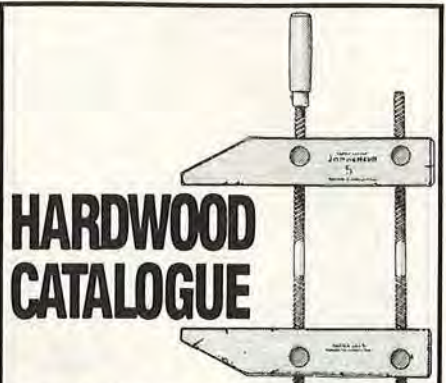

## HARDWOOD CATALOGUE

**Only \$2.00. Refunded with order.**  
White oak, cherry, walnut... nothing compares in texture, grain and quality to Appalachian hardwoods. ■ Order your catalogue today. We offer 21 species of domestic hardwoods, softwoods and hard-to-find imports. ■ All wood is kiln-dried and personally selected. Well finish at no charge. All prices include delivery. ■ Write today.



**EDLCO**  
P.O. Box 5373-C,  
Asheville, N.C. 28813  
1-704-255-8765  
Hardwood specialists since 1952.

**SHAKER PEGS  
CANDLE CUPS  
MUG PEGS**

\$17.95 per 100, prepaid.  
Wide selection of other wood products.  
Catalog \$2.00 or free with order.

**Benny's Woodworks**  
P.O. Box 840, Dept. WD14  
Shelbyville, TN 37160  
1-615-437-2295

Shaker Peg      Mug Peg

If you would like more information about advertising in *WOOD*, contact:

**Terry McIntyre**  
**WOOD Magazine**  
750 Third Avenue  
New York, NY 10017  
212-551-7130

**WOODWORKERS**  
Save on Wood - Tools - Supplies!

**OVER 4000 ITEMS**

Send for New 1989 148 Page Money Saving CATALOG

**OUR 59th Year**

Finest Dimensioned **HARDWOODS** and Quality **VENEERS**  
**42 VARIETIES**  
1/64" to 4" Thickness

Fast service on choice kiln dried Wood and Veneers, Moldings, Trim, Hand and Power Tools, Lamp Parts, Upholstery Supplies, Clock Movements and Kits, Hard-to-Find Hardware, Finishing Materials, Books... over 4000 items in stock! Craftsman—Woodworker's best friend.

**CRAFTSMAN** WOOD SERVICE

Dept. WM-39, 1735 W. Cortland Ct., Addison, IL 60101  
Please enclose \$1.00 to help pay postage and handling.

**DOMESTIC & FOREIGN HARDWOODS**

Quality stock for Cabinet Work  
Most all sizes from 1" to 4" in thickness

**HARDWOODS**  
ASH—BASSWOOD—BIRCH  
BUTTERNUT—CHERRY  
CHESTNUT—EBONY—MAPLE  
OAK—POPLAR—ROSEWOOD  
TEAK—WALNUT  
Also hardwood plywoods

**SOFTWOODS**  
SUGAR PINE—CYPRESS—CEDAR  
SPRUCE—DOUGLAS FIR etc.  
**MAURICE L. CONDON CO., INC.**  
242 Ferris Ave., White Plains, NY 10603  
914-946-4111  
Monday through Friday 8 AM to 4:30 PM

**Exotic Woods**

The Sawmill is an excellent wholesale source for exotic and domestic hardwoods, and musical instrument components.

**Call toll free 800-345-3103\* for price lists and information.**

For specialty woods, Martin memorabilia, guitar kits or parts, with no minimum order, ask for Woodworker's Dream

\*In Pennsylvania, call (215) 759-2064

**The Sawmill**  
THE MARTIN GUITAR COMPANY  
Nazareth, Pa. 18064

# DOOR HARPS PLANS & KITS

## WHAT'S A DOOR HARP?

Mounted on the inside of your door, a door harp will welcome your guests with a beautiful musical tune each time the door is opened. You'll find it easy to build these door harps in your shop using only standard 3/4" stock and our special Hardware Parts Kits.

Order the project plan and the hardware parts kits below.

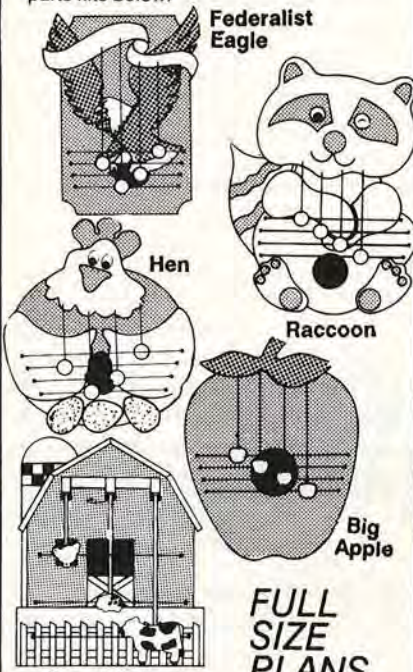

Federalist Eagle

Hen

Raccoon

Big Apple

Barn "Kicker"

**FULL  
SIZE  
PLANS**

## DOOR HARP PLANS

You'll find our jumbo 22" X 34" blueprints very clear and easy to follow. Full step by step instructions explain every step. All drawings are FULL SIZE.

- #W263 Raccoon Plan .....\$3.50/EA
- #W306 Federalist Eagle Plan\$3.50/EA
- #W310 Hen Door Harp Plan..\$3.50/EA
- #W312 Big Apple Plan.....\$3.50/EA
- #W316 Barn "Kicker" Plan.....\$3.50/EA

## HARDWARE PARTS KITS

These kits contain the hard to get parts - special high resonance plywood, tuning pins, clapper balls, music wire and plastic eyes. You need to supply some 3/4" stock, and the paint.

Plan is not included with kit, order separately above.

- #8227 Federalist Eagle HDW Kit.....\$7.00/EA
- #7765 Raccoon HDW Kit.....\$6.50/EA
- #7769 Hen HDW Kit.....\$6.25/EA
- #8252 Big Apple HDW Kit.....\$7.25/EA
- #8338 Barn HDW Kit.....\$8.39/EA

### ADD SHIPPING & HANDLING:

Mail check or money order and include \$3.50 shipping & handling. MN Res. add 8% tax. Alaska and Hawaii send \$9.50 p&h. Canada send \$15.50 (U.S.) p&h. We accept VISA or MC on orders over \$25.00.

Phone toll free 1-800-441-9870.

MN Res. call (612) 471-8550.

Catalog \$1.00 or FREE with order.

**MEISEL HARDWARE  
SPECIALTIES**

P.O. BOX 70 W-4 MOUND, MN 55364

# HOW TO BUY AND CARE FOR YOUR SANDING BELTS

**A**s we tested the machines brought in for the stationary belt sander article on page 58, we noticed that about half of the machines had warped abrasive belts. Since this sort of warpage creates rounded corners on your workpieces, we sought some answers to this problem. We turned for help to Wayne Lee, a product engineer with the Coated Abrasives Division of Norton Co., a leading producer of sanding belts. Here's what Wayne had to say.

## DON'T LET YOUR ABRASIVES RUB YOU THE WRONG WAY

• Like wood, belts cup in two directions, either forming a bulge in their center (dry conditions) or rolling up on their edges (moist conditions), as they sit on a platen. To prevent this from happening, store your belts in a climate of 70° and 50 percent humidity.

• If you can't maintain this climate in your shop—and few of us can—Wayne suggests buying polyester-backed sanding belts. Unlike paper- or cloth-backed belts, polyester belts will not absorb any moisture, making them more resistant to warpage than other belts. When they become loaded with sanding debris, you can even clean polyester-backed belts by scrubbing them

with water and a water-soluble cleaner. If your local abrasive distributor doesn't carry polyester belts, see the buying guide *below*.

## TENSION RELIEVERS

• When you finish using your sander, release the tension on the belt. This can be a hassle with some machines, but not with those that have a locking tension release lever (see the stationary belt sander buy-  
manship chart on page 63).

• As shown *below*, you can extend belt life and improve your machine's performance by properly hanging the belts on cylinders that match the diameter of the rollers on your sanding machine. A narrow hanger such as a peg may damage the backing as well as the bonding that holds the abrasive grit to the backing. A nonlevel hanger may damage the edge of the belt and cause tracking problems.

## BUYING GUIDE

• **Polyester sanding belts.** Available from Norton and Klingspor distributors or by mail from Industrial Abrasives Co. 6×48" belts in 50, 80, 120, and 220 grits, \$3.55 each plus postage. Larger sizes also available. Call 800-428-2222 for ordering information (Pa. residents call 800-222-2292).

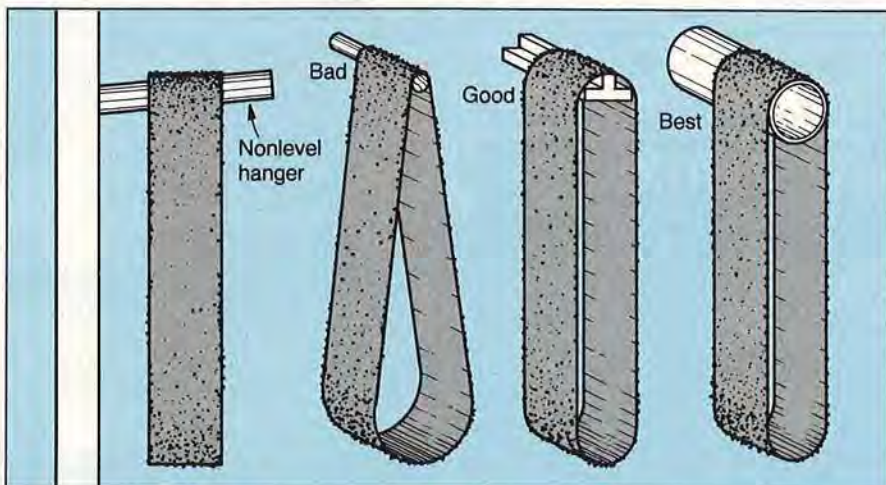

Illustrations: Mike Henry

# FINE-FINISH SCRAPER



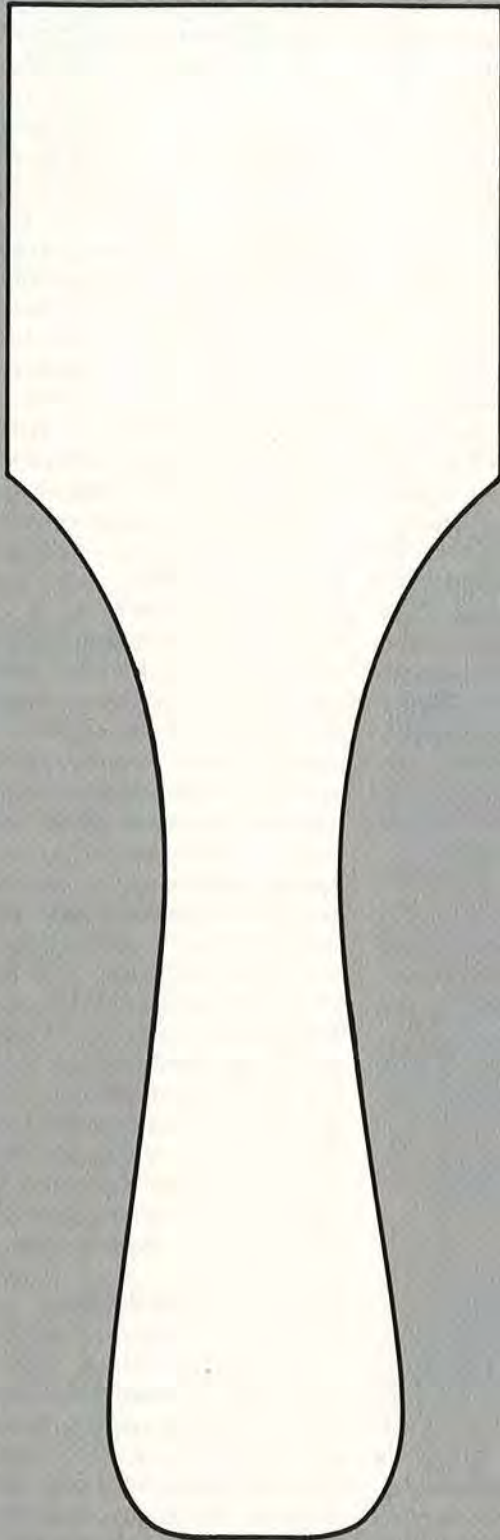









Continued from page 69

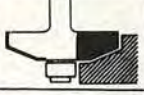

FULL-SIZED HANDLE PATTERN

## CARBIDE TIPPED ROUTER BITS PROFESSIONAL PRODUCTION QUALITY

1000's SOLD TO READERS OF FINE WOODWORKING

BEST CUT BEST PRICE	ITEM NO.	DESCRIPTION	RADIUS	LARGE DIAM.	CUTTING LENGTH	PRICE
	#01	COVE 1/4" R	1/4"	1"	1/2"	\$13.00
	#02	3/8" R	3/8"	1-1/4"	9/16"	14.00
	#03	1/2" R	1/2"	1-1/2"	5/8"	15.00
	#04	ROUND OVER 1/4" R	1/4"	1"	1/2"	\$15.00
	#05	3/8" R	3/8"	1-1/4"	5/8"	16.00
	#06	1/2" R	1/2"	1-1/2"	3/4"	19.00
	#07	ROMAN OGEE 5/32" R	5/32"	1-1/4"	15/32"	\$18.00
	#08	1/4" R	1/4"	1-1/2"	3/4"	20.00
	#11	3/8" RABBETING	Deep 3/8"	1-1/4"	1/2"	\$14.00
	#09	1/8" (KERF) SLOT CUTTER		1-1/4"	1/8"	14.00
	#10	1/4" (KERF) SLOT CUTTER		1-1/4"	1/4"	14.00
	#12	45° Chamfer	45° Angle	1-1/2"	5/8"	\$15.00
	#15	Raised Panel	20° Angle	1-5/8"	1/2"	\$25.00
	#35	1/4" V Groove 90°		1/4"	1/4"	\$ 8.00
	#36	3/8" V Groove 90°		3/8"	3/8"	9.00
	#37	1/2" V Groove 90°		1/2"	1/2"	11.00
	#16	3/8" Dovetail 9°		3/8"	3/8"	\$ 7.50
	#80	1/2" Dovetail 8° (For Leigh Jigs)		1/2"	13/16"	12.00
	#17	1/2" Dovetail 14°		1/2"	1/2"	8.50
	#18	3/4" Dovetail 14°		3/4"	7/8"	10.50
	#19	CORE BOX (ROUND NOSE) 3/8" Core Box	3/16"	3/8"	3/8"	\$11.00
	#20	1/2" Core Box	1/4"	1/2"	11/32"	14.00
	#21	3/4" Core Box	3/8"	3/4"	5/8"	18.00
	#056	Tongue & Groove (FOR WOOD THICKNESS FROM 1/2" to 1")		1-5/8"	1"	\$30.00
	#24	1/4" Straight Bit		1/4"	3/4"	\$ 7.00
	#25	5/16" Straight Bit		5/16"	1"	7.00
	#26	3/8" Straight Bit		3/8"	1"	7.00
	#27	1/2" Straight Bit		1/2"	1"	7.00
	#28	3/4" Straight Bit		3/4"	1"	10.50
	#13	Flush Trim		1/2"	1"	\$ 8.50
	#14	Key Hole (This Bit Only HSS)		3/8"	CUTS 3/8" KEY HOLE FOR FLUSH MOUNTING PICTURE FRAMES, ETC.	\$ 8.50

WHEN ORDERING ANY THREE OR MORE DEDUCT \$1.00 EACH  
ALL PRICES POSTAGE PAID

Professional Production Quality • 1/2" Ball Bearing Pilot  
• 1/4" Diameter Shanks x 1-1/4" Long • One Piece Construction  
• Two Flute Thick High Quality Tungsten Carbide Tips

To order by MasterCard or Visa Toll Free  
7 Day—24 Hour Order Service Call  
1-800-533-9298  
or send check to:

**MLCS Ltd., P.O. Box 4053D, Rydal, PA 19046**

# WHAT CHOOSY BIRDS LOOK FOR WHEN THEY GO HOUSE HUNTING

When he's not behind his desk as staff naturalist for *Bird Watcher's Digest*, Lynn Barnhart monitors a 25-mile trail of bluebird houses or takes on a bird-banding operation. We were pleased when this Ohio resident took time from his busy schedule to offer us some professional advice on birdhouses (also called nest boxes).

• If you hang it from a tree limb with wire or rope, use a two-point attaching system to minimize swaying. A birdhouse supported by only one line will be unstable and allow the box to move too freely, discouraging possible nesters.

• Orient the birdhouse entrance away from prevailing winds and perpendicular to the ground.

• The entrance hole should face straight out or angle slightly downward to keep rain from being blown into the nesting box.

• Also, if possible, position the house so it is out of direct sunlight for at least part of the day. Shade helps keep the box cooler.

## WHERE BIRDS HANG OUT

Where you hang your birdhouse determines which species will nest in it. Smaller nesting boxes placed in wooded areas will likely attract chickadees, nuthatches, titmice, and woodpeckers. Large houses in wooded areas attract owls and with water nearby, wood ducks. The smaller box, placed along brushy hedgerow between field and forest, draws wrens and deermice. Larger boxes located in the same terrain, or in small patches of trees surrounded by open fields, may summon kestrel and barn owls. Boxes placed along country roads that run through open farmland provide an inviting home for bluebirds.

## TO FINISH OR NOT TO FINISH

A weathered, unpainted box looks the best—naturally. But unless you make the box of decay-resistant cedar, redwood, or cypress, you'll probably want to protect it with an exterior finish. Almost any finish will do, but never finish the birdhouse interior. Paints in neutral or natural colors such as light brown, green, or gray work well. Raw linseed oil also provides protection to the wood. After finishing the box, let it weather outside for a month. This allows time for the paint vapors to dissipate.

Unfortunately, boxes placed near a farm or home primarily attract pesky house sparrows. They'll take over and keep other, more desirable birds from using the nesting box. The sometimes-ruthless sparrows even kill occupants already nesting in the box.

For more information on birds and birdwatching, order a copy of *Birdwatcher's Digest* for \$3.50. A one-year subscription (6 issues) costs \$15. *Birdwatcher's Digest*, P.O. Box 110, Marietta, OH 45750.

## SUPPORT YOUR LOCAL BIRDHOUSE

How high you hang your house isn't as crucial as you might think. (See chart on page 80.) Warblers, chickadees, wrens, and bluebirds nest in boxes placed anywhere from 4–15' above the ground. However, heeding the following guidelines will pay big dividends:

• Fasten your birdhouse firmly to a tree trunk, pole, or post, and place it in such a way that you can get to it to monitor for unwanted species and clean it.

## KEEP A TIDY HOUSE

Cleaning a birdhouse rates as the most important thing you can do once you've hung the box. Check the box each spring, before the nesting season, to clear out mouse nests or debris left from winter occupants. Clean the box after each nesting season. Left to build up, the top of a nest can come too close to the entrance hole, allowing predators to reach in and steal eggs or



	QTY.	TOTAL
3-1/2" Economy Shaker Peg	\$14.00 / 100	
3-1/2" Premium Shaker Peg	\$20.00 / 100	
2-1/2" Medium Shaker Peg	\$12.00 / 100	
1-3/4" Mini Shaker Peg	\$ 7.00 / 100	
Bean Pot Candle Cup	\$16.00 / 100	
Mini Bean Pot	\$ 8.00 / 100	



3/4" x 1/8" Hearts	\$ 3.50 / 100	
1" x 1/8" Hearts	\$ 4.00 / 100	
1" x 1/4" Hearts	\$ 6.00 / 100	
1" x 1/2" Hearts	\$ 6.50 / 100	
1-1/4" x 1/8" Hearts	\$ 5.00 / 100	
1-1/4" x 1/4" Hearts	\$ 7.20 / 100	
1-1/4" x 1/2" Hearts	\$ 8.50 / 100	
1-3/4" x 1/8" Hearts	\$ 9.50 / 100	
2" x 1/4" Hearts	\$12.90 / 100	



1" Maple Toy Wheels	\$ 6.00 / 100	
1-1/4" Maple Toy Wheels	\$ 7.00 / 100	
1-1/2" Maple Toy Wheels	\$ 8.00 / 100	
Axle pegs for above wheels	\$ 4.00 / 100	
1-1/2" Maple Spindles	\$ 8.00 / 100	
2" Maple Spindles	\$14.00 / 100	

## Door Harp Parts!



3/4" prebored Door Harp Balls	\$ 8.00 / 100	
Tuning pins	\$17.00 / 100	
Wire-550 Ft. 12 gauge	\$12.00 / roll	
1" Full Round Balls	\$12.00 / 100	
1-1/2" Full Round Balls	\$19.50 / 100	
2" Full Round Balls	\$10.00 / 10	
2-1/2" Full Round Balls	\$ 1.50 each	
3" Full Round Balls	\$ 2.50 each	



1-5/8" Sawtooth Hanger	\$ 4.00 / 100	
Small picture Hanger	\$ 2.00 / 100	
*17 Screw Eye 1/2" long	\$ 2.00 / 100	
*14 Screw Eye 13/16" long	\$ 3.00 / 100	
Small Eggs 1-3/8" x 2"	\$ 8.75 / 25	
Large Eggs 1-7/8" x 2-1/2"	\$12.50 / 25	
Apples	\$ 1.50 each	



**ALL NEW WOOD PARTS CATALOG \$1.00**  
(Free With Order)

Total for Goods	
Texas Only - Add 7% Sales Tax	
Handling and Insurance	\$3.00
<b>Total</b>	

B29

MC OR VISA

CHECK ENCLOSED

ACCOUNT # \_\_\_\_\_

EXPIRES \_\_\_\_\_ PHONE \_\_\_\_\_

NAME \_\_\_\_\_

SHIP TO \_\_\_\_\_

CITY/STATE/ZIP \_\_\_\_\_



**Woodworks**

4500 Anderson Blvd.  
Fort Worth, Texas 76117  
**(817) 281-4447**





Illustration:  
Jim Stevenson

the young. Cleaning the box also keeps parasites to a minimum. If the box becomes infested with insects, dust it with a pyrethrum or rotenone pesticide in the fall; never dust when the house is inhabited.

### GIVE 'EM SOME AIR

Although wood has excellent insulating properties, birdhouse interiors can overheat. Drill ventilation holes near the roof, two per side, except for the back. Drill 1/4" holes for small boxes and 1/2" holes for larger ones. Drill the holes near the roof and angle them slightly upward into the box to prevent rain from blowing in.

### KEEP 'EM DRY

Drainage holes allow water condensation and rain seepage to escape through the bottom of the nesting box. To create drainage, position the nesting box side pieces slightly higher than the bottom piece to create two narrow gaps. Or, drill four or five 1/4" holes in the box bottom. Each time you clean the box, clear all vent and drain holes of debris.

### PLAYING MOTHER

Children don't like mothering, but birds—especially bluebirds—don't mind the fuss. The most important reason to monitor a birdhouse is to rid it of house sparrows. Although persistent, sparrows eventually will abandon a nesting box if you repeatedly remove their nests.

*Continued on page 80*

## WOODWORKERS

**DOWEL CRAFTER™**

Self-Aligning  
Doweling Jig

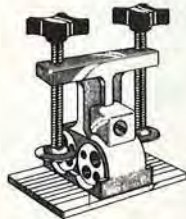

\$35.95 ppd

FREE CATALOG SUBSCRIPTION  
WITH PURCHASE.

CATALOG ONLY.

2 year subscription (8 issues) \$4.00.  
Free \$5.00 gift certificate with catalog  
order.

R. A. NESS & CO.  
**THE WOODWORKERS  
EMPORIUM**

8888 N. MILWAUKEE AVE.

NILES, IL 60648

(312) 824-0565



## FERRIS WHEEL

21" HIGH, 16" WIDE, 12" DEEP

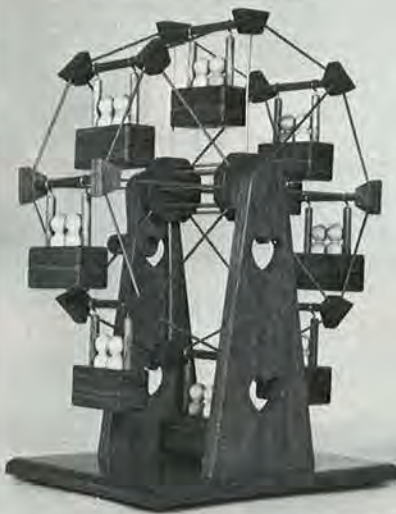

Ferris Wheel delights children of all ages with whirling motion in gleaming brass and wood construction. **FULL SIZE PLAN PLUS COMPONENTS:** 16 wood people, Roto-Hinge, bushings, brass hooks, screws and 20 feet of solid brass rod. Step-by-step directions guide you to success. Fast **FREE** shipping. Plan and Tool Catalog **FREE** with order; \$1.00 separately. Send order **TODAY** to:



RJS Custom Woodworking  
P.O. Box 12354, Dept. Z  
Kansas City, Kansas 66112

27 SHOWS IN 1989!  
• Free Workshops  
• 100 Exhibits • Prize Drawing

★ **THE  
WOODWORKING  
SHOW** ★

machinery  
tools—supplies



See the Widest Variety of Woodworking  
Products All Under One Roof  
**HUNDREDS OF ITEMS**

Machinery • Power & Hand Tools • Supplies

Kansas City	Jan. 27-28-29
Indianapolis	Feb. 3-4-5
Colorado	Feb. 10-11-12
North Texas	Feb. 17-18-19
Greater Milwaukee	Feb. 24-25-26
South Florida	Mar. 3-4-5
Metro-Richmond	Mar. 10-11-12
Arizona	Mar. 17-18-19
No. California	Mar. 31-Apr. 2
Tennessee	Apr. 7-8-9
Atlanta	Apr. 14-15-16
Connecticut	Apr. 21-22-23
Chicagoland	Apr. 28-29-30
Greater Cleveland	May 5-6-7

... and more!

Seminars by Ian Kirby - Roger Cliffe  
- Bob Rosendahl - Rude Osolnik  
Nick Cook - and other Master Craftsmen  
**1-800-826-8257 or 213-477-8521**  
Call for free brochure 8:30-5 Pacific Time

Save \$1 off reg. \$6 admission  
with this ad

**NEW**

**FREE** - The most complete selection of scroll saw blades, accessories, and improvements for almost any scroll saw, plus much, much more!



Catalog from  
the exclusive  
distributors of  
**HEGNER &**

**FELDER Woodworking Machinery.**

Includes HEGNER Precision Scroll Saws, Lathes & Lathe Duplicators, JET Clamps, Workbenches, FELDER Systems, and more!

A \$2.00 value, now offered **FREE** during this special promotion.

CALL  
**TODAY 1-800-962-2589**  
**TOLL-FREE FOR YOUR COPY**

Name \_\_\_\_\_

Address \_\_\_\_\_

City, State, Zip \_\_\_\_\_

Phone ( ) \_\_\_\_\_

**ADVANCED  
MACHINERY  
IMPORTS LTD.**

P.O. Box 312  
Dept. 330  
New Castle, DE  
19720

# TOOLS etc.

CALL TOLL FREE  
ORDERS ONLY

1-800-327-6250  
OTHER INFORMATION  
714-525-3581

8 AM to 5:30 PM PST  
1567 HARBOR BLVD.  
FULLERTON, CA 92632



ALL ORDERS SHIPPED UPS FREIGHT  
PREPAID (CONTINENTAL USA) ON  
ORDERS \$50. OR MORE. SINGLE  
ITEMS WEIGHING 70 LBS. OR MORE  
ARE SHIPPED F.O.B. SANTA FE  
SPRINGS, CA. CALL FOR DISCOUNT  
FREIGHT RATES. SALE PRICES,  
LIMITED TIME ONLY AND SUBJECT  
TO CHANGE WITHOUT NOTICE.

NEED IT QUICK?  
FEDERAL EXPRESS  
SHIPPING AVAILABLE



**HITACHI**

**\$189**

TR12 3 HP  
Plunge Router  
with \$60.00  
Accessory  
Package.

You get:

- \* Straight guide
- \* Micro guide holder
- \* Roller guide
- \* 1/4, 3/8 and 1/2" collets
- \* Template guide
- \* Template guide adapter
- \* 1/2" carbide straight bit

**BOSCH**



**\$159**

1581 VSK Top-  
handle jig saw kit  
with metal  
case **\$159**



**PORTER-CABLE**

330 Finish Sander with  
Free Stik-It Pad New  
Model with 15000  
OPM **\$59**



**PORTER-CABLE**

5116 Omni-jig Dovetail  
Machine with Half-  
Blind Template,  
Dovetail bit, template  
guide and manual. **\$299**



42000 Template guide  
kit. Fits most routers. **\$39**

**PORTER-CABLE**



**\$159**

**NEW!**  
**ADJUSTABLE  
FENCE FOR THE  
PORTER-CABLE  
555**

- \* Tilts 0-45°
- \* Slides parallel up &  
down
- \* Precision accuracy
- \* Screws right on, no  
drilling or tapping.

**INTRODUCTORY  
OFFER \$59.95**

555 Bisquit joiner  
with case **\$159**

555A Bisquit joiner  
with adjustable fence &  
metal case **\$199**

AFPC adjustable fence  
for 555 **\$59.95**

0-10-20 Bisquits **\$29**



**Elu \$299**

WOODWORKING TOOLS BY  
BLACK & DECKER

#3338 2 1/4 H.P.  
electronic variable  
speed plunger  
router.

**freud**

New Freud Thin Kerf  
Carbide Blades

LU87M010 10" x 24T  
Ripping **\$44**  
LU88M010 10" x 60T  
Cut-Off **\$54**

FINE CUT-OFF CROSS CUT BLADES

LU73M008 8"X48T ATB **\$54**  
LU73M009 9"X54T ATB **59**  
LU73M010 10"X60T ATB **39**  
LU73M012 12"X72T ATB **85**  
PRECISION PLYWOOD BLADES  
LU82M008 8"X48T TCG **59**  
LU82M009 9"X54T TCG **64**  
LU82M010 10"X60T **59**  
LU82M012 12"X72T TCG **92**

COMBINATION BLADES

LU84M008 8"X40T COMB. **53**  
LU84M009 9"X40T COMB. **53**  
LU84M011 10"X50T COMB. **34**  
LU84M012 12"X60T COMB. **69**

RIPPING BLADES

LM72M008 8"X24T FLAT TOP **43**  
LM72M010 10"X24T FLAT TOP **36**  
LM72M012 12"X30T FLAT TOP **65**

SUPER FINE CUT-OFF BLADES

TEFLON COATED  
LU85M008 8"X48T ATB **\$69**  
LU85M009 9"X54T ATB **75**  
LU85M010 10"X60T ATB **59**  
LU85M012 12"X72T ATB **99**  
LU85M014 14"X108T ATB **119**  
LU85M015 15"X108T ATB **149**

ATB = Alternate Top Bevel

TCG = Triple Chip Grind

SC-001 Saw Blade Stabilizer **17**

CARBIDE DADO SETS

DS306 6" Dado **\$99**  
DS308 8" Dado **109**  
AD800 8" Adjustable Dado **49**  
JS-100 Joining Machine **169**  
0-10-20 Bisquits box of 1000 **29**



94-100 5pc Cabinet Set **\$179**  
95-100 5pc Cabinet Set with 99PK-1  
Multiform **\$229**

Both Sets Come With FREE Door  
making book!

90-100 15pc Carbide set **\$179**  
91-100 13pc 1/2" Shank set **\$199**  
91-102 6pc 1/2" Shank set **\$89**  
91-104 6pc 1/2" Shank set **\$129**  
92-100 26pc router bit set **\$295**



FB-107 7pc Forstner bit set **\$49**  
FB-100 18pc Forstner set **\$179**

WC-106 6pc Chisel Set **\$39**  
WC-110 10pc Chisel Set **\$59**

# NEVER AN EMPTY NEST

Designing, Building, and Hanging Birdhouses

Continued from page 79

Interior Floor Size	Diam. of Entrance Hole	Center of Entrance Hole to Floor	Depth of Cavity	Height of Box Placement
<b>BLUEBIRDS (Eastern and Western)</b>				
5x5"	1 1/2"	7"	8-9"	5-15'
<b>CHICKADEE (black-capped, Carolina, Boreal, and chestnut-backed)</b>				
4x4"	1 1/8"	6-8"	8-10"	8-15'
<b>FINCH (house)</b>				
6x6"	2"	4"	6"	8-12'
<b>FLYCATCHERS (great crested, olivaceous, Western, and ash-throated)</b>				
6x6"	2"	7-8"	8-10"	8-20'
<b>NUTHATCHES (red- and white-breasted)</b>				
4x4"	1 1/4"	6"	8"	12'
<b>OWL (barn)</b>				
10x18"	6"	7"	15-18"	12-18'
<b>OWL (screech)</b>				
8x10"	3 1/4"	12"	16-18"	12-30'
<b>OWL (barred)</b>				
13x15"	8"	9-12"	16"	10-30'
<b>OWL (saw-whet)</b>				
7x7"	2 1/2"	12"	12-15"	15-20'
<b>ROBIN (American)</b>				
7x7"	open on three sides		8"	6'
<b>SWALLOWS (barn)</b>				
6x6"	open on three sides		6"	8-12'
<b>SWALLOWS (purple martin)</b>				
6x6"	2 1/2"	2 1/2"	6"	15-20'
<b>TITMICE (plain, tufted, and bridled)</b>				
4x4"	1 1/4"	6"	6-8"	6-15'
<b>WARBLER</b>				
5x5"	1 1/8-1 1/2"	6-8"	8-10"	4-6'
<b>WOODPECKER (downy)</b>				
4x4"	1 1/4"	6-8"	8-10"	12-15'
<b>WOODPECKER (flicker)</b>				
7x7"	2 1/2"	14-16"	16-18"	6-20'
<b>WOODPECKER (gold-fronted and hairy)</b>				
6x6"	1 3/4-2"	9-12"	13-15"	8-20'
<b>WOODPECKER (red-headed and red-bellied)</b>				
6x6"	2"	9-12"	12-15"	12-20'
<b>WRENS (Bewicks and house)</b>				
4x4"	1 1/8"	5 1/2"	7-8"	6-10'
<b>WRENS (brown-throated)</b>				
4x4"	1"	3 1/2-6"	6-8"	6-10'

# Like Having A Lumberyard Right In Your Shop!



MADE IN U.S.A.

**NOW! Choose From  
Two Sizes—Popular  
12-in. Planer or  
NEW 18-in. Model!**

Only **Woodmaster**<sup>®</sup>  
lets you

## PLANE MOLD & SAND

with the Precision Control of  
**Infinitely Variable Power-Feed!**

**MAKES YOU MONEY... SAVES YOU MONEY!**

Put this versatile power-feed tool to work in your own shop . . . see how fast it pays for itself! Quickly converts low-cost rough lumber into valuable finished stock. Turns out perfect picture frame moldings, quarter-round, casing, tongue & groove . . . all popular patterns . . . any custom design!

✓ **Just a twist of the dial** puts twice as many cuts-per-inch at your fingertips as any comparable planer—from 70 to over 1,000 CPI! This heavy-duty machine will sail through even the toughest oak at higher speeds, or you can slow it down to handle those “hard-to-work” pieces like curly maple, knotty cedar, burls, knees and much more! A valuable feature for molding work, where profiles make sanding impossible.

✓ **Now choose from two powerful models!** Woodmaster introduces the first 18” Planer/Molder . . . the “Big 18” . . . with all of the features that have made the 12-inch model the most versatile Planer/Molder on the market.

✓ **Change to Molding or Sanding in just minutes!** Unique “Morse-Taper” Quick Change Cutterhead guarantees fast change-over . . . bearings remain factory set . . . precisely aligned at all times.

### Here's What Woodmaster Owners Say:

**Shop Test Results**—“It does an excellent job of planing, on a par with more expensive machines, and even better than some commercial models.”

*Editor, Workbench Magazine*

**Gets More Done**—“I build grandfather clocks, music boxes, toys and picture frames. They say a craftsman is only as good as his tools, and let me tell you, my Woodmaster is tops. I get more done, and done right, than I ever did before.”

*R.V. Delacourt, Cleveland, Ohio*

**Best Value**—“After checking them all, Woodmaster was obviously the best deal for the money. Also, I would like to acknowledge the polite and prompt service.”

*E. D. Holtz, North Carolina*

**Likes Woodmaster Best**—“I have two other planers in my shop . . . wouldn't trade my Woodmaster for either one. I am delighted with its versatility and precision.”

*Ron's Custom Cabinets, Colorado*

**Paid Off Fast**—“Paid for itself in no time flat.”

*E. L. Walters, North Dakota*



Woodmaster's Quick-Change Molding Head lets you create custom moldings from any stock. Choose from over 250 standard trim and picture frame patterns . . . or design your own!



Power-fed sanding speeds production and improves the quality of your work. No more waves or cross-grain scratches. Separate sanding head installs in just minutes.

**MAIL COUPON TODAY OR CALL TOLL FREE 1-800-538-4200 Ext. 2330**

### FREE 30 DAY TRIAL!

Send for complete information on how you can try this versatile power tool in your own shop for 30 days. You must be satisfied! We'll also send you details on Woodmaster's One Full Year Warranty and our convenient Easy-Payment Plan.



**YES!** Please rush me your FREE Information Kit which tells in words and pictures why this amazingly designed powerfeed shop is so much better than other single-purpose or combination tools. Also send me details on your 30-DAY FREE TRIAL GUARANTEE.

Woodmaster Tools, Dept. PW30, 2908 Oak, Kansas City, MO 64108

NAME \_\_\_\_\_

ADDRESS \_\_\_\_\_

CITY \_\_\_\_\_

STATE \_\_\_\_\_ ZIP \_\_\_\_\_

# WOODWORKER'S CATALOG



There are over 4,000 money-saving reasons why woodworkers rely on Constantine.

Unique products. Hard-to-find products. 4,000 woodwork items! Everything important for people who like to Build-Restore-Repair-Refinish—and like to save money doing it. Cabinet or furniture wood? Choose from over 200 sizes and kinds. Beat up surface to cover? Choose from 150 richly-grained veneers. Plus 500 plans . . . cabinet hardware . . . 96 How-To Books . . . 118 carving tools and chisels . . . 76 inlay designs . . . and lots more for One-Stop, Right-Price Shopping without leaving home!

**CONSTANTINE** Est. 1812  
2051N Eastchester Road, Bronx, NY 10461

**CONSTANTINE** Est. 1812 Send 116 page  
2054R Eastchester Road catalog  
Bronx, New York 10461 \$1.00 enclosed

Name \_\_\_\_\_  
Address \_\_\_\_\_  
City \_\_\_\_\_ State \_\_\_\_\_ Zip \_\_\_\_\_



The All-New **ScrollMate** Scroll saw

3 Speeds—Handles a variety of materials.  
Capacities— 14" Throat depth  
-2" Depth-of-cut  
**Built-in Blower**—(standard) Keeps the cutting line clear of sawdust at all times.  
**Smooth, Quiet Operation**—Delivers the sound and feel of quality.  
**Plenty Of Power**—Totally enclosed, fan cooled, induction motor lets you tackle big and small jobs with equal ease.  
**Compact**—Small enough for the utility room or garage with room to spare.  
**Built To Last**—Made of rugged, cast aluminum for a lifetime of dependable service.

LIMITED 2-YEAR WARRANTY

For your **FREE FACT KIT**  
Send your mail-in inquiry to:



SAKURA, U.S.A.  
P.O. Box 710-CF  
Xenia, Ohio 45385  
or call 1-800-533-3728  
Dealer Inquiries Invited

Scroll Saw users, Sign makers....  
Announcing a **PRICE BREAKTHROUGH**

**PLASTIC LETTERING GUIDES**  
ONLY \$12 / set !!!

• Neptune 1-1/2" style with full upper/lower case alphabet+numbers • Made from durable .030" plastic, beveled edges, precision cut for accurate alignment • Package includes **FREE** pattern set. Shipped postage paid • Similar guides are sold by others for over \$40 !!



Penn State Industries • Dept. LW  
2850 Comly Rd • Phila PA 19154  
Check, Visa/Mc accepted



## SQUARE DRIVE SCREWS

- "Cam-Out" is a Thing of the Past
- Heat Treated for Strength
- Deep Thread for Holding Power

**SPECIAL:** 100 each of the following sizes, plus a power driver bit and hand driver.

Size	Length	Price
#6x 1/2, 3/4, 1, 1 1/4, 1 1/2		13.35
#8x 3/4, 1, 1 1/4, 1 1/2, 2, 2 1/2		16.65
#10x 1 1/4, 1 3/4, 2, 2 1/4, 2 1/2, 3		23.65
	Order Total	\$ & H
	Shipping & Handling	\$0.1 to \$20.00 \$3.00
	U.P.S. Ground Service	\$20.01 to \$50.00 \$4.50
	Va. Res. add 4.5% Tax	\$50.01 to \$80.00 \$6.00
		Over \$80.00 \$7.50



**McFEELY** P.O. Box 3, 712 12th St.  
HARDWOODS Lynchburg, VA 24505  
1-800-443-7937 • In VA 1-800-542-2023

# MAKE MONEY

WITH FURNITURE RESTORATION

SAFE, DEPENDABLE, EASY stripping and refinishing systems and products, featuring **HYDROCOTE™** water-base finishes.

**AMITY**

Quality Restoration Systems

Wisconsin: 608-837-8484  
Nationwide: 800-334-4259

## BACKYARD STRUCTURES



Included are 65 **Full Color** designs for Storage Sheds, Animal Shelters, Barns, Studios, Cabanas, and Garage Enclosures. Full construction plans for all designs are available. **Backyard Structures... \$8.95**  
**Also available - Bridges & Cupolas... \$8.95**  
**Gazebos & Other Garden Structures... \$8.95**  
Please include \$1.90 postage and handling for 1st copy, .50 for each additional book.



**SUN DESIGNS**  
173 E. Wisconsin Ave.  
P.O. Box 6, Dept. 34  
Oconomowoc, WI 53066  
(414) 567-4255  
MONEY BACK GUARANTEE - MC & VISA ACCEPTED

**WOODWORKERS!**  
We've Got The Tools You Need...  
Give Us A Call Today.



**PORTER-CABLE**  
PROFESSIONAL POWER TOOLS  
\$55

**w.s. JENKS & Son**



1933 Montana Ave. NE (202) 529-6020  
Washington DC 20002 1-800-638-6405



## 89 JIG SAW PATTERNS

UP TO 21" HIGH

89 FULL SIZE patterns of beautiful Wall & Corner Shelves, Bird Houses, Action Toys, Novelties, Lawn & Animal Figures, Flying Duck, Sprinkling Girl! P.L.U.S. dozens of other easily made things. Just trace, cut out & paint! Order the JIG SAW PACKET today. Only \$7 Postpaid 1st Class.

**MASTERCRAFT PLANS WEST, Dept. 34H**  
P.O. Box 625, Redmond, WA 98073

## 90 PATTERNS

LAWN ORNAMENTS • NOVELTIES

FULL SIZE patterns up to 20" high of Dutch boy and Girl, Dwarf, Penguin, Fishing Boy, Animals, Birds, Novelties and many other popular items. Easy to make and sell. Just trace, cut out and paint. Send \$7 today for the **LAWN ORNAMENT PACKET** containing all 90 patterns. Prepaid, 1st Class.

**MASTERCRAFT PLANS WEST, DEPT 32H**  
P.O. Box 625, Redmond, WA 98073



## Wood-Mizer®

World's Largest Manufacturer Of Portable Sawmills



**OWN YOUR OWN SAWMILL**  
Four Models To Choose From  
BUY DIRECT

**1(800)553-0219**

In Indiana call: (317) 271-1542  
**FREE** 44-page catalog or use your MasterCard or VISA to order our 50-minute demonstration video—\$10.00

Wood-Mizer Products, Inc. • Dept. QO31  
8180 W. 10th St., Indianapolis, IN 46214-2430

## Sleeveless DRUM SANDER

Uses regular sandpaper — no pre-made sleeves to buy!



**Lifetime Guarantee**

USE ON:  
Drill press, motor, lathe, combo-tools, radial saw, drills.

Twist of key tightens sandpaper to drum. Rubber backing insures long sandpaper wear.

1" x 3" long	\$13.95
2" x 3" long	\$15.95
2 1/2" x 3" long	\$16.95
3" x 3" long	\$17.95
1" and 2 1/2" above	\$27.95
Set of 4 above	\$56.95
3/4" x 3" long	\$14.95
2 1/2" x 4 1/2" long	\$21.95
3" x 4 1/2" long	\$23.95
2 1/2" x 6" long	\$25.95
3" x 6" long	\$27.95
Add \$2.50 per order for shipping.	

AVAILABLE WITH:  
1/2" bore with 1/2" or 1/4" shaft  
1/2-20 RH thread (except 3/4" x 3")  
3/4" bore (except 3/4" x 3" and 2" x 3")

MC, Visa, Check or Money order to:  
**SINGLEY SPECIALTY CO. INC.**  
P.O. Box 5087B, GREENSBORO, NC 27403  
CALL: (919) 852-8581

**DML CLAIMS CARBIDE BREAKTHROUGH**

Long-lasting performance has always been the benchmark that sets carbide-tipped saw blades apart from other blades. Now, DML, a subsidiary of Vermont American, has developed a new carbide—dubbed Dyanite—that they claim outlasts any existing carbide.

DML tested the blades in three different case studies and found that Dyanite blades last twice as long as standard carbide blades in particleboard, 20 to 30 percent longer in hardwoods, and 11 times longer in green hardwoods. Why? DML says Dyanite better resists high temperatures and the corrosive acids found naturally in wood.

At *WOOD*® magazine we don't have laboratory conditions to test durability, but to test the blades for quality of cut, we took three blades—24-tooth rip, 40-tooth combination, and 60-tooth cutoff—into









our shop for a tryout. I found that all three blades produced cuts comparable to other high-quality carbide-tipped blades. Of the three I tested, the combination blade was surprisingly the most impressive. It produced smoother crosscuts than the cutoff blade, and made less-labored rip cuts than the ripping blade. If you want to pick up one

of these wood gobblers, the combination blade should be at the top of your list.

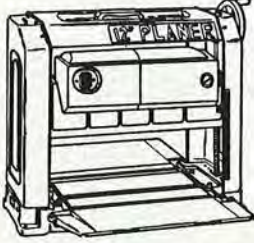
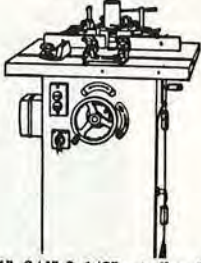
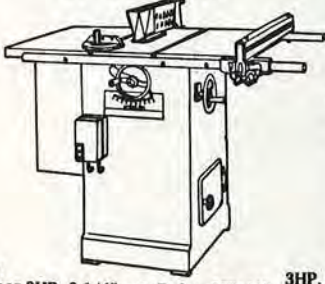
—Tested by Jim Downing, *WOOD* magazine's design editor  
DML Golden Eagle Dyanite saw blades; the 40-tooth combination blade has a suggested retail price of \$72. Call 800-233-7297 for the dealer nearest you.

Continued on page 84

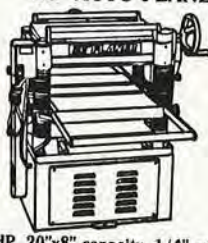
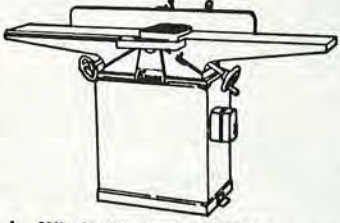
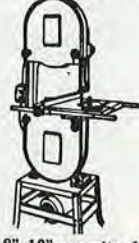
**TRANSPOWER** A COMMITMENT TO EXCELLENCE • ORDER TOLL FREE 1-800-654-7702

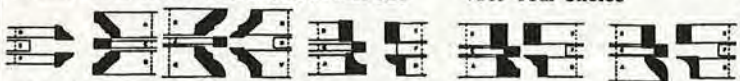
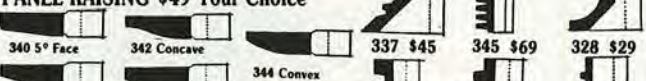
<p><b>12" AUTO PLANER</b></p>  <p>2HP, 12.5"x6" capacity, 2 feeders, 8000 RPM/16000 cuts, 1/8" cut, 65 lbs. <b>Sale \$328</b></p>	<p><b>3HP SHAPER</b></p>  <p>1", 3/4" &amp; 1/2" spindles, 3HP, 2 rever. speeds, router chuck, 20"x20" table, 2.5" travel, 350 lbs. <b>Sale \$645</b></p>	<p><b>10" TABLE SAW</b></p>  <p>3HP, 3-1/4" cut, T slot, 27"x40" table, precision fence, 440 lbs. <b>Sale \$745</b></p>	<p><b>15" AUTO PLANER</b></p>  <p>3HP, 15"x6" capacity, 2 feeders, 3 blades, 1/4" cut, 15300 cuts, 520 lbs. <b>Sale \$645</b></p>	<p><b>90" EDGE SANDER</b></p>  <p>2HP, 6"x90" belt tilts 90°, 28" cast iron table, adj. fence, 260 lbs. <b>Sale \$445</b></p>					
<p><b>DUST COLLECTOR</b></p>  <p>2HP, three 4" holes, 1500 CFM, 21"x37" base w/casters, 210 lbs. <b>\$335 prepaid</b></p>	<p><b>20" AUTO PLANER</b></p>  <p>5HP, 20"x8" capacity, 1/4" cut, 4 blades, 2 speeds, auto 2 feeders, 980 lbs. <b>Sale \$1175</b></p>	<p><b>8" JOINTER</b></p>  <p>2HP, 9"x68" long bed, 3 blades, 1/2"x8" cut, 36" fence, 4500 RPM, 500 lbs. <b>Sale \$625</b></p>	<p><b>18" BAND SAW</b></p>  <p>2HP, 18"x10" capacity, 18" table, adj. fence, 680 RPM, 380 lbs. <b>Sale \$595</b></p>	<p><b>6"x12" SANDER</b></p>  <p>2HP, 6"x48" belt, 12" disc, tilting table, vert/horizontal, 180 lbs. <b>Sale \$325</b></p>					
<p><b>INDUSTRIAL CARBIDE MULTI-CUTTER SET \$169 Your Choice</b></p>  <p>21 Cabinet Set   22 Cove Bead   23 Concave Set   24 Ogee Set   25 Convex Set</p>					<p><b>PANEL RAISING \$49 Your Choice</b></p>  <p>340 5° Face   342 Concave   344 Convex   343 12° Face</p>				
<p><b>TRANSPOWER</b> TCM Industries, Inc. 322 Paseo Sonrisa, Walnut, CA 91789</p>					<p>IN CA. (714) 594-0780</p>				

# SIGNCARVING IS FUN & PROFITABLE!



And it's easy, if you use the Marlin Woodcarvers and accessories. You can carve signs quickly at home or at swap meets. *No special training is required.* The machines do the work, the operator has the fun and the profits. These machines will also 3-D carve panels and plaques.

SEND \$1.00 FOR OUR FULL LINE BROCHURE AND PRICE LIST AND START PLANNING YOUR FULL OR PART-TIME BUSINESS.



**MARLIN INDUSTRIES, INC.**

Rt. 70, Box 191, Dept. D94  
Cashiers, NC 28717  
(704) 743-5551

## PRODUCTS THAT PERFORM

Continued from page 83

### AN EXACTING EDGER



The Edger helps you sharpen X-acto blades Nos. 11 and 16—the two most common types. The tool holds the blade at the right angle and focuses the honing, as it should, on the point of the knife. Unless you go through a lot of X-acto blades, the Edger may be hard to justify. But, to the craftsman who demands finely honed blades, that shouldn't matter.

—Steve Oswalt

*The Edger, item No. 14293, \$15.45 ppd. from Micro-Mark, 340 Snyder Ave., Berkeley Heights, NJ 07922.*



#8 MODIFIED '57 \$4.95

#10 MONSTER TRUCK \$4.95

STICKLER FOR DETAIL? At last, an exciting new line of REALISTIC Wood Block Models that you can build with your own scrap wood & dowels, and my easy to follow instructions.

**MODIFIED '57** measuring over 11" long, 4 3/4" wide & 3 3/4" high. Includes details of textured bucket seats, deep sunk wheel rims w/ baby moon hub cap, detailed front & rear bumper, hood, and even side pipes.

**MONSTER TRUCK** measuring over 14" long, 11" high, w/ 6 3/4" x 4 1/2" monster wheels, 16 shock absorbers, 5 ton military rears, & rear axle supports. Details from engine, transmission, transfer case, & oil pan to K.C. Lights & mirrors.

Send check or money order in the above amount to:

Gatto Plan Supply, Rt. 1 Box 1568 Hamburg, Pennsylvania 19526  
215-488-6932

## FREE WOODCARVER'S WISHBOOK



You'll find everything you need for decoy, bird and woodcarving in our new 48 page Wishbook including a complete line of special tools, cutouts, patterns, paints and supplies—all backed by our unconditional guarantee.

Send for your FREE catalogue today or Call Toll Free 1-800-221-9474.

## P.C. English, Inc.

P.O. Box 380, Dept. W39, Thornburg, VA 22565

### National Carvers Museum

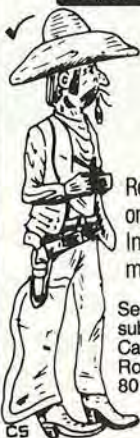

#### LEARN WOODCARVING AT HOME

Receive sample instructional pack on whittling and woodcarving. Includes copy of *Mallet* monthly magazine.

Send \$2.00—deductible upon subscription payment to The National Carvers Museum, 14960 Woodcarver Road, P.O. Box 389, Monument, CO 80132.

(719) 481-4737

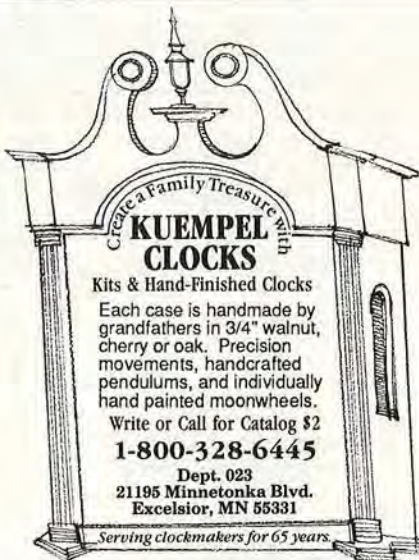

### KUEMPEL CLOCKS

Kits & Hand-Finished Clocks

Each case is handmade by grandfathers in 3/4" walnut, cherry or oak. Precision movements, handcrafted pendulums, and individually hand painted moonwheels.

Write or Call for Catalog \$2

**1-800-328-6445**

Dept. 023

21195 Minnetonka Blvd.  
Excelsior, MN 55331

Serving clockmakers for 65 years.

### HIGH-TECH LUBRICANT



When applied to saw blades, ta blesaw tops, or any surface that benefits from less friction, Dri-Cote reduces drag, prevents resin buildup, and prolongs blade life. I found Dri-Cote especially helpful when applied to the pilots of non-ball-bearing router bits.

—Steve Oswalt

*Dri-Cote, \$11.95 ppd. for a 10-oz. bottle, from Sandaro Industries, 20 Galli Dr., Suite J, Novato, CA 94949. Call 800-999-7009.*



## WOODWORKING WORLD SHOWS

### MACHINERY, TOOLS, SUPPLIES FOR EVERY WOODWORKER

#### THE HOUSTON SHOW

March 3-5, 1989

Fri. 5-9 / Sat. 10-6 / Sun. 10-5

Pasadena Convention Center, Pasadena, TX

#### THE TOLEDO SHOW

April 14-16, 1989

Fri. 5-9 / Sat. 10-6 / Sun. 10-5

Seagate Center, Toledo, Ohio

#### THE BUFFALO SHOW

April 7-9, 1989

Fri. 5-9 / Sat. 10-6 / Sun. 10-5

Erie County Fairgrounds, Hamburg, NY

#### THE BOSTON SHOW

April 28-30, 1989

Fri. 5-9 / Sat. 10-6 / Sun. 10-5

The Bayside Expo Center, Boston, MA

For More Information Call Toll Free M-TH 1-800-521-7623

Woodworking Association of North America - P.O. Box 706, Plymouth, NH 03264 (603) 536-3876

# J E T

A World Of Value.



**\$404.00**  
JBS-14 MW Bandsaw

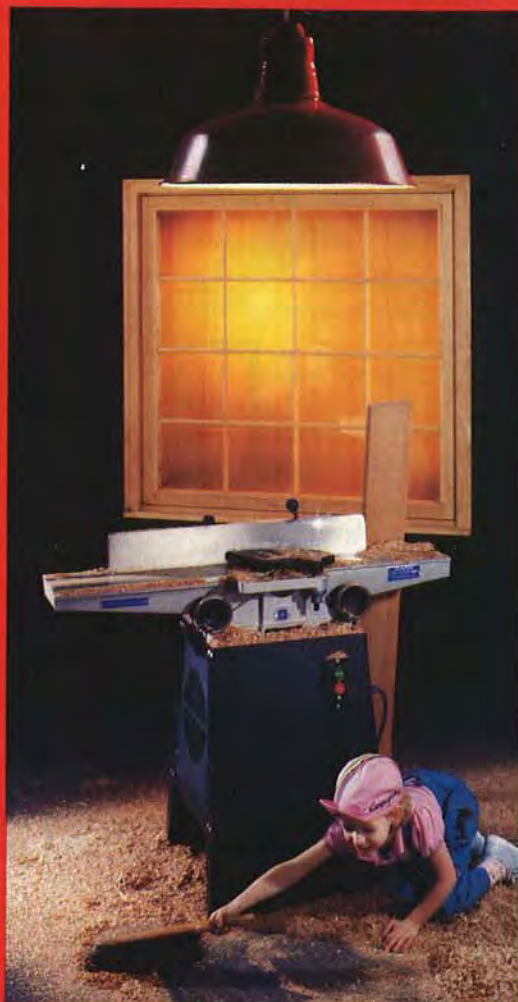

**\$409.00**  
JJ-6 Jointer

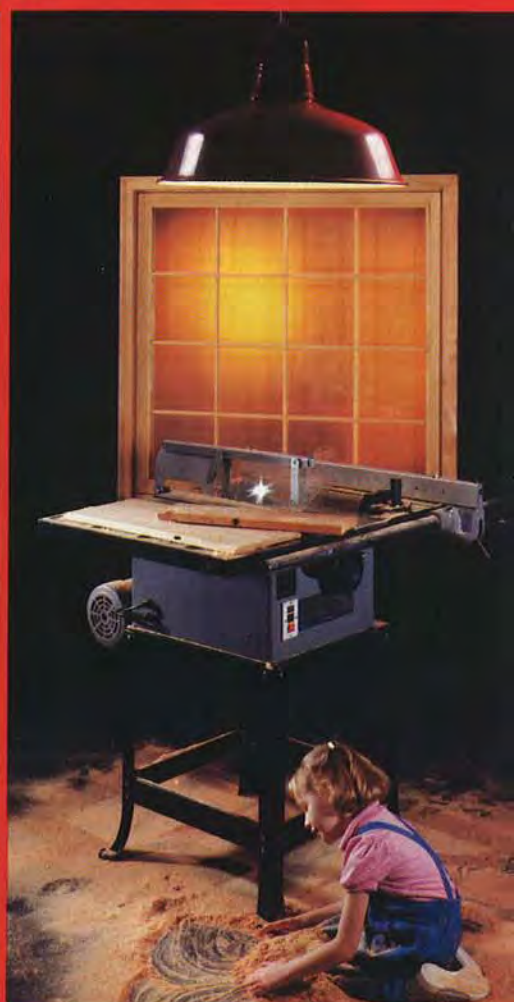

**\$488.00**  
JTS-10 Tablesaw

*“right at home”*

JET wood-working machinery is designed for heavy industrial use but always... “right at home.” When you want quality machinery at affordable prices with readily available replacement parts, repair services and technical advice, look to JET Equipment and Tools.

The 14" Bandsaw features a power-

ful 1 HP motor, a full 6" cutting height, 14" throat depth, and 45° square tilting table.

The 6" Jointer features a 3/4 HP motor, 7" x 42 1/2" table with a 4" x 28" fence with positive stops at 45° and 90°.

The 10" Tablesaw features a 1 1/2 HP motor with a 27" x 40" working surface, and a tilting blade with a full cutting depth of 3 1/8."

These are just a few of the features that come standard on these machines. To see these machines or

to take advantage of the substantial savings, contact your local JET dealer today.



*“right at home”*

# J E T

1-800-426-8402, Ext. 305

## The First ECONOMICAL Scrollsaw That Works Like THE REAL THING

### Save with Our Package Deal

A \$204.85 Value, now just

**\$149.95**

plus \$6.00 shipping  
(within 48 states)

You Receive  
Free Books & Blades  
Worth \$31.85

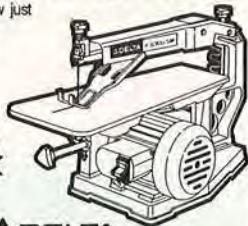

**DELTA**

**SCROLLSAW TECHNOLOGY** took a giant leap forward in the late 1970's when a German manufacturer first introduced the rocking parallelogram mechanism along with a floating blade clamp system, features which dramatically increased blade life and cutting precision.

**DELTA NOW MAKES THESE FEATURES** highly affordable in its new 15" model 40-150 scrollsaw. It weighs 37 lbs., has a 2-year limited warranty, and performs superbly!

**WHILE SUPPLIES LAST**, save big by ordering our Delta Scrollsaw Package Deal, which includes the 40-150 scrollsaw (list price \$179), 62 assorted spare blades (worth \$22), 2 bestselling toy pattern books (\$5.90 value), plus our own Scrollsaw User's Guide (a \$3.95 value).  
**YOU SAVE \$54.90!**

To order, send check, M.O. or MC/Visa info.  
Send \$1.00 for our complete tool catalog  
(free with order).

MC/Visa Users outside GA  
**ORDER TOLL FREE**  
(800) 241-6748  
(Orders Only)

**highland hardware**

1045 N. Highland Avenue, Dept. B  
Atlanta, GA 30306 (404) 872-4466

# TOOL INDUSTRY INSIDER



Print this article

## FOREIGN TOOL MAKERS COPE WITH LOW DOLLAR

The U.S. dollar has dropped against most major world currencies in the past couple of years, making most foreign goods sold in the U.S. more expensive. Here's why. If a tool costs a Japanese manufacturer a set number of yen to produce, and those yen now equal more U.S. dollars, that manufacturer has to charge more U.S. dollars for that tool to cover his production costs.

Between February 1985, and September 1988, the yen jumped 49 percent in value against the dollar, and the German deutsch mark gained 47 percent. "There's no way you can pass along those kinds of increases," one manufacturer told us. So how do these toolmakers cope? "All we can do is cut our overhead and wait for the dollar to come back up," the same manufacturer told us. "We've raised our prices modestly, while absorbing 75 percent of the decline in our normal profits. The cost of the product to us has nearly doubled, and we haven't raised our prices nearly that much." Fortunately for these importers and foreign manufacturers, the dollar has slowly, but gradually, risen since bottoming out in early 1988.

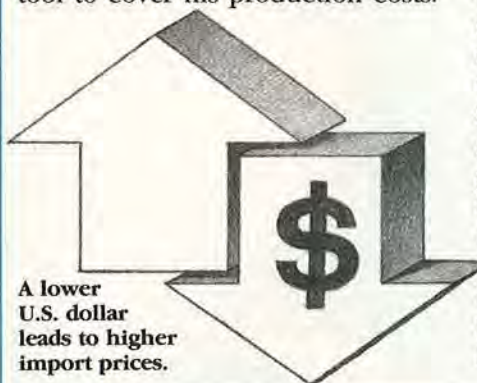

A lower  
U.S. dollar  
leads to higher  
import prices.

## FACTORY DIRECT CLOCKS AND FURNITURE



### Do-It-Yourself Kits or Assembled and Finished

- Grandfather Clocks, Mantel and Wall Clocks
- Cabinets, Chests, Tables, Chairs, Desks...and more!
- Solid 3/4" Black Walnut, Cherry, or Oak
- Heirloom Quality
- Solid Brass West German Movements and Dials
- Money Back Guarantee



SEND \$1 FOR  
COLOR CATALOG

## EMPEROR CLOCK COMPANY

World's Largest Manufacturer of Grandfather Clock Kits  
Dept. 3007, Emperor Industrial Park  
Fairhope, Alabama 36532 • Phone 1-205-928-2316

I am interested in  
 Do-It-Yourself Kits  Finished Clocks  Finished Furniture

Name \_\_\_\_\_

Street \_\_\_\_\_

City \_\_\_\_\_

State \_\_\_\_\_ Zip \_\_\_\_\_

(Please Print)

## BOSCH RIDS TOOLS OF CHAMELEON

If you've noticed that some of your Bosch power tools have changed colors, or if you've purchased one of their tools lately and it doesn't match the color of a model you purchased a few years ago, don't worry. The color shift affects your tool only cosmetically.

There's a reason. About two years ago, in response to environmental concerns, the Robert Bosch Power Tool Corp. removed cadmium (a suspected carcinogen) from the plastic in the body of its tools. Although the material does not pose a threat to you while embedded in the plastic, the long-term effects of disposing of any form of cadmium concerns environmentalists.

After removing the chemical element, a funny thing happened. Because cadmium acts as a color-stabilizer in plastics, the new tools shifted from the familiar "Bosch blue" to green in color. Bosch corrected the problem recently by switching to a more fade-resistant dark-blue color.

## SHOPSMITH ON RETAIL EXPANSION TRACK

Long known as the maker of the Mark V multipurpose woodworking machine, Shopsmith wants to be known for much more. The Dayton, Ohio, company has tremendously increased its product line in the past few years, and now aims to greatly expand its number of retail outlets across the country.

"We'll have whatever the woodworker needs—we're not just the Mark V company anymore," said Tim Silvers of Shopsmith. And to serve more of those woodworkers, Shopsmith boosted its number of stores from 24 to 40 in the past year. "With 40 stores, we'll have a store within 50 miles of 80 percent of the U.S. population," said Shopsmith's Scott Phillips. "And we plan to expand to 70 stores in the next three years."

However, the company is not content to let its "total source" concept stop at products and stores. "Through our in-store classes, we also want to be a leading educational force," Phillips said.

Illustration by Jim Stevenson



# Shophelper

All Wheels can be Sold Individually and are Interchangeable on Arms

**\$69.95**

## SHOPHELPER Holds it down for a cut above.

Shophelper's unique double wheel configuration gives it the stability required to virtually eliminate kickback and enhance safety. The inflex wheel holds the material down to stabilize the cut. The outfeed wheel controls rapping as narrow as 1/8" x 1/4". Shophelper is the perfect safeguard for professionals and hobbyists alike.

Three Multi-Purpose Multi-Colored Wheels



- Three different dual-wheel designs, including single and multi-directional
- Wide range of shop uses
- Provides a virtually accident-free environment
- Straighter, cleaner cuts
- Saves time and materials
- Options include adjustable slotted track, auxiliary fence, saw guard

Yellow Wheels turn clockwise for table saws and radial arm saws.

Orange Wheels turn counterclockwise for radial arm saws.

Green Wheels turn both directions for shapers, routers and jointers. (No anti-kickback).



Call For Nearest Dealer

Call Toll Free: 800-344-7455 • In California Call: 800-828-8833

WESTERN COMMERCIAL PRODUCTS • P.O. Box 238, Tulare, CA 93275

## SCROLL SAW LETTERS EASILY...



### ...with Seyco's Layout Guides!

**SPECIAL!** (Style #RST-001) 1 1/2" (pictured above)

\$25.00 includes brochure and shipping cost.

Make Name Plates, Signs, Gifts and more.

Our unique Lettering Guides are available in many styles and sizes to suit your needs. Upper and Lower Case, Script and Block Styles...and numbers too. Send \$1.00 for brochure and prices to:

**SEYCO** The Scroll Saw Specialists

1414 Cranford Dr. • Box 472749 • Garland, TX 75047

## "NEW" COMPLETE SET OF WOODCARVING TOOLS HONED READY TO USE.

# COMBI T-4 \$57.75 PPD  
Durable Compact Tool-Box  
Included in Offer.  
(Not Shown)

Bear NOT Included.



CATALOG \$1.00

NY Residents include sales tax.

Send Check or Money Order to:

WARREN TOOL CO. INC.  
Rt. 1 Box 14-A Dept. W  
Rhinebeck, NY 12572  
(914) 876-7817

"WARREN TOOLS GIVE YOU THE EDGE"

## BAND SAW OWNERS!

A NEW TOOL is now available so you can make or repair any length Band Saw Blade in minutes!

This patented tool was developed for use in our own shop and has proven itself with thousands of high quality, true running splices.

Our splicer enables any craftsman to make up any length blade from economical coil blade stock QUICKLY and EASILY. The resulting silver brazed joint normally outlasts the service life of the blade.

Three models are currently available:

1C-001 1/4" to 3/4" Blades..... \$ 49.95 ppd  
1C-002 1/2" to 3/4" Blades..... 49.95 ppd  
1C-003 3/4" to 1 1/2" Blades..... 150.00 ppd

The tool comes complete with detailed instructions and supplies for approximately 100 splices.

We also carry additional supplies and OLSON band saw stock at reasonable prices.

Send L.S.A.S.E. for FREE information to:

NEW MILFORD SPECIALTIES CO.  
Dept. BH, P.O. Box 241  
Botsford, CT 06404-0241  
(203) 426-4276

DEALER INQUIRIES INVITED

# Van Dyke's

## Presents a Catalog

with supplies for upholstery, antique restoration, wood working, caning, brass hardware, carvings and many related trades!

36 Years in Creative Arts & Trades

Many Hard-To-Find Items!

SEND \$1.00 FOR CATALOG TO:  
**Van Dyke's Restorers**  
Dept. D55 - Woonsocket, SD 57385



## The Basic Woodworking Series Now on Video

**INTRODUCTION SET \$34.95 (SAVE \$4.95)**

**HAND TOOLS:** Use of over 45 tools for home maintenance and woodworking. \$19.95\*

**HAND POWER TOOLS AND WOOD:** Operation of small power tools. Types, grades, and uses of wood. \$19.95\*

**POWER TOOL SET \$49.95 (SAVE \$9.90)**

**WOOD LATHE:** Wood turning, scraping, beads, coves, shearing and cutting to size. \$19.95\*

**TABLE SAW:** All basic cuts plus setups for panel doors, chessboards, finger lap joints, etc. \$19.95\*

**JOINTER AND PLANER:** Operation plus combination tools and advanced techniques. \$19.95\*

FREE Safety booklet included with each tape.

\* Add \$3.00 shipping per tape. Specify VHS or BETA



**DR TRAINING & VIDEO, INC.**  
P.O. BOX 3539, NAPA, CA 94558

## Wood Moisture Meter

- Avoid Moisture Problems
- Protect your Masterpiece

### MINI LIGNO

Incl. Case, Batteries and Pins for 3/8" and 1/2" Measuring Depth.

only **\$110**

also from Lignomat:  
**MINI-LIGNO E**  
Range: 6%

Easy-to-use, sturdy instruments for the professional woodworker or serious hobbyist. Great for lumber, veneer, fiberboards. Ask for free catalog on the complete line of moisture meters and accessories for kiln drying.

**Lignomat USA Ltd.**

503-257-8957 800-227-2105

P.O. Box 30145bh  
Portland, OR 97230



PICNIC PATIO



TABLE PLAN

Build and enjoy this exclusive piece of art made of 2x4's! A functional picnic patio table. Everyone seated in is visual and voice contact. Octagon seats 8 adults. Lazy susan, umbrella holder. 7' 1" across. Fully illustrated for cutting assembling, material list. Patented. \$12 check, M.O., M.C., VISA (card no. + exp. date). USA \$, Money Back Guarantee.

**THOM'S, INC. Dept. 2**  
2012 Wilkins • Laurel, Montana 59044



# FULL SIZE WOODCRAFT PATTERNS

SIMPLE TO MAKE • FUN • PROFITABLE

- 200 pattern packet for scroll, band & jigsaws
- "Country Critters"-100 patterns, unique projects
- 6 enjoyable "Wind-Action" whirligigs
- "Country Classics" - best selling country projects
- 100 yard ornaments, animals, birds and more
- 17 "Show Stoppers" - craft show best sellers

Send \$7.00 per blueprint packet or choose any 3 FOR ONLY \$14.00.

Fast Service • Satisfaction Guaranteed!

**ACCENTS** Dept. MA39, Box 7387, Gonic, NH 03867

Catalog of 1000 patterns - \$1.00 (Free with order)

## SPECIAL OFFER

# BRANDING IRON

For hard and soft wood

**\$26.00**

Plus \$2.00 for shipping and handling

Nebr. residents add correct sales tax

SATISFACTION GUARANTEED of your money back

- Shipped in 1 week
- Solid brass head — deep cut letters
- First Line: HAND CRAFTED BY — as above
- 2nd line: Your choice — 20 characters/spaces max.
- Compact size
- As above but with 3rd line — \$37.00 + \$2.00

ORDER TOLL FREE 1-800-826-7606 (except Nebraska)  
In Nebraska 1-402-464-0511

For free brochure, write or call (402) 464-0511

Order by mail from: **NOVA TOOL CO.**

12500 Finigan Rd. Dept. BH

P.O. Box 29341, Lincoln, NE 68529



## HORTON BRASSES

Nooks Hill Road, P.O. Box 120J  
Cromwell, CT 06416 (203) 635-4400

HORTON BRASSES are authentic copies of 17th, 18th, 19th & early 20th century pulls



Mfrs. of Cabinet & Furniture  
Hardware for Homes & Antiques.  
Send \$3.00 for a Catalogue.

# MAKE TOYS

CLOCKS & WHIRLIGIGS

Make wooden toys, whirligigs, clocks, dollhouses, autos, music boxes, weather instruments, games, crafts & furniture with our plans, parts (hardwood & metal), kits (for all skill levels), books, tools and supplies. Bulk prices. Catalog \$1. (614)484-4363  
Cherry Tree Toys, Bx 369-409, Belmont, OH 43718

## GARDENER

Pre-cut Kit: \$29.95

Just sand & assemble



22' long  
Visa/MC  
Uncut Kit: \$24.95  
Just cut, sand & assemble

# Information



## WORTH WRITING FOR

You can get useful ideas and product information by mail. Use the coupon in this section to order your choice of literature listed below.

### POWER TOOLS

**SCROLL SAW AND LATHE INFORMATION**—More than 20 pages of information, including full-color photos, on HEGNER precision scroll saws, HEGNER lathes, and HEGNER duplicators. Find out why these machines are considered state of the art, and what to look for when shopping for scroll saws or lathes. AMI, LTD. \$1.00. *Circle No. 3.*

**WOODWORKING PROFESSIONALS ONLY**—Now save 50% on machinery, 70% on operating costs! How? By using the world's finest production quality universal machine. Commercial durability, utmost precision, set-up in seconds. No other tool combines usable capabilities like FELDER. Thousands sold all over the world. Now available in America through AMI. Send for brochure. AMI LTD. \$1.00. *Circle No. 4.*

**THIS IS IT! THE CATALOG YOU'VE BEEN WAITING FOR!**—ACME's catalog contains everything you need whether you're a professional woodworker, hobbyist, or contractor. All 120 pages are fully illustrated, and contain some of the lowest prices on name brand manufacturers that you will find anywhere. A must for anyone serious about saving money. ACME ELECTRIC. \$2.00. *Circle No. 6.*

**BOSCH BELT SANDER, MODEL 1273DVS**—10.5 amp 4" x 24" Belt Sander with 6 speeds, speed selector guide. Use higher speeds with coarse grits, slower, with finer ones. Faster belt changes, automatic belt tensioning; uses dust collection bag or vacuum-boosted Bosch Air Sweep™ system. BOSCH POWER TOOL CORP. Free. *Circle No. 17.*

**BOSCH LAMINATE TRIMMER KIT, MODEL 1608**—Trim laminates, veneers; 5.6 amp motor. Complete with all bases; accessories for sloped installation tasks. One base handles routine cuts; tilting base trims odd angles or up to vertical surface; offset base for corners, angles. BOSCH POWER TOOL CORP. Free. *Circle No. 18.*

**BOSCH 3 HP PLUNGE ROUTER**—Ergonomics, superior safety and operator control, plus wanted features mark the Bosch 1611. 3 hp, 22,000 rpm Lead-in Plunge Base Router. Controls are located so operator's hands stay on over-sized handles. Collet capacity to 1/2-inch. BOSCH POWER TOOL CORP. Free. *Circle No. 19.*

**BOSCH JIG SAW, MODEL 1581VS**—Virtually vibration-free top handle model has 6 speeds; 4 blade orbits. Controls, blade lock and guide, tilting outplate; blade options; and 4.8 amp motor let you meet sawing requirements with precision. BOSCH POWER TOOL CORP. Free. *Circle No. 20.*

**FREE WOODWORKING POWER TOOL CATALOG**—Buy planers, jointers, shapers, table saws, scroll saws, bandsaws, drill presses, wood lathes, sanders, dust collection systems, and more...direct from the factory and save. Foley-Belsaw sells direct to you...so you save on every purchase. You'll find quality power tools, plus hand tools and accessories to meet all of your woodworking requirements. Complete money-back guarantee. Send for details. FOLEY-BELSAW. Free. *Circle No. 41.*

**MANUFACTURED SINCE 1926**—the Foley-Belsaw Model M-14 Circular Sawmill lets you go right to the trees to turn out smooth, true-cut lumber. Available with heavy-duty steel base or with plans and track provided for owner built wood base. Will accurately saw logs up to 14 ft. in length and up to 24 in. in diameter. Complete money-back guarantee. Send for details. FOLEY-BELSAW CO. Free. *Circle No. 42.*

**INCA MACHINERY INFORMATION**—Complete information on the famous line of Inca Swiss woodworking machines. Designed for precision work by the small to medium sized cabinet shop. Used by thousands of hobbyists and professionals. Table saws, bandsaws, joiner/planners, dust collector, radial arm saw. GARRETT WADE CO. Free. *Circle No. 44.*

**KELLER DOVETAIL SYSTEM**—"In a class by itself" —Wood Magazine. Beautiful through-dovetail joints made accurately, quickly and very easily with your router. For novice and pro. Warranted 20 years! Send for full descriptions. KELLER & CO. \$1.00. *Circle No. 56.*

**LOBO POWER TOOLS**—Our lower prices make our fine woodworking machines more affordable for you, "our cus-

tomers." We sell a complete line of band saw jointers, planers, drum sanders, shapers, and much much more. All of our machines come with a 1-year warranty. Order today for a free catalog. LOBO POWER TOOLS. Free. *Circle No. 57.*

**VERTICAL PANEL SAW/PANEL ROUTER PLANS**—Now even working alone you can make deadly accurate rip and cross cuts up to 5 ft. wide in plywood, particle board, plastic laminates and most sheet goods. Instant set ups on V-Grooves, Dadoes and more. This extremely versatile tool is perfect for cabinet shops, sign shops and home workshops. Send for more info. BRAD O'CONNOR. Free. *Circle No. 70.*

**SCROLL SAW**—Information package available from Penn State Industries describing the specifications and applications of its super 15-inch scroll saw. Special discount pricing available on current promotion. PENN STATE INDUSTRIES. Free. *Circle No. 76.*

**SURFACE PLANER**—Information package available from Penn State Industries describing the specifications and applications of its super 15-inch surface planer. Special discount pricing available on current promotion. PENN STATE INDUSTRIES. Free. *Circle No. 77.*

**QUALITY AMERICAN-MADE SCROLL SAWS**—The RBI Hawk family of Precision Scroll Saws with 6 models, one to fit your needs. Patent pending Camover Quick Blade Change system, 2 way tilting tabletop, 2 speed or variable speed motor, all add up to make the Hawk the best value on the market today. Virtually end sanding forever! Send for the facts. RB INDUSTRIES, INC. Free. *Circle No. 84.*

**AMERICAN WOODWORKING EQUIPMENT**—Over 60 years of experience manufacturing first quality woodworking machinery. The RBI Woodplaner a leader in versatility and durability featuring planing, moulding, sanding and gang ripping capabilities all in one space saving machine. The RBI Joint Machine makes most precision joints simple to make in just seconds. Send for fact filled brochure. RB INDUSTRIES, INC. Free. *Circle No. 85.*

**SAKURA SCROLL SAW INFORMATION**—You owe it to yourself to compare the value-priced 14-inch 3-speed ScrollMate with other units before you make your buying decision. It offers a built-in air bellows; stand; quick, safe speed changes; and a full 2-year limited warranty—all at a price that's tough to beat. SAKURA USA. \$1.00. *Circle No. 87.*

**THE VERSATILE TOOLMAX T310**—woodworking machine solves the common "too small a shop" problem by combining a 10" table saw, 1" spindle shaper, 12" jointer, 12" planer and fully adjustable mortising table. Saves 90% on space and 60% on investment. Send for complete color information pack. TOOLMAX. \$1.00. *Circle No. 90.*

**MOLDER-PLANERS FROM WILLIAMS & HUSSEY**—Mold, plane, and edge, convert from moulder to planer in less than 2 minutes. The W-7 series is available in 3 models for manual, power in feed, or power in feed/out feed. The units plane to a satin, almost sanded finish, produce doll house to crown sized mouldings, raised panels, and virtually any shape profile. Custom knives available up to 7" wide and 3/4" depth of profile. Rugged, well-made, dependable, and transportable. Complete with sturdy movable stand. Send for catalog. WILLIAMS & HUSSEY. \$1.00. *Circle No. 93.*

**PORTABLE SAWMILLS**—Convert logs into valuable lumber—Wood-Mizer® Products manufactures a line of portable bandsaw mills that allows the novice as well as the experienced sawyer to safely convert standing logs into lumber. Then, with the use of our SolaryDry™ Kiln or Vacu-Kiln™ to dry your lumber, you could increase the value of every board you produce. We manufacture some of the most progressive woodworking equipment on the market today. Product videos available. Send for our 44-page catalog. WOOD-MIZER PRODUCTS. \$1.00. *Circle No. 94.*

**BRIDGEWOOD WOODWORKING MACHINERY**—A new 52-page catalog of fine BRIDGEWOOD wood and metal-working machinery is available from Wilke Machinery Company. The BRIDGEWOOD line includes a wide range of products for use in the serious home workshops up through the industrial applications. WILKE MACHINERY CO. \$1.00. *Circle No. 96.*

**IS THIS THE WORLD'S BEST JOINER-PLANNER?**—We think so and invite you to take a closer look! MiniMax's new FS-35 joiner-planer combines industrial quality with an affordable price that will appeal to professionals and amateurs alike. THE XYLOPHILES CO. \$1.00. *Circle No. 97.*

**12", 18" and 25" PLANER/MOLDER/SANDER FROM WOODMASTER TOOLS**—a size to meet any shop requirement...all with exclusive variable feed rate. Free information kit includes details on 30-day trial period and easy terms. WOODMASTER TOOLS, INC. Free. *Circle No. 99.*

**COMPACT STROKE SANDER FEATURES BIG CAPACITY**—The low-cost, Model 800 features three built-in speeds, a large, 24" x 48" sliding table with automatic elevation, and a traveling, lever-action, pressure platen. Open-

ended design accommodates any length material. Long-lasting belts are 6" x 156". 30-day free trial! WOODMASTER TOOLS, INC. Free. *Circle No. 100.*

### HAND TOOLS

**DIAMOND WHETSTONES BY DMT**—Discover the ease and speed of sharpening on the finest Diamond Whetstones. Five sizes from 3" to 12" in size, coarse, and extra coarse. Finest monocrystalline industrial diamonds permanently bonded in nickel. Lubricated with water rather than messy oil. Stays flat, unbreakable. Twelve years of serving sharpening needs. Satisfaction guaranteed. Send for full color catalog. DIAMOND MACHINING TECHNOLOGY, INC. \$2.00. *Circle No. 112.*

**PERSONAL BRANDING IRONS**—Brochure describes branding irons that enable you to put your name on you work quickly and easily. Made especially for branding wood, they are available with 1, 2, or 3 lines of copy or with your logo. Changeable date also available. NOVA TOOL CO. \$1.00. *Circle No. 160.*

**STUDSENSOR**—Free literature featuring Zircon's stud locating device. The only accurate way to locate studs, not nails. Also excellent for use in locating ceiling joists and fire blocks. Can be used on dry wall, plastic, wood and acoustic surfaces. Eliminates guess work—"sees" through walls to hang pictures, heavy mirrors, lamps, etc. Great for installing wall units, shelves and paneling. ZIRCON INTERNATIONAL, INC. Free. *Circle No. 199.*

### STAINS/FINISHES

**ARTI ANILINE DYES**—Color chart features 28 aniline colors and 8 toymaker's colors. Price list and ordering instructions included. HIGHLAND HARDWARE. \$1.00. *Circle No. 232.*

### PLANS

**OVER 1000 WOODCRAFT PATTERNS!**—Create gifts, toys, whirligigs, lawn ornaments, folk art, bird houses and feeders, magazine racks, household accessories, plus much more! Simple enough for the beginner, fun and profitable for the pro. Catalog plus sample pattern. ACCENTS IN PINE. \$2.00. *Circle No. 310.*

**WOODWORKERS' PLANS AND SUPPLIES**—Wood projects are simplified with the high quality plans, specialty hardware and other supplies offered by Armor Products. Over 100 plans are available for making toys, desks, clocks, pool tables, lamps, chests, and other furniture. Movements, dial, moldings, ornaments, dollhouse kits, door hamp supplies and tuning pins are also available. ARMOR PRODUCTS. \$1.00. *Circle No. 315.*

**FULL-SIZE FURNITURE PLANS CATALOG**—Illustrates and describes over 200 plans for making furniture of quality found in museums and fine furniture stores. Plans include rolltop desk, cradles, dining tables, chairs, buffets, chests, gun cabinets, poker table, children's furniture, rocking horse, spinning wheels, and more. Bill of materials exploded drawings assist the woodworker. FURNITURE DESIGNS, INC. \$2.00. *Circle No. 345.*

**STICKLER FOR DETAIL?**—At last an exciting new line of realistic wood block models that you can build with your own scrap wood and dowels and my easy-to-follow instructions. Highly detailed plans for a 20x8 3/4-in. dump truck. GATTO PLAN SUPPLY. \$8.00. *Circle No. 355.*

**COUNTRY FURNITURE PLANS**—Our catalog features more than 30 designs—from a washstand to a roll top desk. Our new book on finishing and refinishing will show you how to finish projects like the pros. Also included are various products for the home workshopper. Send for our latest catalog (price of catalog deductible from first order). HAM-MERMARK ASSOCIATES. \$1.00. *Circle No. 370.*

**WOODWORKING PLANS**—Catalog of full-size plans printed on heavy paper for toys, gifts, novelties, action windmills, shelves, birdhouses, garden furniture, Dutch windmill, lawn ornaments, old-fashioned lawn swing, jigsaw projects for children, and more. MASTERCRAFT PLANS WEST. \$1.00 (refunded with first order). *Circle No. 390.*

**FULL SIZE PLANS**—for fine furniture, home accessories, and toys featuring Plan Plus—the plan complete with hardware and hard-to-find components. "All American Tool Collection" spotlights shop-tested tools made in USA. 16-page

# THE SANDER WITH WIDE APPEAL

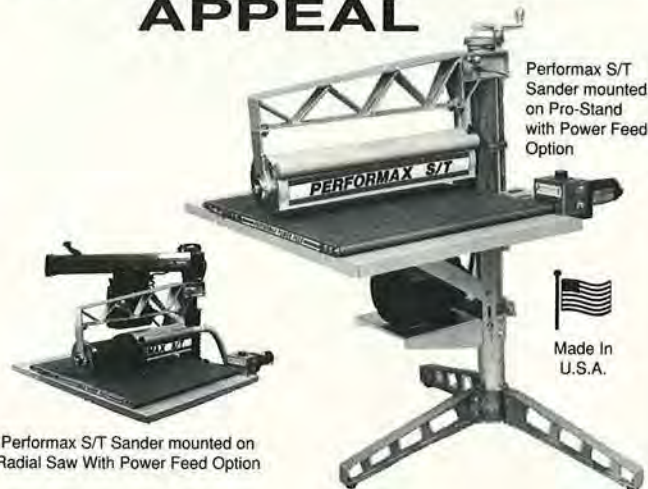

Performax S/T  
Sander mounted  
on Pro-Stand  
with Power Feed  
Option



Made In  
U.S.A.

Performax S/T Sander mounted on  
Radial Saw With Power Feed Option

## 44" TO BE PRECISE

Uniform thickness accuracy to within .010 of an inch—precision that you almost have to see to believe. Or take the word of thousands of woodworkers who are achieving flawless sanding results in their cabinet shops, craft shops, home workshops, custom furniture shops and in musical instrument making.

The Performax Component Sander appeals to such a wide variety of woodworkers because it allows you to select the components to fit your needs now with retrofitting options for potential heavier use later.

Plus, your sanding width won't ever be limited with the 44" wide sanding capacity, due to the open-end design of the Performax S/T Sander, which is just one of the many innovative features that makes the Performax Component Sander a wise investment and an excellent choice for all types of woodworking.

For More Information or the Dealer Nearest You  
Call 1-800-334-4910 or Write to:

Performax Products, Inc., 11975 Portland Ave. S., Suite 142, Burnsville, MN 55337

OWN THIS CLASSIC

## "Roll Top" OAK DESK

Quality  
Woods



**FREE FULL COLOR CATALOG  
GIVES YOU ALL THE FACTS**

Here's the turn-of-century "Roll Top" you've always wanted. A full size oak desk now yours at extraordinary savings. . . because you put it together yourself from pre-cut Kit parts. No special tools needed. When finished, you'll possess a magnificent showpiece for your home or office—worth at least twice what you paid for the Kit! Send for details without obligation.

Please send my free Craftsman's Corner catalog featuring the Classic Roll-Top Desk and many other hardwood kits. I understand I am under no obligation.

Print Name \_\_\_\_\_

Address \_\_\_\_\_ Apt. \_\_\_\_\_

City \_\_\_\_\_

State \_\_\_\_\_ Zip \_\_\_\_\_

Craftsman's Corner Dept. 4-GF • 4012 N.E. 14th Street • Box AP • Des Moines, Iowa 50302



## Have a problem with your subscription?

We want to solve it to your complete satisfaction, and we want to do it fast. Please write to: Robert Austin, *Better Homes and Gardens*® WOOD®, P.O. Box 10628, Des Moines, Iowa 50336.

You can help us by attaching your magazine label here, or copy your name and address as it appears on your label. Send this along with your correspondence.

Name \_\_\_\_\_

Address \_\_\_\_\_ Apt. # \_\_\_\_\_

City \_\_\_\_\_ State \_\_\_\_\_ Zip \_\_\_\_\_

## Moving?

Simply attach the mailing label from this magazine and write in your new address below. (Please allow 4-8 weeks.)

Name \_\_\_\_\_

Address \_\_\_\_\_ Apt. # \_\_\_\_\_

City \_\_\_\_\_ State \_\_\_\_\_ Zip \_\_\_\_\_

## For Fast Service...

...it is better to write us concerning your problem and include the magazine label. Also, address changes are handled more efficiently by mail. However, should you need to reach us quickly the following toll-free number is available:

## Subscription Rate:

6 issues — 1 year — \$18. Add \$6 for Canadian, or \$12 for other foreign subscriptions.

Renewal  New Order

1-800-678-2666

**WOOD**  
magazine

P.O. Box 10628 • Des Moines, Iowa 50336

## CONTROL THE SPEED OF YOUR ROUTER

**ROUTE AT THE SPEED  
THAT GIVES THE BEST  
RESULTS WITH THE  
WOOD AND BIT YOU  
ARE USING!**

INTRODUCTORY PRICE  
**\$39.95**  
POSTAGE PAID  
VALUE OVER \$100.00

- LESS TEAR OUT
- STOPS BURNING
- FEED AT COMFORTABLE RATE
- BETTER, SAFER RESULTS WITH LARGE DIAMETER PANEL-RAISING BITS
- LESS WEAR ON BITS
- LESS NOISE AND SOFTER STARTS AT LOWER SPEEDS



### FEATURES:

- SPEED ADJUSTABLE FROM FULL SPEED TO 0 RPM
- FULL HORSEPOWER AND TORQUE AT ALL SPEEDS
- GO BACK AND FORTH FROM ANY PRE-SET SPEED TO FULL SPEED AT THE FLIP OF A SWITCH
- WORKS WITH ALL ROUTERS 3 HP OR LESS
- 120V 15 AMP
- GIVES YOUR ROUTER A FEATURE ONLY AVAILABLE ON ROUTERS THAT COST OVER \$500.00

**EASY TO USE** — SIMPLY PLUG IN SPEED CONTROL AND PLUG YOUR ROUTER INTO THE SPEED CONTROL — TURN DIAL FOR BEST RESULTS. (SPEED CONTROL HAS A CLIP THAT CAN BE WORN ON YOUR BELT OR HUNG ON WALL OR LEFT LOOSE.)

- REDUCES SPEED ELECTRONICALLY WITHOUT REDUCING TORQUE; ELECTRONIC FEED-BACK MAINTAINS SPEED BY INCREASING VOLTAGE TO MOTOR AS LOAD INCREASES.

To order by Master Charge or Visa Toll Free  
7 Day — 24 Hour Order Service, Call

1-800-533-9298

or send check to: MLCS, Ltd., P.O. Box 4053D, Rydal, PA 19046

catalog; price refunded with first order. RJ'S CUSTOM WOODWORKING. \$1.00. Circle No. 424.

**BACKYARD STRUCTURES** — Contains designs for 21 really different storage sheds, 5 cabanas, 13 animal shelters, 3 barns, 13 garbage enclosures, 3 studios, and more, plus 8 plans in book. 66 designs in all, for which plans can be ordered. Full color. SUN DESIGNS. \$10.45. Circle No. 454.

**MAKING TIMELESS TOYS IN WOOD** — contains 40 heirloom-quality designs, with 20 mini-plans in book. Full color, 96 pages. SUN DESIGNS. \$11.45. Circle No. 455.

**CUPOLA AND BRIDGE** — Consists of designs for 22 foot bridges, 8 covered bridges, 36 cupolas, and some history of each. Complete plans available for each design. SUN DESIGNS. \$10.45. Circle No. 456.

**GAZEBOS AND OTHER GARDEN STRUCTURES** — The most comprehensive collection of gazebo designs found anywhere today. Includes 55 gazebo designs from 8 ft. to 30 ft., 13 trombones, 7 arbors, 14 bird feeders, and 4 birdhouse designs. Has mini-plans of 2 bird feeders and 1 of our most popular Tiffany gazebo. Complete construction plans can be ordered for all 93 designs. SUN DESIGNS. \$10.45. Circle No. 457.

**CREATE FUN & PROFITABLE WOODCRAFTS**—Popular folk-art, toys, decorative country items, old fashioned St. Nicks. 20-page catalog is overflowing with over 400 original projects for all skill levels. Full size blueprint patterns eliminate tedious enlarging—giving you more time to enjoy actual woodworking. THE WINFIELD COLLECTION. \$1.00. Circle No. 480.

## LUMBER

**QUALITY EXOTIC LUMBER/TURNING WOODS**—We offer a comprehensive selection of fine quality exotic woods: Ebony, Kingwood, Tulipwood, Snakewood, African Blackwood, Cocobolo, Bloodwood, Figured Maple, Spalted Maple, Padauk, etc. Unique and unusual turning woods and burls are also available. Send for catalog. BEREA HARDWOODS. \$1.00. Circle No. 10.

**WOODWORKERS! HELP CELEBRATE OUR 59TH YEAR OF SERVICE** — Send for our new 148-page Craftsman 1988-89 Catalog #55. 42 varieties of choice hardwoods 1/64 in. to 4-in. thickness. Fine hardwood veneers, tools, moldings, trim, marquetry inlays, upholstery and lamp supplies, finishes, clock kits, and hard-to-find hardware. 4,000-plus items for your projects. CRAFTSMAN WOOD SERVICE CO. \$1.00. Circle No. 520.

**EdCo — WE KNOW OUR LUMBER** — Educational Lumber Company is pleased to offer you our new catalog, stacked with excellent buys at delivered prices. Available to you are over 21 species of imported as well as domestic hardwoods, softwoods, turnings, shorts, veneers. All our lumber is kiln dried. As school shop suppliers for 35 years, we know our lumber. It is top-grade. Send today and receive your BONUS GIFT: 4 new furniture designs. EDUCATIONAL LUMBER CO., Inc. \$2.00. Circle No. 530.

**THIN LUMBER**—Approximately 20 species—1/4" to 3/4" thickness. Thinner material sanded, all KD & surfaced—UPS delivery in continental US included in price. Packages of micro-lumber 1/8" - 1/2" thick. HARDWOODS OF ILLINOIS. 50¢. Circle No. 545.

**THE BEST LUMBER AT THE RIGHT PRICE**—Located in close proximity to some of the most ideal growing ranges for Red Oak, Pennsylvania grade Cherry, Hard Maple, Ash, Poplar, and other hardwoods, we can supply your needs with the highest quality hardwoods. Our experience in hardwood purchasing and our dedication to keeping our overhead low is your guarantee of low prices. No minimum order. Retail and wholesale. Send for 20-page catalog. NORTH EASTERN HARDWOODS. \$2.00. Circle No. 563.

**RARE IMPORTED EXOTIC AND DOMESTIC HARDWOODS**—The world renowned Martin Guitar Co. sells wholesale and retail exotic wood (4/4, 6/4, 8/4) and sawn veneers (1/8" & 1/4" Sanded Stock), plus guitar parts, kits, accessories and second quality guitars. Send for catalog. SAWMILL/WOODWORKER'S DREAM. \$2.00. Circle No. 578.

**STEVE H. WALL LUMBER CO.**—Quality hardwoods and woodworking machinery for the craftsman and educational institutions. 22-page catalog lists 15 species of popular hardwoods at wholesale prices. Also dealers for Delta, RBl, MiniMax, Freud and ProCut woodworking machines. STEVE H. WALL LUMBER CO. \$1.00. Circle No. 592.

## GENERAL WOODWORKING CATALOGS

**ADVANCED WOODWORKING**—Specialty products catalog from the exclusive distributors of Hegner & Felder woodworking machinery. Includes complete selection of scroll saw blades, accessories, and improvements for almost any scroll saw. Also the Hegner precision scroll saws, lathes & duplicators, Jet clamps, workbenches, Felder systems & more. AMI, LTD. \$2.00. Circle No. 801.

**EVERYTHING FOR THE WOODWORKER** — Wide selection of woodworking supplies, including candle cups and

shaker pegs. Price of catalog is refundable with order. BENNY'S WOODWORKS. \$1.00. Circle No. 810.

**CONSTANTINES' CATALOG FOR WOODWORKERS**—116 pages packed with over 4,000 products for fine wood-working. Included are 250 kinds and sizes of domestic and imported hardwoods; 150 varieties of exotic veneers, top quality woodworking tools, hard-to-find specialty hardware and accessories; wood finishes, books, plans, and more. 60-day money back guarantee if not fully satisfied. Serving the woodworker since 1812. ALBERT CONSTANTINE AND SON, INC. \$1.00. Circle No. 820.

**MASTER TOOLS CATALOG**—1988-89 212-page master woodworking tools catalog. Full line of the best hand tools, power tools & accessories, machinery, glues, finishing supplies, and much more. Hundreds of books included. 212 pages. All four-color. Lots of technical information. GARRETT WADE CO. \$4.00. Circle No. 855.

**WOODWORKING MACHINERY CATALOG** — Planers, jointers, tablesaws, shapers, drill presses, sanders and much, much more. Buy direct from importer at super low prices. Full color catalog. GRIZZLY IMPORTS, INC. Free. Circle No. 860.

**WOODWORKING TOOLS, MACHINERY, & SUPPLIES**—W. S. Jenks & Son's new 128 page source book is packed with a full range of tools for the serious woodworker, from hand tools, to portable power tools, to woodworking machinery. Includes many imported and hard to find tools, from the best manufacturers at the most competitive prices. Send for catalog. W. S. JENKS & SON. \$2.00 (refundable with first order). Circle No. 877.

**WOODWORKING SUPPLIES CATALOG**—1200 tools, patterns, veneers, thick and thin hardwoods, plywood, carving and turning stock, hardwood bundles shipped UPS, books, doweling jigs, hinges, hardware, drawer slides, dowels, spindles, 2 plys, flexibles, cane, finishes, stain, inlays, edging, burls, faces, more! Send for your catalog today! BOB MORGAN WOODWORKING SUPPLIES. \$1.00. Circle No. 890.

**WOODWORKING TOOL CATALOGS** — R.A. Ness & Co., the Woodworkers Emporium, offers a 2-year subscription, a total of eight huge sale catalogs. Thousands of industrial quality items — machinery, hand tools, portable electric tools, and supplies — are featured at super sale prices. The fee is refundable with purchase. R. A. NESS & CO., the Woodworkers Emporium. \$4.00. Circle No. 900.

**RENOVATOR'S SUPPLY**—America's Number One source for elegant, old-style reproductions at factory-direct prices! 48 colorful pages of door, window and cabinet hardware; lighting and bathroom fixtures; and gifts for the home in brass, oak, porcelain and wrought iron. RENOVATOR'S SUPPLY. \$3.00. Circle No. 915.

## Europe's Favorite Workshop For Home Craftsmen • K5

Turn your "dream" projects into finished projects with the power and precision of a full professional cabinet shop!

You can saw, plane, mold, and mortise with ease and accuracy -- on anything from a baby-doll cradle to a full set of kitchen cabinets! Yet the K5 is a compact Combination that takes up less than 12 square feet and requires almost no adjustment to change operations.

Find out more! Send for FREE information or take a look at "THE K5" Video for just \$14.95.

Call or Write for More Information

1-800-USA-KITY



NEW!  
K5 VIDEO  
JUST \$14.95  
(VHS)



Farris Machinery  
Dept. D289 309 N. 10th  
Blue Springs, MO 64015

FREE INFO  VIDEO \$14.95

Name \_\_\_\_\_

Address \_\_\_\_\_

City \_\_\_\_\_ State \_\_\_\_\_ ZIP \_\_\_\_\_

Acct # \_\_\_\_\_ Exp.  MC  VISA



### SPECIAL SALE I

#### DUST COLLECTOR

1 HP, 2 Bag,  
4" Connect Hole  
58" High, 15"x 26" Base  
Weight 80 lbs.  
Model no. DC-31  
ONLY \$159.00

(shipping \$20)

TRUE VALUE Customer Satisfaction Guaranteed  
One year parts Warranty.



## LOBO POWER TOOLS

10922 Klingerman St. #3,  
So. El Monte, CA 91733

All Prices FOB-L.A. (818)350-1096 Canada:(604)299-0911

Write or call for Free catalogue **HIGH QUALITY**

## COMATIC

### COMATIC POWER FEED

SK-303FD  
1 HP, 3 phases  
SK-301FD  
1 HP, 1 phases  
SK-321FD  
1/4 HP, 1 phases



# rbindustries family of precision, quality tools, American - made and affordably priced

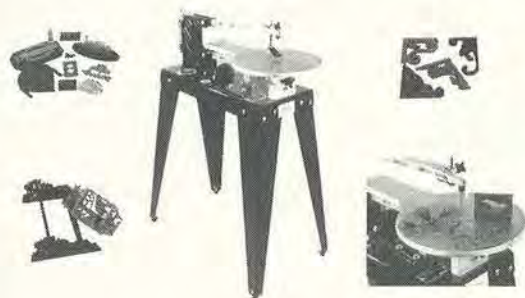

## The RBI HAWK Scroll Saw

### Family of Precision Scroll Saws

America's largest line of Precision Scroll Saws can unlock your creativity. With **6 models to choose from**, there is one suited for **your needs**. It takes a real woodworker to build a first class tool and that's what RBI is all about. We're American Woodworkers building quality, affordable tools with pride for you - the American Woodworker. Send today for your free information kit to see why rbi is the best value for your woodworking dollars.

## The RBI JOINT MACHINE

Precision Joint Making • Spindle Shaper • Router Table • Inverted Pin Router

Create beautiful wood joints so precise, you may be tempted not to glue them! Making finger joints, mortise and tenons, all types of dovetail joints, mitered joints, and raised panel doors has never been easier. Your rbi Joint Machine can also convert into a spindle shaper or an inverted pin router with accessory attachments. Send for your free fact kit today!



Call Toll Free 1-800-535-8665  
(In MO 816-884-3534) for information  
Dealer Inquiries Invited

rbindustries  
1801 Vine St.  
PO Box 369  
Harrisonville, MO  
64701



## The RBI WOODPLANER™

Planer • Sander • Molder • Gang Rip Saw

Four essential woodworking functions designed into one precision, dependable machine. Plane your rough stock into dimensioned lumber to the size you want, save yourself hours of hand sanding using the sanding attachment, you can edge cut and width dimension your stock with the power-fed gang rip saw attachment, or create beautiful standard or custom moldings out of any wood you want with the molding head assembly. All these functions without having to remove the knives from the cutterhead and the time and trouble needed to reset the planer knives again like other machines on the market. Send today for your free fact kit on this extraordinary tool!

Yes, Please rush me a free fact kit on:

Hawk Scroll Saws  Woodplaners  
 Joint Machine (Mark Interest)

Name \_\_\_\_\_

Address \_\_\_\_\_

City \_\_\_\_\_

State \_\_\_\_\_ Zip \_\_\_\_\_

W28

## BE IN CONTROL OF YOUR LIFE!

"Will you have a job tomorrow?"

ONE WEEK INTENSIVE COURSES  
Third Generation Master Craftsman



- Fine Finishing
- Impossible Repairs
- Hand Joinery

You Don't Have to Spend a Fortune  
To Start Your Own Business

Send \$5.00 for complete information including  
testimonials and tool catalog.

**The Hymiller School**  
912 Lakeshire Drive  
Fairfield Glade, TN 38555  
615-484-9309



**NEW!**  
**12 1/2"**  
**Surface**  
**Planer**  
2HP, 115V  
**\$397**



**THE SOURCE** FREE FREIGHT  
7305 Boudinot Drive  
Springfield, VA 22150  
703-644-5460

SEND \$2.00 FOR CATALOG

ORDER TOLL-FREE

US 800-452-9999 VA 800-468-1778

## Furniture Restoration

**Big Money in Small Business**

Stripping ★ Repairing ★ Refinishing  
Mirror Resilvering ★ Veneering

**Earn \$200-\$1000 a day!**

At home or in shop ★ Spare time, full  
time ★ Men or women ★ Complete  
training, no experience necessary  
★ Simple, fast, safe, fun.

**FREE CATALOG**

Send \$2.00 for postage & handling to  
**MINUTEMAN, INC.**, Dept. 17,  
115 N. Monroe St., Waterloo, WI 53594

**DMT** Diamond  
Whetstone™

The answer to  
your sharpening needs

A few light strokes  
will sharpen knives and  
achieve perfect edges  
on all tools.

- Durable • Fast
- Versatile • Clean

Available at quality  
woodworking stores or

**DIAMOND MACHINING  
TECHNOLOGY, INC.**  
85-WD Hayes Memorial Drive  
Marlborough, MA 01752

## Quality EXOTIC WOOD TURNERS

Burls / Thick Planks / for Bowls / Squares

**CABINET MAKERS**  
Individually Selected Lumber for  
Furniture / Boxes / Inlays  
OVER 70 SPECIES

All Inquiries Welcome - Call or Write

**The Berea Hard Woods Co.**

125 JACQUELINE DRIVE, DEPT. 10  
BEREA, OHIO 44017  
216-243-4452

"It's a Matter of Pride for Both of Us"

## DUST COLLECTION

Your best source for  
a complete line of Round Pipe Fittings



**FLEXIBLE HOSE**

Available 2" to 24" Diameter

2-ply, wire reinforced

Diameter	10ft.	15ft.
3"	\$57.50	83.75
4"	\$62.00	90.50
6"	\$77.50	113.75

All items in stock ready to ship

ORDER TOLL FREE TODAY! 1-800-367-3828  
We Pay ALL Surface Shipping Costs!



MC, VISA, CHECKS ACCEPTED



SEND \$2.50 for FULL catalog, Duct calculator and  
Design information. Free with order.

Air Handling Systems by  
Manufacturers Service Co. Inc.  
358-B Bishop Avenue  
Bridgeport, CT 06610  
(203) 336-0533



Where Do Ohio's  
Serious  
Woodworkers Shop?

**WOODCRAFTERS  
SUPPLY ©**

5331 Sinclair Road  
Columbus, Ohio 43229  
(Off I-71)

(614) 436-6900

## WOODWORKING TREASURES

Create beautiful  
scale masterpieces.  
Simple tools & pride  
in your work.  
Award winning  
results!



Choose from:

- V1. Victorian Glider Pony
- V2. Old English Rocking Horse
- C1. Early American Carousel Mare
- C2. French Carousel Rabbit
- C3. 19th Century Carousel Lion

Order Today

Pre-cut Kits, only \$49.95 ea.  
Complete Plans, only \$14.95 ea.  
Illustrated Brochure, \$1.00

Plus, with order!



C2. 14" x 4" x 15"

**The MASTER'S WORKBENCH**

P.O. Box 15284 Dept. BW-29 Portland, OR. 97215

**TOOLS ON SALE**—A Division of Seven Corners Ace Hardware Inc. offers a comprehensive catalog featuring over 430 pages of the most competitive prices in the industry. If you're looking for savings and fast delivery on over 4000 items, request our catalog. This catalog offers one of the most complete selections of power tools available anywhere from the most respected manufacturers in the industry: Milwaukee, Makita, Porter-Cable, Black & Decker, Freud, Bosch, Delta, and many more. SEVEN CORNERS ACE HARDWARE. \$1.00. Circle No. 920.

**A WOODWORKER'S DREAM BOOK!**—Power tools...hand tools...machinery...router bits...pneumatic tools...cutting tools...clamps...hardware...wood parts...books...and more! For our new catalog, we've selected the tools woodworkers want most from around the world...at prices that won't hurt your wallet. This is a must reference for every woodworking shop. So give us a try. Price of catalog is refundable with your first purchase. THE SOURCE. \$2.00. Circle No. 935.

**TOOL CITY CATALOG HAS THE TOOL OR ACCESSORY FOR YOU!**—The 500-page 1987-88 Tool City Catalog is the most complete mail order catalog. It features a comprehensive selection of stationary & portable power tools; hand tools; tool accessories; hardware parts; woodworking books, and shop equipment. Priced to save you money in all categories. TOOL CITY. \$5.00. Circle No. 945.

**WOODWORKING TOOLS OF EXCEPTIONAL QUALITY!**—Since 1928, we have searched the world for tools you don't just buy, but adopt; tools made by craftsmen for craftsmen, classics of lifetime quality for people who love to work with their hands...carvers, cabinetmakers, finishers, hobbyists, builders, teachers. Our catalog details over 4,000 tools, each backed by Woodcraft's unconditional guarantee of satisfaction. WOODCRAFT SUPPLY CORP. Free. Circle No. 955.

**WOODWORKERS SUPPLY**—Offers high quality tools and supplies for skilled, amateur, and professional woodworkers. Our complete catalog includes machinery, hand tools, plans, router bits, shaper cutters, wood specialties, and more. For your two year subscription send to WOODWORKERS SUPPLY OF NEW MEXICO. Free. Circle No. 975.

## KITS

**OAK FURNITURE AND ACCESSORY KIT CATALOG**—features a full range of top quality oak furniture kits and accessory items plus unfinished assembled furniture. Featured items include roll top desks in several styles, stacking barrister's bookshelves, tables, chairs, trunks, file cabinets, bedroom furniture, Mariner's globe, plus many more. Send for full color catalog and enjoy true woodcrafting pleasure. CRAFTSMAN'S CORNER. Free. Circle No. 1017.

**FACTORY DIRECT GRANDFATHER CLOCKS**—Build a magnificent grandfather clock kit from world's largest manufacturer. Clocks are made of solid 3/4" hardwoods, primarily walnut, oak and cherry. West German-made solid brass movements. Send for color catalog showing our selection of grandfather clocks, furniture and home accent pieces. Buy direct from factory and save. EMPEROR CLOCK CO. \$1.00. Circle No. 1030.

**QUALITY CLOCK KITS AND PLANS**—Handmade and semi-assembled of carefully selected 3/4" in. cherry, oak, or walnut with beveled glass. Or build from "scratch" using our detailed plans and trim pieces. Choice of quality movements. Established in 1916. KUEMPEL CHIME CLOCK WORKS. \$2.00. Circle No. 1050.

**CLOCK COMPONENTS**—Quartz movements of all types. Quartz, Westminster chime, fit-ups, bezel, and flat dials. Hand-painted clock dials with kits for you to assemble and sell. Clock hardware and hundreds of items to build clocks. Send for catalog and sales plan. NEWPORT ENTERPRISES. \$1.00. Circle No. 1065.

**MUSIC MAKER'S KEEP BOOK**—A 36-page resource catalog for building and learning to play handmade musical instruments. This source book contains plans, blueprints, kits, books, hardware, strings and accessories for building such instruments as guitars, banjos, dulcimers, harps, violins, pipes, and more. ST. CROIX KITS. \$1.00. Circle No. 1080.

## PUBLICATIONS

**WOOD NEWS**—A newsletter containing tips, ideas, product reviews and specials. HIGHLAND HARDWARE. \$1.00. Circle No. 1129.

**WOOD CARVING**—You can obtain information on learning woodcarving by sending for our literature. The offer includes sample copy of *The Mallet Magazine* and two lesson sheets on carving. NATIONAL CARVERS MUSEUM. \$2.00. Circle No. 1140.

**BOOKS BY AMERICA'S FAVORITE WOODWRIGHT**—Roy Underhill, creator of "The Woodwright's Shop" for PBS, is the author of three best-selling books on hand woodworking and lore. Send for brochure on *The Woodwright's Shop*, *The Woodwright's Companion*, and *The Woodwright's Workbook*. UNIV. OF NO. CAROLINA PRESS. Free. Circle No. 1185.

## SHOP ACCESSORIES

**RIPSTRATE SAVES FINGERS** — for table saw and radial arm saw users. Brochure describes the RIPSTRATE and shows how it gives straighter cuts, speeds, the work, prevents kickbacks, and keeps hands away from the blade. FISHER HILL PRODUCTS. 25¢. Circle No. 1235.

**CLASSIC WORKBENCH**—This is a space saver's dream. Assembled & knocked down in minutes. Beautifully designed workbench is made of Danish Red Beech with a linseed oil finish. Other features include built-in precision steel spindle rises & dogs. Send for literature, LAGUNA TOOLS. \$1.00. Circle No. 1240.

**ROBLAND ONE-MAN SHOP**—Professional quality wood-working machine in a very small area. An ideal machine for people with a limited work area, whether you are professional or a hobbyist. Large capacities, strong motors, cast iron construction, European quality. LAGUNA TOOLS. Free. Circle No. 1241.

**EASY DOES IT** — with HTC'S power tool accessories. Discover many unique items, designed only with you, the dedicated woodworker, in mind. Make your machinery safer, increase the working area of your shop and accomplish nearly impossible tasks easily, quickly, accurately. Full-line catalog and price list. HTC PRODUCTS, INC. \$1.00. Circle No. 1245.

**CHISEL SHARPENING JIG**—Inexpensive, patented jig assures accurate bevvels on chisels and plane irons when used with bench grinder or Makita sharpener. Illustrated brochure. HIGHLAND HARDWARE. \$1.00. Circle No. 1247.

**BUY YOUR SANDING BELTS DIRECT FROM THE MANUFACTURER** — Industrial Abrasives is the company that gives you six free belts with every dozen ordered. But, sanding belts are not the only product we have to offer. In our catalog you will find many specialty items not readily available in your hardware store. Price of catalog refunded with first order. INDUSTRIAL ABRASIVES CO. \$1.00. Circle No. 1248.

**WOOD MOISTURE METER** — Avoid moisture problems such as cracking, warping, splitting, delamination etc. by using a moisture meter, as described in the latest brochure. Moisture Meter Mini-Ligno is designed for serious hobbyists and woodworkers. Attachments for depth measurements and remote reading during air and kiln drying are available. Available Moisture Range 6-20%, 6-36% or 4-30%, 4-60%. Catalog describes complete line of moisture meters. LIGNOMAT USA, LTD. Free. Circle No. 1250.

**ROUTER SPEED CONTROL**—Reduces speed electronically without reducing torque. Route at the speed that gives best results with the wood and bit you are using. Speed adjustable from full speed to 0 RPM. Less tear out—stops burning—less wear on bits—easy to use. Send today for information. MLCS LTD. Free. Circle No. 1251.

**DUST COLLECTION SYSTEMS**—Our 28 page catalog is filled with all the parts needed to design and install a dust collection system. Flex-hose, spiral hose, blast gates, reducers, y-branches, laterals, elbows, and more. The catalog includes tips on how to go about designing and installing your own dust collection system. As an added bonus we are including a duct calculator. Free. Send now for full catalog, duct calculator, and design information. MANUFACTURERS' SERVICE CO. INC. \$2.50. Circle No. 1252.

**AFFORDABLE PRECISION SURFACE SANDER**—Tired of high and low spots and countless hours of sanding? Now you can buy the components to fit your budget and your needs: The Performax S/T Sander attaches to radial saw or stand, optional power feed conveyor unit, stand hardware kit for a build-your-own stand or all the metal, ready-to-assemble pro stand. Send for informative brochure. PERFORMAX PRODUCTS. \$1.00. Circle No. 1253.

**WHOLESALE SANDPAPER, SANDING BELTS, SANDING DISCS**—SUPERGRIT offers its quality line of abrasive products at wholesale prices directly to the consumer. Full or partial box orders welcomed. \$25 minimum order. Prompt, free UPS shipment to most areas. Literature, price list. RED HILL CORP. 50¢. Circle No. 1267.

## BITS, BLADES CUTTING TOOLS

**CARBIDE TIPPED ROUTER BITS AND SHAPER CUTTERS** — Over 400 router bits and shaper cutters displayed in catalog featuring 6 piece cabinet sets, 3 piece 1/2-in. shank router bit panel raising system, and 3 wing industrial shaper cutters. An outstanding selection of top quality shaper cutters available in 1/2-in. - 1 1/4-in. bore, and router bits offered in 1/4-in. and 1/2-in. shank at the industry's best factory direct prices. CASCADE PRECISION TOOL CO. \$1.00. Circle No. 1315.

**INDUSTRIAL QUALITY BAND SAW BLADES**—Precision welded to any length for most applications: All woods, steels, stainless steels, non-ferrous metals, cardboard, plastics and more. Widths from 1/8" - 1 1/4", flexback, hardback, bimetal, special orders. Send for troubleshooting guide to help solve common problems (blade breakage, tooth stripage, etc.). Also included is a blade width selection chart for profile (scroll) sawing. CHANDLER BAND SAW, INC. \$1.00. Circle No. 1316.

**WOODWORKING TOOLS** — Freud provides the finest in hand tools, carbide cutting tools, and hand held power tools. From drills and sanders to carbide saw blades and router bits. Send for catalog. FREUD. \$1.00. Circle No. 1321.

**PRODUCTION QUALITY CARBIDE TIPPED ROUTER BITS** — MLCS Ltd. offers a full line of professional production quality carbide tipped router bits at 50-70% lower than retail prices. We sell through the mail and only direct to craftsmen. Send today for information. MLCS LTD. Free. Circle No. 1350.

## HARDWARE/WOOD PARTS

**OUR READY TO ASSEMBLE KITS**—for Queen Anne chairs and occasional tables make it easy for you to make professional looking furniture. We also stock individual Queen Anne legs for every project. Complete information in our brochure packet. ADAMS WOOD PRODUCTS. 50¢. Circle No. 1401.

**SPECIALTY WOODEN PARTS** — Hundreds of turned wooden parts in maple, birch, oak, cherry, walnut, and colors for toys, furniture, games, and crafts. Included are Shaker pegs, mug pegs, gallery spindles, wheels, axles, balls, finials, smokestacks, plugs, buttons, people, pegs, cargo, game pieces, knobs, handles, candle cups, stool legs. Bulk prices available. Send for color catalog subscription. CHERRY TREE TOYS, INC. \$1.00. Circle No. 1415.

**HARDWARE CATALOG**—A unique 64-page catalog of the very finest in classic, traditional solid brass cabinet hardware. All of British or No. American manufacture. Double & single post handles, knobs, escutcheons, standard & specialty hinges, box hardware, brass screws, castors, latches, catches, locks, and more. GARRETT WADE CO. \$2.00. Circle No. 1427.

**BRASS FURNITURE HARDWARE**—This 36-page catalog shows over 500 items of authentic reproduction hardware from the 1700's and on into this century. This fine quality hardware is a must for the furniture craftsman working on a new project, or the refinisher who needs replacement hardware. HORTON BRASSES. \$3.00. Circle No. 1430.

**SQUARE DRIVE SCREWS**—Once you try them, you will never want to use anything else! The square drive recess virtually eliminates work-damaging driver bit "cam-out," the "lo-root" thread design results in superior holding power; and they are heat treated for strength. Sizes from #6 x 1/2" to #12 x 3", with stainless steel, brass plated, solid brass, and zinc plated available. Quantity discounts. Send for literature. McFEELY HARDWOODS. 25¢. Circle No. 1450.

**WOODWORKER'S SPECIALTIES**—64-page catalog of plans and hard-to-find hardware for woodworkers. Dozens of door harp plans, wood toy plans & accessories, including wood wheels. Also wood turnings, brass hardware, canister liners, stencil supplies, & wood cutouts. MEISEL HARDWARE SPECIALTIES. \$1.00. Circle No. 1455.

## WHY PROFESSIONALS USE BRAD POINT DRILLS

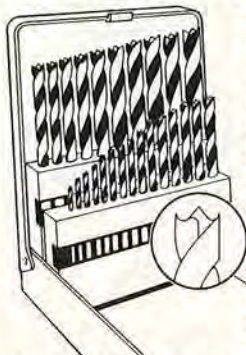

Brad Points are engineered especially for wood - soft wood or hard. The center point (brad point) of the drill is pushed into the marked location for the hole. It locks into position and will not slide out. Then the motor is turned on. The hole is drilled exactly where it is wanted. This is the most important part of dowsing, after proper measuring.

The two outside spurs cut clean entry holes. There is no tear out (splintering) - not even in Oak or Curly Maple - so that if the hole is to be later plugged to cover a screw, the periphery of the hole will be almost invisible.

These spurs provide smooth hole walls and almost flat bottoms. A dowel should touch bottom to glue properly. Metal working drills leave a tapered bottom.

It is best to own a complete 25-pc set and have every size from 1/8" to 1 1/2" in increments of 1/64ths (.0156") because commercial dowsing is seldom sized exactly. Dowels that are too loose don't cut it; those that are too tight don't fit.

**WHY DOLLAR'S BRAD POINTS ARE BEST:** Our drills are milled from the solid; others are only roll forged. Our brad points and spurs are first milled then ground for accuracy. We use high carbon, alloy steel. Many others are made from plain carbon steel. Our drills are heat treated and hardened to Rockwell C48-52. They are tough, sharp and long lasting. Most companies that sell drills do not know what they are made of, or what the hardness is.

**AS FOR PRICE, YOU BE THE JUDGE.**

These drills will fit any 3/8" or larger chuck. FREE metal index included.

ORDER #10-0100 25-pc Brad Point Drill Set **only \$29.95 ea.**  
2 or more sets to one address **only \$26.95 ea.**  
Ship/Handling \$3.00 for 1, \$5.00 for 2 or more to one address.

CALL TOLL FREE: 800-447-7770 • VISA/MC/AMEX  
Dollar Trading Corp. (Est. 1953); P.O. Box 8433, Grand Rapids MI 49518  
Dept. WM03 • Sales Tax MI 4%; CT 7-1/2%  
NO HASSLE, 30-DAY MONEY BACK GUARANTEE

## WOODWORKER'S PLANS & PARTS

### HEIRLOOM ROCKER

Build our classic rocking horse and create a family heirloom which will delight the children in your family for generations to come.

Size: 35" x 58"

Order Plan 400 Only \$10.25

This great rocker retails for over \$300.00

Accessories available See our catalog



Low, low prices on wood parts

Smooth Maple Wood Wheels Eight Sizes

WT-3/4" \$4.50/100  
WT-1" \$5.00/100  
WT-1-1/4" \$7.00/100  
WT-1-1/2" \$10.00/100  
WT-1-3/4" \$15.00/100  
WT-2" \$18.00/100  
WT-2-1/4" \$5.00/20  
WT-2-1/2" \$7.00/20

Axle Pegs AP-1 fits 1" to 2" \$4.00/100

Full Round Wood Balls Four Sizes

BA-3/4" \$8.00/100  
BA-1" \$10.00/100  
BA-1-1/2" 25¢each  
BA-2" 60¢each

Shaker Peg Candle Cup Reg Peg \$16.00/100  
Mini-Peg \$6.00/100  
Candle Cup \$16.00/100  
Mini-Cup \$7.00/100

Tie Peg \$6.00/100

### DOOR HARP PLANS AND PARTS

Same Day Service



Goose



Duck

Plans include stencil design

Harp Plans \$4.00 each or buy all four \$12.50

New design No fret bar



Pig



Clown

Hardware Kit (no plywood) One harp 3.50 Four harps 12.50



Harp Wire 10¢ per ft. 25' for 2.50 100 for 12.00 1 lb. 34.00

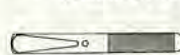

Tuning Pins 30¢ each 50 for 11.00 100 for 18.00 500 for 75.00



Tuning Pin Wrench 3.50 or FREE if harp order totals 35.00



Door Harp Plywood 1 1/2" x 1 1/2" 1.00 ea. 10 for 9.00 30 for 24.00

Shipping \$2.50, NY Res. add tax. Catalog \$1.00 FREE with order. We accept VISA & MASTERCARD. Phone (516) 462-6228

Armor Products Box 445-L East Northport, NY 11731

**WOOD TOY PATTERNS** — Patterns for all ages including children's patterns and executive toys. New catalog has many new patterns to choose from including parts and wheels. Send for new catalog and receive a coupon for free wheels and axle pegs. TOYS AND JOYS. \$1.00. Circle No. 1480.

**QUALITY AMERICAN-MADE WOOD TURNINGS** — such as shaker pegs, spindles, toy wheels, toy parts, craft items, and dowel rods in birch, oak, walnut, and cherry. Send for complete 32-page catalog. WOODWORKS. \$1.00. Circle No. 1490.

## INCOME OPPORTUNITIES

**AMITY, NATION'S #1 QUALITY FURNITURE RESTORATION CO. SINCE 1971**—New product catalog featuring: Complete restoration systems, Hydrocote non-flammable water based stains and finishes, Permafuse repair products, stripping solvents, chemicals and supplies. Amity 1-2-3 wipe-on finishes and much more. Regional workshops in your area. AMITY. \$1.00. Circle No. 1605.

**WOOD CARVING MACHINES AND ACCESSORIES**—make all types of wood carving easy, fun and profitable. The machines do the work. Whether for sign carving, flat 3-D, decoys, panels, gun stocks or furniture, we have the proper machine for the job. Professional woodcarving for the hobbyist and superior quality for the professional. Begin your hobby or full or part-time business by ordering our catalog and price list. MARLIN INDUSTRIES. \$1.00. Circle No. 1659.

**MAKE MONEY IN FURNITURE RESTORATION THE MINUTEMAN WAY**—Earn \$200-\$1000 per day stripping, repairing, refinishing, mirror resilvering, and/or veneering, at home or in shop, spare time or full time. We provide complete free training; no experience necessary. Free workshop teaches you latest in furniture restoration. You have to see it to believe it! Send for catalog. MINUTEMAN. \$2.00. Circle No. 1661.

## MISCELLANEOUS

**MAKE WOODEN TOYS** — Whirligigs, doll houses, classic autos, clocks, music boxes, weather instruments, desk sets, games, crafts & furniture with our plans, parts (hardwood and metal), kits (for all skill levels), books, tools, finishes and supplies. Bulk prices available. Send for 60-page color catalog subscription. CHERRY TREE TOYS, INC. \$1.00. Circle No. 1918.

**MAKE WOODEN CLAMPS** — Save 60%. Kits and plans for 8, 10, and 12 in. wooden handscrew clamps. Acme threaded steel rods, components, handles and full-sized plans provided. Kits also available with uncut and pre-cut maple jaws. You decide how much you want to save. Also available are hundreds of plans, kits, parts, and supplies for wooden toys and whirligigs in our beautiful color catalog. CHERRY TREE TOYS, INC. \$1.00. Circle No. 1919.

**FOLEY-BELSAW INSTITUTES' NEW WOODWORKING CORRESPONDENCE COURSE**—for people with the desire to learn how to work with wood and the proper use of tools. Create over 20 projects using professional plans and tools like a table saw, router with stand, and more...all included with the course. Complete money-back guarantee. Send for details. FOLEY-BELSAW INSTITUTE. Free. Circle No. 1930.

**LEARN ALL THE SKILLS**—of professional upholstery and refinishing techniques in the comfort of your own home. The Foley-Belsaw Institute system of "hands on" training provides clear, step-by-step instructions in the use of tools and materials on actual furniture "kits"...all included with the course. Complete money-back guarantee. Send for details. FOLEY-BELSAW INSTITUTE. Free. Circle No. 1931.

**THE CUSHION CONTOUR SANDER** — is a new concept in pneumatic drum sanding. Sanding sleeves are slid over an air bag (inflated with a hand tire pump) on an arbor to mount it between centers on a wood lathe. Drum effectively takes on profiles, curves, and bevels practically eliminating flat spots and chatter marks. INDUSTRIAL ABRASIVES CO. \$1.00 (refunded with first order). Circle No. 1976.

**BANDSAW OWNERS** — A new tool is now available so you can make or repair any length bandsaw blade in minutes. Our splicer enables craftsmen to make up any length blade from economical coil blade stock quickly and easily. Three models are currently available to accommodate blade widths from 1/4 to 1 1/2 in. The tool comes complete with detailed instructions and supplies. We also carry OLSON bandsaw stock at reasonable prices. Send for literature. NEW MILFORD SPECIALTIES CO. 50c. Circle No. 2025.

**ATTENTION! ANTIQUE RESTORERS! WOODWORKERS! COLLECTORS! AND HOBBYISTS!**—This 192-page wholesale catalog is loaded with unique, hard to find items! Includes hundreds of essential antique restoration parts, brass reproduction hardware, oil lamps and accessories, wood parts, caning, basketry, upholstery, and art supplies, wood refinishing products, tools, books, etc. VAN DYKE'S RESTORERS. \$1.00. Circle No. 2077.

**UNIQUE GREENHOUSE/SCREENHOUSE IDEA**—A gardener's paradise during the winter months, a bug-free screen room during the summer months. That's the concept behind the versatile new Sun-Porch. This two-in-one sun-space features sturdy aluminum framing, 1" shatter-resistant glazing, do-it-yourself assembly, and mounts readily on decks, patios, landscape ties. Color catalog includes models, prices; sent first class mail. VEGETABLE FACTORY, INC. \$2.00. Circle No. 2078.

**SERIOUS WOODWORKERS**—In our shop we offer the finest: INCA, Jet, Konig, RBL, Ryobi, Virutex, Apollo—Keller, Leigh, Excalibur, Portalign—Freud, Byrom, Onsrud—3M, Walco, Behlen's—Imported and U.S. made hand tools—Hardwoods, domestic & exotic—Veneers—Craft plywoods—Books & magazines—Quality, Service and competitive prices. WOODCRAFTERS SUPPLY CO. \$2.00. Circle No. 2080.

**WOODWORKING ASSOCIATION OF NORTH AMERICA** — First international association for woodworkers. Benefits include our quarterly magazine *International Woodworking*, specials from selected manufacturers, group health and life insurance, access to the woodworking network. WOODWORKING ASSOC. OF NORTH AMERICA. 50c. Circle No. 2092.

## CARVING SUPPLIES

**DECOY AND WOOD CARVERS WISHBOOK**—48-page catalog features wide selection of tools and supplies for decoy carvers, wood carvers, wood turners. Chisels, gouges, sharpening stones, precision grinding tools, Fore-dome tools, Fire Brush burners, pneumatic sanders, glass eyes, pewter feet, patterns, paints, reference books. P. C. ENGLISH, INC. Free. Circle No. 2115.

**WOODCARVING TOOLS** — Whittlers and carvers — Warren Tool Co. offers a catalog for you full of whittling and carving hand/power tools, books, stones, wood, and supplies. Since 1927, the finest in woodcarvers tools. WARREN TOOL CO., INC. \$1.00. Circle No. 2185.

**WOOD CARVERS SUPPLY INC.**—offers you the widest array of wood carving supplies in the USA. We offer products for turning, chekering, cabinet making, log building, instrument making, and more. Everything is backed by a 32-year reputation for service and our famous 30-day money-back guarantee. Send for 2-year subscription to our color catalog. WOOD CARVERS SUPPLY INC. \$2.00. Circle No. 2190.

## CLAMPS

**MERLE ADJUSTABLE CORNER CLAMP** — Quick & easy to use. Fully adjustable from 2 1/2" to 69x69 in. Perfect for clamping picture frames, cabinets, or anything that requires 90° corner clamping. The Merle Clamp is cast aluminum & steel construction, a true industrial quality tool. Send today for information. MLCS LTD. Free. Circle No. 2250.

## CLOCKS

**BUILD HEIRLOOM CLOCKS** — Now create beautiful heirloom quality clocks right in your own home. Choose from magnificent chiming grandfather clocks to charming wall clocks. 32-page catalog also offers a selection of music boxes, music movements, traditional barometers, and a huge variety of quartz movements and dials for custom clock building. Satisfaction guaranteed. CRAFT PRODUCTS CO. Free. Circle No. 2320.

**KLOCKIT'S FREE 64-PAGE COLOR CATALOG**—is packed with the largest selection of beautiful wood clock kits for all skill levels, a huge selection of quartz and mechanical clock movements, dials and accessories, turned wood parts, music movements, tools and much more for the craftsmen KLOCKIT. Free. Circle No. 2335.

## CEILINGS

**TOP OFF**—your remodeling project with a good-looking, functional Armstrong tile ceiling or suspended ceiling. You can choose from a wide variety of patterns, from plain white to decorative to warm "wood" grain. Want peace and quiet? Select an acoustical ceiling. It absorbs a minimum of 45% of the noise striking its surface. Send for color brochure that tells you all you need to know. ARMSTRONG. Free. Circle No. 2710.

# Information

WORTH WRITING FOR

Better Homes and Gardens®  
WOOD MAGAZINE, April 1989 Dept.  
MAW089  
P.O. BOX 5103  
Pittsfield, MA 01203-5103

### TO ENSURE PROMPT HANDLING OF YOUR ORDER FOLLOW THESE INSTRUCTIONS:

- Circle your choice
- Enclose check or money order for cost of booklets plus \$2.00 service charge (no stamps/foreign)
- Send coupon and remittance to address above
- U.S. FUNDS ONLY
- ALLOW 4-6 WEEKS FOR DELIVERY
- Coupon expires April 14, 1990

### WOOD SUBSCRIPTION

1. A 1 year WOOD subscription (6 issues) for \$18.00 (U.S. price) — a \$3.00 savings off newsstand rate. Allow 6-8 weeks for first issue. Canadian price \$24.00. Be sure to include payment with total below. NO FOREIGN ORDERS ACCEPTED ON THIS COUPON; please contact Subscription Dept. directly.

### FREE LITERATURE

Circle numbers below corresponding to items in this issue.  
Please include \$2.00 for handling charge

17.	42.	77.	199.	1185.	1930.	2335.
18.	44.	84.	860.	1241.	1931.	2710.
19.	57.	85.	955.	1250.	2115.	
20.	70.	99.	975.	1251.	2250.	
41.	76.	100.	1017.	1350.	2320.	

### PRICED LITERATURE

Numbers below refer to items on which there is a charge.  
Please include proper remittance.

3....\$1.00	232....\$1.00	480....\$1.00	877....\$2.00	1140....\$2.00	1401.....50c	1919....\$1.00
4....\$1.00	310....\$2.00	510....\$1.00	890....\$1.00	1235....25c	1415....\$1.00	1976....\$1.00
6....\$2.00	315....\$1.00	520....\$1.00	900....\$4.00	1240....\$1.00	1427....\$2.00	2025....50c
56....\$1.00	345....\$2.00	530....\$2.00	915....\$3.00	1245....\$1.00	1430....\$3.00	2077....\$1.00
87....\$1.00	355....\$8.00	545.....50c	920....\$1.00	1247....\$1.00	1450....25c	2078....\$2.00
90....\$1.00	370....\$1.00	563....\$2.00	935....\$2.00	1248....\$1.00	1455....\$1.00	2080....\$2.00
93....\$1.00	390....\$1.00	578....\$2.00	945....\$5.00	1252....\$2.50	1480....\$1.00	2092.....50c
94....\$1.00	424....\$1.00	592....\$1.00	1030....\$1.00	1253....\$1.00	1490....\$1.00	2185....\$1.00
96....\$1.00	454....\$10.45	801....\$2.00	1050....\$2.00	1267....50c	1605....\$1.00	2190....\$2.00
97....\$1.00	455....\$11.45	810....\$1.00	1065....\$1.00	1315....\$1.00	1659....\$1.00	
112....\$2.00	456....\$10.45	820....\$1.00	1080....\$1.00	1316....\$1.00	1661....\$2.00	
160....\$1.00	457....\$10.45	855....\$4.00	1129....\$1.00	1321....\$1.00	1918....\$1.00	

Name (please print) \_\_\_\_\_

Address \_\_\_\_\_

City \_\_\_\_\_

State \_\_\_\_\_ Zip Code \_\_\_\_\_

94

### I AM ENCLOSING:

\$\_\_\_\_\_ for priced items

\$ 2.00 for handling

\$\_\_\_\_\_ total remittance



ORDER TOLL FREE 1-800-328-0457 - MAIL ORDER HOURS 7:00-5:30 C.S.T. MONDAY-FRIDAY

DELTA BENCH TOP TOOLS			
Model	List	Sale	
23-700	Welding grinder	201	135
23-580	6" bench grinder 1/2 H.P.	81	62
23-880	8" bench grinder 1/2 H.P.	136	99
23-980	10" bench grinder 1 H.P.	246	199
11-950	8" drill press	184	119
14-040	14" drill press	313	240
40-150	15" hobby scroll saw	178	125
28-160	10" hobby band saw	189	129
31-050	1" belt sander 2.0 amp	93	69
31-460	4" belt/sd. sander	178	125

DELTA STATIONARY			
Model	List	Sale	
34-761	10" unsaw 1 1/2 H.P.	1579	1179
22-651	13" planer 2 H.P.	1586	979
34-429	10" lifting arbor bench saw		
	1 1/2 H.P.	1479	999
28-243F	14" band saw w/stand, no motor	621	419
33-990	10" radial arm saw	727	539
11-072	32" radial drill press	487	360
37-280	6" motorized jointer	440	319
50-179	3/4 H.P. 2 stage dust collector	435	339
37-154	Deluxe DJ-15 6" jointer w/1/2 H.P. motor	1288	979

**BRAND NEW BY DELTA:**  
**33-050 8 1/4" Sawbuck**  
 List Price 742 Special Sale 539!!  
**34-330 8 1/4" Table Saw 13 Amp**  
 List Price 321 Special Sale 225!!

MILWAUKEE TOOLS			
PRICE BUSTERS			
Model	List	Sale	
0224-1	3/8" drill 4.5A magnum	179	110
0234-1	1/2" drill 4.5A w/agg 0.850 rpm	189	105
0244-1	1/2" drill 4.5A magnum 0.600 rpm	189	105
0222-1	3/8" drill 3.5A 0-1000 rpm	169	95
0228-1	3/8" drill 3.5A 0-1000 rpm	154	88
0275-1	3/8" close quarter drill	208	115
0279-1	1/2" close quarter drill	243	139
0212-1	3/8" cordless drill w/spd.	263	149
6539-1	Cordless screwdriver 190 rpm	108	62
6540-1	Cdless screwdriver w/bts & cse	137	87
6545-1	Cdless screwdriver 200 & 400 rpm	120	72
3102-1	Plumbers rt angle drill kit	295	179
3002-1	Electricians rt angle drill kit	290	179
1579-1	D-Handle Ham drill kit	299	169
1569-1	H.D. Hole Hawk w/cls	395	235
6511-1	2 sp SawZall w/cls	209	119
6405-1	8" circle saw	209	119
6750-1	Drywall gun 0-4000 4.5A	149	89
6798-1	Tek screwdriver	173	105
6226	2 sp bandsaw w/clsae	416	240
6224	TSC bandsaw w/clsae	427	279
6507	TSC SawZall w/clsae	219	129
6170	14" chop saw	430	255
6212	Orbital sander 3 1/2"x7 1/2"	179	100
6214	Orbital sander 4 1/2"x9 1/2"	189	110
6305	6 1/2" cordless circle saw	284	155
6753-1	Drywall gun 0-4000 3.5A	129	79
8977	Var temp heat gun	109	70
0214-1	3/8" v spd cordless drill	220	125
5397-1	3/8" v spd hammer drill kit	227	139
5371-1	1/2" v spd hammer drill kit	313	199
3167-1	1/2" v spd rt angle drill kit	305	180
6754-1	Drywall gun 0-4000 4.5A	179	115
6232	4 1/2" bandsaw w/clsae	432	275
6747-1	Drywall driver 0-2500	149	87
0230-1	3/8" drill 0-1700 rpm	169	99
3300-1	1 1/2" v spd magnum rt angle kit	289	179
5620	Router 1 H.P.-8 amp	289	180
5660	Router 1 1/2 H.P.-10 amp	299	180
5680	Router 2 H.P.-12 amp	350	205
5455	3/4" polisher 1750 rpm	199	125
5375	7" polisher 2800 rpm	259	159
6215	16" chain saw	280	169
6935	Heat gun	85	55
6366	7 1/2" circular saw	198	112
6368	7 1/2" circular saw w/clsae	226	125
0216-1	2 spd cordless drill Hi-torque	222	134
0235-1	1/2" drill keyless chuck mag	199	123
6016	1/4" sheet pad sander	75	44
6415	4 1/2" grinder 10000 rpm	149	95
8950	B gal weld/vac	205	139
8955	10 gal weld/vac vac	279	169
0238-1	1/2" drill keyless chuck	189	114
6749-1	Drywall gun 0-2500 4.5A	189	117
6377	7 1/2" worm drive saw	275	155

FREUD SAW BLADES			
% Bore Industrial Grade CARBIDE TIPPER SAW BLADES:			
Item No.	Description	Diam.	List Sale
LUM1010	Gen Purp ATE	10"	49 34
LUM1010	Gen Purp 3Ch	10"	49 34
LUM2010	Cut-off	10"	50 35
LUM4011	Combination	10"	50 35
LUM5010	Super Cut-off	10"	50 35
LUM7010	Ripping	10"	24 16
LUM2010	Cut-off	10"	50 35
LUM3010	Thin kerf	10"	24 16
LUM8010	Thin kerf	10"	60 39
PS203	Genl Purp	7 1/2"	24 16
FS303	Plywood	7 1/2"	40 25
OS306	8" Dado Carbide		183 95
OS308	8" Dado Carbide		265 89
F0	1 1/2"x1 1/4" Biscuits 1000 Qty		25
F10	2 1/4"x1 1/4" Biscuits 1000 Qty		25
F20	2 1/2"x1 1/4" Biscuits 1000 Qty		25
FA	Assorted Biscuits 1000 Qty		28
WC106	4 pos. chisel set w/clsae 1 1/2"		39 27
WC108	6 pos. chisel set w/clsae 1 1/2"		52 36
WC110	10 pos. chisel set w/clsae 1 1/2"		88 39
78100	15 pos. chisel set w/clsae 1 1/2"		152 85
34-100	5 pos. router bit door system		260 159
J5100	Biscuit Joiner		265 154

MAKITA CORDLESS			
Model	List	Sale	
6071DW	3/4" var spd rev 7.2v	123	65
6071DDW	3/4" var spd rev w/removable batt. 7.2v	190	105
5090DW	3 3/8" saw kit. 9.6v	243	125
5600DW	6 1/4" circular saw, 10.8v	317	167
4610DW	3 1/2" angle drill, 7.2v	155	89
6016SDW	3/4" cordless drill, 7.2v	103	58
4330DW	9.6v volt cds. recip saw kit	238	130
6010DL	3/4" drill w/flashlight, 7.2v	198	112
6012DW	2 spd. driver drill w/clutch & case. 9.6v	224	110
6710DW	Cordless screwdriver kit, 7.2v	186	103
6092DW	Wspd. drill, kit complete	237	115
6093DW	Wspd. drill w/clutch-complete	248	119
6891DW	Drywall gun 0-1400, 9.6v	225	119
KD1001	6010 DWK drill kit comp & 40710 vac cleaner	178	115
6320E4	9.6 volt battery	49	29
6320E4	7.2 volt battery	42	27

50079A	7 1/2" saw w/elec. brake	228	125
50089A	8 1/2" saw w/elec. brake	276	145
804510	Sander	80	46
990908	3"x21" belt sander w/bag	254	139
992408	3"x24" belt sander w/bag	288	159
9035	3 1/2" sheet finish sander	106	58
90450	1/2" sheet finish sander	216	116
9045N	1/2" sht fin sand w/bag	219	117
4200N	4 1/2" circ saw 7.5 amp	213	111
9021NA	10 1/4" circ saw 12 amp	506	288
43018V	Orb vspd jig saw 3.5 amp	274	145
JR3000V	2 sp recip saw w/clsae	220	122
LS1020	New 10" mitre saw	440	229
90210	Blade sharpener	354	199
419	Dust collection unit	489	269
3705	Offset trimmer	255	129
19090W	3 1/4" planer w/clsae	198	115
1100 1 1/4"	3 1/4" planer w/clsae	381	185
927SPC	3" sander-polisher	262	139
3601B	1 3/8" H.P. router	242	125
3708B	1/2" H.P. trimmer	180	92
95018	4" grinder	137	65
804500	6" round sander	95	57
804550	1/2" sheet pad sander w/bag	95	46
DA3000R	1 1/2" angle drill	286	139
DP4700	1/2" vspd w/rev 4.8 amp	195	109
6300LR	1/2" angle drill w/rev	325	175
2705W	8 1/4" table saw	474	245
2711	10" table saw w/brake	800	460
GV5000	Disc sander 5"	109	59
6800DB	2500 rpm 3.5 amp	140	79
6800DBV	0-2500 rpm 3.5 amp	154	89
6801DB	4000 rpm 3.5 amp	140	80
6801DBV	0-4000 rpm 3.5 amp	154	89
2030N	12" planer/jointer	3270	1575
2040	15 1/2" planer	2470	1375
1805B	6 1/2" planer kit w/clsae	546	329
JV1600	Var speed jig saw	220	119
JV2000	Var speed orb jig saw	242	127
50058A	5 1/2" circular saw	211	115
50058H	5 1/2" circular-grinder	153	79
6404	3 1/2" drill 0-2100 rpm, 2 amp	102	55
6301LV	3/8" drill rev. 0-1050 rpm	137	72
6013BR	3/8" drill rev. 6 amp	240	125
58010	6 1/2" circular saw -12 amp	305	165
3612BR	3 H.P. plunge router	376	185
9401	4"x24" belt sander w/bag	362	182
3620	1 1/2 H.P. plunge router w/clsae	182	97
4302C	Vspd. orb jig saw	287	145
5077B	7 1/2" Hypoid saw	248	139
LS1430	14" Mitre saw	624	319
2414	14" cut-off saw AC/DC	350	195
5007NB	7 1/2" circ saw 13 amp	209	110
3612B	3 HP plunge router sq/b	376	185

SKIL ZIZZERS			
Model	List	Sale	
5510	(551) 5 1/2" circ saw	112	92
5625	(562) 6 1/2" circ saw	175	110
5656	(563) 7 1/2" circ saw	132	103
5665	(564) 8 1/2" circ saw	204	118
5750	(807) 7 1/2" circ - drop foot	186	115
5785	(808) 8 1/2" circ - drop foot	216	130
5790	(810) 10 1/4" circ - drop foot	400	229
5825	(825) 8 1/2" worm saw	250	149
4580	Var. orb. jig saw w/clsae	144	82
3810	10" Mitre saw	263	189
595	3"x21" sander w/bag 5.5A	197	125
7565	1 1/4" palm sander	52	34
7313	3x18 belt sander 4.5A	72	58
77	7 1/2" worm drive	230	132
5350	2 1/2 HP circ saw	80.99	69
5250	2 1/2 HP circ saw	58.99	49

**XTRA SPECIAL BY SKIL**  
 2735-04 12v Vspd. Cordless Drill comp. w/clsae & 2 Batt. 210 118

LEIGH DOVHEAT JIGS			
Model	List	Sale	
D1258-12	List \$114.00 - Sale 245.00		
D1258-24	List \$75.00 - Sale 229.00		

HITACHI TOOLS			
Model	List	Sale	
TR5	Trimmer	177	95
TR6	Plunge router, 1 1/2 H.P.	219	119
TR12	Plunge router, 3 H.P.	354	189
C10FA	10" dive mitre saw	490	265
C09F	8 1/2" slide compound saw	859	475
C15F	15" mitre saw	745	389
FREUD LU85M15	15" Carb. Blt.		
108 Tooth		181	115

**1989 TOOL CATALOG AVAILABLE**  
 Call Toll-Free 1-800-328-0457 - In Minnesota Call (612) 224-4859  
**CHECK - MONEY ORDER - VISA - MASTERCARD - DISCOVER**  
**SEVEN CORNERS ACE HDW. INC.**  
 216 West 7th St. - St. Paul, MN 55102 - Est. 1933

DELTA TOOLS			
Item No.	Table Saw Complete w/1 1/2 H.P. motor & stand	List	Sale
34-410		579.00	
33-150	8 1/4" Saw Buck	499.00	
28-243S	14" Band Saw w/open stand, light attach & H.P. motor	479.00	
28-283F	14" Band Saw w/enclosed stand & H.P. motor	599.00	
43-122	Lt. Duty Shaper w/stand & 1 H.P. motor	499.00	
17-900	16 1/2" Floor Drill Press	289.00	
40-601	18" Scroll Saw w/stand and blades	679.00	

**DELTA**  
 10" MITRE BOX  
**XTRA SPECIAL**  
 179.00  
 List 289.00

**TOOLS ON SALE™**  
 AMERICA'S LOWEST PRICED TOOLS  
 FREE FREIGHT TO THE 48 CONTINENTAL STATES ON EVERY ITEM.  
 PRICES SUBJECT TO CHANGE WITHOUT NOTICE

PIRANHA By Black & Decker CARBIDE TOOTH SAW BLADE					
Model#	Diameter	Teeth	List	Sale	
73-756	6-1/2	36	28.96	16.30	
73-717	7-1/4	18	13.14	7.10	
73-737	7-1/4	24	16.36	9.00	
73-					

## WILLING TO TALK

Looking for an informative someone to address your woodworking group? Contact the Early American Industries Association. The national organization's newly formed speakers' bureau lists members who cover topics such as colonial clockmaking, 18th-century cabinet-making, and cooperage. So far, most of the speakers live in the New England area.

To inquire about a speaker, or to add your name to the speakers' list, contact Ruth Hyde, R.D. 1, Box 45, Golts, MD 21637.

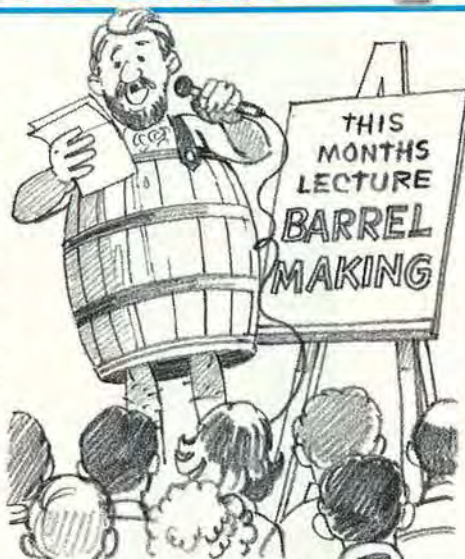

## AN IDEA TO STICK WITH

As you lie awake at night, trying to come up with a woodworking project so clever and innovative that no one has ever thought of it before, keep this in mind: At last count, the British Stickmakers Guild had 1,000 members. That's 1,000 craftsmen who believe that a simple, traditional walking stick is still worth making, and still worth making well.

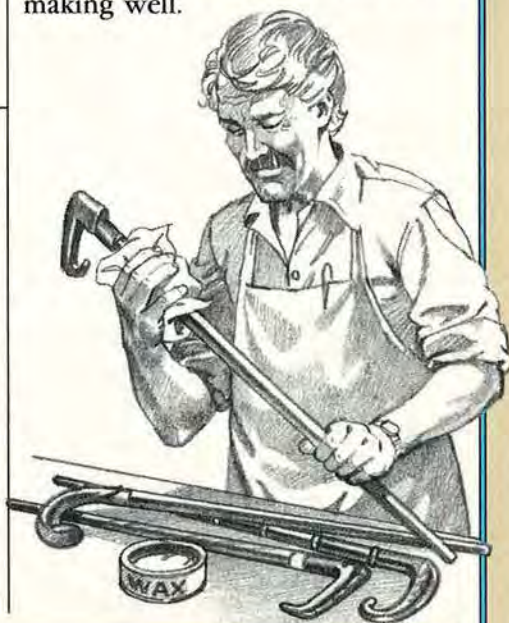

## OH, BACK PAIN!

Before chainsaws, loggers felled trees and bucked (crosscut) the trunks with a handsaw they referred to as a "misery whip." Apparently, they weren't too fond of the backbreaking work.

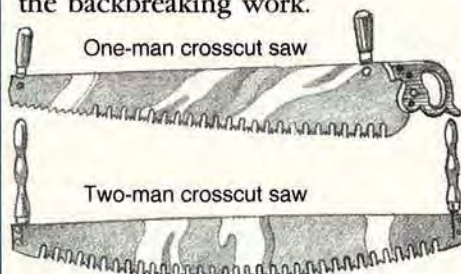

## HIRING FUNGI

Everyone's discovering spalted wood! Thirteen corporations, including giants such as Boise Cascade, Procter & Gamble, and Weyerhaeuser, want to put lowly, decay-causing fungi to work. Calling themselves the Biopulping Consortium, the companies support research using fungi to turn wood chips into paper pulp. Studies suggest a 25 percent energy savings over the present "cooking" method from pretreating the wood with fungi to break down wood fibers.

## OUT OF AFRICA

Carlton McLendon brings home more than a T-shirt when he travels. For instance, his memento from a trip to Africa was something that's sacred in its homeland and awfully valuable everywhere else—pink ivory wood.

Not only are there very few pink ivory trees (no more than 50, it's estimated), but only Zulu chiefs may possess the wood. Under tribal law, anyone else with it could draw the death penalty.

"My wood came from a friend who got it in return for a political favor from a member of South African parliament," relates Carlton, a garrulous 76-year-old who ran a furniture plant for 40 years and now sells lumber in Atlanta as

Carlton McLendon, Inc. To return the favor, Carlton sent some handcrafted American knives to the South African politician, the South African Minister of Forestry, and to the Zulu chief in the Transvaal region where the wood came from. "The chief—known as professor by his tribe because he has a Ph.D. from Oxford—got the fanciest. It was an oversized bowie with his name engraved on the blade," he says.

Carlton had his two pink ivory logs (one 16" in diameter, the other 12"), sawed into slabs and sells the wood for \$40 a pound. "One woodturner bought a 1'-long length for \$1,000," he notes. "I haven't used any, myself." 🌲

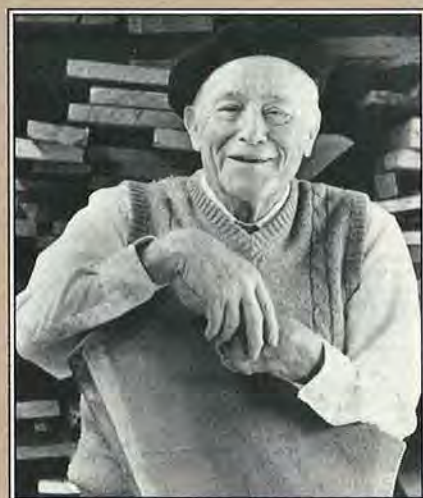

"Most pink ivory goes for knife handles, at \$25 for a 1½×4½×1" piece," says Atlanta wood dealer McLendon, above, posing by his valuable wood.

# MAKE THE ULTIMATE CHOICE.

\$275

\$250

(Bench Model)

\$140

\$650

\$400

As "the" producer of top end industrial woodworking machines since 1921, Powermatic now focuses their engineering expertise and resources for the craftsman, contractor and home hobbyist.

Responding to **your** expressed needs, the **Ultimate Choice Line** of woodworking machinery was developed. Leading the industry in quality, features, and exceptional value. Available now for little or no more than you'd pay for run-of-the-mill machinery.

• **10" Contractor's Saw** — setting the standard for accuracy, ruggedness and portability with industrial quality

Vega fence, built-in dust shroud, T-slot miter gauge and more

• **15" Scroll Saw** — ideal for every shop, with clamp blade holder for easy blade mount, and chip blower standard

• **14" Drill Press, Bench and Floor Models** — with front mounted switch with removable key for safety; 12 spindle speeds; and a table that elevates by crank, tilts, and rotates

• **½" Shaper** — with ¾" solid and ½" interchangeable spindle cartridges,

exclusive fence with integral dust shroud and spindle reversing switch (standard)

Call your **Powermatic Ultimate Choice** distributor today for assistance in selecting the right machines for you.

**The Ultimate Choice**  
**POWERMATIC** *III*

A Division of Stanwich Industries, Inc.

McMinnville, Tennessee 37110

800/248-0144 □ 615/473-5551

TELEX - 554455

FAX # 615/473-7819

# Thin Kerf. Advanced Design.

## The Freud Difference

**Superior Carbide.** Some of the physical properties of carbide, elasticity, hardness and resistance to chemicals, can be changed to meet cutting requirements.

To ensure the blade you buy has the best carbide qualities for its purpose, Freud produces special blends at its own factory. Through a combination of robotic and computer monitoring, each batch is checked to assure purity and quality.

**Advanced CAD System.** The Computer-Aided Design System simulates actual cutting conditions in three dimensions and records the blade performance. This allows Freud engineers to electronically vary the material being cut and the blade's physical characteristics to develop saw blades that provide optimum cutting performance.

**Laser Technology.** A computer-controlled, 500-watt laser is used in the production of Freud cutting tools. The concentrated beam of light creates a perfectly round blade, produces shoulders identical in shape and size and precisely centers the arbor hole. In addition, expansion slots are strategically placed to allow for heat dissipation during brazing and blade body expansion during actual use.

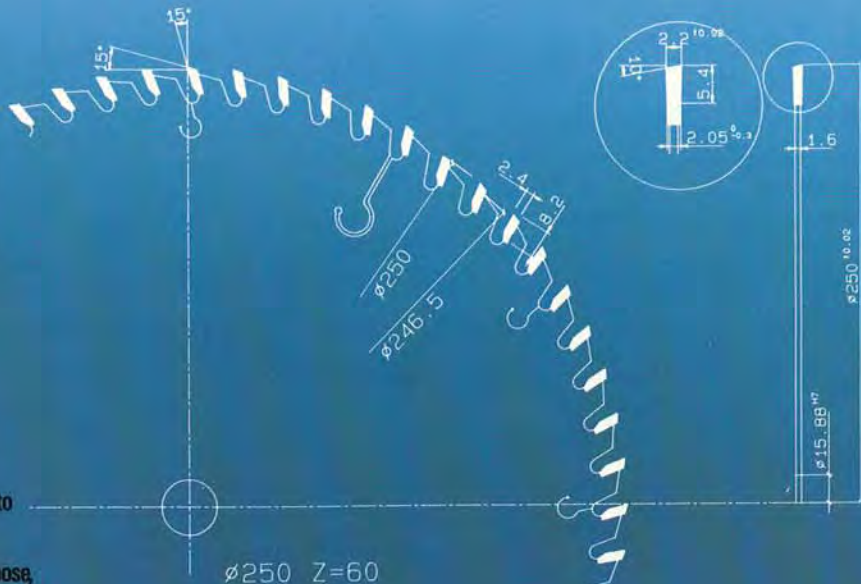

## Freud Perfects the Thin Kerf Blade.

Using advanced technology, Freud's international team of European and North American engineers have perfected the thin kerf saw blade. They have eliminated misaligned teeth, poor blade body tensioning, carbide chipping and a variety of other problems common with some thin kerf blades.

The kerf on the Freud 10-inch crosscut blade, 28% thinner than the standard .126 inch kerf blade, reduces material loss when working with rare or expensive wood.

Freud's thin kerf blade also requires less energy to feed the material into the saw blade, eases the strain on your power tool and makes your work easier and safer.

Turn your under-powered saw into a real board cutting champion with Freud's thin kerf blade. Each thin tooth takes out less wood than the standard carbide blade, thus requiring less horsepower to produce equally good results. Also, the radial arm saw's aggressive self-feeding characteristics are virtually eliminated.

For the best value in advanced thin kerf blade technology, demand Freud.



Thin kerf blade compared to standard kerf blade



Freud thin kerf blades  
Rip (left), Crosscut (right)

Stock Number	Thin Kerf Rip	Kerf	Suggested Retail
LJ87M008	8" x 22 x 5/8"	.086 inch	\$49.00
LJ87M009	9" x 22 x 5/8"	.094 inch	\$54.00
LJ87M010	10" x 24 x 5/8"	.094 inch	\$56.90
Stock Number	Thin Kerf Crosscut	Kerf	Suggested Retail
LJ88M008	8" x 48 x 5/8"	.082 inch	\$59.90
LJ88M009	9" x 54 x 5/8"	.090 inch	\$63.90
LJ88M010	10" x 60 x 5/8"	.090 inch	\$69.90

Call for the name of your local distributor:

**freud**

Freud Inc.  
218 Feld Ave.  
High Point, NC 27264  
(919) 434-3171