

Better Homes and Gardens®

Special
Edition

WOOD

PRODUCTS GUIDE

THE #1 MAGAZINE FOR HOME WOODWORKERS

NOVEMBER 1991 • ISSUE NO. 47
Display Until December 10

**NEW,
INNOVATIVE,**
and
**JUST-PLAIN-HANDY
PRODUCTS**
for the
Home Woodworker
and
Do-It-Yourselfer

**250
GREAT
PRODUCTS**

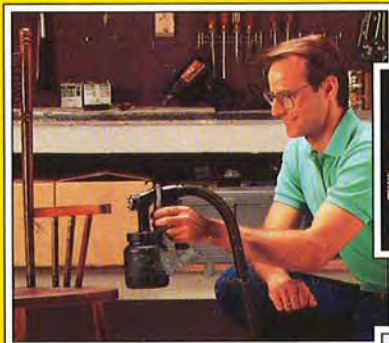
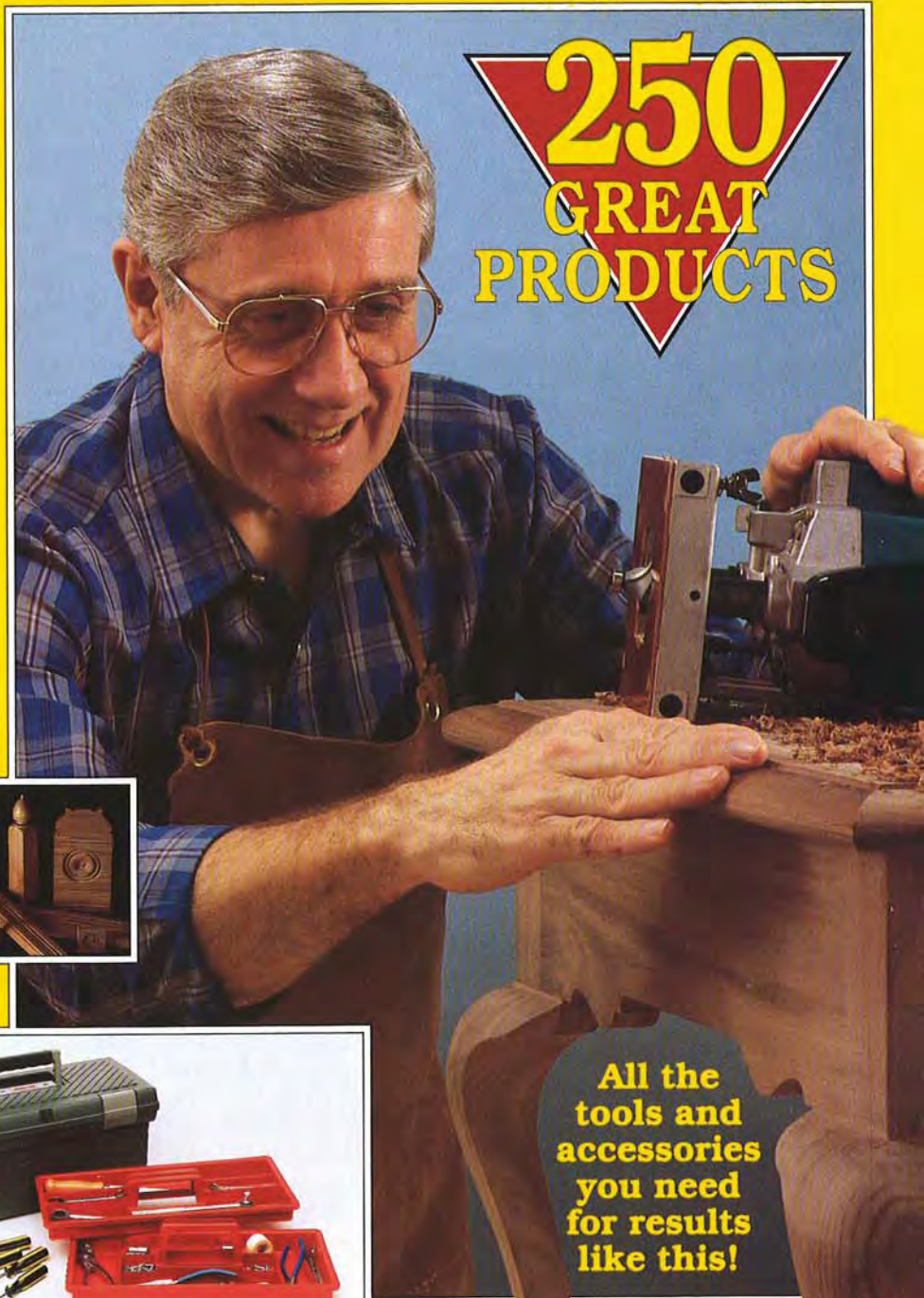

All the
tools and
accessories
you need
for results
like this!



CRAFTSMAN® All You'll Ever Need in a Power Tool.



From project start to a perfect finish,
you can always count on Craftsman to pull you through.

Sure, you could pay more for a tool, but you'll never need to. Because the tools in our Contractor Series are engineered to handle the most demanding projects.

Rigorous life testing on every tool backs up our promise of Craftsman reliability. For example, we ripped 40,000 feet of 2" x 6" stock in just four working days with our Contractor Series tablesaw. We repeatedly jam-tested our 10" compound miter saw for 2,000 cycles. The motor was then cycle-tested at 150% of its rated amperage for 167 hours. The ability of both tools to withstand this abuse was rated excellent.

They continue to be used daily in our engineering workshop.

There's more about every one of the tools in the Contractor Series that will impress you. And you don't have to call your nearest distributor to see for yourself.

Just zip on down to your Sears store.

CRAFTSMAN®
Only at Sears

Horsepower shown on tools is maximum developed.

This One Is For The Shopper In All Of Us

If you're like me—and I have a hunch that you are—you probably get a big kick out of going to homecenters, specialty woodworking stores, and hardware stores. It's there that I'm always running across a new wood-finishing product, or discovering an ingenious cabinet hinge, or happening onto any number of other products that are useful to me as a homeowner and a woodworker. Now that's my kind of shopping!

With that idea in mind, the staff and I have assembled this special Products issue. Now, you can do a little shopping without having to fight the Saturday-morning crowds or wait in line behind someone who doesn't quite know what he wants. On the pages that follow, you'll see over 250 products that we think woodworkers and do-it-yourselfers alike will find interesting.

To locate these products, we asked literally hundreds of manufacturers to nominate their best products. From the 1,000-or-so submissions, we chose about 150 items that we found most innovative and useful. Then, we traveled to the National Home Center Show in Chicago this spring where we interviewed manufacturers, witnessed product demonstrations, and tried out tools for ourselves. The result: another 100 products that just may change your woodworking habits.

 [Print this article](#)

How to use this guide

To help you easily find the products, we've organized them into six chapters and included an index on page 4. For more information on a product, or where to find a dealer in your area, we've included the manufacturer's or supplier's address and phone number with each product description. You'll also find a manufacturer's listing on page 92.

We know that price influences your buying decision, too, so we've made every attempt to include an approximate price with each tool or accessory. Please use these prices as a shopping guideline, but not as a firm quotation.

By the way: we're not changing the *WOOD*® magazine format. This is the ninth issue in our new nine-issue line-up. For most subscribers, this is a bonus edition. Next month, we'll be back to our regular fare of great projects, techniques, tips, feature stories, and other information-packed articles you have come to expect from us. If you like this change-of-pace, let me know. Maybe we'll do it again next November.

My thanks especially to Products/Techniques Editor Bill Krier and Perry McFarlin, our assistant art director (shown in photo), for their superb efforts in putting this issue together.

See you next time!

Larry Clayton



Products and Techniques Editor Bill Krier, seated, and Assistant Art Director Perry McFarlin making a few final color corrections on this special issue of *WOOD*®.

Mobile Machine Bases

to put your entire shop on wheels

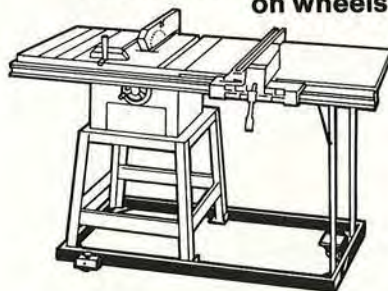

EXPANDS YOUR WORKING AREA
MAKES CLEAN-UP A SNAP

- Over 1000 models to choose from
- Designed for correct machine fit
- Constant 3-wheel suspension insures tool stability
- Dual wheel locks for positive positioning
- No lifting needed to move or dropping to use
- Protects machine settings and components
- All steel and precision welded
- Lifetime warranty

Work Supports

to do your best safely and accurately

Model HRT-18



UNIQUE TAPERED WEDGE ELIMINATES SLIP DOWN. TESTED TO 1000 lbs.

44"-26½" height range

Adjustable levelling feet

HEAVY DUTY

DESIGNED TO HELP YOU SUPPORT AND SAFELY MOVE WORK PIECES THRU YOUR MACHINES

- No tools needed for simple, positive height adjustments
- Top quality, galvanized, ball-bearing rollers
- 4 heavy duty threaded rubber-tipped levelling feet.
- Heavy gauge steel components
- Lifetime warranty

Available at better tool stores



FREE CATALOG



HTC Products, Inc.
120 E. Hudson • P.O. Box 839
Royal Oak, Michigan 48068-0839

1-800-624-2027

FREE Catalog!

Call TOLL-FREE
1-800-237-5907
Dept. 2211



Innovative Tools Solve Your Woodworking Problems!

The Leichtung Workshops Catalog is the only place you'll find "Leichtung Innovations", those tools we've designed and built on our own to make your woodworking and home repair jobs faster and easier. Call our toll-free phone, mail the coupon, or fax it to 1-216-464-6764!

Please send me your FREE catalog!

Name _____
Address _____
City _____
State _____ Zip _____
LEICHTUNG WORKSHOPS 4944 Commerce Pky. #2211
Cleveland, OH 44128

Trace Your Design On Wood With

Saral[®] Wax-Free Transfer Paper

Transfer your design to any wood surface with Saral-Transfer Paper.

- Waxless and greaseless - erases like pencil with no smear.
- Ink or paint over the tracing - won't skip.
- Re-usable.
- Available in 5 colors: graphite, white, blue, red, yellow.
- Comes in Sampler and Tole Kit packages, and 12-ft. Rolls.

Ask for it at your local art and craft materials store. For further information contact:

Saral Paper Co., Inc.
322 W. 57th St. Suite 30-T
New York, NY 10019
(212) 247-0460

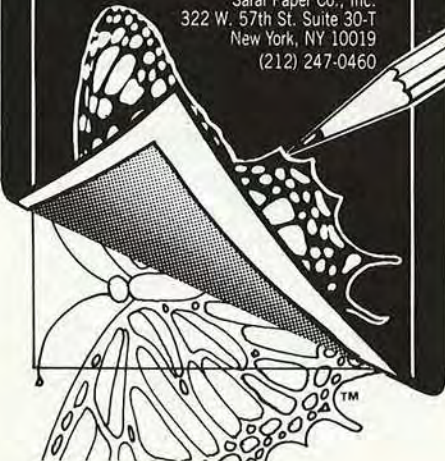

Better Homes and Gardens[®]

WOOD[®]

THE #1 MAGAZINE FOR HOME WOODWORKERS

This issue's cover wood grain: Red Alder

Cover photo: Hopkins Associates

NOVEMBER 1991

ISSUE NO. 47

Handy Tools18

The craftsmen of yesteryear would turn green with envy at the selection of hand tools available to you today.

Power Tool Potpourri34

Good-quality stationary power tools make even the most demanding woodworking tasks a lot easier. Here are a few worth your scrutiny.

The Finish Line42

Chemists far and wide have formulated innovative finishes for woodworkers. Let's take a look at what they've cooked up for you.

Power You Can Hold Onto.50

You can cut the biggest job down to size in no time, provided you have the right portable power tool in hand.

Power Tool Accessories.60

A collection of the right accessories will help you get more usefulness out of all the power tools in your shop.

Medley Of Merchandise76

Glue, hardware, safety supplies, and more. If it defies being put into the above categories, you'll find it here.

Editor's Angle.....	1
Product Index.....	4
Tool Safety Tips.....	16
Differences Between Consumer and Professional Tools.....	58
Manufacturers' Listing.....	92
Information Worth Writing For.....	102

Editorial/Art Staff

Editor **LARRY CLAYTON**
 Managing Editor **JIM HARROLD**
 Art Director **C. L. GATZKE**
 Assistant Art Director **PERRY A. MCFARLIN**
 Design Editor **JAMES R. DOWNING**
 Senior Editor **PETER J. STEPHANO**
 How-To Editor **MARLEN KEMMET**
 Products/Techniques Editor **BILL KRIER**
 Special-Interest Editor **LARRY JOHNSTON**
 Copy/Production Editor **JOHN D. HOFHEIMER**
 Project Builder **JAMES E. BOELLING**
 Administrative Assistant **DARLENE REYNOLDS**
 Business Office Clerk **MARGARET CLOSNER**
 Secretary **ROSEMARIE BURCH**

Woodworking Product Guide

Editor **BILL KRIER**
 Graphic Designer **PERRY A. MCFARLIN**

Publisher **WILLIAM R. REED**
 New York Advertising Manager **CHRIS W. SCHRAFT**
 Advertising Representatives **CRAIG KAPLAN,**
BRENDEAN DELANEY
 Promotion/Research Director **EILEEN SULLIVAN**
 Advertising/Marketing Services Manager **SIGRID FOLKERS**
 Publisher's Assistant **NANCY LOPEZ**
 Advertising Assistant **KIMBERLY DAVIS**
ADVERTISING OFFICES: 750 Third Ave., New York,
 NY 10017. Phone 212/551-6903.

Circulation Manager **ALAN BRUSH**
 Newsstand Circulation Director **MICHAEL SENIOR**
 Business Manager **TERRY UNSWORTH**
 Production Director **ROBERT C. FURSTENAU**
 Public Relations **SONDY DAGGETT**
 Special Projects **JAY BURZON**

Magazine Group Officers

Group President **JAMES A. AUTRY**
 SVP, Publishing Director **ADOLPH AUERBACHER**
 SVP, Editorial Director **DORIS EBY**
 SVP, Operations **DEAN PIETERS**
 Group VPs: Publishing Directors **MYRNA BLYTH,**
BURTON H. BOERSMA, CHRISTOPHER M. LEHMAN
 Group VP, Circulation Director **CLEM SEVDE**
 Controller **MAX RUNCIMAN**

Corporate Officers

Chairman of Executive Committee **E.T. MEREDITH III**
 Chairman of the Board **ROBERT A. BURNETT**
 President and Chief Executive Officer **JACK D. REHM**
 Group Presidents: Broadcasting **PHILIP A. JONES;**
 Magazine **JAMES A. AUTRY;** Real Estate **ALLEN SABBAG**

Better Homes and Gardens® **WOOD**® — the #1 magazine for home woodworkers (ISSN-0743-894X) is published nine times a year in January, February, April, June, August, September, October, November, and December by Meredith Corporation, 1716 Locust St., Des Moines, IA 50336. Second-class postage paid at Des Moines, Iowa. Better Homes and Gardens trademark registered in Canada and Australia. Marca Registrada en México. **ONE-YEAR SUBSCRIPTION PRICES:** U. S. and its possessions, \$24.97; Canada, \$34; other countries, \$38. **POSTMASTER:** Send address changes to **WOOD**, 1716 Locust St., Des Moines, IA 50336. ©COPYRIGHT MEREDITH CORPORATION 1991. ALL RIGHTS RESERVED. PRINTED IN U.S.A. Canadian GST Reg. #R123482887.

WE CARE!

NPA

EDITORIAL MAILING ADDRESS: **WOOD** magazine, P.O. Box 11454, Des Moines, IA 50336-1454.
SUBSCRIPTION SERVICE (including change of address): **WOOD** Customer Service, P.O. Box 10628, Des Moines, IA 50336-0628. Please enclose your address label from current issue. If you wish, call toll-free 800/374-9663.
CUSTOMER-SERVICE TEAM: Supervisor, Chris Warwick, Marjane Cline, Velma Williams.

GUARANTEED* PROBLEM SOLVING PRODUCTS FOR TABLE SAWS



The DUBBY™ Cutoff Fixture \$127.45 ppd.

THE WORLD'S MOST ACCURATE CUTOFF ACCESSORY FOR TABLE SAWS — **GUARANTEED!!**

WOOD Magazine Apr. 88
 A "MITER FINE" Cutoff Fixture
 "We've never seen a more accurate miter fixture than this one."
 "We fitted the **DUBBY** to an old Sears table saw with a reputation for inaccurate crosscuts and miters. The fixture enabled the saw to make exact cuts every time, even in wide boards."
 "We'd recommend the **DUBBY** to anyone who is interested in doing careful, precision work."

Contractor Saw Performance Pkg. \$39.95 ppd.

- Reduce vibration up to 80%
- Increase power to the saw blade
- Includes 8 pg. article on solving vibration problems

WOOD Magazine
 "I noticed an immediate increase in power."
 "An inexpensive and effective upgrade."
 "Improved our Dados 20 percent."
 Pulleys and belt may be purchased separately. Band saw packages also available. Call with pulley inside diameter and outside diameter for prices.



"We reduced the vibration in our table saw by replacing its cast iron pulleys (left) with turned pulleys (right) and adding a link belt."

Paralok™ Fence System

- Cable tracking accuracy within .002"
- Front and rear vertical clamping
- Up to 750 lbs. clamping pressure
- One hand operation

WOOD Magazine
 "Smoother gliding and incredibly precise."
Prices starting at \$289.95 plus shipping

* All products have a 30 day money back guarantee

Zero Clearance Inserts

3 Pack \$22.45 ppd.

- Minimize tearout, acts as a chip breaker
- Top leveling adjustment

WOOD Magazine Oct. 91
 "Improved our results by at least 40 percent."
 "Helps the blade cleanly shear the wood fibers."
 Fits 10" Delta Contractor & Unisaw, Grizzly, Powermatic Artisan & Most Other Saws with 1/2" thick inserts. (Not available for Sears Craftsman)

IN-LINE INDUSTRIES
 661 S. Main St., Webster, MA 01570

ORDERS: USA 1-800-533-6709
 MA 508-949-2968

MLCS Ltd.

CARBIDE TIPPED ROUTER BITS

PROFESSIONAL PRODUCTION QUALITY SPECIAL OFFER — 50% to 75% BELOW COST!

- 1/4" Diameter Shanks x 1-1/4" Long • Two Flute Thick High Quality Tungsten Carbide Tips • 1/2" Ball Bearing Pilot
- One Piece Construction (Not assemblies) • Professional Size • Piloted Bits are Supplied Complete with 1/2" Ball Bearings

<p>COVE</p> <p>#340 1/8" \$12.00 #341 1/4" \$13.00 #342 3/8" \$14.00 #343 1/2" \$15.00</p>	<p>ROUND OVER</p> <p>#350 1/8" \$11.00 #351 3/16" \$11.00 #230 1/4" \$12.00 #353 5/16" \$14.00 #354 3/8" \$15.50 #355 1/2" \$17.00</p>	<p>ROMAN OGEE</p> <p>#231 5/32" \$17.00 #232 1/4" \$18.00</p> <p>CLASSICAL</p> <p>#490 1-1/4" \$22.50 #491 1-1/2" \$25.00</p>
<p>SLOT CUTTER</p> <p>#366 1/8" \$14.00 #368 1/4" \$14.00</p> <p>RABBETING</p> <p>#370 3/8" \$14.00</p>	<p>DOVETAIL</p> <p>#403 3/8" 9" \$ 7.50 #405 1/2" 14" \$ 8.50 #409 3/4" 14" \$10.50 (For Leigh Jigs) #402 3/8" 8" \$12.00 #404 1/2" 8" \$12.00</p>	<p>STRAIGHT</p> <p>#470 1/4" \$ 7.00 #471 5/16" \$ 7.00 #472 3/8" \$ 7.00 #473 7/16" \$ 7.00 #474 1/2" \$ 7.00 #476 9/16" \$ 7.00 #478 5/8" \$ 8.00 #479 3/4" \$10.00</p>
<p>BULL NOSE</p> <p>#460 1/4" \$14.00 #461 3/8" \$15.00 #462 1/2" \$16.00 #464 3/4" \$21.00</p> <p>45° CHAMFER</p> <p>#375 1-1/2" \$15.00</p>	<p>CORE BOX (ROUND NOSE)</p> <p>#415 1/4" \$10.00 #416 3/8" \$11.00 #417 1/2" \$14.00 #418 3/4" \$15.00</p>	<p>TONGUE & GROOVE</p> <p>#545 Straight \$29.00 #546 Wedge \$29.00 (not shown)</p>
<p>RAISED PANEL</p> <p>#385 25° \$25.00 #387 Cove \$25.00 (not shown) #390 Ogee \$28.00 (not shown)</p>	<p>BEADING</p> <p>#450 1/8" \$11.00 #451 3/16" \$11.00 #233 1/4" \$13.00 #453 5/16" \$14.00 #454 3/8" \$15.50 #455 1/2" \$17.00</p>	<p>FLUSH TRIM</p> <p>#500 3/8" \$ 7.00 #502 1/2" \$ 7.50</p> <p>EDGE BEADING</p> <p>#530 3/16" \$15.00 #531 5/16" \$15.50</p>

When ordering any 3 or more, deduct \$1.00 each. All prices postage paid. PA residents add 6% for state sales tax.

FREE CATALOG

To order by MasterCard or Visa — Toll Free 7 Day
 24 Hour Order Service Call 1-800-533-9298 or send check to
MLCS Ltd., P.O. Box 4053D K, Rydal, PA 19046

Index

 [Print this article](#)

- Abrasives, 46-47
 - belts, 61, 62
 - discs, 66, 73, 78
- See also Sanders
- Acrylic finish, 45, 48
- Adhesives, 77
 - colored, 81
 - contact cement, 91
 - epoxy, 84, 88
 - hide glue, 83
 - instant, 76
- Air compressors, 35, 40
- Air nailer, 55
- Air stapler, 54
- Anchors, drywall, 76
- Angle drills, 52, 57
- Angle grinders, accessories for, 62, 65, 70
- Anglesetter/protractor, 30
- Antikickback hold-down system, 61
- Antiquing gel, 47
- Antistatic abrasives, 61
- Bags, trash, 85
- Bandsaw, 41
- Bar clamps, 30-31
- Base, mobile, for
 - stationary tools, 75
- Baskets, storage, 88
- Bearing enlarger kits, 60
- Belt/disc sander, 34
- Belts, sanding
 - antistatic, 61
 - Split-grit, 62
- Belt sander, portable, 56
- Benches. See Workbenches
- Bench plane, 19
- Bench screws, 87
- Biscuit (plate) joiners, 50, 68
 - products for, 72, 90
 - routers as, 71, 74
- Bits, 70, 74-75
 - countersinks, 68
 - in dispenser, 68
 - drywall, for screwdriver, 60
 - Forstner, 64
 - holesaws, 66
 - mandrel for, 71
 - router. See Router bits
- Brad nailer, 52
- Branding irons, 23
- Brass hardware, 79
- Brush cleaner, 44
- Bushings, drill, 75
- Cabinet organizers, 88
- Cabinetmaking system, 89
- Carving tools, 25
- Chainsaw, 50-51
- Chisels, 28-29
 - corner chisel, 19
 - sharpening device for, 28
- Circle cutter, 26
- Circular saw blades, 66, 74
- Circular saws, portable, 56
 - attachment, 65
 - table, 70
- Clamps
 - bar, 30-31
 - corner, 26-27
 - and framing system, 23
 - for large workpieces, 27
 - miter, 25
 - pipe, saddles for, 20
 - vertical glue press, 28
- Clocks
 - kits, 84, 90
 - pattern, 81
- Combination square, 26
- Compressors, 35, 40
- Contact cement, 91
- Corner cam-clamps, 26-27
- Corner chisel, 19
- Corner sander, 70
- Countersinks, 68
- Crackled finishes, 43, 49
- Crosscut saw tables
 - for portable circular saws, 70
 - sliding, for tablesaws, 62, 64, 73
- Danish finish, 42-43
- Deck boards
 - bowed, tool for, 30
 - cutting, blade for, 66
 - spacer for, 21
- Deck cleaner, 43
- Disc/belt sander, 34
- Discs, sanding, 66, 78
- woodturner's, 73

Continued on page 6

Quality Woodworking Machines at Affordable prices from Penn State Industries

Dept. W, 2850 Comly Road • Phila, Pa. 19154

Order Toll Free 1-800-288-7297 • Info: 215-676-7609

Visa, Master, & Discover Cards accepted • Pa residents add 6% Sales Tax

When ordering - Add UPS Shipping Charges as noted

Call or Write for our New 24 Page Color Catalog



5 Speed Drill Presses

- Motor: 1/2 HP TEFC
- 13-3/4" Swing
- 5/8" JT3 Chuck
- 11" x 11" Sq Table
- Work Light included
- Table tilt 90°
- Table swivel 360°
- Rack table elevator

Table Top Model:

#DPT ... \$179.95 (UPS \$25)

Floor Model:

#DPF ... \$219.95 (UPS \$30)

Two Way Sanders

Features of both models:

- Dust collector on belt
- Tables tilt to 45°
- Sealed ball bearings
- Easy belt tracking

6x9 Sander:

- Includes stand
- 9" Disc • 6"x48" Belt
- 3/4 HP, 1720 RPM
- Free Belts & Discs worth \$21.00

#S69 ... \$219.95 (UPS \$30)

4x8 Sander: ON SALE

- 8" Disc • 4"x36" Belt
- 1/3 HP, 1720 RPM
- Free Belts & Discs worth \$14.00

#S48 ... \$109.95 (UPS \$8)

Super 125 Planer

only \$359.95

This machine will pay for itself time and again by planing your own wood. Finishes wood like machines many times its price.

- Portable at 65 lbs
- 26.2 fpm power feed
- HSS Knives 12-1/2" wide
- Motor: 16Amp, 8000RPM 2HP, 115V
- 1/8" Max depth of cut

#PLA ... \$359.95 (UPS \$15)

Extra Knives ... \$25/pair

Dust Chute ... \$15/ea (UPS \$3)

Stand \$39/ea. (UPS \$6)

Variable Speed Scroll Saw

ON SALE \$169.95

Cuts intricate patterns in many different materials. Electronically controlled motor gives full power at all speeds 400-1800cpm.

FREE ACCESSORIES:

- Dust blower • 1 dz blades
- EZ Set permanent top arm blade holders • EZ jig to attach standard holders • 4 blade holders • Neptune 1-1/2" lettering guides w/6 patterns

Specifications:

- Motor: 1.3 Amp, 110V
- Throat: 15" deep • Stroke-3/4"
- Tilt 0-45° left • Cut Depth: 2"
- Blades: uses pin & plain end

#SVS \$169.95 (UPS \$10)

Dust Collectors

610 CFM Dust Collector:

This collector is perfect for hookups to almost any single machine.

- 1HP, 110/220V • 1 outlet @ 4" • 2 Bags @ 20 gal • Wt: 75lbs • 610 CFM
- Free: 8' of hose, 1ea 4" to 3" & 4" to 2" adaptors.. \$15 Value

#DC1 \$199.95 (UPS \$20)

900 CFM Dust Collector:

This 1-1/2HP model allows for use in 2 or more machines & gives improved service for long runs of hose.

- 1-1/2HP, 110/220V • 2 outlet s @ 4" • 2 Bags @ 30 gal • Wt: 120lbs • 900CFM
- Free: 50' of hose, 1ea 4" to 3" • 2 ea 4" to 2" adaptors.. \$40Value

#DC2 \$299.95 (UPS \$30)



Round and round it goes. Where it stops nobody knows.

The Dremel Moto-Tool is a compact, high-speed rotary tool that really gets around. With variable speeds, ranging from 5,000 to 30,000 RPMs, and over 150 specially designed bits and accessories, it allows you to complete all kinds of tasks, on all kinds of materials.

With the right bit and the right speed you can sand, carve, shape and rout wood. Change the bit, adjust the speed and use the Moto-Tool to grind, cut and deburr metal. You can even use it to shape and cut plastic or polish silver.

If we were to list all the ways you could use the Dremel

Moto-Tool, this ad would go on forever. However, you can get a 95 page, detailed guide that explains bits, speeds and 175+ uses, in specially marked Moto-Tool boxes at Hardware, Home Center and Hobby Stores. Or write to Dremel, Marketing Dept., P.O. Box 1468, Racine, WI 53406-9989, for a free copy.

DREMEL® MOTO-TOOL®
High-Speed Rotary Tool

Buy Direct From The Manufacturer And **SAVE!**

Buy 12 "EVER-LAST" Belts... Get 12 Belts FREE!

Need ROLLS, WIDE BELTS, DISCS,
SLEEVES, STROKE BELTS, etc.
Write for catalog.



Belts available in 36, 50, 60, 80, 100,
120, 150, 180, 220, 320 grit sizes.
Please specify grit sizes when ordering,
otherwise an assortment will be supplied.

- 1" x 30" ... \$16.50/Doz. + 12 FREE
 - 1" x 42" ... \$16.95/Doz. + 12 FREE
 - 2" x 48" ... \$25.25/Doz. + 12 FREE
 - 2½" x 16" ... \$17.95/Doz. + 12 FREE
 - 3" x 18" ... \$18.25/Doz. + 12 FREE
 - 3" x 21" ... \$19.25/Doz. + 12 FREE
 - 3" x 24" ... \$19.75/Doz. + 12 FREE
 - 4" x 21" ... \$23.50/Doz. + 12 FREE
 - 4" x 21¾" ... \$23.75/Doz. + 12 FREE
 - 4" x 24" ... \$24.00/Doz. + 12 FREE
 - 4" x 36" ... \$28.75/Doz. + 12 FREE
 - 6" x 48" ... \$37.50/½ Doz. + 6 FREE
- Other size belts on request.**
 Belt Cleaning Stick \$4.95 each

For Fast Delivery Call Toll Free
1-800-428-2222 (U.S.A.)
1-800-222-2292 (PA only)

**INDUSTRIAL
BRASIVES CO.**
643 N. 8th ST. • READING, PA 19612

9" x 11" PAPER SHEETS

A/O or Garnet Cabinet Paper	
50 PACK	100 PACK
40-D ... <input type="checkbox"/> \$17.00	<input type="checkbox"/> \$32.00
50-D ... <input type="checkbox"/> \$16.00	<input type="checkbox"/> \$29.00
60-D ... <input type="checkbox"/> \$15.00	<input type="checkbox"/> \$27.00
80-D ... <input type="checkbox"/> \$14.00	<input type="checkbox"/> \$25.00
100-C ... <input type="checkbox"/> \$13.00	<input type="checkbox"/> \$23.00
120-C ... <input type="checkbox"/> \$13.00	<input type="checkbox"/> \$23.00
150-C ... <input type="checkbox"/> \$13.00	<input type="checkbox"/> \$23.00

No Load Finishing Paper (White)

120-C ... <input type="checkbox"/> \$14.00	<input type="checkbox"/> \$24.00
150-C ... <input type="checkbox"/> \$14.00	<input type="checkbox"/> \$24.00
180-A ... <input type="checkbox"/> \$11.00	<input type="checkbox"/> \$19.00
220-A ... <input type="checkbox"/> \$11.00	<input type="checkbox"/> \$19.00
280-A ... <input type="checkbox"/> \$11.00	<input type="checkbox"/> \$19.00
320-A ... <input type="checkbox"/> \$11.00	<input type="checkbox"/> \$19.00
400-A ... <input type="checkbox"/> \$11.00	<input type="checkbox"/> \$19.00

SHIPPING CHARGES: \$4.75 Continental U.S.

MONEY ORDER CHECK
 MASTER CARD VISA

Index

Continued from page 4

- Door lock installation kit, 73
- Doors, pocket, slides for, 86
- Doweling fixture, 66-67
- Drill bits. See Bits
- Drill bushings, 75
- Drill-grinding attachment, 30
- Drill guide, 21
- Drill presses, 34
- Drills, electric, 57
 - angle drills, 52, 57
 - bits for. See Bits
 - driver/drill, 54
 - hammerdrill, 56-57
 - woodturner's sanding set for, 73
- Driver/drill, 54
- Drum sanders, 37
 - spindle, oscillating, 41
- Drywall anchors, 76
- Drywall screwdriver bits, 60
- Dust collectors, 37, 52-53
- Dust helmet, 89
- Dust mask, 79
- Electrical outlets
 - protective devices for, 83, 88
- Enamels, 44, 48-49
- Epoxy, 88
 - gel, five-minute, 64
- Eyewear, safety, 76-77, 82
- Fence-setting gauge, 64
- Finishing products, 42-49
- Fireplace mantel kits, 85
- Flooring, 91
- Fluorescent lights, 78, 83, 86-87
- Forstner bits, 64
- Frame-clamping system, 23
- Frame restoration kit, 85
- Friction-reducing materials, 67, 69
- Furniture parts, reproducing, 83
- Furniture stripping system, 48
- Glue. See Adhesives
- Glue applicator for
 - biscuit joiners, 72
- Glue press, vertical, 28
- Graining tool, 31
- Grandfather clock, kit for, 84
- Grinders, angle, accessories for, 62, 65, 70
- Ground-fault circuit interrupter (GFCI), outlets with, 83
- Hacksaw blades, 65
- Hammerdrill, 56-57
- Hammers, 18, 25, 27
- Hand protector, wash-off, 45
- Handsaws, 18-19, 21, 25, 30-31
- Hand tools, 18-31
- Hardware
 - antique-look, 83
 - brass, 79
 - plate-joiner hinge, 90
- Hide glue, 83
- Holesaws, 66
 - mandrel for, 71
- Joiners, biscuit (plate), 50, 68
 - products for, 72, 90
 - routers as, 71, 74
- Jointer/planer, 41
- Joint tightener, 78
- Kitchen cabinetmaking system, 89
- Kitchen storage, 88-89
- Knives, hobby, 27
- Lacquer pen, 45
- Lathes, 37, 39
- Levels, case for, 23
- Lights, 78, 83, 86-87, 89, 91
- Lock installation kit, 73
- Lumber dryer, 81
- Mallets, 22
- Mandrel, 71
- Mantel kits, 85
- Mat, antifatigue, 90
- Measuring and marking tools, 19, 22, 26, 29, 30
- Mirrors, 79
- Miter bits, 64
- Miter clamps, 25
- Miter gauge, 74
- Mitersaws
 - power, 38-39
 - small-scale, 21
- Moisture meter, 80
- Molder/planer, 38
- Molding head, for shapers, 68
- Molding-plane profile set, 72
- Moldings, 77, 78
 - scrapers for, 18, 24
- Multipurpose machines, 39, 40
- Nailers, power, 52, 55
- Organizers. See Storage
- Oscillating spindle sander, 41
- Outlets, electrical, 91
 - protective devices for, 83, 88

Continued on page 9

WOODWORKER'S CATALOG

Over 4000 products to

**BUILD,
REPAIR,
RESTORE,
REFINISH**

anything made of wood!

116 pages, jam-packed with fine woods, veneers, inlay borders, finishing supplies, hardware, glue plus hand and power tools, how-to books, plans and much, much more. All first quality, all easy to order by phone or mail, and all covered by our 60-day no-questions-asked guarantee.



YES! Rush my 116 page, full color Woodworker's Catalog. I enclose \$1.00 shipping and handling.

Name _____

Address _____

City/State/Zip _____

Mail to:

CONSTANTINE'S, 2054N Eastchester Rd., Bronx, NY 10461



Serving Woodworker's
for 180 Years

A NEW WAY TO CARRY ON A FINISHING TRADITION.

The Wagner FineCoat is unlike any finishing method you've ever seen before. But it can put a classic, professional finish on the wood-working projects you're doing now, right in your own workshop.

FineCoat's secret is Wagner's High-Volume, Low-Pressure (HVLP) technology. It allows you to spray, with



very little bounceback or over-spray. You don't need a spray booth, just an open mind and a few minutes to read about FineCoat's advantages.

to a vertical, horizontal, or circular pattern, without changing nozzles.

While your coats are drying, the spray gun stands

1/4" To 12" Wide

securely in its own unit. And when the last coat is on, check your watch. You'll most likely be done finishing and cleaning-up, in less time than you used to spend on the finishing process alone.



To find out more about FineCoat, call 1-800-328-8251. We'll send you more information or refer you to a FineCoat dealer.

Spray any finish on the shelf.



The FineCoat can give you the type of finish you had in mind, from the start of the project.

It handles urethanes, oils, varnishes, shellacs, lacquers, stains, even enamel paints. Every FineCoat unit also comes with helpful hints for thinning and spraying different materials.

Your hand has never had this much control.

With FineCoat you can get close, without dripping, or cover large areas. The spray width adjusts from 1/4", to a foot wide. You can also adjust

FineCoat gives you a professional spray finish. Coverage is smooth and even over the most intricate pieces.

The FineCoat unit is portable, storable, and plugs into any 120V outlet.



Send for free literature or a helpful demonstration video.

Check the first box below and we'll send you more literature on HVLP spraying and the FineCoat sprayer. Or, check the second box and send \$3 to cover postage and handling. We'll send you the literature along with a videotape demonstrating the usage and applications of FineCoat.

- Send me more information, free.
- Send me information and the FineCoat video for \$3. (Enclose a check payable to Wagner Spray Tech, or we'll charge it to your MasterCard # _____, or your Visa # _____.)

NAME _____
 ADDRESS _____
 CITY _____
 STATE _____ ZIP _____
 Mail to: Wagner FineCoat, 1770 Fernbrook Ln., Plymouth, MN 55447

© 1991 Wagner Spray Tech Corp. FineCoat is a trademark of Wagner Spray Tech Corp.



Freud Factory Rebate.

1. Buy our Biscuit Joiner or Plunge Router between September 1, 1991 and January 31, 1992.

2. Mail rebate coupon.

3. Receive rebate check for \$30!

Easy as 1-2-3

Rebate
\$30!



Biscuit joining is rapidly becoming the preferred method of joining wood. With the Freud System you can create an exceptionally strong joint that is quicker and easier than doweling or other methods.

The Freud JS100 joiner system is designed for the woodworking professional who relies on his power tool. It has an industrial duty cast housing, a solidly built drive system and a powerful 5 amp motor that will provide many years of service. But the performance from any power tool depends on the quality of the blade or cutter. Freud is world renowned for carbide cutting tools and the blade for the JS100 is made using the same advanced technology in the same factories. With this system you get a carrying case, blade removal tools, sample bag of biscuits, complete instruction manual and our special lubricant. Combine all this and you will understand why this has been the tool preferred by many professionals, and leading authorities in the field.

Now is the best time to buy the Freud JS100 Joiner System. Go to your participating dealer and get your best price and we will send you a check for \$30.*

Rebate
\$30!



If you're looking for a power house of a router look no longer. This machine has both the power and features you have been looking for. It is rated for 3 1/4 developed horsepower at 15 amps. This is the most power you can get from a hand held power tool that will run on standard household current. The technically advanced collet system on the FT2000 is the longest collet available to secure bits even under heavy load. This machine is also packed with many other features like the reverse flow fan to keep the work surface clear and the ergonomically designed handles for maximum control and comfort. But the one feature that makes this the ideal machine is the Micro-Adjustment Knob. Router table operations are a dream because micro cutter height adjustments can be easily made.

This solid work horse has always been an excellent value but if you buy one now from a participating dealer we will send you a check for \$30* that you can spend on bits, wood or just put in the bank.

freud

Precisely what you need.

*Rebates available only on Freud JS100 and Freud FT2000 purchased from participating dealers between September 1, 1991 and January 31, 1992.

For the name of your participating dealer or full details on the rebate call 800-472-7307.

Index

Continued from page 6

- Paint, 44, 48-49
- Paintbrush cleaner, 44
- Paint removers, 44-45, 47
- Paint scrapers for moldings, 18, 24
- Pegboard, tool organizers for, 82
- Pen, detailing and striping, 45
- Pickling gel, 49
- Picture frame restoration kit, 85
- Pipe saddles, 20
- Pitch and gum remover, 88
- Planers, power, 35, 36, 38, 40
 - portable, 55
- Planes, hand, 19, 29
 - sharpening device for, 28
- Plate (biscuit) joiners, 50, 68
 - products for, 72, 90
 - routers as, 71, 74
- Plug cutters, 69
- Plunge routers, 56-57, 52
 - bits for, 65
 - crank handle for, 62
- Pocket doors, slides for, 86
- Polyurethane finishes, 42, 45
 - stain with, 49
- Portable power tools, 50-57
- Power tool accessories, 60-75
- Power tools
 - portable, 50-57
 - stationary, 34-41
- Profile gauge, 60
- Protractor, 30
- Radial-arm saw, 41
- Rail system, kitchen, 88-89
- Random-orbit sanders, 51, 53
 - angle grinder as, 65
- Rasps, 30
- Respirators, 44
 - dust helmet, 89
 - dust mask, 79
- Riffler rasps, 30
- Rollers
 - veneer, 20
 - for work supports, 64
- Rollertable, 60
- Rotary tools, 50-51
 - accessory for, 55
- Router bits, 65, 70
 - bearing enlarger kits for, 60
 - molding/plane profile set, 72
- Routers, 52, 56-57
 - biscuit joinery with, 71, 74
 - bits for. *See* Router bits
 - crank handle for, 62
 - mounting systems for, 64, 67, 70, 71
 - rotary tools as, 55
 - speed control for, 69
- Router/shaper, 40
- Safety wear, 76-77, 82
 - respirators, 44, 79, 89
- Sanders
 - belt, 56
 - belt/disc, 34
 - corner sander, 70
 - drum, 37
 - hand, 20
 - palm, 54
 - random-orbit, 51, 53, 65
 - spindle, oscillating, 41
 - straightline, 53
- Sanding belts, 61, 62
- Sanding discs, 66, 78
 - woodturner's, 73
- Sanding sealers, 42-43, 45
- Saw blades
 - circular, 66, 74
 - hacksaw, 21
- Sawmill, portable, 85

Continued on page 10

Now, Add Instant Earning Power To Your Shop!

Craftsmen everywhere are using the low-cost Woodmaster to **bring in welcome extra cash** and to **save** on all their lumber needs. You can, too!

With the new 18-in. Woodmaster or the standard 12-in. model, you can quickly convert low-cost rough lumber into valuable finished stock. You can turn out perfect picture frame moldings, crown, bed and base moldings, tongue & groove, door and window trim...all popular patterns...any custom design.

You can do custom work for friends, neighbors, lumberyards, picture framers, home remodelers, hobby shops and businesses.

Because it takes just seconds to convert a \$2 rough board into \$10 worth of finished trim, you can see why so many Woodmaster owners enjoy substantial extra incomes!

Variable Speed Makes The Difference!

Just a twist of the dial gives you perfect control for planing, sanding or sawing...from 0 to 1,000 cuts per inch. Creates mirror-smooth molding with no sanding required!

Here's what Woodmaster owner L.C. Griffin of Los Angeles writes: "The shop test article in *Wood Magazine* that said they loved your Variable Feed Rate is what sold me. They were right."

Call or write today for free facts on how you can try this **American-made** tool in your own shop for one full month. Easy terms.

CALL TOLL-FREE

1-800-821-6651 EXT. PWW2



30-Day Free Trial!



Woodmaster's Quick-Change Molding Head lets you create custom moldings from any stock. Choose from over 250 standard trim and picture frame patterns...or design your own!



Power-fed sanding speeds production and improves the quality of your work. No more waves or cross-grain scratches. Separate sanding head installs in just minutes.



New rip saw attachment lets you gang-rip with power feed in a fraction of the time it takes for multiple hand-fed passes on an ordinary table saw.



YES! Please rush me your **FREE** Information Kit plus details on your **30-DAY FREE TRIAL GUARANTEE!**

WOODMASTER TOOLS, INC., DEPT. PWW2
2908 OAK STREET • KANSAS CITY, MO 64108

Name _____
 Address _____
 City _____ State _____ Zip _____
 Telephone () _____

AmMax

FREE
 * Complete catalog sent upon order.
 * Plastic caliper (\$4.00 value) for any order.

TUNGSTEN CARBIDE TIPPED TOOLS

CALL TOLL FREE

1-800-782-6629 (NATIONWIDE)
 (619)535-8940 (CALIFORNIA)

TOOL CO.

Precision tools for skillful woodworkers

CUTTER	TOOL #	CUT DIA.	CUT L.	SNK D.	PRICE	
Straight	ST206	1/4	3/4	1/4	5.50	
	ST208	5/16	3/4	1/4	5.50	
	ST210	3/8	1	1/4	5.50	
	ST213	1/2	1	1/4	5.50	
	ST216	5/8	1	1/4	6.25	
	ST219	3/4	3/4	1/4	8.95	
	ST406	1/4	3/4	1/2	5.50	
	ST408	5/16	1	1/2	5.50	
	ST410	3/8	1	1/2	5.50	
	ST413	1/2	1	1/2	5.50	
Flush Trim	FT210P	3/8	1/2	1/4	6.00	
	FT210	3/8	1	1/4	6.50	
	FT213	1/2	1	1/4	6.95	
	FT213L	1/2	1-1/2	1/4	10.50	
	FT410	3/8	1-3/16	1/2	6.50	
	FT413	1/2	1-3/16	1/2	6.95	
	FT413L	1/2	1-1/2	1/2	10.50	
	Dovetail	DV210	3/8	3/8	3/4	4.95
		DV213	1/2	1/2	1/4	4.95
		DV410	3/8	3/8	1/2	4.95
DV413		1/2	1/2	1/2	4.95	
DV416		5/8	3/4	1/2	6.50	
DV419		3/4	1	1/2	6.95	
Core Box	CB206	1/4	1/4	1/4	8.00	
	CB210	3/8	1/4	1/4	9.00	
	CB213	1/2	5/16	1/4	11.00	
	CB216	5/8	3/8	1/4	12.50	
	CB219	3/4	1/2	1/4	14.00	
	CB413	1/2	5/16	3/2	11.00	
45° Chamfer	CH210	1	3/8	1/4	12.00	
	CH213	1-3/16	1/2	1/4	12.00	
	CH216	1-3/8	5/8	1/4	13.50	
	CH410	1-3/8	5/8	1/2	14.00	
	CH419	1-5/8	3/4	1/2	16.00	
	CH422	1-7/8	7/8	1/2	19.00	
Rabbit 2 FLUTES	RB232	1-1/4	1/2	1/4	12.00	
	RB432	1-1/4	1/2	1/2	12.00	
	SL203-2	1-1/4	3/8	1/4	10.00	
	SL205-2	1-1/4	3/16	1/4	11.00	
	SL206-2	1-1/4	1/4	1/4	11.00	
	SL210-2	1-1/4	3/8	1/4	12.00	

	TOOL #	RADIUS	CUT L.	SNK D.	PRICE	
Rounding Over	CR201	1/16	3/8	1/4	10.00	
	CR203	1/8	3/8	1/4	10.00	
	CR205	3/16	7/16	1/4	10.00	
	CR206	1/4	7/8	1/4	11.00	
	CR208	5/16	9/16	1/4	12.95	
	CR210	3/8	5/8	1/4	14.00	
	CR213	1/2	3/4	1/4	16.00	
	CR406	1/4	1/2	1/2	11.95	
	CR410	3/8	5/8	1/2	14.00	
	CR413	1/2	3/4	1/2	16.00	
Roman Ogee	RO204	5/32	1/2	1/4	15.00	
	RO206	1/4	3/4	1/4	16.00	
	RO404	5/32	1/2	1/2	15.00	
	RO406	1/4	3/4	1/2	16.00	
	Cove	CV203	1/8	3/8	1/4	11.00
		CV205	3/16	7/16	1/4	11.00
CV206		1/4	1/2	1/4	11.00	
CV208		5/16	1/2	1/4	12.00	
CV210		3/8	1/2	1/4	12.00	
CV213		1/2	5/8	1/4	13.00	
Classical	CS203	1/8	5/8	1/4	18.00	
	CS206	1/4	7/8	1/4	19.00	
	CS403	1/8	5/8	1/2	18.00	
	CS406	1/4	7/8	1/2	19.00	
	HALF ROUND	HR203	1/4 D	5/8	1/4	12.50
		HR205	3/8 D	11/16	1/4	13.50
HR206		1/2 D	3/4	1/4	14.50	
HR208		5/8 D	1	1/4	16.00	
HR210		3/4 D	1	1/4	16.00	
HR410		3/4 D	1-1/8	1/2	17.00	
HR413	1 D	1-3/8	1/2	18.00		
HR416	1-1/4 D	1-5/8	1/2	25.00		
HR419	1-1/2 D	1-7/8	1/2	30.00		



CARBIDE TIPPED HORIZONTAL PANEL RAISING \$49 EACH

* Industrial Quality Grade C3 Tungsten Carbide Tipped
 * 3 mm Thickness Carbide Offer Longer Life.



3/4" BORE C931 C984 C985 C986 C987
 1-1/4" BORE C1084 C1085 C1086 C1087

REDUCING BUSHING: \$2 / PAIR

NET 30 DAYS TO GOVERNMENT AGENCIES, SCHOOLS.

SAME DAY SHIPPING Count on us!

Shipping is FREE for orders over \$60 and is only \$2 for smaller orders.

HOURS: MON thru FRI 7 AM to 6 PM
 NEW: SAT 8 AM — 2 PM

SEND YOUR CHECK TO:

AMMAX TOOLS CO.
 P.O. BOX 520
 POWAY, CA 92074

Index

Continued from page 9

Top of the line Made In U.S.A.
Nicholson
 10" 60T \$39.99
 10" 36T \$18.10
 10" 40T \$26.89
 Retail values up to \$60
Carbide Tipped

NEW PRODUCTS
 2-piece Stile & Rail -- \$69 a set

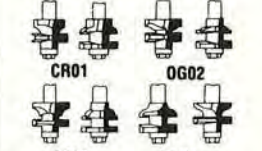

OGEE FILLET PANEL RAISING
 1/2" SHANK ONLY
 OF466 2-5/8" \$24.00
 OF476 3-1/4" \$39.00

STILE & RAIL Reversible
 RS248 1/4" shank \$37
 RS448 1/2" shank \$37

3 WINGS, 9 CUTTING EDGES
FINGER JOINTER
 FJ463 1/2" shank \$53

LOCK MITRE
 ML470 \$34 1/2" shank
 FOR 5/8" TO 1-1/8" STOCK

KEY HOLE
 KH210 1/4" shank \$6.50

TONGUE & GROOVE
 1/4" SHANK \$28
 FOR 5/8" TO 3/4" STOCK
 1/2" SHANK \$29
 FOR 5/8" TO 1" STOCK

3 WINGS SHAPER CUTTERS
 3/4" BORE
 C940 \$140
 CONCAVE STILE & RAIL SET \$140

OGEE STILE & RAIL SET
 C994 \$140

CONVEX STILE & RAIL SET
 C945 \$140

REVERSIBLE STILE & RAIL
 C965 \$45

LOCK MITRE
 C998 \$42

FINGER JOINT
 C961 \$69

GLUE JOINT
 C911 \$32

Saws
 bandsaw, 41
 chainsaw, 50-51
 circular, portable, 56
 attachment, 65
 table, 70
 handsaws, 21
 18-19, 21, 25, 30-31
 holesaws, 66
 mandrel for, 71
 miter, 21, 38-39
 radial-arm, 41
 scrollsaws, 34-35, 36
 project, 81
 upgrade kit, 65
 See also Tablesaws
 Scrapers for moldings, 18, 24
 Screwdrivers, 31
 electric, 51, 53
 driver/drill, 54
 drywall bits for, 60
 holster for, 71
 Screws, 84
 bench screws, 87
 Scrollsaws, 34-35, 36
 project, 81
 upgrade kit, 65
 Shaper cutters, 63
 Shaper/router, 40
 Shaper/router table
 for rotary tool, 55
 Sharpening tools, 24, 28
 power, 39
 Shellac, 44
 Shelving, 79, 86
 Shoulder vise screw, 87
 Sign-making machine,
 62-63
 Spindle sander, oscillating,
 41
 Sprayers for finishes,
 42, 47
 Spray paint, 44, 48-49
 Square, combination, 26
 Stains, wood, 44-45, 46
 47, 48, 49
 Stands
 for stationary tools, 75
 for workpieces, 63
 Stapler, air, 54
 Stationary power tools,
 34-41
 Stone finish, 46
 Stones, sharpening, 24, 28
 power, 39
 Storage, 80
 kitchen, 88-89
 shelving, 79, 86
 for tools, 82, 87
 Stripping system, furniture,
 48
 Table legs, 86-87
 Tables
 crosscut,
 62, 64, 70, 73
 router, 64, 67, 70, 71
 work support, 60
 Tablesaws, 36-37, 38
 antikickback system for,
 61
 crosscut tables for,
 62, 64, 73
 as disc sander, 66
 fence-adjusting gauge for,
 64
 miter gauge for, 74
 Tape measures, 22, 26
 Toggle bolt, 76
 Toolboxes, 87
 Tool organizers, 82
 Tools
 hand, 18-29
 power
 accessories for, 60-75
 portable, 50-57
 stationary, 34-41
 Trash bags, 85
 Urethane wood finish, 43
 Vacuum, shop, 52-53
 Varnish, polyurethane, 42
 Varnish and paint remover,
 44-45
 Veneer, 82
 Veneer roller, 20
 Vise and workbench, 76
 Wainscot kit, 81
 Wall clock, kit for, 90
 Water alarm, 91
 Water-based finishes,
 42-43, 44, 45, 46,
 47, 48, 49
 Weather-stripping system,
 69
 Whetstones, 24, 28
 Woodcarving tools, 25
 Wood dryer, 81
 Wood filler, 80
 Wood-graining tool, 31
 Wood screws, 84
 Woodturning tools, 73, 75
 Workbenches
 European, 77
 screws for, 87
 and vise, 76
 Work supports, 60, 63
 rollers for, 64



We made this cut on a table saw, only we didn't move the wood.

We used the new SAWSMITH 2000 table saw. Which is not exactly a table saw.

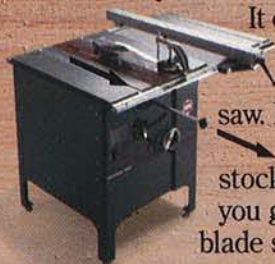

It cuts by pulling the blade through the wood like a radial arm saw. But it's not exactly a radial arm saw. Because it cuts from beneath like a table saw, it doesn't climb the stock like a radial arm saw can. So you get accurate cuts. And with the blade secured you can perform other

table saw operations like ripping.

The point is, you used to have to buy both a radial arm and a table saw to do everything. Now you can save shop space. And save some money over buying two machines. The SAWSMITH 2000. The table saw that works like a radial arm saw. Or vice versa.

For more information about the SAWSMITH 2000 and the location of a store near you, call **800-543-7586** ext. 10.



Shopsmith Inc.

Router Accessories from WOODCRAFT®

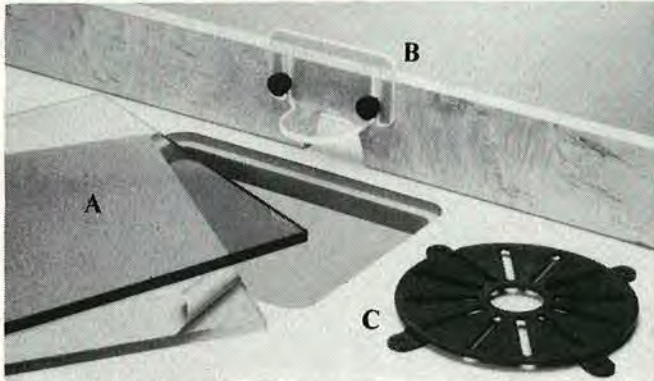

- A. See-Through Bases** of $\frac{3}{8}$ " thick Acrylic or Polycarbonate make superior router bases. Approximately 12" x 12".
16L71 Acrylic \$9.95 **16L72 Polycarbonate \$14.95**
- B. Safety Guide** for router tables. Neon plastic. Includes hardware. Mounts to any wooden fence.
09I29 \$10.95
- C. Universal Router Mounting Plate.** Build your own router table, jigs, or fixtures. $6\frac{1}{2}$ " steel plate substitutes for standard base, screws to setup of your choice.
11S41 \$11.95



- D. Porter Cable® Template Guide Bushing Kit** includes 7 standard bushings and 2 lock nuts for cutting duplicate patterns, dovetails, or template work. Fits Porter Cable Routers.
04F52 \$39.95
- E. 3-Wing Slotting Cutters** are superior to straight router bits for slotting the edges of boards. Carbide tips. Router base is supported by workpiece surface and cutter's ball bearing runs against the wood edge. Quickly, cleanly cuts $\frac{1}{2}$ " deep slots. $\frac{1}{4}$ " shank arbors.
24FW1 $\frac{5}{32}$ " \$22.95 **24FW2 $\frac{1}{4}$ " \$21.50**



WOODCRAFT®

210 Wood County Industrial Park
 Dept. 91W111H
 P. O. Box 1686
 Parkersburg, WV 26101-1686

To Order, Call Toll-Free 1-800-225-1153!
 90-Day Full Guarantee! Major Credit Cards Accepted.
 FREE Catalog with Orders! Shipping Charges Extra.

For a FREE Catalog,
 Call Toll-free 1-800-542-9115!
 Dept. 91W111H

We've helped hold it together... Since 1903

"Jorgensen"
"Pony"
Adjustable™

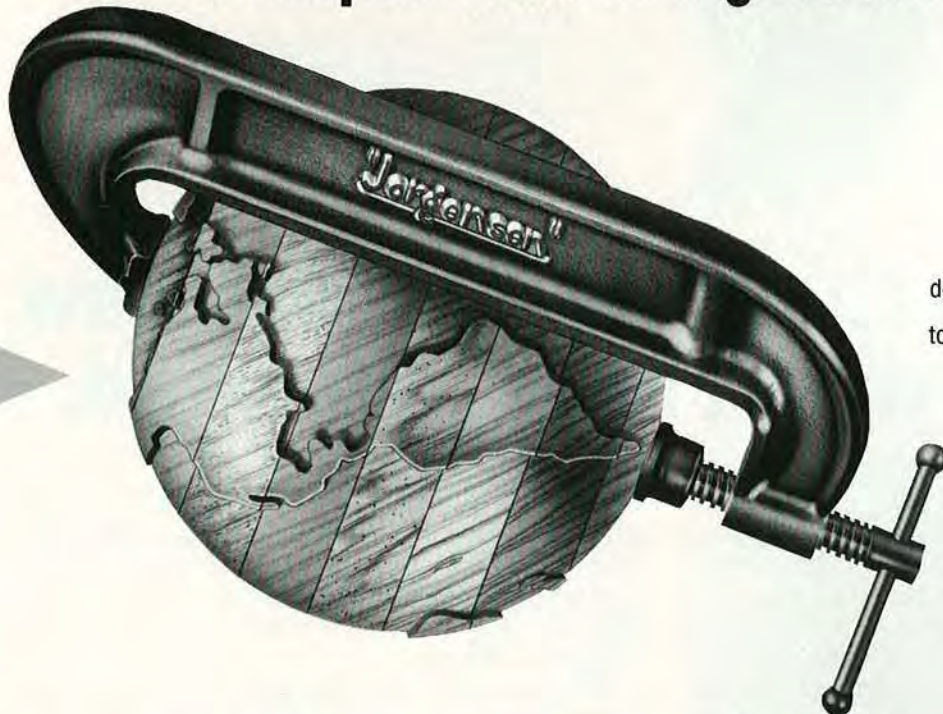

Quality in our products...
 dedication in our service. We've held
 to these commitments just as you've
 held up our Clamps and Vises as
 your standards to each new
 generation since 1903. We'll
 continue to hold consistently
 to our traditions of excellence.

Write for our Catalog SEND \$1.00
 Adjustable Clamp Company
 410 N. Ashland Avenue, Chicago, IL 60622



FORREST

The World's Finest Dado Head Clean Cuts All Your Grooves!

Of 29 dado sets tested

"Only the Forrest Dado-King earned 'Superior' ratings in every category."

Better Homes and Gardens Wood, Oct., 1991, p.60

"No tearout on all five woods tested"

(including melamines and oak/birch plys)*

BEST OF 32 SETS TESTED!

"Forrest Manufacturing Co. makes the only dado set with a negative hook on all its teeth, including chippers. This effectively makes the teeth cut 'up' into the wood, even when used on a tablesaw. It was the only set that cut the oak-veneered plywood without tearout and it also gave a perfectly flat bottom with a discreet little scribe."*
Jim Puterbaugh

*See Fine Woodworking, July/August, 1991, p. 59

• **NO SPLINTERING** —
cross-cutting oak,
ply veneers and melamine.

• **PERFECT
FLAT-BOTTOM
GROOVES** —

not staggered steps or
round bottoms like a
wobble-dado leaves!

• **CUTS IN ALL
DIRECTIONS** —

rip, cross-cut, miter,
any depth.

• **CUTS
ALL SIZED
GROOVES** —

1/8" thru 1 3/16" in 1/16"
increments. (Set of
.005" plastic adjusting
shims included).

• **SUPER-HARD
CARBIDE** —

gives up to 300% longer
life, especially good on
ply woods and abrasive
particle-boards.



TRIABLE & RETURNABLE
for full cash refund if
not completely satisfied.

**Here is why this
great Dado Head
has no equal!**

C-4 Carbide Tips — 24 on
each saw blade — twice as
many as most competitors.



C-4 Carbide Tips —
4 on each chipper, with
special face hooks.

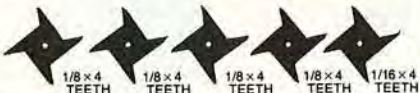

SPECIAL SALE! 8"-5/8" Bore List \$299/SALE \$254
15% OFF! 10"-5/8" Bore List \$362/SALE \$308

Dealer Inquiries Welcome.

BUSINESS OPEN ACCOUNTS
AVAILABLE

FORREST

FORREST MANUFACTURING COMPANY, INC.
461 River Road, Clifton, N.J. 07014

PHONE TOLL FREE!
1-800-733-7111

(In NJ: 201-473-5236) FAX: 201-471-3333



We honor Amex, Visa & Master
Card, Money Orders, Personal
Checks and COD's. **TO ORDER**
BY MAIL clip ad, circle choices
and enclose payment. Specify
Dept. FW when ordering.

STEVE WALL LUMBER CO.

Quality Hardwoods and Woodworking Machinery For
The Craftsmen and Educational Institutions

Ash	4/4	Select	1.90
Basswood	4/4	Select	1.30
Birch	4/4	Select	1.80
Butternut	4/4	Log Run	1.40
Cherry	4/4	Select	2.25
Cypress	4/4	Select	1.60
Hickory	4/4	Select	1.50
Mahogany (Genuine)	4/4	Select	2.70
Maple (Hard)	4/4	Select	1.55
Maple (Soft)	4/4	Select	1.30
Pecan	4/4	Select	1.50
Poplar	4/4	Select	1.20
White OR Red Oak	4/4	Select	1.80
Walnut	4/4	Select	2.50
Cedar (Aromatic Red)	4/4	1C+Btr.	1.35
White Pine	4/4	F.G.	.85
Yellow Pine	4/4	Clear	1.20

**UPS
Special**

	\$59.00
	\$47.00
	\$53.00
	\$55.00
	\$66.00
	\$49.00
	\$47.00
	\$73.00
	\$52.00
	\$46.00
	\$47.00
	\$45.00
	\$57.00
	\$71.00
	\$46.00
	\$37.00
	\$45.00

Above prices are for 100' quantities of kilndried rough
lumber sold by the Bd. Ft. FOB Mayodan, NC.
Call for quantity discounts. Other sizes and grades
available.

Above prices are 20 bd. ft. bundles of
clear kilndried lumber 3"-10" wide x 3'-
7' long (Random widths & lengths)
Surfaced 2 sides or rough. Delivered
UPS prepaid in the Continental U.S.

LUMBER SPECIALS

CHERRY 100 Bd. Ft. Bundle Log Run S2S 13/16 \$ 90*
WALNUT 100 Bd. Ft. Bundle #1 Common 4/4 \$ 110*
*FOB Mayodan - Motor Freight Only

Call For
Best Prices On *MiniMax*

STEVE H. WALL LUMBER CO.

BOX 287 • MAYODAN, N.C. 27027

919-427-0637 • 1-800-633-4062 • FAX 919-427-7588

Send \$1.00 For Lumber and Machinery Catalog

rbi, THE AMERICAN TOOLMAKER

For over 60 years we've been building tools with 3
things in mind, **QUALITY, VALUE, and**
RELIABILITY. We understand the importance that
you place in these factors when making your tool
selections, and you should!

We Proudly Present our 1992 Woodworking Line:

- The rbi Hawk Precision Scroll Saw
- The rbi Woodplaner/Molder/Sander/Gang Saw
- The rbi Router Mates
- The rbi Panel Master
- Industrial Roller Stands
- Custom Molding Knives/Cutters
- Plus Much More . . .

Ask for our NEW All Product Color Catalog
1-800-4USA-MADE

or write: **RBI Industries, The American Toolmaker**

1801 Vine St., P.O. Box 369

Harrisonville, MO 64701

800-487-2623

Dept. A88





ROUTER BITS

1-800-235-0272

Call today for your FREE Catalog!



- Thicker industrial grade carbide!
- Razor sharp edges ground up to 600 grit fineness!
- Largest selection of profiles available!

ROBLAND

The Intelligent One-Man Shop

The Robland X31 features heavy duty cast iron worksurfaces with 3 individual motors of three h.p. each. Full plywood capacity on the 10" table saw, which is equipped with a sliding table that has 50" cutting capacity. The shaper has a cast iron fence system with individually micro adjustable in and outfeed fences, the spindle sizes are 3/4" and 1 1/4". The jointer is 55" long and it features a three knife cutter head, to operate the 12" thickness planer you simply fold the jointer tables out of your way. This process only takes 5 seconds. The thickness planer will accept wood 9" thick. The chuck for the mortiser will self center any bit from 0" to 5/8", the X, Y, Z table is adjustable on all three axes and it will make extremely accurate quality joinery for you in seconds. No function change takes more than 30 seconds.

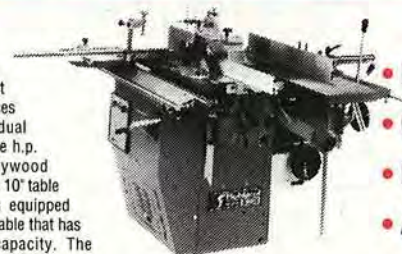

- Heavy Duty
- Cast Iron
- Powerful
- Accurate

CALL TODAY FOR INFORMATION ON A FREE 40 MINUTE VIDEO

LAGUNA TOOLS

2081 Laguna Canyon Road
Laguna Beach, California 92651
1-(800) 234-1976



STOCKING KEEPERS

Hang your Christmas stockings without nails! You get FULL SIZE patterns for all 4 projects shown. Easy to make from 1/2 inch plywood. They fit mantels which extend 6 inches or more from the wall. Order hardware parts below.

#W763 Stocking Keepers Plan..... \$6.99/SET

Hardware Parts

Order one hardware package for each Stocking Keeper you build. You get plastic eyes, eyeglasses, nose, ribbon bow, stocking clip, metal plate, and foam pad. Project plan, wood and paint are not included.

#9946 Hardware Parts \$7.99/PKG
5 or more PKGS..... \$7.49/PKG

To order, list quantity, part number, item, price & total of order. Include \$4.95 shipping & handling on orders under \$50. MN residents add 6.5% sales tax. Mail check or money order. Credit card orders Toll Free 1-800-441-9870.

Meisel Hardware Specialties
P.O. Box 70W12, Mound, MN 55364

RUNNIN' WITH THE PACK



PACK HORSE™

Supports 2 1/2 tons*

\$99.95 a pair

The PACK HORSE is a saw horse made of Southern Yellow Pine & Birch plywood and weighs 32 lbs. When clipped together it stores easily in truck or trunk.

Checks or money orders accepted, call toll free 1-800-945-9545

DAVALCO
301 West 53rd St. suite 3D
N.Y.C., N.Y. 10019

*Not recommended for actual use



Create A Family Treasure with Kuempel Chime Red-i-Kut Kits



- Each case carefully handcrafted by grandfathers
- 3/4" solid walnut, cherry or oak
- Precision movements - chime rods or tubular bells
- Handcrafted pendulums
- Individually hand-painted moonwheels
- Plans, kits, and finished clocks

Write or Call for Catalog \$3.00

1-800-328-6445
Between 8 a.m. and 4 p.m. CDT

Our 75th Year!

Kuempel Chime
Dept. 029, 21195 Minnetonka Blvd.
Excelsior, MN 55331

**FOLD AWAY
ADIRONDACK CHAIR
WITH SEPARATE FOOT REST**

Easy to build in a few hours. Plans are full size with Step-by-step instructions. Using ordinary hardware from your local store.



Sheridan Design, Dept #305
2913 El Camino Real
Tustin, CA. 92680
CA RES ADD TAX

\$ 14.00

Architectural
Plans For A Child's
Colonial Playhouse

Realistic Colonial Design
Full Size Construction Details
Simplified Construction
Standard Materials
4 foot X 6 foot Floor Plan
4 foot - 8 inch high Door

(BROCHURE FREE
WITH FIRST ORDER)
BROCHURE OF
OTHER STYLES
AND SIZES - \$2.00

Plan No. 910
\$24.95
(Incl. postage)
Check or M.O.
No C.O.D.'s
please

ROBERT FLOYD ARCHITECT

P.O. Box 158129, Dept.-A, Nashville, Tennessee 37215 (615) 383-9012

Breathe Easier!



Powered Air
Respirators
for Wood Dust

\$299 Model AGHI

Excellent for all woodworking jobs which create "DUST." Also offers eye protection. Can be worn with beard and glasses. Systems also available for paint and lacquer fumes.

AIRSTREAM DUST HELMETS

16 Division St. W. Elbow Lake, MN 56531
Toll Free 1-800-328-1792 or 218-685-4457



**UNIQUE SHEEP, PIG AND COW
3-Dimensional Wooden Banks**

Great lifelong gifts. Indestructible. 4 1/2 x 9 x 15 long. Photo, instructions, and full-size detailed plans. Kids and adults love them. Send \$12 to:

CHRISTMAN CUSTOM DESIGNS
P.O. BOX 7597-W, ST. CLOUD, MN 56389

**do it
yourself with**



The All-American Value Team

- STAPLING MACHINES
- GLUE GUNS
- RIVET TOOLS
- STAPLES
- GLUE STIX
- RIVETS



For the professional or do-it-yourselfer ARROW makes the job easier, go faster and—less expensive. Whether you're building the new, repairing the old or pursuing a hobby in arts and crafts, ARROW has the right tool.

See the complete assortment of ARROW quality fastening products, available at all leading Hardware, Home Center, and Discount Department Stores.

In U.S.A.: Arrow Fastener Company, Inc., 271 Mayhill Street, Saddle Brook, N.J. 07662
In Canada: Jardel Distributors, Inc., 6505 Metropolitan Blvd. East, Montreal H1P 1X9 Quebec

ASHMAN TECHNICAL LTD.
Machinery - Tools - Shop Equipment

— GENERAL —		US
350-1 Table Saw 3HP.		1450
— with Biesemeyer		1598
— with Excalibur		1695
490-1 15" Band saw, 3/4 HP.		950
160-2 V/S Lathe 3/4 HP.		1198
260-1 V/S Lathe 1 HP.		2254
1180-1 6" Jointer 3/4 HP.		788
480-1 8" Jointer 1-1/2 HP.		1793
Modulus Scoring Saw		340

Canada's Largest "GENERAL" DEALER
351 Nash Rd. N. Hamilton, Ont., Can L8H 7P4
416-560-2400 FAX 416-560-2404
VISA — FREIGHT COLLECT
prices subject to change

THE "PAW PAW PONY"



Years of refinement have resulted in complete plans and full size pattern, that show how to build this impressive all wood rocking horse joined completely with pegs. Full barrel body gives results that make this the plan to use for your special project. Order Plan #911, \$12.95 ppd.

JODAN ENTERPRISES
Dept P, 11308 Elm Dr., Hernando, MS 38632

Panasonic

EY6005BC
12V, 1 Hour, Keyless
Drill W/2 Batteries
\$179



3338
2-1/4 HP Elect.
VS Plunge Router
\$245



3380 jointer/spliner with case 245
4024 3x21 VS sander 159

JET

JCS-10A
10" Cabinet Saw
w/ Jet Fence
\$895



BOSCH
1581VS
Top Handle Jig Saw
W/Case & 30 Blades
\$184



1581VS top handle jig saw 129
1582VS barrel grip Clic jig saw 129
3050VSRK 3/8" VSR kit w/2 batt 128
1370DEVSK 6" random sdr kit 299*

*Free Freight in Contiguous USA
*Same Day Shipping
Full Line Distributor

ALL The Tools You Need to SUCCEED!

The Accu-Miter

18-34
Precision Mitre
Gauge W/Bar
\$149



POWERMATIC

1660760
66 Saw 3 HP
W/50" Biesemeyer
\$1699

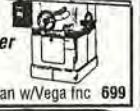

PORTER-CABLE

7334
Random Orbital
Sander W/Case
& 100X/150X Paper
\$149



7334 5" random orbit sdr 118
7335 5" VS random orbit sdr 129
7336 6" VS random orbit sdr 134
73333 sander dust pick-up kit 29

1-800-358-3096

Box 1716 • Grand Forks, ND • 58206
Send \$3.00 For 208 Page Catalog
WOOD Nov. 91 FAX US YOUR ORDER! 1-701-746-2857

RYOBI

BT3000
10" Sliding
Table Saw
W/Dust Bag
\$549



AP10 10" portable planer 348
JP-155 6-1/8" jointer/planer 299
TS254 10" mitre saw w/c.t. bl. 209
RS115 4-1/2" random orb sander 78
RE600 3HP V.S. plunge router 199
R331 2 hp D-Handle router 129
JM100K NEW plate jointer 205
TFD220VRK 12v cdls kit/2 bat 165

freud

JS-100
Plate Joiner
W/Case & 500
Assorted Biscuits
\$144*

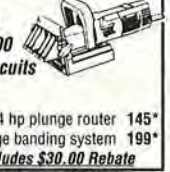

FT2000 3-1/4 hp plunge router 145*
EB100 edge banding system 199*
*Price Includes \$30.00 Rebate

Makita

6095DWE
3/8", VSR,
W/Keyless
Chuck & Extra Battery
\$139



3612BR 3 hp plunge router 165
2012 12" planer w/dust chute 459
LS1011 10" comp. mitre saw 439

Emqlo

AM78-HC4V
1-1/2 HP Vertical
Twin Tank
\$309



DELTA

46-700 NEW!
12" VS
Wood Lathe
\$449



28-180 bench bandsaw 169
23-700 wet/dry grinder 159
11-950 8" bench drill press 145
40-560 16" 2-speed scroll saw 184
22-540
12" Planer
W/Dust Chute
\$399



HITACHI

C8FB
8-1/2" Compound
Mitre Saw
\$439



P12RA NEW 12" planer/6" jointer 799
D10DFK 9.6V VSR dr kit w/2 bat 159
C7BD 7-1/4" saw w/case 129
M12V 3-1/4 hp VS pl. router 224

SKIL POWER TOOLS

2735-04X
12V, 3/8" Keyless
Chuck Drill Kit
W/2 Batteries
\$135



DELTA

34-782
3 HP Unisaw
w/Unifence
& Motor Cover
\$1549*

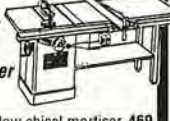

14-600 hollow chisel mortiser 469
36-220 10" comp. mitre saw 235
34-444 10" contractor's saw 619
34-445 10" cont. w/30" Uni&EMS 849
28-283
14" Band Saw
W/Mobile Base
\$735



43-375 3HP HD wood shaper 1469*
31-730 6" belt/12" disc sander 969*
37-350 8" jointer/DJ-20 w/stnd 1299*
50-180 1 hp dust collector 418
50-179 3/4 hp dust collector 338
* Price Includes Rebate!

Milwaukee

6527
VS Super
Sawzall W/Case
\$165



0402-1 12V VSR kit w/keyless ch 163
5397-1 3/8" hammer drill kit 139
6125 5" random orbital sander 129
6368 7-1/4" saw w/cr bl, case, fence 135

WOOD PARTS FROM MIDWEST DOWEL WORKS

Compare Our Low Prices!

Qty.	Cost
3-1/2" Poplar Shaker Peg	\$15/100
1-3/4" Mini Shaker Peg	\$7/100
3-1/2" Country Wall / Mug Peg	\$15/100
2-1/2" Country Shorty Peg	\$12/100
Large Bean Pot Candle Cup	\$17/100
Brass Inserts	\$9/100
1/2" Mini Candle Cup	\$10/100
1-1/2" Toy Wheel	\$10/100
2" Toy Wheel	\$17/100
Axel Pegs	\$4/100

SMOOTH SANDED HEARTS

3/4" x 1/8" Hearts	\$2.75/100
3/4" x 1/2" Hearts	\$4.50/100
1" x 3/16" Hearts	\$4.00/c
1" x 3/8" Hearts	\$6.50/c
1-3/8" x 1/8" Hearts	\$5.50/c
1-3/8" x 1/4" Hearts	\$7.50/c
1-3/8" x 1/2" Hearts	\$10/100
2" x 1/2" Hearts	\$18/100

Great Buys!

Qty.	Cost
3/8" x 36" Standard Dowels	\$21/100
3/4" x 36" Oak Dowels	\$15/10
3/8" Maple Buttons	\$2.15/100
1/2" Maple Buttons	\$2.25/100
1-1/2" Maple Spindles	\$9/100
2-1/8" Maple Spindles	\$18/100

ORDER NOW

MC/Visa Check Enclosed

Total Cost _____

Handling **\$3.00**

Ohio residents add 5% sales tax _____

Final Cost _____

MC/Visa Number _____

Expires _____ Phone _____

Name _____

Address _____

City/State/Zip _____

FREE 16-PAGE CATALOGUE

Circle this section for FREE Dowels
— mixed pack, Maple, Oak, Walnut
Cherry, from 1/4" up to 1"
Approximately 10 LFT. 14" long.
\$5.00 value with any order.

MIDWEST DOWEL WORKS

4631 Hutchinson Road
Cincinnati, Ohio 45248
(513) 574-8488
Same Day Service/Order before Noon
Factory Direct/Satisfaction Guaranteed

Econ-Abrasives

WE MAKE ABRASIVE BELTS ANY SIZE, ANY GRIT!

ABRASIVE SHEETS: (9 X 11)		ABRASIVE BELTS			
CABINET PAPER		PLEASE SPECIFY GRITS			
		1X30	\$.73 ea	3X24	\$.84 ea
		1X42	.73 ea	3X27	.87 ea
40D	\$17.00	1X44	.73 ea	4X21 3/4	.96 ea
50D	16.00	2 1/2X16	.77 ea	4X24	.99 ea
60D	15.00	3X18	.78 ea	4X36	1.20 ea
80D	14.00	3X21	.81 ea	6X48	3.14 ea
100 thru 150C	13.00	3X23 3/4	.84 ea	2 1/4X80	2.94 ea
FINISHING PAPER		OTHER SIZES ON REQUEST			
80A	\$ 10.00	JUMBO CLEANING STICK \$8.80 2 x 2 x 12			
100 thru 280A	9.00				
WET/DRY PAPER		*OTHER ITEMS*			
220 thru 600	\$14.00	*WIDE BELTS	*PSA DISCS		
	\$24.00	*ROLLS	*ROUTER BITS		
NO LOAD PAPER		*FLAP WHEELS	*WOOD GLUE		
180 thru 400A	\$11.00	*PUMP SLEEVES	*VELCRO DISCS		
	\$19.00				
C = 100 SHEETS					

*MINIMUM ORDER \$25.00
*MasterCard, VISA, or Check
*SATISFACTION GUARANTEED!!!
*CALL FOR FREE 1991 CATALOG

- TX & NV Add Sales Taxes
- Continental U. S. Shipping
Charges add \$5.50

NATIONAL (800)367-4101

Econ-Abrasives
P. O. Box B865021
Plano, TX 75086
(214)377-9779

Tool Safety Tips

Practicing tool safety regularly is one of the first habits to develop in the home workshop. Use common sense, and the guidelines below, to add to the many hours of woodworking enjoyment ahead of you. [Print this article](#)

- Always unplug a power tool before servicing or adjustment. Let moving parts come to a standstill.

- Never wear loose-fitting clothes or dangling jewelry when using power or hand tools.

- Check the condition of a tool before you use it. Inspect power cords for cracks or frays, cutting edges for sharpness, and handles for stability.

- Don't tamper with or remove safety mechanisms from power tools. After all, they are there for your protection.

- Use the proper tool for a job. Read and understand all instruction manuals that apply to a tool before you use it. Find out what it was meant to do as well as what it can't do.

- If there is even a remote possibility of eye injury in a particular situation, don't hesitate to wear safety goggles.

- Keep onlookers, especially young children, a safe distance away while you're working with tools. Always instruct others in the proper use of a tool before letting them use it.

- Work in good light. Use bulbs of sufficient wattage and have extra clamp-on or other portable lights available as needed.

- Never work with tools when you're in a hurry, tired, or in a bad mood.

- Put tools away after use, preferably in a locked cabinet. 🔒

AMAZING PRICE BREAKTHROUGHS!

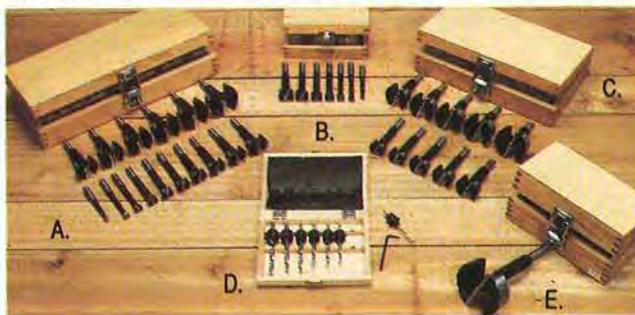

A. 16 pc. Forstner Bit Set #77581 \$87.95
All bits 3 1/2" overall, precision ground, HRC 50-52. Sizes 1/4" through 2 1/8" in wooden case. All 3/8" shanks. Sizes over 1 1/2" supplied with saw teeth to eliminate overheating.

B. 7 pc. Forstner Bit Set #77571 \$27.95
All bits 3 1/2" overall, precision ground, HRC 50-52. Sizes 1/4" through 1" in wooden case.

C. 10 pc. Forstner Bit Set #53982 \$74.95
All bits 3 1/2" overall, precision ground, HRC 50-52. Sizes 1", 1 1/8", 1 1/4", 1 3/8", 1 1/2", 1 5/8", 1 3/4", 1 7/8", 2", 2 1/8" in handsome wooden case. All bits with saw teeth for faster free drilling!

D. 22 pc. HSS Tapered Drill, Countersink/Bore, Stop Collar Set #12232 \$26.95
For screw sizes #'s 5, 6, 7, 8, 9, 10, 12. Wood case included.

E. Jumbo Forstner Bits #18302 \$139.95
8 pc. Set includes 2 1/2" thru 3 1/8", all with saw teeth.
2 1/4" Bit #18232 \$21.95 | 2 3/4" Bit #18272 \$27.95
2 3/8" Bit #18242 \$22.95 | 2 7/8" Bit #18282 \$31.95
2 1/2" Bit #18252 \$24.50 | 3" Bit #77591 \$33.99
2 5/8" Bit #18262 \$25.50 | 3 1/8" Bit #18292 \$35.95

F. Classic Bench Hold-down #54012 \$6.95
Tap on top secures your work, tap at the back releases it. Great for any workbench top.

G. Special Anti-Kickback Device
Table Saw Anti-Kickback #50179 \$31.95
Radial Anti-Kickback #74131 \$31.95
Shaper Anti-Kickback #74141 \$31.95
Optional 2 pc. Aluminum Track #74201 \$10.95

H. Anti-Kickback Featherboard & Hold Down
Featherboard fits into miter gauge slot of your table saw and locks into position. Also prevents material from raising off the blade. #29402 \$11.95

I. Safety Push Block
Sure grip 3" x 5" pad. Helps keep hands away from planer, jointer or table saw blades. #54032 \$3.95

J. Quick Release, Large Capacity Bench Vise
Heavy cast iron construction with built-in steel bench dog. Jaws are 7" wide and predrilled for adding wooden faces. Opens to 11" and mounts to a 2 5/8" or thinner section of your bench. #54002 \$37.95

K. 5 pc. Jumbo Bradpoint Drill Set #54992 \$18.95
Comes in sizes 9/16", 5/8", 7/8" & 1". All with 3/8" shanks.

L. 7 pc. Carbide Tipped Bradpoint Drill Set #53992 \$31.95
Creates clean entry holes with no overheating. Sizes 1/8", 3/16", 1/4", 5/16", 7/16", & 1/2". Wooden case included.

M. 25 pc. Bradpoint Drill Set #77611 \$17.95
Fits any 3/8" or larger chuck. Free metal index.

N. 7 pc. Stop Collar Set #93361 \$4.95

O. 4 pc. Mortise & Chisel Set #54022 \$39.95
Comes with sizes 1/4", 5/16", 3/8" & 1/2". Standard 5/8" shank fits most brand's mortise attachment.

P. Mortise Attachment #64202 \$24.95
Fits all major brands and imports including Jet, Grizzly and Delta. For 5/8" shank, chisels and bits.

In Ohio, please add 6% Sales Tax. Minimum order \$18.95.
All orders add \$3.00 shipping/handling charge.

1-800-345-2396

940 W. Maple St., Hartville, Ohio 44632
Offer available in 48 continental states only.



Handy Tools

Even in this power-everything woodworking world, most tasks still require a hand tool or two. And, having the right hand tool within easy reach can make all the difference between having fun and being frustrated with your next project. Here are some items that might just save your day.

 [Print this article](#)



▶ With an oversized face and weight of 21 oz., the Stanley Deckmaster (\$24.79 list) will help you drive deck nails faster than ever. Stanley Tools, Reader Response Service, Dept. WD, P.O. Box 1146, Bellmore, NY 11710; 203/827-5237.

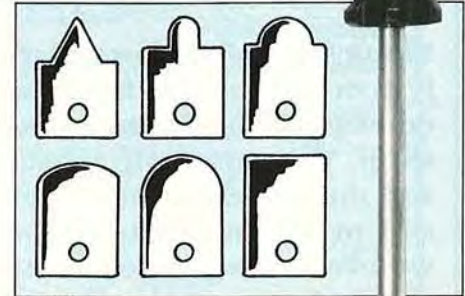

▶ Removing paint or varnish from intricate moldings can turn into time-consuming work if your scraper or sandpaper can't reach into tiny nooks and crannies. The Shape Skrape holds one of six differently shaped, interchangeable blades for getting into those tight spots. Replacement blades available. Price: \$9.25 ppd. from CONVALCO, Dept. WD, P.O. Box 1957, New Britain, CT 06050; 203/223-0076.



▶ From the land of the rising sun come traditional Japanese Handsaws that cut on the pull stroke. One side of the replaceable blade is for rip cuts, the other side has fine teeth for smooth, tear-free crosscuts. \$21.90 ppd. from The Japan Woodworker, Dept. WD, 1731 Clement Ave., Alameda, CA 94501; 800/537-7820 or 415/521-1810.

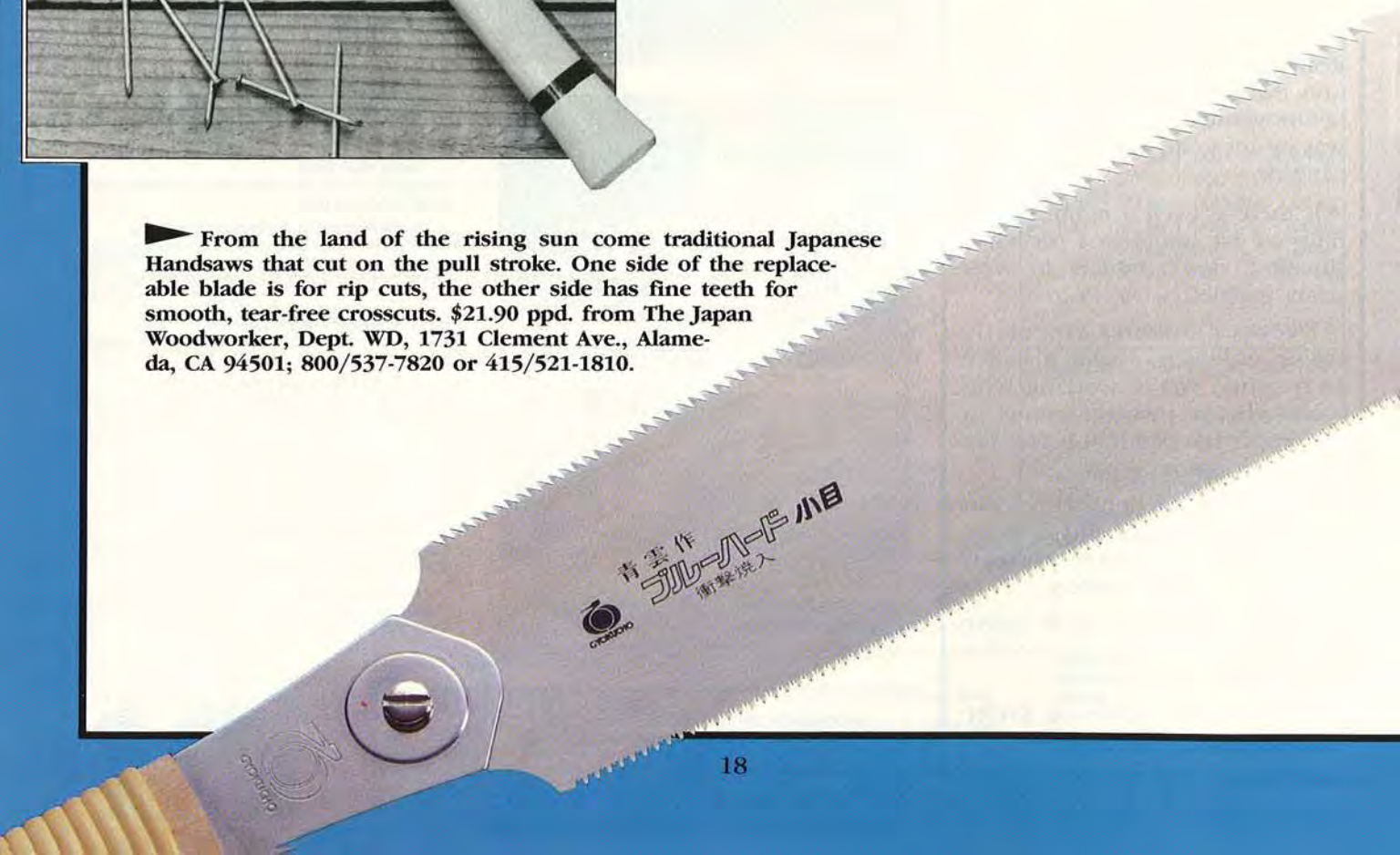

▶ Routers are great for making mortises. There's only one problem. The router cutter makes a round-cornered mortise. To square the mortise quickly and cleanly, just line up the Corner Chisel with the sides of the mortise, tap the spring-loaded cutter with your hammer and presto! Square corners. Order product No. SPT42234 for \$21.95 ppd. from Constantine's, Dept. WD, 2054P Eastchester Road, Bronx, NY 10461; 800/223-8087 or 212/792-1600.

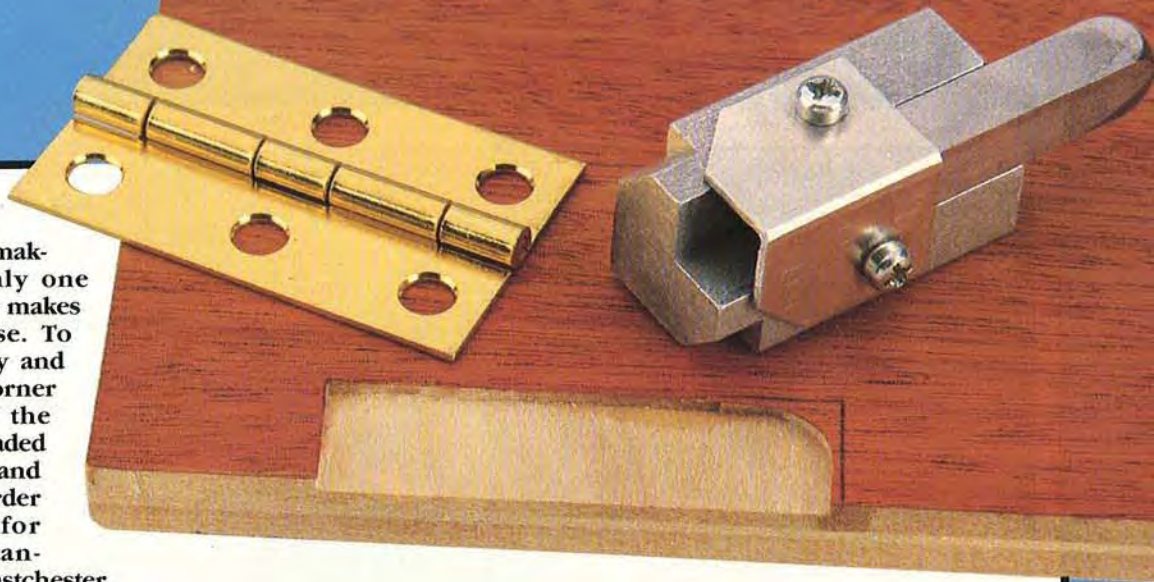

▶ Who says woodworkers can't have measuring and marking tools as nice as any machinist's? Not the makers of General Tools' new Woodworking Measuring and Marking Kit that includes a 6" combination square with level and scribe, protractor and depth gauge, stainless-steel 6" rule, high-quality pencil compass, scratch awl, and dial calipers. Suggested list price: \$92, General Tools Mfg. Co., Dept. WD, 80 White St., New York, NY 10013; 212/431-6499.

▶ The Rali 220 Bench Plane features a disposable, double-edged blade that automatically indexes square to the sole of the plane for smooth, effortless planing. \$89.95 ppd. from Farris Machinery, Dept. WD, 320 N. 11th St., Blue Springs, MO 64015; 800/872-5489 or 816/229-3055.



Hand Tools



◀ There's just no getting around some hand-sanding on many projects, but the Hand Ease Sander makes the job as quick and convenient as possible. The lightweight tool fits comfortably in your hand, and holds a continuous roll of sandpaper. When you wear out a section of paper, just tear it off and roll out some fresh abrasive. About \$5.99 for the sander, and \$3.49 for replacement rolls in various grits. Consumer Relations, Dept. WD, 3M DIY Division, 3M Center, 515-3N-02, St. Paul, MN 55144.

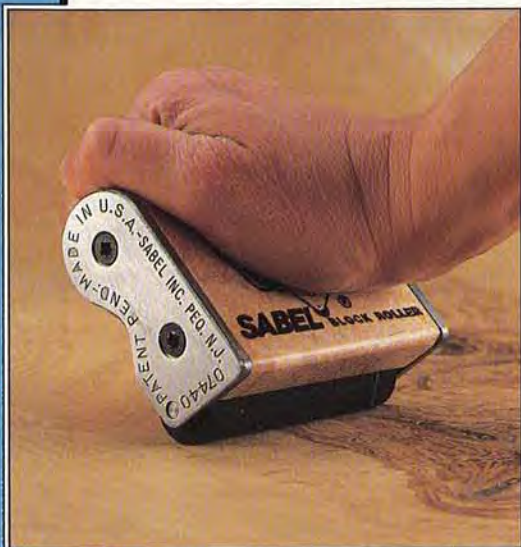

◀ Rolling out veneer takes plenty of elbow grease, so it pays to have a tool that's easy on your hand. The Veneer Roller (\$26.95 ppd.) has a solid-maple body that's curved for a comfortable fit, and angled to put the heel of your hand directly over the roller for smooth, controlled pressure. Constantine's, Dept. WD, 2054P Eastchester Road, Bronx, NY 10461; 800/223-8087 or 212/792-1600.



◀ Pony $\frac{3}{4}$ " pipe saddles hold your $\frac{3}{4}$ " pipe clamps steady so that you can concentrate on the clamping task at hand. A set of four lists for \$11.97. Adjustable Clamp Co., Dept. WD, 417 Ashland Ave., Chicago, IL 60622; 312/666-0640.

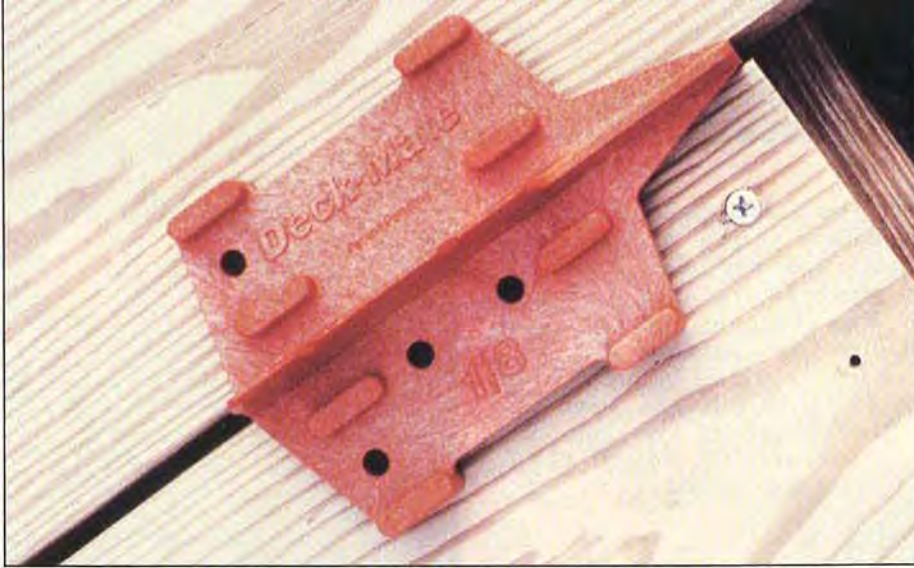

▲ For a deck that's well constructed and good looking, you need to space the boards evenly. Deck-Mate helps you set boards either $\frac{1}{8}$ " or $\frac{3}{16}$ " apart, and serves as a template for marking evenly spaced pilot holes on board ends. You can order it for \$5 ppd. from Recreation Products, Dept. WD, 7 Olde Orchard Lane, Fairport, NY 14450; 716/377-0070.

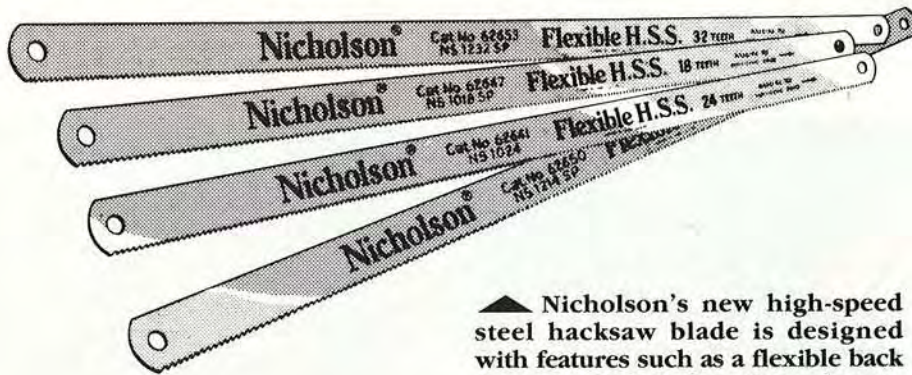

▲ Nicholson's new high-speed steel hacksaw blade is designed with features such as a flexible back to make it last five times longer than conventional carbon blades. The blade comes in two sizes: 10" with three tooth configurations, and 12" with four tooth configurations. Suggested retail price: \$2.39-\$2.59 for two blades. Nicholson High-Speed Steel Hacksaw Blades, Dept. WD, P.O. Box 728, Apex, NC 27502.

▼ Small-scale tinkerers rejoice! The Miter Rite (\$27.45 ppd.) handles your small workpieces with the delicate touch they deserve. Its saw blade has 54 teeth per inch for fine cutting, and adjusts 65° on each side of 90° . Micro-Mark, Dept. WD, 340-1077 Snyder Ave., Berkeley Heights, NJ 07922; 800/225-1066 or 908/464-6764.



▼ Here's a way to get drill-press accuracy with your portable drill. General Tools' Drill Guide (\$37.60 list price) adjusts to a 45° angle from either direction of vertical, and has a V-groove for positioning dowels, pipes, or tubing. The tool works with $\frac{3}{8}$ " and $\frac{1}{2}$ " drills with a $\frac{3}{8}$ " \times 24-thread chuck-mounting shaft. General Tools Mfg. Co., Dept. WD, 80 White St., New York, NY 10013; 212/431-6100.

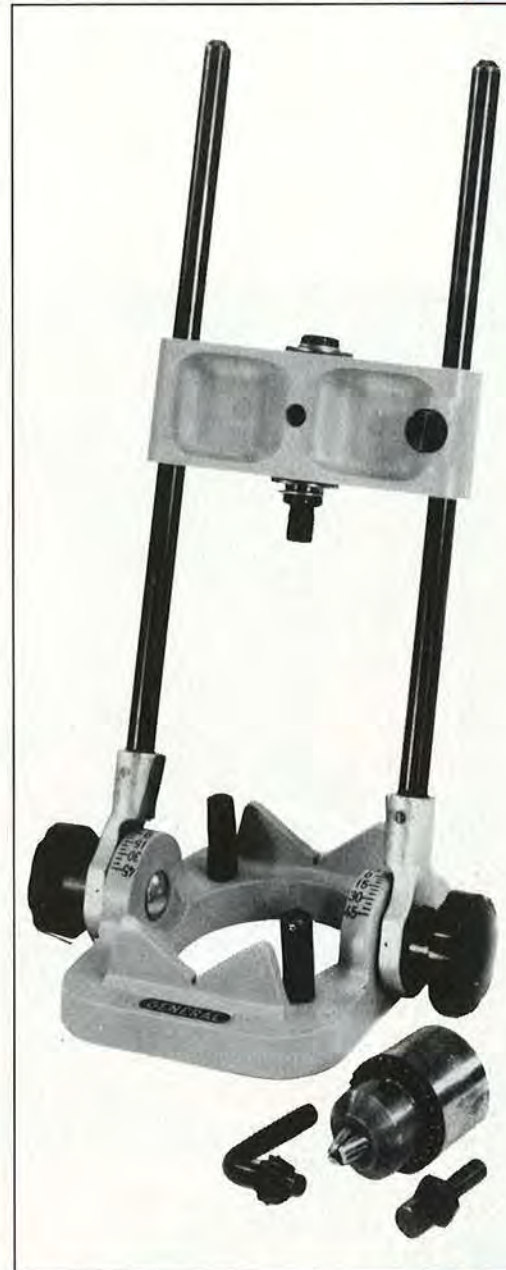

Hand Tools



▲ A mallet with a nearly indestructible head? Yep. The ultra-high-density, molded polyethylene heads of the Vaughan "Super-Plastic" Mallet will not fracture or delaminate under hard blows. The mallets are available in three sizes: 8, 11, and 17 oz. (the 11-oz. model has a suggested retail price of \$16.80). Available at most hardware stores and homecenters.

▶ The E-Clamp holds all sorts of irregularly shaped workpieces including rods and tubes. It also has an attachable, centered third arm for edge clamping. The tool comes in three jaw capacities: 2½", 4½", and 6½", ranging in price from \$22.50-\$34.50. Inlet Inc., Dept. WD, One Saunders Ave., San Anselmo, CA 94960-1795; 800/786-5665.

▼ With a toggle lock positioned where the thumb naturally grips the tape, the Lufkin Series 2000 Power Tapes give you comfortable and accurate performance. Suggested retail prices for the 12' and 16' models: \$16.79 and \$20.79. Lufkin 2000, Dept. WD, P.O. Box 728, Apex, NC 27502.





▶ With one of these hot branding irons in hand, you can quickly and tastefully put your personal brand on all your woodworking projects. A two-line version such as the one shown, with a name not exceeding 20 characters, sells for \$29 ppd. (Electric versions also available.) Nova Tool, 12500 Finigan Rd., P.O. Box 29341, Dept. BG, Lincoln, NE 68529; 800/826-7606 or 402/464-0511.



▼ Here's a quick, affordable, and effective way to square and clamp rectangular frames without the fear of bowing. Bessey's KP Framing System consists of four die-cast aluminum blocks for holding four Bessey K Body clamps in a square configuration. Together, these components form an ideal clamping jig for doors, window frames, boxes, and picture frames. A set of four blocks lists for \$49.70. K Body clamps have jaw openings from 12" to 98" and list for \$41.85 to \$77.60 each. American Clamping Corporation, Dept. WD, 50 Franklin St., P.O. Box 399, Batavia, NY 14021; 800/828-1004 or 716/344-1160.



▲ At one time or another, most of us have either dropped and damaged a level or inadvertently left one out in the elements. Now, Stanley has a solution for these problems. The Protect-A-Level Case fits most 24" and 48" levels and lists for \$8.59 and \$12.85. Stanley Tools, Reader Response Service, Dept. WD, P.O. Box 1146, Bellmore, NY 11710; 203/827-5237.

Hand Tools



▲ When ordinary paint scrapers won't work, reach for the Red Devil Contour Molding Scraper. It works on S-shaped and cove moldings, and can be used as a heat-gun accessory. List price: \$5.65. Red Devil, Dept. WD, 2400 Vauxhall Rd., P.O. Box 194, Union, NJ 07083-1933; 800/247-3790 or 908/688-6900.

▶ As its name implies, Vaughan's Original SuperBar may prove to be one of the handiest items in your toolbox. The 15"-long tool works for many prying and lifting tasks. Its uniquely shaped head makes pulling nails easy. Suggested retail price: \$11. Available at most hardware stores and homecenters.



▼ They say diamonds are forever, and you can count on a lifetime of service from an 8" or 12" DMT Diamond Whetstone. The indestructible "stones" remain flat, come in three grits, and require only water for lubrication. The 8" costs \$75, the 12" sells for \$130 (add \$2.50 for handling). Diamond Machining Technology, Dept. WD, 85 Hayes Memorial Drive, Marlborough, MA 01752; 800/666-4368.



▲ Sharpening curved blades such as gouges is no easy feat, but the Warren Sharpening Aid (No. K91-5, \$32.25 ppd.) sure helps. The tool has a brass chuck for holding a 4"-long, interchangeable, diamond-impregnated steel, tapered round hone. Warren Tool Co., Dept. WD, 2209-1 Rt. 9G, Rhinebeck, NY 12572; 914/876-7817.



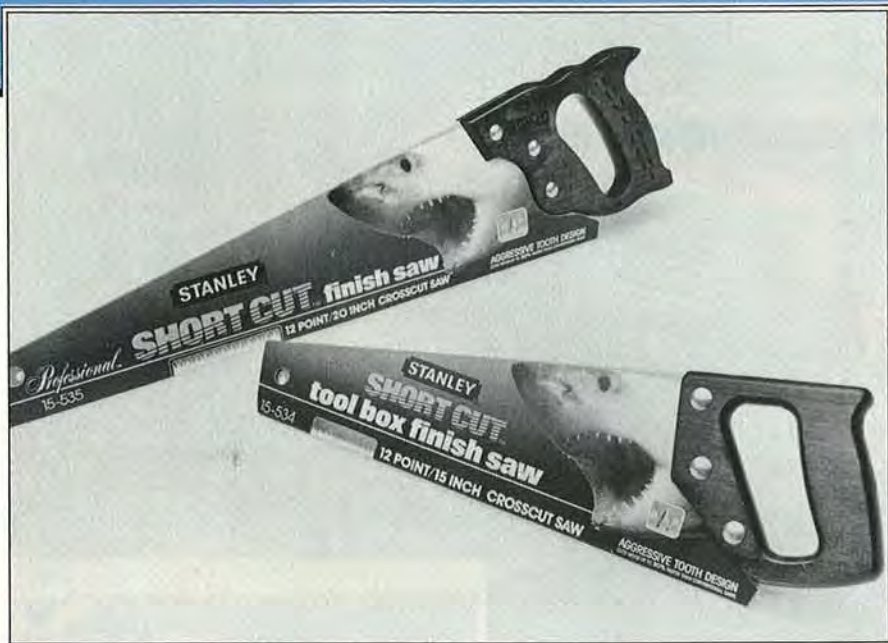

◀ Stanley's new line of Short Cut handsaws has precision-set and bevel-ground teeth that cut in both the push *and* pull strokes. Stanley has incorporated this design in crosscut and backsaws, with list prices in the \$15-\$25 range. Stanley Tools, Reader Response Service, Dept. WD, P.O. Box 1146, Bellmore, NY 11710; 203/827-5237.



▲ Here's an easy and inexpensive (\$18.90 ppd.) way to get started in carving. Warren Tool's new 8-Piece Deluxe Woodcarving Kit (No. K91-2) features a walnut handle with brass fitting for pre-honed interchangeable blades. Warren Tool Co., Dept. WD, 2209-1 Rt. 9G, Rhinebeck, NY 12572; 914/876-7817.



▶ No clamp joins together two mitered pieces as quickly as the No. 62 Mitre Clamp (about \$38). Its jaws have tiny sharpened pins that grab the workpiece as you pull on the clamp's eccentric lever. That's it! The pins make hardly noticeable holes in the workpiece. The Hartford Clamp Company, Dept. WD, 466 Park Ave., P.O. Box 280131, East Hartford, CT 06128; 203/528-1708.

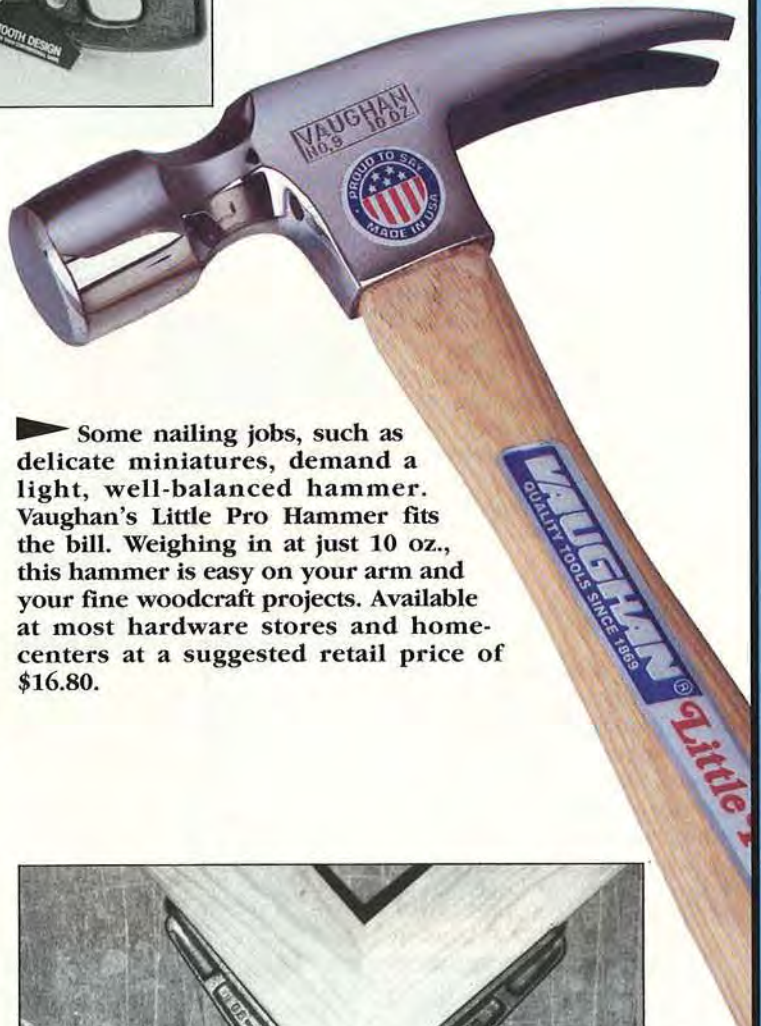

▶ Some nailing jobs, such as delicate miniatures, demand a light, well-balanced hammer. Vaughan's Little Pro Hammer fits the bill. Weighing in at just 10 oz., this hammer is easy on your arm and your fine woodcraft projects. Available at most hardware stores and home-centers at a suggested retail price of \$16.80.

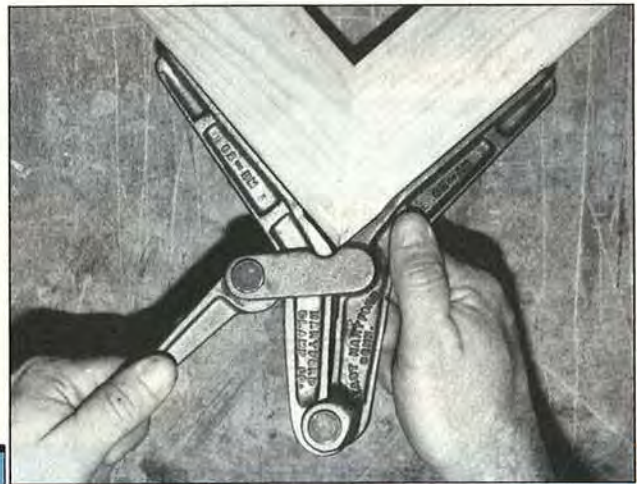

Hand Tools



◀ Sonin's Calcu-Tape combines five tools in one compact instrument: 12' locking, power-return tape rule, solar-powered calculator, level vial for plumb or horizontal readings, angle finder for any pitch from 0° to 180°, and an erasable writing surface. Whew! And all for \$17.99 ppd. Sonin Inc., Dept. WD, 672 White Plains Rd., Scarsdale, NY 10583; 800/223-7511 or 914/725-0202.

▶ How can Stanley improve on its tried-and-true Professional Combination Square? By adding a solid-brass adjusting knob and scriber knob. The 12" version lists for \$19.49 (you can also buy a 16" version). Stanley Tools, Reader Response Service, Dept. WD, P.O. Box 1146, Bellmore, NY 11710; 203/827-5237.

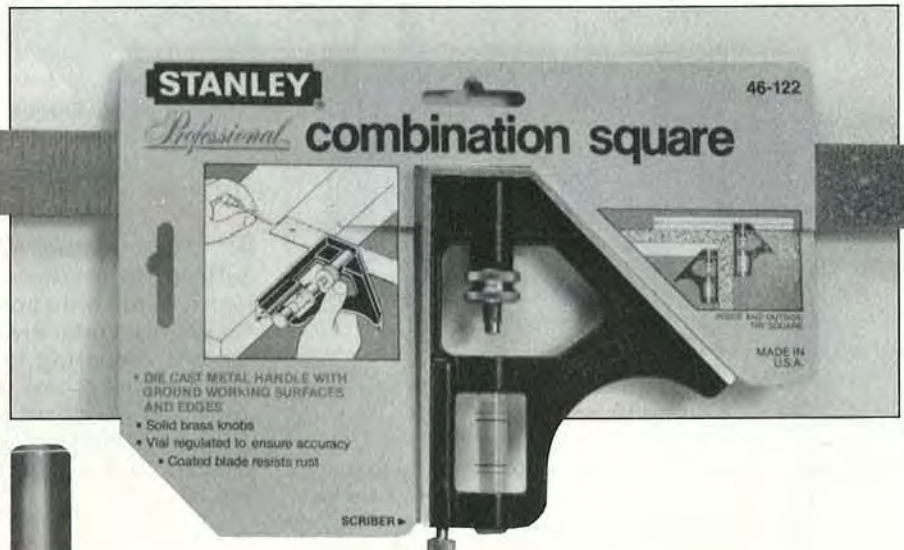

▼ With a General Tools' Wheel & Circle Cutter, you can cut a hole of any diameter from 1" to 6". The high-speed steel cutter works in wood, sheet metal, brass, copper, aluminum, plastic, and composition materials. List price: \$17.76. General Tools Mfg. Co., Dept. WD, 80 White St., New York, NY 10013; 212/431-6100.

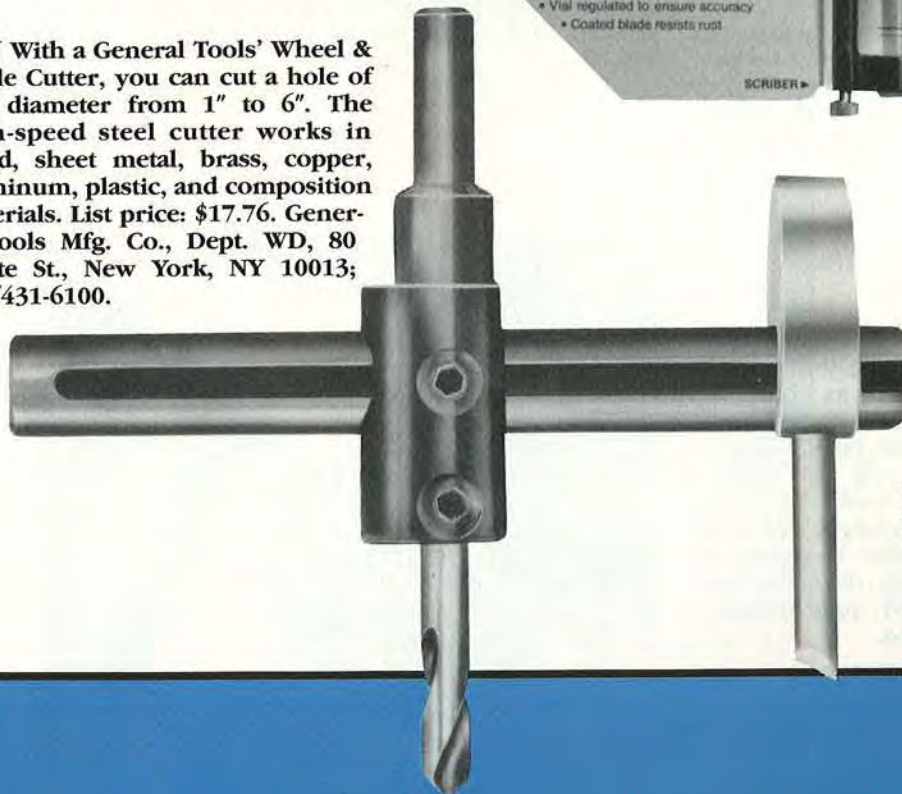

▶ The adjustable cams of the Toulan 2005 Corner Cam-clamp tightly hold workpieces from 1/4" to 2" wide at precisely 90°. A set of four clamps sells for \$48 ppd. Toulan USA, Dept. WD, P.O. Box 12389, Beaumont, TX 77726; 409/838-1386.

Hand Tools



▶ If you like the very best, listen up. Because of their special laminated steel, the importer of these Japanese Blue-Steel Chisels calls them the "world's finest chisels." Price: \$38.45 to \$125.95 per chisel. Japan Woodworker, Dept. WD, 1731 Clement Ave., Alameda, CA 94501; 800/537-7820 or 415/521-1810.

◀ If three stones are truly better than one, then the Tri-Stone Sharpening System is surpassed by none. Three stones (coarse, medium, and fine) are held in place in a simple rotating jig for quick sharpenings. The product comes complete with honing oil and sells for \$29.95 plus postage. Woodcraft, Dept. WD, 210 Wood County Industrial Park, P.O. Box 1686, Parkersburg, WV 26102; 800/225-1153 (sales) or 800/535-4486 (technical help).

▼ Most of us aren't able to hold a chisel or plane blade at the correct and consistent angle while sharpening the cutting tool on a stone. That's why General Tools makes a Chisel/Plane Blade Sharpening Kit (list price: \$15.40). You simply secure the chisel or plane blade in the holder, then roll the wheeled tool across the stone. It's as easy as that! The device holds blades up to 2 5/8" wide at a 30° cutting angle. General Tools Mfg. Co., Dept. WD, 80 White St., New York, NY 10013; 212/431-6100.

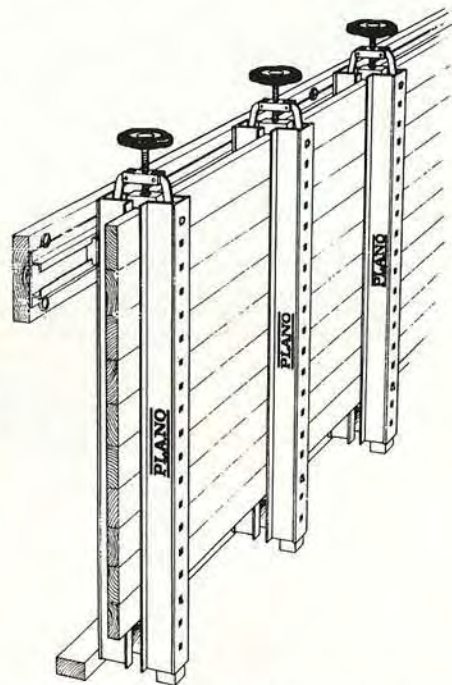
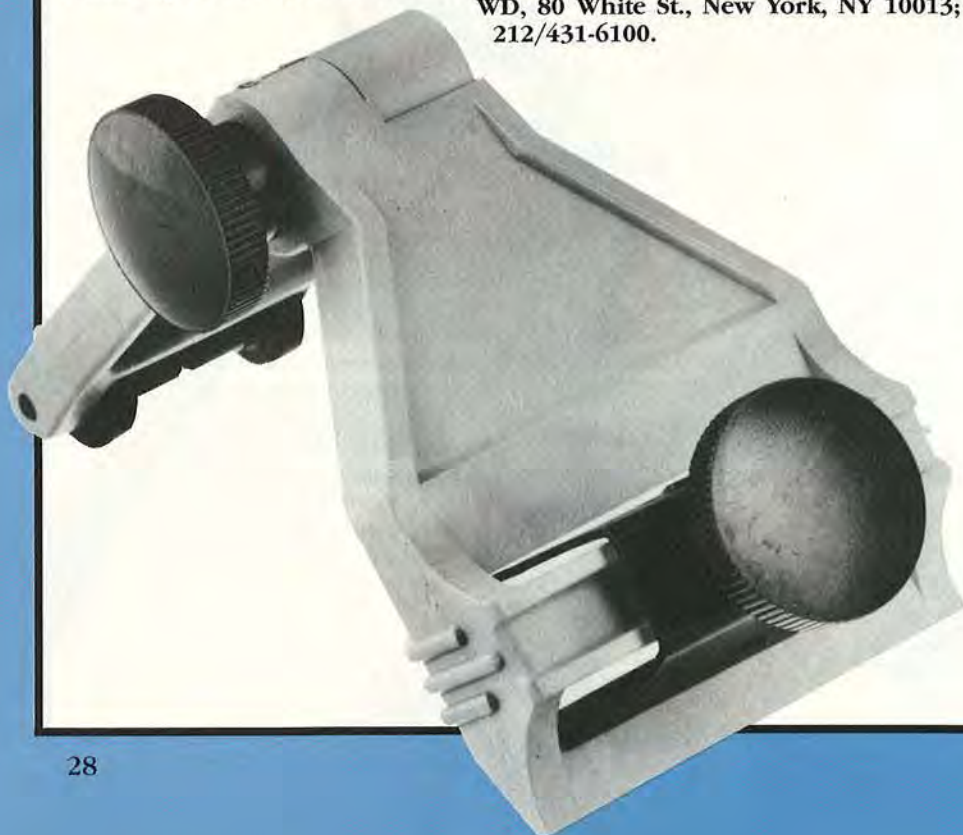

▶ Because the Plano Vertical Glue Press mounts to a wall, this system saves you space while making quick, goof-proof work of edge-to-edge glue-ups. The standard press consists of three 43" clamps and one 39" rail, and sells for \$429 (49" clamps also available). Advanced Machinery Imports, Dept. WD, 2 McCullough Drive, P.O. Box 312, New Castle, DE 19720; 800/648-4264 or 302/322-2226.



▼ The Lufkin Ultrasonic Tape won't replace your tape measure, but you can't top it for quickly calculating the area and volume of a room. Simply point the machine at a wall, punch a button, and the tool provides you with a 99 percent accurate reading over its 48-foot measuring range. The machine handles all of the calculations for you in feet or meters. Suggested retail price of \$35.10. Lufkin Ultrasonic Tape, Dept. WD, P.O. Box 728, Apex, NC 27502.

▼ You may not be able to say its name quickly, but the Akafuji Kanna (Fuji at Sunset) Japanese Woodworking Plane gives the type of long, fine shavings that any woodworker can appreciate. Its thick iron puts a stop to chattering. The model shown in use has a hand-forged, laminated blade and sells for \$265 (other models cost as little as \$35). Japan Woodworker, Dept. WD, 1731 Clement Ave., Alameda, CA 94501; 800/537-7820 or 415/521-1810.



Hand Tools

► Talk about versatility in a layout tool! You can measure, mark, or transfer any inside or outside angle with the Anglesetter/Protractor. The high-impact plastic has brass hardware and a 6"-long blade (\$9.95 ppd.). Micro-Mark, Dept. WD, 340-1077 Snyder Ave., Berkeley Heights, NJ 07922; 800/225-1066 or 908/464-6764.

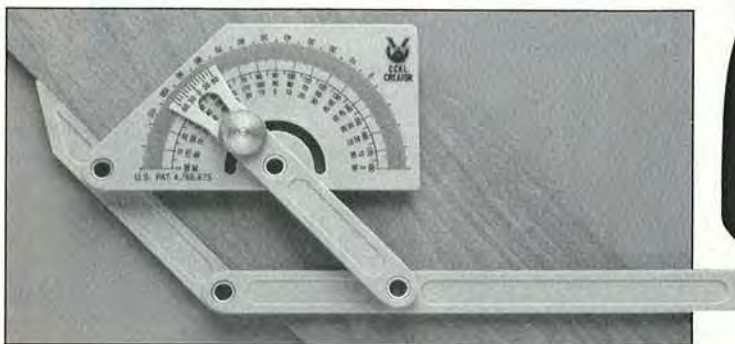

► When you're laying deck boards, bowed lumber can really give you fits. The Lumber Jack helps you deal with this problem quickly and effectively. The tool costs \$89.95 ppd., and will close gaps up to 1 1/4" in just a few seconds. T.C. Manufacturing, Dept. WD, P.O. Box 122, Fredericktown, OH 43019; 800/253-5669.

► The tools in this 8-Piece Riffler Rasp Set have coarse-cut teeth that quickly eat through the toughest woods. With a price of \$26.50 plus postage, the set is affordable for nearly all carvers, sculptors, and other hobbyists. Woodcraft, Dept. WD, 210 Wood County Industrial Park, P.O. Box 1686, Parkersburg, WV 26102; 800/225-1153 (sales) or 800/535-4486 (technical help).



► Get extra life out of your twist drills with General Tools' Drill-Grinding Attachment (\$22.06 list price). Handles bits from 1/8" to 3/4". General Tools Mfg. Co., Dept. WD, 80 White St., New York, NY 10013; 212/431-6100.

► If you use a lot of plugs or dowels, you'll appreciate the capabilities of the French Flush Cutting Saw (\$14.95 plus postage). The teeth have no set on the bottom side and the blade is bent slightly upward from the frame so the saw doesn't scratch adjacent surfaces. Garrett Wade Company, Dept. WD, 161 Avenue of the Americas, New York, NY 10013-1299.





▲ Unlike any other clamp, you can operate the Quick-Grip Bar Clamp with only one hand, leaving your other hand free to position your workpiece. The clamps have jaw openings from 6" to 36", with list prices from \$20.99 to \$33.60. You can also buy a kit for corner clamping. American Tool Companies, Customer Service, Dept. WD, P.O. Box 337, DeWitt, NE 68341; 402/683-2315.

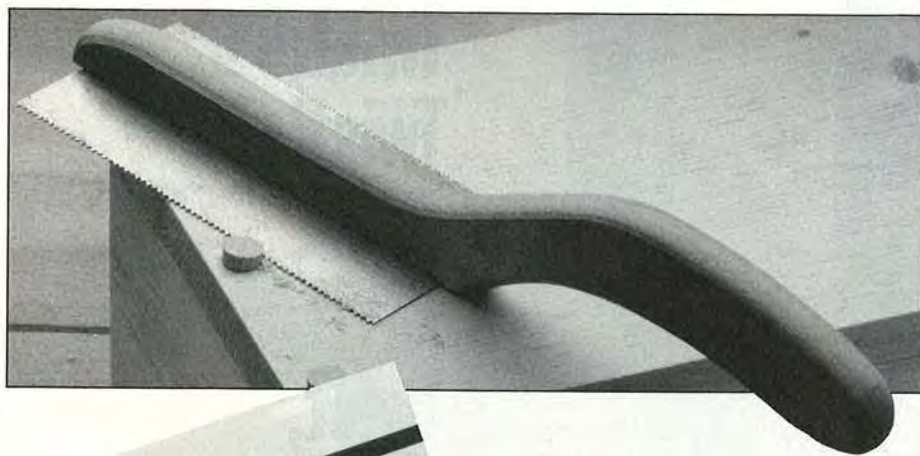

▼ Wood graining is catching on again, and here's an inexpensive tool (list: \$3.95) to help you out. A faux-grain look appears when you pull and slowly turn UGL's Wood-Graining Tool across a surface covered with stain. United Gilsonite Laboratories, Dept. WD, P.O. Box 70, Scranton, PA 18501; 800/845-5227 or 717/344-1202.



◀ Screwdrivers in the new Claw line have several things going for them not found in other screwdrivers. The handles are color-coded (red for Phillips; yellow for slotted), and triangular for better gripping. And, the tips have ribs to prevent slippage. Suggested retail price: \$10.10 for the 4-piece set. Vermont American Tool Co., Dept. WD, P.O. Box 340, Lincolnton, NC 28093-0340; 704/735-7464.



**That was
then.**



**Twist,
Twist,
Twist,
Twist,
Twist,
Twist,
Twist,
Twist,
Twist,**

This is now.

Gone are the days of going round and round with old-fashioned screw-type clamps. Now, there's the QUICK-GRIP® Bar Clamp*.

With a QUICK-GRIP Bar Clamp, you can do anything you can do with a regular bar clamp, only faster. And you can do it with only one hand.

Pull the Quick-Release™ trigger with one finger and slide the bar into place. Tighten the clamp with a squeeze of the hand. That's all there is to it. Your other hand is free to hold your project in place.

The QUICK-GRIP Bar Clamp, from the makers of VISE-GRIP® Tools. It will revolutionize the way you work with clamps. See for yourself - wherever quality tools are sold.

*U.S. Patents 4,926,722; 5,005,449. Other U.S. and Foreign Patents and Designs Issued and Pending.

QUICK-GRIP®

A UNIT OF **AMERICAN TOOL**
COMPANIES, INC.

©1990/1991 American Tool Companies, Inc.  

Slide,
Click.

QUICK-GRIP®
BAR CLAMP

From the makers of VISE-GRIP® Tools.

© 1989 American Tool

Power-Tool

At the heart of every workshop is a collection of stationary power tools—the must-have machines for accurately performing such basic tasks as cutting, sanding, shaping, and drilling. In recent years, manufacturers have refined, modified, or downsized many of these machines to make them more practical for the home woodworker.

 [Print this article](#)



▲ You just can't find another drill press in the price range of the Delta Model 11-090 Radial Drill Press (\$399 list) that has a swiveling/tilting head. Because of this feature, you can do angle drilling and horizontal boring with ease. The head also slides forward and backward for various-sized workpieces. Delta, Dept. WD, 246 Alpha Dr., Pittsburgh, PA 15235; 800/438-2486 or 412/963-2400.

▶ An economically priced belt/disc sander with a port for dust collection hookup? Here's one. The Model S69 has a 9" disc, 6×48" belt, and comes with an assortment of belts and discs—all for \$219.95 plus \$30 UPS shipping. Penn State Industries, Dept. WD, 2850 Comly Rd., Philadelphia, PA 19154; 800/288-7297 or 215/676-7606.

▶ Dremel has added variable speed with digital display to its reliable 16" scrollsaw. The new Model 1695 makes between 200 and 2,000 strokes per minute for optimal cutting performance in wood, metals and plastics. Suggested retail price: \$250. Dremel, Dept. WD, 4915 21st St., Racine, WI 53406; 414/554-1390.

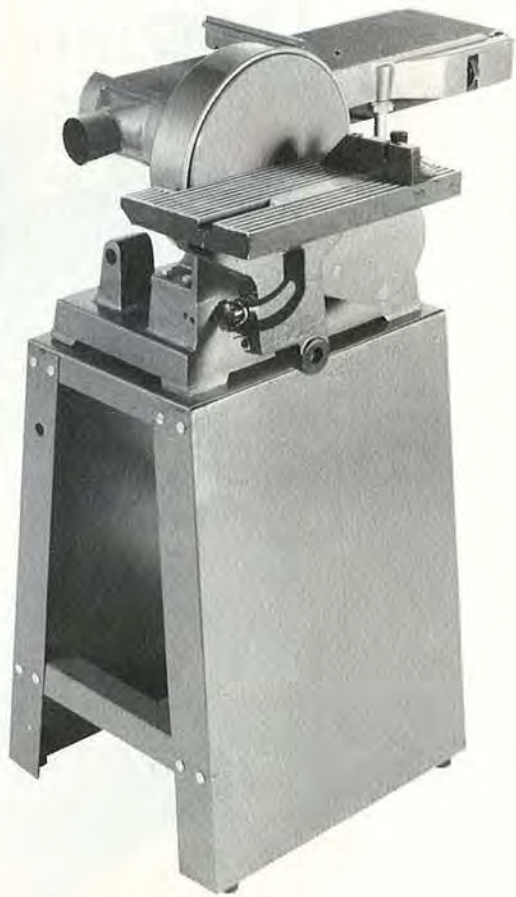

Potpourri



▶ For the ultimate in blade-changing convenience, the Makita Model 2012 12" Portable Planer has disposable, double-edged blades. With the help of a blade-holding jig, you can quickly change blades without spending a lot of time on fine adjustments. List price: \$895. Makita, Dept. WD, 14930 Northam St., La Mirada, CA 90638; 714/522-8088.



▲ The DeVilbiss "Air America" F320 3-hp Air Compressor operates on either a 120- or 240-volt circuit, has a 20-gallon tank, and never requires you to change a belt or add oil. The tools it will power include a nailer, stapler, dusting gun, paintspray gun, sandblaster, drill, and ratchet wrench. Price: \$380-\$425. DeVilbiss, Dept. WD, 213 Industrial Drive, Jackson, TN 38301; 901/423-7000.



▶ It's a tablesaw! It's a radial-arm saw! Actually, it's both. The Sawsmith 2000 looks and functions like a tablesaw, but crosscuts with the ease of a radial-arm saw. By pulling a rod on the front panel of the saw, you can pull the blade through the workpiece (with the workpiece held in place by the miter-gauge holddown). You can choose among four models with various fence and table extension combinations, ranging from \$999 to \$1,499. Shopsmith, Dept. WD, 3931 Image Drive, Dayton, OH 45414-2591; 800/543-7586 or 513/898-6070.

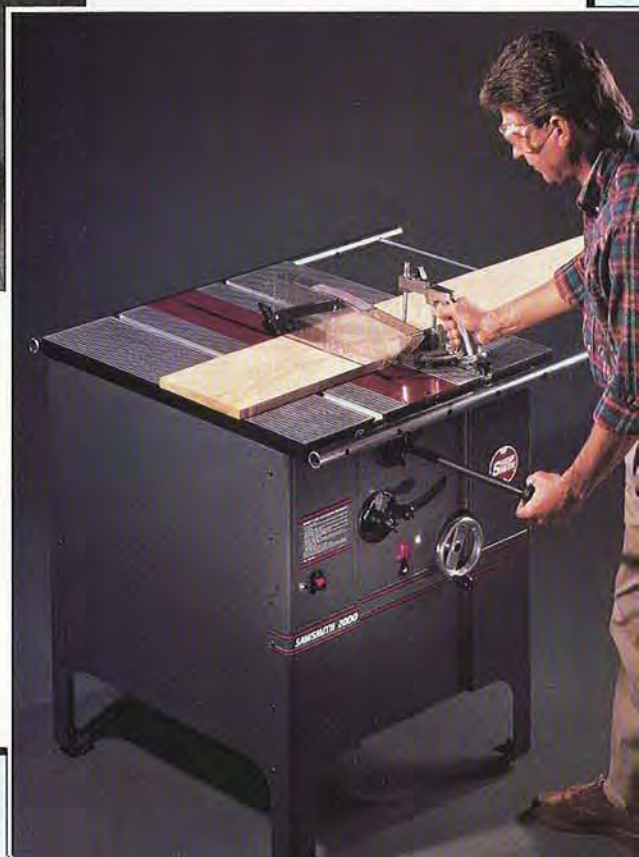

Stationary Power Tools

▼ The new Sears Craftsman 20" Contractor-Series Variable-Speed Scroll saw has several features often found only in more expensive machines. Its permanent-magnet motor varies the cutting speed from 300 to 2,000 strokes per minute, and the cast-iron table tilts 34° left and 45° right. The \$399.99 scroll saw includes a heavy-duty leg stand. Visit your local Sears store or call a Sears telecatalog center.



▲ Hitachi introduces its Model P12R Portable Planer: the most powerful and beefy machine in its class. (About \$650.) You also can purchase the planer with a 6" jointer as the model P12RA (as shown) for about \$850. Hitachi, Dept. WD, 4487-E Park Dr., Norcross, GA 30093; 404/925-1774.



▼ The Delta Model 50-179 Two-Stage Dust Collector traps heavy particles in its main tank before they can pass through the blower, allowing only fine particles through the blower and into its bag. This means less wear and tear on the blower; and little chance of sparks from nails or other metal objects striking the blower. List price: \$483. Delta, Dept. WD, 246 Alpha Dr., Pittsburgh, PA 15235; 800/438-2486 or 412/963-2400.



▶ The Ryobi BT3000 10" Precision Woodcutting System brings big-saw accuracy and features to a portable saw that's reasonably priced. Unlike other portable table-saws, the BT3000 holds a 10" blade, has a 3⁹/₁₆" cutting depth, and a sliding-miter table and precision rip fence. The new saw sells for about \$600 and also has dust-collection capabilities. An adapter kit accommodates mounting a jigsaw or router to an extension table. Ryobi, Dept. WD, 1424 Pearman Dairy Road, Anderson, SC 29625; 800/323-4615 or 803/226-6511.



▶ The Woodmaster Drum Sander promises the performance of a wide-belt sander at just a fraction of the cost. The variable-feed-rate machine is available in 26" and 38" widths with single or double drums. List price: \$2,200 to \$3,100 (discounts available). Woodmaster Tools, Dept. WD, 2908 Oak St., Kansas City, MO 64108; 800/821-6651 or 816/756-2195.



◀ For \$355 plus shipping, it's hard to find more tablesaw value than that offered in the Grizzly 10" Model G1022. The saw has a cast-iron table and extension wings, 1¹/₂-hp, totally enclosed, fan-cooled motor with belt drive, and comes with a steel stand. Grizzly Imports, Dept. WD, (east of the Mississippi river) 2406 Reach Rd., Williamsport, PA 17701; 800/523-4777 or (west of the Mississippi) P.O. Box 2069, Bellingham, WA 98227; 800/541-5537.

▼ For only \$259.95 plus \$20 UPS shipping, the XL40-2 Wood Lathe gives you everything you need to start turning. The lathe has a 16" swing and 40" between centers, five speeds, and comes with a 6" faceplate, spur center on headstock, and an eight-piece chisel set. Penn State Industries, Dept. WD, 2850 Comly Rd., Philadelphia, PA 19154; 800/288-7297 or 215/676-7606.

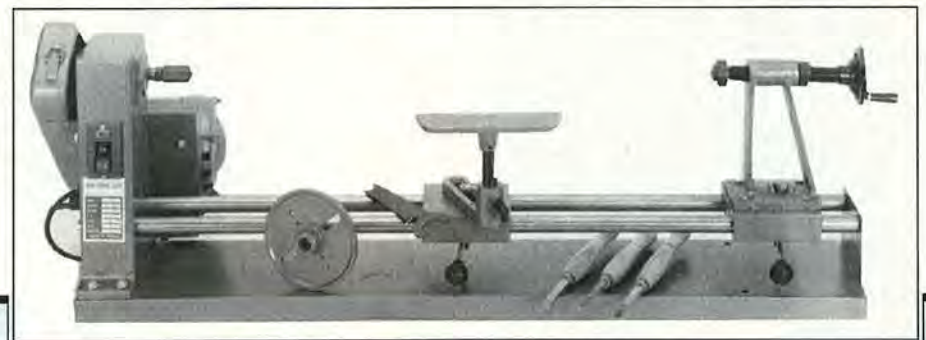

Stationary Power Tools

▼ The Jet JCS-10A Tablesaw helps you take on serious cutting tasks thanks to its double V-belt drive, precision T-square-type rip fence, and sturdy construction. The machine lists for \$1,124 and comes with a 2-year warranty. Jet, Dept. WD, P.O. Box 1477, Tacoma, WA 98401-1477; 206/383-8705.

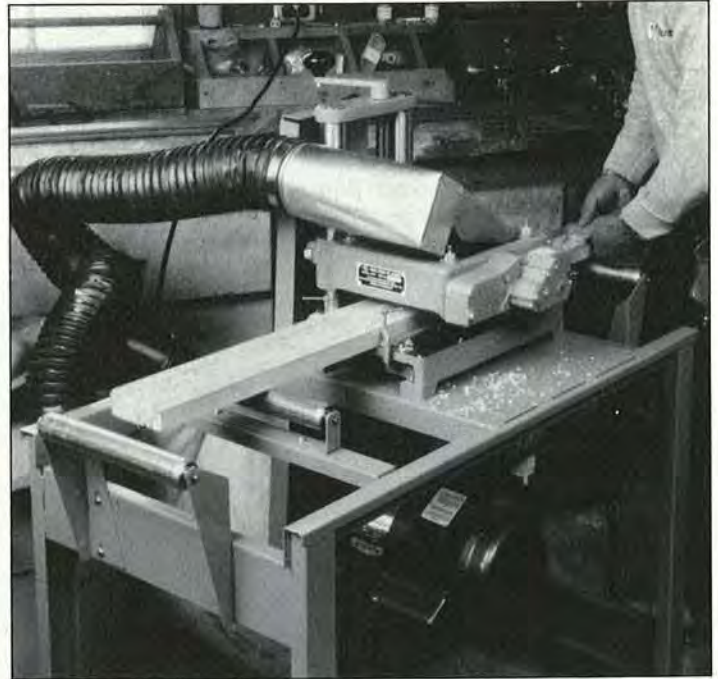

▲ Because of its open-end design, the W-7 Molder/Planer can do raised panels and curved moldings. Rock-solid components and construction assure years of reliable service. No wonder it comes with a five-year warranty. List price: \$898 for the machine; \$1,457 for the machine with 2-hp motor and stand. Williams & Hussey, Dept. WD, P.O. Box 1149, Wilton, NH 03086; 800/258-1380 or 603/654-6828.

▼ Delta has made large, heavy-duty thickness planers for years, and now they've entered the portable-planer market with the Model 22-540 12" Portable Planer (list price: \$595). The machine safely handles workpieces from 1/8" to 6" thick, and has a two-knife cutterhead that provides 16,000 cuts per minute. Delta, Dept. WD, 246 Alpha Dr., Pittsburgh, PA 15235; 800/438-2486 or 412/963-2400.

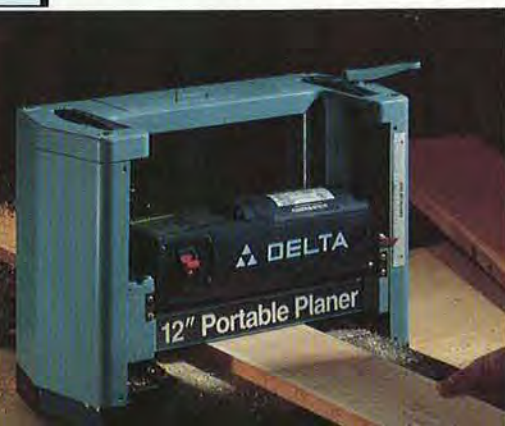
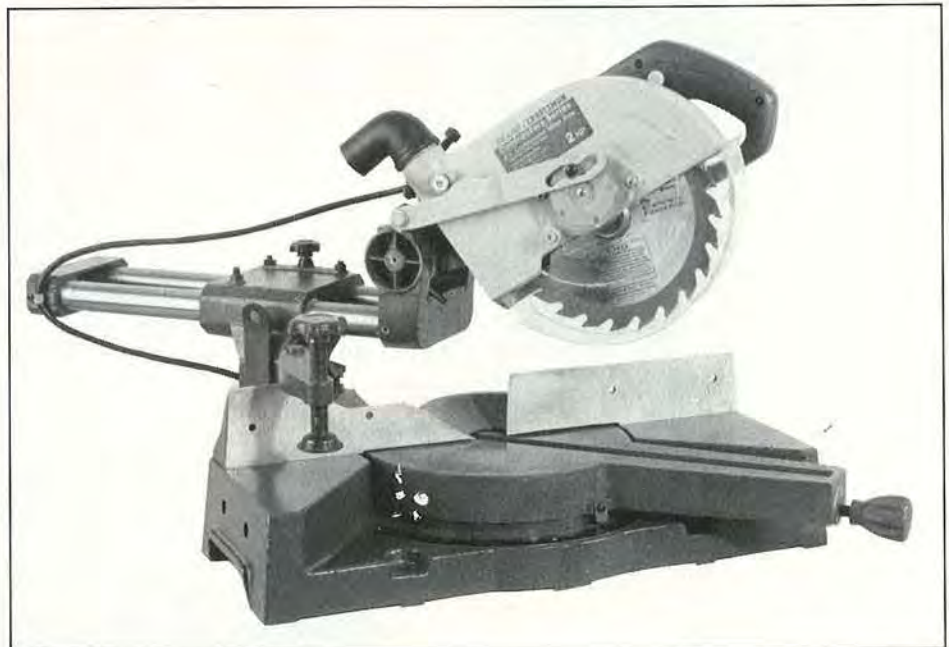

▶ The Robland X31 offers industrial-machine performance in a single, space-saving package. Because the five machines (tablesaw with sliding table, jointer, thickness planer, spindle shaper, and mortiser) are driven by three separate 3-hp motors, you can change functions quickly. The X31 sells for \$5,395. (A 90-minute instructional video is available for \$6.) Laguna Tools, Dept. WD, 2081 Laguna Canyon Rd., Laguna Beach, CA 92651; 800/234-1976 or 714/494-7006.



▶ If you like to turn small objects, one of these two lathes may be just what you're looking for. The Basic Lathe has a 20"-long bed with 5" swing and sells for \$349. The Short Bed Lathe is 7" long, has a 5" swing, and sells for \$199. A complete line of accessories is also available. Klein Design Inc., Dept. WD, 6514 115th Pl. SE, Renton, WA 98056; 206/226-5937.

▶ Sliding-compound mitersaws have become big hits with woodworkers because they combine the accuracy of a mitersaw with the cutting capacity of a radial-arm saw. The new Sears Craftsman 8¼" Contractor-Series Sliding-Compound Miter saw gives you these benefits in one of the most reasonably priced units on the market (\$399). The machine crosscuts boards up to 12" wide and 2½" thick, and has settings for crown molding and rafters. Visit your local Sears store or call a Sears telecatalog center.

▶ Because of its water reservoir, the Wen model 2900 Wet Stone Machine cools your tools as it sharpens them. The machine includes a built-in sharpening guide for scissors, knife, and drill-bit sharpening. List price: \$99.99. Wen Products, Dept. WD, 5810 Northwest Highway, Chicago, IL 60631; 800/462-3630 or 312/763-6060.



Stationary Power Tools



Delta officials had the home craftsman in mind when they designed the Model 43-505 Benchtop Router/Shaper. The machine accepts 1/2" and 3/4"-shank router bits, and 1/2" shaper cutters with an accessory spindle. Because of its speed (12,500 rpm—about half the speed of most routers) the machine works safely with large bits. The unit also features conveniently located height-adjustment and height-locking knobs. Suggested list price: \$399. Delta, Dept. WD, 246 Alpha Dr., Pittsburgh, PA 15235; 800/438-2486 or 412/963-2400.

Because it's permanently lubricated, the direct-driven Campbell Hausfeld 3.5-hp Workhorse model WL6007 Compressor needs virtually no maintenance. The Workhorse runs on 120 volts, has a 20-gallon tank, delivers up to 125 psi, comes with a 15' hose, and sells for about \$379. Campbell Hausfeld, Dept. WD, 100 Production Drive, Harrison, OH 45030; 800/634-4793.



Few tools will do as much in as little space as the Accura MK4 Benchtop Workstation by Hegner. The tool includes a two-speed, belt-driven 6" table saw, 1/4" inverted router, 5" disc sander, and 3/8" horizontal boring head. List price for the basic machine: \$1,295. Accessories include a flexible shaft and 14" lathe. Advanced Machinery Imports, Dept. WD, 2 McCullough Drive, P.O. Box 312, New Castle, DE 19720; 800/648-4264 or 302/322-2226.

Heavy-duty thickness planing is a cinch with the Jet JWP-15HO Planer. The machine has a 3-hp, 230-volt, single-phase motor that delivers its power via three V-belts. The \$1,565 (list price) machine includes a magnetic switch, 4" dust chute, and two-speed gearbox. It's backed by a 2-year warranty and local distributor support. Jet, Dept. WD, P.O. Box 1477, Tacoma, WA 98401-1477; 206/383-8705.





◀ Although small and portable, the Sears Craftsman 8 1/4" Compact Radial-arm Saw will make the same types of cuts as larger machines. Its size makes it ideal for small shops and job-site work. Price: \$299.99. Visit your local Sears store or call a Sears telecatalog center.



▲ By oscillating up and down as it rotates, the drum of the Clayton Oscillating Spindle Sander (Model No. 140) leaves virtually no sanding burns or grooves. This action also helps the drum clean itself for longer life. Unlike most other oscillating spindle Sanders, this machine can be had for less than \$1,000. A lot less: about \$625 actual price. Clayton Machine Corporation, Dept. WD, P.O. Box 513-W2, Clawson, MI 48017; 313/548-2380.

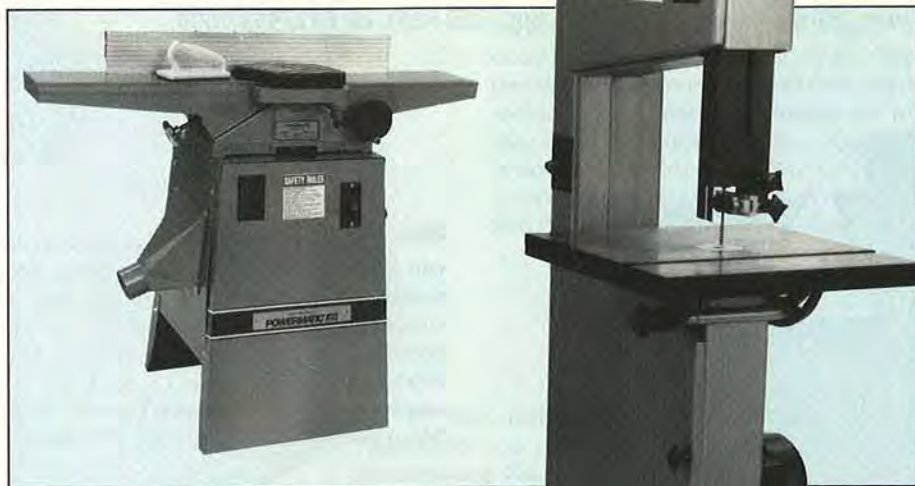

▶ Powermatic introduces two new products to its Artisan's Choice line of machines designed and priced for the home woodworker. The 14" Model 43 bandsaw has a dust-collector hook-up, 3/4-hp motor, industrial upper and lower blade guides, and a list price of \$792. The 6" Model 53 jointer lists for \$615 and has Powermatic's patented "Controlled Chip" cutterhead for reduced noise level, lower feed force, and reduced potential of kickback. Powermatic, Dept. WD, McMinnville, TN 37110; 800/248-0144 or 615/473-5551.

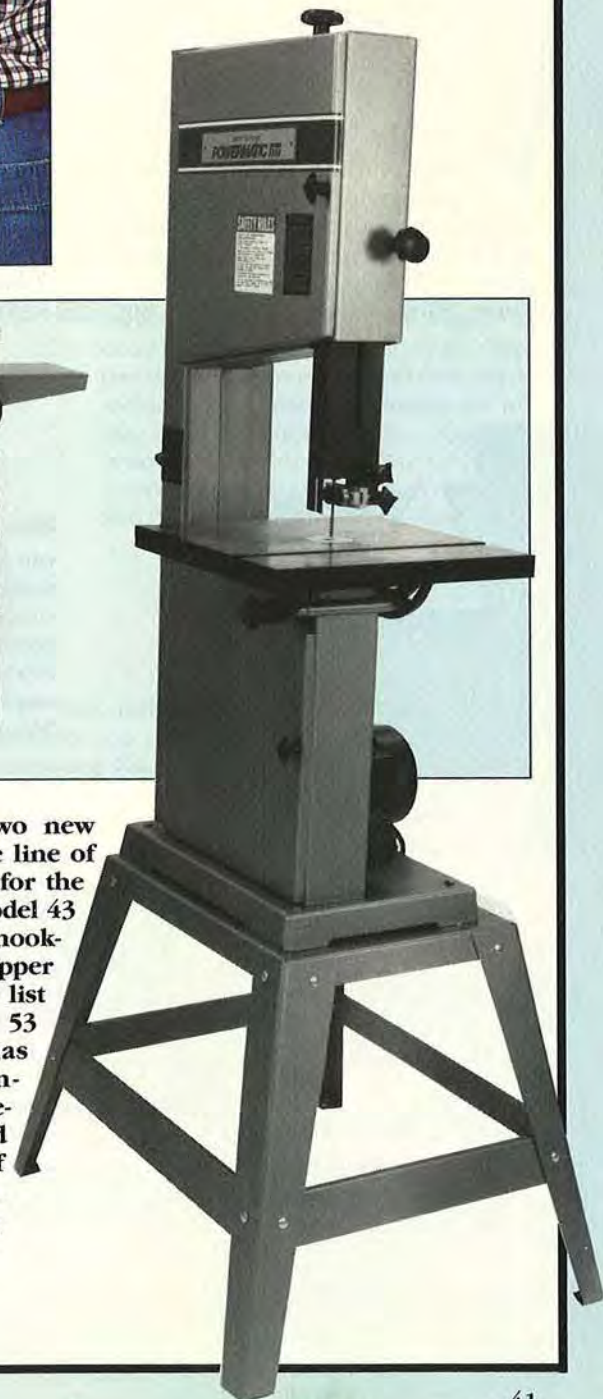

The Finish

Few product areas in woodworking have seen more changes in recent years than finishing supplies. Today's coatings are friendlier to you and the environment, protect better than ever, and promise greater convenience than yesterday's finishes. Come along and see what we mean.

 Print this article

► High-volume, low-pressure spray systems have gained steadily in popularity in recent years because they waste less finish and create less pollution. Now, Wagner's FineCoat Low Overspray Finishing System brings this technology down to affordable levels (retail price \$179-\$209). Wagner Spray Tech, Dept. WD, 1770 Fernbrook Lane, Minneapolis, MN 55447; 800/328-8251 or 612/553-7000.



► Carver Tripp has two new products in its Safe & Simple line of water-based finishing products. First, a sanding sealer (\$8.99 list for a quart) that you can use under almost any topcoat including varnish, polyurethane, and paints. Also, the company now has a water-based Danish Finish (\$5.49 list for 12 oz.) for a hand-rubbed look that's easily repairable. Parks/Carver Tripp, Dept. WD, P.O. Box 5, Somerset, MA 02726; 800/225-8543 or 508/679-5938.



► Are you looking for the toughest, most weather-resistant finish available? Lots of boatbuilders use West System 1000 Polyurethane Varnish because there's no better way to protect a surface from natural elements. Like an epoxy, the product comes in a two-part kit consisting of 1 quart of varnish and 1 pint of hardener (\$57.80 list). Requires multiple coats to be effective. Gougeon Brothers, Dept. WD, 100 Patterson Ave., Bay City, MI 48707; 517/684-7286.

Line



◀ How long will Zip-Guard Urethane Wood Finish protect your project? That depends on how you treat your workpiece, but Zip-Guard's manufacturer warrants the product not to chip, crack, craze, or peel for 4 years. Star Bronze Co., Dept. WD, 803 South Mahoning, Alliance, OH 44601; 800/321-9870.



▲ Your gray, weathered deck can look like new with an application of Osmose WoodBrite Deck Cleaner. A packet lists for \$8.59 and mixes with 2 gallons of water to cover 250-300 square feet. The product removes ground-in dirt, mildew, and algae, contains no acids, and is biodegradable. Osmose Wood Preserving, Dept. CP, P.O. Drawer O, Griffin, GA 30224; 800/522-9663 or 404/228-8434.



▼ For authenticity and convenience, few products top the Original Old World Crackle Refinishing Kit. You can choose among three antique colors: beige, rust, and gray. The finish goes on in three steps, and cleans up with water. The kit sells for \$23.95 ppd. and covers approximately 15 square feet. Paint Strokes, Dept. WD, 3519 Civic Center Drive, N. Las Vegas, NV 89030; 800/468-3779.



Finishing Products



Because it's water-based, Krylon's Clean 'n Safe Acrylic Enamel spray paint cleans up easily with water within 20 minutes of applying it. The paint, available in 10 colors in 12 oz. cans, lists for \$4.75. Krylon, Dept. WD, 6830 Cochran Rd., Solon, OH 44139; 800/832-2541 or 216/498-2300.

In response to consumer demand, Thompson's has added five new colors to its line of waterproofing exterior stains: Natural Redwood, Bisque, and Rock Beige (semitransparent), and two solid stain colors (Chamois and Bisque). One- and five-gallon containers retail for \$14.99 and \$64, respectively. Call 800/367-6297.



Make no bones about it. Breathing the fumes of solvent-based finishes can be harmful to your health. The Series 300 Comfort-Air Respirator with 7-in-1 Cartridge will protect you from paint, lacquer, enamel, and other mists, as well as dusts, fumes, radon, organic vapors, and pesticides. About \$25-\$30. U.S. Safety, Dept. WD, 8101 Lenexa Drive, Lenexa, KS 66215; 913/599-5555.



A nonflammable, nonpolluting paintbrush cleaner that doesn't evaporate? You bet! Savogran's CleanSafer is user-friendly because it contains no harsh solvents and removes both oil-based and latex paints. Suggested retail price: \$6.56 per pint. Savogran, Dept. WD, P.O. Box 130, Norwood, MA 02062; 800/225-9872.

Dad's Easy Spray Paint, Stain, & Varnish Remover has a trigger spray attachment for added convenience. And, it's nonflammable and washes off with water. Postage-paid prices: \$11 per quart and \$28 per gallon from Sansher Corporation, Dept. WD, 8005 N. Clinton St., Fort Wayne, IN 46825; 219/484-2000.

Before today's man-made finishes came along, craftsmen relied on shellac to enhance and protect their wood projects. Today, William Zinsser & Co. still offers this time-honored finish in the form of Bulls Eye Shellac Sealer & Finish. You can choose between a traditional amber-colored product and a non-yellowing clear formula (list price: \$25 per gallon). William Zinsser & Co., Dept. WD, 39 Belmont Dr., Somerset, NJ 08875; 908/469-8100.





▶ As easily as signing your name, you can paint fine or thick lines on your projects with an Auto-graphics Pen. The pen dispenses a fast-dry lacquer in a wide range of glossy and metallic primary shades plus gold and silver metallics and fluorescent orange. Each pen contains 1/3 oz. and sells for about \$5.75. Plasti-Kote, Dept. WD, P.O. Box 708, Medina, OH 44258; 800/431-5928 or 216/725-4511.



▶ You know how hard it is to remove stains, paints, and other finishes from your hands. By applying a small amount of PR88 on your hands before beginning your work, you can protect your skin from these substances as well as many solvents. After you're done, just rinse your hands clean. A liter of the product (\$28 ppd.) will last through about 600 applications. Tech Rep & Associates, Dept. WD, P.O. Box 12389, Beaumont, TX 77726; 409/838-1386.



▶ Unlike most other water-based finishes, McCloskey's new Heirloom finishes go on clear rather than milky. The line includes sanding sealer, acrylic finish, polyurethane finish, and wood stain in 12 colors, including two bases for producing more than 20 designer tints. Suggested list prices for gallon containers: sanding sealer, \$23.69; acrylic finish, \$37.99; polyurethane finish, \$44.99; and stain, \$25.79. McCloskey; 800/767-2532.

Finishing Products



Hydrocote Clear Polyshield has the same benefits as other water-based finishes (it's nontoxic, dries quickly, and cleans up with soap and water), but boasts additional benefits. The premium-quality, non-yellowing finish is appropriate for exterior use and also contains UV stabilizers. Price: \$20.95 per quart. Hydrocote, Dept. WD, P.O. Box 160, Tennent, NJ 07763; 800/229-4937 or 908/257-4344.

Fleck Stone offers you the look of granite, the feel of stone, and the ease of spray paint. The two-unit kit contains aerosol basecoat in 12 colors plus a clear protective finish. List price: \$13.85 for 12 oz. of basecoat and 6 oz. of clear finish. Plasti-Kote, Dept. WD, P.O. Box 708, Medina, OH 44258; 800/431-5928 or 216/725-4511.

In keeping with today's design schemes, Benjamin Moore's line of Interior Wood Finishes has expanded with 11 designer's shades in colors such as Lilac Gray, Nectar Rose, Monet Blue, and Pink Blush (see samples at left). Suggested retail: \$21.15 per gallon. Benjamin Moore & Co., Dept. WD, 51 Chestnut Ridge Rd., Montvale, NJ 07645; 201/573-9600.

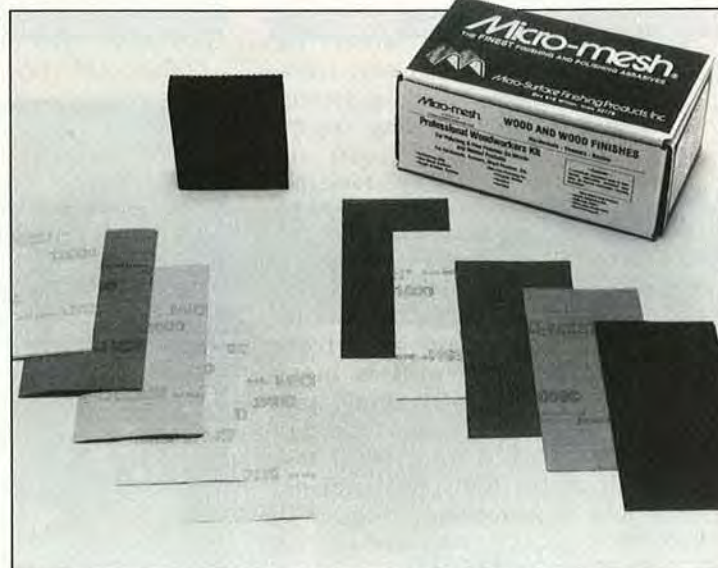

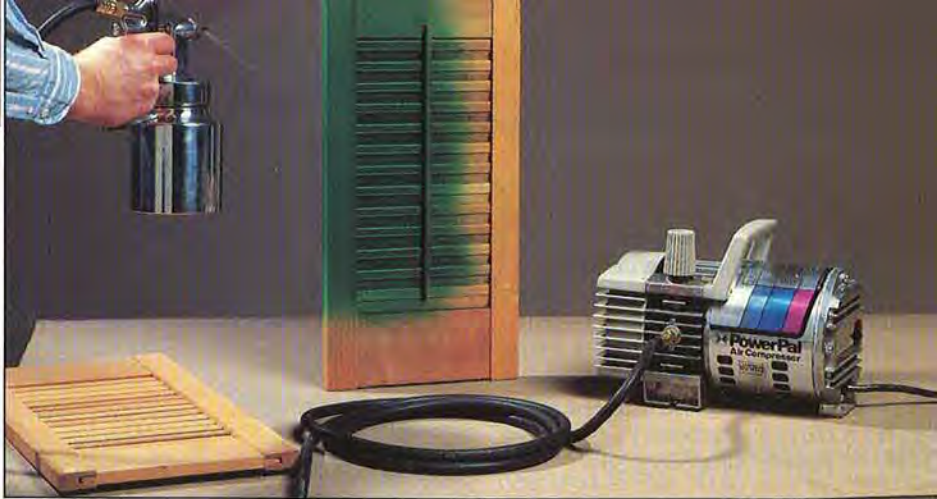

▲ Here's an air-fed spray gun that you can buy for the price of a few good brushes. The Campbell Hausfeld Model DH4200 Spray Gun sells for about \$39 and easily handles all finishes from latex paints to quick-drying lacquers. It works with any 3/4-or-more-hp compressor. Campbell Hausfeld, Dept. WD, 100 Production Drive, Harrison, OH 45030; 800/634-4793.

▼ Here's a way to remove dried latex paint drips and spatters, glue, caulking, grease, and tape adhesives. Dad's Drip Strip (\$5.49 ppd. for 8 oz.) will not affect oil-based finishes. Sansher Corporation, Dept. WD, 8005 N. Clinton St., Fort Wayne, IN 46825; 219/484-2000.



◀ Micro-mesh abrasives have long been used by airlines to restore and polish airplane windows to optical clarity. Now, these products can do the same thing for the finishes on your woodworking projects. The Micro-mesh Professional Woodworkers Kit (\$38.50 ppd.) contains two pieces of abrasive in each of nine grades ranging from 1,500 to 12,000 grit. The product outlasts conventional abrasives by 8 to 15 times. Micro-Surface Finishing Products, Dept. WD, P.O. Box 818, Wilton, IA 52778; 319/732-3240.

▶ Duffy's Stain Samplers take the guesswork out of choosing a stain because you can purchase one of six colors for a suggested retail price of only 44 cents. Then, you can test the stain under actual conditions (even mix them). After making up your mind, you can buy the stain in larger quantities. Klean-Strip, Dept. WD, P.O. Box 1879, Memphis, TN 38101.



▶ If you would like your project to look like an antique, but don't want to wait years for it to happen, Hallmark Home Decor Antiquing Gel can help out. The nontoxic, water-based product does not drip or run, and lists for \$6.98 per pint. Delta Technical Coatings, Dept. WD, 2550 Pellissier Place, Whittier, CA 90601; 800/423-4135; 800/553-8940 (in Calif.) or 213/686-0678.

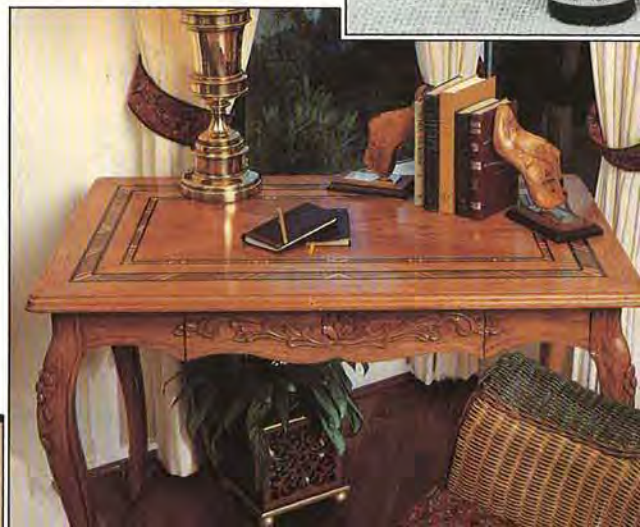

Finishing Products



◀ With Minwax Pastels Wood Stain, you no longer have to mix stains or water down paints to get the pastel colors you need. (Price: \$9.99 suggested retail per quart.) Minwax,

Tips on Wood Finishing, Dept. WD, P.O. Box 426, Little Falls, NJ 07424; 201/307-4800.

▼ Applying a new finish to a previously finished surface can result in tiny pits known as "fish eyes," even if you've thoroughly stripped and sanded the surface. What happened? The surface is still contaminated with silicones left behind by polish that was used on the piece months or years ago. To prevent "fish eye," you need only add a drop of Fish Eye Destroyer to your varnish or lacquer before you apply it. One ounce goes a long way and costs \$5.95 ppd. Constantine's, Dept. WD, 2054P Eastchester Rd., Bronx, NY 10461; 800/223-8087 or 212/792-1600.



▶ Because it contains Teflon, Rust-Oleum's Wood Saver stands up to the elements like no other paint. Available in quantities up to 1 gallon and in aerosol cans (suggested retail price of \$3.99-\$4.29 for spray cans). Rust-Oleum, Dept. WD, 11 Hawthorn Parkway, Vernon Hills, IL 60061; 800/323-3584.



▶ For exterior surfaces such as fencing, siding, and decks, the folks at BossWorks offer WoodBoss Clear Acrylic Latex Wood Sealant, a product that provides weather protection and a 2-year warranty. The water-based finish is friendly to both you and the environment. About \$15-\$18 for a 1-gallon pail. BossWorks, Dept. WD, 889 Valley Dr., Shakopee, MN 55379; 612/496-4297.

▶ If you want to get serious about stripping furniture, the Minuteman Mini-Flo Furniture Stripping System gives you professional results at a price (\$1,495) below many recirculating flow-on stripping systems. Minuteman, Dept. WD, 115 N. Monroe St., P.O. Box 8, Waterloo, WI 53594; 800/733-1776 or 414/478-2001.





▼ There's no quicker way to a crackled finish than with Cracklin' Finish, an aerosol kit consisting of a 12 oz. can of basecoat and 12 oz. of topcoat. The product lists for \$12.95 and comes in six color combinations. Plasti-Kote, Dept. WD, P.O. Box 708, Medina, OH 44258; 800/431-5928 or 216/725-4511.

▼ With Hallmark Home Decor Pickling Gel, you can conveniently add a pickled look to your projects in six transparent pastels and one neutral color. List price: \$6.98 per pint (other sizes available). Delta Technical Coatings, Dept. WD, 2550 Pellissier Place, Whittier, CA 90601; 800/423-4135; 800/553-8940 (in Calif.) or 213/686-0678.



▶ Water-based finishes speed you along because of their fast drying times. Now, Hydrocote One-Step Finish (suggested retail: \$11.06 per quart) makes water-based finishing even faster. The product combines a wood stain (available in six tones) with a polyurethane finish. Hydrocote, Dept. WD, P.O. Box 160, Tennent, NJ 07763; 800/229-4937 or 908/257-4344.

Power You Can

What's new in portable power tools? Everything! Manufacturers continue to add features formerly reserved for top-of-the-line industrial tools to their consumer-priced tools. And, more and more of these machines have such niceties as electronic speed control, dust collection, cordless capability, and other innovations.

 Print this article

▼ A lot of us would like to try plate joining, but balk at the price of most plate joiners. The Skil Model 1605:02 sells for under \$200, but offers features such as a three-position depth stop, 12-tooth carbide blade, dust bag, plate-joining guidebook, supply of biscuits, and carrying case. Skil, Dept. WD, 4300 West Peterson Ave., Chicago, IL 60646; 312/286-7330.

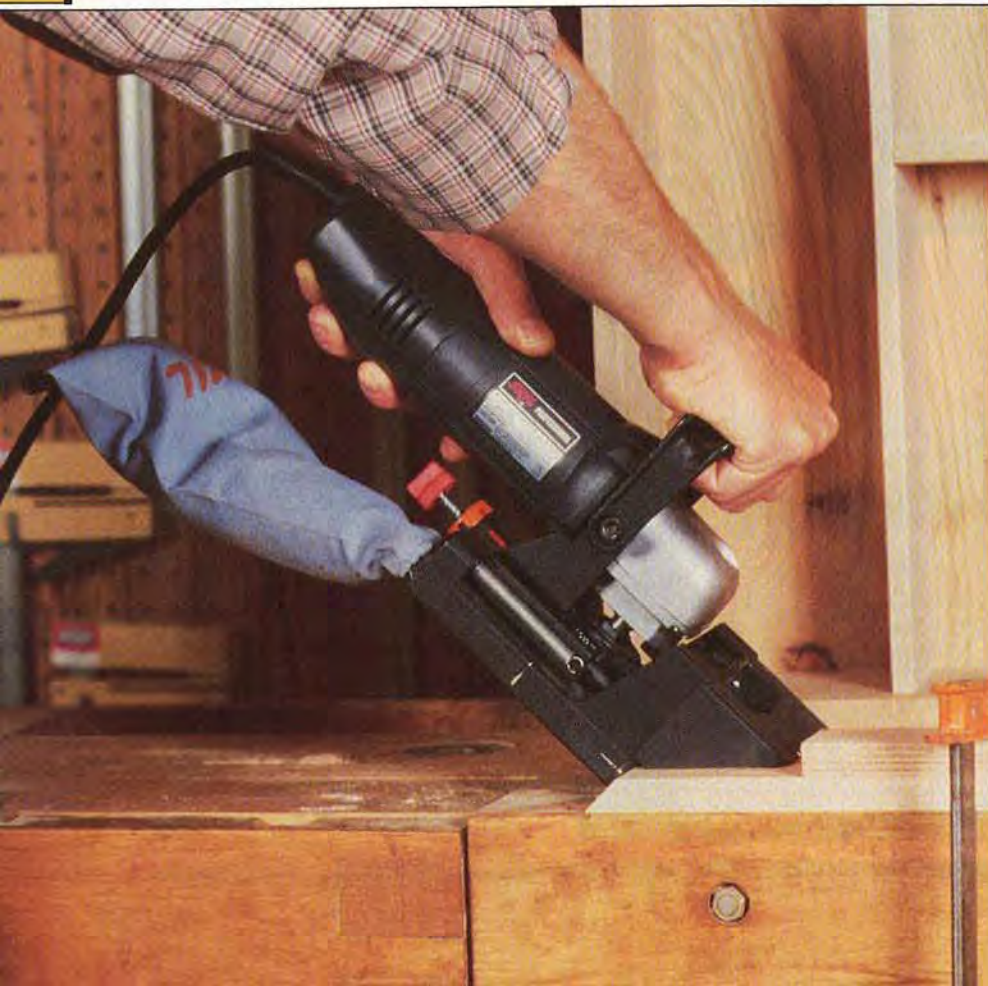

▼ The Dremel MiniMite Model 750 compact cordless rotary tool lives up to its name—it weighs only 10 ounces but has enough power to handle sanding, drilling, and detailing tasks. The \$35 unit recharges in about three hours. Extra battery packs available. Dremel, Dept. WD, 4915 21st St., Racine, WI 53406; 414/554-1390.

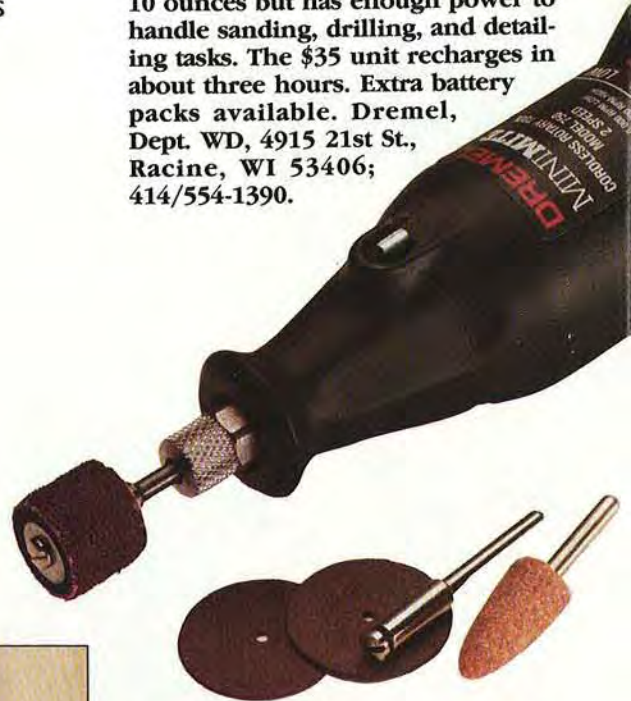

▼ If you're looking at chainsaws, but don't need a heavy-duty lumberjack model, listen up. Safety features, noise reduction, solid-state ignition, and the power of a 2.0-cubic-inch gas engine are just some of the highlights of the economically priced (\$209.99 list) Homelite Model 200 chainsaw. You can order the unit with 10", 12", 14", or 16" guide bars. Homelite, Dept. WD, 14401 Carowinds Blvd., P.O. Box 7047, Charlotte, NC 28273; 800/242-4672 or 704/588-3200.



Hold Onto



► It used to be that dual-action (rotation and eccentric orbit) sanders were available only in air-driven models. Enter the Bosch Model 3283DVS 5" Random-Orbit Sander/Polisher. It runs on electric current, and it also has through-the-pad dust collection and hook-and-loop material on its pad for quick abrasive changes. List price: \$169. See your Yellow Pages for the location of your nearest Bosch dealer.

► With the Black & Decker Model 2033 Deckgun electric screwdriver you can affordably take advantage of what professional builders have known for years: nothing holds like a screw, especially when you're working with pressure-treated lumber and drywall. The tool sells for less than \$100 and delivers 115 inch-pounds of torque. Black & Decker, Dept. WD, 10 N. Park Dr., P.O. Box 798, Hunt Valley, MD 21030; 800/762-6672 or 301/527-7000.



Portable Power Tools



How do you make an already-great router even better? In the case of the Elu Model 3338 2¼-hp electronic plunge router, Black & Decker has added larger handles for better control, a new fine adjuster on the guide fence, and a spindle lock. The router still features full-wave electronic control for soft starts and variable speeds from 8,000 to 20,000 rpm. Black & Decker, Dept. WD, 10 N. Park Drive, Hunt Valley, MD 21030; 800/762-6672.

If you go through a lot of brads in your work, here's a tool that will save you loads of time. The Model C3030 pneumatic nailer weighs only 2.6 pounds, and holds 100 ⅜" to 1⅓/16" 18-gauge brad nails. The tool sells for \$99.95 plus shipping. Cascade Tools Inc., Dept. WD, P.O. Box 3110, Bellingham, WA 98227; 800/235-0272 or 206/647-1059.



The Metabo Model AD500VS electric angle drill is indispensable for any tight-quarters work. If you turn a lot of bowls, you'll find it helpful for smoothing inside walls. The AD500VS (list price: \$278) weighs only 4 pounds, yet has a 5.2-amp motor. Metabo, Dept. WD, 1231 Wilson Drive, P.O. Box 2287, West Chester, PA 19380; 215/436-5900.

It's a shop vacuum! It's a dust collector! Actually, it's a little of both. Like some dust collectors, the Toolmate Shop Cleaner comes with a 12'×4" hose, and has a two-stage filter system that traps heavier particles in the tank and lighter particles in a cloth bag. Like shop vacuums, the Toolmate is portable and has a 1.25-hp (peak) universal motor. List price: \$369.95. Shop-Vac Corporation, Dept. WD, 2323 Reach Road, P.O. Box 3307, Williamsport, PA 17701; 717/326-3557.

▼ Few sanding machines help you true large surfaces with greater control and better results than an air-powered straightline sander. Like hand sanding, the straight back-and-forth motion of the machine does not leave tattletale scratches. The Campbell Hausfeld Model TL1016 sells for about \$65 and requires a compressor of at least 3 hp. Campbell Hausfeld, Dept. WD, 100 Production Drive, Harrison, OH 45030; 800/634-4793.

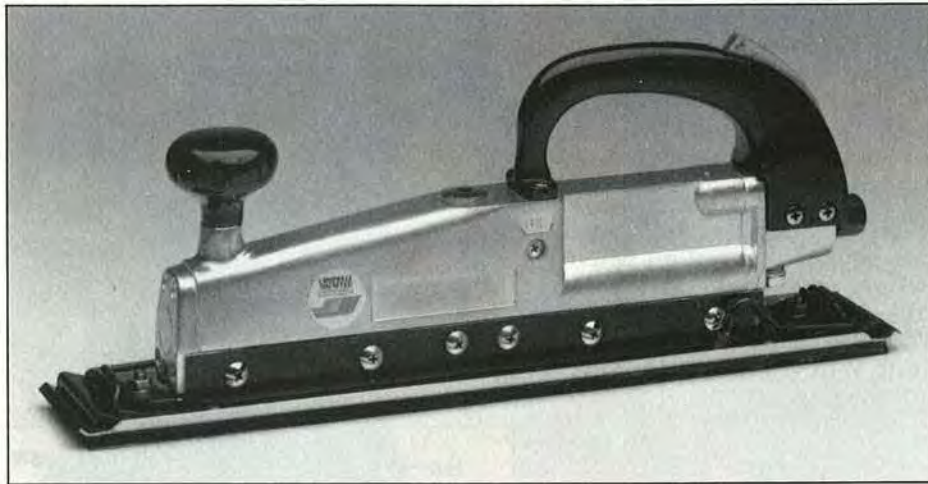

▲ Ryobi's new random-orbit sander has a removable front grip for maneuverability in tight areas and a plastic dust compartment for unobstructed work and easy dust disposal. Accessories help you polish furniture and automobiles to a high gloss. Price: about \$80. Ryobi, Dept. WD, 1424 Pearman Dairy Road, Anderson, SC 29625; 800/323-4615 or 803/226-6511.



▲ Traditionally, installing drywall with an electric screwdriver has been a noisy job—one that deserves ear protection. Now, Hitachi has come out with an electric screwdriver with a unique air-flow design that reduces noise (it still makes sense to wear ear protection, even with this product). The full-featured Model W6V2 has a list price of \$145. Hitachi, Dept. WD, 4487-E Park Drive, Norcross, GA 30093; 404/925-1774.

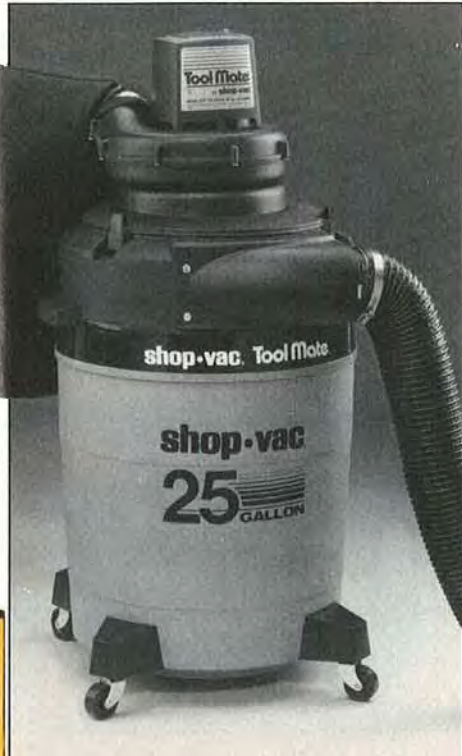

Portable Power Tools

▶ Black & Decker's new Cyclone cordless driver/drill has a unique clutching system that helps you drive small screws without stripping their heads, and also helps you drive screws through inconsistent materials such as wood with knots. The patented "Versa-Clutch" design has thrust bearings that increase torque when you apply additional forward pressure to the drill. After using the drill for a short time, you develop a finesse for driving screws that's not possible with other models. Also, the tool has separate controls for clutch

setting and switching from driving to drilling modes. So, you don't lose your clutch setting when you switch to drilling. Price range: \$169-\$189. Black & Decker, Dept. WD, 10 N. Park Dr., P.O. Box 798, Hunt Valley, MD 21030; 800/762-6672 or 301/527-7000.

▶ For tasks as varied as assembling craft items, reupholstering furniture, and installing insulation, an air stapler is just the tool you need. The Campbell Hausfeld Model TL1012 sells for about \$59 and includes 200 ¼" staples and 200 ½" staples. It operates with any ½-hp-or-larger air compressor. Campbell Hausfeld, Dept. WD, 100 Production Drive, Harrison, OH 45030; 800/634-4793.

▶ Although similar in function to a palm sander, a ½-sheet finish sander helps you work faster because of its larger sanding pad. The Metabo Model SR 282 (list price: \$202) has a dust-collection system that removes up to 90 percent of the sawdust particles. Metabo, Dept. WD, 1231 Wilson Drive, P.O. Box 2287, West Chester, PA 19380; 215/436-5900.



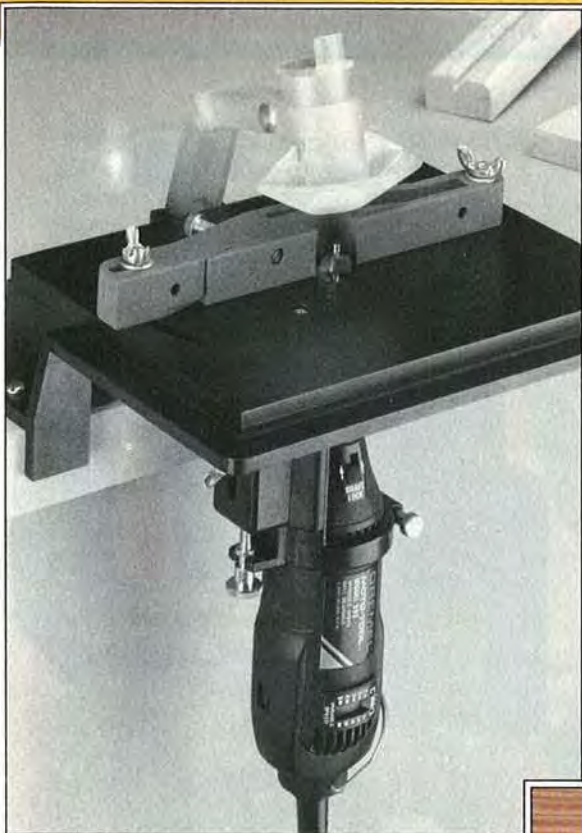

▲ If you already own a Dremel Moto-Tool, here's a new accessory that will increase its usefulness. The Model 231 Shaper/Router Table quickly converts the rotary tool into a bench-mounted wood router. You can use all recent Moto-Tools including models 245, 250, 270, 275, 280, 285, 370, 380, 395, and Freewheeler Model 850. List price: \$39. Dremel, Dept. WD, 4915 21st St., Racine, WI 53406; 414/554-1390.

▶ Like a nail gun, the Model LPN672K Air Palm Nailer from Power Tool Specialists helps you quickly and effortlessly drive nails without a hammer. Unlike a nail gun, this air-powered tool works with common nails—not expensive stick or coil nails. All you need do is position the nail, place the air palm nailer over it, and the tool automatically drives the nail. No switch or trigger necessary. Price: about \$99. Power Tool Specialists, Dept. WD, 3 Craftsman Road, East Windsor, CT 06088; 800/243-5114 or 203/654-1761.



▲ Power planers such as the Makita Model 1900BW perform just as well as a hand plane for many tasks, but without a drop of perspiration on your part. This Makita unit has two 3/4"-wide blades that change easily for precise blade adjustment. A unique center V-groove in the front sole plate helps you make easy chamfer cuts. List price: \$217. Makita, Dept. WD, 14930 Northam St., La Mirada, CA 90638; 714/522-8088.

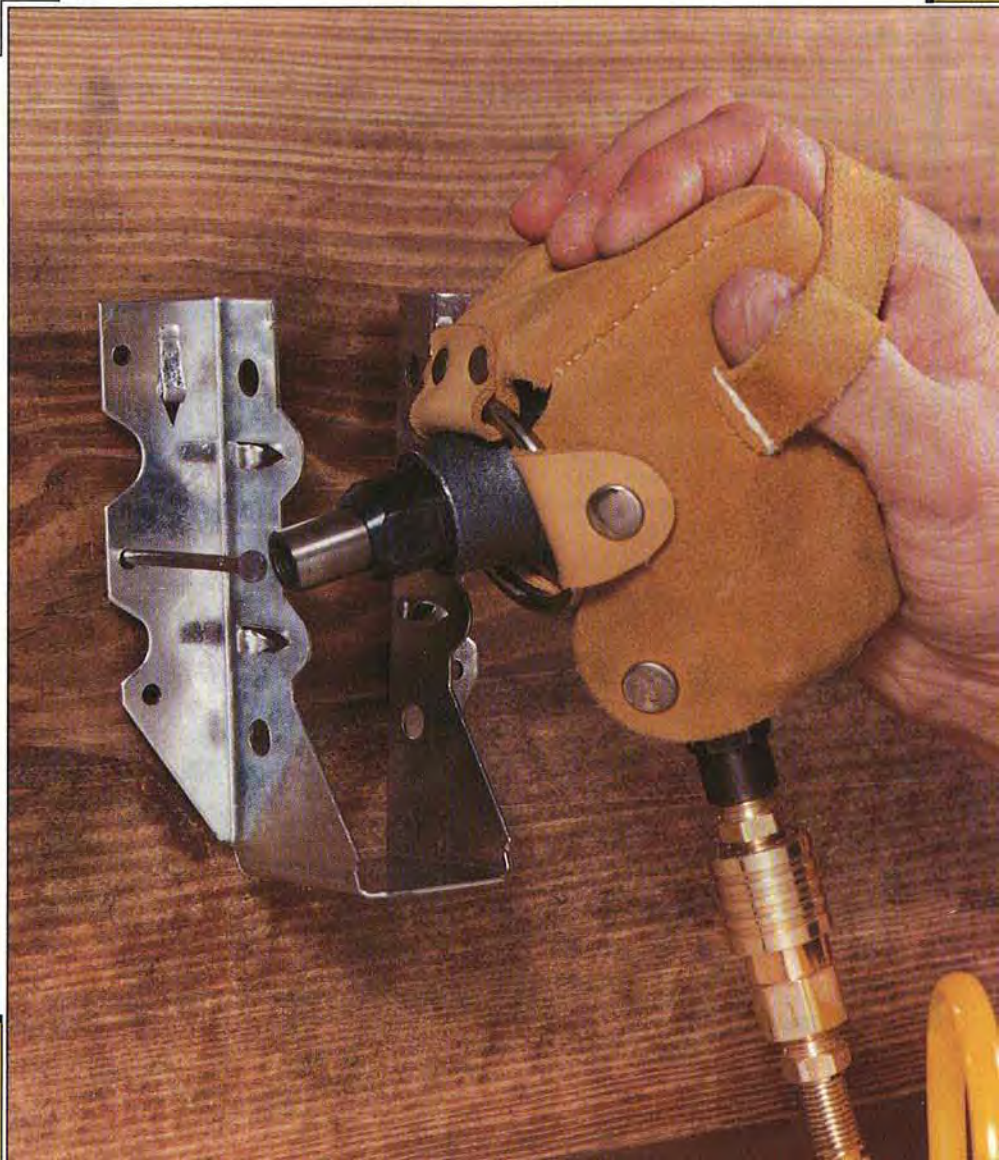

Portable Power Tools

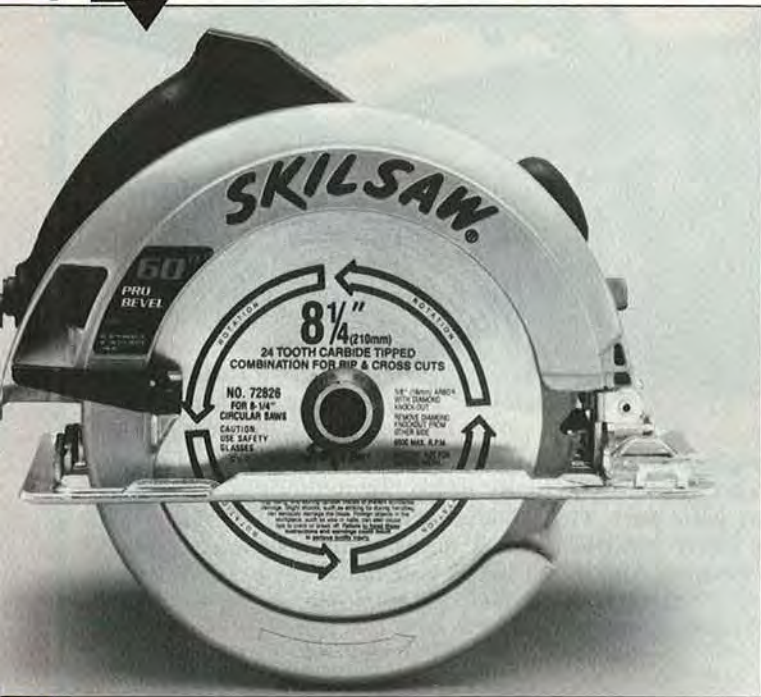

▲ The new Skil Model 5660 portable circular saw has all the features and reliability that craftsmen have come to expect from Skil saws, but now has one feature unique in the marketplace. A Pro Bevel depth bracket allows you to set cuts for up to 60° in one pass—an important feature for many roof-framing applications. Price: about \$200. Skil, Dept. WD, 4300 West Peterson Ave., Chicago, IL 60646; 312/286-7330.

▼ AEG Power Tools' high-tech 3×21" Model HBSE 75S portable belt sander features in-line design, variable speed (490 to 1,040 feet per minute), and a state-of-the-art dust-collection system. It comes standard with a set of supports for holding the machine upside down on your bench for stationary sanding. An optional sanding frame greatly aids the truing and smoothing of large surfaces. List price: \$279. AEG Power Tool Corp., Dept. WD, P.O. Box 6003, Three Shaw's Cove, New London, CT 06320-1777; 800/243-0870 or 203/447-4600.



◀ If you're looking for a powerful plunge router at an affordable price, you've come to the right place. The Ryobi RE600 electronic 3-hp plunge router has variable speed and maintains constant speed and torque. Price: about \$220. Ryobi, Dept. WD, 1424 Pearman Dairy Road, Anderson, SC 29625; 800/323-4615 or 803/226-6511.

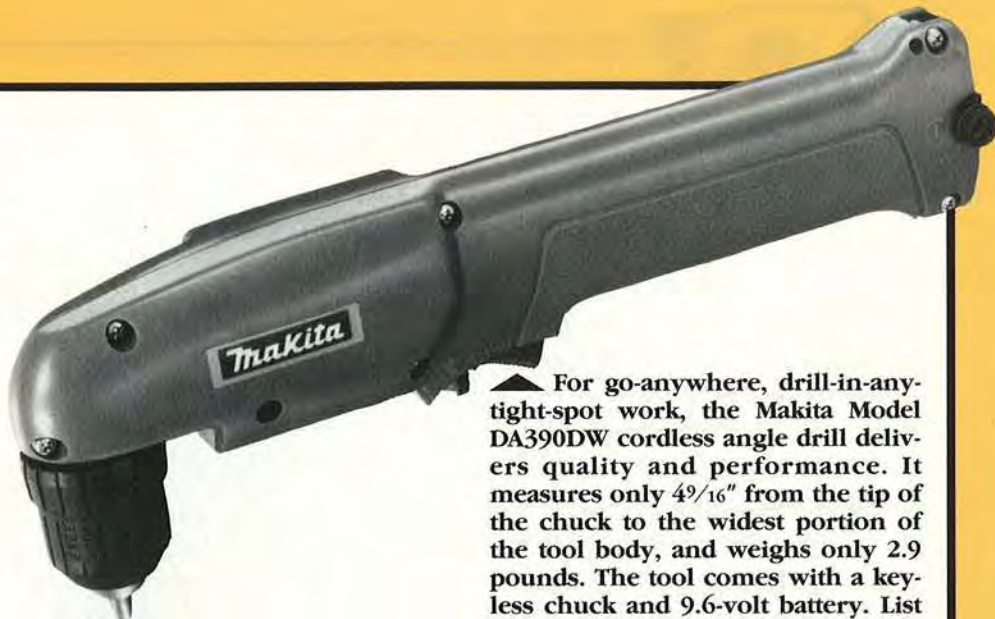

▲ For go-anywhere, drill-in-any-tight-spot work, the Makita Model DA390DW cordless angle drill delivers quality and performance. It measures only 4⁹/₁₆" from the tip of the chuck to the widest portion of the tool body, and weighs only 2.9 pounds. The tool comes with a keyless chuck and 9.6-volt battery. List price: \$278. Makita, Dept. WD, 14930 Northam St., La Mirada, CA 90638; 714/522-8088.

▼ There's nothing like a hammerdrill for quickly boring into concrete, but up until now these machines have been expensive for the do-it-yourselfer. Black & Decker engineers have changed all of that by designing a model that sells for less than \$80. The Model 7197 Blockbuster Hammerdrill adjusts from 0-43,000 beats per minute and 0-2,700 rpm. Black & Decker, Dept. WD, 10 N. Park Dr., P.O. Box 798, Hunt Valley, MD 21030; 800/762-6672 or 301/527-7000.

▼ Porter-Cable's Magnequench cordless drill has always had plenty of muscle thanks to a motor with rare-earth magnets. Now, the company has improved this tool by adding a second, higher speed range (0-1,000 rpm) and a keyless chuck. The model 9853 comes with a metal carrying case (\$270 list price). Porter-Cable, Dept. WD, 4825 Highway 45 North, P.O. Box 2468, Jackson, TN 38302; 901/668-8600.

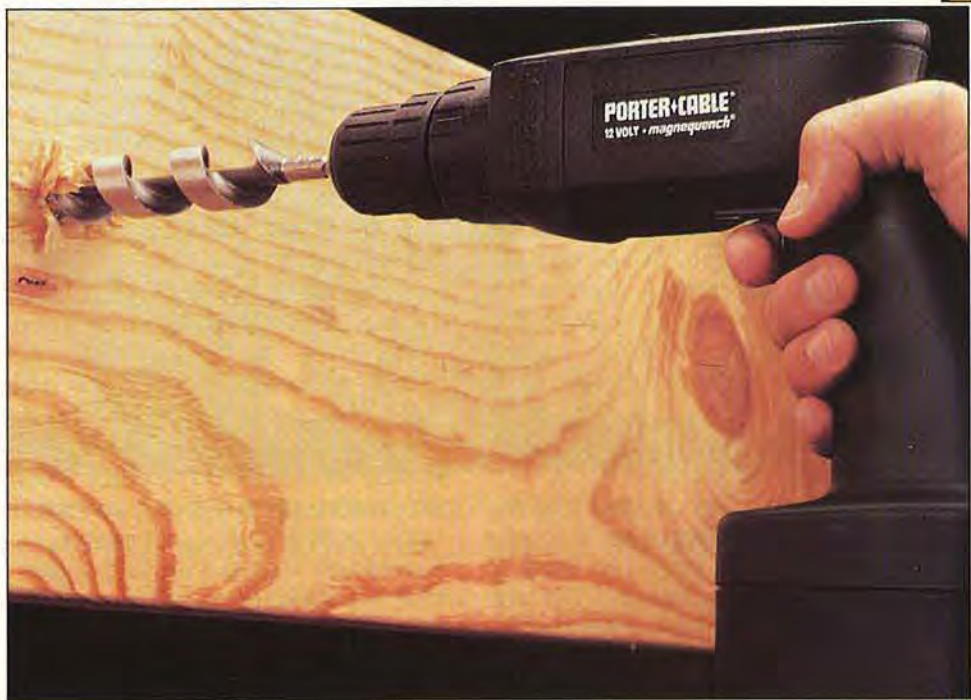

Power Tools

WHAT'S THE DIFFERENCE BETWEEN CONSUMER AND PROFESSIONAL

 Print this article

Most people know that tool manufacturers produce more than one line of a product for varying consumer needs. What they may not realize is how these tools differ in their manufacture, and what it is that makes one drill, for example, cost \$35 and another "similar" one cost \$135. We explain some of the points of difference here.

Design. The professional power tool is designed to be more powerful, last longer, and perform better under continual use than consumer models. For occasional projects, you may prefer a less expensive consumer tool.

Electrical cords. On most consumer tools, the electrical cord is 6' long or less. With the professional models, 8' and 10' cords are the norm. With this length of cord, you don't have to use an extension cord in most situations.

Cord materials vary, too. With tools designed for professionals who may have to work outside, it's important for the cord to remain flexible during cold weather. To protect the tools, natural rubber or high-cost elastomer jackets are used. Less costly cords are sheathed with polyvinyl chloride (PVC) material.

In addition, on the pro tool the cord protector leading into the tool is separate from the cord to facilitate replacement. On the consumer tool, the protectors are molded onto the cord.

Switches. Dust and frequent usage are the enemies of tool switches. Since professional tools are subjected to more of both,

switches need to be heavy duty and protected from dust.

Motors. Professional-quality tools have motors designed to generate more power and sustain overloading for longer periods than consumer tools. At the same time they must be light enough for tradespeople to use for a long time. To guard against short-circuiting at high temperatures and speeds, manufacturers coat the windings of quality motors with epoxy.

More expensive tools have copper windings rather than aluminum ones because, while copper costs more, it makes the motor more powerful.

Precise positioning of the carbon brushes, which transfer electricity from the electrical outlet to the motor, also sets professional tools apart from consumer tools. On the former, the brushes are held by close-tolerance brass holders rather than by the high-impact plastic ones on the latter.

Another difference is the type of bearings used. Generally, consumer tools have sleeve bearings. For pro tools, manufacturers use better-quality ball bearings to a greater extent to reduce the amount of lateral movement and vibration.

Gears. Often, a heavy-duty tool has wrought-steel gears, which are heat-treated to harden the metal. With some consumer tools, powdered-metal gears are used because they're less expensive.

Housings. Unless you know plastics, it's difficult to tell the difference between the materials used on pro tools and their consumer counterparts. Supertough nylon often sheathes the former, and consumer tools have a less durable plastic covering.



Metal housings differ, too. The professional tool has mating surfaces that have been machined to fit against the motor housing. The consumer model is die-cast with minimal machining.

Assembly. The major components of pro tools interlock with one another. With consumer tools, the components often are held together clamshell-style with one set of screws.

Safety. No matter which type of equipment you buy there are certain maintenance procedures you'll want to follow for safety as well as extended tool life.

All electrical power cables should be in good repair, without frays, breaks or loose plugs. If your workshop outlets aren't the three-prong type, always use a grounding plug adaptor.

If tools aren't self-lubricating, follow the instructions in the manual to lubricate them at regular intervals.

And keep blades sharp. Dull blades can be dangerous as well as ruinous to work. ♣

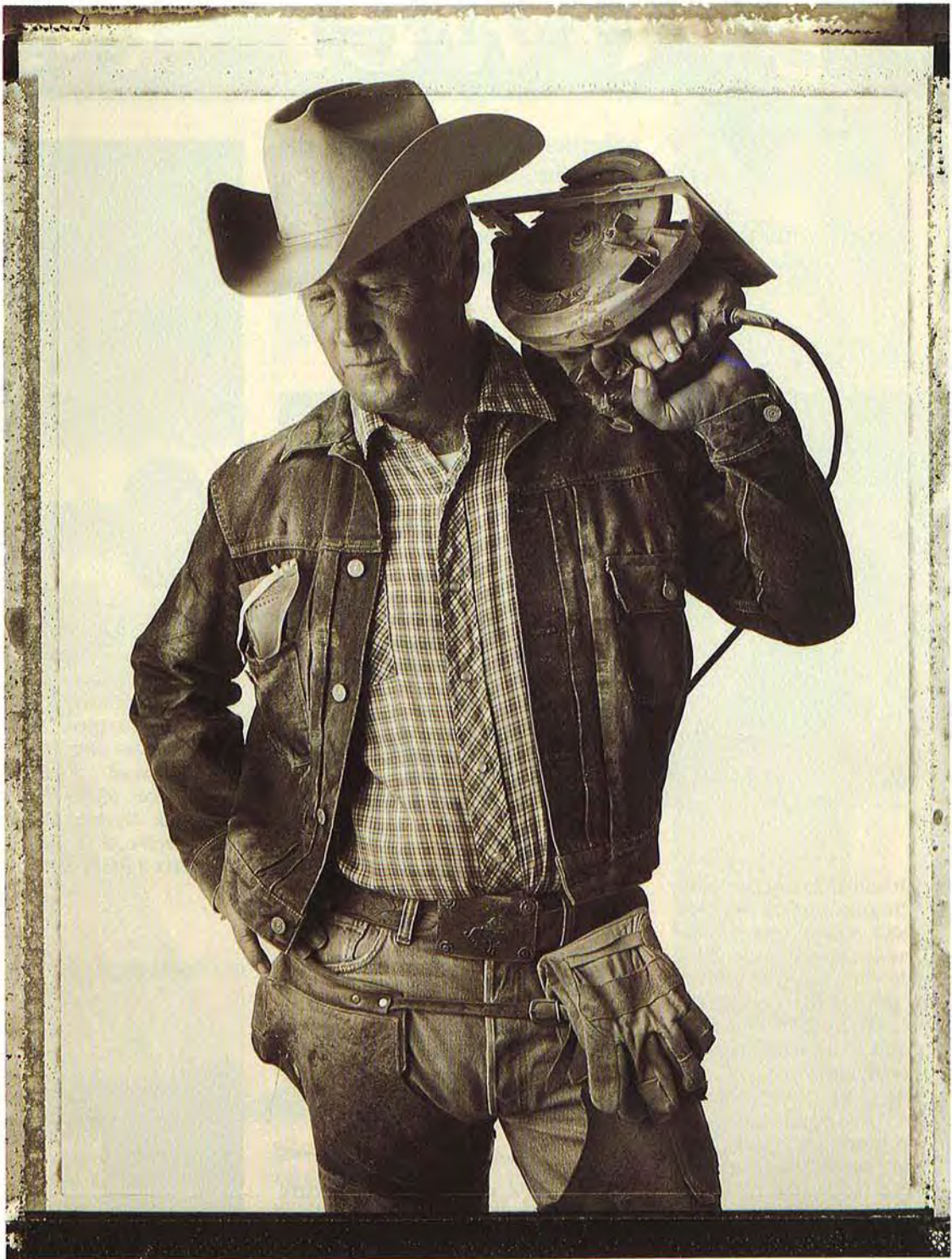

Paul Flinn, Construction Superintendent, Weatherford, Texas.
Over the past 40 years, he's never worked without his favorite hat. Or his SkilSaw.

SKILSAW[®]
We made it first. We make it last.



Skil Corporation, Subsidiary of Emerson Electric Co., 4300 W. Peterson Ave., Chicago, IL 60646. © 1990 Skil Corp. SkilSaw is a trademark of Skil Corp.

Power Tool

A collection of power tools can represent quite an investment, so it only makes sense to complement those tools with the right accessories. And we've assembled an impressive bunch for you to look over!

 Print this article



▼ These Bearing Enlarger Kits allow you to change cutting profiles and depth-of-cut when using ball-bearing-piloted router bits. The bearings work with any bit with a $\frac{3}{16}$ " OD pilot post. A three-piece set consists of $\frac{3}{8}$ ", $\frac{5}{8}$ ", and $\frac{3}{4}$ " bearings and sells for \$14.95 plus postage. A four-piece set includes $\frac{3}{4}$ ", $\frac{7}{8}$ ", 1", and $1\frac{1}{8}$ " bearings and costs \$32.50 plus postage. Woodcraft Supply, Dept. WD, 210 Wood County Industrial Park, P.O. Box 1686, Parkersburg, WV 26102-1686; 800/225-1153 or 800/535-4486.



▲ How do you copy complex moldings and other patterns? Answer: With a profile gauge such as these two models from Garrett Wade. The gauges have plastic plates that conform to the shape of the profile. The $5\frac{1}{2}$ " model sells for \$24.95, the 12" model for \$39.50 (prices do not include postage). Garrett Wade, Dept. WD, 161 Avenue of the Americas, New York, NY 10013-1299; 800/221-2942.

▶ There's nothing like a little support when you're ripping or resawing long stock. The HRT-18 Rollertable is made of heavy-duty components, and its height adjusts from $26\frac{1}{2}$ " to 44". For added stability it has four adjustable feet. List price: \$109.95. HTC Products, Dept. WD, 120 E. Hudson-W1, P.O. Box 839-W1, Royal Oak, MI 48068; 800/624-2027 or 313/399-6185.



▲ Because so many of us use drywall screws, Black & Decker has developed a new power screwdriver bit especially designed for these screws. Scorpion Anti-Slip Drywall Screwdriver Bits have a reduced-diameter head to minimize slippage. List price: \$9.99 for a 7-piece set. Black & Decker, Dept. WD, 10 N. Park Drive, P.O. Box 798, Hunt Valley, MD 21030; 800/762-6672.



Accessories

▶ Stationary saw and router-table kickbacks can be scary and dangerous experiences, so why take chances? The Anti-Kickback Hold-Down System (Item 96974) sells for \$55.98 ppd. and handles workpieces as small as 1/4" thick and 1/4" wide. Leichtung Workshops, Dept. P130, 4944 Commerce Parkway, Cleveland, OH 44128; 800/542-4467 (product info.), 800/654-7817 (catalogs), or 800/321-6840 (orders).

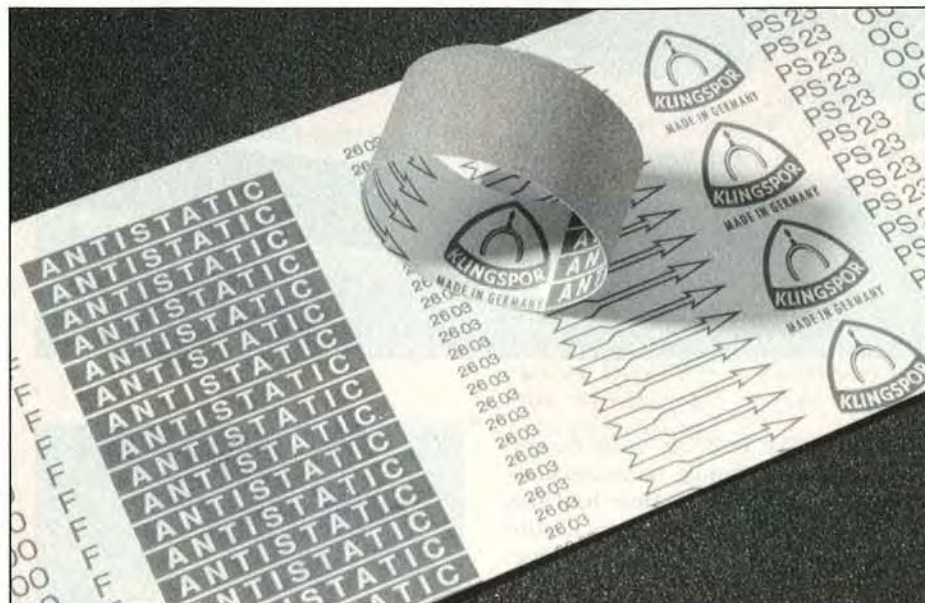
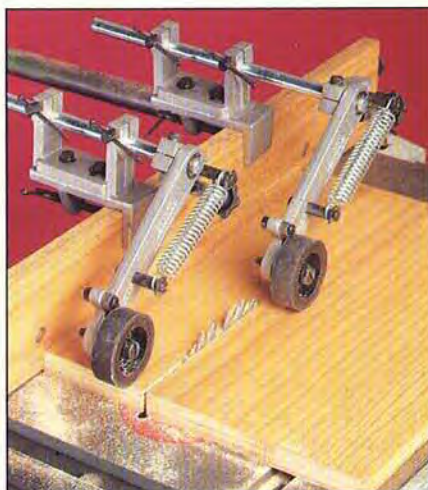

▲ Because Klingspor's new PS23 Antistatic Abrasives resist loading, they last longer and remove material more effectively than other sanding belts. If your sander is properly connected to a dust-collection system, the antistatic feature of these abrasives helps them efficiently channel the dust toward the collection port. Price depends on size and grit. Klingspor Abrasives, Dept. WD, 2555 Tate Blvd. S.E., P.O. Box 2367, Hickory, NC 28603; 800/645-5555 or 704/322-3030.

▶ Start screws the easy way with Makita's new Finder Driver (suggested retail price of \$7.55). Because the device prevents screws from wobbling or disengaging from the bit, it's especially useful when starting long deck screws and slotted-head screws. Makita, Dept. WD, 14930 Northam St., La Mirada, CA 90638; 714/522-8088.

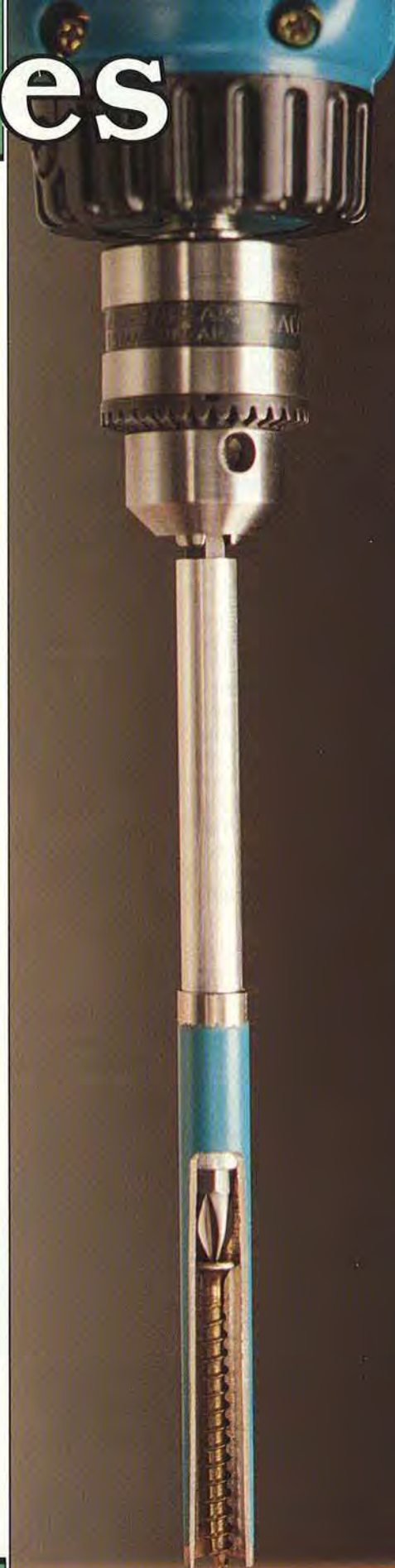

Power Tool Accessories



◀ If you have a table-mounted plunge router, this crank will help you lower and raise the router faster than any similar device on the market. The Router Crank Handle fits most Hitachi, Makita, Elu, Porter-Cable, and Bosch plunge routers. The original version sells for \$34.45 ppd., and a quick-release version goes for \$44.45 ppd. Tools Etc., Dept. WD, 1567 S. Harbor Blvd., Fullerton, CA 92632; 800/327-6250 or 714/525-3581.

▶ If you would like to get set up in your own sign-making business, here's a machine worth a look. The Kimball Woodcarver Model K55 comes complete with all you need to get started, and will carve signs with letters up to 12" high from templates. It also will help you carve pictures and logos from drawings. Free training provided at the company's headquarters. Selling price: \$2,195 F.O.B. factory (basic model). Kimball Sign Co., Dept. WD, 2602 Whitaker St., Savannah, GA 31401; 912/232-6561.

▶ How would you like to give your tablesaw the cutoff capabilities of a radial-arm saw? The Shopsmith Crosscut Sliding Table has a 15 $\frac{3}{4}$ x 31 $\frac{3}{4}$ " laminated surface and a fence that adjusts for angle cuts of 90°, 45°, 36°, 30°, and 22.5°. Four models fit Shopsmith MARK V 510, Shopsmith MARK V 500, and Delta and Sears tablesaws. All sell for \$59. Shopsmith, Dept. WD, 3931 Image Drive, Dayton, OH 45414; 800/543-7586 or 513/898-6070.



▶ With a Split-Grit abrasive belt on your 6 x 48" sander, you can save time changing belts because half of the belt has one grit, and the other half has another grit. Several grit combinations available ranging from 40 to 150. Price: \$9.95 plus postage. Woodworker's Supply, Dept. WD, 5604 Alameda Place N.E., Albuquerque, NM 87113; 800/645-9292 or 505/821-0578.



▶ With the Woodcarver you can convert your angle grinder into a small, fast, and maneuverable woodcutting instrument. The accessory quickly sculpts and trenches any wood without kickback. Price: about \$40. Ryobi, Dept. WD, 1424 Pearman Dairy Road, Anderson, SC 29625; 800/323-4615 or 803/226-6511.

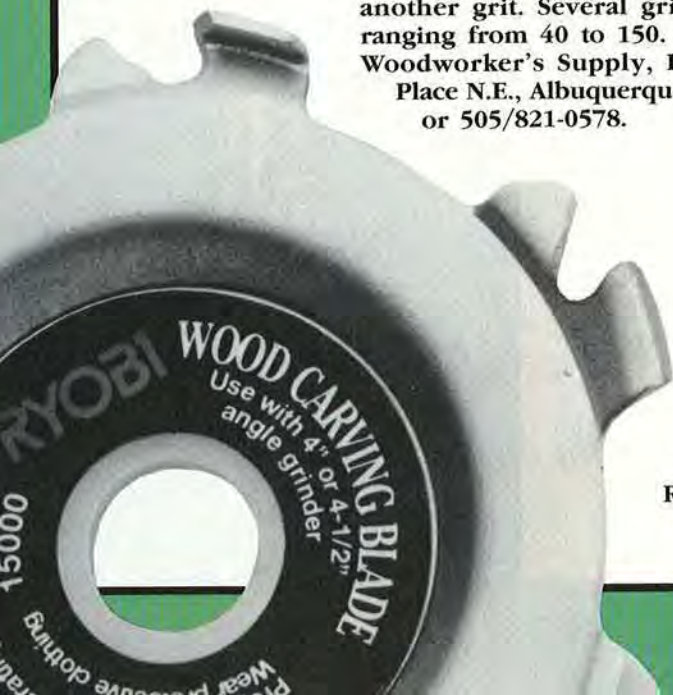

The Caroline

Redwood

E

WESTERN STYLE



▲ Shaper cutters always have represented a hefty investment for woodworkers, but now LRH is bringing down the cost of these items with its new line of CO-ST Cutters. These cutters are made in the U.S. and are specially designed for smaller shapers with $\frac{1}{2}$ " and $\frac{3}{4}$ " spindles. Prices vary. CO-ST Cutters, Dept. WD, 7101 Valjean Ave., Van Nuys, CA 91406; 800/423-2544 or 818/782-0226.

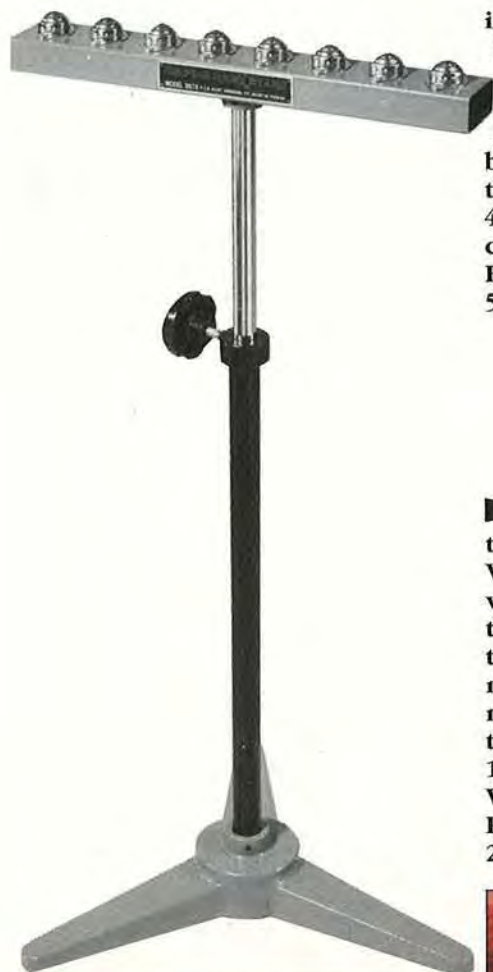

▲ Because the model 9975 Helping Hand Stand has eight independent ball bearings, you can roll workpieces across it from any direction without changing the stand's position. It has a cast-iron base and telescoping steel column that adjusts in height from 28" to 48". Price: \$40-\$45. Power Tool Specialists, Dept. WD, 3 Craftsman Rd., East Windsor, CT 06088; 800/243-5114 or 203/654-1761.

▲ By combining the best qualities of auger and spade bits, the Wood Eater bit feeds itself into the workpiece easily. And according to the manufacturer, it cuts up to three times faster and will make as many as seven times more holes than a spade bit. A three-piece set with $\frac{1}{2}$ ", 1", and $1\frac{1}{2}$ " bits sells for about \$19.99. Vermont American, Dept. WD, P.O. Box 340, Lincolnton, NC 28093-0340; 704/735-7464.



Power Tool Accessories

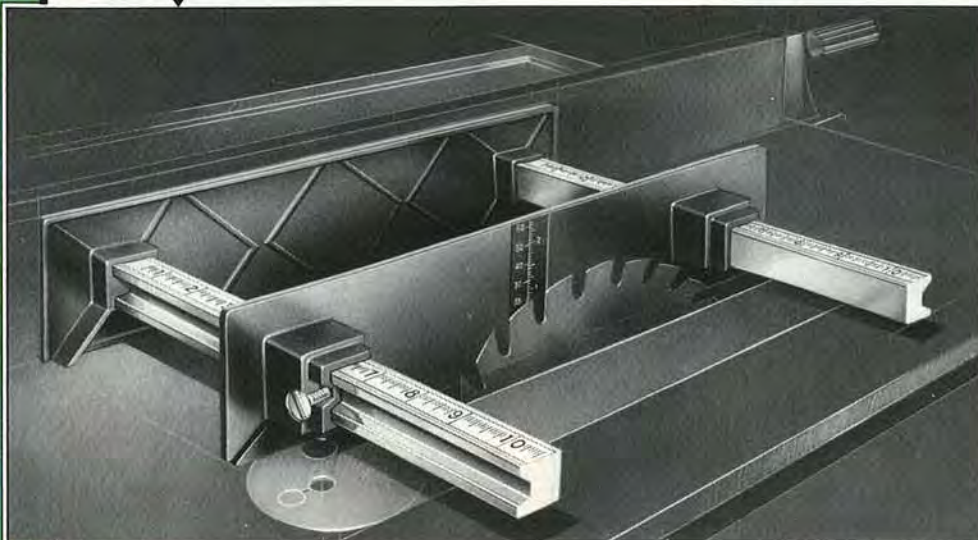

▲ The Paragauge is guaranteed to set any power-tool fence to within .010". And, you can use it to measure blade depth and adjust your table saw fence parallel to the blade. The 12" model PG-12 sells for \$34.95 plus postage, and the 18" model PG-18 sells for \$39.95 plus postage. Accuset Tool Co., Dept. WD, P.O. Box 1088, Troy, MI 48099; 800/343-6129 or 313/879-0030.



▲ You can build your own work-support roller systems with a few HU-13 Universal Roller/Brackets. The high-quality roller is 1.38" in diameter and 13" long (22"-long models also available). List price: \$12.95. HTC Products, Dept. WD, 120 E. Hudson-W1, P.O. Box 839-W1, Royal Oak, MI 48068; 800/624-2027 or 313/399-6185.

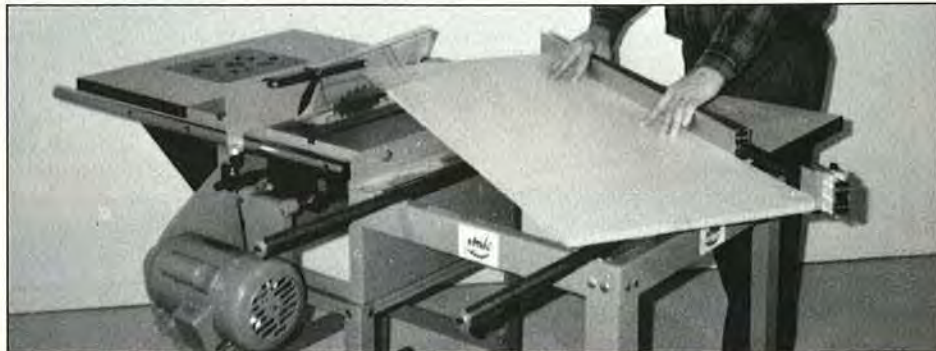

▲ Here are two accessories that help turn your table saw into an all-around performer. One is the MULE Router Table that consists of a double-laminated top, phenolic router plate, and steel mounting brackets (\$149). The other is the MULE Cabinetmaker Sliding Table for hassle-free crosscuts (\$369). MULE Cabinetmaker Machine, Dept. WD, 519 Mill St., P.O. Box 731, Lockport, NY 14095; 800/563-6853 or 416/727-7090.

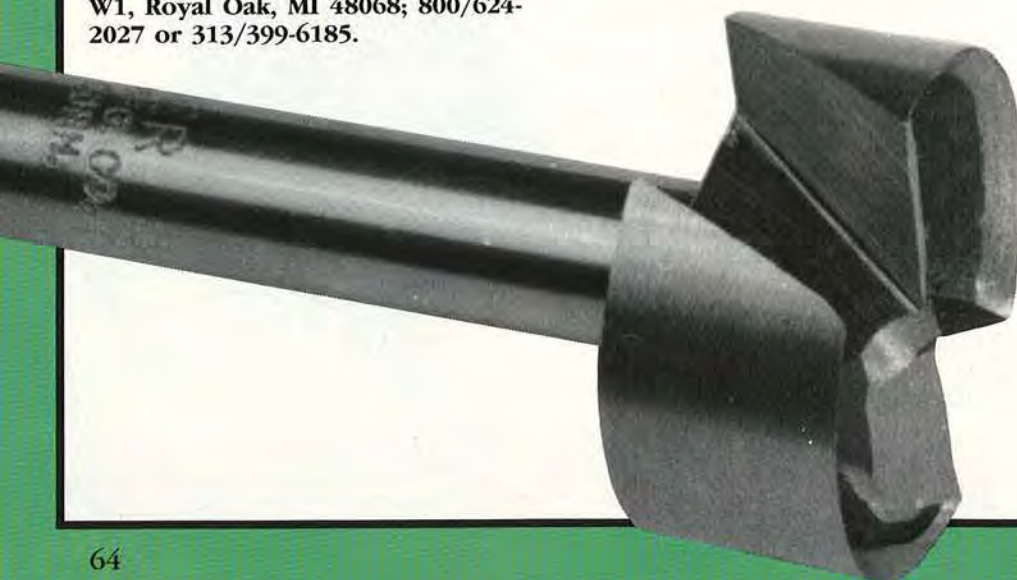

▲ Only CONVALCO Forstner bits closely resemble the original Forstner bits developed by Benjamin Forstner. The bits have minuscule centerpoints for flat-as-possible hole bottoms, and have plenty of steel mass near the rim for cool cutting. A 7-piece set (bits ranging from 1/4" to 1") sells for \$142 ppd. Connecticut Valley Manufacturing Co., Dept. WD, P.O. Box 1957, New Britain, CT 06050; 203/223-0076.



◀ For faster, cooler, and smoother plunge-router cuts, Vermont American has come out with a titanium-nitride-coated set of plunge-cutting router bits. The five-piece set (suggested price: \$24) consists of these bits: ½" straight, ¼" veining, ⅜" V-groove, keyhole slot, and ¼" panel pilot. Vermont American, Dept. WD, P.O. Box 340, Lincolnton, NC 28093-0340; 704/735-7464.

▼ If you happen to own a Skil Model 77 portable circular saw—and plenty of people do since versions of the saw have been made for 50 years—here's an accessory for better rip cuts. The new Slickfoot attaches to the saw's foot and helps the saw glide smoothly over wood and prevents marring or scratching of fine finishes. Price: about \$8. Skil, Dept. WD, 4300 W. Peterson Ave., Chicago, IL 60646; 312/286-7330.



▼ Woodworkers are catching on to the benefits of random-orbit sanders, and this attachment allows you to add this capability to your 4", 4½", or 5" angle grinder with ⅝" arbor and 11 threads per inch. The Random Orbit Sander Head works with 5" adhesive-backed sanding pads (\$54.95 plus postage). Woodcraft Supply, Dept. WD, 210 Wood County Industrial Park, P.O. Box 1686, Parkersburg, WV 26102-1686; 800/225-1153 or 800/535-4486.



▲ If you own a Taiwanese-made scroll saw that accepts pin-end blades, you can enjoy the benefits of plain-end blades by outfitting your saw with an Upgrade Kit. (Plain-end blades are available in finer tooth sizes and cut a greater variety of materials than pin-end blades). The easy-to-install kits come in four versions for various saws and range in price from \$38 to \$50. Advanced Machinery Imports, Dept. WD, 2 McCullough Drive, P.O. Box 312, New Castle, DE 19720; 800/648-4264 or 302/322-2226.

Power Tool Accessories

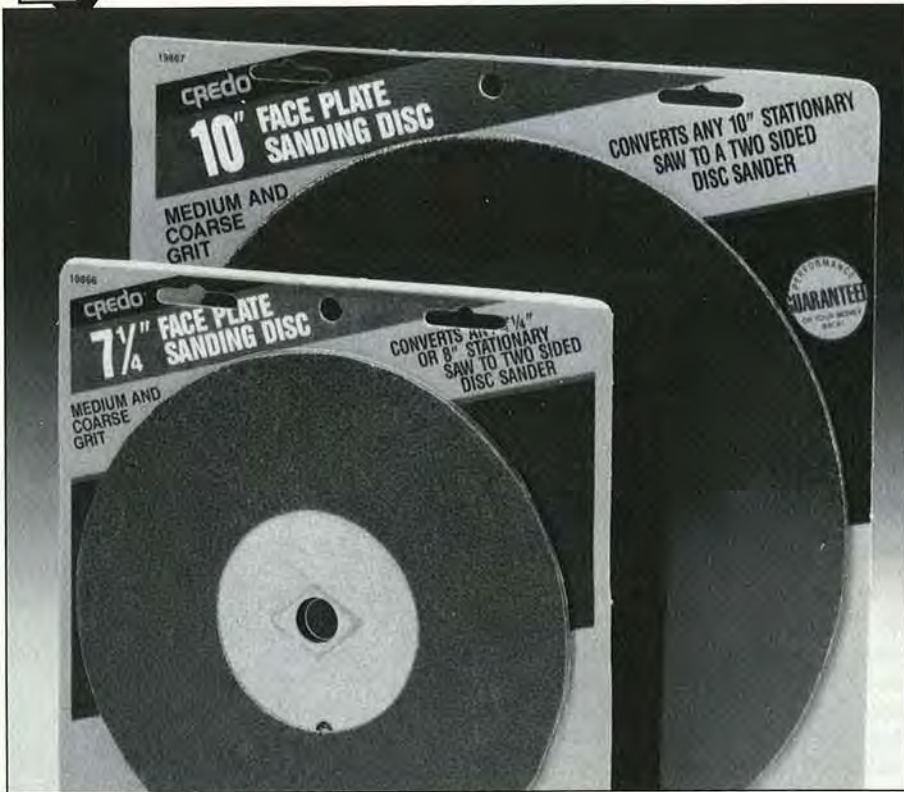

▶ You can convert your tablesaw into a two-sided disc sander with the Credo Face Plate Sanding Disc. Each disc has medium-grit sandpaper mounted on one side, and coarse-grit sandpaper on the other. Available in 7¼" and 10" sizes for \$9.64 and \$15.22. Credo, Dept. WD, 2765 National Way, Woodburn, OR 97071; 503/982-0100.

▶ Removing plugs from a hole-saw can be a real chore, but the Plug-Ejecting Hole Saw helps you get the job done with ease. After cutting the hole, you simply reverse the drill to back the plug out of the saw. The saws range in size from ⅞" to 2½" and retail for \$20 to \$25 each. Vermont American, Dept. WD, P.O. Box 340, Lincolnton, NC 28093-0340; 704/735-7464.

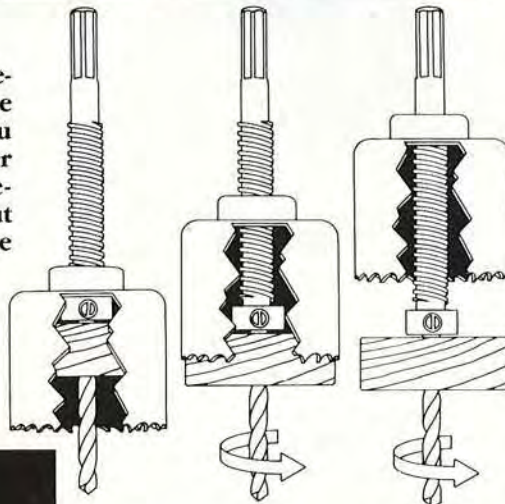

▶ The Marathon Blade for cutting deck lumber has several special features to help you cut pressure-treated lumber with ease. Its thin-kerf body helps the blade slice through the lumber with less power from the saw. And a silicone coating reduces resin buildup. List price: \$20 for a 7¼" blade. Irwin, Dept. WD, 92 Grant St., Wilmington, OH 45177; 513/382-3811.



▶ The DDF100 Doweling Fixture handles drawers and other joints without the usual alignment problems you run into when doweling. The fixture includes an industrial-grade hardened steel bushing. List price: \$49.95. Nova Tool Co., 12500 Finigan Rd., P.O. Box 29341, Dept. BG, Lincoln, NE 68529; 800/826-7606 or 402/464-0511.





Many tool surfaces benefit from a low-friction finish that aids the smooth gliding of parts while providing protection from rust. Kity-speed gets this job done on machine tables, jigs, power-tool bases, and many other surfaces. All you need to do is apply a thin coat, allow a few minutes to dry, then buff. It will not transfer to stock when properly applied. Postage-paid prices: \$19.95 for 18 oz., and \$4.95 for 2.5 oz. Farris Machinery, Dept. WD, 320 N. 11th, Blue Springs, MO 64015; 800/872-5489 or 816/229-3055.



You can make your own router table with the help of a Woodhaven No. 100 Series Router-Base Plate. The acrylic plate screws to the base of your router, enabling you to hold the router or suspend it in a table. You only need to cut a rabbeted hole in a freestanding table or into a tablesaw extension. Price: \$16-\$20 plus postage. Woodhaven, Dept. WD, 5323 W. Kimberly, Davenport, IA 52806; 800/344-6657 or 319/391-2386.

Note: If you would like to obtain your own plans for building a router table with the Woodhaven plate, WOOD® magazine has two plans to choose from. A floor-standing version appeared in the February 1990 issue. If you don't have this issue, we'll send you one for \$4.95 ppd. We also have a blueprint-style plan available for a benchtop version (\$4.95 ppd.). WOOD magazine, P.O. Box 11454, Des Moines, IA 50336-1454.

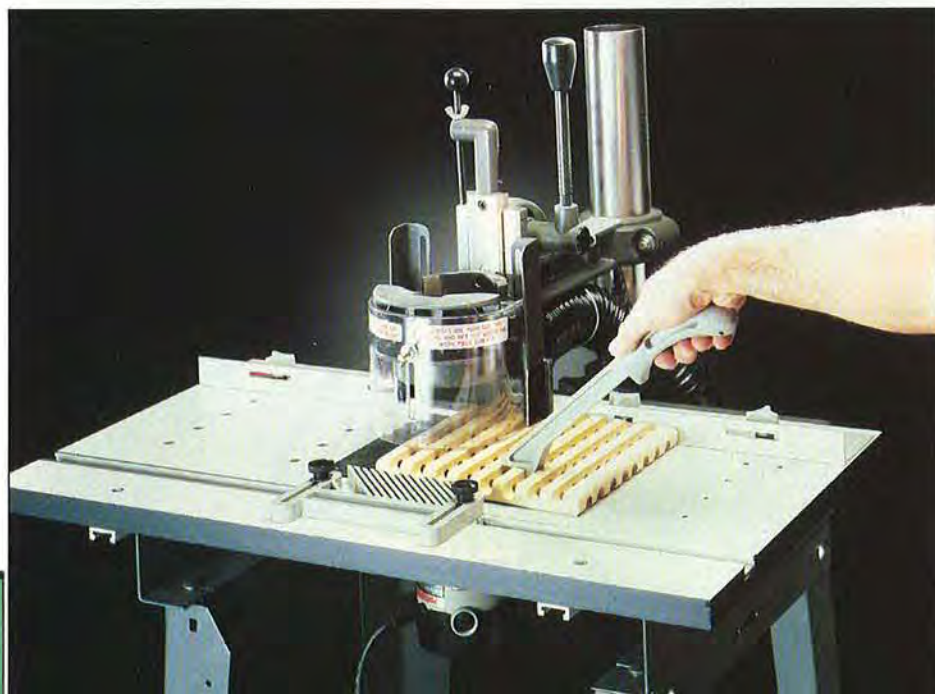

Few systems under \$1,000 allow you to mount a router above or below your workpieces, but the Shopsmith Routing System (\$439) does. The unit comes with a feather board, fence, guide pins, dust-collection hookup, and a comprehensive owner's manual (router not included). Shopsmith, Dept. WD, 3931 Image Dr., Dayton, OH 45414; 800/543-7586 or 513/898-6070.

Power Tool Accessories



◀ You know how it goes. It seems as if your drill and drill bits are never in the same place at the same time. Now, they can be. The Drillminder contains 13 high-speed twist drill bits in sizes from $\frac{1}{16}$ " through $\frac{1}{4}$ " by 64ths. The dispenser stands up or clips to the cord of your drill. List price: \$17.79. Irwin, Dept. WD, 92 Grant St., Wilmington, OH 45177; 513/382-3811.

▼ Hey, Shopsmith owners! You can convert your MARK V into a stationary biscuit joiner with the Shopsmith Biscuit Joiner (\$109). The accessory has dust-collection hookup for debris-free work. Shopsmith, Dept. WD, 3931 Image Drive, Dayton, OH 45414; 800/543-7586 or 513/898-6070.



▲ Once you own the Model C2220 Molding Head (\$64.95 plus shipping and handling), you can purchase all sorts of interchangeable knives to handle most any job. The head has a $\frac{3}{4}$ " bore and accepts two knives (also available from the supplier). Cascade Tools Inc., Dept. WD, P.O. Box 3110, Bellingham, WA 98227; 800/235-0272 or 206/647-1059.

▼ Because these countersinks shear rather than scrape, they make smooth, chatter-free cuts. Three sizes countersink a wide range of holes and sell for \$9.95 to \$11.95 each plus postage. Garrett Wade Company, Dept. WD, 161 Avenue of the Americas, New York, NY 10013-1299; 800/221-2942.

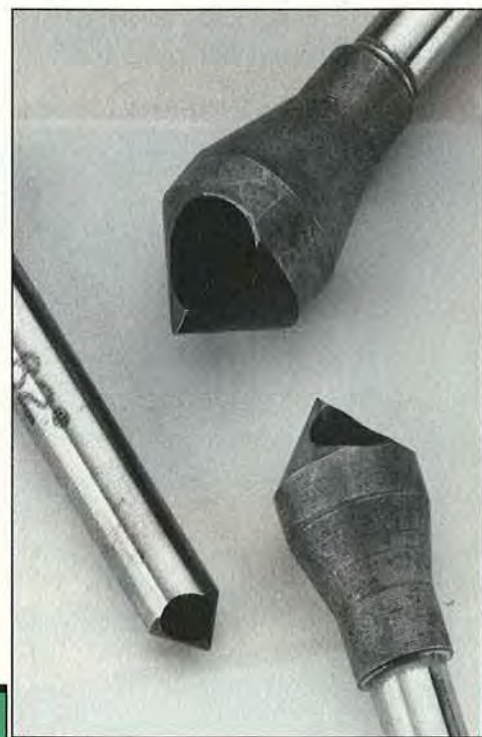
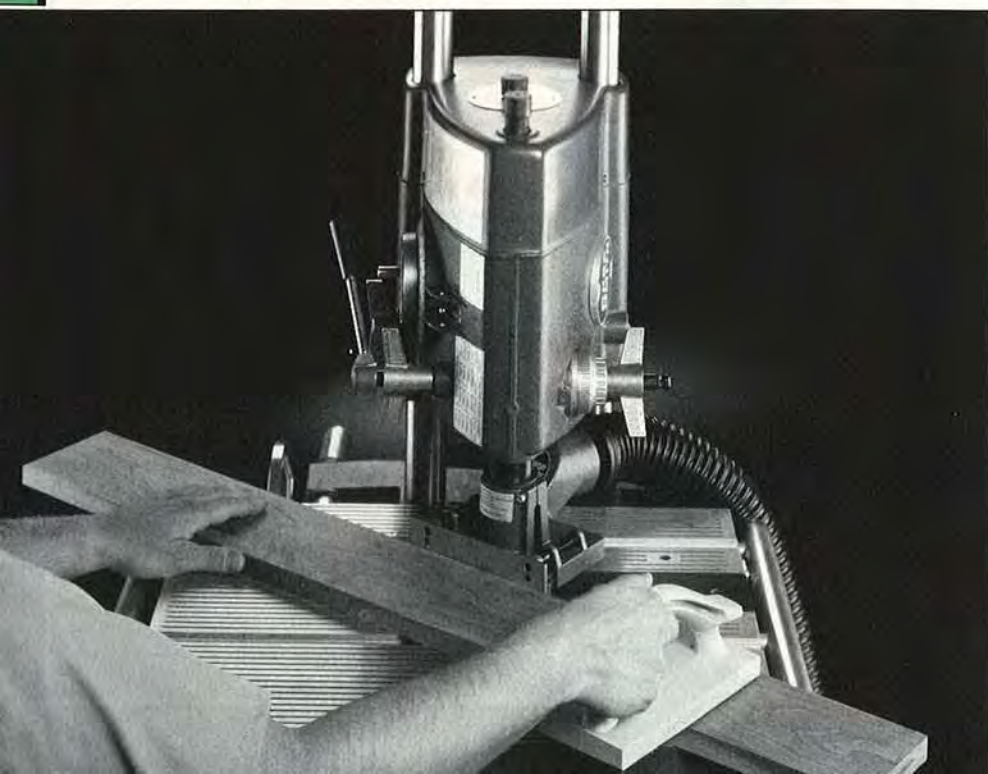

▶ Slick Strips are made of a special adhesive-backed flexible plastic film that reduces friction tremendously. And, their high abrasion resistance even surpasses Teflon. The 3" width (\$15.95 plus postage for 10.5') is ideal for power-tool fences and the bases of routers and hand-held saws. You can renew the smooth run of worn wooden drawers or protect other surfaces with the 3/4"-wide material (\$4.75 plus postage for 10.5'). Woodcraft Supply, Dept. WD, 210 Wood County Industrial Park, P.O. Box 1686, Parkersburg, WV 26102-1686; 800/225-1153 or 800/535-4486.

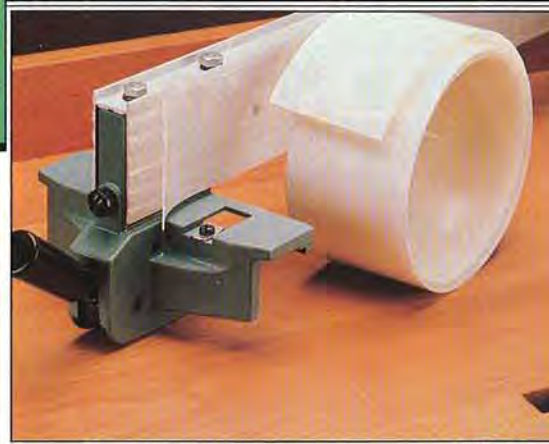

▼ Large router bits, such as panel raisers, require slow router speeds. So what do you do if your router doesn't have variable speed? You can add this capability to your router for \$39.95 with the MLCS Router Speed Control. The control works with portable power tools up to 15 amps that have universal motors. MLCS, Dept. WD, P.O. Box 4053-D-9, Rydal, PA 19046; 800/533-9298 or 215/886-5986.

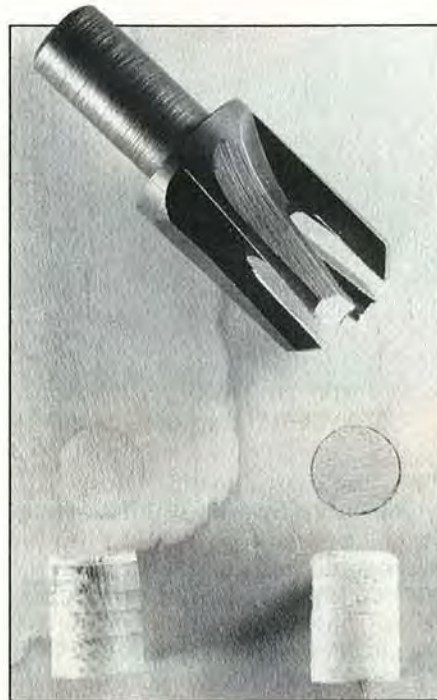

▶ Your wooden plugs will always fit tightly if you cut them with a Veritas Snug Plug Cutter. Why? These cutters make slightly tapered plugs that fit like a cork in a bottle (see example on left in photo). A set of three plugs in English or metric sizes costs \$29.95 plus postage. Veritas Tools, Dept. WD, 12 E. River St., Ogdensburg, NY 13669.

▼ Here's a weather-stripping system that allows you to install a hollow silicone bead that cannot loosen or fall out. The silicone bead recovers its original shape under nearly any circumstances, and is temperature-resistant. A complete kit sells for \$399 and includes a Bosch laminate trimmer, solid-carbide bit, attachment for curves and arches, alignment tool, a roller for pressing the bead into its channel, and 150' of bead in one of three sizes (1/4", 5/16", or 3/8") in brown or white. Weatherbead Insulation Systems, Dept. WD, 81-824 Trader Place, Unit C-5, Indio, CA 92201; 800/966-0159 or 619/347-3738.

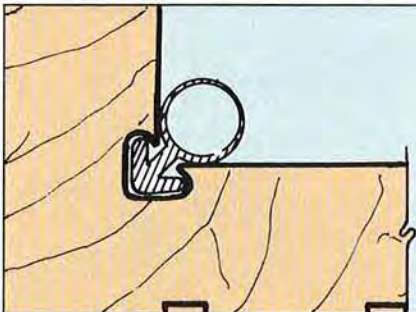
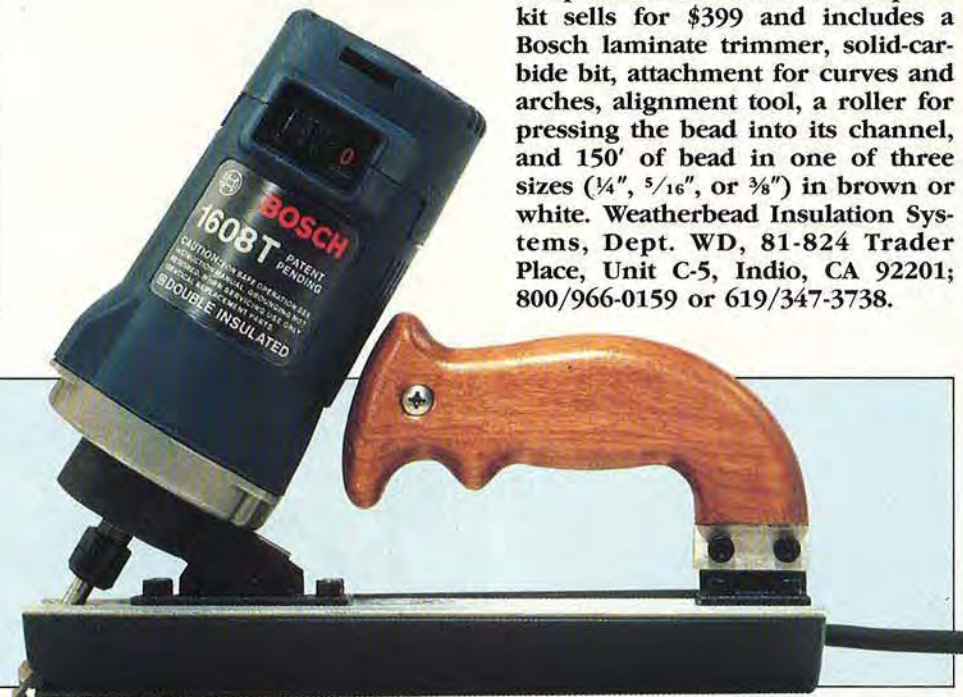

Power Tool Accessories



▶ To give your portable circular saw many of the abilities of a radial-arm saw, all you need is the Trimtramp Sliding-Compound Miter Saw Table. It handles boards up to 16" wide and weighs 21 lbs. Suggested retail price: \$149.95. Trimtramp Ltd., Dept. WD, 151 Carlingview Drive, Unit 11, Etobicoke, Ont., Canada M9W 5S4; 416/798-3160.

▼ With the Corner Sander and your angle grinder, you can sand into the corners of shelving, floors, cabinets, and other knuckle-busting spots. The attachment sells for \$29.95 plus postage and fits grinders with a $\frac{5}{8}$ "—11 arbor. Woodcraft Supply, Dept. WD, 210 Wood County Industrial Park, P.O. Box 1686, Parkersburg, WV 26102-1686; 800/225-1153 or 800/535-4486.

▼ The Woodchuck Indexing Router Table System unlocks your router's potential by turning it into a horizontal milling station. With it, you can combine these elements for an endless variety of designs: indexed tapers, flutes, accent cuts, mortises, dovetail slots, dadoes, and rabbets. Five models range in price from \$89 to \$695. Phantom Engineering, Dept. WD, 16890 Church St., Bldg. 13, Morgan Hill, CA 95037; 408/779-1616.



▲ Woodhaven's "Know Bits" help you check your router or drill press for runout. You can also use these handy helpers to find mortise centers. Price: \$12.99 ppd. Woodhaven, Dept. WD, 5323 W. Kimberly Road, Davenport, IA 52806; 800/344-6657 or 319/391-2386.

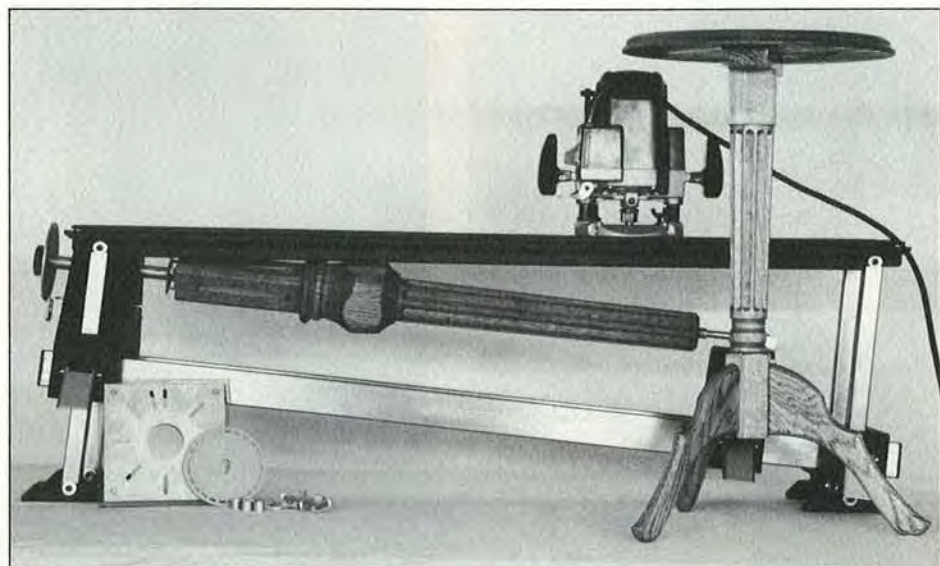

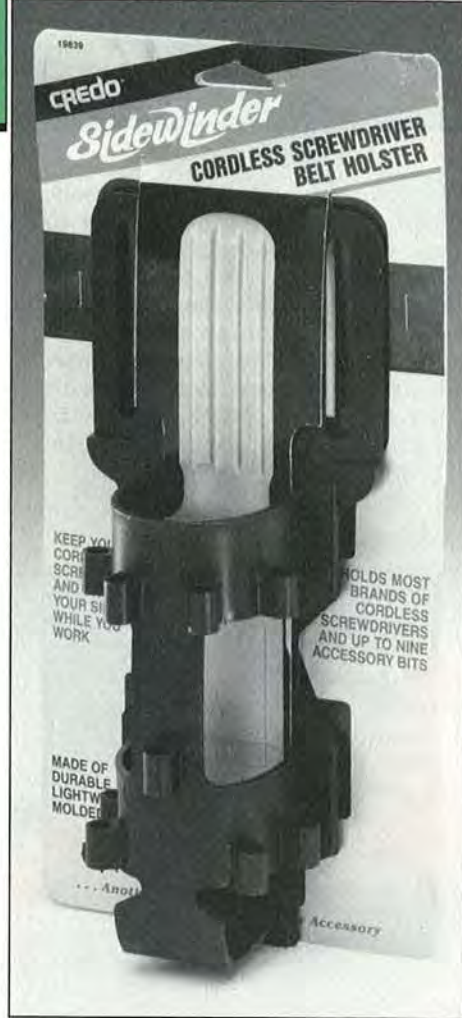

◀ To keep your cordless screwdriver and its accessories organized, you need the Sidewinder Holster. It will hold most cordless screwdrivers (the type with a straight barrel) and up to nine accessory bits. Suggested list price: \$5.19. Credo, Dept. WD, 2765 National Way, Woodburn, OR 97071; 503/982-0100.

▶ By mounting your router horizontally in the Shopsmith Joint-Matic, you can accurately cut an amazing array of joints including half-blind dovetails, spliced dovetails, sliding dovetails, mortise and tenons, and box joints. The sturdy built tool also makes for safe and easy raised panels when used with optional "Raiser Router Bits." Price: \$399. Shopsmith, Dept. WD, 3931 Image Dr., Dayton, OH 45414; 800/543-7586 or 513/898-6070.



▼ Black & Decker's new Universal Quick-Change Mandrel allows you to easily lock a holesaw on or take it off without tightening a nut. The mandrel fits all sizes of carbon-steel holesaws, so you don't have to own two different-sized mandrels. List price: \$6.98. Black & Decker, Dept. WD, 10 N. Park Drive, P.O. Box 798, Hunt Valley, MD 21030; 800/762-6672.

▼ How would you like to try biscuit joining without investing in an expensive biscuit joiner? The MLCS Biscuit-Joining Set for Routers allows you to do just that. The set (\$29 ppd.) consists of a 1/4"-shank, carbide-tipped slot cutter and 250 No. 20 biscuits. MLCS, Dept. WD, P.O. Box 4053-D-9, Rydal, PA 19046; 800/533-9298 or 215/886-5986.

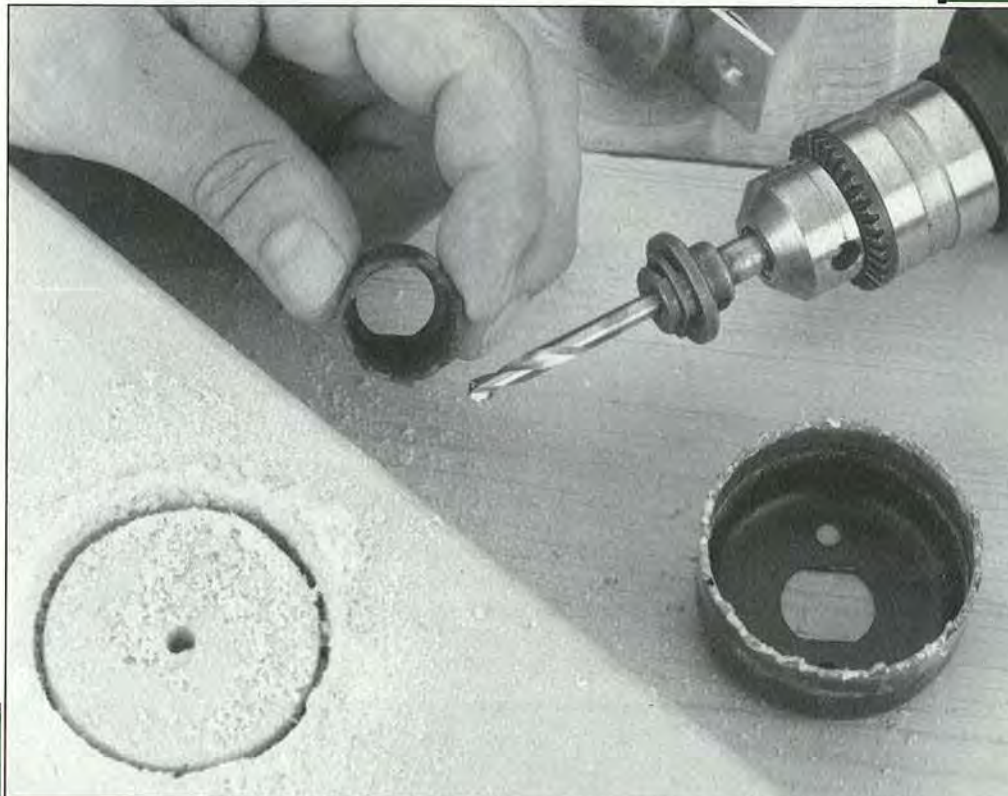

Power Tool Accessories



Before the age of power tools, craftsmen used molding planes to shape complex moldings. You can duplicate the look of these moldings with your router and the four-piece molding-plane profile set (\$99.95 ppd.). The two-flute, carbide-tipped bits are available with $\frac{1}{4}$ " or $\frac{1}{2}$ " shanks. MLCS, Dept. WD, P.O. Box 4053-D-9, Rydal, PA 19046; 800/533-9298 or 215/886-5986.



With the Cutter's Edge II, you can cut straight lines in sheet goods using your portable circular saw, router, jigsaw, or utility knife. The guide is over 8' long, breaks down into two sections, and includes two clamps for locking the guide in place. Suggested price: \$27.95. The Hirsh Company, Dept. WD, 8051 N. Central Park, Skokie, IL 60076; 800/872-3279 or 708/673-6610.

Applying glue to biscuit slots can be messy—unless you have the Biscuit Glue Applicator and Storage Box (\$19.95 plus postage). The box contains a water-soaked sponge to keep the glue at the tip of the applicator from drying out. The squeeze bottle holds 8 oz. of glue. Woodworker's Supply, Dept. WD, 5604 Alameda Place N.E., Albuquerque, NM 87113; 800/645-9292 or 505/821-0578.





▲ With the Black & Decker Door Lock Installation Kit, you can quickly and accurately install most any lockset or door bolt (six kits available). The kits list for \$16.99 and include a holesaw with mandrel, spade bit, latch-locator pin, and drill guide. Black & Decker, Dept. WD, 10 N. Park Drive, P.O. Box 798, Hunt Valley, MD 21030; 800/762-6672 or 301/527-7000.

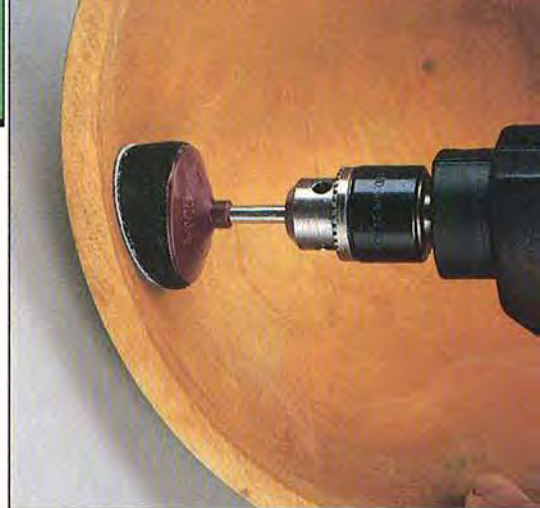

▲ The quickest way to smooth a bowl is to do it with a power tool while the bowl is still on the lathe. The Woodturner's Sanding Set consists of two 2"-thick foam pads that chuck into your portable electric drill, five spare hook-and-loop faces, and 50 abrasive discs in various grits—all contained in a plastic case. Price: \$41.95 ppd. Constantine's, Dept. WD, 2054P Eastchester Road, Bronx, NY 10461; 800/223-8087 or 212/792-1600.

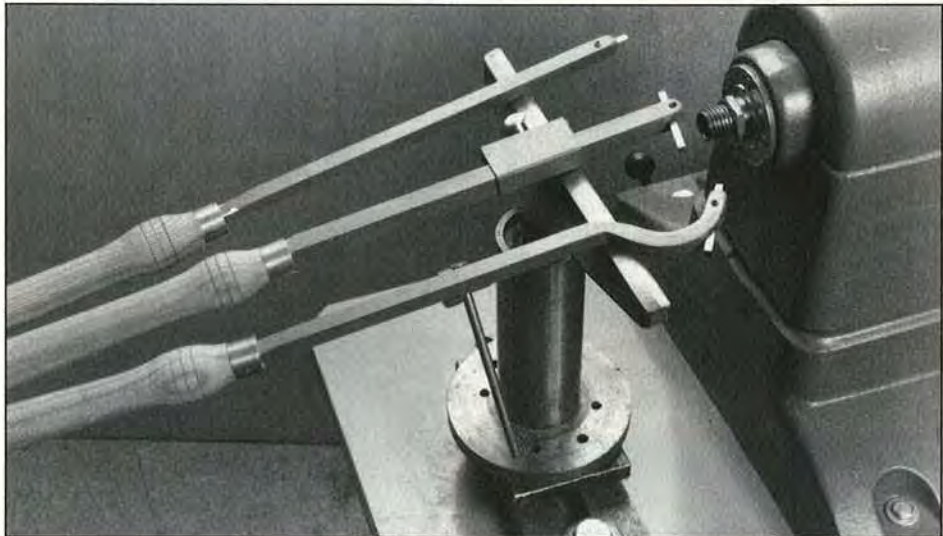

▼ Sliding tables help you cross-cut large workpieces with ease, and here's one of the highest-quality models around. Its cast-iron table rides on a ball-bearing glide system. The complete outfit sells for \$795 and attaches to nearly any tablesaw. A video presentation is available for \$6. Laguna Tools, Dept. WD, 2081 Laguna Canyon Road, Laguna Beach, CA 92651; 800/234-1976 or 714/494-7006.

▲ Few turning tasks present as many challenges as hollowing wooden vessels. This set of Three Hand-Forged Woodturning Tools is designed to make the job as easy as possible by eliminating the torque problem encountered with simple bent tools. Replacements for the high-speed steel tips are available at machinist's supply stores. You can buy the tools with or without handles ranging in price from \$25 to \$47.50 each plus postage. Lea's Tools, Dept. WD, 1651 S. Pecan Circle, Mesa, AZ 85202; 602/838-6452.



Power Tool Accessories



▲ Cutting exact-fitting miters is a real pleasure—one that you'll experience again and again with the help of the Kity Right-Angle Miter Gauge. The two faces of the gauge's protractor head are precision milled at 90° to each other for guaranteed success. The gauge sells for \$84.95 ppd., and comes with the correct bar to fit your saw's miter-gauge slot, and a 20" fence with adjustable stop. Farris Machinery, Dept. WD, 320 N. 11th, Blue Springs, MO 64015; 800/872-5489 or 816/229-3055.

▼ The Woodhaven Mini Biscuits & Bit Kit consists of a 6mm × 1½" cutter and 100 6mm compressed biscuits for doing biscuit joinery with your router. You also can buy compressed spline stock and a 6mm straight cutter for face frames. Because these biscuits are smaller than standard biscuits, you can use them with frame pieces as narrow as 1½". Price: \$38.48 ppd. Woodhaven, Dept. WD, 5323 W. Kimberly Rd., Davenport, IA 52806; 800/344-6657 or 319/391-2386.



▼ To demonstrate the durability of their "TK" (thin kerf) series of blades, Freud representatives cut through nails embedded in boards. The saw barely slows down for the nails and the blade's teeth appear unscathed following the workout. The blades have an antikickback design for your protection. Typical selling prices for 6½"-10" models range from \$19 to \$27. Freud, Dept. WD, P.O. Box 7187, 218 Feld Ave., High Point, NC 27264; 919/434-8300.

Art. No. TK205

freud®

9" Framing

PREMIUM QUALITY CARBIDE BLADE

24 TEETH
THIN KERF

5/8" BORE
LASER CUT

ADVANCED ANTI-KICKBACK DESIGN

Recommended Use and Cut Quality	
Rip Wood	██████████
Crosscut Wood	██████████
Chip Board	██████████
Plywood	██████████
Non-Ferrous	Not Recommended
Masonry	Not Recommended

8000
MAX
RPM

▶ No other drill bit does what this one does: bore curved holes! The Around-the-Corner Bit eliminates the need to drill two holes (and hope they line up), making it ideal for many wiring jobs. The bits will also drill straight holes. Suggested retail prices: \$9.35 (⅝" diameter) and \$10.95 (1⅜"). Vermont American, Dept. WD, P.O. Box 340, Lincolnton, NC 28093-0340; 704/735-7464.

▼ No matter what brand or vintage of stationary tools you own, HTC can outfit you with a mobile base to help you make the most of your woodworking space. The super-durable stands raise the machine only $\frac{3}{4}$ " off the floor. Prices range from \$68 to \$288 depending on the size of your machine (model shown sells for \$149). HTC, Dept. WD, 120 E. Hudson-W1, P.O. Box 839-W1, Royal Oak, MI 48068; 800/624-2027 or 313/399-6185.



▲ You can make your own custom drilling fixtures with these Hardened Steel Drill Bushings. The bushings have knurled surfaces so they hold in place when inserted into wood and come in 10 sizes in prices ranging from \$2.80 to \$3.40 each plus postage. Woodworker's Supply, Dept. WD, 5604 Alameda Place N.E., Albuquerque, NM 87113; 800/645-9292 or 505/821-0578.

▼ This 8-piece Detail Woodturning Set helps you turn tiny stock with ease. Price: \$54.50 plus postage. Woodcraft Supply, Dept. WD, 210 Wood County Industrial Park, P.O. Box 1686, Parkersburg, WV 26102-1686; 800/225-1153 or 800/535-4486.

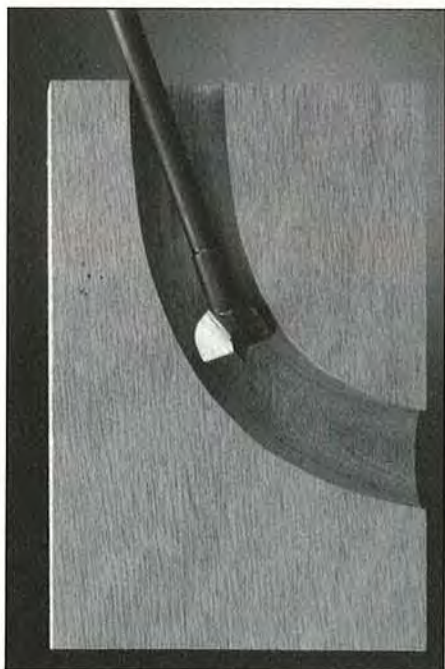

A Medley of

Many of the tools, accessories, and other supplies necessary for a well-stocked workshop just don't fit into a basic category. We've gathered together this varied group of helpers because we know you're sure to find an item or two that will help with your next project.

 Print this article



▶ The Workmate 200 Portable Vise and Workbench could become the most useful item in your shop. Swiveling pegs in the top surface hold odd shapes up to 22" diagonally and 12" horizontally. The 23"-wide vise jaws angle to hold odd shapes up to 5 1/4" wide and have horizontal and vertical V-grooves to grip round objects. Between jobs, this super helper folds to 7 3/4" deep. List price: \$73.95. Black & Decker, Dept. WD, 10 N. Park Drive, P.O. Box 798, Hunt Valley, MD 21030; 800/762-6672 or 301/527-7000.

▼ You won't find a more complete line of instant adhesives than that offered by Satellite City. In addition to instant glues in several consistencies, the manufacturer offers accelerators that speed curing, solvents, and odorless instant glues. Satellite City, Dept. WD, P.O. Box 836, Simi Valley, CA 93062; 805/522-0062.

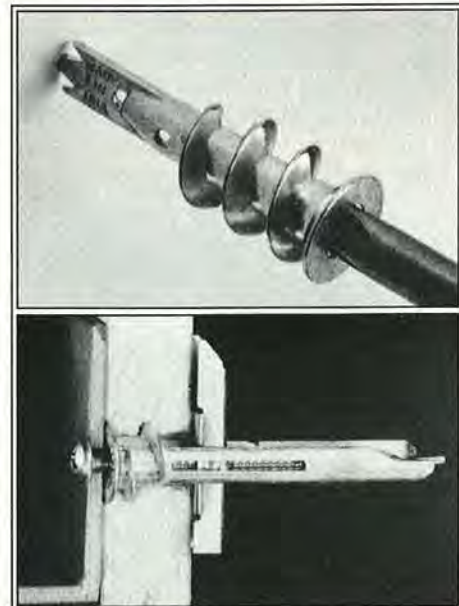

▲ Few things are faster, simpler, or more effective than these two drywall anchors from ITW Buildex. For mounting lightweight fixtures, all you need is the E-Z Anchor—a self-drilling, one-piece anchor—and a No. 2 Phillips screwdriver. After screwing the anchor into the wall, you only need to insert a No. 8 screw into the anchor. Price: about \$1.69 for three anchors. For mounting heavier fixtures, the E-Z Toggle has all the holding power of other toggle-based systems, but is also self-drilling. Price: about \$2 for a pack of two. ITW Buildex, Dept. WD, 1349 W. Bryn Mawr Ave., Itasca, IL 60143; 800/323-0720 or 708/595-3500.



▶ The Intego Do-It-Yourself Safety System allows you to combine safety glasses, goggles, and earmuffs into one comfortable headpiece. Each component adjusts separately for proper fit. Racal Panorama, Dept. WD, 7305 Executive Way, Frederick, MD 21701; 800/682-9500 or 301/695-8200.

Merchandise



▲ Craftsmen have relied on original Titebond woodworker's glue for over 30 years. Today, there's a Titebond II formula that behaves much like the original product, except that it's water-resistant. So, you can use it on exterior projects such as patio furniture and birdhouses. Price: about \$5.90 for 16 oz. Franklin International, Dept. WD, 2020 Bruck St., Columbus, OH 43207; 800/347-4583 or 614/443-0241.

▼ Few moldings from any era match the complexity or elegance of those from the Victorian period. Manufacturing these moldings on your own can be a huge job. The good news is that Silverton Victorian Millworks can do the work for you. All types of moldings (including standard and custom-made arches) available in a wide price range. Silverton Victorian Millworks, P.O. Box 2987-WM6, Durango, CO 81302; 800/933-3930.

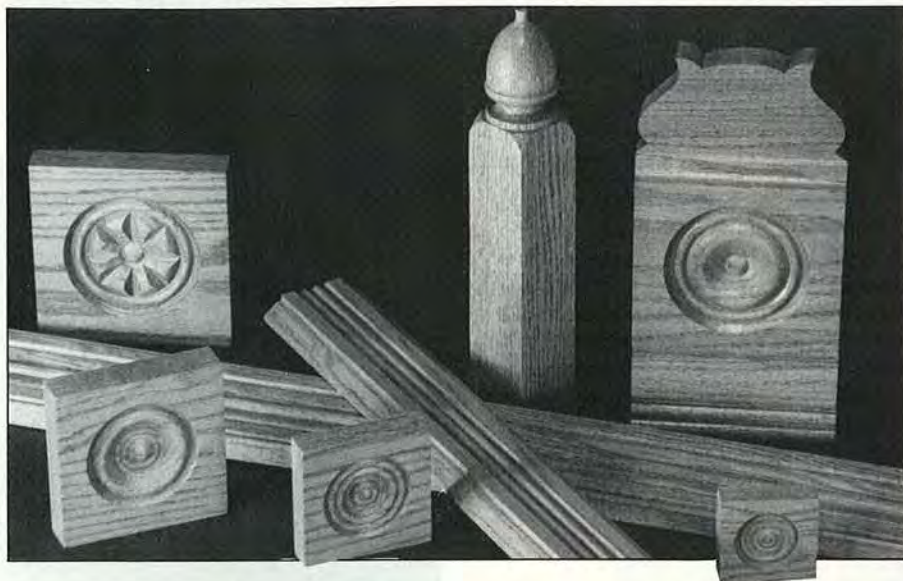

▶ Have you always dreamed of owning a finely crafted European workbench? Well, stop dreaming. The precision-made and affordable Lervad 610 Workbench is made of beech and imported from Denmark. The 59"-long, 27½"-wide, 32¼"-high bench folds out of the way when necessary. Price: \$449 plus shipping (usually not more than \$80 within the U.S.). Leichtung Workshops, 4944 Commerce Parkway, Dept. P130, Cleveland, OH 44128; 800/542-4467 (product info.), 800/654-7817 (catalog requests), or 800/321-6840 (orders).



Medley of Merchandise



◀ Here's the light you've been trying to find for that next display case or cabinet. The Pico Lampi puts out 4 watts of fluorescent light, equivalent to 15-20 watts of incandescent light, at a fraction of the energy cost. It has electronic circuitry instead of ballast, so it's lightweight. The 6.875×1.125" unit lists for \$11.95. Lampi, Dept. WD, P.O. Box 1769, Huntsville, AL 35807; 800/633-7256 or 205/830-3110.

▼ You can repair rickety chairs, wobbly drawers, and other projects with loose joints by applying Faber-Castell's UHU Woodtite Wood Sweller to the affected area. The product has a thin consistency, so it quickly penetrates and permanently swells wood fibers. Suggested retail price: \$2.49-\$3.99 for 1.69 oz. See your local homecenter.

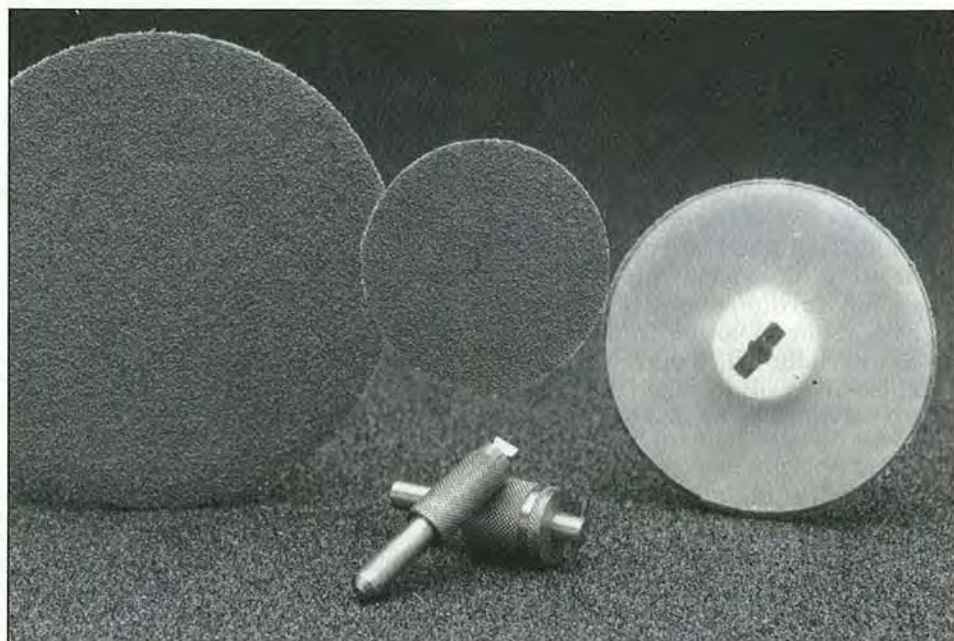

▲ Saving time counts when you're taking on a sanding job. The Quick Disc Connect (QDC) System allows you to change sanding discs in seconds. Discs from 3/4" to 4" in diameter snap onto a 1/4" mandrel with just a quarter turn. Available grits: 36 through 240. Klingspor Abrasives, Dept. WD, 2555 Tate Blvd., S.E., P.O. Box 2367, Hickory, NC 28603; 800/228-0000 or 704/322-7238.



◀ Few new homes have this type of ornamental molding, but you can buy and install molding such as this in your home. The manufacturer specializes in products that capture the classic detail of plaster moldings while retaining the warmth and workability of wood. Ornamental Mouldings Limited, Dept. WD, 289 Marsland Drive, P.O. Box 336, Waterloo, Ont. Canada N2J 4A4; 519/884-4080.



▲ Most throwaway dust masks are not approved for woodworking dusts. This one is. The 3M Sanding & Fiberglass Insulation Respirator costs \$3.99 to \$5.99. Consumer Relations, Dept. WD, 3M DIY Division, 3M Center, Building 515-3N-02, St. Paul, MN 55144.

▶ You won't find these specialty mirrors down at your local glass or hardware store. The Mirrora Collection consists of small beveled mirrors that are perfect for hand mirrors, pocket mirrors, and other projects. Call for free literature; \$50 minimum order. Floral Glass & Mirror, Dept. WD, 895 Motor Parkway, Hauppauge, NY 11788; 800/647-7672 or 516/234-2200.

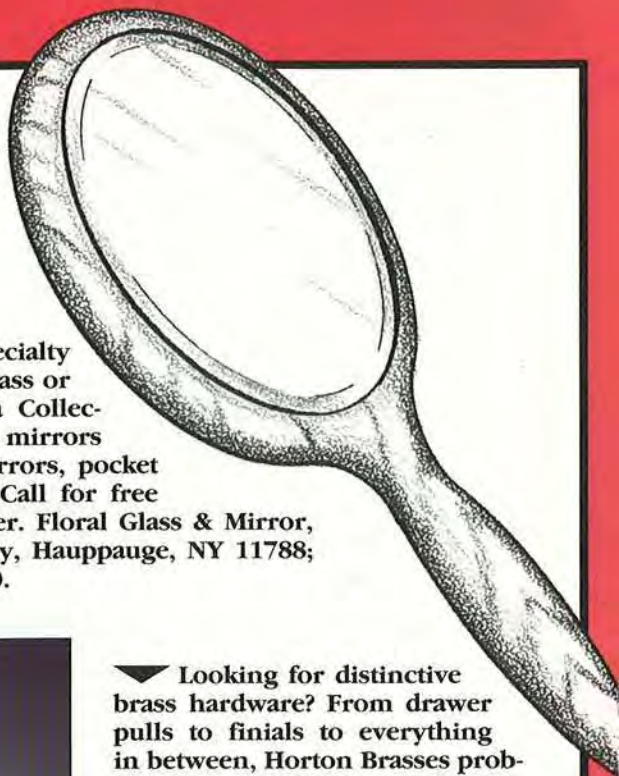

▲ Many times it's easier and less expensive to repair damaged or rotted wood than to replace it. Mr. Mac's Wood Fix rebuilds deteriorating wood and protects it from further damage. You also can use the two-part product to fill cracks and gaps. List price: \$14.99 for 4 pounds (makes one quart). Mr. Mac's Products, Dept. WD, 111-F Creek Ridge Road, Greensboro, NC 27406; 800/333-3262.

▼ Looking for distinctive brass hardware? From drawer pulls to finials to everything in between, Horton Brasses probably has something to suit your project and pocketbook. Horton Brasses, Dept. WD, Nooks Hill Road, P.O. Box 95, Cromwell, CT 06416; 203/635-4400.



◀ True to its name, the Megarack will support up to 1,200 pounds on each shelf. Using just a mallet or hammer, you can assemble the shelf into a 36"-wide, 72"-high shelving unit or into a workbench about half that high. Suggested retail price: \$79.95 to \$105.95. The Hirsh Co., Dept. WD, 8051 Central Park, Skokie, IL 60076; 800/872-3279 or 708/673-6610.



Medley of Merchandise

► One of the critical factors determining wood quality is its moisture content. The Mini-Ligno moisture meter fits in your pocket and instantly and accurately reads moisture content between 6 to 20 percent, with pins for measuring depths of $\frac{3}{16}$ " or $\frac{7}{16}$ ". Price: \$110. Lignomat USA, Dept. WD, P.O. Box 30145, Portland, OR 97230; 800/227-2105 or 503/257-8957.



▲ Unlike some wood putties, Elmer's Fill 'N Finish Wood Filler won't sting your nostrils with pungent solvent odors. Its forgiving formula makes the product easy to use for do-it-yourselfers of all skill levels. List price for a pint: \$5.49. Borden, Dept. WD, 180 E. Broad St., HPPG, Columbus, OH 43215-3799; 614/225-4511.

◀ Odds and ends—we all have 'em, and most of us need better ways to store and organize these goods. Here's an easy way. Keepers Rough Tote Storage Containers have tight, snap-on lids and easy-grip handles, and come in five sizes ranging from 1 to 18 gallons. List prices range from \$2.99 to \$17.99. Rubbermaid Advertising Services, Media Dept. HS-0368-W, 717 W. Smith Road, Medina, OH 44258.



▲ **Attention scrollsawers:** If you're looking for an exciting challenge that will result in an impressive project, stay tuned. The Dome Clock Pattern will help you build this impressive 52"-high, 24"-wide, and 12"-deep project. Price: \$22.95. Order No. 71095 from Klockit, Dept. WD, P.O. Box 636, Lake Geneva, WI 53147; 800/556-2548.

▶ **Wainscoting adds a distinctive decorative touch** to many rooms, and the Cedarpro Incense Cedar Wainscot Kit lets you get the job done with just a few hand tools. The kit contains enough materials to cover 18 square feet (six running feet), and instructions. List price: \$34.95. P&M Consumer Products, Dept. WD, 2423 W. March Lane, P.O. Box 7958, Stockton, CA 95267; 800/243-7010 or 800/542-3436 (Calif.) or 209/957-6850.

▼ **Who says glue has to be colorless?** Elmer's GluColors come in six neon colors and work great for many craft items and decorative woodcarvings. A three-pack lists for \$4.99. Individual colors list for \$1.69. Borden, Dept. WD, 180 E. Broad St., HPPG, Columbus, OH 43215-3799; 614/225-4511.



▲ **You can save money by drying your own lumber** with the TR250 Lumber Dryer—the smallest wood dryer in America. Once you build the kiln and add the TR250 you can dry 50 to 250 board feet for just 2¢ to 4¢ per board foot. Kiln construction guide included. List price: \$1,150. Ebac Lumber Dryers, Dept. WD, 106 John Jefferson Road, Suite 102, Williamsburg, VA 23185; 800/433-9011 or 804/229-3038.



Medley of Merchandise



▼ Stylish protective eyewear? Is there such a thing? Arriva Protective Eyewear provides you with a high level of good looks and protection. A specially designed orbital underbar helps protect from below as well as front, side, and above. Price: \$6 to \$7. U.S. Safety, Dept. WD, 8101 Lenexa Drive, P.O. Box 15965, Lenexa, KS 66215-5965; 913/599-5555.

▼ Many home workshops have some perforated hardboard on the wall for hanging tools. But as we all know, the typical metal hooks made for pegboard usually fall short of fulfilling our needs. That's where Roughneck Tool Organizers come in. They help you hang all sorts of hand tools, and measuring and layout devices. Small parts such as nuts and bolts store in 4"-deep bins. Rubbermaid Advertising Services, Media Dept. HS-0271-W, 717 W. Smith Rd., Medina, OH 44258.

▼ You can take on veneering without a lot of specialized tools, provided you've got Wood-Works Natural Wood Veneer from Red Devil on your side. The flexible veneer sheets come in four species—cedar, cherry, oak, and walnut—and can be applied to virtually any surface with standard adhesives. The sheets vary in price from \$7.99 to \$24.99 depending on size (from 18×24" to 36×48"). Red Devil, Dept. WD, 2400 Vauxhall Rd., P.O. Box 194, Union, NJ 07083-1933; 800/247-3790 or 908/688-6900.

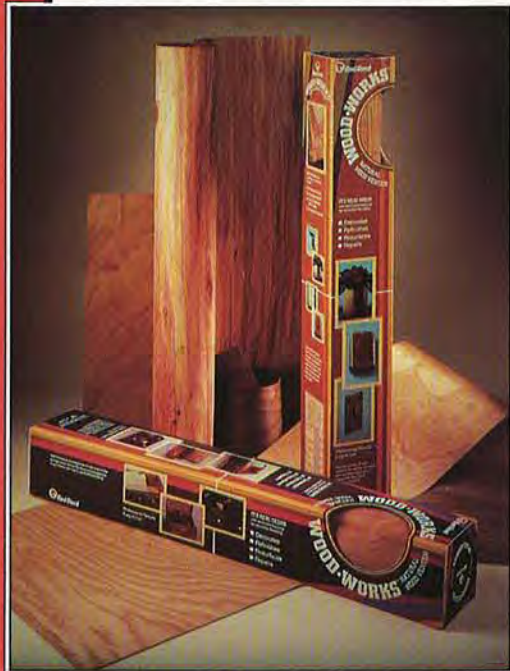
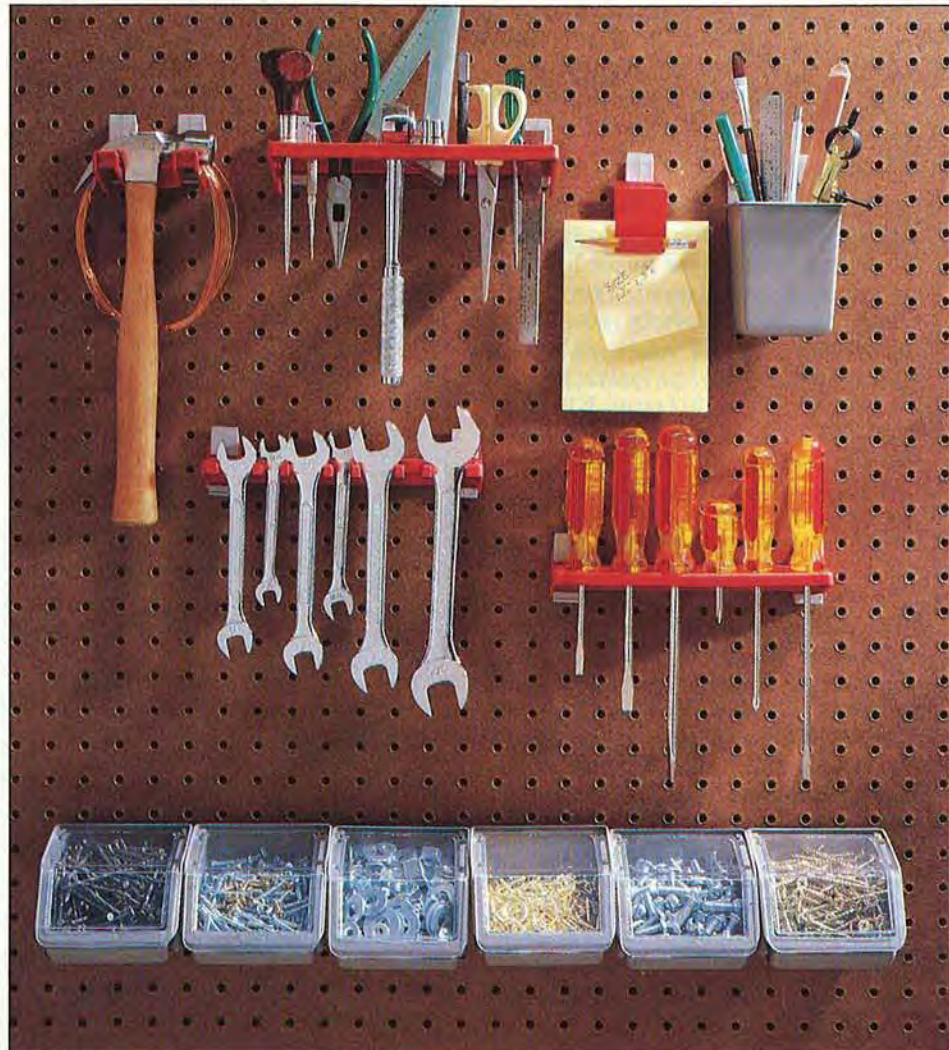



▲ The Antique Hardware Store carries the kind of hardware you'll find in thousands of old homes, but in few if any hardware stores. The solid-brass Victorian door hinge shown *above* sells for about \$30. Similar hinges and other hardware are available in cast iron as well. The Antique Hardware Store, Dept. WD, Rd. 2, Box A, Kintnersville, PA 18930; 215/847-2447.

▶ Because of its slim design, the Electronic Lampi will go where other work lights can't. And, it's lightweight, shatter-resistant, rustproof, and can withstand shock and moisture. It comes with a 10' cord, retractable hook, and 8-watt fluorescent tube that's equivalent to a 40-watt incandescent bulb. Lampi, Dept. WD, P.O. Box 1769, Huntsville, AL 35807; 800/633-7256 or 205/830-3110.



▶ If you prefer traditional gluing methods, then try Franklin's Hide Glue (about \$4.50 for 8 oz.). The adhesive also helps you achieve a crackled finish when applied beneath a latex paint. Franklin International, Dept. WD, 2020 Bruck St., Columbus, OH 43207; 800/347-4583 or 614/443-0241.

▶ With the Minuteman Deluxe Dupli-Kit you can reproduce missing furniture parts in 4 to 6 minutes. The molded parts feel and look like real wood and can be colored and finished to match original wood. An instructional video and manual show how to replace Victorian carvings, pressed wood ornamentation, turned finials, glass knobs, brass hardware, and more. Price: \$395. Minuteman, Dept. WD, 115 W. Monroe St., P.O. Box 8, Waterloo, WI 53594; 800/733-1776 or 414/478-2001.



▶ Circuit breakers will protect your equipment, but to protect yourself from electrical shock, it sure helps to have a Ground-Fault Circuit Interrupter (GFCI) between your power tool and the wall outlet. The Six-Outlet Power Strip with Shock Protection from Woods Wire Products increases your available outlets and has a built-in GFCI. A test button verifies that the device is working, and a fault light indicates that the unit has tripped. List price: \$21.60. Woods Wire Products, Dept. WD, 510 3rd Ave. S.W., P.O. Box 2675, Carmel, IN 46032; 800/428-6168 (consumer helpline) or 317/844-7261.

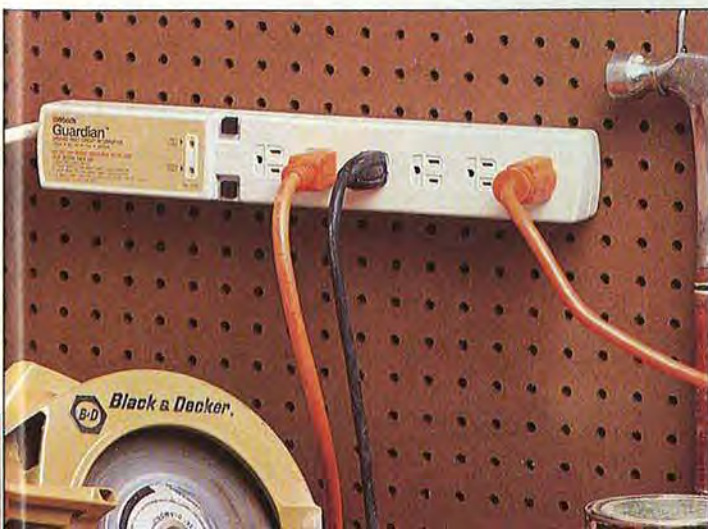

Medley of Merchandise

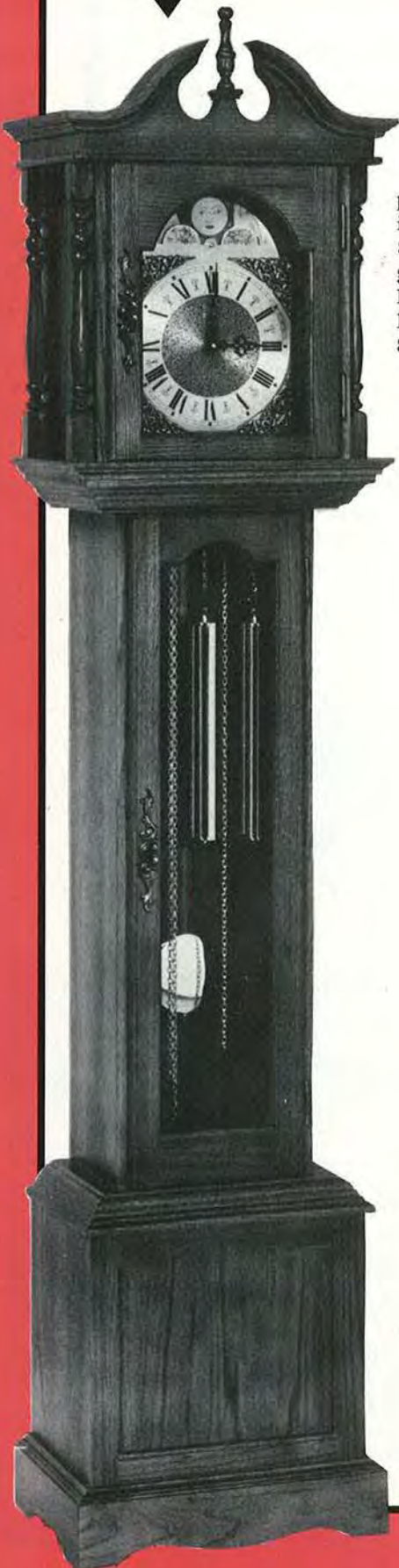

◀ Building a grandfather clock can be a huge project, so why not get some help? The design of the Model 120 Newport Clock Kit fits most decors. It's available in cherry, oak, or black walnut. Price: \$199.50 for the case. Movement and beveled glass priced separately. Emperor Clock Co., Dept. WD, Emperor Industrial Park, P.O. Box 1089, Fairhope, AL 36533-1089; 800/642-0011 or 205/928-2316.

▶ For overhead and vertical bonding projects, you need an adhesive that's thick so it won't drip or sag. Devcon's 5-Minute Epoxy Gel fits the bill. Price: Less than \$3 for 1 oz. Devcon Consumer Division, Dept. WD, 780 A.E.C. Drive, Wood Dale, IL 60191; 800/227-7950 or 708/350-2710.



▼ With the Assorted Woodscrew Kit, you'll have most of the screws you'll ever need, all neatly organized. The kit contains 12 bins, each holding 100 screws in popular sizes ranging from No. 6× $\frac{3}{4}$ " to No. 10×2 $\frac{1}{2}$ ", two screwdrivers, and two power-tool bits (\$47.95 ppd.). Available with Phillips (SCDKPMX) or square-recess (SCDKSMX) heads. Trend-Lines, Dept. WDEM, 375 Beacham St., Chelsea, MA 02150; 800/767-9999.





◀ No matter what sort of fireplace you have, chances are Majestic has a trim kit, mantel, and mantel shelves to help you enhance it. Six complete mantel kits range from the simple and classic to the intricately detailed, from the broad and hefty to the contemporary. Majestic, Dept. WD, 1000 E. Market St., Huntington, IN 46750; 800/525-1898 or 219/356-8000.

▶ It seems like every antique shop or flea market has one: a once-beautiful picture frame badly in need of repair. Now, you can restore these treasures of yesteryear with the Minuteman Deluxe Frame Kit. It contains all the special tools, materials, and instructions you'll need to tackle nearly any frame. Price: \$499.95. Minuteman, Dept. WD, 115 W. Monroe St., P.O. Box 8, Waterloo, WI 53594; 800/733-1776 or 414/478-2001.



▼ Although it weighs only 45 pounds, the Ripsaw Portable Sawmill makes short work of logs up to 20' in diameter. Three electric and six gas models available. Prices range from \$1,049 to \$1,974. Better Built Corp., Dept. WD, 845 Woburn St., Wilmington, MA 01887; 508/657-5636.

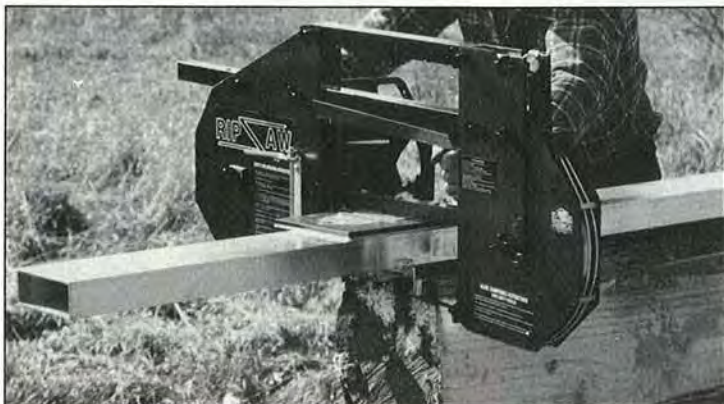

▶ Heavy or sharp workshop debris can rip through standard trash bags, turning a minor mess into a major disaster. Ruffies Shop Sak Heavy-Duty Clean-Up Bags are 3 mils thick, and guaranteed to hold up to 100 pounds. Available at retail outlets across the country.



Medley of Merchandise

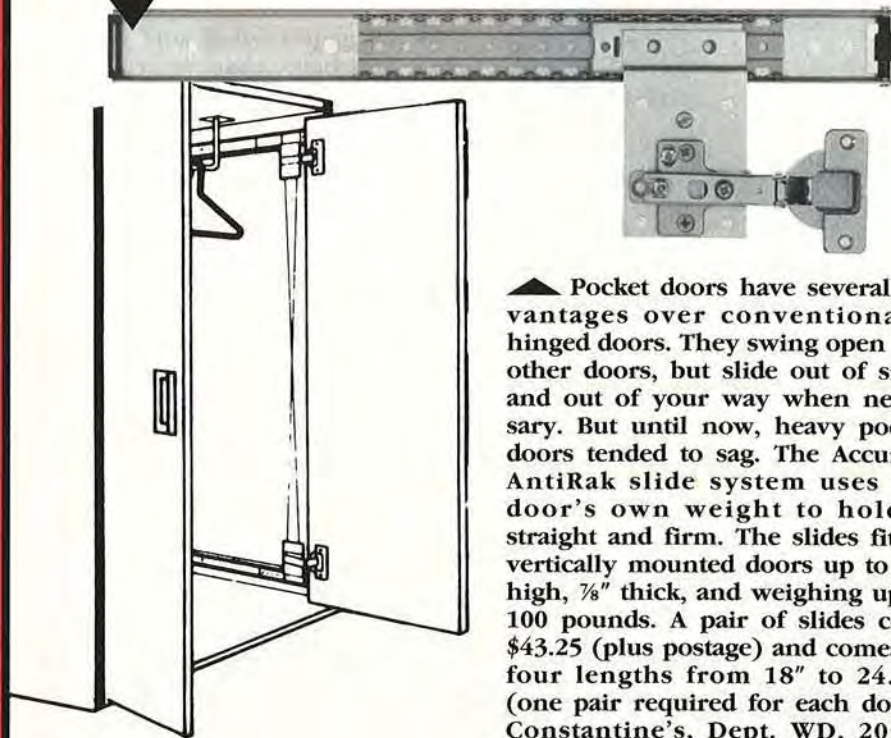

▲ Pocket doors have several advantages over conventionally hinged doors. They swing open like other doors, but slide out of sight and out of your way when necessary. But until now, heavy pocket doors tended to sag. The Accuride AntiRak slide system uses the door's own weight to hold it straight and firm. The slides fit all vertically mounted doors up to 60" high, 7/8" thick, and weighing up to 100 pounds. A pair of slides costs \$43.25 (plus postage) and comes in four lengths from 18" to 24.29" (one pair required for each door). Constantine's, Dept. WD, 2054P Eastchester Road, Bronx, NY 10461; 800/223-8087 or 212/792-1600.

▼ Although it has the looks to be appropriate in your dining room or kitchen, the Studio Lamp and Lift has a feature that you might appreciate in your workshop. The lifts allow the fluorescent fixture to be raised or lowered in a drop ranging from 16" to 62" with an easy pull or push—no chains! Available in three sizes from 21" to 51" long. The 27" model with two lifts lists for \$52.50. Lampi, Dept. WD, P.O. Box 1769, Huntsville, AL 35807; 800/633-7256 or 205/830-3110.



▶ The Casteel Series of heavy-gauge, black epoxy-coated shelving helps you organize your entire garage or workshop. Ventilated design allows good air circulation and reduces dust buildup. Clairson International, Dept. WD, 720 S.W. 17th St., Ocala, FL 32674; 800/221-0641 or 904/351-6100, ext. 4065.

▶ Here's just the ticket for any table project, from an elegant dining-room piece to a country-style model for the kitchen. The manufacturer also supplies cabriole and ball-and-claw units in a variety of species. Adams Wood Products, Dept. WD-1, 974 Forest Drive, Morristown, TN 37814; 615/587-2942.



▶ Because they're made of an industrial-grade Resinite polymer, Roughneck toolboxes are light and won't rust or dent. A comfortable, recessed handle adds convenience to carrying and storing. The model 7714 shown lists for \$24.95. Rubbermaid Advertising Services, Media Dept. HS-0362-W, 717 W. Smith Road, Medina, OH 44258.



▼ ZAR Wood Patch has an easy-to-use latex formula that contains pulverized wood for well-disguised repairs. Once the product dries, you can nail, saw, sand, or drill it. It will take paint, varnish, polyurethanes, and stains, and can be used indoors or outdoors. United Gilsonite Laboratories, Dept. WD, P.O. Box 70, Scranton, PA 18501; 800/845-5227 or 717/344-1202.



▼ If you'd like an old-fashioned woodworking bench, and don't mind a challenging project, here are some bench screws turned from birch and maple. Both the shoulder vise screw (top) and bench screw (bottom) sell for \$74.95 each (some instructions included; intermediate woodworking skills required for installation). The supplier also carries laminated beech benchtops. Beech Tree Hand Tool Co., Dept. WD, P.O. Box 21448, 4607 Ivanhoe Place, Columbia Heights, MN 55421; 612/572-0918.

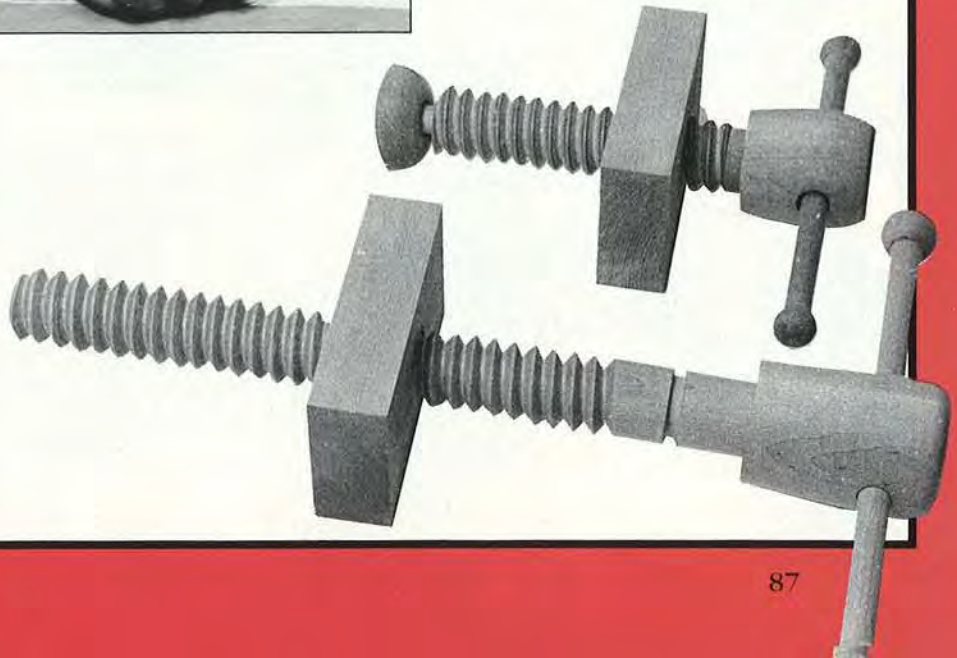

Medley of Merchandise



◀ If you're concerned about unauthorized use of your power tools by children or others, the Honeywell Power LockOut Control may be just what you're looking for. No special installation is required; just plug it into your outlet and turn the key. The device also provides power-surge protection. Price: \$31.49. Techmart, Dept. WD, Suite 139, 2745 Winnetka Ave. North, Minneapolis, MN 55427; 800/688-1280.

▶ Looking for the fastest epoxy around? Here it is. Sure Shot Super Epoxy (\$4.99 for 1 oz.) cures in one minute, and comes with a two-part syringe and mixing nozzle. Devcon Consumer Division, Dept. WD, 780 A.E.C. Drive, Wood Dale, IL 60191; 800/227-7950 or 708/350-2710.

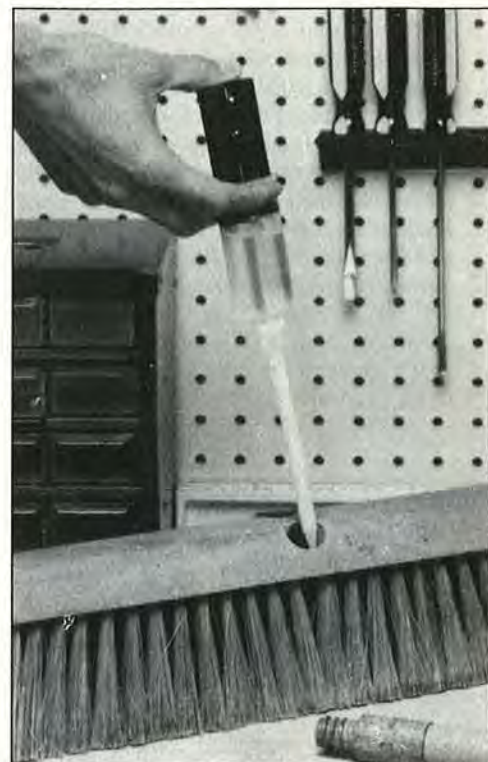

▼ Whether you're completely renovating your kitchen or just doing a little updating, you ought to take a look at the various cabinet organizers from Cabinet Maid. Dozens of versions of the coated-wire baskets and racks are available. The Dual Slide-Out Basket Sets shown here give you new storage space, and improve visibility and access. Three sizes fit virtually all cabinets. Clairson International, Dept. WD, 720 S.W. 17th St., Ocala, FL 32674; 800/221-0641 or 904/351-6100, ext. 4065.



▶ Even the best blades and router bits won't perform well once covered with wood pitch. Pitch & Gum Remover is guaranteed to eliminate these problem buildups. Postage-paid price: \$6.95 for one 18-oz. can (AG100). Trend-Lines, Department WDEM, 375 Beacham St., Chelsea, MA 02150; 800/767-9999.



▶ The Lido Brass Gourmet Rail System provides a decorative accent to any kitchen and helps you get things organized. Other available finishes include chrome, satin stainless, and powder-coated white. Lavi Industries, Dept. WD, 27810 Ave. Hopkins, Valencia, CA 91355; 800/624-6225 or 805/257-7800.

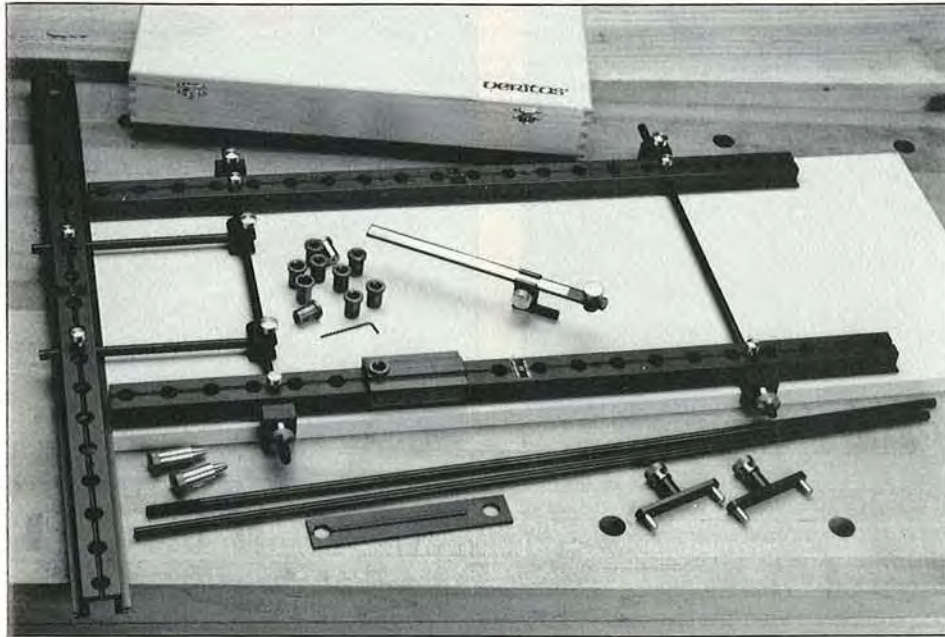

▲ You can build your own kitchen cabinets with just an electric drill, tablesaw, some clamps, and a few basic hand tools if you own the Veritas 32 Cabinetmaking System. The product consists of a rigid frame that you transfer from panel to panel. With the jig in position, you can precisely bore all necessary holes for joinery, shelf supports, and European-style hardware. List price: \$295. Veritas Tools, Dept. WD, 12 E. River St., Ogdensburg, NY 13669.

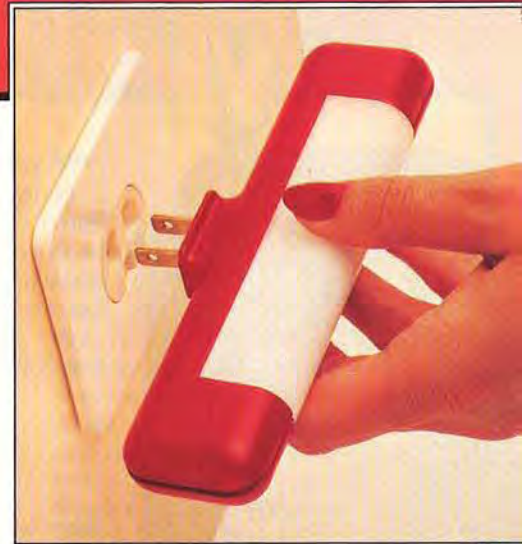

▲ Wherever you need a little light, all you need to do is plug in Micro—The Anywhere Light from Lampi. It's ideal as a supplemental light for dark workshop corners and garage surfaces, lasts up to two years, and costs less than one cent to operate for 10 hours. List price: \$9.95. Lampi, Dept. WD, P.O. Box 1769, Huntsville, AL 35807; 800/633-7256 or 205/830-3110.



▼ If you have facial hair, or just don't find most respirators to be very comfortable, the Airstream Dust Helmet is for you. A belt-mounted, rechargeable battery pack and fan circulate fresh air to the front of your face for 10 continuous hours. Price: \$299. Airstream, Dept. WD, 16 Division St., West, P.O. Box 975, Elbow Lake, MN 56531; 800/328-1792 or 218/685-4457.



Medley of Merchandise



◀ You can build a wall clock that will make a delightful addition to any room with the Spirit of Liberty Wall Clock Kit. It's available in walnut, cherry, or oak, and plays Westminster chime on rods. List price: \$699. Kuempel Chime Clock Works & Studio, Dept. WD, 21195 Minnetonka Blvd., Excelsior, MN 55331; 800/328-6445 or 612/474-6177.

▶ Woodworkers everywhere are using plate joiners and compressed wooden biscuits (plates) for joining cabinets, furniture, and countless other projects. Lamello, a Swiss company on the leading edge of plate joinery, makes two new plates and a hinge for increasing the usefulness of any plate joiner. With Lamello Simplex Interlocking Plates, shown *middle right*, you can make knockdown furniture that disassembles without tools. List price: \$43 for 50 pairs. For hard-to-clamp projects, the K-20 Clamping Plates, shown *bottom right*, have ribs that hold workpieces together as the glue dries. List price: \$13 for 50 plates. You even can buy hinges that fit into plate-joiner-made mortises. The Lamello Duplex Hinge, shown *top right*, comes in black, nickel, or brass. List prices range from \$36 to \$50 for 20 hinges. Colonial Saw, Dept. WD, 100 Pembroke St., P.O. Box A, Kingston, MA 02364; 617/585-4364.

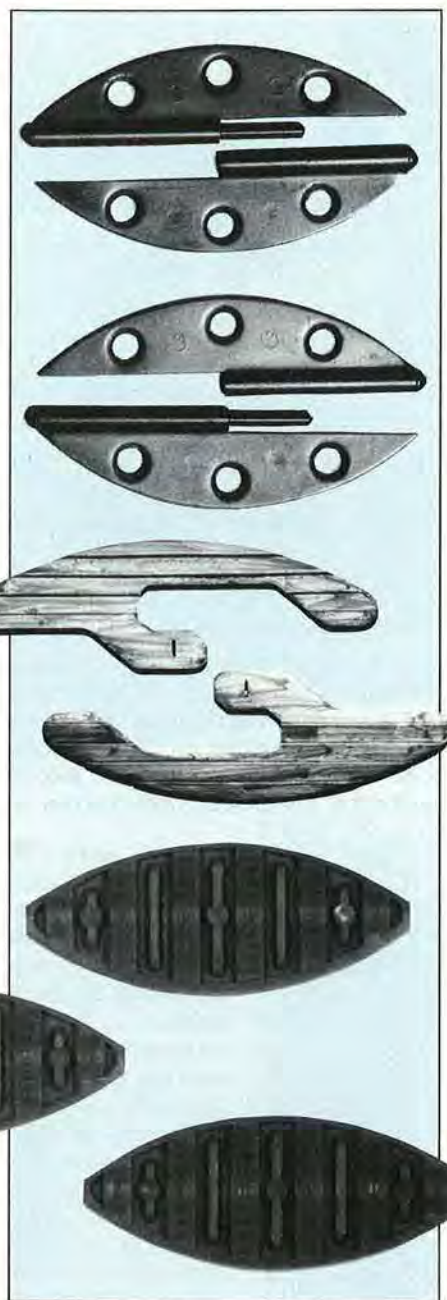

▶ Those of us who spend long hours in the shop can benefit greatly from placing antifatigue mats wherever we stand for long periods. The Dynamat, a $\frac{3}{8} \times 24 \times 36$ " plastic foam mat, helps prevent back pain and leg strain. Price: \$18.99. Dynamat, Dept. WD, 399 27th Avenue N.E., Minneapolis, MN 55418; 612/788-7923.



▲ The Power Cat 300 brings light, ventilation, and a power outlet to any work area. It moves fumes and dust away from you when you're woodworking or applying finishes. In a hot attic or under the hood of a car, it will cool you and light your way. List price: \$199. FASCO Consumer Products, Dept. WD, 810 Gillespie St., P.O. Box 150, Fayetteville, NC 28302; 800/334-4126 or 919/483-0421.



◀ Water can cause loads of damage to tools and machinery, so if you work in a basement or other area subject to water leakage, it may make sense to invest in a water alarm. This model has a remote sensor that you can place up to 50' away from the alarm (unit comes with 6' of wire). Postage-paid price: \$17.99. Sonin, Dept. WD, 672 White Plains Road, Scarsdale, NY 10583; 800/223-7511 or 914/725-0202.

▼ Here's a product that will be appreciated by anyone who has done a lot of work with traditional contact adhesives. DAP's 3030 Water Dispersed Spray Grade Contact Cement is water-based with a high solids content, so it releases only a mild odor. You also can brush on the product. Price: \$30-\$40 for a gallon. DAP Inc., Dept. WD, P.O. Box 277, Dayton, OH 45401-0277; 800/543-3840 or 513/667-4461.

▼ You can install a patterned wooden floor in your home with Pattern-Plus flooring. The flooring stands up to heavy traffic because it has an acrylic-impregnated finish. Numerous patterns and colors available. Hartco Quality Wood Flooring, Dept. WD, 900 S. Gay St., Suite 1902, Knoxville, TN 37902; 615/544-0767.

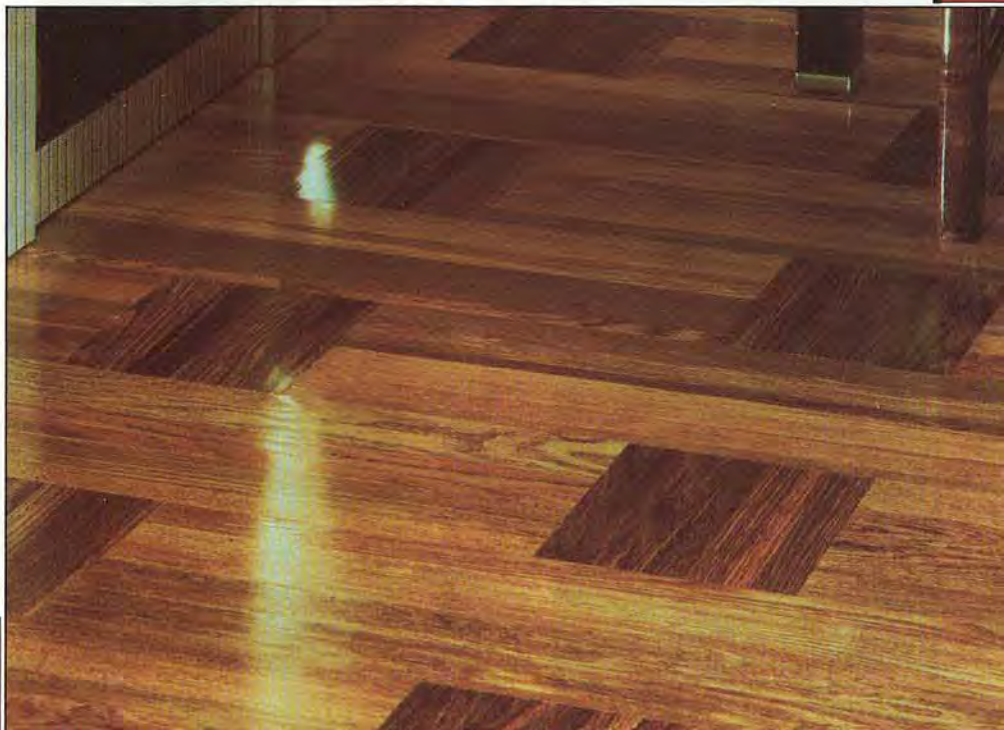

M Manufacturers' Listing

Print this article

AEG Power Tool Corp., Dept. WD,
P.O. Box 6003, Three Shaw's Cove,
New London, CT 06320-1777;
800/243-0870 or 203/447-4600

Accuset Tool Co., Dept. WD,
P.O. Box 1088, Troy, MI 48099;
313/879-0030

Adams Wood Products, Inc.,
Dept. WD-1, 974 Forest Drive
Morristown, TN 37814; 615/587-2942

Adjustable Clamp Co., Dept. WD,
417 N. Ashland Ave., Chicago, IL
60622; 312/666-0640

Advanced Machinery Imports,
Dept. WD, P.O. Box 312,
New Castle, DE 19720;
800/648-4264 or 302/322-2226

Airstream, Dept. WD,
16 Division St., West, P.O. Box 975,
Elbow Lake, MN 56531;
800/328-1792 or 218/685-4457

American Clamping Corporation,
Dept. WD, 50 Franklin St.,
P.O. Box 399, Batavia, NY 14021;
800/828-1004 or 716/344-1160

American Tool Companies, Inc.,
Dept. WD, P.O. Box 337,
DeWitt, NE 68341; 402/683-2315

Antique Hardware Store, Dept. WD,
RD2, Box A, Kintnersville, PA 18930;
800/422-9982 or 215/847-2447

Beech Tree Hand Tool Co., Dept. WD,
P.O. Box 21448, 4607 Ivanhoe Place,
Columbia Heights, MN 55421;
612/572-0918

Benjamin Moore & Co., Dept. WD,
51 Chestnut Ridge Rd.,
Montvale, NY 07645; 201/573-9600

Bessey
(see American Clamping Corp.)

Better Built Corp., Dept. WD,
845 Woburn St., Wilmington,
MA 01887; 508/657-5636

Black & Decker, Dept. WD,
10 North Park Dr., P.O. Box 798,
Hunt Valley, MD, 21030;
800/762-6672 or 301/527-7000

Borden, Dept. WD, 180 E. Broad St.,
HPPG, Columbus, OH 43215-3799;
614/225-4511

Bosch (see yellow pages
for your nearest dealer)

BossWorks, Inc., Dept. WD,
889 Valley Park Dr., P.O. Box 469,
Shakopee, MN 55379; 612/496-4297

Campbell Hausfeld, Dept. WD,
100 Production Dr.,
Harrison, OH 45030; 800/634-4793

Carlisle Plastics (see your local hard-
ware store or homecenter)

Cascade Tools Inc., Dept. WD,
P.O. Box 3110,
Bellingham, WA 98227;
800/235-0272 or 206/647-1059

Continued on page 94

PORTER CABLE	
309	LAMINATE TRIMMER..... \$ 92
100	7.8 HP ROUTER..... 95
314	4 1/2" TRIM SAW..... 128
330	SPEED BLOCK FINISHING SANDER-1/4 SHT..... 59
351	3" X 21" BELT SANDER..... 129
352	3" X 21" BELT SANDER WITH DUST BAG..... 131
360	3" X 24" BELT SANDER WITH DUST BAG..... 178
361	3" X 24" BELT SANDER..... 169
362	4" X 24" BELT SANDER WITH DUST BAG..... 185
363	4" X 24" BELT SANDER..... 179
506	1/2 SHEET FINISHING SANDER..... 112
555	BISCUIT JOINER WITH STEEL CASE..... 164
5116	OMNI JIG..... 259
6931	PLUNGE ROUTER BASE..... 77
7310	LAMINATE TRIMMER, 5.6 AMP..... 85
7335	5" RANDOM ORBIT SANDER-VARIABLE SPD..... 127
7336	6" RANDOM ORBIT SANDER-VARIABLE SPD..... 132
7518	3 1/4 HP FIXED BASE ROUTER-5 SPEED..... 259
7519	3 1/4 HP FIXED BASE ROUTER-SINGLE SPD..... 224
7536	2 1/2 HP ROUTER-SINGLE SPEED..... 204
7537	2 1/2 HP ROUTER-"D" HANDLE..... 214
7538	3 1/4 HP PLUNGE ROUTER-SINGLE SPEED..... 224
7539	3 1/4 HP PLUNGE ROUTER-5 SPEED..... 259
7549	BAYONNET SAW, BOSCH, PC OR UNIV BLADES..... 139
9118	PORTA PLANE KIT W/CASE, CARBIDE BLADE..... 169
9853	12 V, 3/8" CDLESS DRILL KIT-KYLS 2 SPD, VAR..... 149
9854	12 V, 1 1/2" CDLESS KIT, VAR SPD W/GEARED CK..... 159
9505	COMMEMORATIVE 505 WITH OAK CASE..... 135
97310	LAMINATE TRIMMER KIT W/4 BASES & CASE..... 184

Panasonic	
EY6207BC	12 VOLT CORDLESS KIT, 1 1/2" KEYLESS CK, 2 SPD VSR, 15 MIN CHRG, 2 BAT, CASE!..... 235
EY6058C	12V 3/8" CK, KYLS 2 SPD VSR W/2 BAT, 1HR..... 169
EY6258C	12V 3/8" CK, KYLS 2 SPD VSR W/15 MIN CHRG..... 179
EY6008C	12 VOLT 3/8" HAMMER DRILL KIT 15 MINUTE CHARGE, INC. 2 BATTERIES & CASE-NEW!..... 225

MILWAUKEE	
0228-1	3/8" VSR PISTOL GRIP DRILL..... \$ 99
6014	1/2 SHEET FINISHING SANDER..... 116
6017	1/4 SHEET FINISHING SANDER, DUSTLESS..... 54
6365	7 1/4" CIRCULAR SAW..... 117
6511	2 SPD SAWZALL W/CASE & BLADES..... 128
6528	SUPER SAWZALL WITH CASE & BLADES..... 165

HITACHI	
TR8	1 1/2 HP PLUNGE ROUTER..... \$ 117
TR12	3 HP PLUNGE ROUTER..... 168
C8FB	8 1/2" SLIDE COMPOUND MITER W/24T BLD..... 448

INTERNATIONAL TOOL CORPORATION
1939 TYLER STREET, HOLLYWOOD, FL 33020
IN USA, CANADA, PUERTO RICO & US VIRGIN ISLANDS
1-800-338-3384
FAX US YOUR ORDER AT 1-305-927-0291
FREE FREIGHT & SAME DAY SHIPPING
ON MOST ORDERS WITH \$25.00 MINIMUM PURCHASE

COD ADD \$5.00
(CASH, CASHIERS CHECK OR MONEY ORDER PLEASE!)

3 1/4 HP PLUNGE ROUTER, VARIABLE SPEED

freud ALL FREUD ROUTER BITS ARE 38% OFF OF LIST PRICES!

BOSCH

MODEL 1611EVS
\$228.00

3 1/4 HP PLUNGE ROUTER, VARIABLE SPEED

BOSCH ROUTER BITS ARE 40% OFF OF LIST PRICES!

MODEL	DESCRIPTION	PRICE
FT2000	3 1/4 HP PLUNGE ROUTER AFTER REBATE	145
LU88M008	8" X 48T ATB CROSSCUT THIN KERF	42
LU88M008	8" X 60T TCH NON FERROUS METALS	47
LU84M008	8" X 40T ATB COMBO WOOD BLADE	42
LU82M010	10" X 40T ATB COMBINATION WOOD	36
LU84M011	10" X 50T ATB COMBO WOOD BLADE	38
LU85M010	10" X 80T ATB CUT OFF-BEST FOR WOOD	55
LM72M010	10" X 24T FLAT TOP RIP BLADE-WOOD	36
LU87M010	10" X 24T RIP BLADE THIN KERF	37
LU88M010	10" X 60T CROSSCUT THIN KERF	43
LU88M010	10" X 72T TCH NON FERROUS METALS	64
LU92M010	10" X 80T TCH BEST FOR LAMINATES	68
LU98M010	10" X 80T TCH WOOD OR LAMINATES	68
TK203	7 1/4" X 24T THIN KERF	18
TK206	10" X 24T THIN KERF RIPPING	20
TK306	10" X 40T THIN KERF COMBINATION	25
TK906	10" X 50T THIN KERF CROSSCUT-COMBO	27
SD308	8" DADO SET WITH CARRYING CASE	116
WC104	4 PIECE WOOD CHISEL SET WITH CASE	39
WC106	6 PIECE WOOD CHISEL SET WITH CASE	52
WC110	10 PIECE WOOD CHISEL SET WITH CASE	79
FB107	7 PIECE FORSTNER BIT SET WITH CASE	49
CS106	6 PIECE CARVING SET WITH CASE	73
CS112	12 PIECE CARVING SET WITH CASE	129
88-100	9 PC BASIC ROUTER BIT SET-1 1/4" SHANK	104
90-100	15 PC ADVANCED SET-1 1/4" SHANKS	162
91-104	6 PC STARTER SET-PROFILE BITS-1 1/4" SH	114
94-100	CARBINET DOOR SET-1 1/2" SHANKS	154
EB100	EDGE BANDING SYSTEM-AFTER REBATE	194

freud

MODEL JS100

\$128.00 AFTER REBATE
BISCUIT JOINER W/ CARRYING CASE

WITH 1000 BISCUITS-\$134.00

PORTER-CABLE

MODEL 690

\$123.00

1 1/2 HP ROUTER W/1/4 & 1/2" COLLETS

BOSCH

MODEL 3283DVS

\$94.00

5" DUSTLESS, VARIABLE SPEED RANDOM ORBIT SANDER

SKIL FREE CARBIDE BLADE WITH SAW PURCHASE

MODEL	DESCRIPTION	PRICE
1605-02	BISCUIT JOINING MACHINE WITH CASE	\$119
2735-04	TOP GUN 12V W/2 BAT, CSE, VSR, KEYLESS	128
77	7 1/4" WORM DRIVE SAW INC. CARBIDE BLD	145
5550	7 1/4" CIRCULAR SAW W/CARBIDE BLADE	89
5660	8 1/4" 60 DEGREE PRO BEVEL SAW W/CBD	138
1575	3 3/4" PLANER W/CARBIDE BLADES	119

Panasonic

MODEL EY571BC

\$149.00

9.6V VS DRIVER DRILL W/2 BATTERIES CASE, CHARGER, KEYLESS CHUCK, 1 HR CHARGE

RYOBI

MODEL TS251U

\$159.00

10" MITER SAW WITH FREUD LU85M010-10" X80T BLADE - \$215.00!

BOSTITCH

MODEL N60FN

OUR PRICE \$335.00

FINISH NAILER 1 1/4" - 2 1/2" CAPACITY W/DIAL A DEPTH GAUGE

Yem

MODEL 636

\$283.00

3 1/8" TRIANGULAR OSCILLATING SANDER FOR CORNERS

BOSCH

1272	3" X 24" BELT SANDER.....	\$ 164
1272D	3" X 24" BELT SANDER WITH DUST BAG.....	168
1273	4" X 24" BELT SANDER.....	170
1273D	4" X 24" BELT SANDER WITH DUST BAG.....	178
1273DVS	4" X 24" BELT SANDER W/BAG-VAR SPD.....	188
13700DVS	6" RANDOM ORBIT SANDER, VS W/BAG.....	224
1581VS	TOP HANDLE VS JIG SAW, ORBITAL.....	132
1582VSC	BARREL GRIP VS JIG SAW, ORBITAL.....	132
1601	1 HP ROUTER.....	99
1604	1 3/4 HP ROUTER.....	119
1608	LAMINATE TRIMMER.....	85
1608U	UNDERSCRIBE TRIMMER.....	117
1609K	LAMINATE TRIMMER INSTALLERS KIT.....	164
1609KX	SAME AS 1609K WITH UNDERSCRIBER.....	209
1654	7 1/4" PIVOTING SHOE CIRC. SAW.....	107
3272D	3" X 21" BELT SANDER WITH DUST BAG.....	129
3050VSRK	CORDLESS DRILL 9.6V W/2 BAT & CASE.....	126
1194VSR	3/8" HAMMER DRILL VARIABLE SPEED.....	154
1196VSR	1 1/2" HAMMER DRILL VSR, 6 AMP.....	99
1198VSR	1 1/2" 2" SPEED VSR HAMMER DRILL.....	130
11305	DEMOLITION HAMMER W/POINT & CASE.....	659
1001VSR	3/8" VSR DRILL 4.8 AMP.....	59
1021VSR	3/8" VSR DRILL 4.8 AMP HD CHUCK.....	84
1023VSR	1 1/2" VSR DRILL 4.8 AMP SIDE HANDLE.....	99

CALL FOR PRICES ON BOSCH ACCESSORIES!

RYOBI

JP155	6 1/8" VAR SPEED JOINTER.....	\$298
RE600	3 HP PLUNGE ROUTER VAR SPEED.....	205
BT2500	10" TABLE SAW, BENCH TOP.....	289
TS2930	15" MITER BOX.....	345
BE424	4" X 24" BELT SANDER W/BAG-VAR SPD.....	165
L1323ALSJK31	4" LONG SHOE PLANNER KIT.....	119

BOSTITCH

N80S	STICK NAILER-6 TO 16 PENNY.....	\$388
T405-1CT	ROOFING STAPLER.....	299
N12B	ROOFING NAILER.....	409
N50FN	FINISH NAILER-1" TO 2" CAPACITY.....	335
M811-812	T-NAILER 9/16" - 2 1/4" CAPACITY.....	429
T28-5	FINISHING STAPLER - 1 3/16" CAPACITY.....	269

DELTA

22-540	12" PORTABLE PLANER.....	\$410
31-460	4" BELT 6" DISC SANDER.....	138
40-560	16" TWO SPEED SCROLL SAW.....	184
31-080	1" BELT 5" DISC SANDER.....	94
31-050	1" BELT SANDER.....	77
40-150	15" SCROLL SAW.....	132

★The Woodworking Shows★
machinery
tools • supplies

Coming in 1991-1992

- Atlanta • Baltimore/Washington • Boston • Charlotte • Chicago • Columbus • Denver • Detroit • Ft. Lauderdale • Indianapolis • Kansas City • Milwaukee • North Jersey • No. California • Philadelphia • Portland • Richmond • Sacramento • San Bernardino • Seattle • So. California • St. Louis • Tampa • Twin Cities • Ventura

Call for free brochure
Monday - Friday 8 am - 5 pm Pacific Time
1-800/826-8257 or 213/477-8521



RESTORE FURNITURE for SECURE INCOME
Perfect 2nd Career

Make \$200-\$2,000 a day! Unlimited market; turn-key business. Free workshops. Set-Up Shop for \$2,999-\$9,999! Part-time or full-time. Great for men, women, families.

Make Molds*Veneer*Resilver Strip*Repair*Refinish

Business Preview Video \$19.95 - Catalog \$2.00

MINUTEMAN, INC., Ste. 17
Box 8, Waterloo, WI 53594

1-800-733-1776



HARDWOODS

EXOTIC & DOMESTIC OVER 75 SPECIES

LUMBER • PLYWOOD • VENEERS
TURNING SQUARES & BLANKS

COLLECTORS SAMPLE KIT
30 EXOTIC & DOMESTIC WOODS
1/2" x 3" x 6" SANDED FINISH

\$29.00 PLUS \$5.00 S&H

Ideal for: Collectors • Schools • Craftsmen • Cabinet & Furniture Makers • Architects • Designers



1-800-423-2450

WOODWORKERS Source

5402 S. 40th St. • Phoenix, AZ 85040
(602) 437-4415

YOU DO HAVE A CHOICE!!

A TABLE TOP FULL OF GROOVES... OR A DOYEL RADIAL ARM SAW FENCE SYSTEM WHICH CUTS ANGLES WITH ONLY 1 SAW GROOVE
... The miter fence adjusts 0-47° with easy to read 1/4° accuracy
... Quick adjustable ruled cut-off feature
... Instantly replaces wood fences up to 44"
... Rugged tempered aluminum construction

MADE IN U.S.A.

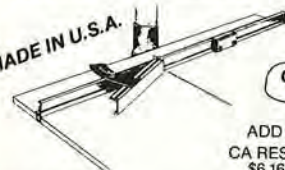

ONLY \$79.50

ADD \$4.75 S & H
CA RESIDENTS ADD \$6.16 (7% TAX)
SORRY, NO C.O.D.'S

SEND CHECK OR MONEY ORDER TO:

DOYEL ENTERPRISES
P.O. BOX 315
YORBA LINDA, CA 92686-0315 • (714) 666-1770

MONEY BACK GUARANTEE

Wood Carvers Supply, Inc.

P.O. Box 8928 G • Norfolk, VA 23503
(804) 583-8928 • Our 36th Year



Complete 76 page color catalog including over 2,000 carving tools, books & supplies such as carousel animal kits, gun checkering tools, ship model kits plus much more. We offer great service, quality products and a 30-day money back guarantee. Send \$2.00 for a 2-year subscription.

FULL-COLOR YARD CHARACTERS

No painting needed • Most 2/3 Life-Size • Just glue to plywood and cut out



We have dozens of holiday outdoor scenes for Christmas, Easter, Halloween - Santa & Sleigh, Santa's Workshop, the Nativity and more!

SATISFACTION GUARANTEED!



A. #1263 Reindeer\$10.50
B. #1256 Caroling Bears...\$8.25
C. #1250 Standing Santa...\$6.75

All prices include shipping charges
68-Page project plan catalog features hundreds of full-size woodworking plans #31...\$3.00

CRAFT PATTERNS™
Dept. WM, 3N345 N. 12th Street
St. Charles, IL, 60174-5598
Call TOLL-FREE (800) 747-1429

BRANDING IRON

Your Satisfaction Guaranteed

- Convenient torch heating
- Solid Brass—lasts years
- Special wording available
- Electric Models Start at \$46.95
- 2nd line—20 letters/spaces max.
- 1/4" letters
- Distinctive Border
- Add \$3.00 shipping and handling
- OH res. add 6% sales tax



Order by mail from:
BrandMark TO ORDER CALL TOLL FREE
462 Carthage Dr., Dept. W11-1
Beavercreek, OH 45434-5865
(513) 426-6843

\$26.00
1-800-323-2570
8:00-5:00 EASTERN TIME

BUILD THIS CLASSIC "Roll Top" OAK DESK
from pre-cut first quality kit



Here's the turn-of-the-century "Roll-Top" you've always wanted. A full size oak desk, yours now at extraordinary savings... because you build it yourself from pre-cut kit parts. No special tools needed. When finished, you'll possess a magnificent showpiece for your home or office — worth at least twice what you pay for the kit! Send for details without obligation.

FREE Full color catalog gives you all the facts

Please send my free Craftsman's Corner color catalog featuring the Classic Roll Top Desk and many other top quality hardwood kits. I understand I have no obligation.

Print Name _____
Address _____
City _____
State _____ Zip _____
CRAFTSMAN'S CORNER
Dept. WA • 4012 N.E. 14th St. • Box AP
Des Moines, IA 50302

Supergrit®
Random Orbital Sander Discs
5" White PSA 180 Grit \$15.00/100

PREMIUM QUALITY BELTS: BEST RESIN OVER RESIN, "X" WEIGHT 10/Box	
1 x 42	\$ 7.00 ea.
3 x 18	75
5 x 21	90
5 x 24	95
4 x 24	\$1.05 ea.
4 x 36	1.30
6 x 48	2.95
6 x 50	5.00

ADHESIVE CLOTH DISCS: BEST RESIN OVER RESIN, "X" WEIGHT	
5" Diameter	\$ 8.00 ea.
6"	30
8"	1.40
9"	1.80 ea.
10"	2.00
12"	2.50

Prices quoted 80 grit, other grits available.

GARNET PAPER — ORANGE	WATERPROOF PAPER — BLACK
A/O CABINET PAPER — BROWN	220 thru 1200 100 PK \$23.00
40 Grit	50 PK \$16.00
60 Grit	50 PK 14.00
80 Grit	50 PK 13.00
100, 120, 150	100 PK 22.00
180, 220	100 PK 15.00
CLEANING STICKS	\$3.50 Small \$6.50 Large

NO LOAD PAPER — WHITE
180 through 400 100 PK \$20.00
Also Shop Rolls • Cloth Sheets • Drums

RED HILL CORP., P.O. BOX 4234, GETTYSBURG, PA 17325
Free Freight to most areas
(800) 822-4003 Free catalogue

IT'S FREE

Create some Great Time with Wood.

Our 20th Year

Our newest full-color catalog has 64 exciting pages of clockmaking and wood projects for you.

- Clock Kits • Ship Models, Whirligigs
- American-made Quartz Clock Movements
- Mechanical Movements
- Woodworking Tools • Wood Plans, Parts
- Dials, Hands and Numerals

All at great low prices! So take a look. Send for your FREE Klockit catalog today.

Name _____
Address _____
City, State, Zip _____

Or call Toll-Free 1-800-556-2548 and mention Dept. WD111.

KLOCKIT™

P.O. Box 542, Dept. WD111
Lake Geneva, WI 53147-9961

Carousel Rocker

Plan is Full Size

Catalog \$1.00 or sent free with order.



Build this King of the Jungle Rocker. Kids will love it. It has a brass pole and 3-tone saddle. Size is 35" x 58".

Plan—428
\$12.75

Trim kit contains mane, saddle material, brass pole, saddle nails, braces & rosettes.
Carousel Rocker Trim Kit \$42.00

MC/Visa orders call toll-free 1-800-462-8296
Shipping charge is \$3.00. NY State add tax.

ARMOR, Box 445-L, East Northport NY 11731

DOMESTIC & FOREIGN HARDWOODS

Quality stock for Cabinet Work
Most all sizes from 1" to 4" in thickness

HARDWOODS

ASH—BASSWOOD—BIRCH
BUTTERNUT—CHERRY
CHESTNUT—EBONY—MAPLE
OAK—POPLAR—ROSEWOOD
TEAK—WALNUT
Also hardwood plywoods

SOFTWOODS

SUGAR PINE—CYPRESS—CEDAR
SPRUCE—DOUGLAS FIR etc.

MAURICE L. CONDON CO., INC.
242 Ferris Ave., White Plains, NY 10603
914-946-4111

Monday through Friday 8 AM to 4:30 PM

BUILD YOUR OWN QUEEN ANN FURNITURE

with our wide variety of stock legs



-OR-
JUST ASSEMBLE
OUR COMPLETE KITS



Matching dining and occasional tables available in
FREE BROCHURE
(no minimum required)

Adams Wood Products, Inc.
974 Forest Drive • Dept. M8
Morristown, TN 37814 • Phone (615) 587-2942



ANTIQUE reproduction furniture HARDWARE



HORTON BRASSES
Nooks Hill Rd. PO Box 120J
Cromwell, Ct 06416 203-635-4400
send \$3.00 for a catalog

Wood Moisture Meter

pocket-size
MINI-LIGNO
Range: 6-20%
in 1% steps
Size: 1"x2 1/4"x5 1/2"

\$110
only

Including Case,
Battery, Pins for
3/16" or 7/16"
measuring depth.

Also available as
Mini E, 6-36%

Lignomat USA Ltd.
503-257-8957 800-227-2105

P.O. Box 30145
Portland, OR 97230



Exclusively Performax Precision Drum Sanders

5 YEAR ANNIVERSARY

Our Customers Say: "You know you really oughta tell people that the Performax really does what you say it'll do."



Performax S/T Sander attached to a Radial Saw

with Power Feed.

So After 5 Years of Ads, Here Goes:
It really is rigid. It really does sand 44" wide in two passes. It really is precise. It really is affordable. It really does have new and really improved abrasive fasteners. It really is the best drum sander money can buy. It really will exceed your expectations.

A REALLY BIG THANK YOU TO ALL WHO MADE THIS ANNIVERSARY POSSIBLE.

For a Free Brochure and the Dealer Nearest You Call

1-800-334-4910
or (612) 895-9922

or write: PERFORMAX PRODUCTS, W1
12211 Woodlake Drive, Burnsville, MN 55337

Manufacturers'

Continued from page 92

Clairson International, Dept. WD,
720 S.W. 17th St., Ocala, FL 32674;
800/221-0641 or
904/351-6100, ext. 4065

Clayton Machine Corp., Dept. WD,
P.O. Box 513-W2, Clawson, MI 48017;
313/548-2380

Colonial Saw, Dept. WD,
100 Pembroke St., P.O. Box A,
Kingston, MA 02364; 617/585-4364

Connecticut Valley Mfg. Co.,
(CONVALCO), Dept. WD,
P.O. Box 1957,
New Britain, CT 06050; 203/223-0076

Constantine's, Dept. WD,
2054P Eastchester Rd.,
Bronx, NY 10461;
800/223-8087 or 212/792-1600

CooperTools, Dept. WD, P.O. Box 728,
Apex, NC 27502; 212/661-5300

CO-ST Cutters, Dept. WD,
7101 Valjean Ave.,
Van Nuys, CA 91406;
800/423-2544 or 818/782-0226

Credo, Dept. WD,
2765 National Way, Woodburn,
OR 97071; 503/982-0100

DAP Inc., Dept. WD,
P.O. Box 277, Dayton, OH 45401;
800/543-4461 or 513/667-4461

Delta, Dept. WD, 246 Alpha Dr.,
Pittsburgh, PA 15235;
800/438-2486 or 412/963-2400

Delta Technical Coatings, Inc.,
Dept. WD, 2550 Pellissier Pl.,
Whittier, CA 90601;
800/423-4135 or 800/553-8940

Devcon Consumer Division,
Dept. WD, 780 A.E.C. Dr.,
Wood Dale, IL 60191;
800/227-7950 or 708/350-2710

DeVilbiss, Dept. WD, 213 Industrial Dr.,
Jackson, TN 38301; 901/423-7000

Diamond Machining Technology,
Dept. WD, 85 Hayes Memorial Dr.,
Marlborough, MA 01752; 800/666-4368

Dremel, Dept. WD, 4915 21st St.,
Racine, WI 53406; 414/554-1390

Dynamat, Dept. WD,
399 27th Avenue NE,
Minneapolis, MN 55418; 612/788-7923

E-Clamp (see Inlet Inc.)

Listing

Ebac Lumber Dryers, Dept. WD,
106 John Jefferson Rd., Suite 102,
Williamsburg, VA 23185;
800/433-9011 or 804/229-3038

Elu (see Black & Decker)

Emperor Clock Co., Dept. WD,
Emperor Industrial Park, P.O. Box 1089,
Fairhope, AL 36533-1089;
800/642-0011 or 205/928-2316

Faber-Castell (see your
local homecenter)

Farris Machinery, Dept. WD,
320 N. 11th, Blue Springs, MO 64015;
800/872-5489 or 816/229-3055

Fasco Industries, Inc., Dept. WD,
810 Gillespie St., P.O. Box 150,
Fayetteville, NC 28302;
800/334-4126 or 919/483-0421

Floral Glass & Mirror, Dept. WD,
895 Motor Parkway,
Hauppauge, NY 11788;
800/647-7672 or 516/234-220

Franklin International, Dept. WD,
2020 Bruck St., Columbus, OH 43207;
800/347-4583 or 614/443-0241

Freud, Dept. WD, P.O. Box 7187,
218 Feld Ave., High Point, NC 27264;
919/434-8300

Garrett Wade Co., Dept. WD,
161 Avenue of the Americas,
New York, NY 10013-1299;
800/221-2942

General Tools Mfg. Co., Inc.,
Dept. WD, 80 White St.,
New York, NY 10013; 212/431-6100

Gougeon Brothers, Inc., Dept. WD,
100 Patterson Ave., P.O. Box 908,
Bay City, MI 48707; 517/684-7286

Grizzly Imports, Dept. WD,
(east of the Mississippi River)
2406 Reach Rd.,
Williamsport, PA 17701;
800/523-4777
(west of the Mississippi)
P.O. Box 2069, Bellingham, WA 98227;
800/541-5537

HTC Products, Dept. WD,
120 E. Hudson, P.O. Box 839,
Royal Oak, MI 48068;
800/624-2027 or 313/399-6185

Hartco Quality Wood Flooring,
Dept. WD, 900 S. Gray St., Suite 1902,
Knoxville, TN 37902; 615/544-0767

Continued on page 96

New books from the experts at WOOD.

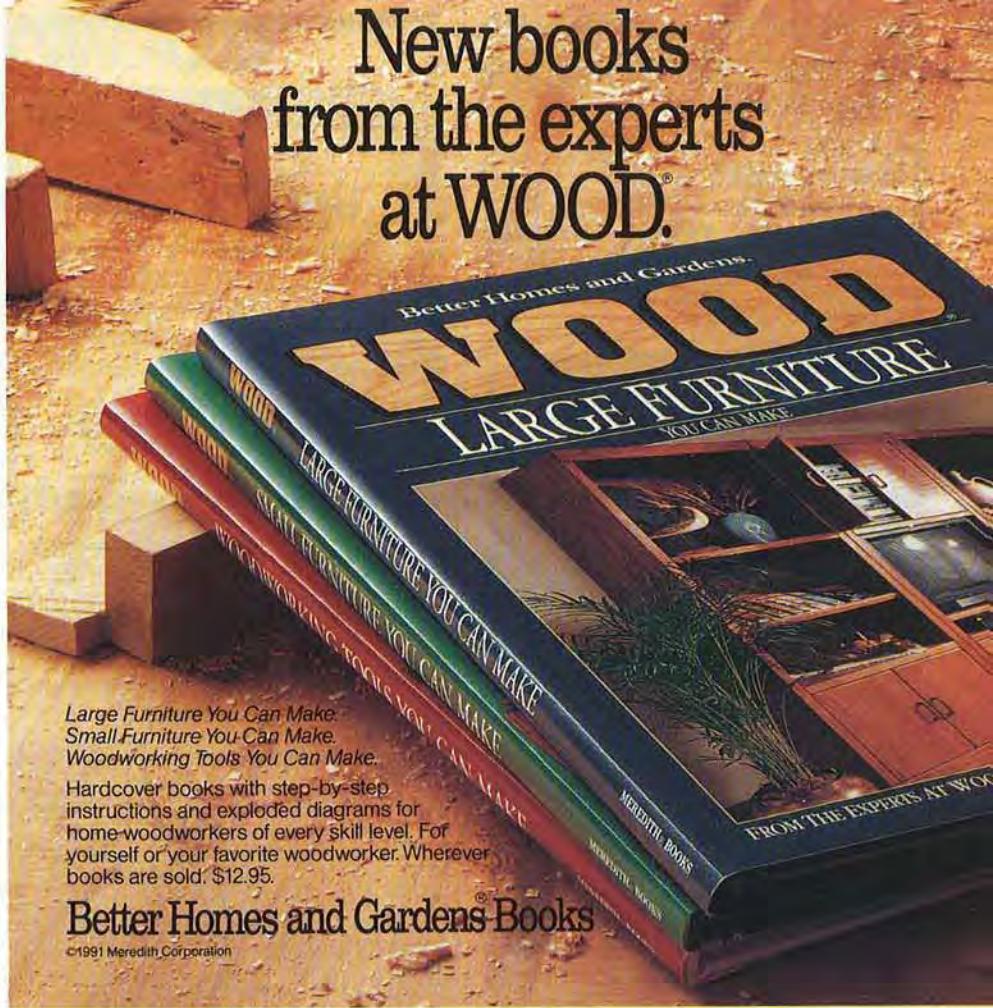

*Large Furniture You Can Make.
Small Furniture You Can Make.
Woodworking Tools You Can Make.*

Hardcover books with step-by-step instructions and exploded diagrams for home-woodworkers of every skill level. For yourself or your favorite woodworker. Wherever books are sold. \$12.95.

Better Homes and Gardens® Books

©1991 Meredith Corporation



SANTA WITH CORNCOB PIPE

The corncob pipe actually lights up with an electric "flicker bulb". Santa is easy to make from 1/2 inch plywood. Body is 15 inches tall. Plan includes FULL SIZE patterns and instructions. Order hardware parts below.

#W754 Santa Plan \$6.99/EA

Santa Hardware Parts

This package contains the corncob pipe bowl and stem, lamp socket, 6-foot cord with on/off switch, plug, flicker bulb, precut Merry Christmas banner, and a white pom pom. Project plan, paint and remaining plywood are not included.

#9950 Santa Hardware Parts..... \$9.99/PKG
5 or more PKGS..... \$9.29/PKG

HOW TO ORDER: List quantity, part number, item, price & total of order. Include \$4.95 shipping & handling per order. MN residents add 6.5% sales tax. Mail check or money order. Credit card customers call TOLL FREE 1-800-441-9870.

Meisel Hardware Specialties
P.O. Box 70W12X, Mound, MN 55364

Do-It-Yourself Kits



*Factory Direct
Clocks and Furniture*
**Also Assembled
and Finished**

- Grandfather Clocks, Mantel and Wall Clocks
- Curios, Tables, Chairs, Desks, Cradle...and more!
- Solid 3/4" Black Walnut, Cherry, or Oak
- Heirloom Quality
- Solid Brass West German Movements and Dials
- Money Back Guarantee



I am interested in
 Do-It-Yourself Kits
 Finished Clocks
 Finished Furniture

SEND \$1 FOR COLOR CATALOG

Name _____
Street _____
City _____
State _____ Zip _____
(Please Print)



**EMPEROR
CLOCK COMPANY**

World's Largest Manufacturer of Grandfather Clock Kits
Dept. 4117 Emperor Industrial Park
Fairhope, Alabama 36532 • Phone 1-205-928-2316

Wood-Mizer®

World's Largest Manufacturer of Portable Sawmills

Own a Sawmill!

Start a Profitable Business!

Save money cutting your own lumber, make money cutting for others.

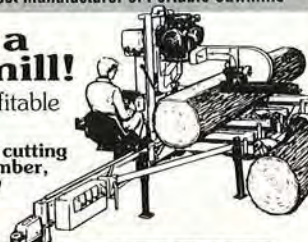

1-800-553-0219

32 Page Full Color Catalog - \$2.00
66-minute demonstration video-\$10.00
MasterCard or Visa accepted

8180 West 10th Street • Dept. QQ56
Indianapolis, Indiana 46214-2400

Van Dyke's

Presents a Catalog

with supplies for upholstery, antique restoration, wood working, caning, brass hardware, carvings and many related trades!



36 Years in Creative Arts & Trades

Many Hard-To-Find Items!

SEND \$1.00 FOR CATALOG TO:
Van Dyke's Restorers
Dept. D55 • Woonsocket, SD 57385

SQUARE DRIVE SCREWS

- Square Recess Reduces "Cam-Out"
- Heat Treated for Strength
- Deep Thread for Exceptional Holding Power
- Sharp Point Self Starts - Even in Most Hardwoods
- Satisfaction Guaranteed!



SPECIAL: 600 screws (100 each of 6 popular sizes), 1 power Driver, and 1 hand driver.

Size	Length	Price
#6x 1/2, 5/8, 3/4, 1, 1-1/4, 1-1/2		14.75
#8x 3/4, 1, 1-1/4, 1-1/2, 2, 2-1/2		19.25
#10x 1-1/4, 1-3/4, 2, 2-1/4, 2-1/2, 3		29.75

Delivery Charges

UPS Ground Only

Order Total	Add
\$.01 to \$20.00	\$3.50
\$20.01 to \$50.00	\$5.00
\$50.01 to \$80.00	\$6.50
Over \$80.00	\$8.00

Va. Residents add 4.5% Tax
Visa, MC, Discover Accepted

Send \$3.00 for Catalog and Samples

McFEELY'S

P.O. Box 3
Lynchburg, VA 24505

Order Toll Free
1-800-443-7937
or FAX
(804) 847-7136

Quality

EXOTIC LUMBER

Figured Domestic
Turning Wood
Exceptional Quality
Personal Friendly Service

Whether you are a
Beginner or Professional,
We welcome your inquiries

Call or Write.

Berea Hard Woods Co.

125 JACQUELINE DRIVE • BEREA, OHIO 44017
216-243-4452

WOOD PATTERNS

3-D PLAQUES-MOBILES-YARD ORNAMENTS
Each Pattern Given in 3 Sizes

- * FISHES
- * CAROUSEL HORSE
- * EAGLE
- * BUTTERFLY
- * CASTLES
- * ANGEL
- * SEA HORSE
- * DOLPHINS

\$4.50 each or 3 for \$12.00 ppd.
\$1.00 for pattern list only
ca. res. add 6%

HOUSE OF STARR

P.O. BOX 783 ANGELS CAMP, CA. 95222

The Ultimate Woodworking Tool.



The Woodworkers' Store
New! 1991-92 Catalog
Over 150 new, hard-to-find items!

Yes! Send me the next four issues of The Woodworkers' Store catalog for only \$2/year.

Name _____
Address _____
City _____ State _____ Zip _____



Dept. 13114
21801 Industrial Blvd.
Rogers, MN 55374
Credit card orders
(612) 428-2199

Manufacturers'

Continued from page 95

Hartford Clamp Co., Dept. WD,
466 Park Ave., P.O. Box 280131,
East Hartford, CT 06128-0131;
203/528-1708

Hirsch Co., Dept. WD,
8051 Central Park, Skokie, IL 60076;
800/872-3279 or 708/673-6610

Hitachi, Dept. WD, 4487-E Park Dr.,
Norcross, GA 30093; 404/925-1774

Homelite, Dept. WD,
14401 Carowinds Blvd., P.O. Box 7047,
Charlotte, NC 28273;
800/242-4672 or 704/588-3200

Honeywell (see Techmart)

Horton Brasses, Dept. WD,
Nooks Hill Road, P.O. Box 95,
Cromwell, CT 06416; 203/635-4400

Hydrocote Co., Inc., Dept. WD,
P.O. Box 160, Tennent, NJ 07763;
800/229-4937 or 908/257-4344

Hunt Manufacturing; 800/879-4868

ITW Buildex, Dept. WD,
1349 W. Bryn Mawr Ave.,
Itasca, IL 60143;
800/323-0720 or 708/595-3500

Inlet Inc., Dept. WD,
One Saunders Ave.,
San Anselmo, CA 94960-1795;
800/786-5665

Irwin Company, Dept. WD,
92 Grant St., Wilmington, OH 45177;
513/382-3811

Japan Woodworker, Dept. WD,
1731 Clement Ave., Alameda, CA
94501; 800/537-7820 or 415/521-1810

JET Equipment & Tools, Dept. WD,
P.O. Box 1477,
Tacoma, WA 98401-1477;
206/572-5000

Kimball Sign Co., Dept. WD,
2602 Whitaker St.,
Savannah, GA 31401;
912/232-6561

Kity (see Farris Machinery)

Klean-Strip, Dept. WD,
P.O. Box 1879, Memphis, TN 38101

Klein Design Inc., Dept. WD,
6514 115 Pl. SE, Renton, WA 98056;
206/226-5937

Listing

Klingspor Abrasives, Dept. WD,
2555 Tate Blvd. SE, P.O. Box 2367,
Hickory, NC 28603;
800/645-5555 or 704/322-3030

Klockit, Dept. WD,
P.O. Box 636, Lake Geneva, WI 53147;
800/556-2548 or 414/248-7000

Krylon, Dept. WD,
6830 Cochran Rd., Solon, OH 44139;
800/832-2541 or 216/498-2300

Kuempel Chime Clock Works & Studio,
Dept. WD, 21195 Minnetonka Blvd.,
Excelsior, MN 55331;
800/328-6445 or 612/474-6177

LRH (see CO-ST Cutters)

Laguna Tools, Dept. WD,
2081 Laguna Canyon Rd.,
Laguna Beach, CA 92651;
800/234-1976 or 714/494-7006

Lamello (see Colonial Saw)

Lampi Corp., Dept. WD,
P.O. Box 1769, Huntsville, AL 35807;
800/633-7256 or 205/830-3110

Lavi Industries, Dept. WD,
27810 Ave., Hopkins,
Valencia, CA 91355;
800/624-6225 or 805/257-7800

Lea's Tools, Dept. WD,
1651 S. Pecan Cr., Mesa, AZ 85202;
602/838-6452

Leichtung Workshops, Dept. WD,
4944 Commerce Pkwy., Dept. P130,
Cleveland, OH 44128;
800/542-4467 or 800/654-7817

Lignomat USA, Ltd., Dept. WD,
P.O. Box 30145, Portland, OR 97230;
800/227-2105 or 503/257-8957

Lufkin (see CooperTools)

MLCS, Dept. WD,
P.O. Box 4053-D-9, Rydal, PA 19046;
800/533-9298 or 215/886-5986

Majestic, Dept. WD,
1000 E. Market St.,
Huntington, IN 46750;
800/525-1898 or 219/356-8000

Makita USA, Inc., Dept. WD,
14930 Northam St.,
La Mirada, CA 90638;
714/522-8088

McCloskey Corp.; 800/767-2532

Continued on page 98

WOOD TOY

- ★ Patterns
- ★ Parts
- ★ Wheels
- ★ Many New Patterns to Choose from.
- ★ Executive toys

SEND \$1.00 FOR NEW CATALOG & RECEIVE COUPON FOR FREE WHEELS & AXLE PEGS.



toys and joys

Box 628W Lynden, Wash. 98264



STOP PERFBORARD HOOK FALLOUT!

M-CLIPS™ are THE guaranteed perfect solution to this annoying problem! Fit both 1/8" and 1/4" perfborard. Send SASE for free sample or \$5.99 + \$1.50 p&h for pkg. of 50 to: AETECH, P.O. Box 6298, Dept. W11 10 Shadowstone Lane Lawrenceville, NJ 08648

Anytime Anywhere Anywood

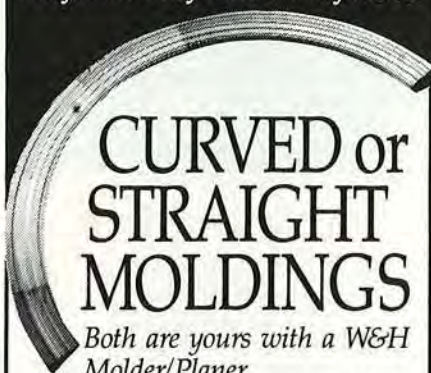

CURVED or STRAIGHT MOLDINGS

Both are yours with a W&H Molder/Planer

Thousands of professionals and serious woodworkers use our American-made cast iron molder/planers to produce smooth moldings, raised panels, crowns and curved molding.

In the shop or at the job site, W&H meets your needs every day with quick knife changeover and ultimate versatility with all kinds of wood.

Over 40 years of experience supports our products with a 5 year warranty! Call or write today for our FREE information kit!

800-258-1380 (USA) 603-654-6828
FAX 603-654-5446

Williams & Hussey
Machine Co., Inc.
Dept. 231KM
P.O. Box 1149 Wilton, NH 03086



SPECIAL OFFER BRANDING IRON

For hard and soft wood

\$2600

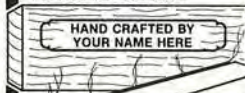

Plus \$3.00 for shipping and handling
Nebr. residents add correct sales tax
SATISFACTION GUARANTEED or your money back

- Shipped in one week
- Solid brass head — raised letters
- 1st Line: HAND CRAFTED BY — as above
- 2nd Line: Your choice — 20 characters/spaces max.
- Complete with wood handle
- As above but with 3rd line — \$37.00 + \$3.00

ORDER TOLL FREE 1-800-826-7606

For free brochure, write or call (402) 464-0511

Order by mail from: NOVA TOOL CO.

12500 Finigan Rd., Dept. BH
P.O. Box 29341, Lincoln, NE 68529



SAFE • EASY • PRECISE PROFESSIONAL WOOD CARVING



AUTO MCH[®]
by Sugino

Compact. 10,000 vpm oscillating speed. Pressure activated. Operates on ordinary household current. Send for free brochure. Dealers inquiries invited. \$28800



Sugino Corp.

Visa & Mastercard accepted.
1700 N. Penny Lane
Schaumburg, IL 60173
(708) 397-9401

FOR INFORMATION ABOUT PLACING AN ADVERTISEMENT IN

Better Homes and Gardens[®]

WOOD[®]

PLEASE WRITE:

BILL REED

WOOD MAGAZINE

750 THIRD AVENUE

NEW YORK, NY 10017

OR CALL COLLECT
212-551-6903

M Manufacturers' Listing

Continued from page 97

Metabo Corp., Dept. WD,
1231 Wilson Dr., P.O. Box 2287,
West Chester, PA 19380; 215/436-5900

Micro-Mark, Dept. WD,
340-1077 Snyder Ave.,
Berkeley Hts., NJ 07922;
800/225-1066 or 908/464-6764

Micro-Surface Finishing Products,
Dept. WD, P.O. Box 818,
Wilton, IA 52778; 319/732-3240

Minuteman, Dept. WD,
115 N. Monroe St., P.O. Box 8,
Waterloo, WI 53594;
800/733-1776 or 414/478-2001

Minwax, Tips on Wood Finishing,
Dept. WD, P.O. Box 426,
Little Falls, NJ 07424; 201/307-4800

Mr. Mac's Products, Dept. WD,
111-F Creek Ridge Rd.,
Greensboro, NC 27406; 800/333-3262

MULE Cabinetmaker Machine,
Dept. WD, 519 Mill St.,
P.O. Box 731, Lockport, NY 14095;
800/563-6853 or 416/727-7090

Nicholson (see CooperTools)

Nova Tool Co., 12500 Finigan Rd.,
P.O. Box 29341, Dept. BG,
Lincoln, NE 68529;
800/826-7606 or 402/464-0511

Ornamental Mouldings Limited,
Dept. WD, 289 Marsland Drive,
P.O. Box 336, Waterloo,
Ont. Canada N2J 4A4; 519/884-4080

Osmose Wood Preserving, Inc.,
Dept. CP, 1016 Everee Inn Rd.,
P.O. Drawer O, Griffin, GA 30224;
800/522-WOOD or 404/228-8434

P&M Consumer Products, Inc.,
Dept. WD, 2423 W. March Ln.,
P.O. Box 7958, Stockton, CA 95267;
800/542-3436 or 800/243-7010

Paint Strokes, Inc., Dept. WD,
3519 Civic Center Rd.,
N. Las Vegas, NV 89030;
800/468-3779 or 702/644-6131

Paragauge (see Accuset Tool Co.)

Parks/Carver Tripp, Dept. WD,
P.O. Box 5, Somerset, MA 02726;
800/225-8543 or 508/679-5938

Penn State Industries,
Dept. WD, 2850 Comly Rd.,
Philadelphia, PA 19154;
800/288-7267 or 215/676-7606

Phantom Engineering, Dept. WD,
16890 Church St., Bldg. 13,
Morgan Hill, CA 95037; 408/779-1616

Plano (see Advanced
Machinery Imports)

Plasti-Kote, Dept. WD,
P.O. Box 708, Medina, OH 44258;
800/431-5928 or 216/725-4511

Plumb (see CooperTools)

Porter-Cable, Dept. WD,
4825 Highway 45 North,
P.O. Box 2468, Jackson, TN 38302;
901/668-8600

Power Tool Specialists,
Dept. WD, 3 Craftsman Rd.,
East Windsor, CT 06088;
800/243-5114 or 203/654-1761

Powermatic, Dept. WD,
Morrison Rd., McMinnville, TN 37110;
800/248-0144 or 615/473-5551

Racal Panorama, Dept. WD,
7305 Executive Way,
Frederick, MD 21701;
800/682-9500 or 301/695-8200

Rali (see Farris Machinery)

Red Devil Inc., Dept. WD,
2400 Vauxhall Rd., P.O. Box 194,
Union, NJ 07083-1933;
800/247-3790 or 908/688-6900

Riecreation Products, Dept. WD,
7 Olde Orchard Ln., Fairport, NY
14450; 716/377-0070

Robland (see Laguna Tools)

Rubbermaid Inc., Dept. WD,
717 W. Smith Rd., Medina, OH 44258

Ruffies (see Carlisle Plastics)

Rust-Oleum, Dept. WD, 11 Hawthorn
Parkway, Vernon Hills, IL
60061; 800/323-3584

Ryobi America Corp., Dept. WD,
1424 Pearman Dairy Rd., Anderson, SC
29625; 800/323/4615 or 803/226-6511

Sansher Corp., Dept. WD,
8005 N. Clinton St., Fort Wayne, IN
46825; 219/484-2000

Satellite City, Dept. WD, P.O. Box 836,
Simi Valley, CA 93062; 805/522-0062

Savogran Company, Dept. WD,
P.O. Box 130, Norwood, NY 02062;
800/225-9872

Sears, Roebuck and Co., (call or visit
your local Sears store or call a Sears
teletailor center)

Shopsmith, Dept. WD,
3931 Image Dr., Dayton, OH 45414;
800/543-7586 or 513/898-6070

Shop-Vac Corp., Dept. WD,
2323 Reach Rd., P.O. Box 3307,
Williamsport, PA 17701; 717/326-3557

Silverton Victorian Millworks,
P.O. Box 2987-WM6,
Durango, CO 81302; 800/933-3930

Skil, Dept. WD,
4300 West Peterson Ave.,
Chicago, IL 60646; 312/286-7330

Sonin Inc., Dept. WD,
672 White Plains Rd.,
Scarsdale, NY 10583;
800/223-7511 or 914/725-0202

Stanley Tools, Readers Response Service,
Dept. WD, P.O. Box 1146,
Bellmore, NY 11710; 203/827-5237

Star Bronze Company, Dept. WD,
803 South Mahoning, P.O. Box 2206,
Alliance, OH 44601;
800/321-9870 or 216/823-1550

T.C. Manufacturing, Dept. WD,
P.O. Box 122, Fredericktown, OH
43019; 800/253-5669

Tech Rep and Associates, Dept. WD,
P.O. Box 12389, Beaumont, TX 77726;
409/838-1386

Techmart, Dept. WD, Suite 139,
2745 Winnetka Ave. North,
Minneapolis, MN 55427; 800/688-1280

Thompson's; 800/367-6297

3M, Dept. WD, 3M Center, 515-3N-02,
St. Paul, MN 55144

Tools Etc., Dept. WD,
1567 S. Harbor Blvd.,
Fullerton, CA 92632;
800/327-6250 or 714/525-3581

Toulon USA, Dept. WD, P.O. Box 12389,
Beaumont, TX 77726; 409/838-1386

Trend-Lines, Dept. WDEM,
375 Beacham St., Chelsea, MA 02150;
800/767-9999

Trimtramp Ltd., Dept. WD,
151 Carlingview Dr., Unit 11,
Etobicoke, Ont., Canada M9W 5S4
416/798-3160

Continued on page 100

Better Homes and Gardens®
Decorative
WOODCRAFTS™

NEW!

From the Publishers
of **Better Homes
and Gardens®**
Magazine!

"Oh, you're so talented!"

Imagine...your family and friends raving about your creativity!

Imagine...transforming scraps of wood into beautiful works of art for your own home!

Imagine...crafting the hot-selling item at your next church bazaar!

Now you can, with new Better Homes and Gardens® DECORATIVE WOODCRAFTS™ — the most inspiring magazine available for those who love to paint and decorate wood projects!

From the first cut of the scroll saw to the last stroke of the brush, we'll guide you every step of the way. (Woodcrafting has never been easier!)

Soon you'll be creating spectacular wood projects you never dreamed you'd try! Holiday treasures... decorative accents... country collectibles... gifts for all occasions...you name it!

- ◆ 12 projects in every issue
- ◆ Easy-to-follow instructions for wood preparation, painting, staining
- ◆ The latest techniques and sure-fire tips
- ◆ Materials list
- ◆ Removable full-size patterns
- ◆ Full-color photos
- ◆ Buying resource
- ◆ Personalities and more — all in one great magazine!

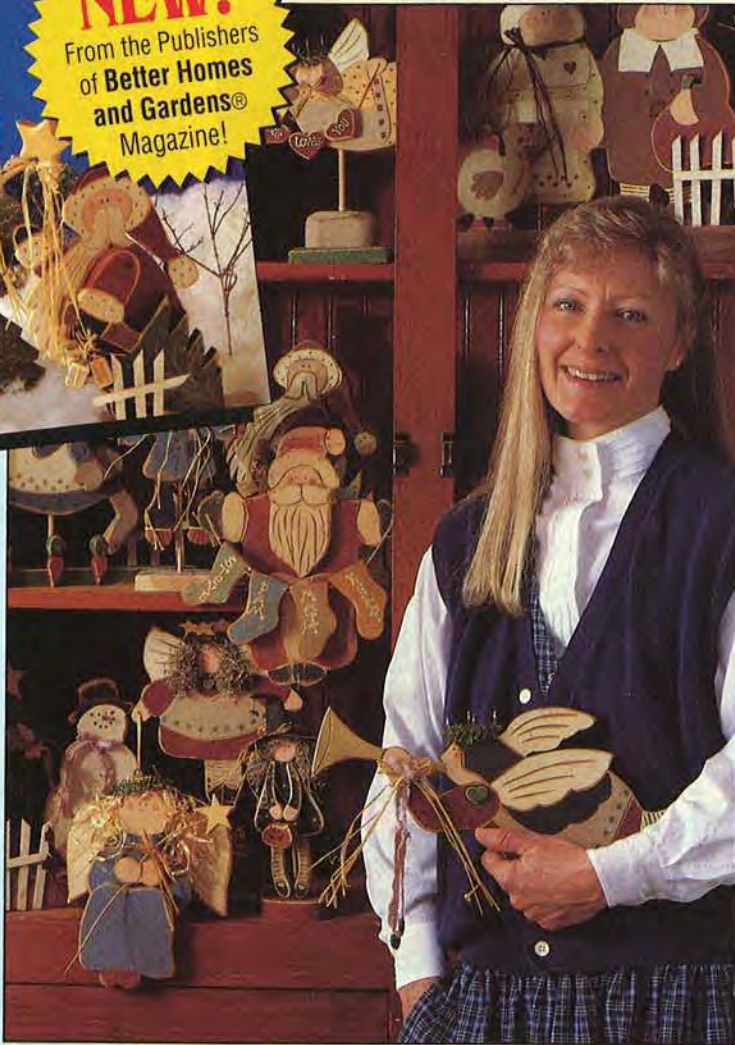

Mail coupon or write to:
Better Homes and Gardens®
DECORATIVE WOODCRAFTS™
Magazine, 6185 Arapahoe,
P.O. Box 54696
Boulder, CO
80322-4696

Order now and enjoy special Charter Savings

One Full Year (6 project-packed issues!) Only \$19.97

SAVE \$10.00 OFF the regular subscription rate!

SAVINGS COUPON

Better Homes and Gardens®
Decorative
WOODCRAFTS™

YES! Begin my Charter Subscription to Better Homes and Gardens® DECORATIVE WOODCRAFTS™ Magazine. I'll get 6 project-packed issues for only \$19.97 — \$10.00 OFF the regular subscription rate!

Name (PLEASE PRINT) _____

Address _____ Apt. # _____

City _____ State _____ Zip _____

WE'LL BILL YOU LATER! Add \$6 for Canadian and other foreign subscriptions.

Mail to: Better Homes and Gardens® DECORATIVE WOODCRAFTS™ Magazine,
6185 Arapahoe, P.O. Box 54696, Boulder, CO 80322-4696

MAIL TODAY — Subscription prices subject to change.

SPECIAL OFFER
for Better Homes and Gardens® **WOOD**®
Magazine Readers!



4MAG2

The Better Homes and Gardens®

GUARANTEE

◆◆◆◆◆◆◆◆

Your complete satisfaction always comes first. If, for any reason, during your subscription you decide you no longer want to subscribe, we'll promptly and cheerfully send you a refund for all unmailed issues.

THE
PERFECT GIFT
FOR HOME WOODWORKERS!

Better Homes and Gardens®

WOOD

ONE FULL YEAR (9 ISSUES) ONLY \$24.97

To order, call TOLL-FREE 1-800-374-9663

or write WOOD Magazine, 1716 Locust Street,
P.O. Box 10625, Dept. 385035, Des Moines, Iowa 50336-0625.



WOODCRAFT

FULL SIZE PATTERNS
SIMPLE TO MAKE ★ FUN ★ PROFITABLE

✓ Check the Packets of Interest to YOU!

- 100 yard ornaments animals, birds, signs, more!
- 200 pattern packet for scroll, band & jigsaws!
- Show stoppers - 22 craft show top-sellers!
- 25 fun, profitable "wind-action" whirligigs.
- Attractive Dutch Windmill - 5 feet tall.
- Country Classics - enjoyable top-selling projects!
- Waving Santa - over 5 feet tall.
- Santa & Sleigh - 35" tall by 44" long.
- Santa's Reindeer - 33" tall by 28" long. 3 poses.
- Over 30 Christmas decorations & centerpieces.
- 3 foot tall Santa, snowman, soldier & candle.
- Nativity - 1/3 life size Holy Family & manger.

Send \$8.00 per packet. Pick 3 for only \$16.00

Fast Service • Satisfaction Guaranteed!

ACCENTS, Dept. MA111 Box 7387, Gonic, NH 03839

WOODCRAFT CATALOG - \$2.00 (Free with order)

WOODWORKERS

Save on Wood - Tools - Supplies!

OVER
4000
ITEMS

Send for
New 1991
132 Page
Money Saving
CATALOG

OUR
61st Year

Dept. WM1191, 1735 W. Cortland Ct., Addison, IL 60101
Please enclose \$1.00 to help pay postage and handling.

Finest Dimensioned
HARDWOODS and
Quality VENEERS

42 VARIETIES
1/64" to 4" Thickness

Fast service on choice kiln dried
Wood and Veneers, Moldings, Trim,
Hand and Power Tools, Lamp Parts,
Upholstery Supplies, Clock Move-
ments and Kits, Hard-to-Find Hard-
ware, Finishing Materials, Books
... over 4000 items in stock! Crafts-
man—Woodworker's best friend.

CRAFTSMAN WOOD SERVICE

SIGNCARVING



IS FUN & PROFITABLE

And it's easy, if you use the Marlin Woodcarvers and accessories. You can carve signs quickly at home or at swap meets. No special training is required. The machines do the work, the operator has the fun and the profits. These machines will also 3-D carve panels and plaques. Our templates work well with other machines.

SEND \$1.00 FOR OUR FULL LINE BROCHURE AND PRICE LIST AND START PLANNING YOUR FULL OR PART-TIME BUSINESS.



MARLIN INDUSTRIES, INC.

Rt. 70, Box 191, Dept D111
Cashiers, NC 28717
(704) 743-5551

Build "Merrilegs"

Full-size
Plan #121

\$14.00
(catalog free
with order)

CATALOG
200 full-size
professional
furniture plans
— \$3.00

SEND TODAY!



Full-Size Professional Plan

FURNITURE DESIGNS, INC., Dept. BZ-121
1827 Elm Dale Ave., Glenview, IL 60025 — (708) 657-7526



MIRRORA®

THE
HAND
MIRROR
COMPLIMENT

PERFECTLY
BEVELED
MIRROR

FLORAL

Glass & Mirror, Inc.

895 Motor Parkway, Hauppauge, NY 11788
516/234-2200 • 800-647-7672



*Traditional
Turnings*

Traditional Turnings for the home craftsman.

Unique selection of
bedposts, table legs,
(dining, sofa, coffee,
end), hutch,
gourmet kitchen.
Available in
Ponderosa Pine.

\$62.
Set

Dining Table
1-800-899-7411
1-404-873-3307
P.O. Box 54169 • Atlanta, GA 30308-0169

Send \$2.00 for catalog.
Special Price(s) with this ad

\$134.
Set

Cannonball Bed



Manufacturers' Listing

Continued from page 98

United Gilsonite Laboratories,
Dept. WD, P.O. Box 70, Scranton, PA
18501; 800/845-5227 or 717/344-1202

U.S. Safety, Dept. WD,
8101 Lenexa Dr., P.O. Box 15965,
Lenexa, KS 66215-5965; 913/599-5555

Vaughan & Bushnell Mfg. Co. (see your
local hardware store or homecenter)

Veritas Tools, Dept. WD,
12 E. River St., Ogdensburg, NY 13669

Vermont American, Dept. WD,
P.O. Box 340, Lincolnton, NC
28093-0340; 704/735-7464

Wagner Spray Tech, Dept. WD,
1770 Fernbrook Ln., Minneapolis, MN
55447; 800/328-8251 or 612/553-7000

Warren Tool Co., Inc., Dept. WD,
2209-1 Rt. 9G, Rhinebeck, NY 12572;
914/876-7817

Weatherbead Insulation Systems,
Dept. WD, 81-824 Trader Place,
Unit C-5, Indio, CA 92201;
800/966-0159 or 619/347-3738.

Wen, Dept. WD, 5810 Northwest Hwy.,
Chicago, IL 60631;
800/462-3630 or 312/763-6060

William Zinsser & Co., Inc., Dept. WD,
39 Belmont Dr., Somerset, NJ 08875;
908/469-8100

Williams & Hussey Machine Co., Inc.,
Dept. WD, P.O. Box 1149, Wilton, NH
03086; 800/258-1380 or 603/654-6828

Woodcraft Supply, Dept. WD,
210 Wood County Industrial Park,
P.O. Box 1686,
Parkersburg, WV 26102-1686;
800/225-1153 or 800/535-4486

Woods Wire Products, Dept. WD,
510 Third Ave., S.W., P.O. Box 2675,
Carmel, IN 46032; 800/428-6168
(consumer helpline) or 317/844-7261

Woodhaven, Dept. WD,
5323 W. Kimberly Rd., Davenport, IA
52806; 800/344-6657 or 319/391-2386

Woodmaster Tools, Dept. WD,
2908 Oak St., Kansas City, MO 64108;
800/821-6651 or 816/756-2195

X-Acto (see Hunt Manufacturing)

Woodworker's Supply, Dept. WD,
5604 Alameda Place N.E.,
Albuquerque, NM 87113;
800/645-9292 or 505/821-0578

**The Japan
Woodworker's
Catalog is...**

loaded with the best tools you can get your hands on.
In our catalog you will find a huge selection of
Japanese saws, waterstones, chisels, planes,
carving tools, cutlery and books. Send
\$1.50 for our catalog and supplements
during the next two years.

THE JAPAN WOODWORKER
1731 Clement E14, Alameda, CA 94501
Phone 1-800-537-7820

BUILDING OUR NAME...

BUILDING YOUR DREAMS...

ONE YEAR WARRANTED

SALE



WIDE BELT SANDER

CT-2575 24" \$4290
CT-3775 36" \$5390



SHAPER

SP-3400 1.5 HP. \$469
SK-30SPA 3 HP. \$849
SP-34T TILTING. \$1695



JOINTER

JT-1007 7" \$309
JT-1008 8" \$639
JT-0012 12" \$1895



TABLE SAW

HTS0012 12" \$789
TS-1010 10" \$1295
TS-1414 14" \$2690



BAND SAW

BS-1316 16" \$299
BS-0163 16" \$499
BS-0183 18" \$649
BS-0202 20" \$1290

WE SPECIALIZE IN CUSTOMER SATISFACTION



9034 Bermudez Street,
Pico Rivera CA 90660
MAIN OFFICE: (213) 949-3747
ATLANTA: (404) 416-6006
(800) 786-5626 (order only)

LOBO POWER TOOLS

"All my tools should be this good!"

The **Accu-Miter®** is a professional miter gauge that makes perfect angles easily. Shot-pin action assures dead-on accuracy for common angles — plus a precise protractor scale for everything in between!



We do not recommend operating without the saw blade guard, as is shown here.
US Patent Pending

Optional accessories:
manual clamp—
pneumatic clamp—
3/8" x 3/4" miter bar—

JDS COMPANY

Precision Woodworking Equipment

Call or write for our free brochure.

800 Dutch Square Blvd., Suite 200, Columbia, SC 29210
1-800-382-2637 / SC 803-798-1600

\$149

Thin HARDWOOD — Priced Right
Clear - Kiln Dried - 2 Sides Surfaced • 3" to 10" widths • 2' to 7' Lengths
20 Sq. Ft. Packs - Random Widths and Lengths
1/4" is 18" to 42" L. • Circle Dollar Amounts

Circle wood desired	1/4"	3/8"	1/2"	3/4"	1"
Red Oak or White Oak	\$40	\$45	\$56	\$56	\$ 56
Walnut or Cherry	44	50	60	60	68
Hard Maple or Birch	40	45	56	56	62
Poplar or Basswood	32	34	52	52	52
Padauk or Purpleheart	63	68	80	80	115

MICRO LUMBER - CUT PARALLEL - SANDED 80 GRIT - SOLD AND PRICED IN PACK OF 10 BOARDS.

4" x 24" Packs	1/4"	3/8"	1/2"	3/4"	1"
Red Oak or White Oak	\$14	\$14	\$20	\$24	\$27
Walnut or Cherry	17	17	24	27	31
Hard Maple or Birch	14	14	20	24	27
Red Cedar or Basswood	10	10	16	19	23
Padauk or Purpleheart	28	28	40	48	54

Any order of \$30 or more will be shipped UPS prepaid.
To order, circle wood and dollar amount above.
Send with check or money order to:

HARDWOODS OF ILLINOIS

R.R. 4 - Box 618 • Mt. Vernon, Ill. 62864

SPECIAL WOODCARVING GIFT #WG91

\$24.95 PLUS POSTAGE #1FS Strop has coarse leather one side. Finished leather opposite side. Shown in partially open and closed position.

ADD POSTAGE
U.S.A. \$3.50
CANADA \$6.50
FOREIGN \$8.50

SPECIAL OFFER INCLUDES:

- 1— Custom made oak & leather folding strop.
- 1— Custom made walnut handled knife with solid brass inter-changeable chuck.
- 1— Heavy duty whittling blade, honed razor sharp, ready for carving.

Free 6-Page instruction booklet.

Complete catalog free with purchase, or send \$1.00 for catalog only.

WARREN TOOL CO. INC.

2209-1 Rt. 9G, Rhinebeck, N.Y. 12572
TEL. (914) 876-7817

N.Y. RES. ADD SALES TAX / USA - Check or money order.
Canada & Foreign money order (only).
USA — COD UPS available at extra cost.



The Portable Sawmill.



The "affordable portable" one man band sawmill. Weighs only 45 lbs. Cuts 20" diameter logs into lumber. Minimum 1/8" to maximum 9" thickness.

Write or call for free brochure.

Better Built CORPORATION

(508) 657-5636

845 Woburn Street, Dept. W, Wilmington, MA 01887

FREE CATALOG

OVER 1100 ROUTER BITS & SHAPER CUTTERS

Send today for your FREE copy of our 56 page catalog. The industry's largest selections of American made bits. The finest quality backed by the best guarantee in the business! Over 600 photos and technical illustrations. Over 200 new items. Many exclusives and hard to find items!



To Order Call TOLL FREE 1-800-872-2511 or write:



EAGLE AMERICA

124 PARKER COURT, P.O. BOX 1099
CHARDON, OHIO 44024

Worth writing for...



You can get useful ideas and product information by mail. Use the coupon in this section to order your choice of literature listed below. Each company mails the catalogs or information directly to you.

POWER TOOLS

1991-92 TOOL CRIB CATALOG—offers a wide selection of merchandise for home woodworkers to industrial builders and features top manufacturers such as Black & Decker, Delta, Makita, Porter Cable, Bosch, Milwaukee, Ryobi, Freud and many more. We offer competitive prices with quality service and same day shipping. 208 page 1991-92 catalog. It's worth it! **TOOL CRIB.** \$3.00. *Circle No. 6.*

PORTABLE SAW MILL—a one man saw mill weighing 45 lbs. Gas and electric models will cut dimensional lumber from logs up to 20 in. diameter. Send for brochure. **BETTER BUILT CORP.** Free. *Circle No. 10.*

175-PLUS USES GUIDE—for Dremel Moto-Tool. Written from the do-it-yourselfer's view, this book shows how to plan and do a variety of everyday projects using the versatile Moto-Tool and cordless Freewheeler. 96-page book with over 275 photos includes tips on using Moto-Tool with flex-shaft, drill press, router attachment, chainsaw sharpening attachment, shaper/router table. **DREMEL.** Free. *Circle No. 33.*

LOBO POWER TOOLS—Fine crafted woodworking power tool, top quality, affordable prices. A commitment of customer satisfaction, with a full 1 year warranty. We sell a complete line with many options for our band saws, table saws, planers, jointers, double drum sanders, edge sanders, wide belt sanders, power feeders and many, many more. Send today for a free brochure. **LOBO POWER TOOLS.** Free. *Circle No. 57.*

MAKITA U.S.A. INC.—offers all new 152-page mini-catalog on its professional line of electric power tools, with special emphasis on the entire cordless line. Catalog provides complete information along with available accessories and practical applications. **MAKITA U.S.A. INC.** Free. *Circle No. 61.*

WOODWORKING MACHINE CATALOG—New 24-page color catalog introduces many new do-it-yourself woodworking machines. Includes planers, dust collectors, drill presses, sanders, lathes, and specializes in scroll saws and accessories. **PENN STATE INDUSTRIES.** Free. *Circle No. 75.*

VARIABLE SPEED SCROLL SAW—Information package available from Penn State Industries describing the specifications and applications of its super VS-15" variable speed scroll saw. Special discount pricing available on current promotion. **PENN STATE INDUSTRIES.** Free. *Circle No. 76.*

SURFACE PLANER—Information package available from Penn State Industries describing the specifications and applications of its super 12½ inch surface planer. Special discount pricing available on current promotion. **PENN STATE INDUSTRIES.** Free. *Circle No. 77.*

GET TO THE FINISH LINE FASTER—with a Performax drum sander. Don't spend hours with a hand-held belt sander. Sand ultra-wide stock ultra-smooth in just minutes. Models start at \$300 to \$2595. Select the model that fits your budget and your needs. New metal abrasive fasteners keep sandpaper tight without re-wrapping. **PERFORMAX PRODUCTS.** \$1.00. *Circle No. 78.*

THE PRECISION SCROLL SAW FOR THE ENTIRE FAMILY!—The Hawk was designed for beginners and built for expert woodworkers. Learn how to produce creative leisure time projects for fun or to make money...we'll show you how! Make cuts so intricate and smooth they don't require sanding. Four models to choose from. Send today for all the facts. **RB INDUSTRIES, INC.** Free. *Circle No. 84.*

THE VERSATILE RBI WOODPLANER/MOLDER/SANDER!—It's indispensable! It's 4-in-1. It's RBI's Woodplaner/Molder/Sander/Gang Saw. Find out how the Woodplaner saves you money turning rough stock into beautiful professional quality projects. With 3 models to choose from there's one that fits your needs. It does it all, so you can do it all! Send today. **RB INDUSTRIES, INC.** Free. *Circle No. 85.*

SKIL CORPORATION—30 page booklet covers the complete line of Skil professional power tools and accessories. Included are saws, cordless drill/drivers, screwdrivers, drills, jigsaws, planes, sanders and the latest addition...a plate joiner. **SKIL CORPORATION.** Free. *Circle No. 87.*

SKIL CORPORATION—Full color, complete line, power tool catalog. Features cordless screwdrivers, drills and the cordless Skilwrench™. Corded products include circular saws, drills, drywall drivers, sanders, hammer drills, jigsaws, planes, roto hammers, sander/grinders, shears, routers, xtra tools, bench top tools and reciprocating saw. All product accessories are also shown. **SKIL CORPORATION.** \$1.00. *Circle No. 88.*

MOLDER-PLANERS FROM WILLIAMS & HUSSEY—Mold, plane, and edge, convert from moulder to planer in less than 2 minutes. The W-7 series is available in 3 models for manual, power in feed, or power in feed/out feed. The units plane to a satin, almost sanded finish, produce doll house to crown sized mouldings, raised panels, and curved molding. Custom knives available up to 7" wide and ¾" depth of profile. Rugged, well-made, dependable, and transportable. Complete with sturdy movable stand. Send for catalog. **WILLIAMS & HUSSEY.** \$1.00. *Circle No. 93.*

PORTABLE SAWMILLS—Convert logs into valuable lumber—Wood-Mizer® Products manufactures a line of portable bandsaw mills that allows the novice as well as the experienced sawyer to safely convert standing logs into lumber. Then, with the use of our SolaryDry™ Kiln or Vacu-Kiln™ to dry your lumber, you could increase the value of every board you produce. We manufacture some of the most progressive woodworking equipment on the market today. Product videos available. Send for our 40-page catalog. **WOOD-MIZER PRODUCTS.** \$1.00. *Circle No. 94.*

HAND TOOLS

PERSONAL BRANDING IRONS—Brochure describes branding irons that enable you to put your

name on your work quickly and easily. Made especially for branding wood, they are available with 1, 2, 3 or 4 lines of copy. Changeable date also available. **NOVA TOOL CO.** \$1.00. *Circle No. 160.*

THE JAPAN WOODWORKER'S 72-PAGE CATALOG—is loaded with the a huge selection of Japanese saws, waterstones, chisels, planes, carving knives, cutlery and garden tools. See our Tools As Art section for the most expensive hand tools available. Send for 1992 catalog and all supplements for two years. **WOODLINE TOOL & SUPPLY.** \$1.50. *Circle No. 190.*

PLANS

OVER 1000 WOODCRAFT PATTERNS!—Enjoy making gifts, toys, lawn ornaments, holiday designs, whirligigs, folk art, bird houses and feeders, household and yard accessories plus much more! Simple enough for the beginner, fun and profitable for the pro. Send for catalog plus sample pattern. **ACCENTS IN PINE.** \$2.00. *Circle No. 310.*

WOODWORKERS' PLANS AND SUPPLIES—Wood projects are simplified with the high quality plans, specialty hardware and other supplies offered by Armor Products. Over 100 plans are available for making toys, desks, clocks, pool tables, lamps, chests, and other furniture. Movements, dials, moldings, ornaments, dollhouse kits, door harp supplies and tuning pins are also available. **ARMOR PRODUCTS.** \$1.00. *Circle No. 315.*

FULL-SIZE FURNITURE PLANS CATALOG—Illustrates and describes over 200 plans for making furniture of quality found in museums and fine furniture stores. Plans include rollout desk, cradles, dining tables, chairs, buffets, chests, gun cabinets, poker table, children's furniture, rocking horse, spinning wheels, and more. Bill of materials exploded drawings assist the woodworker. **FURNITURE DESIGNS, INC.** \$3.00. *Circle No. 345.*

UNIQUE WOOD PATTERNS—Let your imagination run wild. Each pattern given in 3 sizes. No enlarging or reducing is necessary. Simply trace, cut and create. A list of suggestions and helpful hints included with each pattern. List of patterns only \$1.00. **HOUSE OF STARR.** \$1.00. *Circle No. 375.*

PROJECT PLANS—Full-size patterns for over 500 easy-to-build woodworking projects. Nation's leading source for scroll saw patterns, cow projects, toy plans, yard ornaments, wood furniture, etc. Over 3000 hard-to-find specialty items. Send for your big new 72-page catalog. **MEISEL HARDWARE SPECIALTIES.** \$1.00. *Circle No. 401.*

THE COMPLIMENTS NEVER END!—when you show off your completed projects made from our full size patterns. Over 1000 unique, easy to make designs include popular folkart, wind action whirligigs, old world Santas, country furniture, shelves and shadow boxes, action toys, 3D layered animals, country critters, yard ornaments, Christmas yard decorations and more! No enlarging required—just trace our patterns onto wood and cut out. Fast service, satisfaction guaranteed. Send for our latest catalog. **THE WINFIELD COLLECTION.** \$1.00. *Circle No. 480.*

WOOD-MET SERVICES CATALOG LISTS SOME 700 PLANS—to build a wide variety of tools and accessories to equip your workshop. They vary from complete machines to hand tools, photo accessories to shop methods. Included are some 80 attachments for your lathes, drill presses & routers, over 60 hand tools, plus sander, welder, shaper, table saw accessories, etc. Others include a portable band sander, metal spinning tools, air compressor, 3/4" spindle wood shaper, wood lathe & chisels & a 12-in. thickness planer. Send for catalog, order plans, build the equipment for your shop and save. WOOD-MET. \$1.00. *Circle No. 496.*

LUMBER

QUALITY EXOTIC LUMBER/TURNING WOODS—We offer a comprehensive selection of fine quality exotic woods: Ebony, Kingwood, Tulipwood, Snake-wood, African Blackwood, Cocobolo, Bloodwood, Figured Maple, Spalted Maple, Padauk, etc. Unique and unusual turning woods and burls are also available. Send for catalog. BEREA HARDWOODS. \$1.00. *Circle No. 510.*

WOODWORKERS! HELP CELEBRATE OUR 62ND YEAR OF SERVICE—Send for our new 132-page Craftsman 1991-92 Catalog #58. 42 varieties of choice hardwoods 1/4 in. to 4-in. thickness. Fine hardwood veneers, tools, moldings, trim, marquetry inlays, upholstery and lamp supplies, finishes, clock kits, and hard-to-find hardware. 4,000-plus items for your projects. CRAFTSMAN WOOD SERVICE CO. \$1.00. *Circle No. 520.*

THIN LUMBER—Approximately 20 species—1/8" to 3/4" thickness. Thinner material sanded, all KD & surfaced—UPS delivery in continental US included in price. Packages of micro-lumber 1/8" - 1/2" thick. HARDWOODS OF ILLINOIS. 50¢. *Circle No. 545.*

STEVE H. WALL LUMBER CO—Quality hardwoods and woodworking machinery for the craftsman and educational institutions. 22-page catalog lists 15 species of popular hardwoods at wholesale prices. Also dealers for MiniMax, Freud and ProCut woodworking machines. STEVE H. WALL LUMBER CO. \$1.00. *Circle No. 592.*

EXOTIC IMPORTED AND DOMESTIC HARDWOODS—Over 75 species of lumber, bowl planks, turning squares and veneer. Samples 1/2" x 3" x 6" ideal for craftsmen, furniture and cabinet makers, architects, and designers available. Catalog provides common and botanical name, source, and description of each wood. Send for catalog. WOODWORKERS SUPPLY OF ARIZONA \$1.00. *Circle No. 598.*

VIDEOS

LOBO POWER TOOLS—Complete one stop location for all affordable woodworking power tools. Excellent quality at the most affordable prices. Customer satisfaction is job #1. We inventory and sell a full line of band saws, table saw, planers, jointers, sanders (all sizes) and much, much more. All equipment has a 1 year warranty. Send for video; price refundable with \$500 purchase. LOBO POWER TOOLS. \$10.00. *Circle No. 645.*

GENERAL WOODWORKING CATALOGS

CONSTANTINE'S WOODWORKERS' CATALOG—116 pages—over 4,000 woods, veneers, inlays, carvings, moldings, legs, pegs—everything for people who like to build with, turn, carve, refinish wood!

Includes 33 pages of hand and power tools, 24 pages of hard-to-find hardware, 12 pages of finishing supplies... books, kits, plans and more... all backed by Constantine's 180 years of woodworking experience and 60-day no-questions-asked guarantee. 2 year subscription. ALBERT CONSTANTINE AND SON, INC. \$1.00. *Circle No. 820.*

WOODWORKING CATALOGUE—Get your copy of our new full-color catalogue. You'll find the best prices and selection on thousands of different items for the craftsman, cabinetmaker, and hobbyist. Tools, books, and supplies are some of the many items we carry. Packed with gobs of goodies you can't resist. HARTVILLE TRUE VALUE HARDWARE. Free. *Circle No. 865.*

TOOL CATALOG—"Innovation" sets Leichtung apart from the rest! You'll find tools and accessories for the serious woodworker, do-it-yourselfer and hobbyist, many of exclusive design. 78 page full color catalog. 400-plus items. LEICHTUNG WORKSHOPS. Free. *Circle No. 878.*

COMPLEMENTARY TOOL CATALOG—Woodcraft offers over 4,000 of the finest quality woodworking tools, books, supplies, and cabinetry hardware in our complete full color catalog. Craftsmen, cabinetmakers, carvers, woodturners, and hobbyists have depended on Woodcraft since 1928. Backed by Woodcraft's unconditional guarantee. Free technical assistance. WOODCRAFT SUPPLY CORP. Free. *Circle No. 955.*

THE WOODWORKERS' STORE CATALOG—New! The Woodworkers' Store 1991-92 catalog with over 150 new items features 100 color pages of domestic and exotic hardwoods, veneers, wood parts, specialty hardware, kitchen accessories, finishing supplies, tools, books, and plans. Many exclusive items and hard to find specialties. Orders shipped in 24 to 48 hours. \$1.00 credited toward first purchase. Satisfaction guaranteed. WOODWORKERS' STORE. \$1.00. *Circle No. 965.*

KITS

OUR QUEEN ANNE FURNITURE KITS—are ready to assemble and finish. They include dining room table, chairs, hutch, sideboard, a variety of occasional tables, and a personal desk. All are made in solid cherry, oak, walnut, and mahogany. We also stock individual Queen Anne legs for every project. Complete information in our brochure packet. ADAMS WOOD PRODUCTS. Free. *Circle No. 1002.*

OAK FURNITURE AND ACCESSORY KIT CATALOG—features a full range of top quality oak furniture kits and accessory items plus unfinished assembled furniture. Featured items include roll top desks in several styles, stacking barrister's bookshelves, tables, chairs, trunks, file cabinets, bedroom furniture, Mariner's globe, plus many more. Send for full color catalog and enjoy true woodcrafting pleasure. CRAFTSMAN'S CORNER. Free. *Circle No. 1017.*

DO-IT-YOURSELF KITS—Choose from a large selection of grandfather, wall and mantel clocks, as well as elegantly styled accent furniture pieces. Kits are made of solid 3/4" hardwoods, primarily cherry, oak, and black walnut. Buy direct from the factory and save. Send for 36 page color catalog. EMPEROR CLOCK CO. \$1.00. *Circle No. 1030.*

QUALITY CLOCK KITS AND PLANS—Handmade and semi-assembled of carefully selected 3/4 in. cherry, oak, or walnut with beveled glass. Or build from "scratch" using our detailed plans and trim pieces. Choice of quality movements. Established in 1916. KUEMPEL CHIME CLOCK WORKS. \$3.00. *Circle No. 1050.*

SHOP ACCESSORIES

INTRODUCING THE AIR YOU WEAR—Available now for the woodworking industry, is a powered air respirator that is lightweight, portable and effective in filtering dust particles generated by all woods. The hard hat helmet assembly offers head protection and the impact resistant visor offers face and eye protection. Can be worn even if wearer has glasses or facial hair. Rechargeable battery operates unit for 10 continuous hours. Model AGH1 sells for \$299.00. Send for brochure. AIRSTREAM DUST HELMETS. Free. *Circle No. 1207.*

PATENTED SELF STABILIZING SAW HORSE—THE PACKHORSE—opens to a stable working surface on virtually any uneven floor or out-doors ground. Carried as easily as a tool box when clipped together, the pair of saw-horses conveniently stores in truck, trunk or closet. Dipped in boiled linseed oil for weather resistance. Clamp sites at each end for securing work. Practical and durable, for the professional or serious hobbyist, Packhorse tests to hold over two tons of weight. Send for brochure. DAVALCO PRODUCTS. Free. *Circle No. 1215.*

NEW...RADIAL ARM FENCE SYSTEM—Doyel Enterprises produces a precision cut-off and angle cutting fence system. Only one 90 degree cut is required on your table top (no more swiss cheese). Instantly replaces your existing wood fence. Angle accuracy less than 1/4 degree and cut-off accuracy of less than 1/16 inch. Quality heavy duty extruded and machined construction. Send \$2.50 (credited to first order) for complete brochure and instruction manual. DOYEL ENTERPRISES. \$2.50. *Circle No. 1225.*

EASY DOES IT—with HTC'S power tool accessories. Discover many unique items, designed only with you, the dedicated woodworker, in mind. Make your machinery safer, increase the working area of your shop and accomplish nearly impossible tasks easily, quickly, accurately. Full-line catalog and price list. HTC PRODUCTS, INC. Free. *Circle No. 1245.*

BUY YOUR SANDING BELTS DIRECT FROM THE MANUFACTURER—Industrial Abrasives is the company that gives you 12 free belts with every dozen ordered. But, sanding belts are not the only product we have to offer. In our catalog you will find many specialty items not readily available in your hardware store. Price of catalog refunded with first order. INDUSTRIAL ABRASIVES CO. \$1.00. *Circle No. 1248.*

ROUTER SPEED CONTROL—Reduces speed electronically without reducing torque. Route at the speed that gives best results with the wood and bit you are using. Speed adjustable from full speed to 0 RPM. Less tear out—stops burning—less wear on bits—easy to use. Send today for information. MLCS LTD. Free. *Circle No. 1251.*

WHOLESALE SANDPAPER, BELTS, SHEETS, CLOTH & PAPER DISCS—for orbital sanders. Shop rolls, flap wheels, hot melt glue sticks, dust masks, scuff pads, tack cloths, tape, wipers, etc. Supergrit offers quality abrasive and refinishing products at wholesale prices directly to the consumer. \$25.00 minimum order. Prompt, free UPS shipment to most areas. 20 page catalog. RED HILL CORP. 50¢. *Circle No. 1267.*

BITS, BLADES, CUTTING TOOLS

AmMax TOOL CO.—offers "Professional Quality" tungsten carbide tipped router bits, shaper cutters, saw blades, and 16" scroll saw machine, at lower "wholesale prices." 16" scroll saw featuring light load, cutting without blade breakage. UL and CSA approved. Nicholson carbide tipped saw blades from \$6.90; woodworking files from \$6.95. AmMAX TOOL CO. 50¢. *Circle No. 1304.*

CARBIDE-TIPPED ROUTER BIT AND SHAPER CUTTER CATALOG—We have hundreds of styles and thousands in stock ready to be shipped. We specialize in quantity discounts and same day shipping. These are top quality industrial router bits and shaper cutters at super low prices. Send now to receive new giant catalog. CASCADE TOOLS, INC. Free. Circle No. 1315.

TIRED OF THE IMPORTS?—All new 1991 router bit catalog featuring over 1100 items. This factory direct mail order 56-page catalog offers the industry's largest selection of the finest quality American made router bits, shaper cutters, and accessories. EAGLE AMERICA CORP. Free. Circle No. 1320.

WOODWORKING TOOLS—Freud provides the finest in hand tools, carbide cutting tools, and hand held power tools. From drills and sanders to carbide saw blades and router bits. Send for catalog. FREUD. \$2.00. Circle No. 1321.

PRODUCTION QUALITY CARBIDE TIPPED ROUTER BITS—MLCS Ltd. has a new 32-page catalog featuring hundreds of high quality carbide tipped router bits, shaper cutters, the Router Speed Control, the "Merle Adjustable Corner Clamp," plus other Professional Woodworking Products. Prices 50% to 70% lower than elsewhere. Value, quality and prompt service guaranteed! MLCS LTD. Free. Circle No. 1350.

for strength. Sizes from #4 x 3/8" to #12 x 4", with stainless steel, solid brass, brass plated, and zinc plated available. Quantity discounts. Send for literature. McFEELY HARDWOODS. \$1.00. Circle No. 1450.

WOOD TOY PATTERNS—Patterns for all ages including children's patterns and executive toys. New catalog has many new patterns to choose from including parts and wheels. Send for new catalog and receive a coupon for free wheels and axle pegs. TOYS AND JOYS. \$1.00. Circle No. 1480.

QUALITY AMERICAN-MADE WOOD TURNINGS—such as shaker pegs, spindles, toy wheels, toy parts, craft items, and dowel rods in birch, oak, walnut, and cherry. Send for complete 32-page catalog. WOODWORKS. \$1.00. Circle No. 1490.

INCOME OPPORTUNITIES

MAKE MONEY IN FURNITURE RESTORATION THE MINUTEMAN WAY—Earn \$200-\$1000 per day stripping, repairing, refinishing, mirror resilvering, and/or veneering, at home or in shop, spare time or full time. We provide complete training; no experience necessary. Free workshop teaches you latest in furniture restoration. You have to see it to believe it! Business preview video \$19.95. Send for catalog. MINUTEMAN. \$2.00. Circle No. 1661.

levels practically eliminating flat spots and chatter marks. INDUSTRIAL ABRASIVES CO. \$1.00 (refunded with first order). Circle No. 1976.

SARAL® WAX-FREE TRANSFER PAPER—Available in 5 colors, allows the user to transfer their design from a sketch, pattern, template or free hand to any surface. It makes crisp clean tracings which can be erased or painted over with no smearing. It's great for all woodworking projects. Brochure and sample. SARAL PAPER CO. INC. Free. Circle No. 2000.

IF YOU ARE INTERESTED IN RESTORING ANTIQUES—this 240-page catalog packed with unusual, hard-to-find items is just for you. Included are hundreds of essential items for antique restoration including top quality brass reproduction hardware, oil lamps and accessories, numerous wood component repair parts and kits, caning and basketry supplies, everything needed for wood refinishing, related tools, books, and a complete line of upholstery equipment and supplies. All at wholesale prices. Send for this informative catalog. VAN DYKE'S RESTORERS. \$1.00. Circle No. 2077.

LEGAL IVORY—Virtually identical to animal ivory. Tagua is the nut from a tropical palm tree. Ideal for jewelry, knobs, small turnings, inlay, or scrimshaw. Box of 10 REGULAR size (up to 1 1/2" diameter) or Box of 5 JUMBO. Send for information. WOODWORKERS SUPPLY OF ARIZONA. Free. Circle No. 2090.

HARDWARE/WOOD PARTS

TSQUARE DRIVE SCREWS—Thousands agree—once you try them you will never want to use anything else! The square drive recess virtually eliminates work-damaging driver bit "cam-out," the deep threads result in exceptional holding power, and they are heat treated

MISCELLANEOUS

THE CUSHION CONTOUR SANDER—is a new concept in pneumatic drum sanding. Sanding sleeves are slid over an air bag (inflated with a hand tire pump) on an arbor to mount it between centers on a wood lathe. Drum effectively takes on profiles, curves, and

CARVING SUPPLIES

WOOD CARVING MACHINES AND ACCESSORIES—make all types of wood carving easy, fun and profitable. The machines do the work. Whether for sign carving, flat 3-D, decoys, panels, gun stocks or furniture, we have the proper machine for the job. Professional woodcarving for the hobbyist and superior quality for the professional. Begin your hobby or full or part-time business by ordering our catalog and price list. MARLIN INDUSTRIES. \$1.00. Circle No. 2150.

WOODCARVING TOOLS—Whittlers and carvers—Warren Tool Co. offers a complete catalog of whittling and carving, hand/power tools, sharpening stones, wood cut-outs and related wood carving supplies. WARREN TOOL CO., INC. \$1.00. Circle No. 2185.

WOOD CARVERS SUPPLY INC.—OUR 36TH YEAR—Complete 76-page color catalog including over 2,000 carving tools, books & supplies, such as carousel animal kits, gun checkering tools, ship model kits, plus much more. We offer great service, quality products and a 30-day money back guarantee. Send for 2-year subscription. WOOD CARVERS SUPPLY INC. \$2.00. Circle No. 2190.

CLAMPS

MERLE ADJUSTABLE CORNER CLAMP—Quick & easy to use. Fully adjustable from 2 1/2" to 69x69 in. Perfect for clamping picture frames, cabinets, or anything that requires 90° corner clamping. The Merle Clamp is cast aluminum & steel construction, a true industrial quality tool. Send today for information. MLCS LTD. Free. Circle No. 2250.

CLOCKS

KLOCKIT'S FREE 64-PAGE COLOR CATALOG—is packed with the largest selection of beautiful wood clock kits for all skill levels, a huge selection of quartz and mechanical clock movements, dials and accessories, turned wood parts, music movements, tools and much more for the craftsman! KLOCKIT. Free. Circle No. 2335.

Worth writing for...



Better Homes and Gardens®
WOOD Magazine, November 1991
Dept. NOW091
P.O. Box 2713
Boulder, Colorado 80329-2713

TO ENSURE PROMPT HANDLING OF YOUR ORDER FOLLOW THESE INSTRUCTIONS:

- Circle your choice
- Enclose check or money order for cost of booklets plus \$2.00 service charge (no stamps accepted)
- NO FOREIGN ORDERS ACCEPTED
- Send coupon and remittance to address above
- ALLOW 4-6 WEEKS FOR DELIVERY
- Coupon expires December 15, 1992

WOOD SUBSCRIPTION

1. A 1 year WOOD subscription (9 issues) for \$24.97 (U.S. price)—a \$10.58 savings off newsstand rate. Allow 6-8 weeks for first issue. Canadian price \$34.00. Be sure to include payment with total below. NO FOREIGN ORDERS ACCEPTED ON THIS COUPON; please contact Subscription Dept. directly.

Circle numbers below corresponding to items in this issue. Please include \$2.00 for handling charge.

6\$3.00	85Free	375\$1.00	820\$1.00	1215Free	1350Free	2185\$1.00
10Free	87Free	401\$1.00	865Free	1225\$2.50	1450\$1.00	2190\$2.00
33Free	88\$1.00	480\$1.00	878Free	1245Free	1480\$1.00	2250Free
57Free	93\$1.00	496\$1.00	955Free	1248\$1.00	1490\$1.00	2335Free
61Free	94\$1.00	510\$1.00	965\$1.00	1251Free	1661\$2.00	
75Free	160\$1.00	520\$1.00	1002Free	126750¢	1976\$1.00	
76Free	190\$1.50	54550¢	1017Free	130450¢	2000Free	
77Free	310\$2.00	592\$1.00	1030\$1.00	1315Free	2077\$1.00	
78\$1.00	315\$1.00	598\$1.00	1050\$3.00	1320Free	2090Free	
84Free	345\$3.00	645\$10.00	1207Free	1321\$2.00	2150\$1.00	

Name (please print) _____
Address _____
City _____
State _____ Zip Code _____

I AM ENCLOSING:

\$ _____ for priced items
\$ 2.00 for handling
\$ _____ total remittance

Just In Time For The Holidays.



**Free
Extra
Battery**



Model 6095DWE

***Special limited-time offer on a
great cordless driver-drill.***

The versatile **6095DW** is a heavy-duty 3/8" cordless driver-drill with a *keyless* chuck. All it requires is a flick of the wrist and you're ready to change bits. And right now, Makita is offering it as Model **6095DWE** with a dual voltage (7.2V and 9.6V) fast charger, tool case and a *free* extra battery.

**Great
Gift
Idea**



Model 6040DW

***A super gift idea
that can be used year-round.***

Makita's lightweight (1.8 lbs.) **6040DW** is downsized, but it has plenty of power to take on most drilling and driving applications. A nonslip grip makes it easy to handle, and the built-in battery pack is rechargeable. The cordless convenience of the **6040DW** makes it invaluable around the house year-round.



For the location of the participating Makita Power Tool Distributor nearest you, check in the Yellow Pages under "Tools - Electric." The 6095DWE special won't be around long, and quantities are limited, so act fast.

Makita

IT'S ALL THE POWER YOU NEED.®

14930 Northam Street, La Mirada, California 90638-5753

CHOICE CUTS. \$349.

We figured it was time you moved up to stationary tools that are a cut above the rest. Time for Delta quality. The pros' choice. Your choice, 349 bucks.*

For starters, we're giving you two table saws and a band saw.

But to rip a perfect edge, you need to start with a perfect edge. So we added a jointer. For \$349.

Now all those perfect boards are going to call for perfect holes. Yep, the perfect drill press.

You see, one choice tool leads to another. And another.

So your only decision is just where to start. It's your choice. Any one or several.

Call toll free for the name of your nearest dealer. Delta International Machinery Corp., 800/438-2486.

Our 16½" Drill Press gives you 12 speed options, locking depth stop, tilting table, 5/8" capacity chuck and lots of cast iron. Versatility and precision galore.



Our 16" Band Saw is a 3-wheel design for greater capacity; cuts up to 8" thick x16" wide. Tilting table for bevel cutting.



Our Super 10 Saw has a quiet 1 HP induction motor. It features a 22¼" x 38 3/8" table, single lever rip fence, miter gage and see-thru blade guard.

The Delta 6" Jointer with three-knife cutterhead and large cast iron table gives you a precision edge. Comes with steel stand.



Our 10" Table Saw has a powerful 15 Amp, universal series motor and exclusive belt drive. And many of the same features as the Super 10. Your Delta dealer can help you decide which saw is best for you.

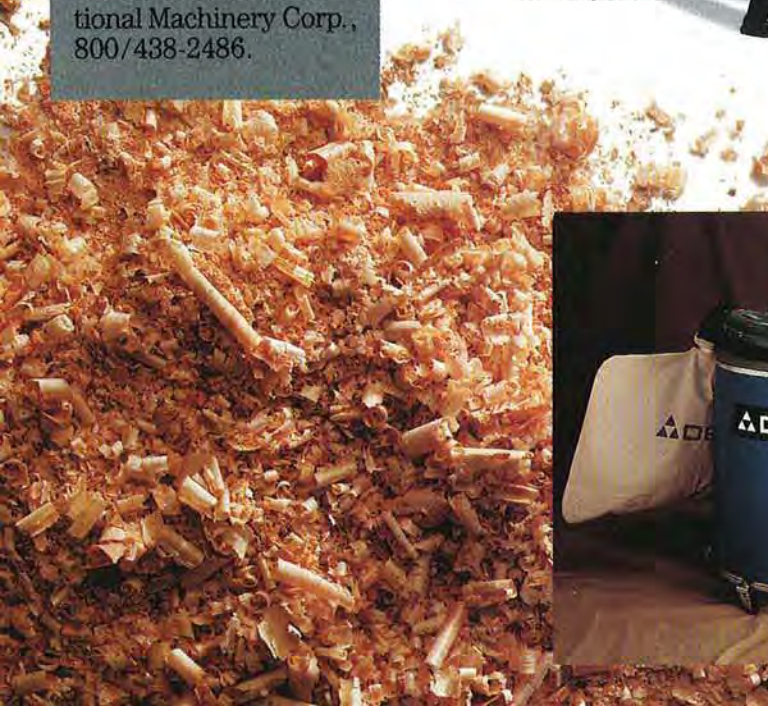

All that quality dust, from all those quality cuts...you might as well go Delta Quality all the way, and breathe easy. Here's a powerful two-stage, industrial quality, portable Dust Collector.

*Offer good only from participating dealers in the continental U.S., Alaska and Hawaii, from September 1, 1991 thru March 31, 1992.

**Building
On Tradition**
DELTA
A Pentair Company