

Better Homes and Gardens®

WOOD®

HAPPY
HOLIDAYS
TO ONE & ALL

THE WORLD'S LEADING WOODWORKING MAGAZINE

DECEMBER 1993 • ISSUE NO. 66
Please display until December 13

TOOL REVIEW

**18 POWER NAILERS
FOR HOME SHOPS**

SPECIAL REPORT

**THE WOOD® GANG
GOES LOGGING**

**20 HOT TIPS FROM A
PRO SCROLLSAWER**

GIFTS GALORE!

Train puzzle

Wristwatch bezels

3 carved ornaments

Heart jewelry box

Country plate shelf

Dinosaur clock

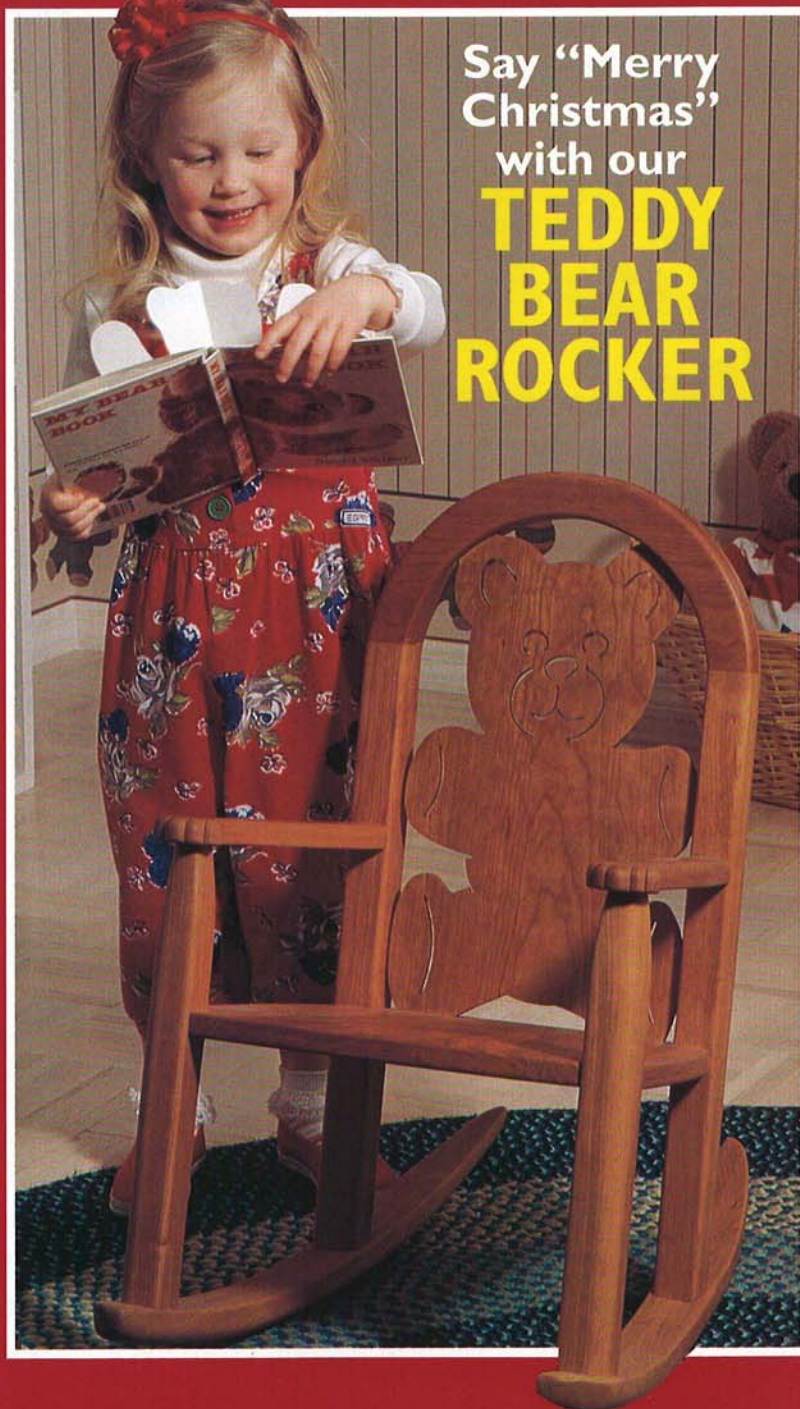

Say "Merry
Christmas"
with our
**TEDDY
BEAR
ROCKER**





IMPORTS, INC.

"IMPORTERS OF FINE MACHINERY"

NO MIDDLEMEN!

We import high quality machines direct from the manufacturers overseas and sell them directly to you at low, down to earth pricing. When it comes to selection, high quality, pricing, after-service and honest dealings, GRIZZLY is second to none.



Now Celebrating
10 years of
Superior Service,
Lowest Possible Prices
& Customer Satisfaction.

**CALL TODAY FOR YOUR
FREE 1993 TOOL CATALOG!**



6" x 17" EDGE SANDER

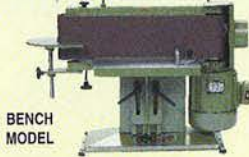

BENCH
MODEL

SANDING BELTS AVAILABLE!

- 3/4 H.P. motor
- Belt size: 6" x 48"
- Quick-release lever
- Table size: 7" x 13 3/4"
- Cast iron table

MODEL G1072

ONLY \$225⁰⁰

COMBINATION SANDER



6" X 48" BELT,
9" DISC

- 3/4 H.P. single phase
- Quick-release lever
- Miter gauge
- Cast iron table tilts 0-45°

MODEL G1014

ONLY \$195⁰⁰

THE BEST 16" BANDSAW ON THE MARKET!

- 1 1/2 H.P., 110/220V
- 3 blade speeds
- Precision balanced wheels
- One-piece cast iron body
- Cast iron table tilts 0-45°



MODEL G1073

Reg. \$575⁰⁰

ONLY \$550⁰⁰

NEW!

10" HEAVY-DUTY TABLE SAW WITH CAST IRON WINGS

- 1 1/2 H.P.
- 110V or 220V
- All-ball bearing arbor tilts using worm gear mechanism



MODEL G1022

Reg. \$395⁰⁰

ONLY \$375⁰⁰

SALE!

10" TILTING ARBOR SUPER H.D. TABLE SAW

- 3 H.P./220V
- Steel cabinet
- Cast iron wings



MODEL G1023

ONLY \$895⁰⁰



WOOD SHAPER

- 3/4 H.P. motor with reversing switch
- All-ball bearing construction
- Large cast iron table

MODEL G1024

ONLY \$295⁰⁰



1-1/2 H.P. SHAPER

- 2 interchangeable spindles
- 110/220V
- 2 spindle speeds
- Cast iron table

MODEL G1035

ONLY \$535⁰⁰



3 H.P. SHAPER

- 3 interchangeable spindles
- 220V motor w/ rev. switch
- Independently adjustable split fence

MODEL G1026

ONLY \$850⁰⁰

4" JOINTER

- 1/2 H.P. motor
- Heavy-duty cast iron beds
- 3-knife cutterhead
- Built-in dust chute



MODEL G1067

ONLY \$250⁰⁰

6" JOINTER

- 1 H.P., 110/220V
- Fence tilts to 45°
- Exclusive 47" bed

MODEL G1182

Reg. \$395⁰⁰

ONLY \$375⁰⁰

SALE!



8" JOINTER

- 1 1/2 H.P., 220V
- One-piece steel stand
- Super heavy-duty fence
- Cast iron beds

MODEL G1018

ONLY \$695⁰⁰



20" PLANER

- 20" X 8" capacity
- 3 H.P., 220V
- 4-blade cutterhead
- Cast iron table

MODEL G1033

ONLY \$1295⁰⁰



12" PLANER

- Cutterhead speed 8,000 R.P.M.
- 2 blade cutterhead
- 2 H.P./ 110V
- 16 AMPS

FREE SET OF EXTRA BLADES

MODEL G1017

ONLY \$395⁰⁰

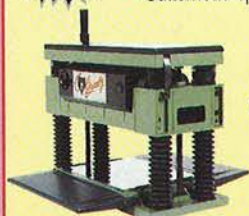

15" PLANER

- 2 H.P., 10 AMPS, 220V
- 2 speeds
- PLANER ONLY

MODEL G1021

ONLY \$765⁰⁰

PACKAGE DEAL WITH STAND

ONLY \$795⁰⁰



ALL MACHINES LISTED ARE F.O.B. BELLINGHAM, WA or WILLIAMSPORT, PA

P.O. BOX 2069, BELLINGHAM, WA 98227
Customer Service: (206) 647-0801
FAX (Orders Only): 1-800-225-0021

**ORDERS:
1-800-541-5537**

IF YOU LIVE
WEST
OF THE
MISSISSIPPI



IF YOU LIVE
EAST
OF THE
MISSISSIPPI

2406 REACH RD., WILLIAMSPORT, PA 17701
Customer Service: (717) 326-3806
FAX (Orders Only): 1-800-438-5901

**ORDERS:
1-800-523-4777**

THE EDITOR'S ANGLE

A BRAND-NEW EXPERIENCE FOR THE GANG AT WOOD® MAGAZINE



Several of the *WOOD* magazine staff, Clayton and Greg Wood (the owners of the timberland), and Wood-Mizer employees Jim Mann and Burl Tichenor relax a spell on the day's log harvest that soon will run through the sawmill.

One day last winter the folks from Wood-Mizer came calling on the *WOOD* staff to talk with us about the virtues of their portable bandsaw mills. And though they didn't realize it at the time, their presentation did more than just familiarize us with their product. It got several of us fever-pitch excited about the idea of taking to the woods and milling our very own boards from just-felled trees. We were so excited, in fact, that we could hardly wait to fit our hard hats on and fire up the chainsaws.

None of us had ever used a portable sawmill before. So we were mightily relieved when Wood-Mizer not only agreed to loan us one of their machines to use, but also offered to send a couple of their employees to Des Moines to show us how to operate the equipment safely. We were in for an education.

Photograph: Wm. Hopkins

On the appointed day last March, we met up with Jim Mann and Burl Tichenor, Wood-Mizer employees who had hauled the sawmill several hundred miles from Indiana. What followed can only be described as one of the most enjoyable and informative days the staff and I have ever experienced. But boy, were we ever pooped out that evening! It was a good tired, though, if you know what I mean.

Fortunately, we thought ahead and had photographer Bill Hopkins on hand to record our experience. So if you want to know more about our woodland adventure, or harvesting your own boards, turn to *page 56* and read Pete Stephano's article, "The *WOOD* Gang Goes Logging." I guarantee you'll enjoy it.

Happy holidays, everyone! 🌲

Larry Clayton

WE CARE! SUBSCRIPTION SERVICE: For change of address it is best for you to directly contact your local Postmaster who then will notify us. For any other service on your subscription, please write *WOOD* Customer Service, P.O. Box 55050, Boulder, CO 80322-5050 (enclose a recent label from your magazine for better service). Or you may phone toll-free **800-374-9663**. EDITORIAL MAILING ADDRESS: *WOOD* magazine, 1912 Grand Ave., Des Moines, IA 50309-3379.

MAD MARLING FALL SPECIALS



TOLL FREE 1-800-247-7178

	6041 DW 4.8 Volt Cordless Drill	\$ 41.95
	6095 DWE 9.6 Volt Cordless Drill Kit	
	w/Extra Battery	\$137.00
	6011 DWE 12 Volt Cordless Drill Kit	
	w/Extra Battery	\$159.95
	6201 DWE 9.6 Volt Cordless Drill Kit	
	w/Extra Battery	\$158.95
	6211 DWE 12 Volt Cordless Drill Kit	
	w/Extra Battery	\$168.95
	2708 W 8 1/4" Table Saw	
	w/10 Free Blades	\$299.95
	2012 Planer w/Free Stand	\$499.00
	BO 4550 Finish Sander	\$ 46.95
	BO 5000 Random Orbit Sander	\$ 63.95
	LS 1011 10" Slide Compound Saw	\$494.95
	N 1900B 3 1/4" Planer	\$133.95
	9820-2 Blade Sharpener	\$189.95
	DW 682K Plate Joiner Kit	\$219.95
	DW 705 12" Compound	
	Miter Saw	\$349.95
	DW 625 3 H.P. v.s. Plunge Router	\$277.95
	DW 615 1 1/4 H.P.	
	v.s. Plunge Router	\$158.95

*Call for Pricing on Other Makita, Dewalt, and Hitachi Tools

HOURS: 7:30-5:00 Monday-Friday

FREE FREIGHT
On All Tools
IN CONTINENTAL U.S.
48 STATES

5.5% Sales Tax for
Wisconsin Residents
VISA • MasterCard • Money
Order • Check • C.O.D.

PRICES SUBJECT TO
CHANGE WITHOUT NOTICE

P.O. BOX 7668
1801 EAST WASHINGTON AVE.
MADISON, WI 53707

Put Your Entire Shop On Wheels

MOBILE MACHINE BASES

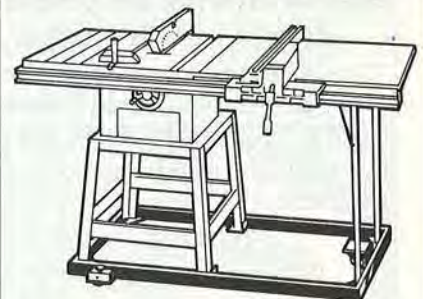

- Increase your working area
- Store machines when not in use
- Hundreds of models available
- Precision welded steel construction
- Three 2-1/2" wheels for stability
- Dual wheel locks provide positive positioning
- Lifetime warranty

Call for a free catalog



HTC Products, Inc.
120 E. Hudson • P.O. Box 839
Royal Oak, Michigan 48068-0839

(800) 624-2027

Fein "Triangle" Sander Eliminates

Hand Sanding
Now At New Low Price!



With the NEW Fein "Triangle" Sander, time consuming, sore finger, bloody knuckle sanding is a thing of the past.

Imagine using a power tool to sand all those areas where before, you had to fold up a piece of paper and "finger sand."

You know all those difficult to sand areas; inside & outside edges, closed corners, coves, spots, glue marks, seams, moldings, intricate profiles and so on. **With the Fein "Triangle" Sander, you can sand right up to, into and along edges & corners without dulling the edge or altering the profile.**

Here's how it works.

Unlike ordinary sanders, the Fein "Triangle" Sander doesn't rotate. Instead it "oscillates" (a back and forth movement) at a blurring 20,000 times a minute.

New Low Price

We've gotten the price down as low as possible, with a new list price of only \$275! (It was \$365.00 in 1992).

The Fein "Triangle" Sander takes the drudgery out of hand sanding and frees up hours of your valuable time.

It's easy to get more information, simply call:

1-800-441-9878



FEIN Power Tools Inc.
3019 W. Carson St.
Pittsburgh, PA 15204
(412)331-2325

©Fein Power Tools, Inc. 1993

Better Homes and Gardens®

WOOD

THE WORLD'S LEADING WOODWORKING MAGAZINE

DECEMBER 1993

ISSUE NO. 66



CRAFTSMAN CLOSEUP

Bandsaw boxes to behold 25
Holed up in his workshop in the mountain city of Boulder, Colorado, forty-one-year-old Jerry Patrasso creates expertly crafted bandsawn boxes. See shinning examples of Jerry's work inside and discover the secrets to his success.

TOOL BUYMANSHIP

Woodworking's sure shots 30
Can a power nailer or stapler serve a need in your workshop? Absolutely! Check out the 18 affordable models rated here.

CHRISTMAS GIFT SECTION

The one and only teddy bear chair 36
Please a child this Christmas with our charming heirloom rocker. Made from cherry, it features a cutout teddy bear backrest and bear-paw armrests. Sorry, storybooks are not included.

CARVING

Terrific tree trimmings 42
Try your hand (and your bench knife) on these yuletide ornaments: a carousel horse, Santa riding a balloon, and gnome Santa.



One sweetheart of a jewelry box 46
Build the perfect gift for a friend or loved one—our multilevel bandsawn box. Note how each tray rotates out for easy access for rings, necklaces, and other fine jewelry.

Country-time plate rack 49
Accent your kitchen or dining room with a homespun storage unit that brims with backwoods good looks. Our two-shelfer features an apple cutout in the top rail and knotty-pine plank paneling for the project's back.

This issue's cover wood grain :Satinwood

TURNING

Ring around the wristwatch 52
Purchase one of the watches in our Buying Guide, and then turn an attractive bezel for it from our selection. What a great gift idea!

DEVELOP YOUR SHOP SKILLS

How to deal with glue squeeze-out 55
Put our proven method to work and avoid letting excess glue in project joints stand in the way of a quality staining and finishing job.

The WOOD gang goes loggin'..... 56
Come join us as we spend a day felling ash, cherry, and walnut trees and slicing the resulting logs into valuable lumber using a portable bandsaw mill. Timber owners, this is a must-read.



CRAFT SHOP
Choo-choo to go 62
Kids will love you to pieces when you give them this clever puzzle. Its wheeled car parts hook together making a complete train.

Time of the dinosaurs 64
Scrollsawers, you'll enjoy cutting out this prehistoric clock.

SHOP-TESTED TECHNIQUES

Rick's tricks for scrollsawing success..... 66
Learn about blades, cutting techniques, and other related subjects from one of the country's most experienced scrollsawers.



Gregory the Grenadier..... 72
Add to the holiday spirit by crafting and painting this superb nutcracker figure designed by Virginian Glenn Crider.



SHORT-SUBJECT FEATURES

Editor's Angle1	Gregory (continued).....74
Talking Back.....7	Spray-on suede.....78
Tips From Your Shop.....10	Products That Perform.....80
Great Ideas For Your Shop..16	Toy Contest Rules.....86
Ask WOOD19	Finishing Touches88

New
OLSON[®]
Premium Scroll Saw Blades

Pre-Introductory Offer
The Best Scroll Saw Blades You Can Buy!

- Smoothest
- Most Accurate
- Longest Lasting

Don't just take our word for it. Here's what the experts say.

"I believe they are the best blades that money can buy. You can see it has a sharper, smoother, micro-fine finish. This creates less drag...while providing the smoothest, most sand-free finish possible". Frank Pozsgai, Pozsgai's Designs

"The quality far surpasses anything I have used in the past. I am using the blade for intricate fretwork and find its performance to be outstanding, and far superior to any other blade I have used." J. Milton Baker, The ToyMan

"These are the blades of the future. They last at least three times longer with better performance". Marc Berner, professional scroller and scroll saw teacher

Available Soon from your Olson Dealer
5" Plain End Blades with Reverse Teeth
Univ. Sizes 5, 7 and 9



See for yourself. Send for your **free** blade in the size of your choice.

(circle size 5, 7 or 9)

Name _____

Address _____

City _____

State _____ Zip _____

The Olson Saw Company
16 Stony Hill Road, Dept. W
Bethel, CT 06801

HEGNER

Scroll Saws: Scrollvergnügen*



*Vergnügen: A German noun meaning delight or pleasure
Our customers love their HEGNER Saws because they are so easy to use and give such great results without sanding.
SAVE NOW during our Holiday Sale!
Call or write for free details today.

☎ 1-800-220-4264 ☎

Please send free information on your HEGNER Holiday Sale. 591

Name _____
Address _____
City, State _____
Phone _____ Zip _____

ADVANCED
MACHINERY
IMPORTS
P.O. Box 312, Dept. 591
New Castle, DE 19720
FAX 302 • 322 • 3479

Better Homes and Gardens®

WOOD®

THE WORLD'S LEADING
WOODWORKING MAGAZINE

December 1993 • Vol. 10, No. 9 • Issue No. 66

Editorial/Art Staff

Editor **LARRY CLAYTON**
Managing Editor **JIM HARROLD**
Art Director **C. L. GATZKE**
Design Editor **JAMES R. DOWNING**
Senior Editor/Features **PETER J. STEPHANO**
Senior Editor/How-To **MARLEN KEMMET**
Assistant Managing Editor/Products **BILL KRIER**
Special-Interest Editor **LARRY JOHNSTON**
General-Interest Editor **TOM JACKSON**
Associate Art Director **PERRY A. McFARLIN**
Graphic Designer **CHERYL A. CIBULA**
Project Builder/Design Editor **JAMES E. BOELLING**
Production/Office Manager **DARLENE REYNOLDS**
Administrative Assistant **MARGARET CLOSNER**
Correspondence Writer **DON MOSTROM**
Art Business Office Secretary **NATALIE DeVORE**

Technical Illustrator **KIM DOWNING**. Product Testing
GEORGE GRANSETH, BOB McFARLIN, DAVE HENDERSON.
Carving **HARLEY REFSAL**. Projects **CHUCK HEDLUND**.

Publisher **WILLIAM R. REED**
Marketing/Advertising Director **CHRISTOPHER W. SCHRAFT**
Marketing/Sales Manager **DONNA BREHM**
Sales/Marketing Representative **JON BOOK**
Advertising Representatives **BRENDEAN DELANEY,**
VICTORIA PELCYGER

Marketing/Advertising Services Manager **SIGRID ANDERSON**
Promotion Supervisor **RICK PALLISTER**
Marketing/Advertising Services Supervisor **PAT HENDERSHOTT**
Administrative Assistant **KATHY GARLAND**
Assistant Product Manager **DEBBIE REYNOLDS**
ADVERTISING OFFICE: 1912 Grand Avenue, Des Moines, IA
50309. Phone 515/284-3785

Circulation Manager **ALAN BRUSH**
Business Manager **JANET NELSON**
Newsstand Circulation Director **MICHAEL SENIOR**
Production and Technology Director **ROBERT C. FURSTENAU**

Magazine Group Officers

President **WILLIAM T. KERR**. Vice Presidents/Publishing
Directors **MYRNA BLYTH, CHRISTOPHER LEHMAN,**
CHRISTOPHER LITTLE, JOHN LOUGHLIN, ROBERT MATE,
JERRY WARD. Vice Presidents, Better Homes and Gardens
JERRY KAPLAN, JEAN LEMMON. Vice President, Operations
DEAN PIETERS. Vice President, Finance **MAX RUNCIMAN**.
Vice President, Director of New Product Development **DAVID**
JORDAN. Vice Presidents, Marketing **WILLIAM MURPHY,**
CLEM SEVDE. Vice President, Circulation **HAL ORINGER**.

Corporate Officers

Chairman of Executive Committee **E. T. MEREDITH III**.
Chairman of the Board, President, and Chief Executive
Officer **JACK D. REHM**. Group Presidents: Books **JOSEPH**
J. WARD. Broadcasting **PHILIP A. JONES**. Magazines
WILLIAM T. KERR. Real Estate **ALLEN SABBAG**.

Better Homes and Gardens® Wood® (ISSN-0743-894X) is published nine times a year in January, February, April, June, August, September, October, November, and December by Meredith Corporation, 1716 Locust St., Des Moines, IA 50309-3023. Second-class postage paid at Des Moines, Iowa, and at additional mailing offices. Better Homes and Gardens trademark registered in Canada and Australia. Marca Registrada en México. **ONE-YEAR SUBSCRIPTION PRICES:** U.S. and its possessions \$25; Canada, \$34; other countries, \$43. **POSTMASTER:** Send address changes to WOOD Magazine, P.O. Box 55050, Boulder, CO 80322-5050. ©COPYRIGHT MEREDITH CORPORATION 1993. ALL RIGHTS RESERVED. Canadian GST Reg. #R123482887.

PRINTED IN U.S.A.
MPA

TABLE & CHAIR KITS
READY TO
ASSEMBLE & FINISH
SOLID WALNUT
CHERRY-OAK-MAHOGANY



SOLID WALNUT

Free Catalogue

Adams Wood Products, Inc.
974 Forest Dr., Dept. M24,
Morristown, TN 37814
(615) 587-2942
Fax (615) 586-2188

Wood-Mizer®

5 Models from
\$6995!*

World's Largest
Manufacturer of
Portable Sawmills

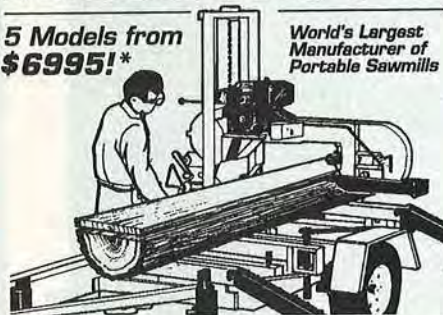

Own a Sawmill!

Save money cutting your own lumber,
make money cutting for others.

- Completely portable, easy to set up
- Highest quality, made in U.S.A.
- Cutting capacities up to 36" dia. x 33' long
- Optional hydraulic log handling (LT40 & LT30)
- 30% more yield than circular saws

1-800-553-0219

32-Page Full-Color Catalog \$2.00
Business Profitability Booklet \$2.00
66-Minute Demonstration Video \$10.00
Mastercard or Visa Accepted

*Shown with optional trailer

Wood-Mizer Products, Inc.
8180 West 10th Street Dept. GQ73
Indianapolis, In 46214-2400

**HIGHEST
QUALITY
ROUTER BITS &
SHAPER CUTTERS**



- Cutters are solid C-2 Carbide
- Ground with upto 600 G diamond wheel
- Largest selection
- Most orders shipped the same day
- Courteous, fast service

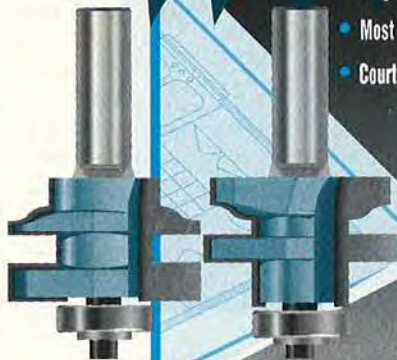

93G-115

CASCADE TOOLS, INC.

FOR A FREE
CATALOG CALL
24 HRS. A DAY!
1-800-235-0272
FAX: 1-800-392-5077

ROBLAND X 31 THE INTELLIGENT ONE MAN SHOP

90-MINUTE
DEMO
VIDEO



- 1100 lbs.
- 3 separate 3HP motors
- 12" jointer
- 12" planer
- 10" table saw
- 50" sliding table
- 3HP shaper
- mortiser
- cast iron

The Robland X 31 is designed to make maximum use of minimum space ideal for the small professional shop and the demanding hobbyist. Change from one tool to another in 20 seconds or less! Solid, sturdy, reliable.

CALL OR WRITE FOR MORE INFORMATION NOW!

2265 LAGUNA CANYON RD., LAGUNA BEACH, CA 92651

LAGUNA TOOLS

1-800-234-1976 or 714-494-7006

Best Catalog Values...

PENN STATE



Quality
Woodworking
Machines &
Accessories

Industries

Portable Panel Saw System

Makes Precision
Cabinet Maker Cuts!

Cut Sheet Goods
up to 8' long

Dealers Inquiries
Welcome!

A Special
Heavy Duty
Ball Bearing
Tracking System
that Works with
any Hand Held
Circular Saw
or Router
Includes:
• Tracking Fixture
• 64" Short fence
• 108" (9') Long Fence
Item # PPS-B

**SPECIAL
\$8900**
UPS \$10⁰⁰

Super 125 Planer



\$35905
UPS \$10⁰⁰

Item #: PLA
• Portable at 65 lbs • 26.2 fpm power feed
• HSS Knives 12-1/2" wide
• Motor: 16Amp, 8000 RPM 2 HP, 115V
• Rollers on infeed & outfeed tables

Air Brad Nailer Kit



\$12905
UPS \$10⁰⁰

Item #: ANK
• Shoots 18 ga nails from 13/32" to 1-9/16" • Lightweight at 2 lbs. • Contact safety switch • Kit includes: case, 5,000 free nails & accessories

Air Cleaning System



\$27900
UPS \$10⁰⁰

Item #: AC460
• Removes sawdust from the air you breathe • 460 CFM air circulator handles most shops • Washable pre-filter
• High efficiency internal bag filter
• Unit size: 12" x 24" x 30", 35 lbs.

Variable Speed Scroll Saw



\$16905
UPS \$10⁰⁰

Item #: SVS
"The crafters favorite!"
• Dial speeds 400-1800 c.p.m.
• E-Z bladeholders accept pin or plain blades • 15" capacity • 2" strike
• 45° tilt • Many extras worth \$50⁰⁰

Order Toll-Free
1-800-377-7297

Information: 215-676-7609

Fax: 215-676-7603

Call or Write for Catalog

Penn State Industries 2850 Comly Road Philadelphia, PA 19154 Dept W.

Also on our New 32
page color catalog:

- Full line of Dust Collectors and Accessories
- Full line of Air Nailers and Staplers
- Lathes
- Drill Presses
- Sanders
- Accessories and More...

30 Day Money Back Guarantee & 1 Year Warranty



How to keep your duck from looking like a silly goose.

The Dremel Heavy Duty Flex-Shaft tool gives you the power and control you need to create birds so lifelike they can almost fly. That's why it's the official carving tool of the Ward World Championship. The big 1/5 hp motor gives you the power you need for "hogging" out wood. The smooth running Flex-Shaft and interchangeable hand pieces run smooth and cool. And the variable speed foot pedal gives you precise, hands-free control from 0-20,000 rpm. That's the kind of control that makes all the difference in your carvings.

For more information, or to order the Heavy Duty Flex-Shaft tool, call us at 1 800 437-3635, Ext. 3.

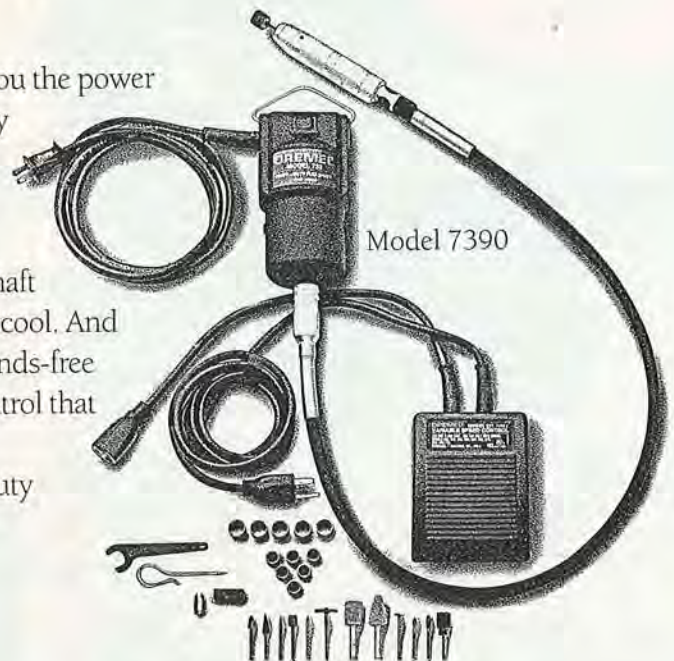

DREMEL®

TALKING BACK

 Print this article

We welcome comments, criticisms, suggestions, and even compliments. Send your correspondence to: Talking Back, Better Homes and Gardens® WOOD® Magazine, 1912 Grand Ave., Des Moines, IA 50309-3379.

Revisiting avocado

The "Wood Anecdote" in the August 1993 issue described avocado wood as "ugly grayish-brown," and not useful for woodworking. This description does not fit two species of avocado wood from my area of California. The Fuerte variety produces wood of a rich, warm, walnut color with a beautiful grain. The Anaheim variety is lighter in color with straighter grain.

I use avocado wood to craft clock cases, carvings, turned bowls, and, most recently, for intarsia. The wood works well, and requires no stain because of the natural beauty.

— Stewart Stodder, Fallbrook, Calif.

Dust system adapters

I just installed a complete dust-collection system in my home shop, using information from "Central Dust Collection" from the June 1991 issue. I followed your instructions, but the dust-collector hoses did not fit the PVC pipe and fittings.

For a solution, I used 11.5-ounce coffee cans with both ends removed to connect the 4" hoses, 15-ounce vegetable cans for the 3" hose, and small plastic bottles as connectors for the 2" hose. Large rubber bands help secure any loose joints.

— Norm Knight, Hemet, Calif.

It takes an extra hand

I have been using pushsticks similar to the one shown in the "Great Ideas for Your Shop" in the August 1993 issue, for many years on both my tablesaw and jointer. The design you published requires the use of a second hand on the end of the pushstick to hold the wood flat to the machine table. By itself, this pushstick could be used for short pieces only. Longer boards would require the use of a second pushstick to prevent the leading end of the board from being lifted and scalloped as it is fed across the jointer knives.

— Tom Rose, Los Angeles, Calif.

Continued on page 8

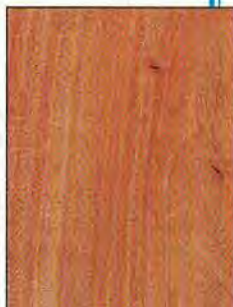

If Only Leonardo Da Vinci Had An RBI Hawk Precision Scroll Saw.



The Good News Is That You Can.

Leonardo would have envied the superior craftsmanship that goes into every RBI Hawk Precision Scroll Saw. Now you'll create the woodworking projects you've always dreamed of building.

Imagine creating beautiful crafts and toys, tole painting cutouts as well as intricate, detailed fretwork and inlays for chairs, cabinets, tables, and much more. With an RBI Hawk, you'll create projects that will be treasured...year after year.

What Size Saw Is Best For You?

We make three sizes of scroll saws—a 16", 20" and 26" model. Our customer representatives will be glad to assist you in choosing the saw that's just right for the artist in you.



Hawk Scroll Saws are perfect to begin or compliment any workshop. Cut wood, metal, glass, plastic, and more. It's the most versatile tool you'll own.

We also have the very best selection of accessories including blades, instructional and pattern books, and much, much more.

RBI Hawk Scroll Saws— The Renaissance in Scroll Saw Technology.

RBI Hawk's are designed and manufactured in the United States for the professional shop and the demanding hobbyist. After all, you're the first one to know that the projects you create are only as good as the tools you use.

**Call 1-800-487-2623 To Order
or To Get Your FREE Catalog.**

Our Guarantee To You

30-Day Money Back Guarantee
3-Year Warranty
(1 Year on Motor)

rbindustries

The American Tool Manufacturer

1801 Vine St. • PO Box 369
Harrisonville, MO 64701

C126

TALKING BACK

Continued from page 7

Fine pine from California

In your article "Tracking Down Good Wood" (June 1993 issue), you stated that the best Ponderosa pine comes from Oregon's high-altitude areas. I don't doubt that a lot of good pine comes from Oregon, but the western slopes of the Sierra Nevada mountains, the southern slopes of the Cascade range, and the area north of the Sacramento Valley in California supply a large percentage of quality pine.

I worked for the McCloud, California, lumber mill for 39 years. This mill produced 600,000 board feet of material every day, and enjoyed the reputation of producing some of the finest pine lumber anywhere in the world. The mill closed in 1979, but the current owner of the surrounding timberlands still harvests logs in the area, with a large portion of these logs being shipped to sawmills in southern Oregon.

— Ed Vandemark, Dunsmuir, Calif.

Thanks for expanding our boundaries, Ed.

Where in the world is the AWPTA?

In the "Finishing Touches" column of your December 1989 issue, you made mention of the Antique Woodworking Power Tool Association. When I wrote to the address listed, my letter was returned. Do you know of a current address for the AWPTA?

— Tim Byrne, Shoreview, Minn.

We haven't heard from these folks in about two years, Tim. If anyone out there has a more recent address for the Antique Woodworking Power Tools Association, please write us.

Mason & Sullivan finds a new owner

In the fall of 1992, Mason & Sullivan was purchased by Woodcraft Corporation. By the end of November 1993, a new Mason & Sullivan catalog will be published. To the largest extent possible, we are attempting to duplicate the product line that previous Mason & Sullivan customers have become accustomed to. To order the new catalog, call our Woodcraft Corporation customer service number 800/535-4482.

— Jody Garrett, Woodcraft Supply Corp.

WOODWORKER II - Best on TABLE SAW

With this ONE ALL PURPOSE blade (40 Teeth) you can SMOOTH RIP & CROSSCUT 1"-2" ROCKHARDS and SOFTWOODS with smooth-as-sanded surface. PLY-VENEERS (oak/birch) crosscut with NO BOTTOM SPLINTER.

- Mostly 1/8 kerf 15", ATB and 20" face hook (easyfeed).
- DOUBLE HARDER and 40% STRONGER CARBIDE.
- Ends blade changing (does rip, combo and crosscut).
- Ends scratchy saw cuts (for the rest of your life).
- Ends second step finishing (jointing or sanding).
- Ends cutting 1/16" oversize to allow for RESURFACING.
- Buy and sharpen ONE blade instead of 3 (24T rip, 50T Combination, 80T Crosscut).
- Strongly recommend our .001 flat large stiffener-dampener against outside of blade for smoothest, quietest cuts by this and any other blade.
- Use 30T if ripping mostly 2" - 3" hardwoods.
- Side wobble held .001 - others .004/.010 is common! RAISE for THICK woods, LOWER for THIN woods and perfect cut everything! All 5/8" holes, unless otherwise noted.

	List	SALE		List	SALE
14" x 40T x 1" BORE	\$215	\$149	9" x 40T	\$146	\$109
14" x 30T x 1" "	195	139	30T	125	99
12" x 40T x 1" "	183	129	7-1/4" x 40T 3/32	136	99
12" x 30T x 1" "	162	119	8" x 40T 3/32	136	99
10" x 40T 1/8 & 3/32	156	119	30T 3/32	115	89
30T 1/8 & 3/32	135	99	7-1/4" x 30T 3/32	112	69
			New 6" x 40T 3/32	139	89

\$7.50 extra - Shipping \$4.50 * NEW For Sears Table Saw

- Also help all your other blades to cut better. Use our 1/8" DAMPENERS STIFFENERS, against one side
- 4" - \$21 Tryable and RETURNABLE.
 - 5" - \$24 Stops vibration, flutter, cutting noise and blade ring.
 - 6" - \$25 Parallel and flat to .001" - 7" and larger available.

5/8" holes std. Boring up to 1-1/4" \$7.50 extra. Others available. Add \$2.50 Shipping.

WOODWORKER I - For TABLE and RADIAL SAW

this trim and crosscut ALL PURPOSE blade gives scratch free POLISHED cuts on all materials RIP or CROSSCUT up to 2".

- All 60T and 3/32" THIN kerf 30" ATB and 5" face hook on 10" dia and under, 12" and 14" are 20" ATB 1/8" K.
- DOUBLE HARDER and 40% STRONGER carbide.
- THIN KERF:-
- Saves 1/3 wood loss on each cut, radial or table. Feeds easy when used for moderate rip and crosscut on table saw. Reduces "JUMP IN" greatly for better "PULL CONTROL". Practically eliminates bottom splinter on RADIAL-CROSS CUT.
- Totally stops ALL bottom and top splinter on ply veneers in push-cut mode on RADIAL.
- Our STIFFENER STRONGLY RECOMMENDED AGAINST outside of blade only for best cuts.

Made and serviced in USA for your benefit.

	List	SALE
14" x 60T x 1" 1/8"	\$224	\$159
12" x 60T x 1" or 5/8" 1/8" K	198	139
10" x 60T x 5/8" 3/32" K	162	129
9" x 60T x 5/8" 3/32" K	156	119
8" x 60T x 5/8" 3/32" K	150	109
New 8-1/4" x 40T x 5/8" 3/32" K	136	99

RYOBI RA200 TS200 SEARS MAKITA 500B NBA
HITACHI PSM8 PORTER CABLE 368-1

DADO KING MULTITOOTH LASERCUT DADO SET cuts ALL 1/4" - 13/16 flat bottom grooves WITH or CROSSGRAIN all woods, OAK, BIRCH, VENEER PLYS, and MELAMINE. NO SPINTERING due to unique 4T Neg. Face fillers and 24T outside saws.

CUT PERFORMS 29 OTHER DADO SETS - Wood Magazine, Oct 91

Boring up to 1-1/4" SALE! 10% OFF
\$25 per set \$5.50 Per Set Shipping

8 - 5/8" Bore List \$321/SALE \$289 • 10 - 5/8" & 1" Bore List \$389/SALE \$349

Forrest Dado King (Superior)	Froid S2039 (Excellent)	V-A 2674 (Good)	U.S. Saw 800-C-PPD (Fair)	V-A 26747 (Poor)
• No tearout on all five woods tested.				
- Fine Woodworking July/Aug, 1991				

DURALINE HI-AT For TABLE & RADIAL SAW

(very good on chop saw tool) STOP SPLINTERING those SPLINTERY OAKS, HARDWOOD VENEERS and thin 2 SIDE LAMINATES ON PARTICLE BOARD.

FOR FASTER FEED RATES AND MORE ABSOLUTE SPLINTER CONTROL.

DURALINE HI-AT Note: Fine Woodworking Editorial Nov./Dec. 1988 No. 73, pg. 65, S.N. recommends high alternating top bevel (ATB) thin kerfs and large blade stiffeners for smoothest cuts on RADIAL SAW, etc.



Jim Forrest, President and designer microscoping cutting edge.

All 5/8" holes. Boring up to 1-1/4" \$7.50 extra Larger holes - time basis. Shipping \$4.50

	List	SALE
7-1/4" x 60T 3/32"	\$149	\$129
8" x 80T 1/8" & 3/32"	202	\$169
9" x 80T 1/8" & 3/32"	207	\$179
10" x 80T 1/8" & 3/32"	207	\$159

Special Sale on 10" Only \$159		
12" x 80T x 1" 1/8"	212	\$181
12" x 100T x 1" 1/8"	253	\$215
14" x 80T x 1" "	232	\$197
14" x 100T x 1" "	266	\$226
16" x 80T x 1" "	262	\$223
16" x 100T x 1" "	294	\$243

CARBIDE IS THE HARDEST OF THE C-4 GRADES AND 40% STRONGER, NOT WEAKER! For 50% to 300% longer life!

CHOPMASTER SERIES FOR MITER SAWS for tight, smooth, splinter-free miter joints. NEW AVAILABLE SIZES

NEW SPECS & Side Dial .001	List	SALE
Hitachi 8-1/2" DeWalt 8-1/2"	\$179	\$109
8-1/2" x 80T x 5/8"	204	119
Delta 10" x 80T x 5/8"	207	129
Ryobi-Makita 12" x 80T x 1"	229	139
Hitachi 14" x 100T x 1"	266	179
Ryobi-Makita 15" x 100T x 1"	277	189
Hitachi		

Use small stiffener where possible

WE RECOMMEND OUR FACTORY SHARPENING as some local sharpening creates problems with Micro-chipped edges reducing blade life & cutting quality. 2-4 DAYS ON THESE AND ALL MAKES OF FLAT FACE & CONCAVE CARBIDE TIP SAWS. SHIP VIA UPS. Typical 10 x 40T \$15.00, 60T \$17.75. Add return UPS \$4.50 or 2nd Day Air \$8.

SATISFACTION GUARANTEED OR FULL CASH REFUND. 47 years of fine American saw making & sharpening.

FORREST
FORREST MANUFACTURING COMPANY, INC.
461 RIVER ROAD, CLIFTON, NJ 07014
DEALER INQUIRIES WELCOME

BUSINESS OPEN ACCOUNTS AVAILABLE
FOR SPECIAL BONUS MENTION WOOD® MAGAZINE
We honor Amex, VISA, MasterCard & Discover. Money Orders, Personal Checks, and CODs. Specify Dept. WD when ordering.
PHONE TOLL FREE! 1 (800) 733-7111
(IN NJ; 201-473-5236) FAX: 201-471-3333

BUILDING OUR NAME...



WOOD LATHE
CL-1140 40" \$569

SHAPER
SP-30 1" \$849

4 SIDE MOULDER
SM-0604 6" \$25,900



UNI. TABLE SAW
TS-2010 10" \$1079
TS-1212 12" \$1479

PLANER
WP-0012 12" \$369
WP-1015 15" \$769
WP-0020 20" \$1295

PNEU. DRUM SANDER
FL-901 \$259

SANDER
SD-0069 6X9 \$189
SD-0612 6X12 \$429

RIP SAW
TRS-0012 12" \$8950

**DIGIT CONTROL
WIDE BELT SANDER**
CA-2548 24" \$6290
CA-3760 36" \$9390



JOINTER
JT-1006 6" \$259
JT-1008 8" \$639
JT-0012 12" \$1895

BAND SAW
BS-0163 16" \$499
BS-0183 18" \$609
BS-0202 20" \$1290

DUST COLLECT
DC-90 1HP \$189
DC-101 2HP \$299
DC-102 3HP \$459

WE SPECIALIZE IN
CUSTOMER SATISFACTION



ONE YEAR WARRANTY
OFFERING A LINE OF
FINE QUALITY MACHINE TOOLS

MAIN OFFICE:
9031 E. SLAUSON AVE.
PICO RIVERA, CA 90660
TEL: (310) 949-3747

ORDER DESK ONLY: ATLANTA:
(800) 786-LOBO (404) 416-6006
CHICAGO: CANADA:
(708) 798-9229 (519) 291-2280

LOBO POWER TOOLS

If Only Santa Claus Had An RBI Hawk Precision Scroll Saw.



(Well, maybe he does.)

This holiday, experience the pleasure of creating the woodworking projects that you've always dreamed of building.

Imagine you and your family building beautiful crafts and toys, tole painting cutouts as well as creating



Hawk Scroll Saws are perfect to begin or compliment any workshop. Cut wood, metal, glass, plastic, and more. It's the most versatile tool you'll own.

intricate, detailed fretwork and inlays for chairs, cabinets, tables, and much more. With RBI Hawk Precision Scroll Saws, you'll create projects that will be treasured...year after year.

There's a full range of sizes to choose from—a 16", 20" and 26" model. Our customer representatives will be glad to help you choose the model that's just right for you.

RBI Hawk Scroll Saws are designed and manufactured in the United States for the professional shop and the demanding hobbyist.

After all, you're the first one to know that the projects you create are only as good as the tools you use.



With the RBI Hawk, you can make toys, crafts, gifts, furniture and more. We also have the very best selection of accessories including blades, books, and much, much more.

Call 1-800-487-2623 To Order
or To Get Your FREE Catalog.

Our Guarantee To You

30-Day Money Back Guarantee
3-Year Warranty
(1 Year on Motor)

rbindustries
The American Tool Manufacturer
1801 Vine St. • PO Box 369
Harrisonville, MO 64701

C125

FORSTNER BIT SPECIAL!



Part No. C3187
ONLY \$24⁹⁵
REG. \$29⁹⁵

7-pc Forstner Bit Set

Used for flat bottom holes, boring through knots, making pocket holes and partial arcs. Seven most used sizes: 1/4", 3/8", 1/2", 5/8", 3/4", 7/8", and 1". All shanks are 3/8". Precision ground for smooth, vibration-free operation.

16-pc Forstner Bit Set

This quality set includes 16 bits: 1/4", 3/8", 1/2", 5/8", 3/4", 7/8", 1", 1 1/8", 1 1/4", 1 3/8", 1 1/2", 1 5/8", 1 3/4", 1 7/8", 2", and 2 1/8". Approximately 3 1/2" long. You can drill pocket, partial arc, and flat bottom holes. Drill through wood at virtually any angle. All shanks are 3/8".



Part No. C3188
ONLY \$79⁹⁵
REG. \$89⁹⁵

CASCADE TOOLS, INC.

FREE SHIPPING
ON ORDERS
OVER \$100⁰⁰

ORDER 24 HRS A DAY!
1-800-235-0272 EXT.
FAX 1-800-392-5077

EARN CASH, PRIZES FOR YOUR TOP SHOP TIP

Do you have a great shop tip (or two) you'd like to share with other *WOOD*® magazine readers? For each published submission, you will get at least \$40 from *WOOD* magazine (as much as \$200 if we devote a page or more of space elsewhere in the magazine to your idea). You also may earn a woodworking tool if your tip is selected as the Top Shop Tip for the issue.

We try not to use shop tips that have appeared in other magazines, so please send yours to only one. *We do not return shop tips.* Mail your tip(s), address, and daytime phone number to:

Top Shop Tip
WOOD Magazine
1912 Grand Ave.
Des Moines, IA 50309-3379

Planer makes bevels a saw can't handle

Sometimes, you want to cut a bevel that your tablesaw or jointer just can't handle, such as beveling the full width of a long piece of 8"-wide stock.

TIP: Do the job with your planer, employing an auxiliary table made from scrapwood and plywood like the one shown *below*. Make it long enough to reach from the front edge of the planer's infeed table to the back edge of the outfeed table. Cut angle A accurately;

Handle saves hands from allen wrench

Those L-shaped allen wrenches really dig into your hand during repeated use—when you're threading a lot of inside cuts on certain scrollsaws, for instance.

TIP: For relief, add a comfortable hardwood handle to the wrench. Along one edge of $\frac{3}{4} \times 1 \times 12$ " stock, saw a groove the width of the allen wrench ($\frac{1}{8}$ " in the instance

shown) and about $\frac{1}{2}$ " deep. Round over the edges of the stock by sanding or routing. Then, cut the handle to length, taking into account the size of your hand and any obstructions the handle will have to clear when in use. Drill a hole through the bottom of the slot, and epoxy the wrench into place in the handle.

—David Weber, Latrobe, Pa.

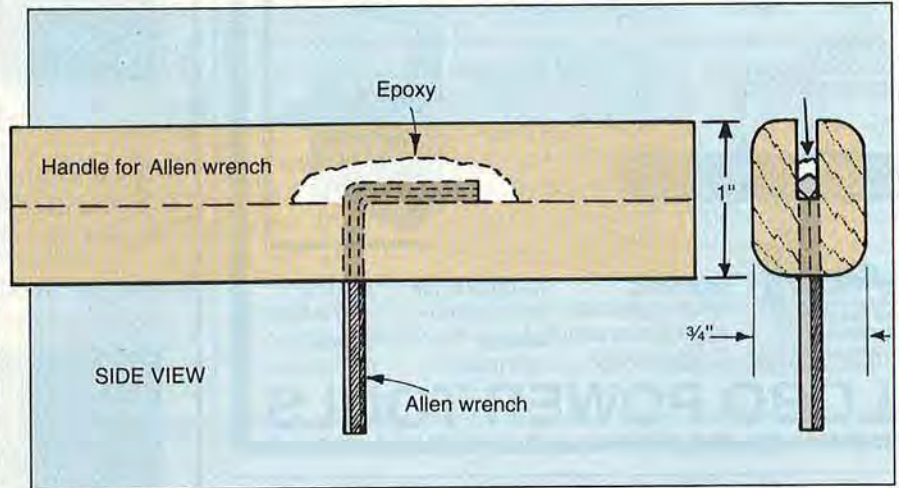

Planer makes bevels a saw can't handle

Sometimes, you want to cut a bevel that your tablesaw or jointer just can't handle, such as beveling the full width of a long piece of 8"-wide stock.

TIP: Do the job with your planer, employing an auxiliary table made from scrapwood and plywood like the one shown *below*. Make it long enough to reach from the front edge of the planer's infeed table to the back edge of the outfeed table. Cut angle A accurately;

it determines the bevel angle. Sand the sliding surfaces smooth and coat them with paraffin wax. Clamp the fixture to the planer table. Scribe a reference line for the bevel on the end of your workpiece, then lay it on the angled surface of the auxiliary table. Feed it through the planer, taking a series of shallow cuts to shave a perfect bevel on the face.

—Todd Grieser, Archbold, Ohio



For his tip, Todd receives a Sears/Craftsman 10" benchtop bandsaw, model no. 24450, above.

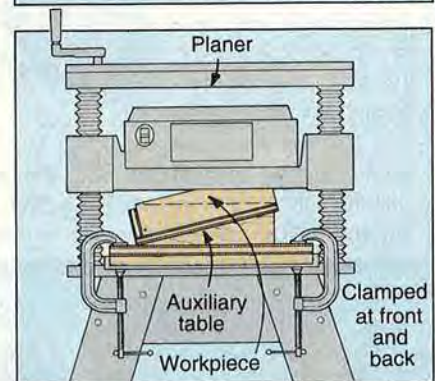
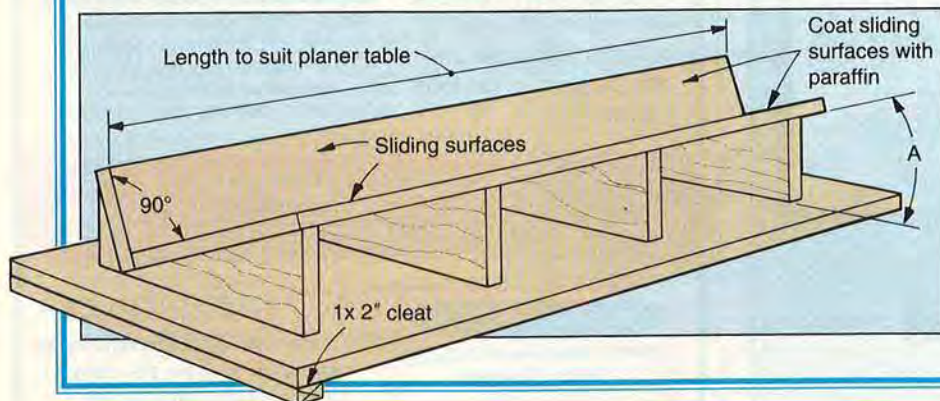

Continued on page 12

Freud Factory Rebate.

1. Buy our Biscuit Joiner or Plunge Router before January 15, 1994.
2. Mail rebate coupon.
3. Receive rebate check for \$30!

Easy as 1-2-3

Rebate
\$30!



Biscuit joining is rapidly becoming the preferred method of joining wood. With the Freud System you can create an exceptionally strong joint that is quicker and easier than doweling or other methods.

The Freud JS100 has an industrial duty cast housing, a solidly built drive system and a powerful 5 amp motor that will provide many years of service. But the performance from any power tool depends on the quality of the blade or cutter. Freud is world renowned for carbide cutting tools and the blade for the JS100 is made using the same advanced technology in the same factories.

With this system you get a carrying case, blade removal tools, sample bag of biscuits, complete instruction manual and our special lubricant. With all this, you can see why this has been the tool preferred by many professionals, and leading authorities in the field.

Now is the best time to buy the Freud JS100 Joiner System. Go to your participating dealer and get your best price and we will send you a check for \$30.*

Rebate
\$30!



Freud's new FT2000E router gives you more power - at your own pace. Features include $3\frac{1}{4}$ developed horsepower at 15 amps. This is the most power you can get from a hand-held power tool that will still run on standard household current. We also include a $\frac{1}{2}$ " collet (with a $\frac{1}{4}$ " collet reducer) - the longest collet available. You can be sure your bits are secure, even under heavy loads.

The micro-adjustment depth control makes accurate vertical settings easily. The special new variable speed feature lets you choose exactly how fast you want to go - anywhere from 8,000 to 22,000 RPMs. Constant RPM feature lets you handle the feed speed your way - and still maintain set RPMs. Top it off with a soft start feature and you've got a real bargain.

Once you get your hands on our router, you won't want to let it go. Plus, if you buy our router from a participating dealer, we'll send you \$30 bucks!® Now that's something to hang onto.

freud®

Precisely what you need.

*Rebates available only on Freud JS100 and Freud FT2000E purchased from participating dealers before January 15, 1994. Offer good only in the continental US, Alaska and Hawaii.

For the name of your participating dealer or full details on the rebate call 800-472-7307.

Santa Wreath Hanger Plan



This creative new way to display your holiday wreath is a sure bet to bring lots of smiles from your family and guests. Santa measures approximately 23 inches high and fits both artificial and fresh wreaths in the popular 24" size. Patterns drawn FULL SIZE.

#W1235 Santa Wreath Hanger Plan.....\$7.99/EA

Santa Wreath Hanger Hardware Parts

This hardware package contains the plastic eyes and mouth, white pom pom, light-up nose, and complete electrical wiring harness for making one Santa Wreath Hanger. Project plan, wood, paint, and wreath are not included.

#1360 Santa Light-Up Wreath Hanger Hardware Parts\$5.99/PKG

HOW TO ORDER: List quantity, part number, item, price & total of order. Include \$5.45 shipping & handling per order. MN residents add 6.5% sales tax. Mail check or money order.

Credit card customers call
TOLL FREE 1-800-441-9870.

MEISEL HARDWARE SPECIALTIES
P.O. BOX 70 J12X MOUND, MN 55364

THE WOODTURNERS CATALOG

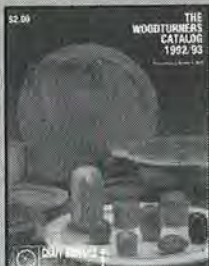

Craft Supplies USA offers woodturners the finest selection of woodturning tools and accessories anywhere.

CHOOSE FROM:

- HENRY TAYLOR TOOLS
- RICHARD RAFFAN TOOLS
- DALE NISH WORKSHOPS
- WOODFAST WOOD LATHES
- COMPLETE LINE OF PEN, PENCIL, FOUNTAIN AND ROLLERBALL KITS

We offer the best quality, prices and service, guaranteed!
Send \$2.00 for our 52 page color catalog.
Craft Supplies USA
PO Box 50300
Provo UT 84605-0030
Phone (801) 373-0919

TIPS FROM YOUR SHOP (AND OURS)

Continued from page 10

Pipe insulation protects shop projects from damage

Your sawhorses may project parts laid across them. And, you're just not having much luck keeping folded shop rags in place on the 2x4 sawhorse edges while wrestling a large panel onto them.

TIP: Open up a piece of formed foam insulation for 3/4" pipe and slip it over the sawhorse top. It grips the sawhorse well enough to stay in place, and protects even finish-sanded parts from damage.

-R.J. Cooke, Newington, Conn.

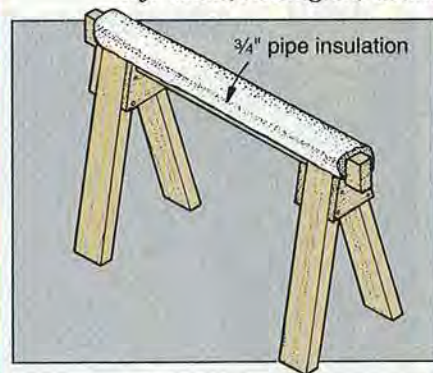

Spray glue helps sandpaper stand up to machine use

Plain sandpaper doesn't last very long on your finishing sander. It wrinkles and tears and slips loose from the clamps.

TIP: Apply spray adhesive to the back of the sandpaper. When it dries, you'll have sticky sandpaper that won't slide around on the sander pad, yet will be easy to remove. To save time, prepare the sheets in batches. Stack them interleaved with waxed paper to keep them from sticking together.

-Frank Pellicone, North East, Md.



Continued on page 14

FREE

FALL 1993 CATALOG

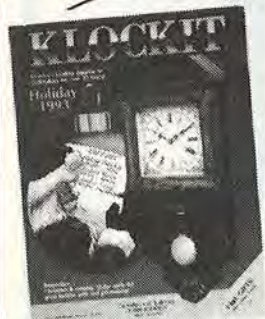

Discover the wonderful world of clockmaking. It's easy, fun... and clocks make sensational gifts.

Klockit's new FREE catalog has:

- Clock Kits, Clock Plans
- American Quartz Movements
- Mechanical Movements
- Quartz Clock Inserts
- Weather Instruments
- And Much More!

1-800-556-2548

Please rush my FREE Klockit catalog!

Name _____
Address _____
City _____ State _____ Zip _____

KLOCKIT

Dept. WD123
P.O. Box 542
Lake Geneva,
WI 53147-9961

PERFORMAX PRO-MAX III DRUM SANDER

\$1595
Mfg's
Sugg.
Retail
Price



Made in the U.S.A.

Sand pieces as wide as 44", as short as 2 1/4" and as thick as 4".
Clean-up glued panels.
Surface rough-sawn lumber.
Dimension highly-figured stock.
Finish sand the thinnest veneers.

A PRO-MAX III Will Exceed Your Expectations. See a demonstration at the dealer nearest you. Call for brochures on our complete line of drum sanders.

1-800-334-4910 or (612) 895-9922
or write: PERFORMAX PRODUCTS, WD02
12211 Woodlake Dr., Burnsville, MN 55337



The Professional Angle ... Milwaukee's New Magnum™ miter saw.

Precise ... Accurate ... PROFESSIONAL.

When accuracy counts, count on the NEW MILWAUKEE 10" MAGNUM miter saw.

Magnum's patented features include: a unique axis mechanism for accurate cutting; an override that locks table at any angle from 51° left - 59° right; an automatic retracting lower guard for visibility and large capacity cutting. Powered by a 15 amp motor, the MILWAUKEE miter saw slices cleanly through 4-1/4" vertical base molding and 4 x 4's at 90°. With an electric brake, spindle lock, built-in carrying handle, and a blade guard you can actually work with, Magnum is made for the professional.

Find Milwaukee Electric Tools at your local hardware retailer, or look in the Yellow Pages under Tools-Electric for the distributor nearest you.

Your satisfaction is guaranteed. If for any reason you're not satisfied with any product, return it within 30 days for a replacement or full refund.

★ **FREE!** ★
\$88 value premium,
80-tooth carbide-tipped
blade included with
every miter saw.
Limited time offer. While supplies last.

Milwaukee®

Professionals Serving Professionals
Excellence in Quality, Performance, Value

**MADE IN
USA**

MILWAUKEE ELECTRIC TOOL CORPORATION BROOKFIELD, WISCONSIN 53005

550-1442

TIPS FROM YOUR SHOP (AND OURS)

Continued from page 12

Sliding tabletop eases dado routing

Routing dados—grooves across the grain—poses several challenges, especially on narrow stock. Securing the workpiece, spacing the dados, and guiding the router straight over the stock become even more difficult on small workpieces.

TIP: A sliding top for your router table makes dado-routing a walk in the park. To build a sliding tabletop, start with a piece of $\frac{1}{8}$ "-thick tempered hardboard as wide as the front-to-back dimension of your router table and about 4" longer than the end-to-end distance. Attach a 1x2 guide bar across each end on the underside, locating them so the hardboard slides freely from front to back on the table without excessive side play. Chuck the straight bit for

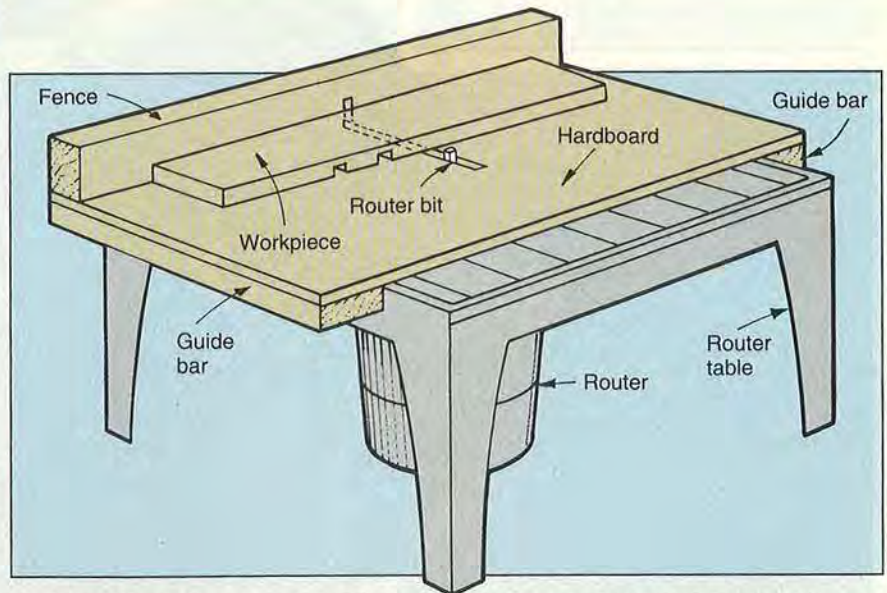

dadoing into the router, and push the hardboard sliding tabletop into it, cutting a slot about halfway across the hardboard. Notch a 1x2 fence to clear the bit, and then mount it at the back of the sliding top, perpendicular to the slot.

Now, to rout dados easily and accurately, hold the workpiece firmly against the fence and slide the tabletop across the bit. Add stopblocks or indexing blocks made of scrap wood to the fence for repetitive cuts.

— C. E. Ramefeld, Decatur, Ala.

There's never been a better time to cut yourself a deal.

Now when you buy a Dremel 1671 or 1695 Scroll Saw in specially marked packages, you get your choice of two great offers from Dremel.



Choose our pattern offer and get 96 free scroll saw patterns from *Wood* magazine plus a special subscription offer – a \$30 value. Or, for just \$14.95, you can receive our scroll saw stand/leg set – a \$58 value.

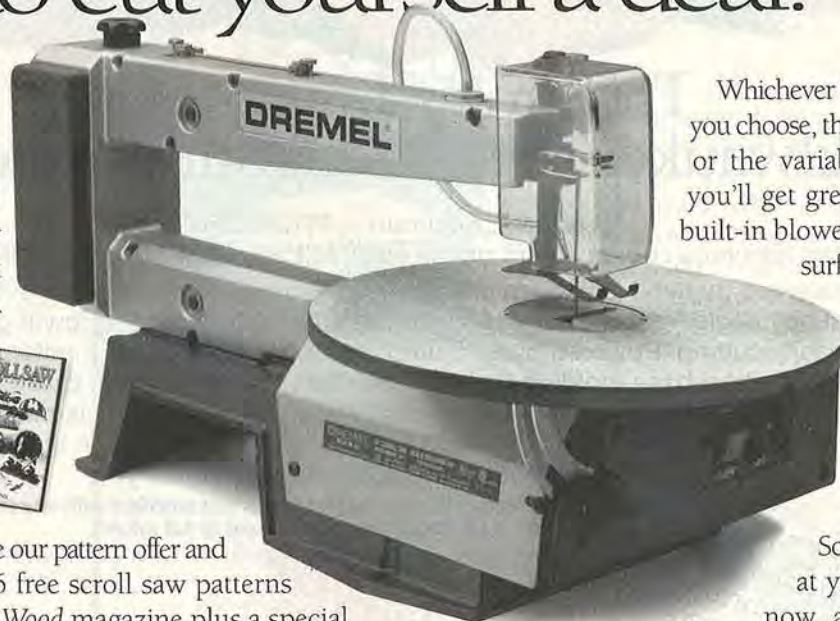

Whichever Dremel Scroll Saw you choose, the two-speed 1671 or the variable speed 1695, you'll get great features like a built-in blower to keep cutting surfaces clean, a large cast-aluminum table and heavy cast-iron base.

This is a limited time offer. So look for specially marked Dremel Scroll Saw packages at your local retailer now, and cut yourself a deal.

DREMEL®

Shorten axles easily with a simple saw jig

Shortening toy axle pegs doesn't seem like it should be a troublesome job—until you try to do it. You can't lay the axles on the saw table for a safe cut because of the mushroom-head end, and their small size makes them hard to hang on to.

TIP: Construct the simple jig shown in the drawing. (We show one for trimming two different

axle lengths or diameters; you could make a jig with only one notch if you work with only one size.) Slide the peg to be shortened into the appropriate hole, inserting it from the notched side of the jig. Then, holding the peg end against the inside of the notch, cut it flush to the end of the jig with a bandsaw, scrollsaw, or handsaw.

—David R. McClellan, Markham, Ont.

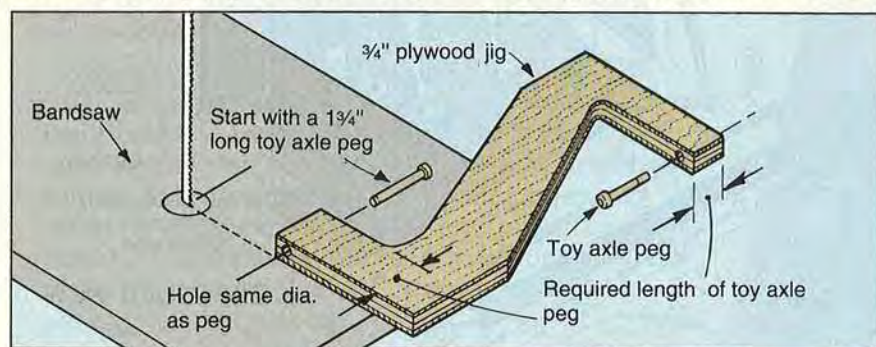

MORE TIPS FROM OUR WOODWORKING PROS

• Our heart-shaped emblem on page 48 will look great atop your favorite jewelry box or small project. Or, epoxy it to a stick pin and wear it as a piece of great fashion jewelry.

• Build our notched router table or fence on page 48. It's a guaranteed finger-saver when it comes to routing small-diameter discs and other itty bitsy parts that could put your fingers too close to the sharp, spinning bit.

• Looking for inexpensive backing for a project? Skip 1/4 inch plywood, and turn to economy tongue-and-groove knotty-pine plank paneling like that used on the plate rack on page 49. ♣

Here's your Christmas Bonus.

Over \$28 worth of additional sanding belts and discs free!

Now when you buy the Dremel 1731 combination Disc/Belt Sander in specially marked packages, you'll get a bonus of six extra belts and six extra discs included free.

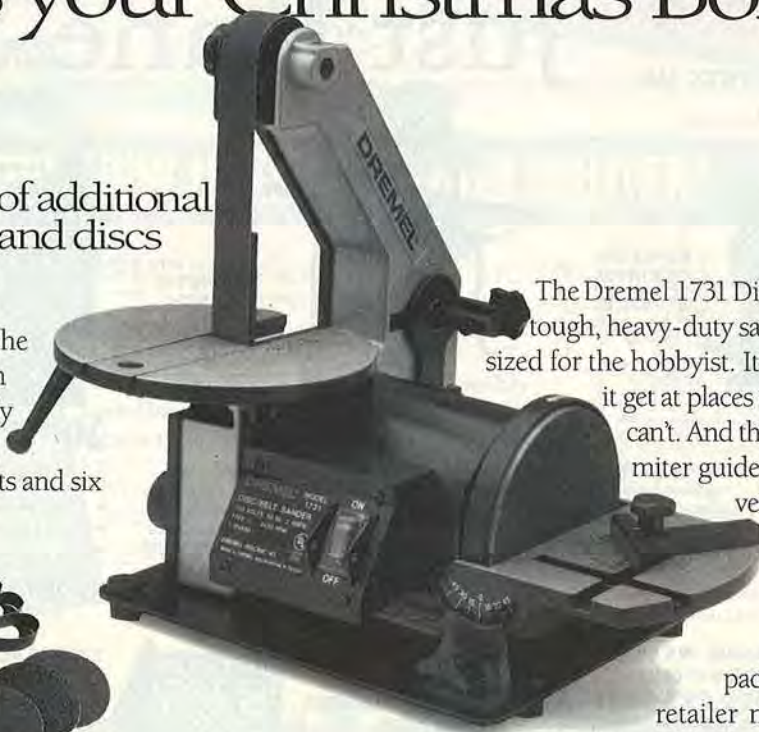

The Dremel 1731 Disc/Belt Sander is a tough, heavy-duty sander that's perfectly sized for the hobbyist. Its one-inch belt lets it get at places that a bigger sander can't. And the five-inch disc with miter guide offers even greater versatility.

Hurry, this is a limited time offer. So look for specially marked packages at your local retailer now. And pick up your Christmas bonus early.

DREMEL®



CUTOFF CATCHALL

Designed to hold cutoffs and other short pieces upright, this handy organizer allows you to see at a glance what stock you have available. And its wall-hugging profile takes good advantage of limited shop space.

Bill of Materials					
Part	Finished Size			Mtl.	Qty.
	T	W	L		
A	3/4"	14 1/2"	33"	P	5
B	3/4"	14 1/2"	48 3/4"	P	1
C	3/4"	33 3/4"	48 3/4"	P	1
D	3/4"	3 3/4"	48 3/4"	P	1
E	3/4"	3/4"	48 3/4"	B	2
F	3/4"	3/4"	31 1/2"	B	5
G	3/4"	3/4"	4 3/8"	B	5

Materials Key: P—plywood, B—birch

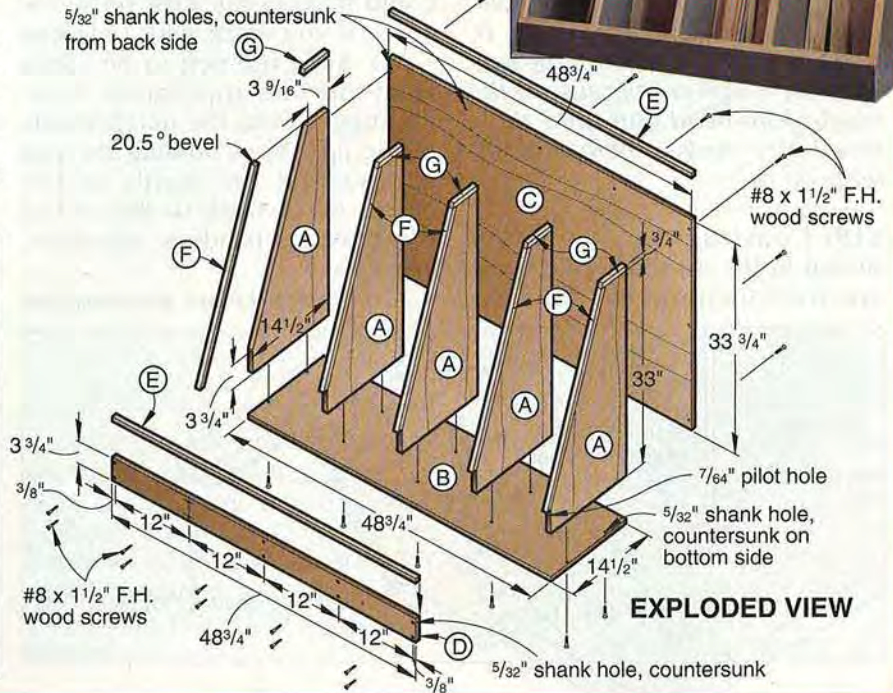

"Importer's of Fine Machinery"

Buying a Grizzly Planer is Just Plane Smart!



EXTRA SET OF KNIVES FREE

12" PLANER

- > 2 H.P. motor, 110V, 16 amps
- > 2 knife cutterhead, 8,000 RPM
- > All-ball bearing construction
- > 4 column support
- > Stainless steel bed
- > 12" maximum cutting width
- > 5 1/2" maximum cutting height
- > 1/4" maximum depth of cut
- > 1/4" minimum board thickness
- > Shipping Weight: 81 lbs.

MODEL G1017 ONLY \$395⁰⁰
F.O.B BELLINGHAM, WA OR WILLIAMSPORT, PA



COMPLETE WITH MAGNETIC SWITCH

15" PLANER

- > 2 H.P. motor, 220V, 10 amps
- > 3 knife cutterhead
- > All-ball bearing construction
- > 4 heavy-duty support columns
- > Adjustable bed rollers
- > Quiet powerful operation
- > Infeed / outfeed rollers
- > Shipping Weight: 500 lbs.

MODEL G1021 PACKAGE DEAL WITH STAND ONLY \$765⁰⁰
ONLY \$795⁰⁰
F.O.B BELLINGHAM, WA OR WILLIAMSPORT, PA



COMES WITH DUST EXHAUST HOOD

20" PLANER

- > 3 H.P. motor, 220V, 18 amps
- > 4 knife cutterhead, 5,000 RPM
- > All-ball bearing construction
- > 2 speed automatic feed
- > 26" x 20" Precision ground table
- > Magnetic switch
- > Minimum stock feed thickness is 1/4"
- > Adjustable bed rollers
- > Shipping Weight: 840 lbs.

MODEL G1033 ONLY \$1295⁰⁰
F.O.B BELLINGHAM, WA OR WILLIAMSPORT, PA

P.O. BOX 2069, BELLINGHAM, WA 98227
Customer Service: (206) 647-0801
FAX (Orders Only): 1-800-225-0021

IF YOU LIVE WEST OF THE MISSISSIPPI



IF YOU LIVE EAST OF THE MISSISSIPPI

2406 REACH RD., WILLIAMSPORT, PA 17701
Customer Service: (717) 326-3806
FAX (Orders Only): 1-800-438-5901

ORDERS: 1-800-541-5537

ORDERS: 1-800-523-4777

DISCOVER 507 CREATIVE NEW USES FOR YOUR ROUTER!

Astonishing router cuts you never thought you could do! NOW EASY!

Here are the private shortcuts and solutions from some of America's finest woodworkers.

Cover to cover, **WOODWORKING WITH THE ROUTER** is packed with proven, shop-tested tips and techniques . . . innovative solutions to common wood-working problems . . . name-brand buying advice on routers, bits, jigs and fixtures . . . money-saving alternatives to expensive new equipment or accessories . . . plans and detailed instructions for some of the most useful jigs and fixtures you'll ever lay your hands on.

Try it without cost or obligation for 21 days and you'll also receive *Successful Cabinets and Built-Ins* FREE. You'll discover the secrets to building heirloom-quality cabinets brought to you by master cabinet-makers!

TRIPLE the versatility of your router FREE FOR 21 DAYS!

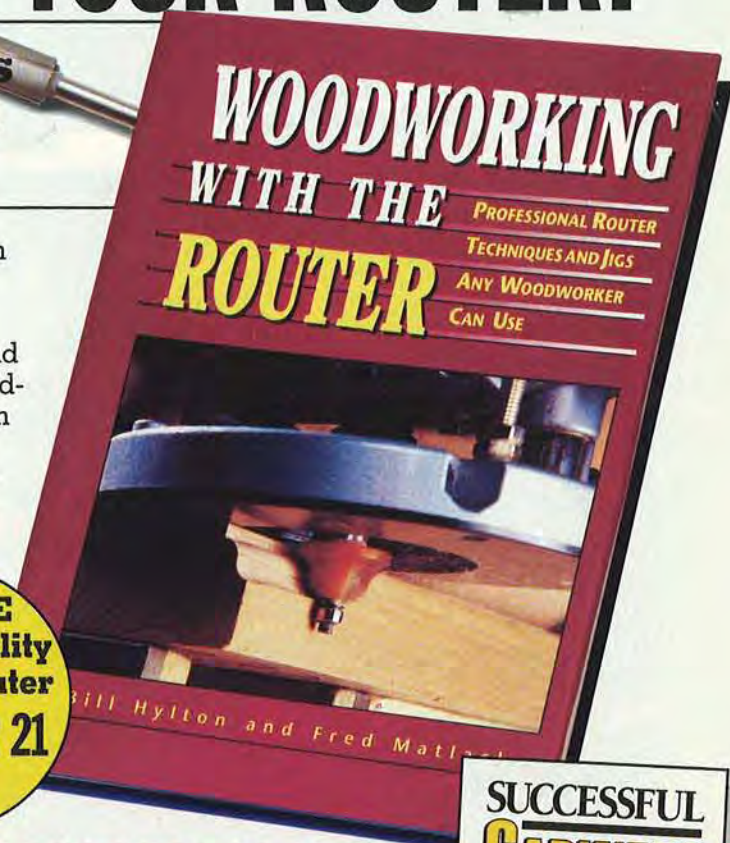

ALL NEW!

Over 300 Pages of ROUTING SECRETS THEY NEVER TELL YOU IN YOUR ROUTER'S INSTRUCTIONS!

- **SECRETS FOR SLIDING DOVETAILS.** They slide together flawlessly with the tricks on page 249.
- **THE INDEX CARD SECRET** for micro-adjusting your fence. Foolproof! Page 109.
- **JOINTING WITH A ROUTER.** Even if you own an expensive jointer, your router does a better job on these cuts! See page 158.
- **BEST BITS FOR DADOING AND GROOVING.** You must have these on hand. Page 191.
- **6 WAYS TO GUARANTEE YOU GET THE CUTTING DEPTH RIGHT THE FIRST TIME!** No more frustration and wasted wood. Details, page 4.
- **AND HUNDREDS MORE!**

RODALE



WOODWORKING BOOKS
Emmaus, PA 18098

Yours for 21 days— absolutely FREE!

YES! Send me **WOODWORKING WITH THE ROUTER** for 21 days absolutely free. If I choose to keep it, I'll pay **four monthly installments of just \$6.99 (\$7.99 CDN funds plus GST) each**, plus postage and handling. If I'm not happy with it for any reason, I'll return it within 21 days and owe nothing.

FREE CABINETRY BOOK!

SUCCESSFUL CABINETS & BUILT-INS

TECHNIQUES FOR Professional-Looking CABINETRY

FREE BONUS!

Successful Cabinets and Built-Ins is mine to keep no matter what!

- Mr.
 Mrs.
 Miss
 Ms.

40394

NAME (First) (Last)

ADDRESS APT. #

CITY STATE ZIP

SEND NO MONEY NOW. This is a FREE-TRIAL offer.

Clip and mail this coupon to: Rodale Woodworking Books,

14-796 Department Q, 33 East Minor St., Emmaus, PA 18098

SHOWROOM/MAIN OFFICE:

19400 E. SAN JOSE AVE.
CITY OF INDUSTRY, CA 91748
CUSTOMER SERVICE:
TEL: (909) 468-3688
FAX: (909) 468-3689
HOURS: P.T. MON.- SAT.
8:00 A.M. - 5:00 P.M.

ENLON™

IMPORT CORPORATION

The Power You Can Trust

22" SCROLL SAW

- 1/8 H.P., 110V
- Removable Safety Key Switch
- Built-In Dust Blower
- 5" Plain End Blades Included

MODEL EN-SC22 \$145

NEW

6" JOINTER

- 1 H.P., 110/220V, 47" Cast Iron Bed
- Sealed Ball-Bearings
- Built-In Dust Chute

MODEL EN3101 \$350

NEW

1-1/2 H.P. WOOD SHAPER

- 110/220V, 2 Spindle Speeds
- All Ball-Bearing Spindle
- 1/2" & 3/4" Spindles Included

MODEL EN3302 \$530

NEW

3 H.P. SLIDING TABLE WOOD SHAPER

- 220V, 2 Spindle Speeds
- Magnetic Safety Switch
- Accepts 1/4" & 1/2" Router Bit Collect
- 1/2", 3/4" & 1" Spindles Included

MODEL EN3304 \$890

FREE

1/2" Spindle W/ Purchase of EN-WS10

3 H.P. HEAVY DUTY WOOD SHAPER

- 220V, 2 Spindle Speeds
- Magnetic Safety Switch
- 3/4" & 1" Spindles Included

MODEL EN-WS10 \$845

1/2" WOOD SHAPER MODEL EN-WS05 \$265

NEW

12" SUPER HEAVY DUTY JOINTER

- 3 H.P., 220V, Magnetic Safety Switch
- Fully Adjust. In & Out Feed Tables
- Built-In Dust Chute, 72" Cast Iron Bed
- H. D. Cast Iron Center Mount Fence

MODEL EN3103 \$1,795

NEW

8" H. D. JOINTER

- 2 H.P., 110/220V, 65" Cast Iron Bed
- Fence Tilts 0° - 45°
- Built-In Dust Chute
- Magnetic Safety Switch

MODEL EN3102 \$645

FREE

4" X 10" P.V.C. Hose W/ Purchase Of Any Dust Collector

2 H.P. DUST COLLECTOR

- 110/220V, Bag Capacity 40 Gals.
- Will Handle 2 Machines
- All Steel Impeller
- Mobile Base Included

MODEL EN-DC20 \$290

1 H.P. DUST COLLECTOR

MODEL EN-DC10 \$180

3 H.P. DUST COLLECTOR

MODEL EN-DC30 \$450



ORDERS
1-800-888-9697
Pacific Time: Mon.- Sat. 7:00a.m. - 5:00p.m.

PRICES ARE SUBJECT TO CHANGE WITHOUT NOTICE.
*F.O.B. CITY OF INDUSTRY, CA OR CLARKSBURG, WV

NEW

16" UNIVERSAL KNIFE GRINDER

- 1/2 H.P., 110V, 6" Grinder Wheel
- Tool Rest Tilts 0° - 45°
- Cast Iron Base
- Sliding Table Included

MODEL EN-GR16 \$150

NEW

6"x 30" FLOOR STAND EDGE SANDER

- 1-1/2 H.P., 110/220V,
- Belt Tilts 0° - 90°
- Magnetic Safety Switch
- Built-In 4" Dust Collector Port

MODEL EN3406 \$470

24" UNIVERSAL KNIFE GRINDER

- 1/2 H.P., 110V, 6" Grinder Wheel
- Tool Rest Tilts 15° - 90°

MODEL EN-GR24 \$240

6"x 30" EDGE SANDER

- 1-1/2 H.P., 110/220V
- Table Tilts Both Ways To 45°

MODEL EN3405 \$420

NEW

16" BAND SAW

- 1-1/2 H.P., 110/220V, 3 Speeds
- Heavy Duty Cast Iron Body
- Sealed Ball-Bearing Const.
- Blade & Miter Gauge Included

MODEL EN-BS16 \$490

18" HEAVY DUTY BAND SAW

MODEL EN-BS18 \$860

14" BAND SAW

MODEL EN-BS14 \$280

18" H. D. BAND SAW

- 2 H.P., 110/220V., 3 Speeds
- Precision Ground Cast Iron Table
- Balanced Die Cast Aluminum Wheels
- Blade & Miter Gauge Included

MODEL EN-BS18S \$620

15" BAND SAW

MODEL EN-BS15 \$450

20" INDUSTRIAL BAND SAW

MODEL EN3506 \$1,230

Call For FREE Catalog Or Router Bits And Shaper Cutter Catalog.
FREE Baseball Cap With Any Purchase Over \$ 50

**SHOWROOM/
SHIPPING WAREHOUSE:**

12 ARMORY ROAD,
CLARKSBURG, WV 26301
HOURS: E.S.T. MON. - FRI.
8:00A.M. - 5:00P.M.

**12"
PLANER**

- 2 H.P., 110V
- Overload Protected
- Removable Safety Key Switch
- Sealed Ball-Bearing Const.

MODEL EN-PN12 \$355



**15"
PLANER**

- 3 H.P., 110/220V, 2 Feed Rates
- Sealed Ball-Bearing Const.
- Built-In Dust Chute
- Adjustable Table Rollers

MODEL EN-PN15 \$815



NEW

10" TABLE SAW

- 1-1/2 H.P., 110/220V
- Sealed Ball-Bearings On Arbor
- Precision Ground Cast Iron Table
- Miter Gauge & Dado Insert Included

MODEL EN-T810N \$335



**10" H. D. TILTING
ARBOR TABLE SAW**

- 3 H.P., 220V, Magnetic Safety Switch
- Heavy Duty Trunion, Cast Iron Table
- Built-In Inch & Metric Scale
- Heavy Duty Lever Lock Rip Fence Sys.

MODEL EN-47810 \$1,150

**10" TILTING
ARBOR TABLE SAW**

- 3 H.P., 220V, Magnetic Safety Switch
- Cast Iron Table & Extensions
- Triple V-Built Drive System
- Dado Insert & Miter Gauge Included

MODEL EN-3203 \$890



NEW



WOOD COPY LATHE

- 1/2 H.P., 110/220V., 3 Speeds
- Includes: Drum Sander, 8" Sanding Disc, Adjust. Work Table W/ Miter Gauge & 5 Pc. Chisel Set

MODEL EN-WL05 \$370



6" X 48" BELT/ 9" DISC SANDER

- 3/4 H.P., 110/220V
- All Ball-Bearing Motor & Rollers
- Belt Tilts 0° - 45°
- Sanding Belt & Disc Included

MODEL EN-SN69 \$185

1" X 42" BELT/ 8" DISC SANDER

MODEL EN-SN18 \$105

WOOD TURNING LATHE

MODEL EN-WL01 \$145

4" X 36" BELT/ 6" DISC SANDER

MODEL EN-SN46 \$115

HEAVY DUTY WOOD LATHE

MODEL EN-WL10 \$625

1" X 30" BELT SANDER

MODEL EN-SN130 \$60

ASK WOOD

Print this article

Whether your woodworker's license reads "Beginner," "Intermediate," or "Advanced," you're bound to have a few questions about your favorite hobby. We can help by consulting our staff and outside experts. Send questions to:

Ask WOOD
Better Homes and Gardens®
WOOD® Magazine
1912 Grand Ave.
Des Moines, IA 50309-3379

Check those cracks!

What can be done to slow or stop the cracking that happens at the ends of tree limbs and trunks I harvest? I have tried coating the log ends with a variety of products and have not had good results.

—Charles Schultz, Orlando

Charles, you are seeing the results of uneven drying of the log. The sapwood, or the outer 1 1/2 to 2" of the log, shrinks much faster than the heartwood or center of the log while drying. This results in a stress build-up that leads to cracking.

Keep these things in mind when drying a log:

1) Use logs and limbs under 6" in diameter when drying wood in the round. The larger the diameter of the log, the greater the resulting build-up of stress.

2) Logs dry fastest at the ends, with the drying process slowing as it moves toward the center of the section. Plan your cuts on the log to allow 6 to 8" of waste wood at each end of the piece you wish to use.

3) Different types of wood will dry at different rates. Harder and denser woods, such as beech, hickory

and some oaks, are more likely to crack while drying. For more information, look at shrinkage tables in books like *The Encyclopedia of Wood* (Sterling Publications, 1989) or *Understanding Wood* by R. Bruce Hoadley (Taunton Press, 1980).

4) Use a chainsaw, or wedges and maul, to split the logs into halves or quarters. Then remove the pith or very center of the wood with a wedge or froe. This will allow these pieces to dry with less cracking. Coat the end grain with paraffin or a commercial sealer to slow the drying.

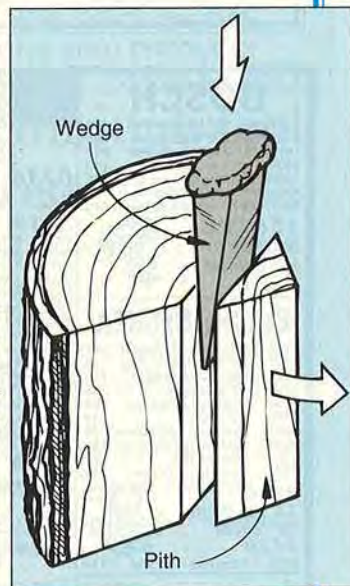

Continued on page 20

ASK WOOD

Continued from page 19

Moisture and wood, part II

Your articles frequently mention the need to purchase and work wood with a low moisture content. But what effect does prolonged storage of the wood have on moisture content?

— Brian Foreman, Eagen, Minn.

Brian, the moisture level in wood changes with the humidity level in the air around the wood. Kiln drying the wood does not stop this exchange and applying a finish will only slow it down.

Wood comes from the drying kiln with a moisture content of around six to eight percent. This low moisture content will change as the lumber adjusts to the surrounding atmosphere. Boards of the same type of wood will eventually reach an approximately equal, although constantly changing, level of moisture.

Stability in a wooden item does not refer to its not taking on moisture. Rather it refers to the separate pieces of wood taking on moisture evenly. For more stable finished work, buy your wood well ahead of building your project. Stack and sticker this lumber in your shop, allowing it several days to equalize in moisture content before using it.

Gluing ebony

What type of glue should I use on ebony?

—Pat Asquith, Cleveland, Tenn.



Pat, the answer to your question depends on how you intend to use the ebony. The experts at Franklin International recommend their Titebond brand yellow woodworker's glue for gluing ebony. Musical instrument makers often use hot hide glue for ease of repair and regluing. For inlay work, use epoxy or super (cyanoacrylate) glues.

Carefully fit the joint when gluing ebony. The density and hardness of this wood partially blocks the penetration of the glue, reducing the strength of the glue joint.

The joint should also be fresh, without dust, oils or dirt to interfere with the bond. Many dense tropical hardwoods, such as rosewood and cocobolo, have natural oils that interfere with the bonding of the wood and the glue. We recommend you clean the joint surfaces with lacquer thinner or acetone before gluing these woods. Officials from Franklin International will answer gluing questions on their technical support number: 800/877-4583.

Continued on page 22

if you can plug it in...we've got it!

GREAT BARGAINS ON ALL YOUR FAVORITE TOOLS

BOSCH

1194VSR	1/2" Hammer Drill	\$144
11212VSR	SDS Roto Hammer	194
1615EVS	3 hp Plunge Router	257
1604	1 3/4 hp Router	133
1609K	3 base Trimmer Kit	173
3283DVS	5" R.O. Sander	95
3051VSRK	With 2 batteries	148

1581VS \$138 VS Orbital Jigsaw

BLACK&DECKER

1166	3/8" 0-2500 Holgun	\$62
1167	3/8" Drill w/Keyless Chuck	68
1180	3/8" 0-1200 Holgun	103
1703	10" Miter Saw	185
2038	0-4000 rpm Drywall gun	99
2670	1/2" Impact	139
2664K	Cyclone 9.6V Cordless	139
2665K	Cyclone 12V Cordless	159
2750	Mini Grinder	79
3338	ELU Plunge Router	253

2720 1.5 hp Router \$129

2721 1.5 hp Router 1/2" collet 139

DELTA

37-070		\$249
--------	--	-------

6" Table Top Joiner \$144

11-950	6" bench Drill Press	\$144
14-600	Hollow Mortise Chisler	448
22-540	12" planer	398
28-180	10" band saw	169
31-050	1" belt sander	78
31-080	1" Belt 5" Disc Sander	94
32-100	Plate Joiner	269
33-060	Sidekick F&T Saw	368
36-040	8" Compound Miter	149
36-090	Sidekick 10" Miter Saw	218
36-220	10" Compound Miter	234
40-150	15" Scroll Saw	115
40-560	16" Scroll Saw	188
40-640	20" Scroll Saw	316

Milwaukee 0234-1 1/2" Magnum \$119

0222-1	3/8" Drill	\$106
0224-1	3/8" Magnum	114
0375-1	3/8" RA Drill	127
0379-1	1/2" RA Drill	145
3300-1	RA Magnum	183
5392-1	3/8" Hammer Drill	114
6368	7 1/4" Circ saw Kit	137
6527	VS Super Sawzall	164
6528	VS Super Sawzall	164
6546-1	2 spd. Cord Screwdriver	81
6583-1	HD ScrewShooter	145
6747-1	Drywall gun 0-2500	103
8977	VariableHeat Gun	74

DEGA 6508 2 range VS Sawzall \$132

SMARTLEVEL

SL224	2' economy Level	\$ 54
PR24S	2' Pro Level w/case	88
PR48S	4' Pro Level w/case	105

STABILA

LEVELS - Hand holes. Two vertical-vials. Two milled faces. Yellow coat.		
24	24"	\$ 36
2469	36"	39
2467	48"	45
2501	10" POCKET LEVEL	24
2699	6 ft -3vial	99
2700	6 ft 6" -3vial	115

LUFKIN 10 FT TAPE
ABBEY SPECIAL \$7.95-\$3.95

PORTER-CABLE 330 Palm Sander \$49

after \$10 rebate from Porter-Cable

100	7/8 hp Router	\$ 102
314	4-3/8" Trim Saw	135
315-1	7 1/4" Circular Saw	117
6"	Saw Boss	102
351	3x21 Belt Sander	144
352	3x21 Belt Sander w/bag	148
360	3x24 Belt Sander w/bag	184
361	3x24 Belt Sander	179
362	4x24 Belt Sander w/bag	189
363	4x24 Belt Sander	185
505	1/2 Sheet Sander	118
556	Beaut Joiner w/rod, fence	178
693	Plunge Router	169
6931	Plunge Base	76
696	Router Table	125
7310	Trim Router	88
7336	6" R.O. Sander	134
9118	Door Plane Kit	203
9345	6" SawBoss Kit	122
97310	Trimmer Kit	194
9840	New 9 V cordless	163
9853S	12V Cordless-2 batt	179
9879S	Router Edge Guides	14.95
Corner Chisel		17.95

690K W/ FREE CASE 145

1-1/2 hp Router

freud

94-100	5pc	\$158
--------	-----	-------

Router Bit Cabinet Set \$199

FT2000E Vs Plunge Router \$ 199
JS100 Blacuit Joiner 159
\$30 Rebate on these tools 11/12/93

LU85M010	10" 80T Finish	58
LU84M011	10" 50T Combo	39
LM72M010	10" 24T Rip	37

Emglo

AM78HC2	1 1/2 HP-1 tank	\$ 279
AM78HC4V	1 1/2 HP-2 tank	299

The Kreg Jig

Pockethole \$99 for joining face frames, butt joints and other pocket hole applications

HITACHI C8FB Compound Miter Saw \$599

Clamp for C8FB \$ 18.95
Small Piece Fence 12.95
60 Tooth Carbide Blade 39.95
C10FA 10" Miter Saw 299
C105VA Orbital Jigsaw Kit 155
TR6 Trim Router 89
M12VK 3 1/4hp PingFtr w/case 229
TR12K Plunge Router/case 179

NAIL GUNS

NR83A	Framing Gun	374
NT45A	18 g Finish Nailer	274
NT65A	16 g Finish Nailer	314
N2824A	1" Roofing Stapler	329

SENCO NAIL GUNS

not available in all areas

Pinner 5/8" - 1"	\$ 209	
SCN200R	Coil Roofing Nailer	399
SFN1	1" - 2" Finish Nailer	249
SFN2	Big Finish Nailer	349
SKS	1/4" Crown Stapler	239
SN70	NEW! Framing Nailer	467

SLP20 Pinner 5/8" - 1 5/8" \$242

Hook & Loop Sandpaper

PORTER/CABLE	5" discs 10 count	
BOSCH	5" discs 10 count	
MAKITA	5" discs 10 count	

All GRITS 10pc \$4.95

BIESEMEYER

T50	50' Commercial Fence	\$294
HS40	50' Home Shop	235
HS40	40' Home Shop	222
TABLE SAW INSERTS		9.95
MITER SAW STOP		69

TS380 15" Miter Saw \$369

AG1200V Heat Gun \$ 39
AP10 10" Planer \$ 379
AP10 Replacement Blades 24.95
OSS450 NEW! Spindle Sander 174
BE321 3x21 Sander 128
BT3000 Table Saw 539
DS1000 New! Detail Sander 49
JP155 6" Planer 299
JM100K Biscuit Joiner 209
QS1000 Quick Stand 49
RS0K Trimmer 2 base Special 99
R70K Trimmer 2 base Special 99
RE600 3hp Plunge Router 209
RS112 Random Orbit Sander 52
SC160 Scroll Saw 138
TFD170-2 9v Cord's Drill 2 batt. 148
TFD220-2 12v Cord's Drill-2 batt. 164
TS260 10" Comp. Miter 245

D81000 SANDPAPER

40,60,80,100, 150 Grit, Assorted 10 pieces...\$3.25

STIK-ON SANDPAPER

60	N/A	100 pc	19.95	15.95
80	10.95	100 pc	18.95	13.95
100	9.85	100 pc	17.95	12.95
120	9.85	100 pc	17.95	12.95
150	9.85	100 pc	17.95	12.95
180	9.85	100 pc	17.95	12.95
220	9.85	100 pc	17.95	12.95

DEWALT DW682K Biscuit Joiner \$225

DW100	3/8" 0-2500 Drill	64
DW102	3/8" 0-1200 Drill	59
DW250	0-4000 Screwgun	87
DW254	0-2500 Screwgun	87
DW357	7 1/4" Circular Saw	109
DW610	1-1/2 hp Router	145

TRIEGRIN

Clamp n Tool	Back-to-Back Bench Clamp
500	\$ 29.50
36C	26.50
24C	22.50
B850	\$ 45.95
B836	37.95
B818	31.95

PANASONIC

EY571B	9.6V Cordless Drill	\$ 119
EY571BC	with case	139
EY970B	9.6V battery	35

AIRY NAIL GUNS

2415K	18G Brad Nail Kit	119
350K	16G Brad Nail Kit	189
626SK	1 1/4" Crown Staple Kit	129

MAKITA

BO4510	Square Pad Sander	49
BO4530	Round Pad Sander	59
BO5000	Hand. Orbit Sander	66
LS 1030	10" Miter Saw	185
9.6 V Battery		24.50
7.2 V Battery		23.00
9.6 V Flashlight		39.00
3/8" Keyless Chuck		15.00

DUOFAST

CN350SH	Framing Nailer	339
---------	----------------	-----

AEG

EY102	4" Plane	\$79
EZ1320	Cord'rs Screwdriver Kit	89
STSE380	Jig Saw	69
VS280	1/2 sheet sander	49

SKIL

2735:08	12V Cordless-2 batt	129
77	7 1/4" Wormdrive Saw	139
77-72	Wormdrive	140

7 1/4 Blades Box of 25 \$49.50

DEWALT

DW100	3/8" 0-2500 Drill	64
DW102	3/8" 0-1200 Drill	59
DW250	0-4000 Screwgun	87
DW254	0-2500 Screwgun	87
DW357	7 1/4" Circular Saw	109
DW610	1-1/2 hp Router	145

USE VISA, MC, DISCOVER
FREE SHIPPING on orders from this add over \$50. Within continental 48 states, HI and AK extra. Sales limited to stock on hand.

ABBEY TOOLS

1-800-225-6321

1132 N. MAGNOLIA, ANAHEIM CA. 92801
OPEN 8-5:30 WEEKDAYS 9-2 SATURDAY
Calif. residents add 7.75% state sales tax
SERVING YOU FOR OVER 15 YEARS
Prices subject to change without notice

Two Brand New Kits
from the
Roudebush Company.



Replica IRISH MAIL HANDCAR measures 34"x16". Kit includes: 4 high impact red spoked polypropylene wheels with rubber tread, crank axle, front axle and bushings. \$59.00. TOY WAGON with miniature buckboard bench measures 40"x21". Kit includes: same wheels as above (2-11"x1 1/2", 2-8"x1 1/2"), steel hitch and under support and 2 axles. \$69.00. Both kits include complete hardware, instructions and shipping (UPS). Visa and MasterCard accepted.

The Roudebush Co.
Box 348A, Star City, Indiana 46985
800-847-4947

BEST CARVING SUPPLIES!



100s of quality hand & powercarving tools, books, kits, plus more. Fast friendly service, lowest price & satisfaction guaranteed. Join 100's of happy customers, send \$2 for our 76 pg. color catalog.

Wood Carvers Supply, Inc.
SERVING CARVERS SINCE 1955
P.O. Box 7500-G,
Englewood, FL 34295-7500

BUILD A FAU-1 CORSAIR PEDAL PLANE
FOR YOUR 4 TO 7 YEAR OLD PILOT



FEATURING,
Folding wings,
Tail wheel steering,
Detailed instrument panel,
Gun ports and Air / Oil intakes
Light weight plastic molded parts. Stainless steel and aluminum metal parts, and all wood parts made from quality Birch plywood are supplied in our factory construction kits. See catalog for details and kit prices.

Decals for both NAVY and MARINE livery available.
EASY to build from scratch, and quality finish will make your FAU CORSAIR jr. the envy of the flight line or neighborhood.
Send \$2 for our 18 page catalog of ride on and in pedal planes, pedal cars, hand launch gliders, & Hi-Tech Coaster Wagon, and or \$21.95 plus \$3.50 for P/H, (\$5 export) for FAU-1 CORSAIR jr. Full sized blueprints, patterns and photo assembly guide.
Wings & Wheels for kids of all ages
PO Box 1510 WM, Jacksonville, Oregon 97530 (503) 878-1473
FLASH-- P-51 and P-40 Blueprints will be available by 11-1-93

Heavy Glass
Table Tops

FACTORY DIRECT DISCOUNT PRICING



- Table Tops
- Shelves
- Doors
- Display Cases
- Entertainment Centers
- Tempered Glass

TABLE TOPS BY PHONE SATISFACTION GUARANTEED!

WGB GLASS ■ SHAPES ■ THICKNESSES ■ EDGE DESIGNS
FREE CATALOG - 1-800-288-6854

GLUE SPOT PROBLEMS?
SPOTLIGHT
exposes glue before stain
exposes it for you!

Mixed with white or yellow wood glue, SPOTLIGHT makes the glue visible when exposed to a fluorescent U-V light.



- 1/3oz. makes 1pt. \$300
- 2/3oz. makes 1qt. \$450
- 22/3oz. makes 1gal. \$600
- 18" U-V fluorescent light \$2700
- S&H for SPOTLIGHT and light \$800
- S&H for SPOTLIGHT only \$400
- PA res. add 6%

Questions? Call: 800-933-7963
P.O. Box 97
Carlisle, PA 17013
(Include no. & exp. date)

DON'T CUT PLYWOOD

WITHOUT THE
PLYMATE SAW GUIDE
use with circular saw

- A MUST FOR CARPENTERS, DO-IT-YOURSELFERS
- EXCELLEN AS A STRAIGHT EDGE FOR ROUTER
- QUICK, ACCURATE, SAFE
- MADE IN U.S.A.



\$24.95 for 4 ft. model
\$44.95 for 8 ft. model
for free literature or to place orders call
1-800-PLYMATE (759-6283)
OLIVE KNOT PRODUCTS
1409 North St. Corning, CA 96021

TRANSPOWER

FOR EXPRESS NEW CATALOGUE CALL
1-800-654-7702

TS200HD



HP500



SUPER HEAVY DUTY WOODWORKING EQUIPMENTS

200HD	10" SUPER HEAVY DUTY TABLE SAW, 3HP	\$895
200HA	10" SUPER HEAVY DUTY TABLE SAW, 3HP	\$740
MS250	10" TABLE SAW, 1 1/2HP	\$345
SB800	20" BAND SAW, 3HP	\$1190
SB700	18" BAND SAW, 2HP	\$595
SB600	16" BAND SAW, 1 1/2HP	\$475
SB500	14" BAND SAW, 3/4HP	\$230
AP200A	20" AUTO PLANER, 2 SPEEDS, 3HP	\$1195
AP400	24" AUTO PLANER, 3 SPEEDS, 7HP	\$2590
AP650	15"X8" AUTO PLANER, 2 SPEEDS, 2HP	\$695
AP800	16"X8" AUTO PLANER, 2 SPEEDS, 3HP	\$695
AP150	12"X6" AUTO PLANER, 2HP	\$328
SP980	TILTING SPINDLE SHAPER, 1 1/4" & 3/4", 3HP	\$1250
HP500L	3HP SHAPER, 1" 3/4" 1/2" SPINDLES	\$740
HP500	3HP SHAPER, 1" 3/4" 1/2" SPINDLES	\$695
SP980	3HP SHAPER, 1" 3/4" 1/2" SPINDLES	\$840
JT650	6" LONG BED JOINTER, 1HP	\$250
JT880	8" HEAVY DUTY JOINTER, 1 1/2HP	\$650
1200	12" HEAVY DUTY JOINTER, 3HP	\$1695
747	DUST COLLECTOR, 650 CFM, 1HP	\$168
2000	DUST COLLECTOR, 1250 CFM, 2HP	\$285
3000	DUST COLLECTOR, 1850 CFM, 3HP	\$325
RF150	AUTO FEEDER, 1/4HP	\$385
RF250	AUTO FEEDER, 1HP	\$640
SD800	90" EDGE SANDER, 2HP	\$420
SD1200	123" EDGE SANDER, 2HP	\$980
DB600	AIR DRUM SANDER, 1 HP	\$285
 AND MORE.	

Another breakthrough tool only from Garrett Wade...

With 224 pages, our Free Catalog is probably the biggest in the business. We think it's the best, too.

We have the woodworking supplies and tools that you just can't find in your local hardware store anymore. Everything from traditional old-style hand planes and saws to the very latest in power tools and accessories.

We've got Measuring tools, Chisels, Carving tools, Turning tools, Sharpening tools, and much, much more. Plus half a dozen kinds of glue to hold your work together, 70 stains to color it, and 20 different top coats to protect it.

Just send us the coupon below or call toll-free for your free 1994 Garrett Wade Catalog - plus free supplements throughout the year. It could be just the tool your workshop needs.

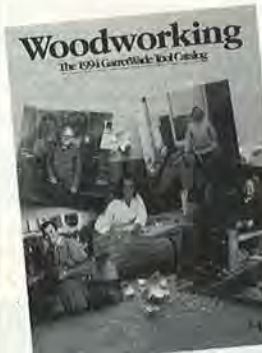

Our free 1994 Catalog.

Garrett Wade Co., Inc.
161 Avenue of the Americas
New York, NY 10013, Dept. 913
800-221-2942



Name _____
Address _____
City _____ State _____ Zip _____

Like Having A Lumberyard Right in Your Shop!



**NOW! Plane,
Mold, Sand
& Saw...
with
Infinitely
Variable
Power-Feed!**

Put this versatile power-feed tool to work in your own shop. See how fast it pays for itself! Quickly converts low-cost rough lumber into valuable finished stock, quarter-round, casing, base mold, tongue & groove... all popular patterns... even custom designs!

NEW! Variable Feed Rate

Now, just a twist of the dial adjusts your planer from 70 to over 1000 cuts-per-inch! Produces a glass-smooth finish on tricky grain patterns no other planer can handle. Converts to Drum Sander or Gang Rip Saw in under five minutes.

**FREE
FACTS! 1-800-821-6651, ext. PW66**

Woodmaster Tools, Inc., Dept. PW66
1431 N. Topping Ave., Kansas City, MO 64120

Econ-Abrasives

WE MAKE ABRASIVE BELTS ANY SIZE, ANY GRIT!

Standard Abrasive Sheets

CABINET PAPER

	50/pk	100/pk
60D	\$15.00	\$27.00C
80D	14.00	25.00C
100 thru 150C	13.00	23.00C

FINISHING PAPER

80A	\$ 10.00	\$17.00C
100 thru 280A	9.00	15.00C

NO LOAD PAPER(white)

100 thru 400A	\$11.00	\$19.00C
---------------	---------	----------

C = 100 SHEETS

Velcro® Vacuum Discs

8 Hole pattern for Bosch sanders

Dia.	Grit	Price
5"	60	\$.48ea
5"	80	.46
5"	100 thru 320	.45

* OTHER PRODUCTS *

- *Wide Belts*Rolls*Flap Wheels
- *Pump Sleeves*PSA Discs
- *Router & Wood Bits*Wood Glue

- *MasterCard, VISA, C.O.D. or Check
- *SATISFACTION GUARANTEED!!!
- *CALL FOR FREE CATALOG
- TX & NV add appropriate sales tax
- Continental U. S. shipping add \$5.50

ABRASIVE BELTS

PLEASE SPECIFY GRITS

1X30	\$.73 ea	3X24	\$.84ea
1X42	.73 ea	3X27	.87ea
1X44	.73 ea	4X21 3/4	.96ea
2 1/2X16	.77 ea	4X24	.99ea
3X18	.78 ea	4X36	1.20ea
3X21	.81 ea	6X48	3.14ea
3X23 3/4	.84 ea	2 1/4X80	2.94ea

OTHER SIZES ON REQUEST

HEAVY DUTY SPRING CLAMPS

Clamps come w/PVC tips and grips.

Size	Price
4"	\$1.75 ea
6"	2.25
8"	3.50

JUMBO ROUTER PAD(24" x 36")

It will not allow small blocks of wood to slip out under router or sanding applications. ROUTER PAD ONLY \$8.95ea.

**JUMBO BELT CLEANING STICK
ONLY \$8.80**

Econ-Abrasives



P. O. Box B865021
Plano, TX 75086
(214)377-9779

ASK WOOD

Continued from page 20

Looking for jewelry-box hardware

I've been building small chests and am unable to find suitable hardware such as hinges and drawer pulls. These chests vary from jewelry boxes to decorative storage chests. Could you help me locate the hardware?

—George Lindenberger,
Norwood, Ma.



Several catalogs and many woodworking stores sell such hardware. In particular, Garrett Wade offers a catalog called "Classic Hardware." There, you'll find an attractive selection of quality brass hardware for all cabinetry projects. The catalog costs \$3, or \$1 with a tool order. Order the publication by calling 800/221-2942.

Also, Lee Valley—a Canadian firm—has a fine selection of small box hardware. Write them at P.O. Box 6295, Station J, Ottawa, Ont. K2A 1T4. Or call 800/461-5053 from anywhere in the U.S. All other calls, 613/596-0350.

Higher prices has him searching for cheaper plywood substitutes

With lumber prices going through the roof, I've been wondering about the differences between OSB (Oriented Strand Board, or waferboard) and A-C plywood, and particleboard. When subjected to heat change, humidity change, and wetting and drying, do they respond much differently? Since particleboard and OSB are cheaper than plywood, I thought I'd ask.

—Scott Ladd, Penobscot, Maine.

You've brought up some good questions, Scott. We asked Dobbin McNatt, technologist at the Forest Product Laboratory, Madison, Wisconsin for his expert opinion. "A-C plywood is an exterior grade plywood while OSB primarily goes into flooring and sheathing and is not exterior grade," says McNatt. "OSB is more compressed and heavier than plywood but does not stand up to wet weather."

If you are looking for cheaper construction materials for woodworking projects, McNatt suggests that you consider Medium Density Fiberboard or particleboard. Both products hold a tight edge, and have uniform density with a hard surface. You can cover them with veneer or veneer plywood and they have good milling qualities. Plus, they're cheaper and much heavier than plywood.

Your lumberyard should have information on the various grades and performance abilities of fiberboard, particleboard, and plywood. Ask them about the specific products they carry. 🌲

TOLL-FREE ORDERING LINE (800) 367-4101

**WE'VE GOT
A DEAL
FOR YOU...
AND IT'S WORTH
100 BIG ONES!**

**JET is offering rebates
of up to \$100!**

Why buy JET? Because up to 100 big ones can be yours when you buy JET's most popular woodworking tools between September 15, 1993 and February 28, 1994. So, get your mug into your local JET dealer, make your purchase, and pick up a rebate coupon.

Don't wait; me and the boys think this is a great deal you shouldn't refuse.

For the name of the JET dealer nearest you, or for more information, call 1-800-274-6848 between 7 AM and 4 PM Pacific Time.

**JET'S
GOT
IT!**



WBS 14CS
Closed Stand or
WBS 140S
Open Stand
Bandsaw
\$25 Rebate
WBS 14MW
3 Speed Bandsaw
\$35 Rebate



JWL 1236
Woodworking Lathe
\$25
Rebate

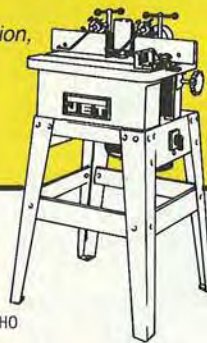

JWS 18HO
Shaper
\$25
Rebate



JJ 6CS
Jointer
\$25
Rebate

JDP 17MF
Drill Press
\$25
Rebate



DC 1200
Dust Collector
\$25
Rebate

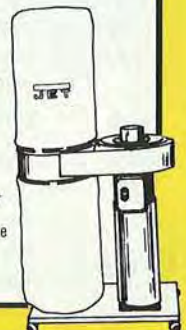

DC 650
Dust Collector
\$15
Rebate



JTS 10JF
Tablesaw
\$25
Rebate

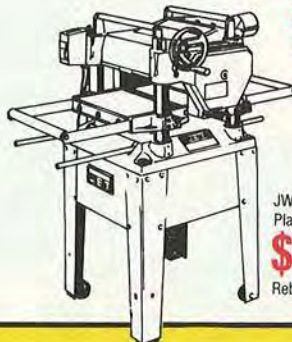

JWP 15HO
Planer
\$100
Rebate

Find out how good the NEW JET really is!

MAKE BEAUTIFUL RAISED PANEL DOORS WITH YOUR . . . 1/4" or 1/2" ROUTER . . . 1/2" or 3/4" SHAPER

Professional production quality bit makes it quick and easy to produce matching rails and stiles — the panel raising bit with ball bearing guide makes the raised panel perfect every time.

SALE PRICE **\$69.95** Regular value over \$150.00!

FOR COMPLETE SET **1/4" Shank set item #554 (includes both bits shown)**

SET ALSO AVAILABLE IN 1/2" SHANK - \$79.95 - Item #852

Shaper Cutters set: Item #1059
SAVE! only \$99.95
Set: Rail & Stile & Raised Panel Cutters

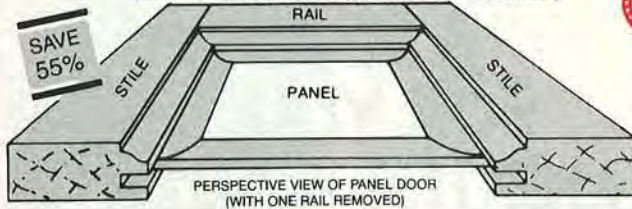

RAISED PANEL BIT
SUPPLIED WITH BALL BEARING
2" Large Diameter

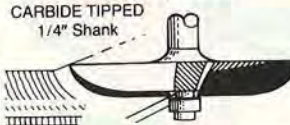

REVERSIBLE COMBINATION RAIL AND STILE BIT

(For making matching rails and stiles in raised panel doors, etc.) Works with stock from 11/16" to 7/8" thick

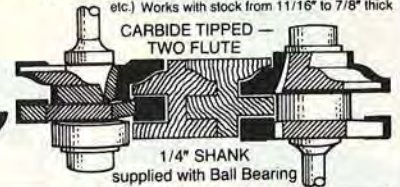

CARBIDE TIPPED ROUTER BITS • PROFESSIONAL PRODUCTION QUALITY GUARANTEED WHEN ORDERING ANY THREE OR MORE DEDUCT \$1.00 EACH. • FREE SHIPPING IN CONTINENTAL U.S.

ITEM NO.	BEST CUT BEST PRICE	DESCRIPTION	ANGLE/DEPTH/RADIUS CIRCLE DIAMETER	LARGE DIA.	CUTTING LENGTH	SHANK SIZE	PRICE
#601	Solid Carbide	1/8" Spiral Cutter		1/8"	1/2"	1/4"	\$ 9.00
#603		1/4" Spiral Cutter		1/4"	3/4"	1/4"	\$12.00
#903		1/4" Spiral Cutter		1/4"	3/4"	1/2"	\$12.00
#904		3/8" Spiral Cutter		3/8"	1"	1/2"	\$24.00
#905		1/2" Spiral Cutter		1/2"	1 1/2"	1/2"	\$29.00
#530		3/16" Edge Beading	3/16" Dia. of Circle		1/2"	1/4"	\$15.00
#531		5/16" Edge Beading	5/16" Dia. of Circle		1/2"	1/4"	\$15.50
#350		1/8" Round Over	1/8" R	3/4"	3/8"	1/4"	\$11.00
#351		3/16" Round Over	3/16" R	7/8"	1/2"	1/4"	\$11.00
#230		1/4" Round Over	1/4" R	1"	1/2"	1/4"	\$12.00
#353		5/16" Round Over	5/16" R	1 1/8"	1/2"	1/4"	\$14.00
#209		3/8" Round Over	3/8" R	1 1/4"	5/8"	1/4"	\$15.00
#355		1/2" Round Over	1/2" R	1 1/2"	3/4"	1/4"	\$17.00
#655		1/2" Round Over	1/2" R	1 1/2"	3/4"	1/2"	\$17.00
#656		3/4" Round Over	3/4" R	2"	7/8"	1/2"	\$21.00
#199		Multiform Moulding	Unlimited Patterns	2 1/4"	2"	1/2"	\$40.00
#205		1/4" Cove	1/4" R	1"	1/2"	1/4"	\$12.00
#206		3/8" Cove	3/8" R	1 1/4"	9/16"	1/4"	\$13.00
#207		1/2" Cove	1/2" R	1 1/2"	5/8"	1/4"	\$14.00
#643		1/2" Cove	1/2" R	1 1/2"	5/8"	1/2"	\$15.00
#208		3/4" Cove	3/4" R	1 3/8"	3/4"	1/2"	\$26.00
#231		5/32" Roman Ogee	5/32" R	1 1/4"	15/32"	1/4"	\$16.00
#232		1/4" Roman Ogee	1/4" R	1 1/2"	3/4"	1/4"	\$17.00
#506		1/2" Pattern	Flush Trim	1/2"	1"	1/4"	\$15.00
#508		3/4" Pattern	Flush Trim	3/4"	1"	1/4"	\$17.00
#366		1/8" Slot Cutter	3/8" Deep	1 1/4"	1/8"	1/4"	\$14.00
#368		1/4" Slot Cutter	3/8" Deep	1 1/4"	1/4"	1/4"	\$14.00
#204		3/8" Rabbeting	3/8" Deep	1 1/4"	1/2"	1/4"	\$13.00
#670		3/8" Rabbeting	3/8" Deep	1 1/4"	1/2"	1/2"	\$14.00

ITEM NO.	BEST CUT BEST PRICE	DESCRIPTION	ANGLE/DEPTH/RADIUS CIRCLE DIAMETER	LARGE DIA.	CUTTING LENGTH	SHANK SIZE	PRICE
#211		3/8" Core Box	round nose	3/8"	3/8"	1/4"	\$10.00
#212		1/2" Core Box	round nose	1/2"	1 1/32"	1/4"	\$13.00
#418		3/4" Core Box	round nose	3/4"	5/8"	1/4"	\$15.00
#213		1" Core Box	round nose	1"	3/4"	1/2"	\$17.00
#548		Lockmitre		2"	7/8"	1/4"	\$32.00
#214		1/4" Straight	plunge cutting	1/4"	3/4"	1/4"	\$ 6.50
#216		3/8" Straight	plunge cutting	3/8"	1"	1/4"	\$ 6.50
#474		1/2" Straight	plunge cutting	1/2"	1"	1/4"	\$ 7.00
#219		3/4" Straight	plunge cutting	3/4"	1"	1/4"	\$ 9.50
#779		3/4" Straight	plunge cutting	3/4"	1 1/2"	1/2"	\$10.00
#462		1/2" Bull Nose	1/2" Dia. of Circle		3/4"	1/4"	\$16.00
#464		3/4" Bull Nose	3/4" Dia. of Circle		1"	1/4"	\$21.00
#764		3/4" Bull Nose	3/4" Dia. of Circle		1"	1/2"	\$21.00
#545		Tongue & Groove	Straight	1 5/8"	1"	1/4"	\$29.00
#845		Tongue & Groove	Straight	1 5/8"	1"	1/2"	\$29.00
#546		Tongue & Groove	Wedge	1 3/16"	1"	1/4"	\$29.00
#846		Tongue & Groove	Wedge	1 5/8"	1"	1/2"	\$29.00
#450		1/8" Beading	1/8" R	3/4"	3/8"	1/4"	\$11.00
#233		1/4" Beading	1/4" R	1"	1/2"	1/4"	\$13.00
#454		3/8" Beading	3/8" R	1 1/4"	5/8"	1/4"	\$15.50
#455		1/2" Beading	1/2" R	1 1/2"	3/4"	1/4"	\$17.00
#500		3/8" Flush	Trimming	3/8"	1/2"	1/4"	\$ 7.00
#501		3/8" Flush	Trimming	3/8"	1"	1/4"	\$ 7.50
#503		1/2" Flush	Trimming	1/2"	1"	1/4"	\$ 8.50
#221		1/2" Flush	Trimming	1/2"	1 3/16"	1/2"	\$ 8.00
#558		Thumbnail		1 3/16"	3/8"	1/4"	\$18.50
#858	Thumbnail		2 1/2"	3/4"	1/2"	\$35.00	
#579		Molding Plane		1 1/8"	1 3/4"	1/4"	\$31.95
#879		Molding Plane		1 1/8"	1 3/4"	1/2"	\$31.95

FREE — NEW 32-PAGE CATALOGUE • While in the Philadelphia Area Visit Our Fully Stocked Showroom (call for easy directions)

CONTROL THE SPEED OF YOUR ROUTER

ROUT AT THE SPEED THAT GIVES THE BEST RESULTS WITH THE WOOD AND BIT YOU ARE USING!



FEATURES:

- Works With All Routers 3/4 HP or less - 120V 15 Amp.
- Full Horsepower and Torque at All Speeds.
- Gives Your Router a Feature Only Available on Routers Costing Hundreds of Dollars!



~~\$39.95~~
SALE \$29.95
Order Item #197

FORSTNER BITS

For Perfect Holes

Forstner bits are designed to drill flat bottom or through holes cleanly in end grain, thin stock, veneers and regular stock. Comes with its own attractive wood box and includes the following sizes: 1/4", 3/8", 1/2", 5/8", 3/4", 7/8", 1", 1 1/8", 1 1/4", 1 3/8", 1 1/2", 1 5/8", 1 3/4", 1 7/8", 2", 2 1/8".



Regularly **Special Sale \$79.95**
\$99.95 16 Piece Set Order Set #314

©1993

To order by Master Charge, Visa, or Discover
Call Toll Free, 7 Day - 24 Hour Order Service

1-800-533-9298

or send check to: **MLCS Ltd.**
P.O. Box 4053 DU, Rydal, PA 19046

FROM THE BASE OF
COLORADO'S ROCKY MOUNTAINS,
JERRY PATRASSO SKILLFULLY CRAFTS

BANDSAW TO BEHOLD

 Print this article

BOXES

Jerry Patrasso grew up in the shadow of Chicago's Wrigley Field, home of the Cubs. The only wood he even remotely cared about then was the length of turned, straight-grained white ash that batters swung from their shoulders. Twenty-some years later, at age 41, his tastes have changed.

Now, in his Boulder, Colorado, workshop, Jerry creates expertly crafted boxes from a multitude of unusual, eye-catching woods. The fact is, these days Jerry can't get enough of wood—he's crazy about it.

Continued

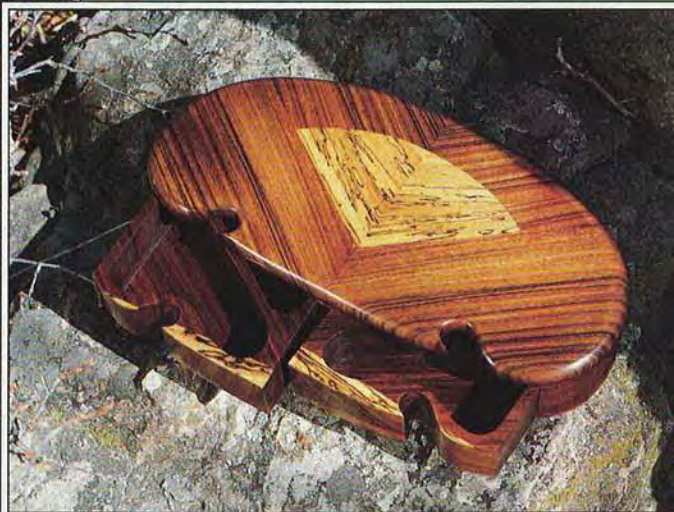
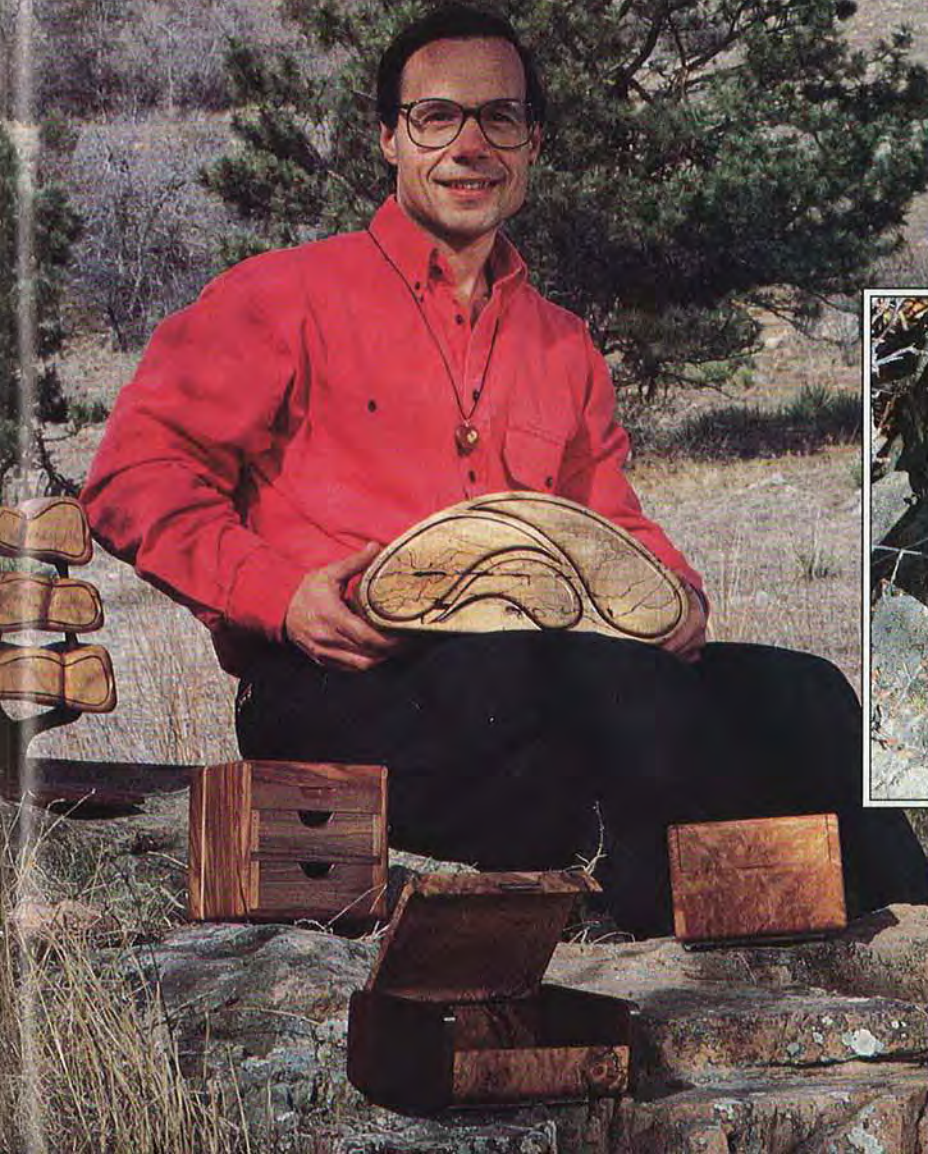

▲ Light spalted pecan matches up with amarillo's striking grain in this eye-catching example of Jerry's skill.

◀ At Sanitas Trailhead, a Boulder mountain park, Jerry Patrasso shows off his boxes in the setting that frequently inspires him.

BANDSAW BOXES

Natural treasures

"I remember, as a kid, having special containers where I kept my prized possessions, like baseball cards and ticket stubs from Cub's games," says Jerry. "Now, when I make a box, I think of it as the special place where the buyer will put treasured items. And that's why I use wood that's highly unordinary, to make the boxes extra special."

Jerry's design theory belies his true love of the material. "Boxes should be designed to emphasize the natural beauty of the material," he explains. "I want people to be attracted by the eyes in bird's-eye figure, the swirls in burl, or the beauty of evenly matched grain, not the cleverness of the box's cuts or any intricacies of drawers that I could put in."

▼ You'll see Jerry bandsawing this three-drawer tear-drop box to shape later in the article. Made of redwood lace burl, it sells for \$255.

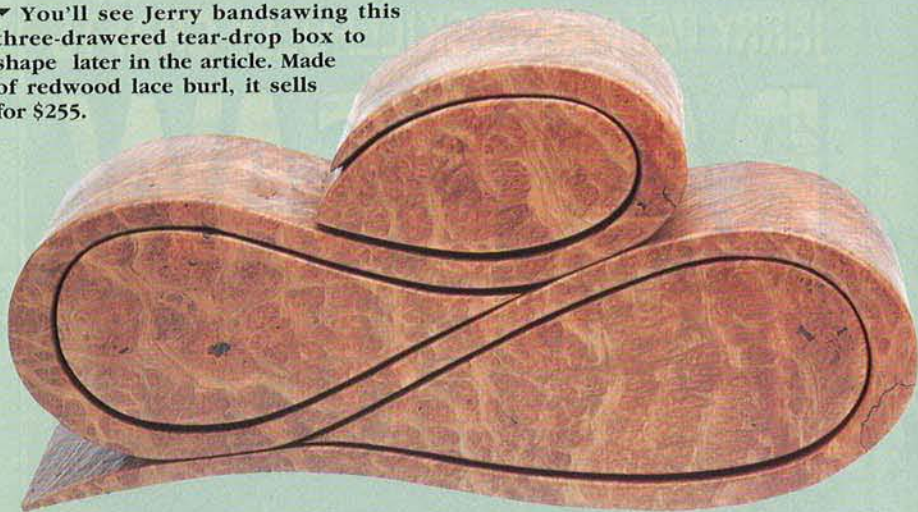

▼ Jerry's customers select from these woods, and more: 1. redwood lace burl 2. buckeye burl 3. bigleaf maple burl 4. amboyna burl 5. myrtle burl 6. manzanita burl 7. madrone burl 8. quilted bigleaf maple 9. white oak burl 10. ceanothus burl 11. cherry burl 12. spalted hard maple 13. curly walnut



And for the beholders of his boxes, there's plenty for the eyes to feast on. Spalted buckeye burl, a distinctive blue-gray, explodes with bursts of forsaken buds. Redwood lace burl entices with its intricate, doily-like pattern. Fiddleback claro walnut gleams in chocolate iridescence. (See the photograph *below* for these woods and more.)

But almost as fascinating as Jerry's wood is the story behind it. "I picked up the fiddleback claro walnut at a nut orchard near California's Silicone Valley," he recalls. "The owners were selling firewood, and it was in the pile. I dug through it, pulling out chunks I wanted while the people kept insisting I buy the whole cord."

Then, there's the awesome stack of buckeye root burl slices outside

next to his shop, as shown in the photo *right*. "These came from California, too, and cost me about \$500 in freight," he says of the 4'-diameter pieces. "The original burls were so huge that the logger blasted them out of the ground with dynamite!"

Jerry, it seems, finds wood wherever he goes, and he travels a lot, always with his eye out for wood. On a visit to his wife Beth's parents in Wisconsin, he discovered slabs of burlled white oak at a small local mill. During a trip to New Hampshire, he talked a woodturner out of 800 pounds of spalted maple, birch, and sycamore. In Oregon, he acquired quilted bigleaf maple that loggers had discarded in favor of straight-grained timber. So go the stories, wood to wood, state to state.

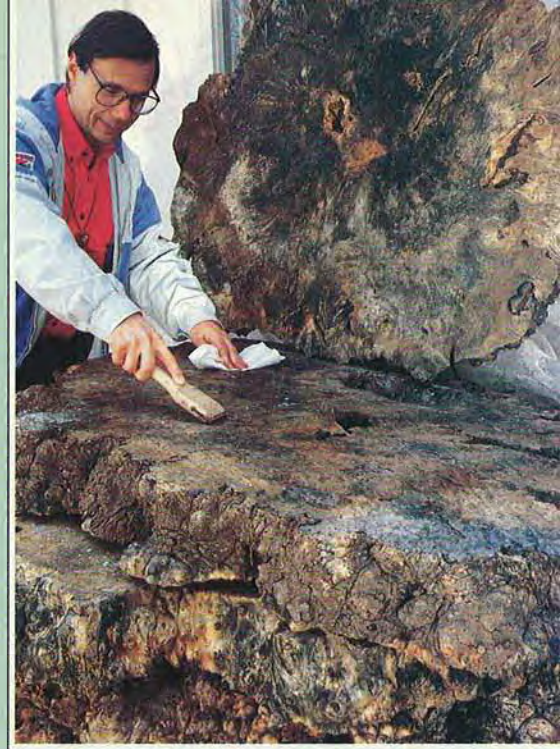

▲ These huge slices of buckeye root burl will eventually spalt to the gray color displayed in the foreground.

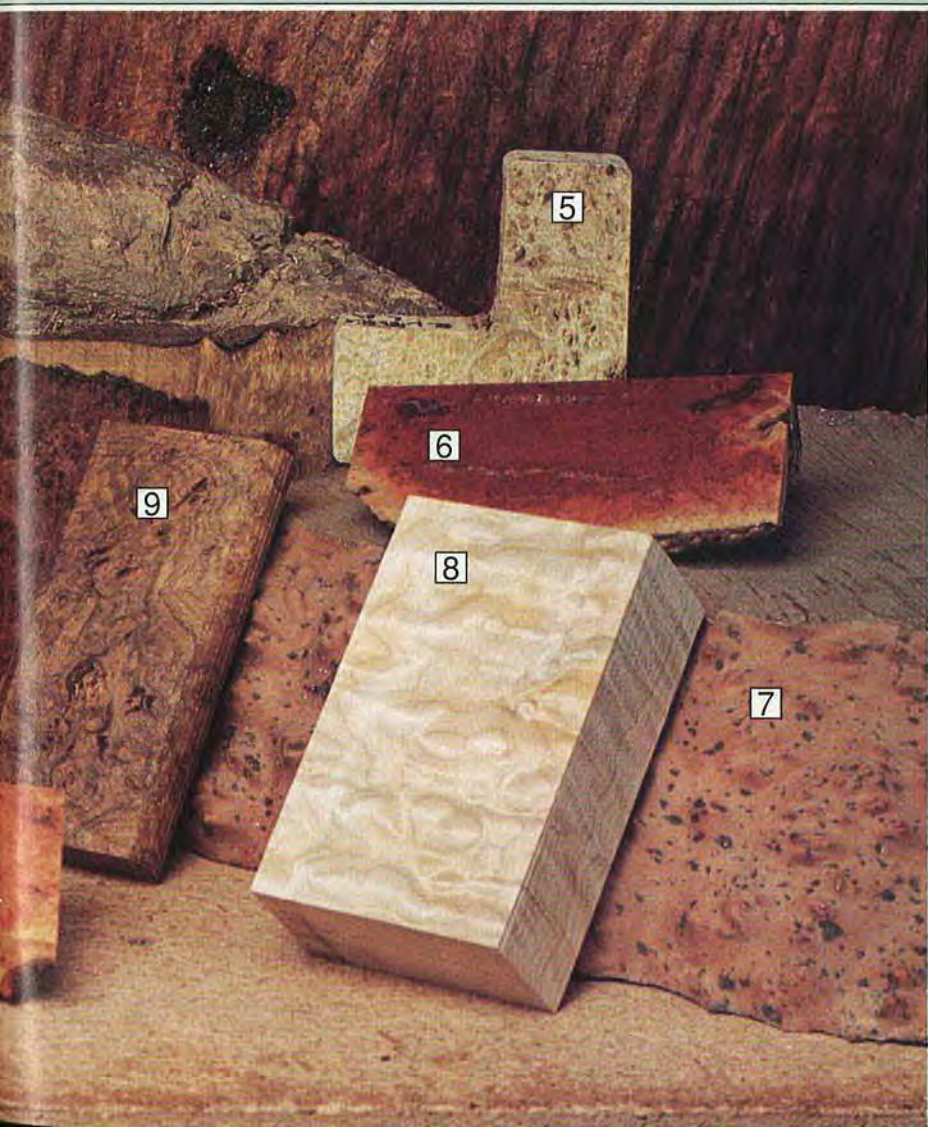

"I once relied pretty heavily on exotic woods for color and grain," Jerry comments. "But I've switched almost entirely to native American wood now, although none of it is run-of-the-mill. Customers really don't want to buy anything of wood that might have come from the rain forest."

The trade that paid: computers for sawdust

Jerry's bandsawn boxes reflect the thought, care, and craftsmanship that he puts into every one. It's hard to imagine that he at one time couldn't tell oak from maple or end grain from side grain. "I graduated from college with a degree in computer science, specializing in programming languages like Fortran," Jerry says. "Then I went to work for the State of Wisconsin. But it wasn't long before I realized that I was more a hands-on type person."

To find an outlet for his job frustration, Jerry signed up for woodworking in evening adult-education classes, and the choice suited him fine. Eventually, he went to work for a professional furniture-maker in Madison. "David Flatt was best at contemporary bent-

Continued

BANDSAW BOXES

wood furniture, but he had a line of bandsawn boxes, too," Jerry remembers. "After awhile, I took over the boxes." The rest, as they say, is history.

Eleven years ago Jerry and Beth set out on their own, arriving in Boulder with little more than determination. Beth, who has a library-science degree, got a job at the Boulder Public Library, where she still works as a research librarian. Jerry started making boxes.

"It hasn't been easy," Jerry says of his career change. But he'd be the last one to say that it hasn't been fun. "I like working by myself, and with the wood. In fact, I don't know what I could do that I'd like any better."

And to Jerry, Boulder is the perfect location. Here, he enjoys the beauty of the mountains as much as the wood he so skillfully works. "Growing up, I really never had much of a playground. Now I have the Rockies," he laughs.

Batches of boxes for Boulder

For years, Jerry's boxes went to galleries and shops in the East, north in Montana, and further west in California. Today, though, most make their way out of Boulder in the hands of customers. Surprisingly, that's because almost his entire annual output of 600 to 700 boxes is sold through the local arts and crafts co-op store.

"The Boulder Arts and Crafts Cooperative does great for me. It's right downtown in the high-traffic Pearl Street Mall," says Jerry. "We have over 60 members, but show work by about 100 Colorado arts and crafts people."

Jerry's boxes fall into two classes: production models and commissions. But by "production" models, Jerry isn't referring to assembly-line manufacture. Rather, he makes them in batches of eight to 10, roughing them out from

blocks all at one time, and then cutting the drawers, sanding, and finally finishing. Completed, the production boxes sell for \$26 to \$140, depending on size and type of wood. Commission boxes are another story.

"Commissions run up to about \$500, and the buyers select the wood and the way it's used," Jerry says. "Not everybody views wood exactly the same way."

Three sides to saw, and all to finish

"My bandsaw only has a 6" throat, so that limits one dimension of my boxes," comments Jerry regarding his sawing technique. "Still, I have the choice of making top cuts, side cuts, and face cuts, depending on which way I want to feature the wood's figure in the box's intended shape."

▼ Dark ends of amarillo add just enough accent to the box body made of burlled white oak from Wisconsin.



Jerry's boxes have elegantly simple lines. That, as he's said, makes the wood stand out. But simplicity also means that Jerry can make all his cuts with a 1/4" blade. "I don't own anything finer, because I don't have to make tight circles and intricate cuts," he notes. "But I do always try to maintain balanced wall thicknesses in scale with the box's body mass."

Unlike many boxmakers, Jerry shuns flocking the insides of his items. You guessed why: He likes people to see the wood, not cover



▲ The six-ply cotton buffing wheel on Jerry's bench grinder required a long custom spindle. For a high gloss on the finish, he charges the wheel with tripoli, a polishing compound, then follows with carnuaba wax.



▲ A believer in preventive medicine, Jerry wears eye protection and a respirator when sawing or sanding.

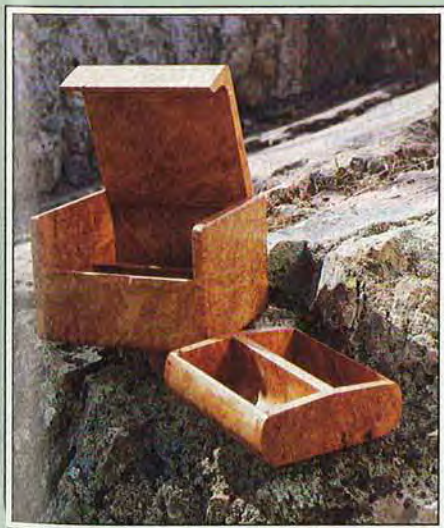

▲ Made of burl maple, this S-section lift-out tray box sells for \$95.

it up. You can also assume that that means extra sanding and finishing. Jerry doesn't mind. In fact, he's really set up for it.

For the gently rounded surfaces inside his boxes and their drawers, the craftsman smooths the wood with assorted spindle sanders he chucks into his drill press. And because he doesn't like even tiny unfinished areas, he hand-sands in the grooves.

For exterior contours, Jerry relies on a Sand-Rite inflatable drum sanding machine that he's also equipped with a flap sander. "I'm trying to get the absolute smoothest surface possible for the finish," Jerry notes. "That adds to the wood's appeal." And for the finish, Jerry has a special blend.

"Now, this is a production finish, not a French polish," he explains, smiling broadly. "If I could, I'd love to put three coats on, but I can't spend that much time, I'd have to raise prices! So, I use as thick a coat as I can without leaving marks from the paper-towel application. What I've found that works the best is six parts Flecto's Varathane Gloss Clear Finish mixed with two parts of a gloss polymerizing tung oil [Gillespie's

the brand], and about three-quarters of a part of mineral spirits. After applying it, I let it get tacky, then rub it down with a clean paper towel."

Jerry's finish mix gives the boxes the maximum possible gloss because he realizes that with wear the finish will dull to a more pleasing sheen. "And it does dull down," the craftsman says, his eyes twinkling. "My boxes become like the old 'worry stones.' People pick them up and handle them so much, I'm afraid someday they'll wear the finish right off!" ♣

Got a question for Jerry?

Jerry's a craftsman willing to help. In fact, he's advised other woodworkers on how to get started. If you have a question on working unusual wood, or about bandsaw-box making, write him (please enclose a self-addressed, stamped envelope):

Jerry Patrosso,
660 North St.,
Boulder, CO 80304.

Written by Peter J. Stephano
Photographs: Tim Murphy/Foto Imagery

WOODWORKING'S



Professional woodworkers and carpenters long have used air-powered nailers and staplers with good reason. Nothing else gives you faster, more accurate, or cleaner results when assembling or clamping workpieces. And in the past couple of years, imported guns costing less than \$150 have made this option affordable to most home woodworkers. Here's what you need to know to make a smart buy.

Around the *WOOD*® magazine shop, we use an air-powered brad nailer practically every day for chores such as attaching moldings, cleats, and cabinet backs, assembling craft projects, making jigs and fixtures, and fastening hard-to-clamp glued workpieces. With these guns, you can drive and countersink a fastener in the blink of an eye (try doing that with a hammer and nail set!).

In this article we'll concentrate on air-powered brad nailers since we feel most of you will get the greatest use from these tools. To give you a look at other options, we'll also examine air-powered staplers, as well as electric and cordless nailers and staplers.

Stapler or brad nailer: which one should you buy?

Although brads excel for most woodworking tasks, a stapler comes in handy for upholstery work, and some construction tasks such as installing insulation, sheathing, and lattice. In our tests we concentrated on guns that fire ¼"-wide narrow-crown staples. You can buy similar guns that fire ½"-wide crowns. The crown, or the portion of the staple that bridges its two points, provides holding power in thin materials.

But, the staple crown also leaves a large countersunk hole compared to a brad. This makes staples inappropriate for fastening visible surfaces such as moldings. As shown in the photo *right*, staples also have a greater tendency to split hardwoods.

Because staples have two points instead of the brad's one, they require twice as much driving force to reach the same depth. That's why the staplers in our test handle fasteners no longer than 1". To shoot longer staples you need to step up to large guns weighing about 6 pounds and costing upwards of \$300.

Imports vs. domestics: points to keep in mind

The popularity of air-powered fastening machines has zoomed

Continued

AIR-POWERED BRAD NAILERS

AIRY
ATK-0241



JET
JDPN-607.2



JET
JDPN-6018.2



WOODTEK
832-371



SURE SHOTS

Power brad nailers and staplers bring speed and convenience to your workshop

HOW AIR-POWERED FASTENING TOOLS WORK

When you squeeze the trigger of a pneumatic nailer or stapler, you set into motion a series of mechanical actions that take just a split second to complete. First, a rod connected to the trigger pushes a trigger-valve assembly upward, allowing a small amount of air to flow into the head valve as shown at right. This valve opens to let a larger volume of pressurized air rush into the cylinder, driving the piston and drive blade downward. The drive blade forces a fastener into your workpiece. When you release the trigger, air flows into the cylinder through holes near its base to drive the piston upward, completing its stroke. Then, the fastener magazine pushes another fastener into position under the drive blade. Finally, the exhaust air escapes out of the gun's top through the exhaust deflector.

ANATOMY OF AN AIR-POWERED FASTENING TOOL

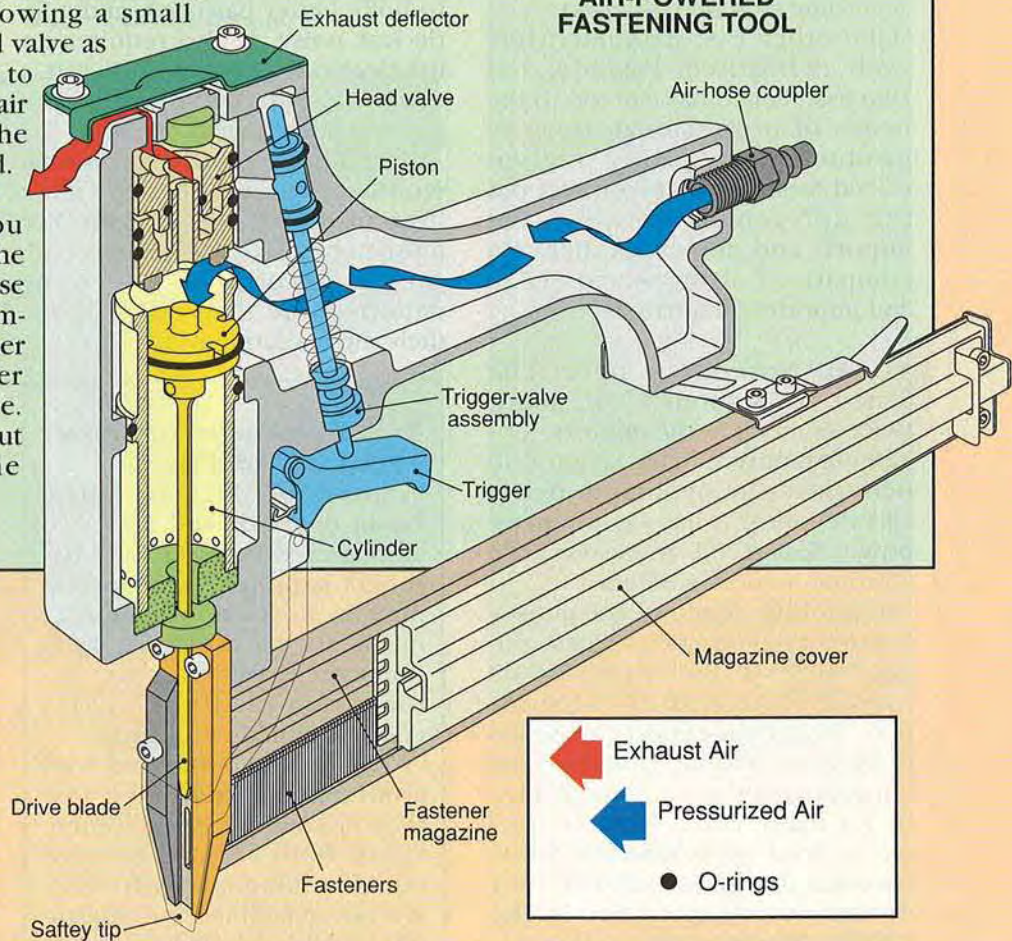

Staples have greater holding power, but leave larger holes, and tend to split hardwoods more so than brads.

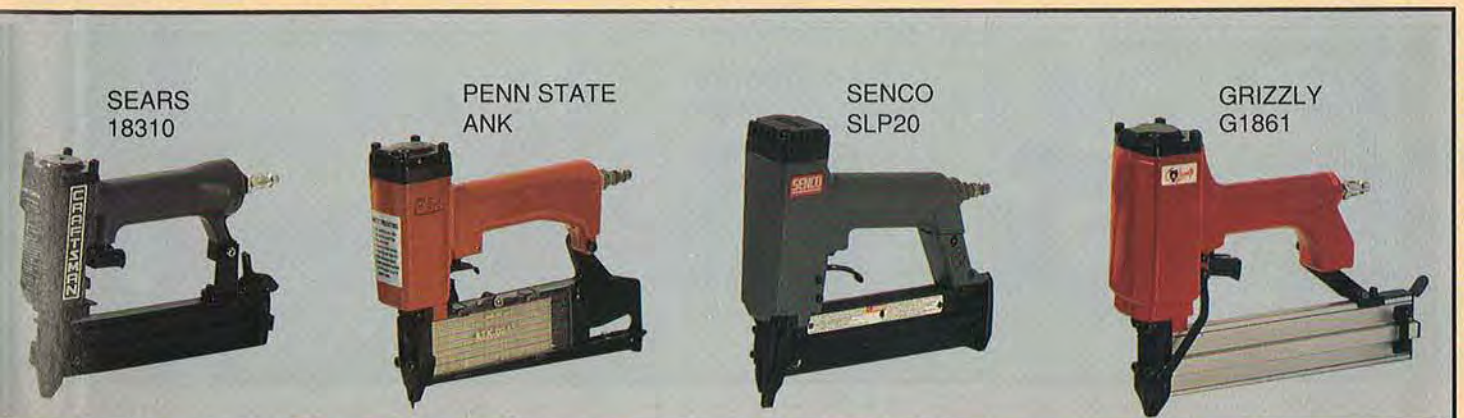

SURE SHOTS

among woodworkers in recent years, largely due to the advent of lower-priced, Taiwanese models. Although we focused our testing on these less-expensive units, we also included two similarly sized, U.S.-made, pneumatic machines: the Senco L stapler and the Senco SLP20 brad nailer (the world's top-selling air-powered tool according to Senco officials).

Like other U.S. manufacturers such as Bostitch, Paslode, and Duo-Fast, Senco has catered to the needs of professional users by producing top-quality, higher-priced tools. To help you sort out the differences between the imports and domestics, here's a comparison of the Senco SLP20 and imported bradnailers:

• **Cost.** No contest here. The Senco costs about \$270, about twice as much as the imports.

• **Performance.** The Senco outperformed the imports in nearly all categories. It has slightly more power, less recoil, and leaves little marring on work surfaces.

• **Reliability:** None of the guns—imports or domestics—failed during our tests. But, based on its overall higher-quality construction, we would expect the Senco to be more reliable. However, the imports should last a home hobbyist for many years. For example, we've fired approximately 5,000 fasteners through a Grizzly G1861 during two years of use in the *WOOD* magazine shop without a single breakdown. If you do need to replace a part, or remove a

jammed fastener, we found the Senco easier to disassemble and repair. The importers stock replacement parts, but you'll need to wait for them during the shipping period. Domestic manufacturers have extensive local-dealer networks.

• **Other points.** We found the Senco slightly more comfortable to hold, better balanced, and a little less noisy. It also requires no lubrication. (You should put a drop or two of oil into the imports before every use.)

All in all, we think professional woodworkers will benefit most from using a U.S.-made gun. For most hobbyists on a limited budget, the lower price tags of the imports more than make up for their slight shortcomings.

What you need to know about fasteners

You can use the same fasteners in domestic and imported air-powered guns, but the fasteners supplied by domestic makers cost about twice as much. So, we wondered if the domestic fasteners have features that justify the extra cost. We couldn't find any.

We measured both types with a micrometer and found that they shared the same dimensions. Both seemed to have equal holding strength. And, we never jammed a domestic gun with imported fasteners or vice versa.

Safety systems: four types to choose from

Each of the products in our test features one of four safety systems designed to prevent you from accidentally firing a fastener. (The chart on pages 34-35 describes the system for each tested gun.) Each system has a different effect on a gun's safety level, handling comfort, and performance.

For example, the Penn State model ANK and Woodtek model 832-371 brad nailers shown at *right* are nearly identical, but they have different safety systems that affect their overall performance level. Like most air-powered nailers, the Penn State model has a safety tip that must contact a work surface before the gun fires. This system provides a good margin of safety, but the sharp point of the safety tip tends to mar the surfaces of softwood.

With the Woodtek unit, you need to depress two triggers. This system took some getting used to, and doesn't protect the operator as much as the safety tip, but has advantages of its own. The Woodtek gun created almost no marring, even in softwoods. And you easily can fire fasteners in tight or awkward quarters where the position of the gun may prevent you from fully depressing a safety tip.

The Sears and Arrow staplers (air, electric, and battery powered) have a manual safety lock that prevents you from squeezing the trigger, similar to the version shown *right top* on the Sears 18300 air

AIR-POWERED STAPLERS

AIRY
ASP-0626



SEARS
18300



WOODTEK
832-364



SENCO
L



GRIZZLY
G1847



stapler. Like the safety on a firearm, these work as long as you remember to use them.

Overall, we rate the safety systems on the Jet, Penn State, Senco, and Sears 68425 as the safest because they require you to depress the trigger and safety tip.

Continued

▼ The nearly identical Penn State ANK (left) and Woodtek 832-371 have different safety systems.



▲ The Sears 18300 air-powered stapler has a safety lock that works like the trigger lock on a firearm.



Surface marring

The photo *below* shows you the marring effect of some of the brad nailers in our test. As you can see, none of them produce much marring in oak, but most of them damage the pine surface to some degree. In the chart on *page 35* we rate the surface marring of all the tested units. The Woodtek 832-371 came out on top of this test, with the Senco also producing excellent results.

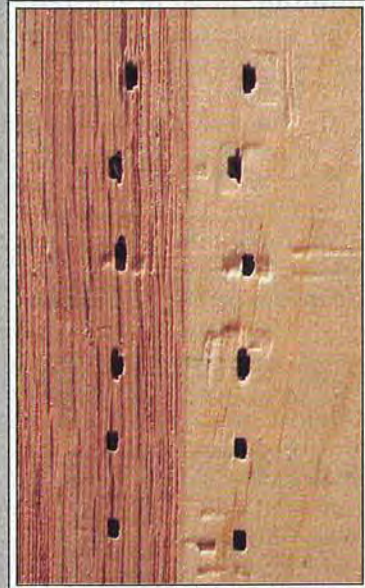

Here's how the brad nailers compared in a marring test on oak (left) and pine: (from top) Sears 18310, Senco SLP20, Sears 68425, (electric), Grizzly G1861, Woodtek 832-371, and Penn State ANK.

ELECTRIC FASTENING MACHINES: INEXPENSIVE, BUT LACKING POWER

For \$40 or less you can buy electric-powered nailers and staplers, but these machines have several limitations. Because their power does not compare to the brute force of air-powered tools, we found them inappropriate for use with hardwoods such as oak. They work fine in softwoods, as long as you hold the tool against the workpiece with considerable force. Otherwise, the tool recoils and the fastener does not sit flush or countersunk in the surface. All of the tested units marred the surface around the fastener.

Power and its effect on recoil

All of the air-powered tools in our test were able to drive their longest available fastener into pine. But, as you can see in the "power" column of the chart on *page 35*, the Sears and Grizzly air-powered staplers fell shy of driving their longest fasteners into oak.

When a powered fastening tool does not have sufficient power to drive a nail or staple, the tool recoils, meaning you feel some kickback. Most of the air-powered tools in our test produced little recoil in pine or oak.

ELECTRIC STAPLERS



SURE SHOTS

More points to consider:

• **Magazines.** Of all the tested units, we preferred the clear-plastic fastener magazines on the Airy, Woodtek, and Penn State brad nailers. Although not quite as durable as some of the metal magazines, the clear versions give you ample warning that you're running low on fasteners.

• **Jamming.** In all of our testing, we did not experience a single jammed fastener. But, if this should happen, and it probably will if you use a gun enough, some guns make removing the jam easier than others. The chart *right* rates the ease of clearing a jam (we forced the guns to jam to develop this rating).

• **Compressor requirements.** These guns require little compressed air compared to other pneumatic tools such as sanders. So, almost any compressor with an air-storage tank will do.

If you opt for a Taiwanese-made, air-powered tool, you need a compressor with an accurate regulator. We found that the o-rings on these tools blow out of position if you exceed the manufacturer's recommended maximum air pressure. And, none of the guns will work correctly if you don't have the required minimum pressure.

Drive carefully when handling these machines

Although nearly all of the hundreds of fasteners that we fired in our test followed a straight path when entering a wood surface, some occasionally veered off course due to the grain of the wood. For example, each of the fasteners in the photo *below* was fired straight into the workpiece, but each veered to the side and exited the wood. So, keep this possibility in mind when you hold two workpieces together for fastening, and keep your hands out of harms way.

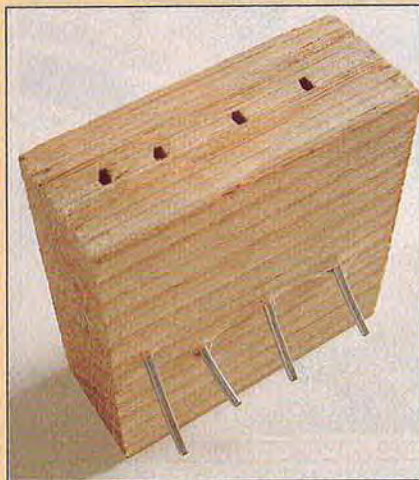

The orientation of wood grain can cause brads to bend as they travel through a workpiece.

Cordless staplers: handy, but pricey

The battery-powered staplers in our tests performed about equally with the electric staplers discussed on the *previous page*, but were handier because you

can use them almost anywhere. This convenience carries a stiff price however: \$145 for the Arrow ETC-50K and \$195 for the Makita T220DW.

CORDLESS STAPLERS

MAKITA
T220DW



ARROW
ETC-50K



Recommendations

We found most of the Taiwanese-made, air-powered tools to be good values and closely matched in overall performance. We give the Airy and Woodtek nailers and

MANUFACTURER/ IMPORTER	MODEL	LENGTH RANGE (INCHES)	FASTENERS		
			GAUGE		
AIR- AND ELECTRIC- POWERED BRAD NAILERS	AIRY	ATK-0241	13/32-19/16	18	
	GRIZZLY	G1861	3/8-19/16	18	
	JET	JDPN-607.2	3/8-1 1/4	18	
		JDPN-6018.2	9/16-15/8	18	
	PENN STATE	ANK	13/32-19/16	18	
	SEARS	68425	1-1 1/4	18	
		18310	3/8-1 1/4	18	
	SENCO	SLP20	5/8-15/8	18	
WOODTEK	832-371	13/32-19/16	18		
AIR-POWERED STAPLERS	AIRY	ASP-0626	3/8-1	18	
	GRIZZLY	G1847	1/2-7/8	18	
	SEARS	18300	1/2-7/8	18	
	SENCO	L	3/8-1	18	
	WOODTEK	832-364	1/2-1	18	
ELECTRIC- AND BATTERY-POWERED STAPLERS	ARROW	ETN-50	1/4-9/16	22	
		ETC-50K	1/4-9/16	22	
	MAKITA	T220DW	1/4-7/8	22	
	SEARS	68481	1/4-9/16	22	

NOTES:

- (AIR) Pneumatic powered, with required pounds per square inch of air pressure
(AC) 110-volt electric wall current
(BAT) Cordless units with listed voltage of battery cells
- (A) Drives bottom of staple crown flush with work surface
(B) Adjustable driver guide cover for settings from flush to about 1/8" countersunk
(C) Only countersinks to about 1/8" unless you change air pressure to gun
(D) Flush only; nail set and hammer required for countersinking

staplers a slight edge on the rest of the field because they produce little marring. Like the Penn State nailers, these similar models come with a carrying case, and a supply

of fasteners, oil, wrenches, and spare parts.

If price doesn't matter to you, buy a Senco or other domestically produced fastening tool. The elec-

tric-powered Arrow and Sears tools priced under \$50 offer excellent value for work in softwoods, in places where the fastener will not show. 🌲

MORE POWER TO YOU: A COMPARISON OF 18 FASTENING TOOLS

CROWN WIDTH (INCHES)	CAPACITY	POWER SOURCE (1)	COUNTERSINK DEPTH (2)		SAFETY SYSTEM (3)		BODY		MAGAZINE		CONSTRUCTION MATERIALS (4)		PERFORMANCE EVALUATION (6)				SIZE (INCHES)			STANDARD ACCESSORIES (12)	COUNTRY OF ORIGIN (13)	LIST PRICE	SELLING PRICE (14)
			WIDTH OF DRIVE BLADE (INCHES) (5)	SURFACE MARRING (7)	RECOIL IN PINE (8)	RECOIL IN OAK (8)	EASE OF CLEARING A JAM (9)	POWER (8) (10)	OVERALL PERFORMANCE	OVERALL VALUE	LENGTH (11)	WIDTH	HEIGHT	WEIGHT (POUNDS)									
.081	100	AIR 55-95 PSI	B	B	A	P	.087	E	E	G	G	19/16	19/16	8	10	9 1/2	2	7 1/2	2.1	AF, CC, OI, PA, WR	T	\$180	\$135
.081	150	AIR 90 PSI	C	D	A	A	.124	F	E	E	F	19/16	19/16	7	9	12 1/16	2 3/8	8 7/8	3.5	AC, OI, WR	T	--	130
.081	100	AIR 50-90 PSI	C	C	A	A	.143	F	E	G	P	1 1/4	1 1/4	6	8	9 1/2	2	7	2.7	CC, OI, WR	T	165	123
.081	100	AIR 60-90 PSI	C	C	A	A	.143	F	E	G	P	1 5/8	1 5/8	7	8	9 1/2	2	8	3.1	CC, OI, WR	T	217	162
.081	100	AIR 80-100 PSI	B	C	A	P	.087	F	E	G	P	19/16	19/16	7	9	9 1/2	2	7 1/2	2.1	AF, CC, OI, PA, WR	T	--	130
.081	100	AC	D	C	P	S	.092	F	E	NR	G	NR	1 1/4	3	5	8 3/4	2 1/4	8 1/2	3.5	--	T	--	40
.081	100	AIR	B	D	A	S	.124	F	G	G	G	1 1/4	1 1/4	6	9	9 1/2	2	7 1/4	3.5	OI, WR	T	--	95
.081	110	AIR 70-120 PSI	C	C	A	P	.088	E	E	E	E	1 5/8	1 5/8	10	10	9 1/2	1 7/8	8 1/4	2.2	CC	U	422	270
.081	100	AIR 80-100 PSI	B	B	A	P	.087	E	E	G	G	19/16	19/16	8	10	9 1/2	2	7 1/2	2.1	AF, CC, OI, PA, WR	T	--	139
1/4	100	AIR 55-95 PSI	B	B	A	P	.236	E	E	E	E	1	1	8	9	9	2	7 1/4	2.1	AF, CC, OI, PA, WR	T	194	130
1/4	100	AIR 90 PSI	B	D	A	S	.220	G	E	P	G	1/2	7/8	6	8	9 1/2	2	7	2.5	AC, OI, WR	T	--	90
1/4	100	AIR 52-100 PSI	B	A	A	S	.220	E	E	P	G	1/2	7/8	6	8	9 1/2	2	7	2.1	AC, OI	T	--	95
1/4	240	AIR 80-120 PSI	C	C	A	S	.249	E	E	E	E	1	1	10	10	11 1/16 to 14 13/16	2	7 3/4	3.2	--	U	298	215
1/4	100	AIR 80-100 PSI	B	B	A	P	.236	E	E	E	E	1	1	8	10	9	2	7 1/4	2.1	AF, CC, OI, PA, WR	T	--	110
3/8	85	AC	A	A	P	S	*	F	G	NR	F	NR	1/2	5	9	7 1/2	2 1/4	6 1/2	2.1	--	U	36.25	25
3/8	85	BAT. 7.2 V	A	A	P	S	*	F	G	NR	F	NR	1/2	5	3	9 1/8	2 1/4	6 1/2	3.4	CC, CH	U	210	145
3/8	100	BAT. 9.6 V	B	D	P	P	*	F	G	NR	F	NR	7/8	9	8	10 3/4	2	6 7/8	4.3	CC, CH	J	352	195
1/2	85	AC	A	A	P	P	*	G	G	NR	F	NR	1/2	5	9	8 1/2	2 1/8	6 1/2	1.1	--	U	--	30

- (A) Trigger firing with trigger safety lock disengaged.
- (B) You need to squeeze two triggers in sequence to fire gun.
- (C) You must place safety tip in contact with work surface, then depress trigger to fire each fastener.
- (D) Like 'C' except that you can fire the gun by simply holding the trigger down and touching the safety tip against the work surface.
- (A) Aluminum (P) Plastic (S) Steel
- (+) Staples are not countersunk, so width of drive blade not important.

- | | |
|---|-----------|
| E | Excellent |
| G | Good |
| F | Fair |
| P | Poor |

- Surface marring in pine; all tools were excellent in oak.
- (NR) Not recommended for use in oak; 22-gauge fasteners tend to crumple when driven into oak.
- Effort required to disassemble components that obstruct a jammed fastener.

- Longest fastener that can be fired flush with work surface.
- *Length varies depending on whether you extend the fastener magazine.
- (AC) Air coupler
(AF) Assorted fasteners
(CC) Carrying case
(CH) Battery charger
(OI) Oil
(PA) Piston/drive blade assembly
(WR) Wrenches
- (J) Japan (T) Taiwan (U) United States
- Selling prices based on advertisements and catalogs of mass merchandisers at time of article's production.

MANUFACTURERS' LISTING:

Airy
310/926-6192

Arrow
201/843-6900

Grizzly
East of Mississippi River:
800/523-4777
West of Mississippi River:
800/541-5537

Jet
800/243-8538

Makita
714/522-8088

Penn State
800/288-7297

Sears
Call or visit your local
Sears store

Senco
800/543-4596

Woodtek
800/645-9292

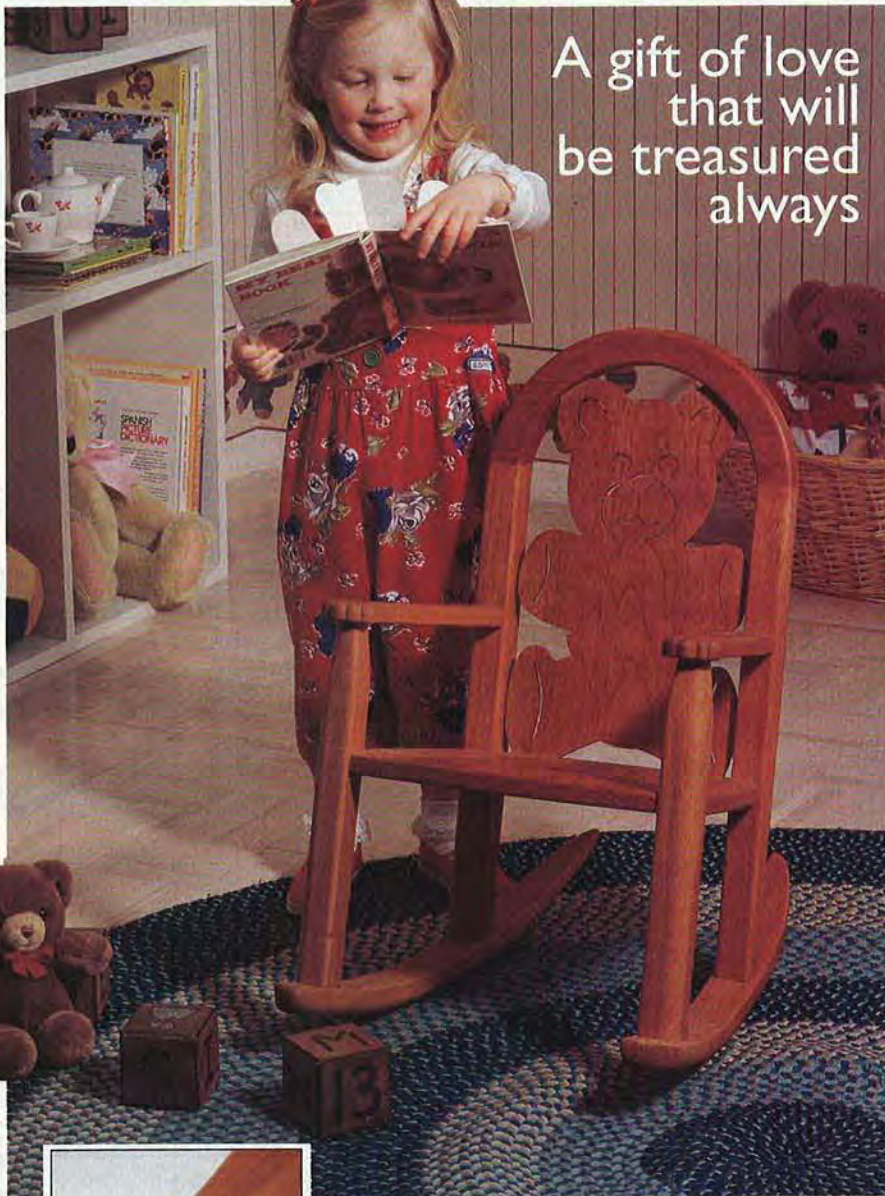

A gift of love
that will
be treasured
always

The one TEDDY

NOTE: For your convenience, we'll supply you with full-sized patterns for the bear cutout (D), rocker (F), and armrest (G). Or, if you just can't wait to get started, enlarge the gridded patterns shown on page 38. To receive the full-sized patterns, send \$3 and a 10×13" self-addressed envelope with \$1.25 postage to The Teddy Bear Chair, WOOD Magazine, 1912 Grand Ave., Des Moines, IA 50309-3379. (Foreign readers please include an international reply coupon.)

Begin construction with the arch-topped backrest

1 From $\frac{3}{4}$ " stock (we used cherry), cut one piece to 7×13" and a second piece to 7×10" for the backrest top rail (A). With the bottom edges flush and an even $1\frac{1}{2}$ " overhang on each end where shown on the Backrest drawing, glue and clamp the two pieces.

2 To form the backrest uprights (B), cut two pieces of $\frac{3}{4}$ "-thick cherry to $1\frac{5}{8}$ × $17\frac{1}{2}$ " and two pieces to $1\frac{5}{8}$ × $25\frac{1}{4}$ ". With the bottom ends and edges flush, glue and clamp the pieces face-to-face.

3 Scrape the excess glue from one edge of each laminated upright (B), and joint or plane the scraped edge flat. Rip and then joint the opposite edge of each upright for a $1\frac{1}{2}$ " finished width.

4 Miter-cut the bottom end of each laminated upright where shown on the Backrest drawing. Mark the centerpoints, and drill two counterbored mounting holes through each upright for the seat and two for the armrests.

5 Glue and clamp the uprights to the backrest top rail.

Text continues on page 39



Scrollsawed kerfs and round-overs accent the bear-paw armrests.

The children we've shown this little rocker to just can't resist it. We're not sure if it's the bear cutout in the backrest, the paw armrests, or the smooth rocking action that attracts them to it. But we do know this is one of the most usable pieces you'll ever have the opportunity to present to some lucky young recipient.

 Print this article

and only BEAR CHAIR

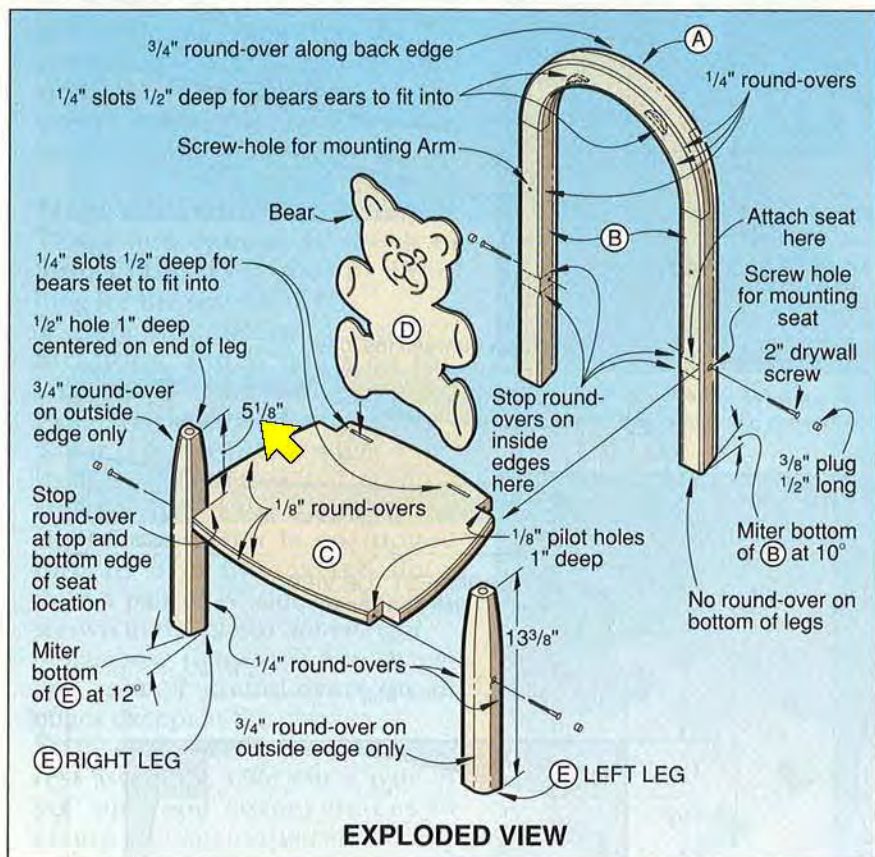

CUTTING DIAGRAM

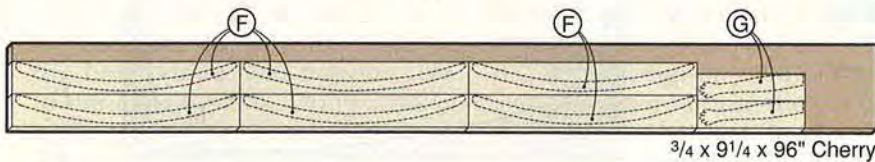
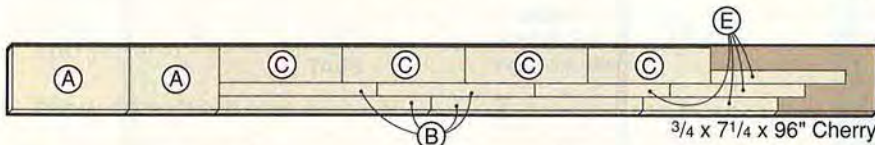

Bill of Materials					
Part	Initial Size			Matl.	Qty.
	T	W	L		
A backrest top rails	1 1/2"	7"	13"	LC	1
B backrest uprights	1 1/2"	1 1/2"	25 1/4"	LC	2
C seat	3/4"	15 1/2"	13 9/16"	EC	1
D bear cutout	1/4"	11"	17"	EC	1
E front legs	1 1/2"	1 1/2"	13 3/8"	EC	2
F rockers	2 1/4"	4"	25"	LC	2
G armrests	3/4"	3"	12"	C	2

Materials Key: LC—laminated cherry (or 1 1/2" solid stock), EC—edge-joined cherry

Supplies: 2" drywall screws, 1 1/2" dowel stock, finish.

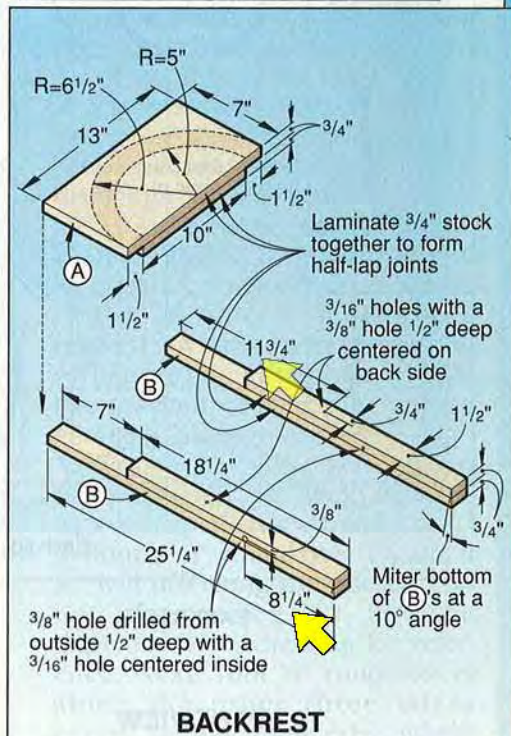

The TEDDY BEAR CHAIR

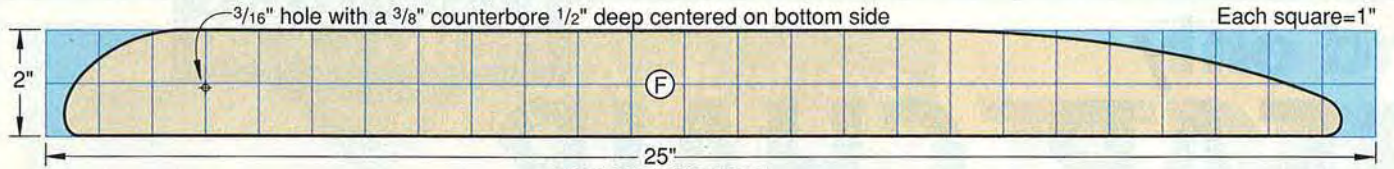

ROCKER TOP VIEW
(Top view for right rocker shown, make a mirror image for left rocker top view)

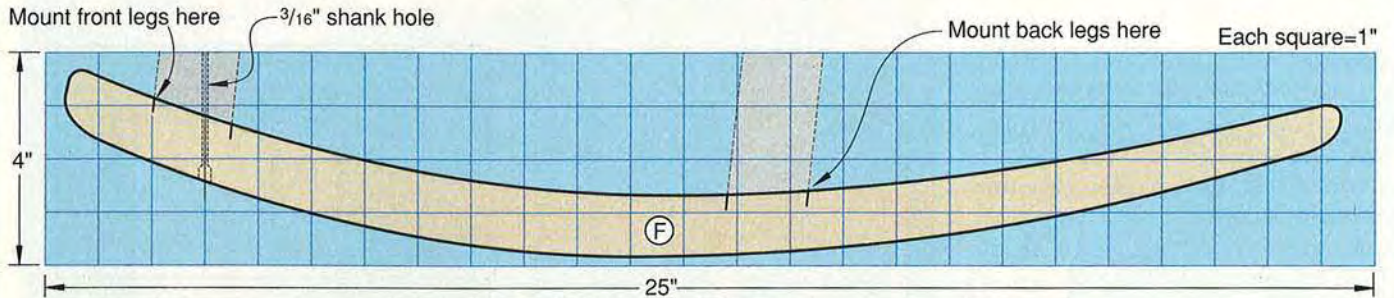

ROCKER SIDE VIEW

If necessary, sand tops of ears and bottoms of feet to fit into slots cut in (A) and (C)

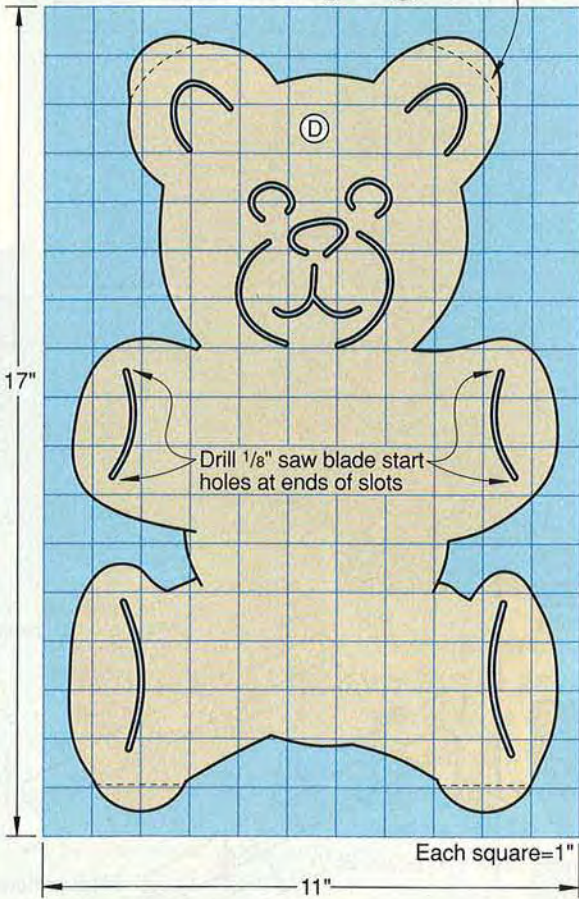

BACKREST

PART VIEW

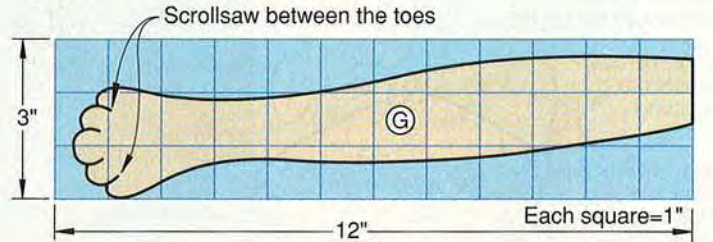

ARMREST TOP VIEW
(left arm shown)

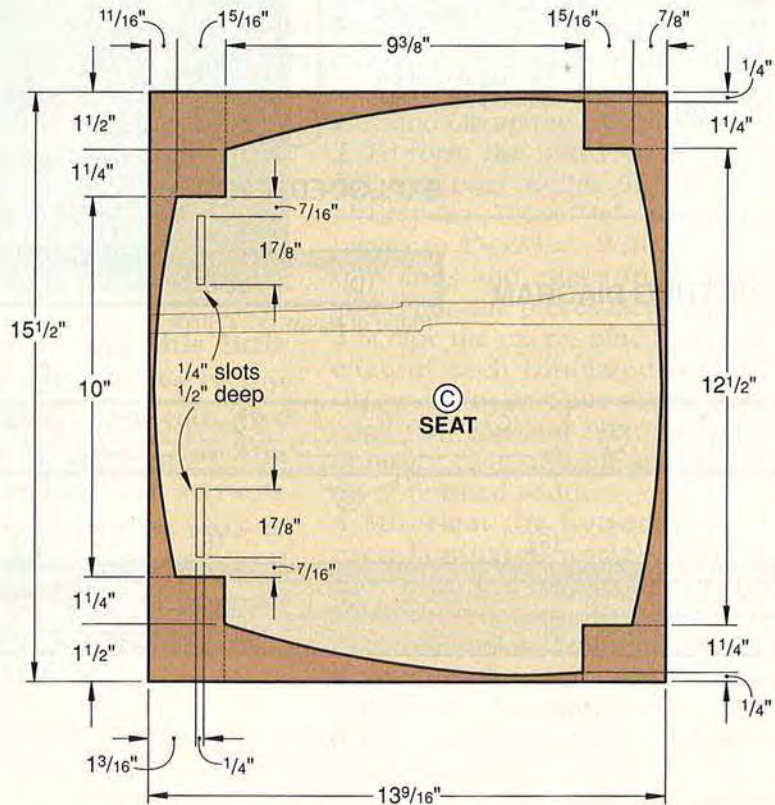

6 Using trammel points, mark a pair of arcs on the backrest top rail where shown on the Backrest drawing. Bandsaw and sand the top rail to shape.

7 Rout a $\frac{3}{4}$ " round-over along the back outside edge of the backrest frame. If you don't have a $\frac{3}{4}$ " round-over bit, a $\frac{1}{2}$ " will do. See the Exploded View drawing for reference. Rout $\frac{1}{4}$ " round-overs along the remaining three edges, except where the seat will attach where shown on the drawing.

Now, construct the seat

1 Edge-join enough $\frac{3}{4}$ " stock to form a blank $15\frac{1}{2}$ " wide by $13\frac{1}{16}$ " long for the seat blank (C).

2 Mark the outline, leg notch locations, and $\frac{1}{4}$ " slots on the chair blank, using the Seat on the Parts View drawing for reference.

3 Fit your router with a $\frac{1}{4}$ " straight bit. Position and clamp a straightedge to the seat blank so the $\frac{1}{4}$ " router bit is positioned directly over the marked slots. Rout a pair of $\frac{1}{4}$ " slots $\frac{1}{2}$ " deep as shown in the photo *above right*.

4 Bandsaw the seat (C) to shape, and rout $\frac{1}{8}$ " round-overs on all edges except at the corners.

5 Dry-clamp the seat to the backrest assembly. (We cut a pair of 90° plywood corner braces to clamp the seat squarely to the uprights.) Using the previously drilled mounting holes in the uprights for reference, drill a pilot hole centered top to bottom into the seat notch. Drive drywall screws through the uprights and into the seat.

Now for the bear cutout

1 Edge-join enough $\frac{1}{4}$ "-thick stock to form a panel measuring 11×17 " for the bear cutout (D). Transfer the bear outline and interior cuts to the 11×17 " blank. Drill $\frac{1}{8}$ " holes at the ends of each marked slot.

2 Using the $\frac{1}{8}$ " holes as blade-start holes, cut the decorative slots. Scrollsaw or bandsaw the bear's exterior outline to shape.



Rout a pair of $\frac{1}{4}$ " slots $\frac{1}{2}$ " deep in the seat blank to house the bottom of the bear's feet. For photo clarity we moved the model's right hand away from the router.



Position the bear cutout on the assembled backrest, and mark the slot locations as shown.

3 Position the bear cutout on the backrest assembly where shown in the photo *above*. Mark the start and stop marks on the front face of the backrest top rail (A) for the slots needed to house the ear tabs.

4 Using your router fitted with a $\frac{1}{4}$ " slotting-cutter, rout two $\frac{1}{2}$ "-deep slots, centered from face-to-face, between the start and stop marks on the backrest top rail.

5 Remove the seat from the uprights, fit the bear cutout in place, and reattach the seat.

Let's add the front legs

1 Using the same laminating and trimming method used to form the uprights, build a pair of $1\frac{1}{2} \times 1\frac{1}{2} \times 14$ " front leg blanks (E).

2 Miter-cut the bottom ends of the front legs where shown on the Exploded View and Front Leg drawings. Crosscut the top ends for a $13\frac{3}{8}$ " finished length.

3 Draw diagonals on the top end of each leg to find center. Then, drill a $\frac{1}{2}$ " hole 1" deep where marked. (We used a brad-point bit to center the hole directly over the marked centerpoint and to eliminate bit wander.)

4 Transfer the full-sized leg top patterns to the leg blanks. Cut the legs to shape and sand smooth.

5 Rout a $\frac{3}{4}$ " round-over (again, a $\frac{1}{2}$ " will do) along the outside corner of each leg (E). See the Exploded View drawing for reference. Next, rout $\frac{1}{4}$ " round-overs along the other three edges except on the inside edge where the seat will attach later.

Continued

The TEDDY BEAR CHAIR

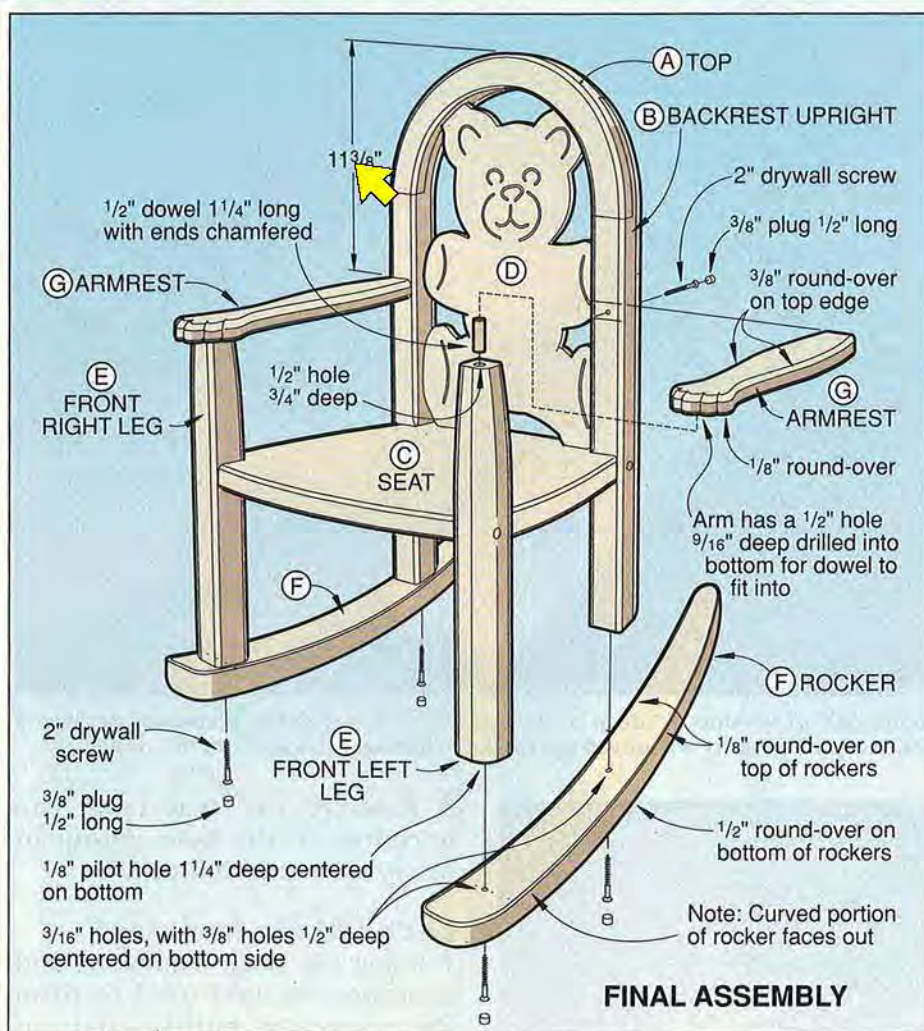

scrap cut from each rocker back end to its original position. (Taped back in place, the scrap keeps the blank from rocking when cutting the side view pattern. Now, bandsaw the side profile of each rocker to shape. Remove the taped-on scrap parts, and sand the rockers smooth. Rout $\frac{1}{2}$ " round-overs on the bottom edges of each rocker and sand $\frac{1}{8}$ " round-overs along the top.

Fasten the front legs and rockers

1 To join the front legs squarely to the seat, cut a plywood spacer $13\frac{3}{8} \times 15\frac{3}{8}$ ". Cut notches in the corners to match those in the seat. Cut the spacer in two, and tape the pieces back together with duct tape. See the photo *below right* for reference. The tape acts as a temporary hinge when positioning the spacer. If you leave the spacer as one solid piece, you can't remove it once the rockers have been attached.

2 Secure the spacer between the uprights and front legs with a bandclamp as shown in the photo *at right*. To clamp the rockers securely to the uprights, cut two small corner blocks. Clamp the rockers to the seat/uprights as shown in the photo.

3 Using the previously drilled $\frac{3}{16}$ " shank hole in each rocker as a guide, drill a $\frac{3}{8}$ " counterbore $\frac{1}{2}$ " deep into the bottom side of each rocker. Fasten the rockers to the front legs with drywall screws.

4 Mark the centerpoints on the bottom edge of the rockers to screw them to the uprights. Drill $\frac{1}{8}$ " pilot holes $1\frac{1}{2}$ " deep into the bottom end of each upright as shown in the photo. Drill $\frac{3}{8}$ " plug holes into the rockers, centered over the pilot holes. Finally enlarge the pilot hole in the rockers to $\frac{3}{16}$ ". Drive the screws.

5 Plug the $\frac{3}{8}$ " holes in the bottom of the rockers with extra-long plugs. Sand the plugs flush.

Laminate and cut the rockers to shape

1 Cut six pieces of $\frac{3}{4}$ "-thick stock to the sizes shown on the Rocker Lamination drawing for the two rocker blanks (F). Glue and clamp the two laminations (three boards each) together, with the edges and ends flush.

2 Joint or plane the top edge flat. Transfer the full-sized patterns (top and side) to each lamination. Note that you'll need a right and left top view pattern. Check that the patterns align with each other. Also, note that the inside edge of each rocker is straight while the outside edge is curved.

3 Working from the top surface of the rocker blank, drill a $\frac{3}{16}$ " shank hole $2\frac{1}{2}$ " deep into each blank where marked. (We'll drill the rear hole in each rocker later.)

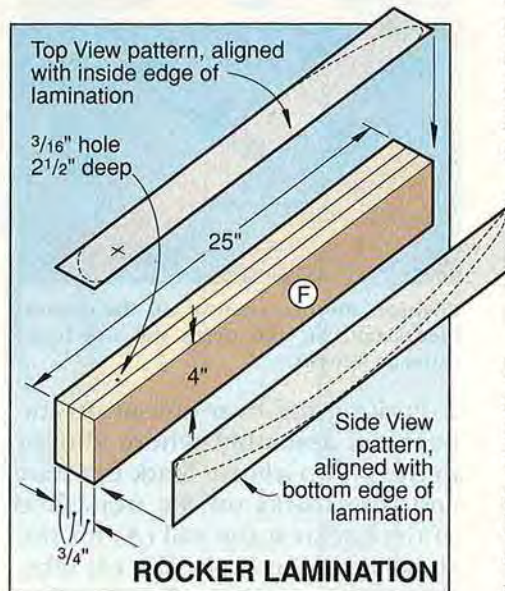

4 To bandsaw the rockers to shape, cut the top pattern to shape first. Using double-faced tape, adhere the back piece of

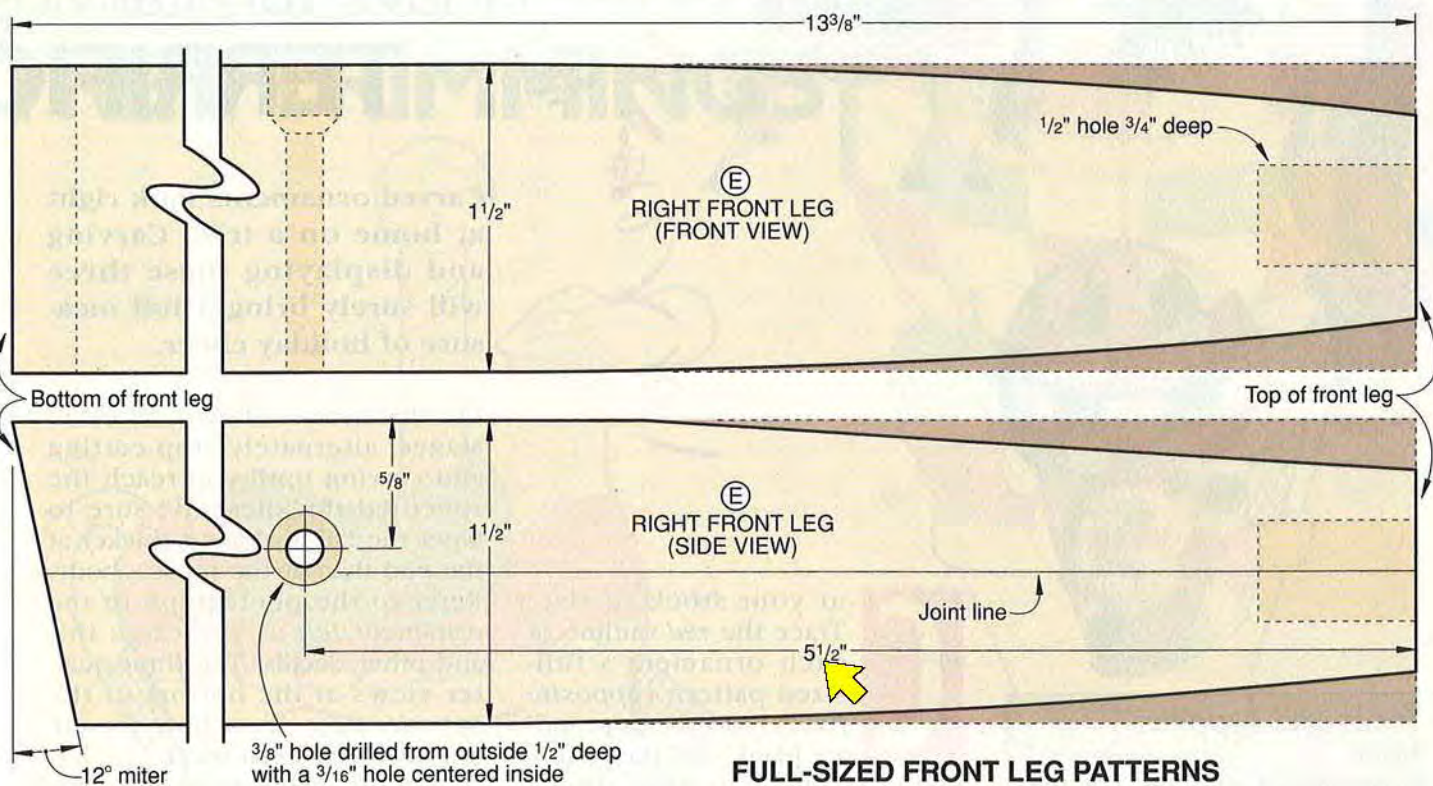

FULL-SIZED FRONT LEG PATTERNS

Add the bear-paw armrests and then the finish

1 Cut two pieces of 3/4"-thick stock to 3" wide by 12" long for the armrest blanks (G). Stick the armrest blanks together face-to-face with double-faced tape.

2 Transfer the full-sized armrest pattern to the top piece.

3 Bandsaw the taped-together armrests to shape. Separate the pieces and remove the tape.

4 Rout 3/8" round-overs along the top edges of the armrests. To

accent the paws on the armrests, scrollsaw between the toes. Sand slight round-overs on the areas around the toes where shown in the inset photo on page 36.

5 Insert a 1/2" dowel center into the 1/2" hole in the top end of a front leg. Hold an armrest in position so the back end of the armrest is flush with the front surface of the backrest. Push down to transfer the dowel hole centerpoint to the bottom of the armrest. Repeat for the other armrest.

6 Drill a 1/2" hole 3/16" deep into the bottom surface of each armrest where indented.

7 Cut two 1/2" dowels to 1 1/4" long. Sand a chamfer on each end of each dowel. Glue and dowel the armrest fronts to the front legs, and use drywall screws to fasten the back end of the armrests to the uprights. Plug the holes.

8 Sand the rocking chair. Stain and finish as desired (we used Watco Natural Danish Oil).

Position and clamp the rockers to the chair assembly. Mark the centerpoints, and drill pilot holes through the rockers and into the bottom of the uprights and legs.



Produced by Marlen Kemmet
 Project Design: Judith Ames, Seattle, Wash.
 Photographs: John Hetherington
 Illustrations: Kim Downing

Have fun carving **TERRIFIC**

Carved ornaments look right at home on a tree. Carving and displaying these three will surely bring a full measure of holiday cheer.

the thicknesses shown. Work in stages, alternately stop-cutting and carving until you reach the specified thickness. Be sure to taper the tail, making it thicker at the end than at the horse's body. Refer to the photograph of the ornament *left* as you carve this and other details. The three-quarter views at the bottom of the *opposite page* show how the different carved levels meet.

Carve the major detail lines (the *black* lines) about $\frac{1}{16}$ " deep with a V-tool. Hold the V straight up for these cuts. Once you have established the major details, round over the top edges to begin shaping the horse. A knife or shallow gouge, such as a no. 3, will work fine for rounding the edges.

As you carve, extend the detail lines around and onto the edges. Draw them first, and then carve them with the V-tool. Blend the back of the head and mane into the neck, but let the ear extend straight back from the head.

On the saddle, the rolled portion at the back of the seat extends straight across the top edge. With the tip of your knife, carve out the area between the tail and the back of the horse's body.

Lay out angled lines representing the spiral pattern on the rounded pole. Space them about $\frac{1}{16}$ " apart, slanting about 45° upward from the back of the pole toward the front. Then, starting from the center of the pole, make a V-tool cut around onto the edge on each line. Turn the ornament, and cut to the other edge.

Text continues on page 44

 Print this article

Cut your stock to size. Trace the *red* outline of each ornament's full-sized pattern (*opposite page*) onto the appropriate blank, and then band-saw or scrollsaw to shape. Drill a $\frac{1}{8}$ " hanging hole where shown.

Draw the *green* pattern lines onto the carousel horse and balloon blanks (disregard this and other references to *green* lines if you're starting with roughouts.) Copy the *black* lines showing the major details onto each blank or roughout, but don't attempt to draw in fine details yet. In fact, to keep the patterns uncluttered, we haven't shown many of the fine details on them. Study the photographs for the details not illustrated. Now, you're ready to carve. Here's how to proceed with each ornament.

A colorful holiday horse

To rough out the horse from the sawed blank, stop-cut the *green* lines with a knife or V-tool. (A *stop cut*, an incision along a pattern line, enables you to carve up to the pattern line without chipping out the wood beyond it.) Keeping the knife blade (or the vertical side of the V-tool) perpendicular to the surface, cut about $\frac{1}{8}$ " deep to start.

Carve the crosshatched legs, tail, pole, and the ball atop the pole to

Tools and supplies

Stock

Basswood or jelutong. For the balloon, $\frac{1}{2} \times 3 \frac{1}{2} \times 5$ "; for the carousel horse, $\frac{1}{2} \times 4 \times 5$ "; for the gnome Santa, $\frac{1}{2} \times 3 \times 5$ ".

Gouges

No. 3, $\frac{1}{2}$ ", 1" fishtail 

No. 8, $\frac{1}{4}$ " 

No. 9, $\frac{1}{4}$ " 

No. 11, $\frac{1}{8}$ ", $\frac{1}{4}$ " 

V-Tools

60°, $\frac{1}{4}$ " or $\frac{5}{16}$ " 

Knives

Bench knife

Detail knife

Finishing supplies

Acrylic artist's colors. For the paint schemes shown, use these or similar colors. (The two-letter codes denote the colors on the photographs.) Ceramcoat by Delta: black, white, bright red, ultra blue, medium flesh, antique white (AW), iridescent white (IW), cadet gray (CG), burnt sienna (BS), pigskin (PS), antique gold (AG), Christmas green (GR). DecoArt: glorious gold (GG), crystal green (GN).

Wood sealer, linseed oil or antiquing stain, semigloss spray lacquer, brushes.

these heirloom ornaments

TREE TRIMMINGS

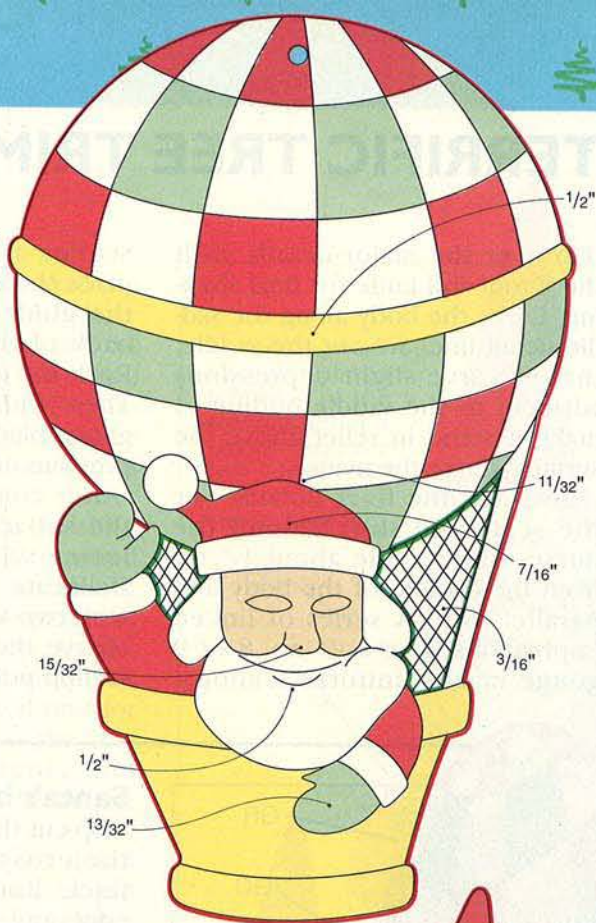
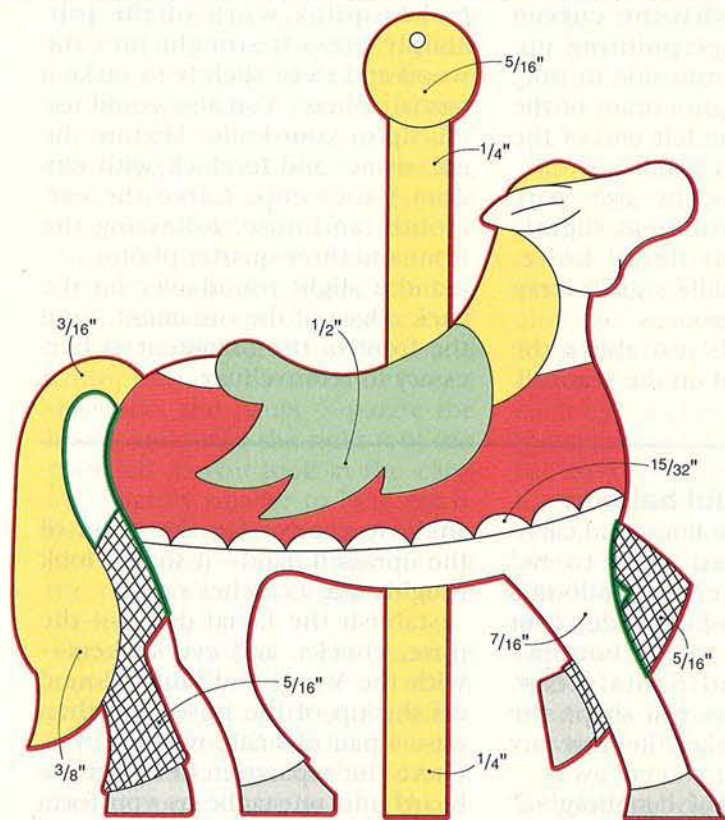

Separate the elaborate trappings from the horse's body by carving them in relief. The three-quarter front view shows details of the face and the front legs. Note in the rear view that the tail becomes both wider and thicker at the end.

TERRIFIC TREE TRIMMINGS

Go over the major details with the V-tool and knife for final shaping. Carve the body along the saddle detail line. *Set out* the saddle; that is, carve slight depressions adjacent to the saddle outline to make it stand in relief above the surface. Carve the mane.

Now, add the finer details. For the scalloped skirt around the horse, draw a line about $\frac{1}{4}$ " up from the bottom of the body and parallel to it. A series of linked impressions from a $\frac{1}{4}$ " no. 8 or 9 gouge makes uniform scallops.

Starting at the front of the horse, place the corners of the blade on the guideline, with the curved back of the gouge pointing up. Rock the gouge from side to side. Then, with the right corner of the gouge blade at the left end of the previous arc, do it again.

After completing the arcs, pare the surface below them slightly lower with your detail knife. Delineate the saddle's girth strap with two V-tool grooves.

Carve the jewels just above the scallop points and on the seat roll.

A $\frac{1}{8}$ "-diameter eye punch, available from carving-supply dealers, makes quick work of the job. Simply press it straight into the wood and twist slightly to make a partial sphere. You also could use the tip of your knife. Texture the tail, mane, and forelock with random V-tool cuts. Carve the ear, mouth, and nose, following the front and three-quarter photos.

Sand a slight round-over on the back edges of the ornament. Sand the front of the ornament as necessary to remove fuzz.



Diagonal V-tool cuts about $\frac{1}{16}$ " apart lend realism to the heavy rope around the balloon. Undercut the bottom of the balloon basket slightly, sloping it from front to back for perspective.

Santa's beautiful balloon

Stop-cut the *green* lines, and carve the crosshatched areas to $\frac{3}{16}$ " thick. Round over the balloon's edge and the basket's sides (but not the basket's top or bottom). Stop-cut around Santa's cap, beard, and arm as you shape the balloon and basket. Redraw any detail lines that you cut away.

With the V-tool, cut about $\frac{1}{16}$ " deep along the checkerboard detail lines on the balloon, creating the panels. Then, carve a half-round profile between the parallel lines around the balloon to simulate a rope. (An upside-down gouge does the trick.) To heighten the effect, cut evenly spaced diagonal lines across the rope with a V-tool.

Set out the rope, and smooth the balloon surface with a gouge and knife. With shallow V-tool cuts, clean up the lines between the panels.

Shape Santa's head with a detail knife. Rough in the rectangular area for his face. Carve his cap and beard, creating sharp separations between them and the balloon and basket.

Round Santa's arms, and form his mittens and fur cuffs. The mittens can be almost circular, with just a hint of a thumb on the hand on the front of the basket. Carve a

shallow groove for the palm of the upraised hand—it should look roughly like a catcher's mitt.

Establish the facial details—the nose, cheeks, and eye sockets—with the V-tool and knife. Round off the tip of the nose, and then raise a pair of small ovals for eyes. Carve the separation between the beard and mustache as you form Santa's lower lip.

Texture Santa's hair, beard, and the fur trim on his clothing with V-tool cuts. Short, curved, random cuts will look better than long, straight ones.

Carve rolled rims at the top and bottom of the basket, and detail them with closely spaced diagonal V-tool cuts. Carve the body of the basket slightly lower than the rims, and then detail it with a basketweave pattern. Start with horizontal V-tool cuts parallel to the top of the basket. Then carve the vertical lines. Take shallow cuts to minimize breaking off the small pieces that create the texture.

Undercut the bottom of the basket slightly. Carve a shallow V-tool groove parallel to the right edge between the balloon and basket to delineate the rope connecting the basket to the balloon. Detail Santa's sleeves and cap with shallow cuts to form folds and wrinkles. Sand the ornament lightly.

Gnome Santa

Incise the detail lines with the V-tool. With gouges and your bench knife, round over the edges of the blank. Carry the detail lines on around the edges, either carving them with the V-tool or penciling them in to carve later. Set out the arm, cap, coat bottom, legs, and boots using the V-tool and knife.

Rough out the basket on the gnome's back, and shape the bag at his side as you carve the coat and left arm. With the V-tool and knife, carve a division between the boots and pants. Separate the boots, and make the right foot (on your left as you look at the carving) slightly smaller to help establish perspective. Notice in the photographs, too, that the sole of the right boot isn't aligned with the left one.

Carve the package in the gnome's hands, using the knife or no. 3 gouge. Slope the top of the package upward and back from the corner marked A on the pattern illustration. Notice in the three-quarter photographs that the front of the package slopes in (becomes thinner) from that point both vertically and horizontally.

As you carve the package, rough in mitten shapes for the hands. To add a ribbon to the package, outline it with shallow V-tool cuts, then set it out slightly.

Next, divide the fingers. Only four fingers of the right hand will show on the carving, but four fingers and the thumb will show on the gnome's left hand.

Carve a slight break between the left hand and the sleeve to create a cuff. Then, refer to the three-quarter view photo as you shape the trumpet, ball, and box in the basket using the gouges and knife.

Project Design: © Joe and Kay Wannamaker

Form the eyebrow line and the bridge of the nose as you hollow the eye locations with a no. 11 gouge. Round the cheeks and blend them into the eye sites, noting that the right side of the face (on your left) runs off the edge of the ornament.

Carve slight hollows on the sides of the nose to create a rounded end. Make a shallow knife cut alongside the nose to separate it from the cheek. With the V-tool, carve a small football shape at each eye socket (a partial one for the right eye). Cut across the center to separate the upper and lower eyelids, and then blend the eyes into the face.

Set out the ear, and then detail the hair, mustache, and beard with random V-tool cuts. Carve the lower lip as you complete the beard. Detail the basket as you did the balloon basket. Inspect the carving, and sand.

Bright holiday colors

Before painting, coat the ornaments with an undercoat or sealer. (Clear spray-on lacquer or thinned acrylic gesso work fine.) Paint with acrylic artist's colors thinned slightly with water. Follow the color scheme shown in the photographs, or paint the ornaments in your own style. Apply the paint in thin coats to preserve carved details.

To antique the ornaments, wipe on Danish oil finish or walnut stain. Wipe off the excess immediately. Let the ornaments dry, then spray on semigloss lacquer or polyurethane finish. Tie a loop of gold cord through the hole on each, and hang the trio on your tree. 🌲

Photographs: John Hetherington

Buying Guide

Roughouts. Set of three roughouts with gold elastic string, \$15 ppd. in U.S. J&K Wannamaker, 324 Big Arch Road, Godfrey, IL 62035, 618/466-8640.

The face stops abruptly at the left edge of the carving. From a three-quarter left view, you see the face almost head-on.

CG

GR

GG

UNPAINTED

BS

Three-quarter right side view shows the face in profile. The basket top rim curves 90° to the back in the vicinity of the blue stripe on the ball.

AG

AW

IT'S THE PERFECT GIFT

ONE SWEETHEART



You'll surely win your loved one's affection with this unique gift. The lid and trays rotate open to display fine earrings, rings, and necklaces, and they swivel closed, making an eye-pleasing dresser-top showpiece. If you don't get it built by Christmas, keep in mind that the heart-topped container works great for birthdays and Valentines Day, too.

Marking the base, trays, and top layouts

1 From 1 $\frac{1}{16}$ "-thick cherry, cut a 7"-square piece for the base (A), two pieces to 5 $\frac{1}{2}$ " square for the trays (B), and one piece of $\frac{3}{4}$ "-thick bird's-eye maple to 5 $\frac{1}{2}$ " square for the lid (C).

2 Mark centerlines on the *bottom surface* of the four blanks where shown on the Parts View drawing. Then, using a combination square, mark 45° reference lines on the bottom surface of the two trays and lid blanks.

3 Using a compass, mark a 3 $\frac{1}{4}$ "-radius and 2"-radius circle on the base blank. See the Parts View for reference. Mark 2"-radius and 2 $\frac{1}{2}$ "-radius circles on the tray blanks (B). Mark a 2 $\frac{1}{2}$ "-radius circle on the maple lid blank (C).

4 Mark the centerpoints, and drill the pivot holes where shown on

the Parts View drawing. For the base pivot hole, drill a $\frac{5}{8}$ " hole $\frac{1}{4}$ " deep on the bottom side first. Then, drill a $\frac{1}{4}$ " hole centered inside the $\frac{5}{8}$ " hole.

Cutting and sanding the pieces to shape

1 Fit your bandsaw with a $\frac{1}{4}$ " blade. (See the previous bandsaw-blade article for reference.) Following the centerline marked parallel with the grain, bandsaw the base and trays in half.

2 Bandsaw the inner marked circle on the tray and base pieces to cut the interiors to shape.

3 Spread glue on the kerfed areas, and glue the tray and base halves back together, with the top and bottom edges flush.

4 Cutting just outside the outermost marked circle, bandsaw the base, two trays, and lid to shape.

Later, sand the outside edge of the base to the marked circumference lines to finish the shaping.

5 Using your largest diameter drum sander, sand the inside of the base and trays, sanding to the inner marked circle.

6 To make the bottom (D) for the base (A), position the base on a piece of $\frac{1}{4}$ "-thick stock (we used plywood). Marking along the inside of the base wall, transfer the shape to the $\frac{1}{4}$ " stock. Cut and sand the base bottom (D) until it fits snugly inside the base and the bottom edges are flush.

Glue the bottom in place. Repeat the process for the two trays.

7 Mark the stop-dowel center-points on the bottom side of the trays and lid. Drill the holes.

It's time for final machining

1 Cut the pivot dowel to 3 $\frac{1}{16}$ " long. Dry-fit (no glue) one end of the dowel into the hole on the bottom side of the lid. Sand the rest of the dowel until the trays rotate easily on it.

2 To sand the edges of the trays and lid flush, use double-faced (carpet) tape to adhere the trays and lid one on top of the other with the outside edges flush and the pivot pin inserted through the pivot pin holes in the trays and into the $\frac{1}{4}$ "-deep hole in the lid.

3 With the assembly upside down and resting on the lid, disc sand the outside edges of the pieces flush. Switch to a palm sander, and sand away any sanding marks left by the disc sander.

4 Use a splash of lacquer thinner or acetone to weaken the double-faced tape joints. Now, separate the parts, and remove the tape and any sticky residue.

5 Cut a V-block router-table fence like that shown in the photo on *page 48*. The fence provides support when routing the base and lid covers and helps keep your fingers safely away from the spinning router bit. Rout a $\frac{3}{8}$ " cove along



OF A JEWELRY BOX

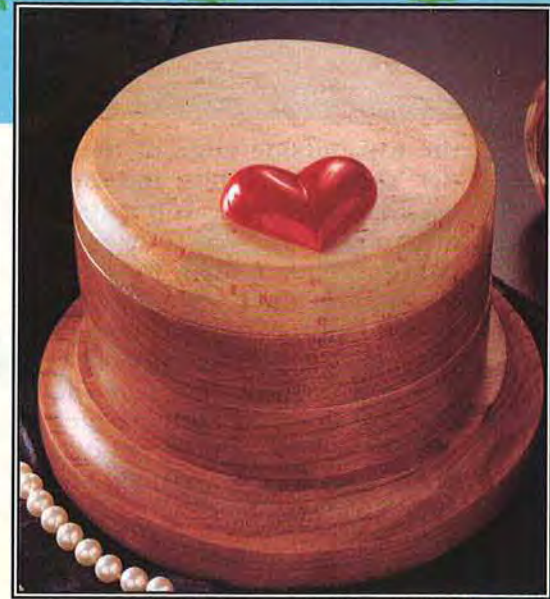

Chiseled and sanded smooth, the painted wood heart adds an element of romance to this trayed jewelry box.

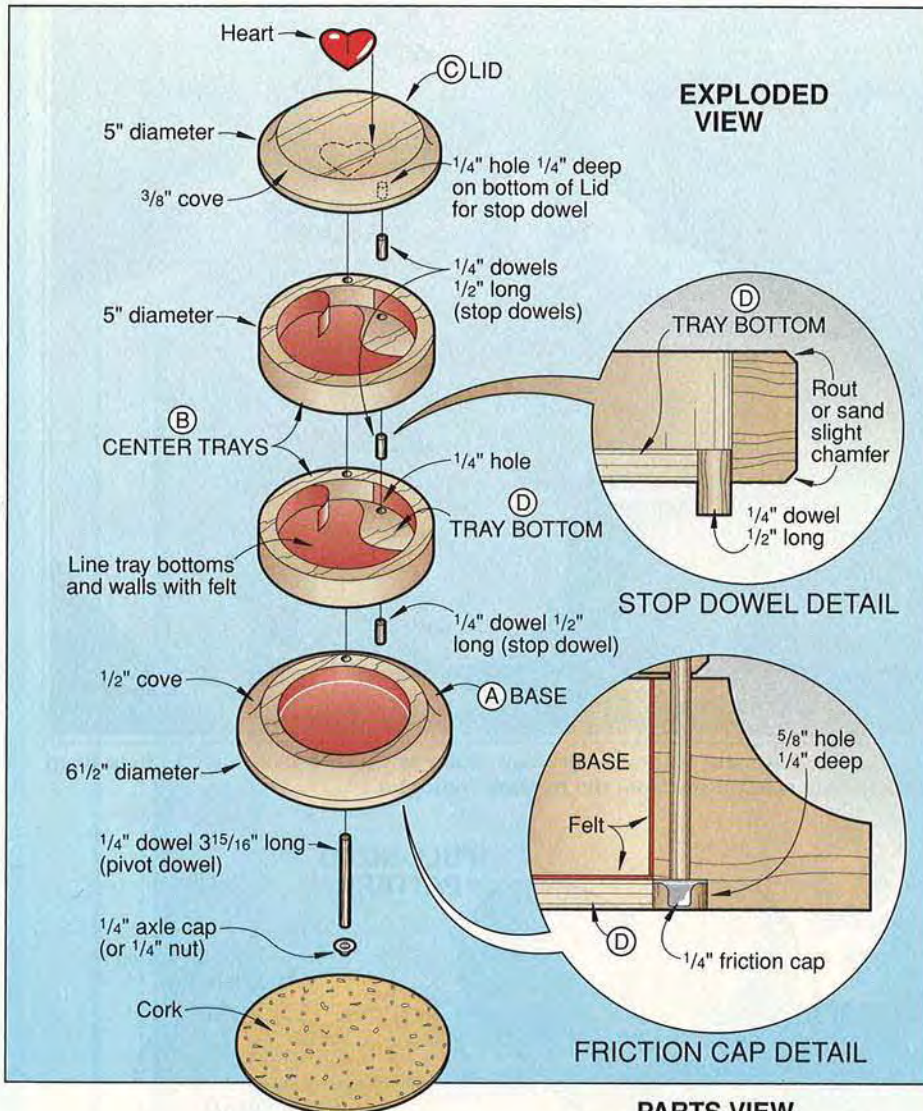

Bill of Materials					
Part	Finished Size			Mater.	Qty.
	T	W	L		
A* base	1 1/16"	6 1/2" dia.		C	1
B* trays	1 1/16"	5 1/2" dia.		C	2
C* lid	3/4"	5" dia.		BM	1
D bottoms	1/4"	4" dia.		P	3

*Initially cut parts oversized. Then, trim each to finish size according to the how-to instructions.

Materials Key: C—Cherry, BM—bird's-eye maple, P—Plywood

Supplies: 1/4" friction cap or 1/4" nut, 1/4" dowel stock, red enamel paint, clear finish, cork.

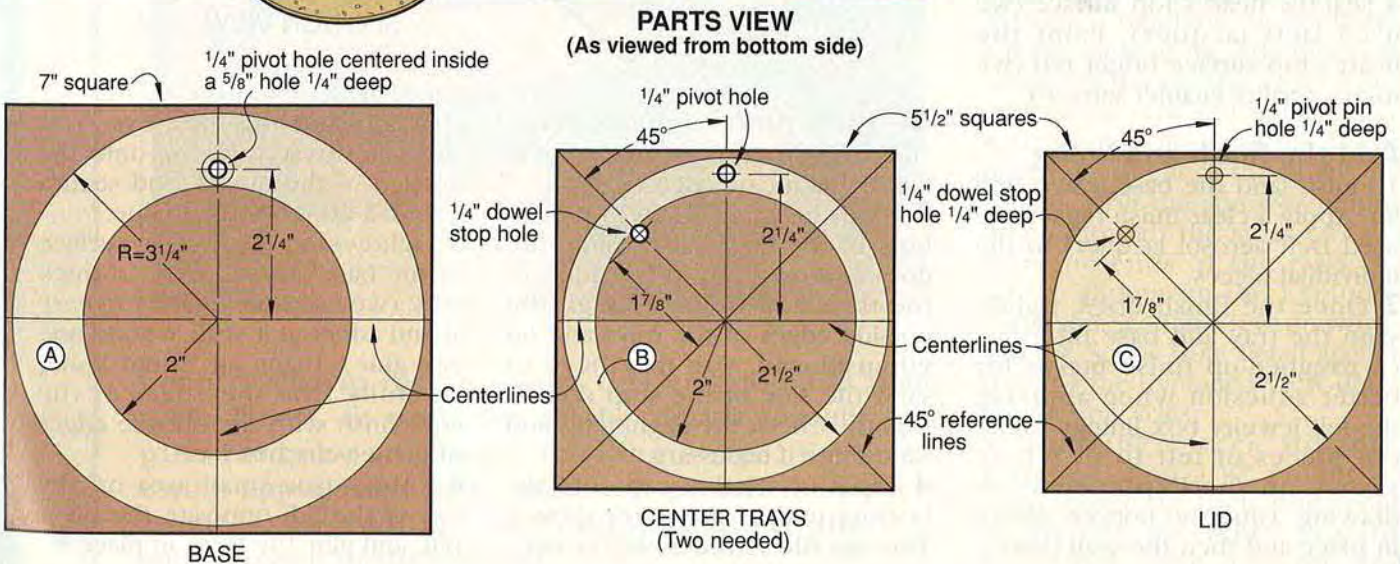

ONE SWEETHEART OF A JEWELRY BOX

the top outside edge of the lid (C). Then, switch bits, and rout a $\frac{1}{2}$ " cove along the top outside edge of the base (A). To minimize chip-out when routing the covs, we did it in three passes, increasing the depth of cut each pass.)

6 Sand a $\frac{1}{32}$ " chamfer along the top and bottom edges of each tray, and along the bottom edge of the lid. See the Stop Dowel detail accompanying the Exploded View drawing for reference.

7 From $\frac{1}{4}$ " dowel stock, cut the three stop dowels to $\frac{1}{2}$ " long. Again, see the Stop Dowel detail for reference. Glue the stop dowels in place.

OK, let's make the heart

1 Transfer the full-sized heart pattern to a piece of $\frac{3}{8}$ " thick maple. Using a bandsaw or scrollsaw, cut the heart to shape, and then sand the cut edges smooth.

2 For stability, adhere the heart to one corner of your benchtop or to a large piece of scrap material. Using a handsaw, cut a $\frac{3}{16}$ "-deep kerf down the middle of the heart where shown at *right*.

3 Sand or chisel the contours of the heart to the shape shown on the drawing and intro photos. Finish-sand the heart to its final rounded shape.

4 Seal the heart's top surface (we used Deft lacquer). Paint the heart's top surface bright red (we used a quality enamel aerosol).

Add the finish and lining

1 Finish-sand the base, trays, and lid. Apply a clear finish (again, we used Deft aerosol lacquer) to the individual pieces.

2 Once the finish dries, lightly sand the tray and base interiors. (A roughed-up finish makes for better adhesion when applying the felt jewelry box linings. Next, cut pieces of felt to fit where shown on the Exploded View drawing. Glue the bottom pieces in place and then the wall pieces.

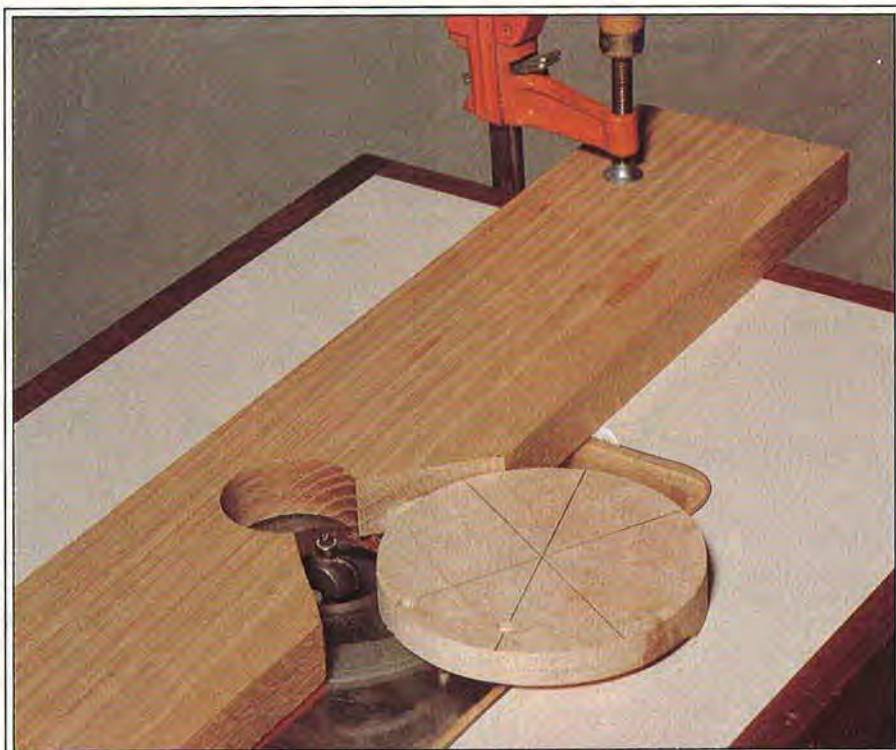

To rout the base and lid covs, fit your router with a V-block fence to help keep your fingers safely away from the rotating router bit.

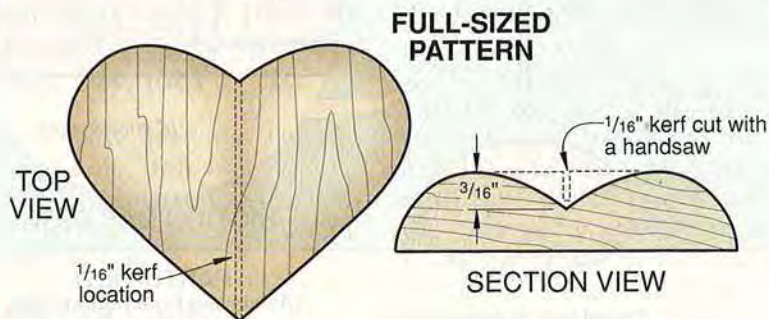

Or, for a professional-looking "flocked" interior, see our flocking technique on *page 76*.

3 Glue the pivot dowel into the hole in the lid bottom. Slide the dowel through the pivot holes in the trays and base. To align the outside edges of the trays and lid when closed, you may have to sand the side of the stop dowels slightly. Check the alignment, and sand more if necessary.

4 Tap a $\frac{1}{4}$ " friction cap onto the bottom end of the pivot dowel. The cap allows the dowel to swiv-

el when opening the trays. You also can thread a $\frac{1}{4}$ " nut onto the bottom of the dowel, and secure it with a drop of instant glue.

5 Lightly sand the bottom surface of the base, and adhere $\frac{1}{16}$ "-thick cork (we used cork gasket material and adhered it with woodworker's glue). Using an X-acto knife, carefully trim the edges of the cork flush with the outside edges of the jewelry box base.

6 Rough-up a small area on the top of the lid, opposite the pivot pin, and glue the heart in place. ♣

COUNTRY-TIME PLATE RACK



Country charm radiates from this easy-to-build plate rack. That's, in part, due to the simple joinery and pine tongue-and-groove backing strips. Even the cutout apple motif helps make our project the perfect creation for adding real homespun atmosphere to your kitchen or dining area.

Note: To form the cabinet back, we purchased economy-grade tongue-and-groove knotty pine plank paneling at a local home center. Our strips measured $\frac{1}{4}$ " thick by $3\frac{1}{2}$ " wide. They came packed in random lengths measuring 5' to 8' long. The stock is quite inexpensive, but we did have to work around a few knots and defects. You also could use $\frac{1}{4}$ " plywood for the back.

Cut the main frame pieces first

1 From $\frac{3}{4}$ "-thick pine, cut the sides (A), shelves (B), and upper and lower rails (C) to the sizes listed in the Bill of Materials.

2 Using double-faced tape, adhere the two sides (A) face-to-face with the edges and ends flush. Transfer the full-sized top and bottom patterns on the next page, including the hole centerpoints, to the ends of the taped-together side pieces.

3 Using a bandsaw or scrollsaw, cut the ends of the side pieces to shape. Separate the pieces and remove the tape and residue.

4 Dry-clamp (no glue) the assembly (A, C) to check the fit and for square. Drill the screw-mounting holes through the sides (A) and into the ends of the rails (C) where shown on the Exploded View and Section View drawings. See the Screw-Hole detail accompanying the Exploded View drawing for hole sizes.

5 With the pieces still dry-clamped, rout a $\frac{1}{4}$ " rabbet $\frac{1}{4}$ " deep around the back inside edge of the A/C assembly. See the Exploded View drawing and

Continued

PLATE RACK

accompanying Rabbet detail for reference. Remove the clamps and disassemble the unit.

6 Mark the dado locations on the side pieces where dimensioned on the Exploded View drawing. Using your tablesaw or radial-arm saw, cut $\frac{3}{4}$ " dados $\frac{1}{4}$ " deep where marked. (We set a stop when cutting each dado to ensure that the dados are in the same location on each side piece.)

7 Cut a $\frac{3}{8}$ " groove $\frac{1}{4}$ " deep in each shelf (B) where shown on the Section View drawing.

Add the shelves and upper and lower rails

1 Enlarge and transfer the full-sized apple and top outline pattern to the upper-rail blank. Tape the upper and lower rails (C) face-to-face, and cut the outlines to shape. Separate the pieces and remove the tape.

2 Next, drill a blade-start hole, and scrollsaw the apple to shape in the upper rail (you also could use a coping saw).

3 Glue, clamp, and screw the sides (A), shelves (B), and top and bottom rails (C), checking for square. Position the shelves (B) into the dados in the side pieces so the back edge of the shelves are flush with the inside edge of the rabbets. This will leave enough room for installing the pine plank paneling.

4 Cut $\frac{3}{8}$ "-diameter plugs from $\frac{5}{16}$ " stock, and plug the screw-mounting holes. Sand the plugs flush with the outside surface of the side pieces.

5 Working from the center of the rack out, crosscut pieces of the

pine plank paneling to fit into the rabbeted back edge of the cabinet assembly. Hold the pieces in place with masking tape. You'll need to rip the two outside pieces for a good fit. Glue and nail the pieces in place, being sure to wipe off excess glue with a damp cloth. (We used #18x $\frac{5}{8}$ " brads to secure the pine plank paneling in the rabbets and to the back edges of the shelves where shown on the Section View drawing.)

6 For mounting to the wall later, drill and counterbore a pair of mounting holes through the upper and lower rails (C). You'll need to use long screws and hit studs or use toggle bolts to hang the unit. Plug the holes with wood buttons after hanging.

7 Finish-sand the assembled cabinet. Stain the cabinet (we used Wood Kote gelled Fruitwood stain). Let the stain dry overnight before applying a clear finish. ♣

Produced by Marlen Kemmet
Project Design: James R. Downing
Photograph: John Hetherington
Illustrations: Kim Downing

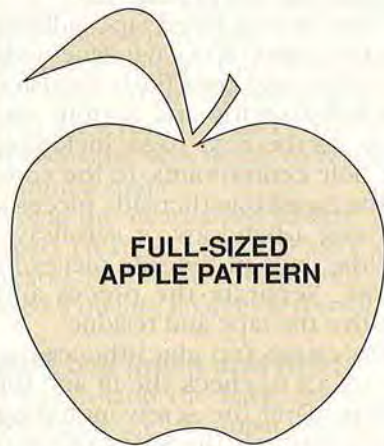

FULL-SIZED TOP PATTERN (A)

FULL-SIZED BOTTOM PATTERN (A)

$\frac{3}{8}$ " holes $\frac{1}{4}$ " deep with a $\frac{5}{32}$ " countersunk shank hole centered inside

$\frac{3}{8}$ " holes $\frac{1}{4}$ " deep with a $\frac{5}{32}$ " countersunk shank hole centered inside

Bill of Materials

Part	Finished Size			Matl.	Qty.
	T	W	L		
A sides	$\frac{3}{4}$ "	$4\frac{1}{2}$ "	$31\frac{1}{4}$ "	P	2
B shelves	$\frac{3}{4}$ "	$4\frac{1}{4}$ "	23"	P	2
C rails	$\frac{3}{4}$ "	$4\frac{1}{8}$ "	$22\frac{1}{2}$ "	P	2
D backing	$\frac{1}{4}$ "	23"	$25\frac{1}{4}$ "	PP	1

Materials Key: P-Pine, PP-pine plank paneling

Supplies: #18x $\frac{5}{8}$ " brads, #8x $1\frac{1}{4}$ " flathead wood screws, #8x $2\frac{1}{2}$ " flathead wood screws, $\frac{1}{2}$ " wood buttons, double-faced tape, stain, clear finish.

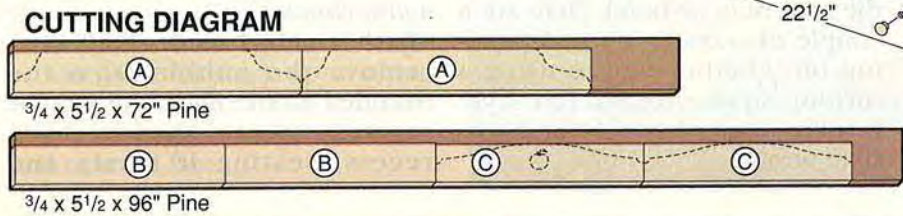
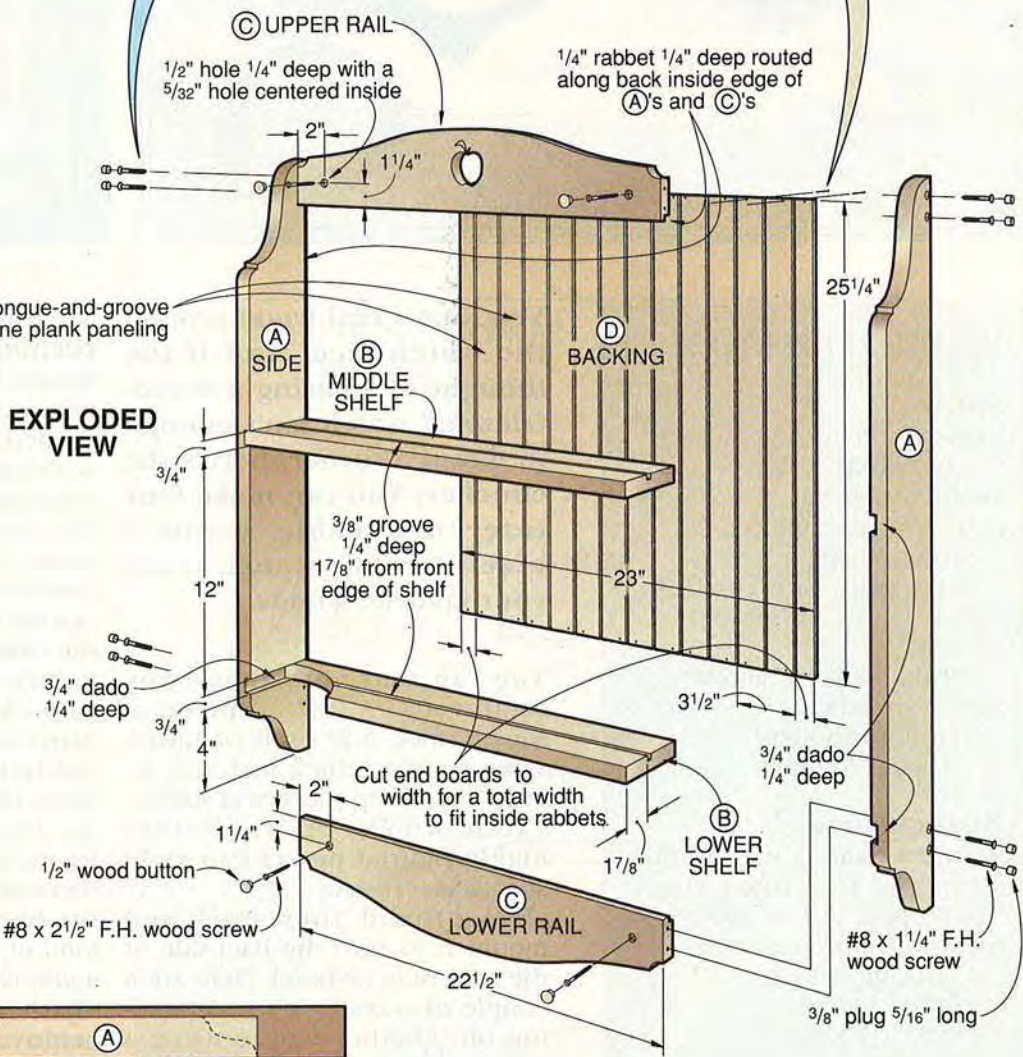
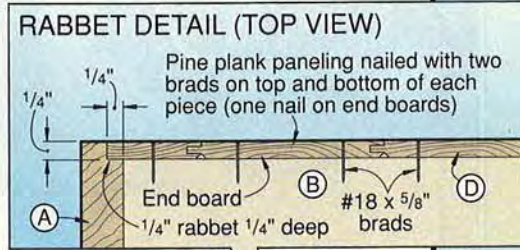
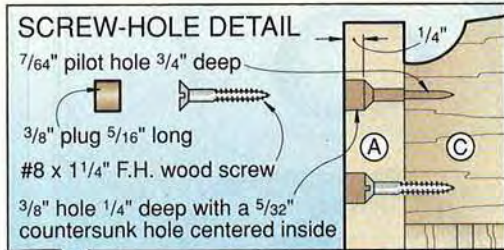
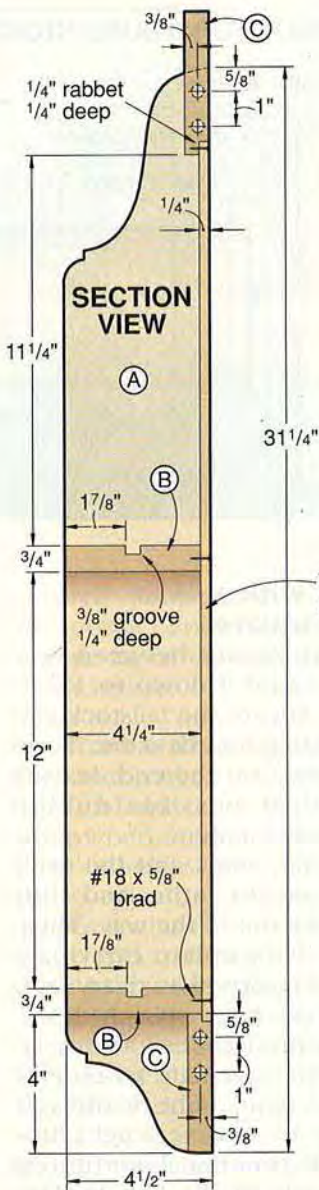
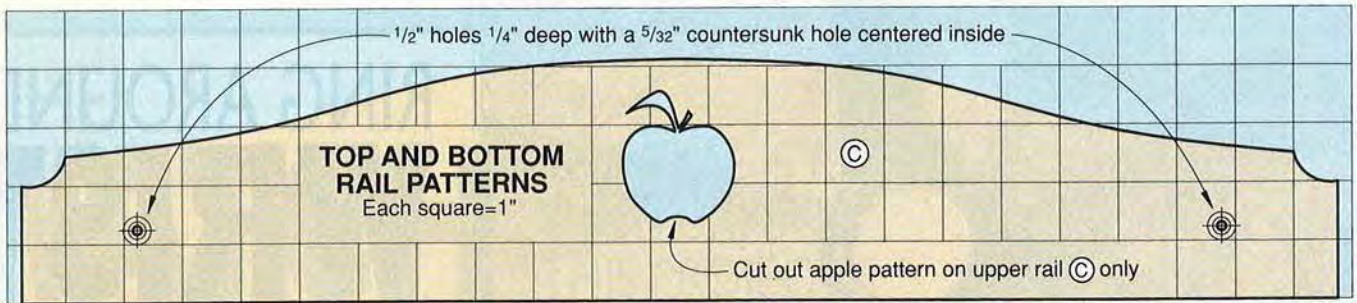

RING AROUND WRIST

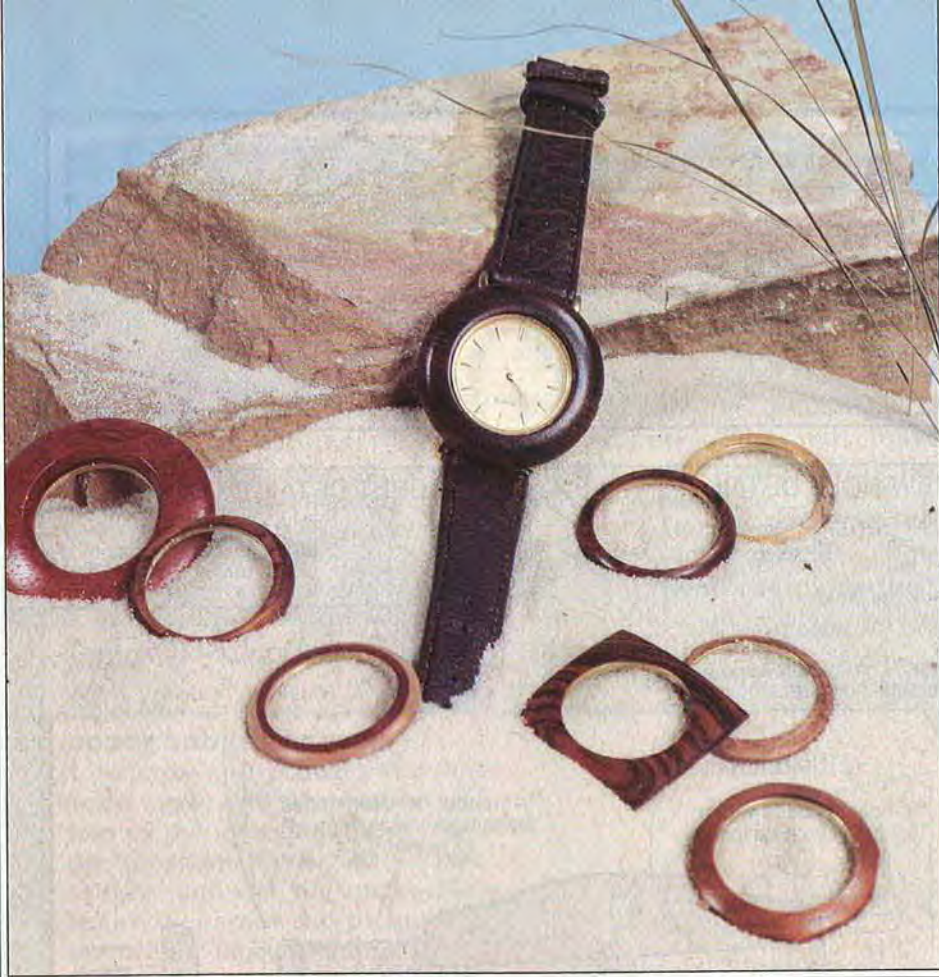

JAM CHUCK FOR ROUND STOCK

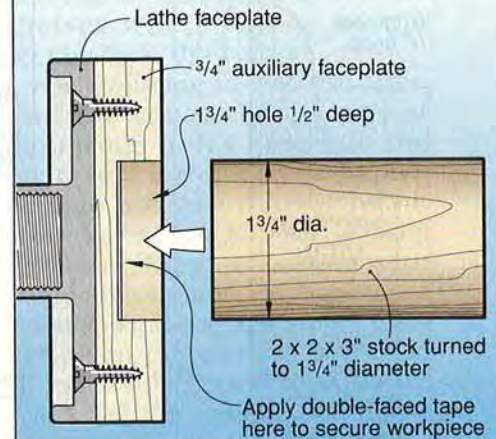

WE USED THESE TOOLS AND SUPPLIES:

Stock

Miscellaneous scrapwood
(see text)

Lathe tools

Drive center, tail center
Screw center
3" faceplate
Gouges $\frac{5}{32}$ ", $\frac{1}{4}$ ", and $\frac{1}{2}$ "
Skew $\frac{1}{2}$ "

Parting tools $\frac{1}{16}$ " and $\frac{1}{8}$ "

Lathe speeds

Turning, sanding
1100-1400 rpm

Buying guide

• **Quartz watch** with leather strap and four brass rings, \$26.95 ppd. in U.S. Add \$5.50 for wooden presentation case.

Craft Supplies USA,
1287 E. 1120 S.,
Provo, UT 84601
Or call 801/373-0917

Yep, that's real wood around the watch face. And if the thought of wearing a wood-trimmed watch isn't enough to tempt a turner, here's the clincher: You can make four interchangeable wooden bezels for this watch, using your favorite woods.

You can start with almost any scrapwood. A 2x2x3" piece of square stock, a 2" circle or square sawn from $\frac{3}{4}$ "-thick material, or even a glued-up piece will suffice. Exotic woods, burls, or other highly figured pieces can yield spectacular results.

First, round your stock and mount it to turn the backside of the trim ring, or bezel. Here are a couple of ways to start, depending on whether you're using a turning square for spindle-style turning or plank stock for bowl-style turning.

To start with a turning square

Mount the square between centers and round it down to $1\frac{3}{4}$ -2" diameter. Square the tailstock end with a parting tool or skew. Form a flat surface on the end, leaving the smallest possible nubbin under the tail center.

Remove the stock and the drive center from the lathe, and slide the tailstock out of the way. Then, mount a 3" faceplate carrying a $\frac{3}{4}$ "-thick scrapwood auxiliary faceplate. Gouge-cut a straight-sided, flat-bottomed recess about $\frac{1}{2}$ " deep in the faceplate to receive the round stock. Check the size frequently to achieve a tight fit—this will be your chuck for turning the backside of the bezel. (This kind of friction-fit fixture is called a *jam chuck*.)

With a chisel or dovetail saw, remove the nubbin from the rounded stock. Slide the stock's squared end into the jam-chuck recess, seating it firmly and

THE WATCH

THE TIME IS RIGHT FOR TURNING THIS PROJECT

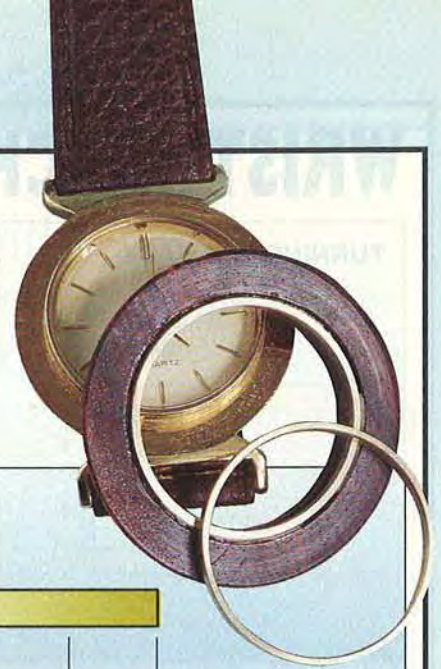

FACEPLATE FOR FLAT STOCK

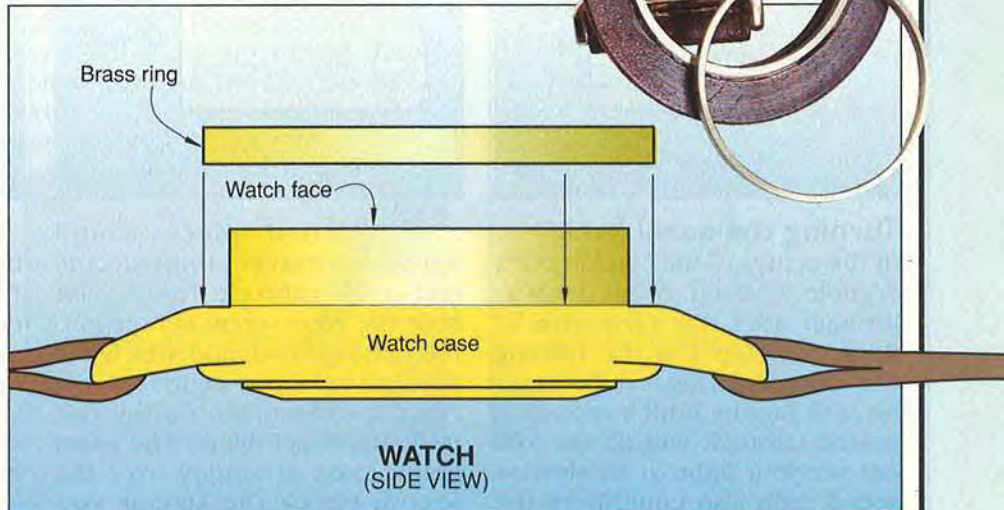
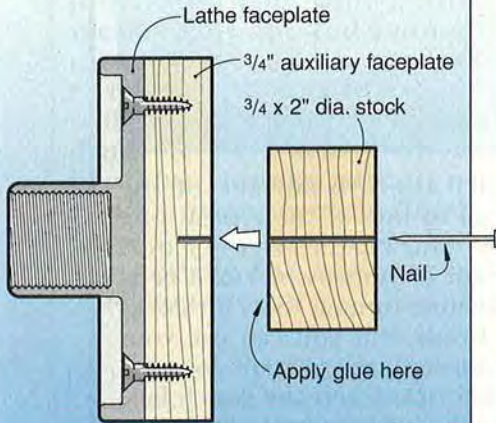

squarely, shown *above left*. If friction doesn't hold it securely, place double-faced tape in the bottom of the recess.

To start with a flat blank

For stock sawn from a board or a bowl blank, attach a $\frac{3}{4}$ "-thick scrapwood auxiliary faceplate to your lathe's 3" faceplate. Mount the faceplate and true the surface.

At the center of the auxiliary faceplate, drill an index hole about $\frac{3}{8}$ " deep to fit an alignment pin such as a 16d nail, a scrap of $\frac{1}{8}$ " dowel, or a drill-bit shank, shown *above*. (We used a twist-drill bit in a Jacobs chuck mounted on the tailstock.) Drill a hole the same size through the center of your stock.

Now, insert the pin to align the holes as you join the workpiece to the faceplate with cyanoacrylate adhesive. Double-faced tape works great for stock up to about $\frac{3}{4}$ " thick, too. Remove the pin. Turn the stock to $1\frac{3}{4}$ "-2" diameter, and true the face.

Continued

TYPICAL BEZEL PROFILES (ENLARGED)

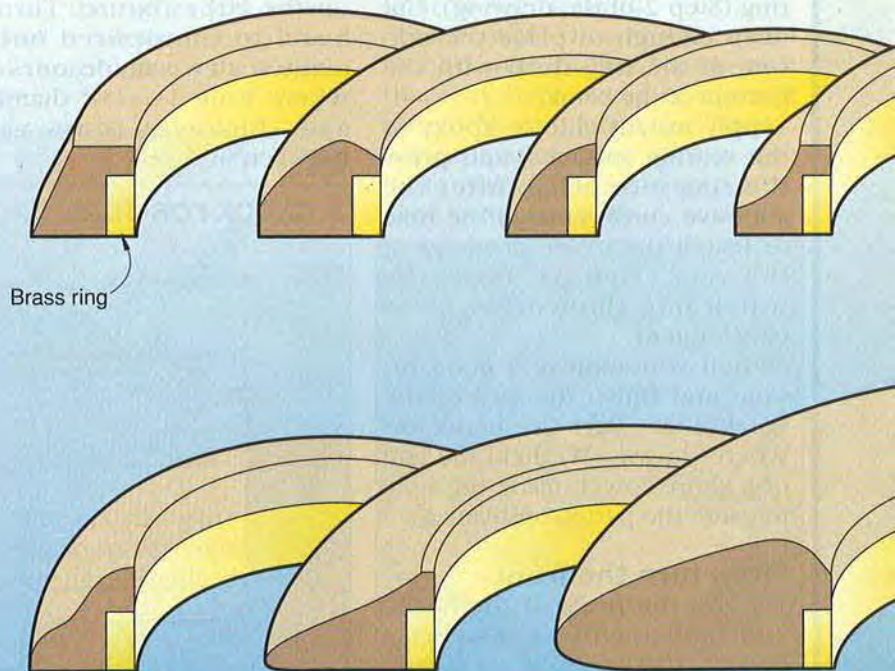

WRISTWATCH

TURNING THE BACK

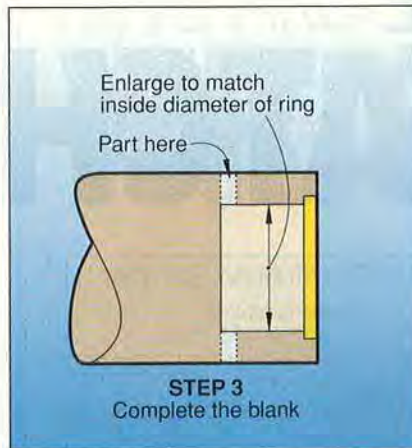
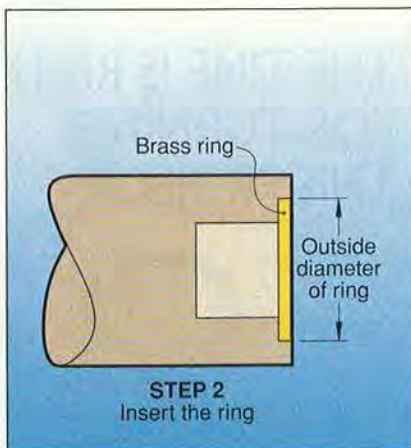
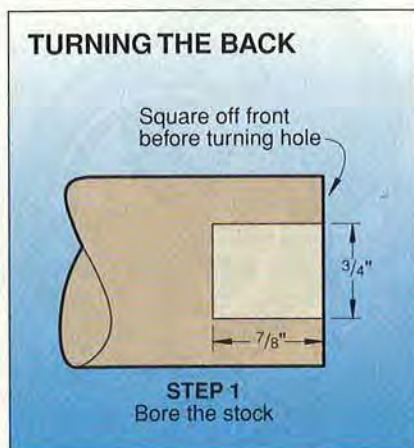

Turning the bezel back

In the center of the blank, bore a $\frac{3}{4}$ " hole $\frac{7}{8}$ " deep, or all the way through stock that's less than $\frac{7}{8}$ " thick (see Step 1 of the Turning the Back drawing). A Forstner bit and Jacobs chuck mounted on the tailstock will do the job, but set your lathe at its slowest speed. You also could bore the hole with a gouge.

Measure the outside diameter of the brass ring. Then, with a small gouge, enlarge the hole in the workpiece to form a seat for the ring (Step 2 of the drawing). Cut deep enough to place the bottom of the ring flush with the bottom of the blank.

Apply instant glue or epoxy to the seating surfaces, and press the ring into place. After the adhesive cures, enlarge the hole to match the inside diameter of the ring (Step 3). Press the watch into the workpiece to check the fit.

When you achieve a good fit, sand and finish the end of the workpiece. Part the blank off where shown. (We held the end of a short dowel inside the hole to catch the parted-off blank.)

Now, turn the front

To turn the front of the bezel, you first need to construct a chuck fixture like the one shown *right*. To make one, turn

a scrapwood piece round between centers, and true the end at the tailstock. Drill a pilot hole for your screw center into the tailstock end, and attach the piece to the screw center.

Turn a short tenon on the end to fit the bezel blank. The bezel blank must fit snugly over the tenon; check the size as you work. A parting tool works great for this job.

Place the bezel blank over the tenon, seating the blank's bottom firmly against the shoulder on the lathe fixture. Turn the bezel to the desired outside diameter (we made ours anywhere from $1\frac{1}{4}$ – $1\frac{3}{4}$ " diameter) and thickness (ours varied between $\frac{1}{8}$ " and $\frac{1}{4}$ ").

Turn the top surface of the bezel to one of the typical profiles shown on *page 53* or a design of your own. You'll need miniature-turning tools for coves or beads, but you can use your smallest standard tools for convex forms. Insert the watch face into the hole to check the fit.

Sand the face of the bezel to 320 grit, and finish as desired. Press the bezel onto the watch. If it seems too loose, build up the inside of the brass ring with a thin application of instant glue. If the stem knob interferes with a wide bezel, carve a slight depression in the bottom of the bezel for clearance. To complete the set, turn three more bezels in different woods or styles. ♣

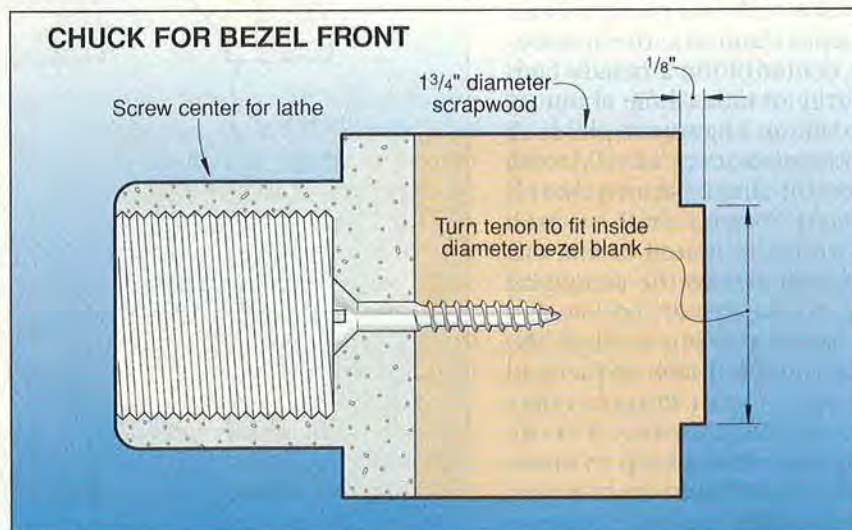

One good way to deal with **GLUE SQUEEZE-OUT**

When you clamp together glued pieces, you should see some glue oozing out at the joint line. This squeeze-out means you applied enough glue to ensure a proper bond. But, if you don't control and clean up this excess glue, it will show up as blotchy marks after you apply a stain or clear finish. Here's a simple procedure for putting the squeeze on glue squeeze-out.

By properly applying the glue, you'll save yourself a lot of cleanup later. First, lay down a bead of glue on both mating surfaces. With a small brush, spread the glue into a thin, uniform layer as shown *below*. (We use the disposable acid-flux brushes available at most hardware stores.)

Allow the glue to sit at least 30–45 seconds before clamping the pieces together. This way, the glue sets up slightly, more of it soaks into the workpieces, and less oozes out of the joint.

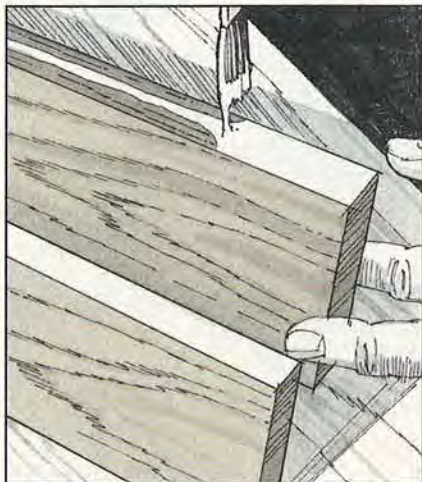

2 Immediately scrape up the excess glue with a putty knife, being careful not to spread it to adjoining areas. Slightly round the corners of the knife to prevent scratching the wood surface.

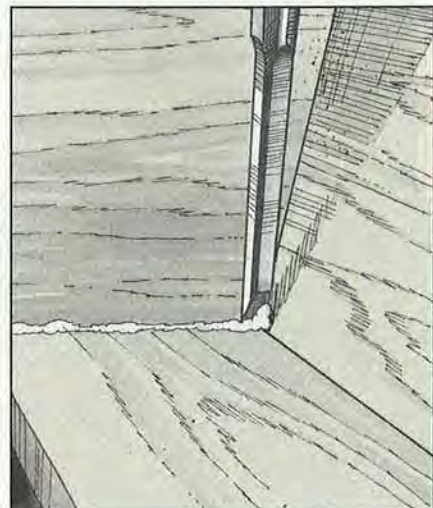
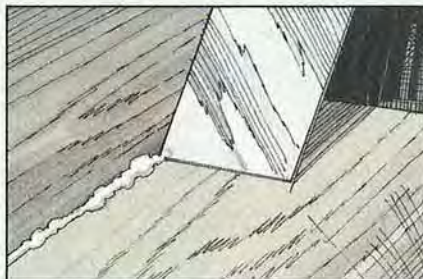

3 Wipe up the glue with a wet rag. Have the rag ready ahead of time so that you don't waste any time between the previous step and this one. Be sure to roll the rag as you wipe, and refold it frequently, so that you don't spread glue onto adjoining areas.



5 Sand the affected areas to remove any remaining traces of dried glue. It often helps to wrap the sandpaper around the tip of a putty knife as shown *below*.

Then, wait five minutes and recheck your project for any glue that may have oozed out during your cleanup efforts. Finally, wipe the joints with mineral spirits to reveal any remaining glue. Sand as necessary. ♣

4 To get the glue out of tight spots, such as the corners inside drawers, scrape it out with a chisel, awl point, or slotted screwdriver tip. Again, be careful not to gouge the wood surface.





READ THE OPERATOR'S MANUAL AND UNDERSTAND ALL SAFETY INSTRUCTIONS BEFORE YOU OPERATE THIS MACHINE.

Wood-Mizer®
LT30 G18

SET-UP PROCEDURES FOR SLOPING TERRAIN



CAUTION

CAUTION

DANGER

THE WOOD® GANG

GOES LOGGING

FELLING TREES AND SAWING BOARDS TAKES A LOT OF HARD WORK, BUT IT'S GREAT FUN, TOO!

Have you ever dreamed of milling your own wood-working stock from a tree that you cut down in the forest? At **WOOD®** magazine we did, so one day last winter we made it reality.



Dave Mann, left, and Bill Krier lead the log bearers up the hill to within reach of the tractor's cable.

Our vehicles fell in—convoy-like—to roll across the 20-acre pasture to the hardwoods. Startled, the farm's half-dozen horses and a donkey trotted toward more distant forage.

For us, the brief and bouncy ride on a gray late-winter morning was the first leg of an adventure in raw woodworking. All of the magazine's staffers who first showed interest were there. Counting Greg Wood, who owned the land (and the trees), his father, Clayton, Dave Mann and Burl Tichenor from Wood-Mizer, we numbered nine. Plenty of labor to handle the trees that Jim Harrold and I had selected earlier in the week.

"Who's experienced with a chain saw?," Jim Harrold shouted after we had parked our vehicles at the wood's edge. Editor Larry Clayton didn't bother to raise his hand. He simply grabbed one of the well-used tools we'd brought along and asked for directions to one of the trees.

It was barely nine o'clock. The morning wasn't bright, but it was warm, at least for early March in Iowa. We'd all dressed in comfortable layers, suspecting that the forecasters predictions for an afternoon cold front would come true. And it did, right on schedule. A month earlier and we would have frozen. February in Iowa this year was particularly cold. A month—or even weeks—later the ground would have turned to the muck of a spring thaw, making logging on Greg's hilly farm just

Continued

When Wood-Mizer's sales manager, Dave Mann, spoke of milling boards from a log, he ignited the glow of interest. The editors around the conference table nodded their heads.

The occasion was a product presentation early last winter by the Wood-Mizer company of Indianapolis to the **WOOD** magazine staff. Wood-Mizer makes portable bandsaw mills and markets them around the world. But they've always seen their product as a natural for woodworkers who want to use quality home-grown stock. A team that included Dave Mann, Bill Metzger, marketing manager, and Jonathan Shaw, a public affairs specialist, journeyed all the way to Des Moines to get the message across.

I remember editor Larry Clayton's enthusiasm after the meeting. "Hey," he said, "it would be really neat to get out from behind our desks and spend a winter day in the

woods! We'll find some good trees, fell them, haul them out, and saw them up! Then we'll share the wood." Larry's enthusiasm quickly spread to managing editor Jim Harrold, products/techniques editor Bill Krier, design editor Jim Downing, and me. The idea sounded great and before long the gang picked a day when we could head for the woods.

In writing feature articles, I've seen quite a few logging operations, and visited a number of saw mills. I even felled and sawed up a seemingly endless sea of trees for firewood when I relied on it for heat years ago in northern Wisconsin. But this was the first time I took part in actually making woodworking stock—from trees to boards.

Peter J. Stephano

Peter J. Stephano, Senior Editor

LOGGING

south of Des Moines nearly impossible. As it was, we slipped on bare ground, patches of ice, and clinging snow, but didn't sink in. As we found out, our tricky footing was perfect for skidding logs.

The whitest walnut in Iowa

Brrrrrupppp. Brrrrrupp. Pup, pup, pup. Larry had fired up the chain saw. Through the thin cover of locust and willow trees on my side of the gully I could see him on the other side, crouched at the base of a tall, leaning tree. A few of the other guys gathered out of harm's way, watching.

"That's a nice walnut, lots of clear wood," said one. "Yeah, that part's right, but it looks a lot like an ash," said another. "Hard to tell, the bark's alot alike," offered a third.

Brrrrruppp. Brrrrrup. The saw hummed. In a second, all doubt was erased. White chips began to fly. Then more. "She's coming down!" someone over by Larry yelled as I heard the crackling, and then the swish and pop of limbs hitting and breaking.

"That's the whitest walnut I've ever seen," Larry laughed when the thud of the falling tree was only an echo. "You're right, it's a white ash, and a good one," I confirmed, my words carrying the expertise I should have displayed when I picked out the tree a week earlier. After bucking (crosscutting into saw-log lengths), the clear part of the 20"-diameter trunk yielded four straight logs—two eight-footers and two sixes. It was a top quality tree.

In turn, I cut a fat black cherry that had potential for crotch-figured wood. (I left a good portion of stump and the smaller of its twin trunks on the hillside to remain as erosion protection.) Next, from the creek bank, Greg took an open-grown walnut that was edging past its prime. The clearest section of the walnut's trunk measured 18" for about 10'.

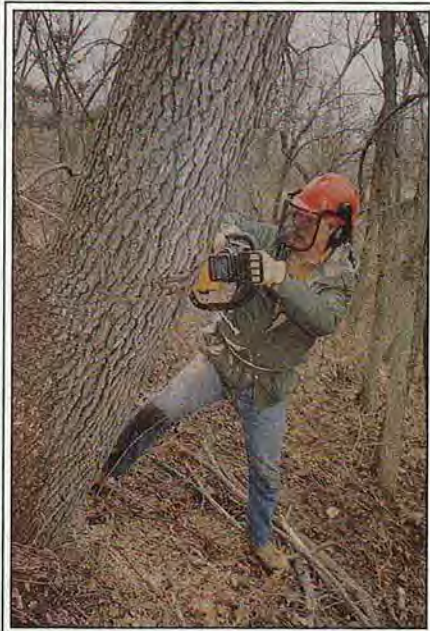

Secured on the hillside by a safety rope, Pete Stephano prepares to make the first felling cut on a black cherry tree.

To the growing harvest of logs, we added a small but straight hackberry tree that was crippled by the falling walnut.

We now had enough to saw up a sizeable stack of boards. We turned to limbing and topping the downed trees, a process that removes all the branches from the main trunks. Four chain saws buzzed, piling up stacks of future firewood for all who wanted it.

What logs hadn't been bucked were measured, marked, and crosscut. Now, the problem rested in getting them up the hill from the creek bed.

Logs to muscle up

"More cable!" yelled Bill Krier, the sweat trickling from under his blaze orange hunter's cap. Greg backed the tractor to the edge of the embankment. Hands pulled the cable toward the logs. "It's short," a voice called out.

Moving the logs to within the cable's reach so that they could be hauled up to flat ground was the day's endurance test. Eight-foot-long green logs can weigh as much as a grand piano!

By turning, prodding, levering, and flipping them end-for-end, our gang of eager, although inexperienced loggers got the saw logs over and out of the creek bed. Still, they lay beyond the cable.

"Let's carry them, on poles," suggested Dave Mann, explaining the procedure of slipping stout poles under each log, and then having a team of bearers lift and lug them one by one. Dave assured us that native loggers in the tropics moved logs that way when the terrain prevented the use of heavy equipment. The scheme worked.

Living lessons in grade sawing

With the logs finally at the open milling site, we caught our collective breath. The tough, intense logging—the felling, topping, limbing, bucking, carrying, and skidding—was over. It was 11:30 a.m.—time for lunch.

"I figure log scale at 441 board feet," announced Dave, glancing at his small notebook and the numbers scribbled there. I'd noticed him moving from log to log, recording the measurements of length and diameter that he took with his steel tape. A few weeks back when we'd scouted the trees, I'd unofficially calculated that they would yield about 380 board feet.

"Does that mean we'll get nearly 500 board feet from these logs?," questioned Jim Downing. Rising from his seat on an ash log, Jim looked at Dave's numbers, avarice in his eyes.

"That's International log scale," said Dave, "calculated by taking the diameter of the log's small end inside the bark and then figuring in its length." Then, to answer Jim, he added, "But that's figuring on cutting with a traditional circular-saw mill that takes a ¼" or better kerf. We'll get more, because the bandsaw mill is more efficient." How much more? We had to wait and see.

The time to start sawing was near. First, though, Wood-Mizer's Burl Tichenor gave us a walk-through on the sawmill and sawing technique.

Briefly, the Model LT30G18 before us (with some nice accessories, it sells for about \$11,000) sported an 18 hp engine to power its moving, cantilevered saw head with a .042"-thick (that's as thin as a credit card) bandsaw blade. The size of the log carriage, or bed, combined with the saw's throat capacity, meant that we could handle logs as large as 36" in diameter and 16'8" long. Of course, we didn't have any even close to that size. But the knowledge that we weren't underpowered was really quite comforting.

Burl passed out ear plugs and eye protection, and then started the mill. It purred like a riding mower. From the control board, he guided the head to lower the blade into cutting position for an imaginary log, and then set it into forward motion, slowly walking and talking behind the moving unit. We could tell that Burl was so familiar with the machine that he could probably saw wood with it in his sleep!

"Okay, let's do a log!" urged Jim Downing. He—like most of us—really likes power tools.

On our demonstrator mill, it was

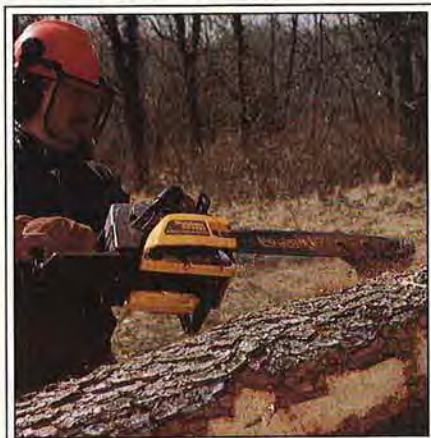

Using a short planer-blade attachment called a Log Wizard, Bill Krier clears a log of bark and dirt with a chain saw.

possible for one man to hand-winch a log into position on the saw bed with a steel cable. And we did the first one that way, just to see it work. But our crew represented enough manpower to roll a log up hand-over-hand and onto the machine in much less time. That's how we positioned all the others.

For teaching purposes, we chose one of the more diminutive ash logs as the leading candidate. In position—it's bone-white butt end on view from the operator end of the mill—it teased us with what lay under its bark. First, though, we had decisions to make, because there's more than one way to saw a log.

"Grade sawing," Burl explained, "means sawing from the best, or defect-free, side of the log. But it involves turning the log every so often to keep a clear face to saw from. It takes longer, but you get boards that are good and clear. And they're what's called flat-sawn lumber."

Then Burl talked about quarter sawing, which basically involves cutting the log in half, and then sawing each half vertically into boards, like slicing half a watermelon lengthwise. The result is very stable wood, and in some species, such as oak, a preferable grain pattern. The drawbacks are more sawing time, narrower boards, and a lower yield per log.

A third option was sawing through and through. This means slabbing off the rounded bark-bearing sides of the log, and then sawing up the resulting square, called a cant, without turning it. There's little effort involved, but the method lends itself better to softwoods. (See the illustration, *right*, for these sawing options.)

For the best boards in the amount of time we had available, we opted for grade-sawing. Our next decision involved the rough thickness of the boards.

BOARD SAWING OPTIONS

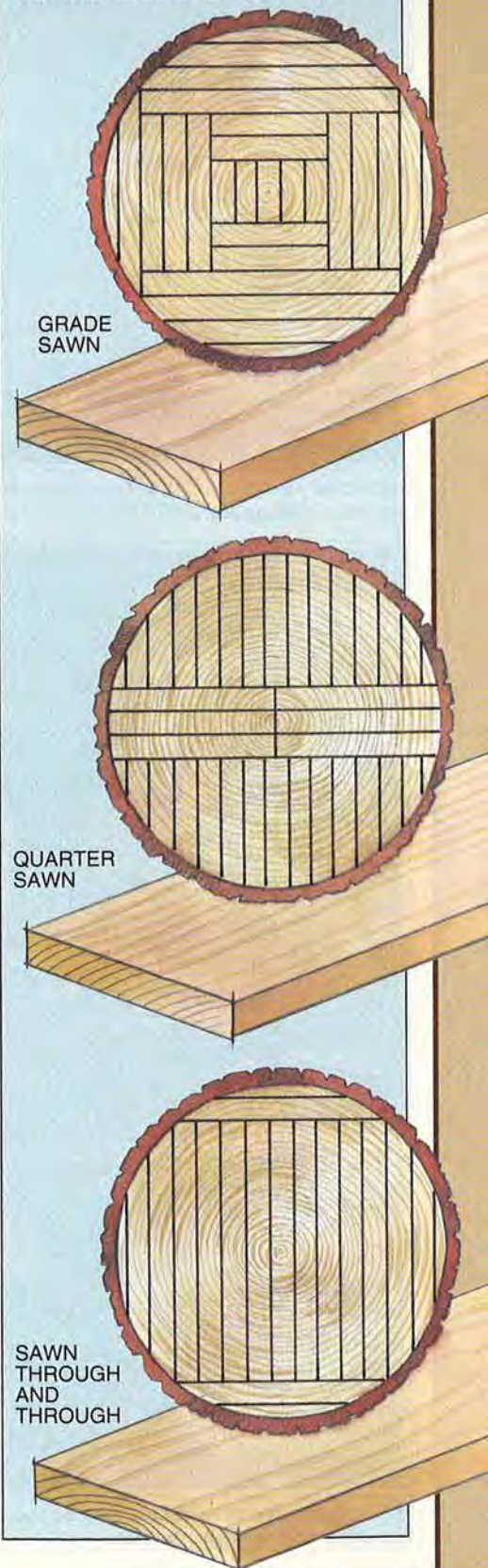

Continued

LOGGING



With four saw passes, Jim Downing will shape this log into a square cant. Then, he can start sawing for grade from the best, defect-free side.



While Jim Harrold inspects one of the first slabs of ash, Pete Stephano guides the bandsaw through another cut.

According to Burl, commercial hardwood mills traditionally saw boards to $1\frac{1}{8}$ " thickness. This allows for shrinkage and planing the wood smooth after it seasons. A bandsaw mill, however, leaves an impressively smooth surface on the rough-cut boards. That's why we decided to set the head to saw boards $\frac{1}{16}$ " thick. After seasoning and dressing, they'd be down to $\frac{3}{4}$ " with less waste.

Sawing into the sunset

There's something fascinating, even mesmerizing, about opening up a log and dividing it into boards. Jim Downing equates it with opening the pages of a big coffee-table book on color photography. "You never exactly know how much beauty will be on the next page," he said, in reference to the figure seen on each board waiting to be sawn from the cant.

Then, too, there's the precision, and the power. "Think of it," Jim said, "we're out here in a clearing, surrounded by woods and fields, with mud on our boots and sun on our faces, and here's this highly technical machine making perfect cuts, one after another. All you do is turn up the speed, and it slices effortlessly through a big ol' log." No one else said it better.

We left most of the sawing to Burl, our on-hand expert. That's because there just wasn't time for all of us to saw. Dave, Burl, and the Wood-Mizer would leave for home come morning. At that time of year, we only had light enough to mill logs until supper time, and there was a pile of them.

One after another—ash, more ash, cherry, walnut, more walnut, then hackberry—Burl worked through the logs we'd cut, hauled, and loaded onto the saw bed. Each board, off-loaded at the end of the cut, was a pleasure to look at in freshly sawn figure and feel in its heft. The lumber pile continued to grow.

Don't forget safety in the field

Logging may be one of the most potentially dangerous occupations around. But you can protect yourself with common safety sense and the following must-have equipment:

- Hard hat
- Hearing protection
- Safety glasses
- Heavy leather gloves
- Steel-toed boots
- First-Aid kit

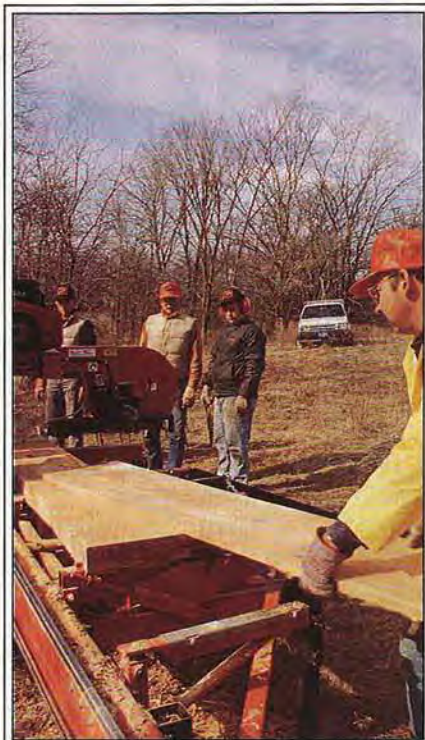

Jim Harrold discovered that off-loading freshly sawn, green boards was more work than cutting them on the mill.

It was nearly dark when we rolled the last log onto the mill. It was the little hackberry, and it went for stickers—the little 1" pieces used to separate layers of wood during air-drying.

In the light from a truck's low beams, Dave carefully tallied the day's yield. "We're over scale by about 50 percent," he announced. That means we'd cut 614 board feet instead of the 441 board feet estimated earlier, even subtracting the stickered hackberry (actually, we were 45 percent over). Not bad for a learning experience.

In a later issue of *WOOD*® magazine, we plan to follow this story with one on building a kiln and drying the boards we sawed that day. In the meantime, we'll let our neat stack of ash, cherry, and walnut air-dry down on Greg's farm. That'll give us time to come up with a kiln plan. 🍄

Written by Peter J. Stephano
Photographs: Wm. Hopkins
Illustration: Mike Henry



The ash, walnut, and cherry in stacks represent only part of the 614 board feet we logged and sawed on a blustery day in early March.

What's out there in sawmills?

Basically, we used a Wood-Mizer bandsaw mill for our hands-on experience because they came to us with the offer to help with any story we might want to do on do-it-yourself lumber. We're glad they did, but should you

want to saw your own boards, we recommend looking into any of the machines produced by the manufacturers listed below. You'll find saws at several price levels, offering a variety of features and options.

Better Built Corp.
845 Woburn St.
Wilmington, MA 01887

Breezewood, Inc.
S. 4th St., P.O. Box 266
Reynoldsville, PA 15851

Kasco Manufacturing Co., Inc.
R.R. 3, Box 393
Shelbyville, IN 46176

Mighty Mite Industries, Inc.
P.O. Box 20427
Portland, OR 97220

Mobile Manufacturing Co.,
798 N.W. Dunbar Ave.,
P.O. Box 258
Troutdale, OR 97060

Sanborn Machine Co., Inc.
Box 29
South Waterford, ME 04081

TimberKing, Inc.
1431 N. Topping
Kansas City, MO 64120

Wood-Mizer Products, Inc.
8180 W. 10th St.
Indianapolis, IN 46214-2400

A toy train that's a puzzle, too

CHOO-CHOO

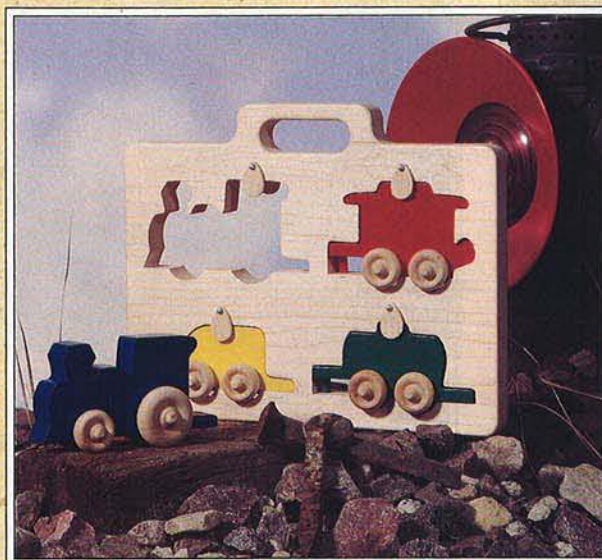
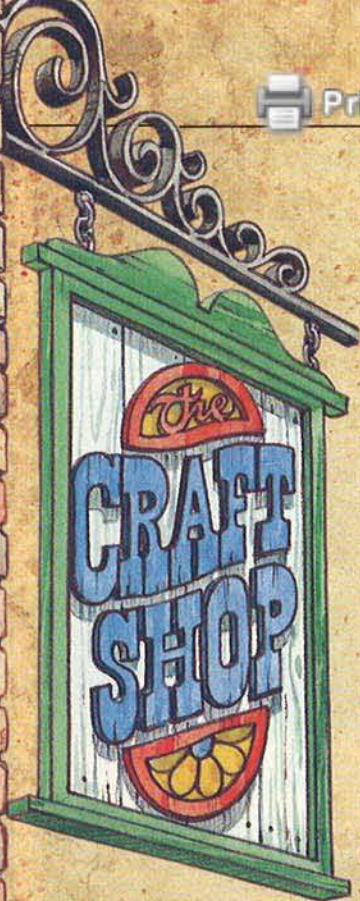

corners. Sand the outside and inside edges. Drill the four pilot holes through the carrier where shown. With a $\frac{1}{8}$ " round-over bit and table-mounted router, round over the inside of the handle opening and all outside edges.

Drill the holes for the axles and couplers through the train pieces where shown. Saw along the *black* lines on the train pieces. Cut three $\frac{3}{4}$ " lengths of $\frac{1}{4}$ " dowel, and glue them

Here's a trainload of play value. After a playtime journey, it's fun to fit the puzzle-like pieces back into the handy carrier.

Note: To build the train, you'll need 1 $\frac{1}{16}$ "-thick maple 5 $\frac{1}{4}$ "x12 $\frac{1}{2}$ ", 3 $\frac{3}{4}$ "x12 $\frac{1}{2}$ ", and 1x12 $\frac{1}{2}$ ", one piece each size. You'll also need 14 wheels 1 $\frac{1}{4}$ " dia., two wheels 1 $\frac{3}{4}$ " dia., toy axle pegs to fit the wheels, $\frac{1}{8}$ "-thick stock, and $\frac{1}{4}$ " dowel rod.

Clamp (but don't glue) the three pieces edge to edge with the narrowest piece on the bottom and the widest on top. Draw a vertical centerline on one side.

Photocopy the train patterns. Adhere them to the stock where shown, aligning the straight bottom line of each on a joint. Cut the patterns at the joints with an X-acto knife.

Separate the three boards. Bandsaw or scrollsaw along the

red pattern lines. (Use a $\frac{1}{8}$ " blade for bandsawing; for scrollsawing, install a #9 or #11 blade.)

On the top board, lay out the handle according to the Handle Detail. Bore the two 1" holes where shown, backing the stock with scrapwood to prevent tear-out. Cut the handle opening between the holes with a scrollsaw. Saw the outside profile.

Glue the three pieces together. Lay out and bandsaw the rounded

into the $\frac{1}{4}$ " coupler holes. Make eight retainers from $\frac{1}{8}$ " stock.

Finish-sand all parts. Paint the train with acrylic artist colors, and apply a clear finish. Shorten the toy axle pegs to 1" long, and install the wheels, taking care not to pinch or glue them. (To cut off the axle pegs, we made a jig like the one shown in the shop tip on page 15.) Then, install the retainers with #4x $\frac{5}{8}$ " screws, and put the train into the carrier. 🚂

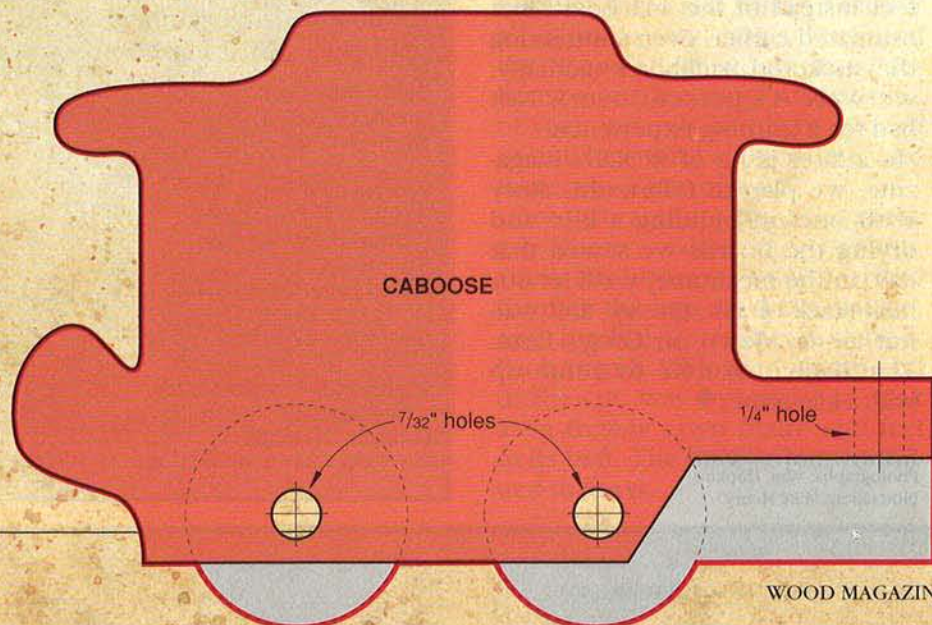

TO GO

FULL-SIZED PATTERNS

Project Design: © Quality Woodcrafters,
Gus Stefureac
Illustrations: Kim Downing
Photograph: John Hetherington

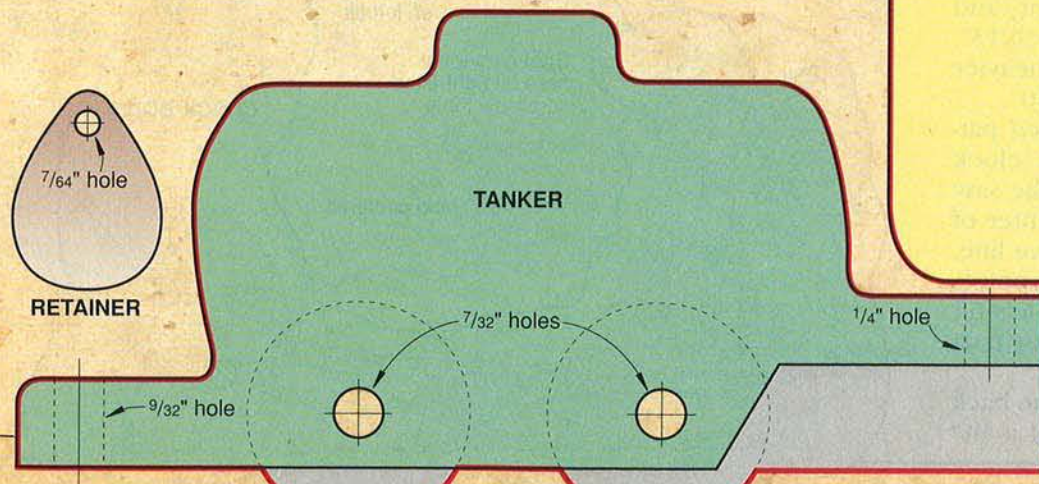
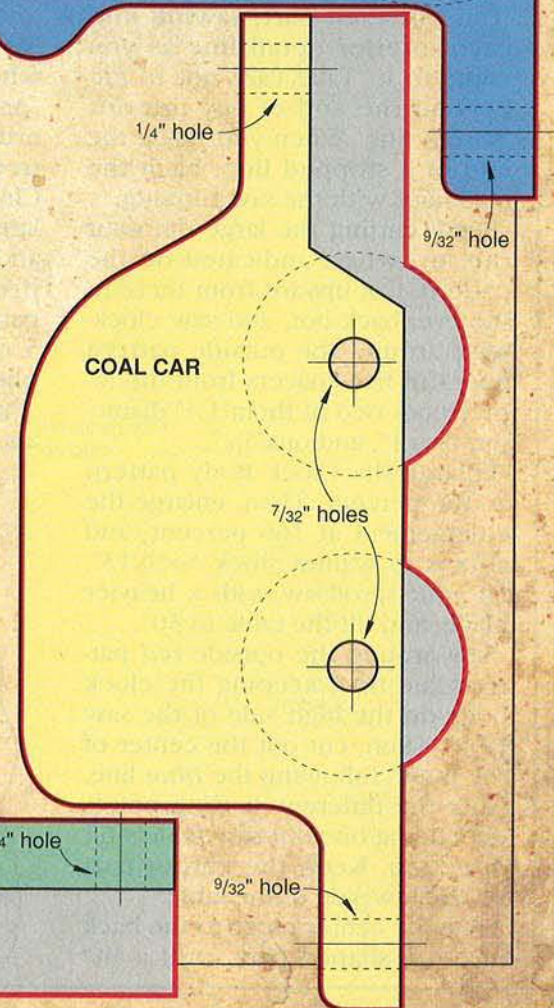
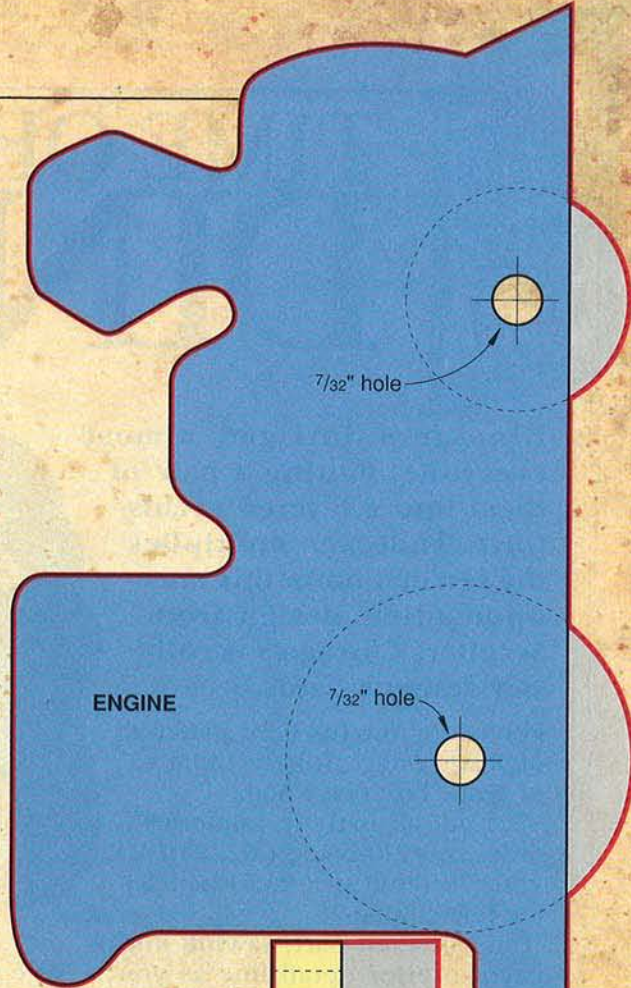
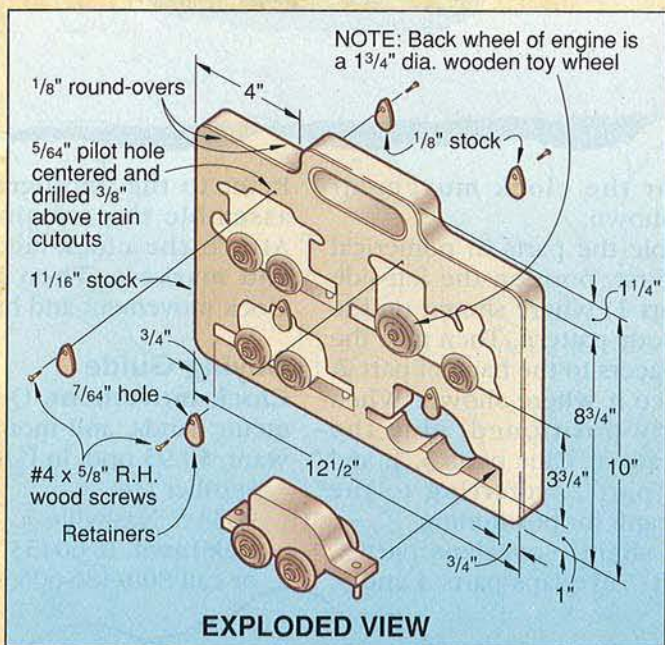
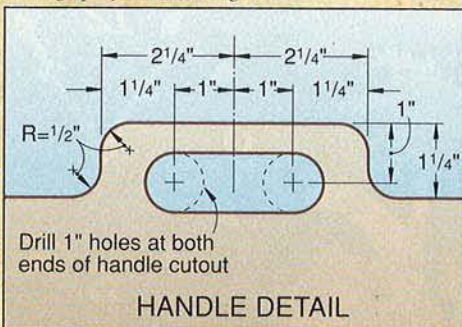
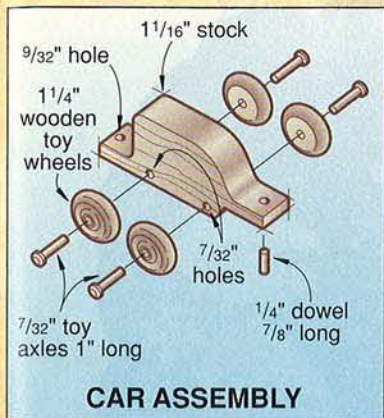

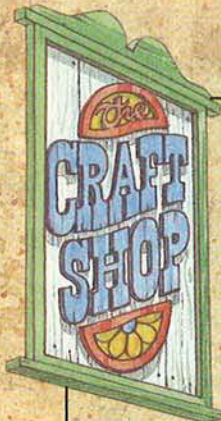

TIME OF THE DINOSAURS

Dinosaurs intrigue almost everyone. Putting a pair of them into a layered prehistoric landscape multiplies the fascination in this once-upon-a-time design from Scroller, Chicago's scroll-saw-design wizards.

Photocopy the full-sized patterns *opposite page*. Adhere them to $\frac{1}{8}$ " Baltic birch plywood.

Cut out all parts in numerical order. A #2/0 blade (.022 \times .010" with 28 teeth per inch) handles the fine cutting.

Cut out each part, sawing into each interior detail line as you come to it. Take care not to cut beyond the end of any interior pattern line. When you reach the end of a stopped line, back the blade out with the saw running.

Begin cutting the large dinosaur (no. 6), where indicated on the pattern. Cut inward from there to the eye, back out, and saw clockwise around the outside pattern line. Cut five spacers from the $\frac{1}{8}$ " plywood, two of them $1\frac{1}{2}$ " diameter, two 1", and one $\frac{3}{16}$ ".

Enlarge the Clock Body pattern at 166 percent. Then, enlarge the enlargement at 166 percent, and affix it to walnut stock $\frac{3}{4}\times 9\times 13$ ". Fit your scrollsaw with a heavier blade, and tilt the table to 30°.

Saw around the outside *red* pattern line first, keeping the clock body on the high side of the saw table. Then, cut out the center of the body, following the *blue* line. Note the different starting points depending on your saw table's tilt direction. Keep the cutout part on the low side of the table.

Glue the center piece to the back of the U-shaped part. Drill a $\frac{3}{16}$ "

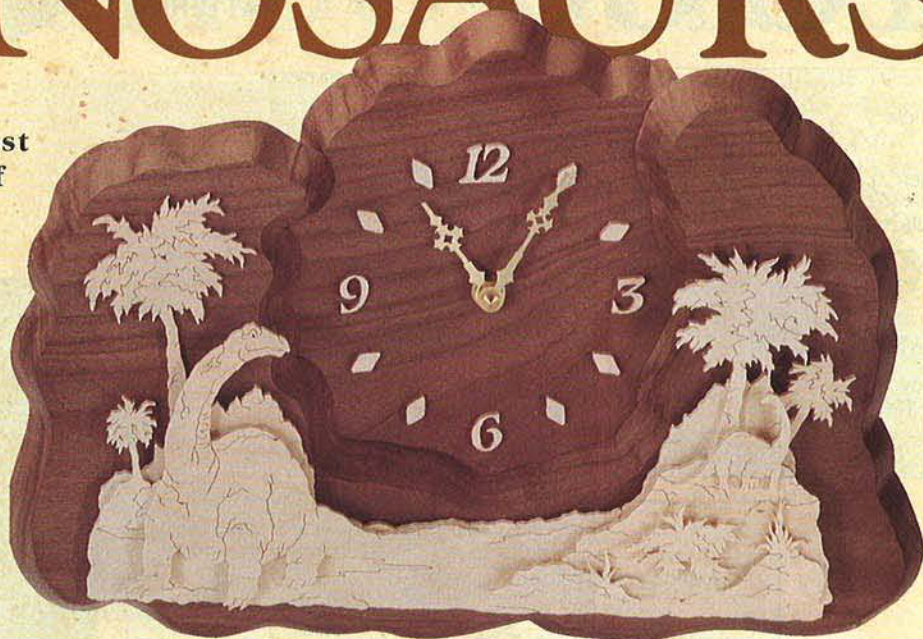

hole for the clock movement where shown.

Assemble the parts in numerical order. First, position the left-side tree (part 1) where shown on the Clock Body pattern. Then glue the large spacers to the back of part 2, and place it where shown. When properly positioned, glue the parts in place. Glue parts 3, 4, and 5 onto part 2, referring to the photograph for positioning.

Part 6 slightly overlaps part 3, and part 7 overlaps parts 4 and 5.

Refer to the photograph as you assemble the remaining parts. Attach the clock-face numbers and markers. Then install the clock movement and hands. ♣

Buying Guide

Clock movement. Quartz movement, hands, and mounting hardware, \$9.95 ppd. in U.S. Write:

Scroller Ltd,
9033 S. Nashville,
Oak Lawn, IL 60453,
or call 800/486-6053.

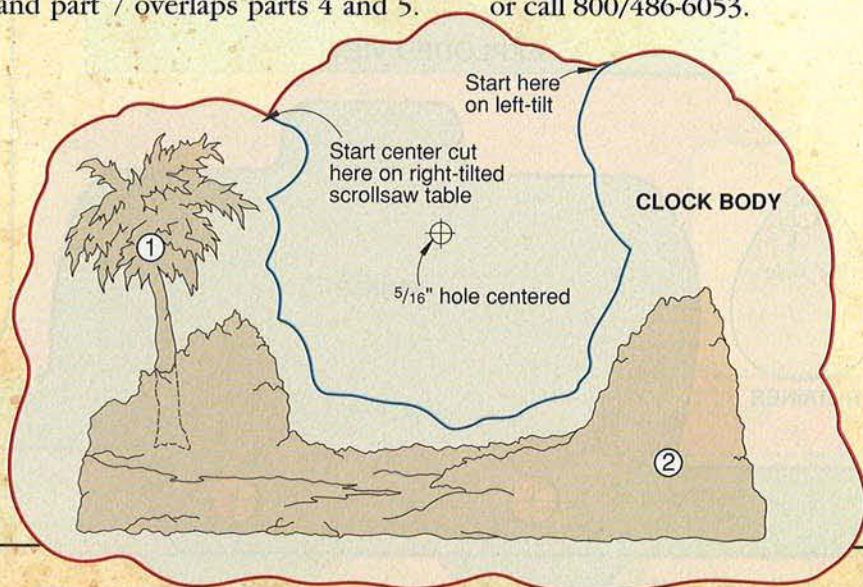

FULL-SIZED PATTERNS

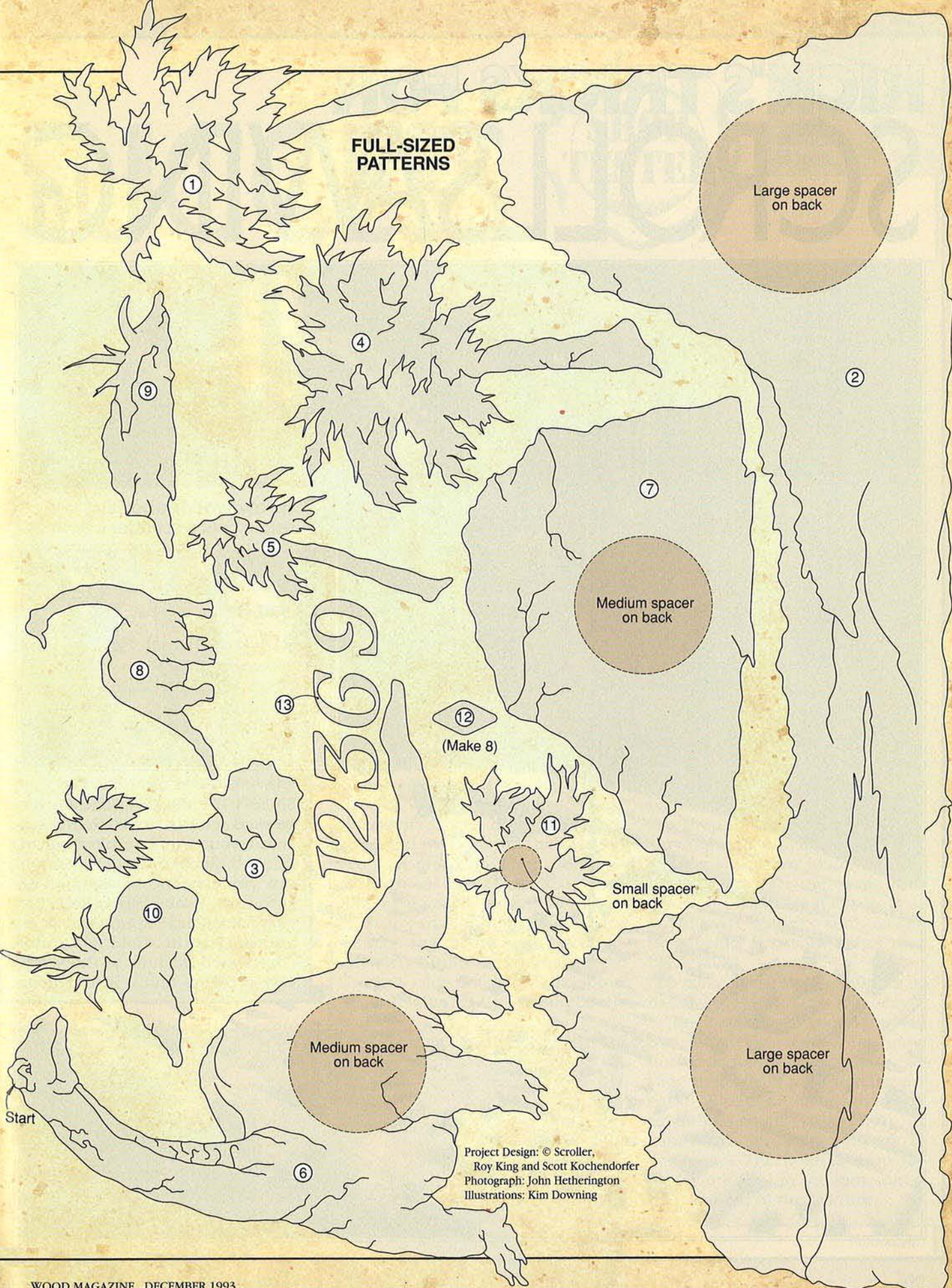

Project Design: © Scroller,
Roy King and Scott Kochendorfer
Photograph: John Hetherington
Illustrations: Kim Downing

RICK'S TRICKS FOR

 Print this article

SCROLLSAWING

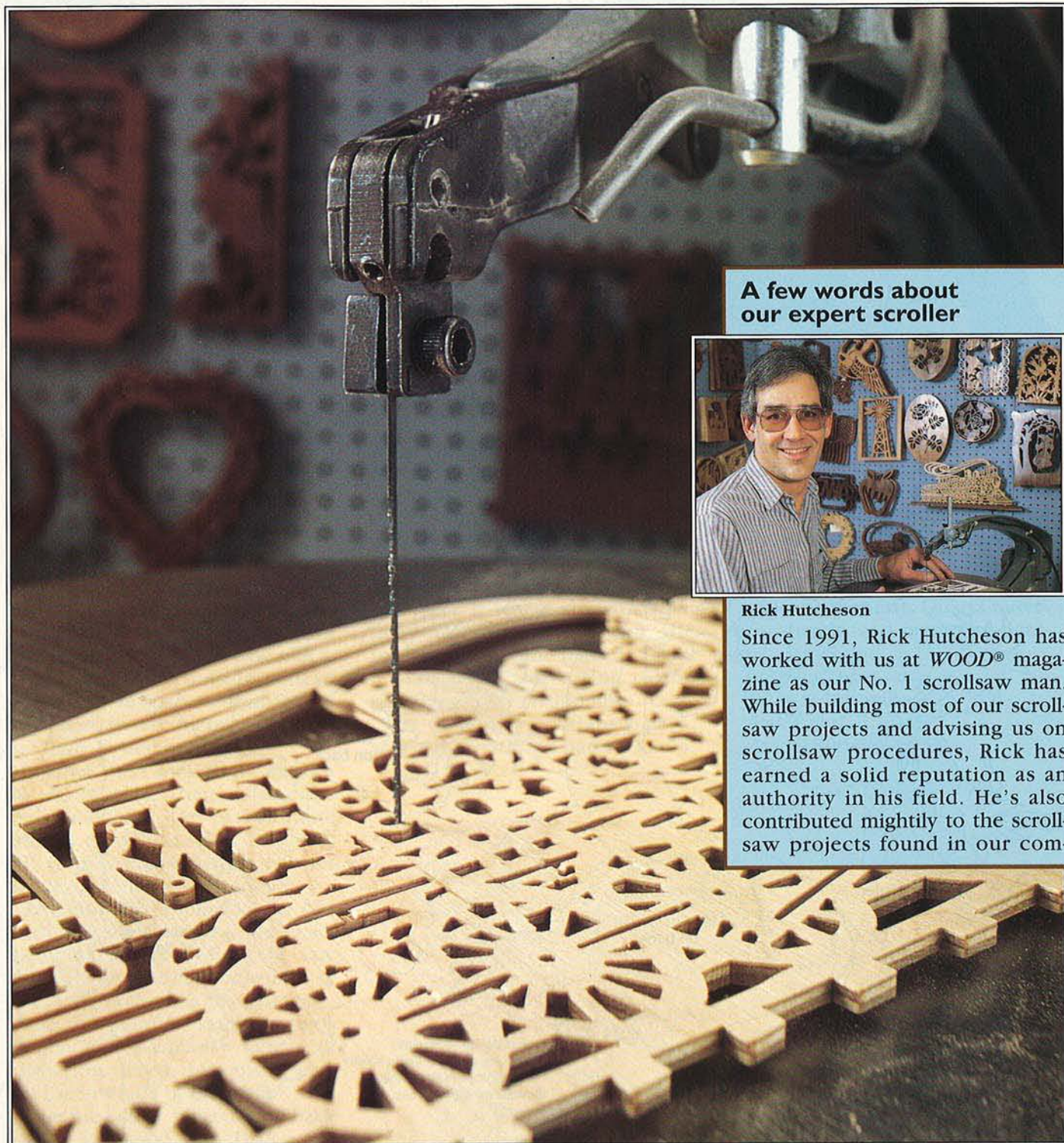

**A few words about
our expert scroller**



Rick Hutcheson

Since 1991, Rick Hutcheson has worked with us at *WOOD*® magazine as our No. 1 scroll saw man. While building most of our scroll saw projects and advising us on scroll saw procedures, Rick has earned a solid reputation as an authority in his field. He's also contributed mightily to the scroll saw projects found in our com-

SUCCESS



Rick's
Favorite
Blades

No. 9

No. 5

No. 2

When we decided to pull together our best collection of scrollsawing tips, we made a beeline to Rick Hutcheson's shop in Grimes, Iowa. We figured anyone who spends thousands of hours every year cutting scrollsaw designs has to know a lot about the craft.

panion publications, *Weekend Woodworking Projects*®, *Decorative Woodcrafts*®, and *Super Scrollsaw Patterns*®. When he's not working with us, Rick creates scrollsaw projects for his gift shop, or cuts unfinished pieces for people more interested in painting than sawing. To keep up with the demand, he spends 10-12 hours daily with his scrollsaws, putting out more work than most of us can produce in a week. No wonder a major manufacturer of scrollsaws supplies Rick with test models before introducing them to the market.

Although Rick saws his way through most projects in just a few minutes, he recently spent 3½ hours—a record-long time for this scrollsaw speedster—on a single workpiece. The project was the intricate locomotive (shown left), with more than 400 inside cuts. Whew!

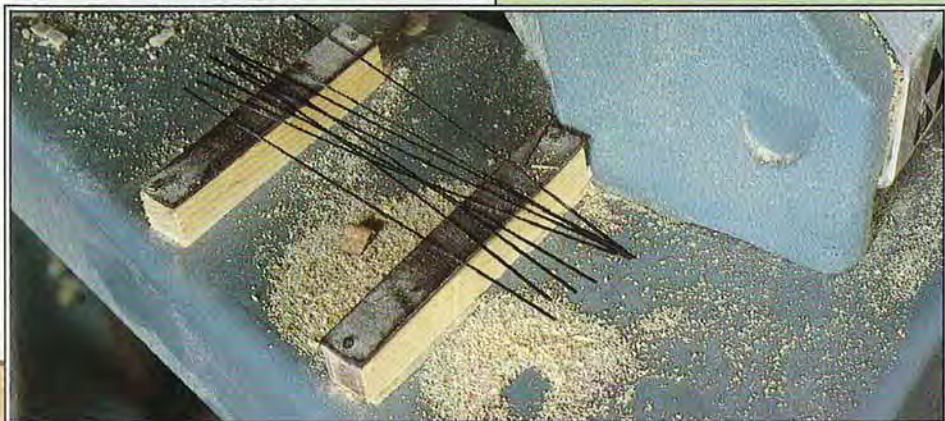

WHAT YOU NEED TO KNOW ABOUT BLADES

Three blades will see you through most projects

For nearly all of his work, Rick uses these blades from the Olson Saw Company:

•No. 5 (Olson no. 446-F)

"My choice (the no. 5) for ¾" pine, oak, walnut, and most other woods," Rick told us. "I've tried other blades, but none give you more blade life for the dollar."

•No. 2 (Olson no. 443-F)

I use this blade for cutting thin plywoods such as ⅛", ⅜", or ¼" baltic-birch plywoods," Rick said. "I cut a stack of plywood about ¾" thick, and with the no. 2 blade, I get good detail and a minimum of feathering on the bottom of the workpiece."

•No. 9 (Olson no. 450-F)

"This relatively thick and wide blade doesn't turn as tightly as the other two," Rick explained, "but you need its extra strength for sawing woods more than 1" thick. Primarily, I use it for 1½"-thick pine and fir. I can run this blade at 2000 rpm without a problem—the no. 5 blade heats up and breaks at speeds over 1750 rpm.

"You can buy other specialty blades that work well, such as jewelers blades for cutting metals. I don't care much for the spiral blades—they cut in all directions

as advertised, but leave a rough, bandsaw-like cut.

"You also can buy reverse-tooth blades with a few teeth at the bottom end that point up. This feature may reduce fuzzing on the back of a workpiece, but I've found that the reversed teeth slow my cutting rate by 30 to 40 percent. I'm usually better off by cutting fast and sanding the feathered grain later. But, these blades do work well on plywood projects with cuts requiring tight turns. That's because plywood feathers worse than solid woods."

Keep your blades nearby and handy

There's no getting around it: Blades will break or just become dull as you work on a scrollsaw. "I figure on a blade life of about 20 minutes maximum during hard cutting. Then, I need to change blades," Rick told us.

To keep these interruptions from slowing you down, you need to keep a supply of blades within easy reach. Over the years, Rick has found that home-made magnetic-strip holders such as the ones *below left* work better than blade racks.

To make these simple helpers he nails two 4"-long strip magnets to ½"-thick scraps of wood (you can buy magnetic strips from many hobby or hardware stores, or salvage them from junked refrigerators). Then, he attaches these assemblies about 3" apart near the base of his scrollsaw with epoxy or screws. The holders keep the blades oriented in the same direction, and out of the sawdust.

Continued

SCROLLSAWING SUCCESS

HOW TO ADD COMFORT AND PRODUCTIVITY TO YOUR SCROLLSAWING

Take a seat

As shown in the photo on page 66, Rick does his sawing from a sitting position. "Your body must be relaxed so you can concentrate on your hands and arms."

Consider a foot switch mandatory equipment

"I like to keep both of my hands free to control the workpiece," Rick told us, "and I haven't found a scrollsaw with a conveniently placed on/off switch. So, I use a foot-operated on/off switch. Once you try one, you'll be hooked."



Wrench padding takes the pain out of blade changes

Just as the grip on a baseball bat or golf club will help take the sting out of hitting a ball, wrapping the handle of a wrench will cushion the sudden snap of loosening a blade-clamp screw. Rick either wraps the handle with electrical tape, or slides a scrap of plastic tubing onto the handle.



PATTERN POINTERS TO KEEP IN MIND

Build your own collection of pattern templates

Rick makes templates for many of his projects, even if he builds only two or three units. "I'll probably make the project again

in the future," Rick said, "and templates are easy to trace around." He prefers plastic laminate for template material because it's thin and durable. "You can fit a lot of these inexpensive templates into a small box, and I've never worn one out," Rick added.

To keep things organized, Rick makes note of the source of the design on the back of the template. Then, he can refer to the source if he needs to brush up on the fine points of the project.

If you have a large collection of templates, Rick suggests you number them. And, keep a numbered listing of each template in a notebook, with comments about how long it took to complete the project, tricky cuts, or other construction pointers.

Nothing tops rubber cement for adhering patterns

I've tried sprays, tape, and other adhesives, but nothing works better than rubber cement," according to Rick. "It's cheap, fast, and holds the pattern firmly. It goes on without the hassle of tapes or the over-

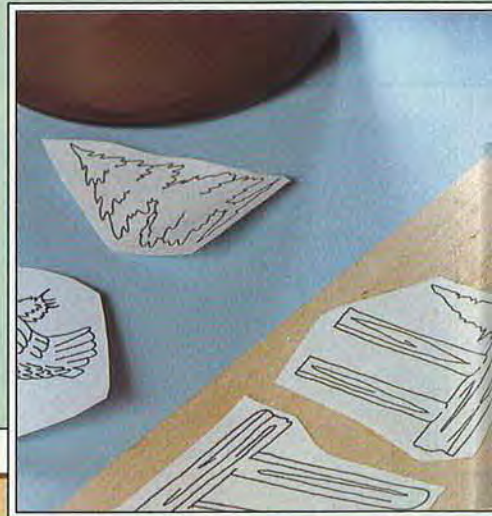

For good results you need to see your cut

Nearly all scrollsaws come with a blower for keeping sawdust off your outline. These work fine if you keep the blower nozzle near the point where the blade engages your workpiece, but Rick likes to keep the blower up and away from the workpiece. Most blowers still work at this height, but because they're powered by the up-down motion of the saw arms, they become useless when you slow down the saw speed.

To solve this dilemma, our intrepid scroller bypasses the saw's blower and hooks the blower nozzle to his air compressor via plastic tubing and a valve. If you don't have a compressor, Rick suggests that you hook the nozzle to an aquarium pump as shown *right*. (We placed the pump on the saw table for clarity's sake only. You should position your pump on the saw stand or another nearby surface that's out of your way.)

The easiest way to square up your saw table

Your saw's blade must be 90° to the saw table for most operations. Otherwise, you won't cut square edges, and will have difficulty making tight turns.

Here's a quick way to ensure square cuts. Make a 1/8"-deep cut into the edge of a 1/2"-thick piece of stock. Swing this piece around so the cut faces you and place the cut behind the blade as shown *right*. The back of the blade should fit into this kerf. If not, adjust your saw table accordingly.

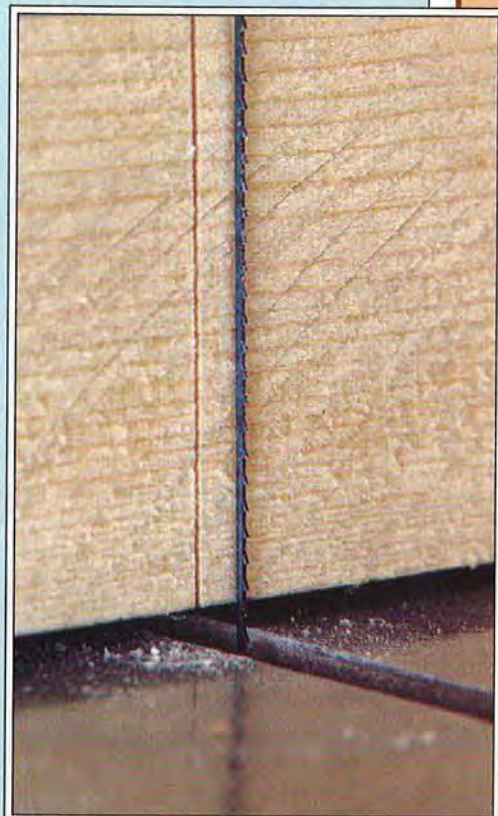

spray of aerosols, and cleans up in a jiffy. (See *page 71* for a nifty cleanup method.) I also work with a lot of tiny pieces, and sprays would blow them right off my workbench." For economy, Rick buys the cement in gallons and transfers it to jars.

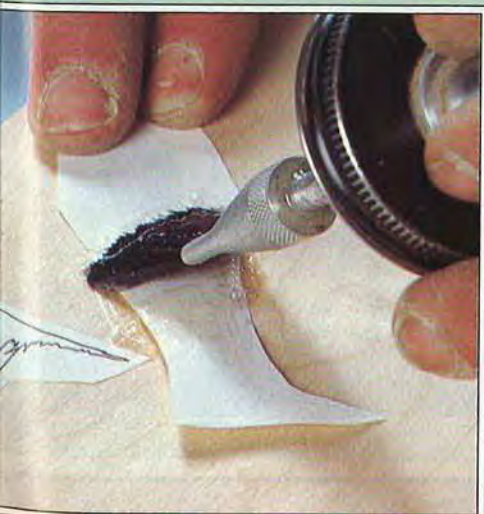

Buy no. 3 pine instead of no. 2

"I can buy no. 3 pine for about half the cost of no. 2, and for most small projects I get nearly as many workpieces out of the no. 3 stock as I get out of the no. 2 wood," Rick said. "I'll trace the large workpieces first, and then trace the smaller pieces onto the remaining clear areas."

As shown on the *left* side of the photo *right*, no. 3 pine has more knots, but you can work around these defects to utilize most of the board. In this example, a no. 3 board costing 50 percent less than the no. 2 board yields the same number of pieces in only about 30 percent more space.

Rick cautions that this thrifty measure may backfire if you're

working with large, knot-free cutouts. In that case, buy boards with large clear areas. You'll find the extra dollars well spent.

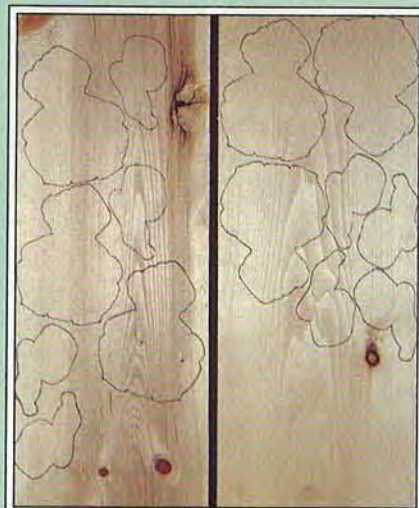

Continued

SCROLLSAWING SUCCESS

SECRETS OF SUCCESSFUL CUTTING

Keep your "save" piece to the right side of the blade

Because most manufacturers make scrollsaw blades by stamping them from thin sheets of steel, the teeth have a burr on their right side (with the teeth facing toward you and pointed down, as when secured in a saw). Because of this built-in burr, Rick keeps his "save" piece (the kept or project piece) on the right side of the blade. "I get more control over the cut this way, and I can make tighter turns," he told us.

As shown in the photo *right, top*, Rick attempted to make the same cut with the save piece to the right and left of the blade, as shown by the cutting-direction arrows. With the save piece to the left of the blade, he had to take a wider turn, and removed more material at the turning point.

The tiny burr also creates "feathering" of the wood fibers on the backside of the saved pieces. But, this feathering cleans up quickly later (see the *next page*).

Use your blade like a rasp

If possible, it makes sense to start a cut at a corner, such as the bottom of a heart or the points of a diamond. This helps prevent irregular cut marks that crop up when you enter and exit a cut on a continuous line. But, sometimes you have to start a cut in the middle of a line. Here's another time when Rick takes advantage of the burr on the right side of the blade.

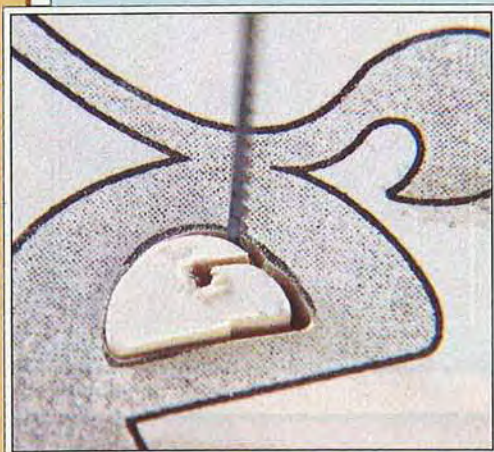
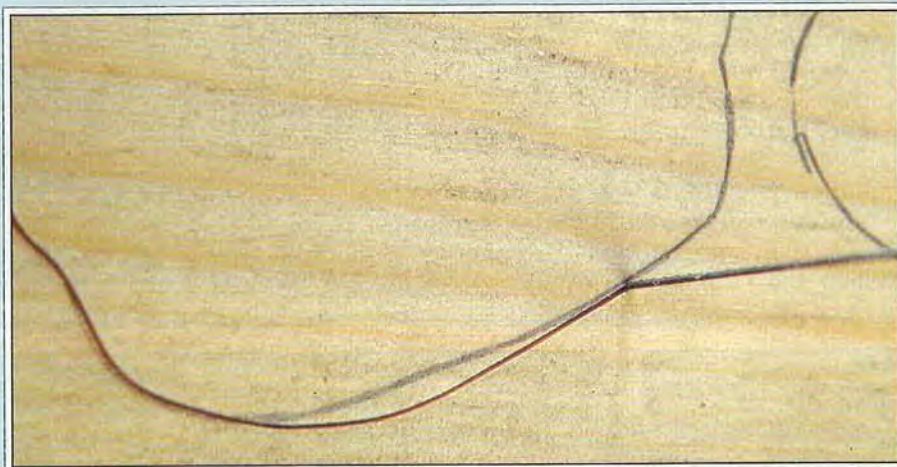
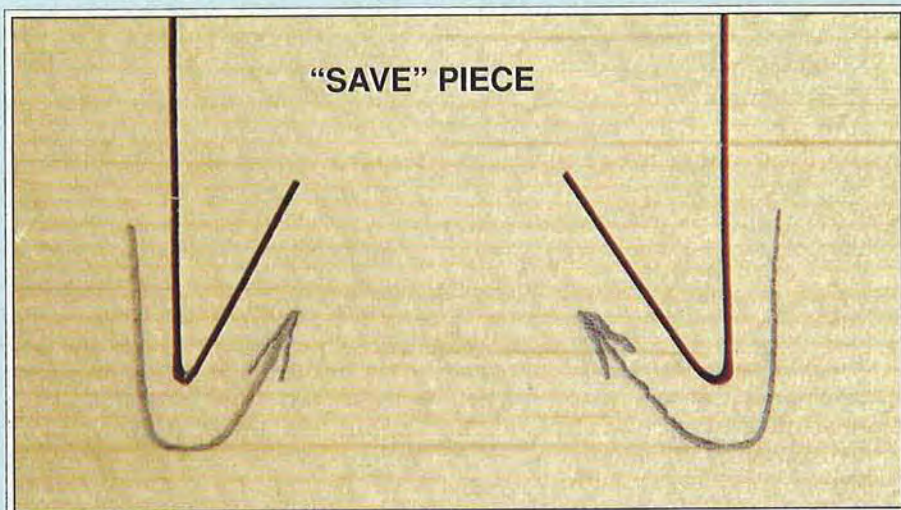

TRUSTWORTHY TRICKS FOR CLEANING UP PROJECTS

As shown on the *previous page, bottom left*, he uses the blade's right side like a rasp to smooth the start/finish point of the cut. To do this correctly, use the blade to sand, not cut, through the irregularity. "Let the burred side of the teeth do the work, and use the side of the blade as a guide to keep you from cutting into your save piece," Rick says. "If you try to cut away the irregularity you just may make it worse." This technique takes a second or two, and saves you from sanding or rasping by hand later.

It's no big deal if you go off the pattern line

For most designs, it's not critical that you follow the pattern line exactly. If you wander off the line, try to smoothly get back to the line as shown at *left*. "Nobody notices that I went off the line after I remove the pattern from the project," Rick said. "But, they may notice it if I try to correct by backing up and recutting.

"Of course, how far you can wander off the line depends on the size of the project. I can wander $\frac{1}{4}$ " off the line on a 10"-wide apple and nobody will notice, but wandering $\frac{1}{4}$ " on a 1" apple would look terrible."

Pile up time savings by stack-cutting

You can make multiple projects from thin materials in a snap by stack-cutting them as shown *left*. Rick stacks his thin materials to a height of $\frac{3}{4}$ ", and then adheres a pattern on top. Next, he secures the stack together with at least two #3 finish nails in a waste area.

"You can't allow the nails to stick out the bottom of the stack," Rick cautions. "So, I hold the stack on a steel plate when I drive the nails. This way, the plate peens the ends of the nails, and materials as thin as $\frac{1}{16}$ " won't fall off the bottom of the stack.

Fuzz-busting for first-rate looks

To remove the inevitable feathered grain on the back of a project, Rick places the workpiece facedown on a carpet pad and runs a finish sander over the back as shown *right*. A few passes with 120-grit abrasive cleans up the surface. The carpet pad holds the workpiece in place, and prevents marring on the faceside. On large projects, Rick may even use a stationary belt sander to complete this task.

A one-step way to clean the front of your project

"Rather than peel off my pattern, I save time and get better results by removing it on a stationary belt sander," Rick said (see photo *below*). "The paper does the same thing as pencil lines marked across a board—it shows you the high and low spots as you sand. When you sand away all of the paper, you know the surface has no more valleys and ridges." Rick keeps a crepe-rubber stick nearby to clean debris off the sanding belt. ♣

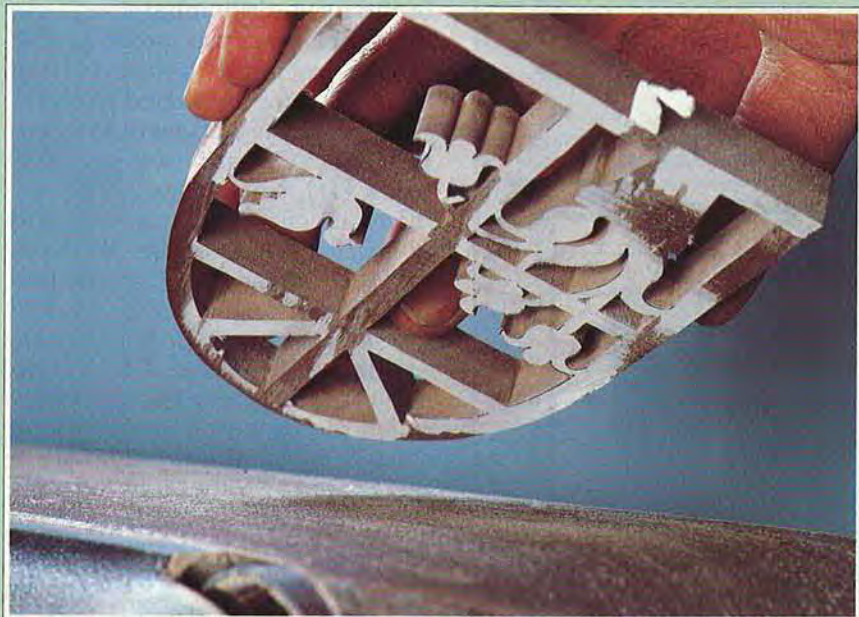
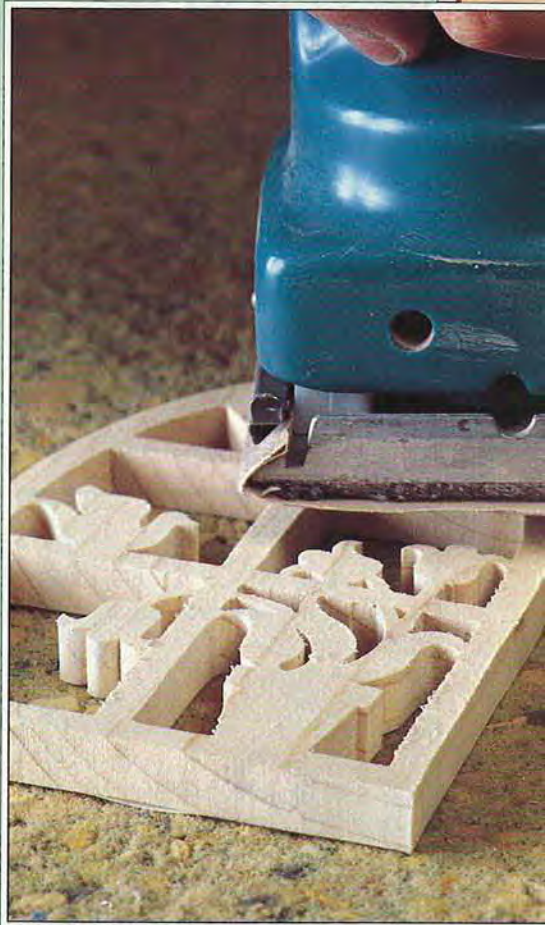

Written by Bill Krier with Rick Hutcheson Photographs: Jim Kascoutas

CRAFT A NUTCRACKER IN THE ORIGINAL STYLE

GREGORY THE

First, build Gregory's body

Enlarge the half-sized patterns on pages 74-75 to full size. Then, transfer the body's back and side views to the $2\frac{1}{2} \times 2\frac{1}{2} \times 3\frac{3}{4}$ " block (A). Bandsaw the body block to shape. Contour the body by tilting the bandsaw table to 45° and take off the corners. (See the shaded areas on the Back and Side View patterns.) Next, saw out the body cavity and the channel in the back. (See the Body detail.)

Roughly round the body block with a bench knife—don't carve on the belt. Drill a $\frac{1}{4}$ " hole $\frac{1}{2}$ " deep on both sides of the cavity in the top half of the body. (See the Exploded View drawing.)

Transfer the jaw lever pattern to the $1 \times 3\frac{1}{8} \times 7$ " stock (B) and saw out. With a $\frac{7}{8}$ " Forstner bit, bore a $\frac{1}{8}$ "-deep hole on the jaw. (See the Exploded View drawing.)

Now, heads up everybody

Transfer the side-view pattern for the head onto the $2\frac{1}{2} \times 2\frac{1}{2} \times 2\frac{1}{2}$ " block (C), and saw the profile. Draw a $2\frac{1}{2}$ "-diameter circle on top of the face block, beginning and ending at the flat area of the face, then saw along the line. Sketch the nose and remove wood on both sides. Tilt the bandsaw table to 45° . Saw off the shaded areas of the face and at the back of the head. (See the Front View and Side View drawings.)

Carve the face features. Then, refer to the front view of the face and drill $\frac{1}{4}$ " eye holes $1\frac{3}{16}$ " deep. At the center of the circle on top of the head, drill another $\frac{1}{4}$ " hole $\frac{1}{2}$ " deep, and two more of the same size in the bottom of the head. (See the Exploded View.)

To make the hat, mark the centers of each end of the 3×3 " block (D). Now, draw a $2\frac{7}{8}$ "-diameter circle on one end and saw it to round on the bandsaw, with the table tilted 5° . In the bottom center of the newly formed $2\frac{1}{2}$ "-diameter end, drill a $\frac{1}{4}$ " hole $\frac{1}{2}$ " deep and glue in a 1" section of $\frac{1}{4}$ " dowel. For the cockade, notch the back side of a $1\frac{3}{4}$ "-long section of $\frac{7}{8}$ " dowel as shown in the Exploded View drawing.

Next come the arms and legs

Transfer the arm and leg patterns to E and F, and saw out. Round their edges (refer to photo, *opposite page*) and shape with the

bench knife (except cuffs).

Drill $\frac{1}{4}$ " holes $\frac{1}{2}$ " deep in the top and bottom of each leg and in the inside top of each arm, as in the Exploded View drawing.

Get Gregory ready to march

Sand all the parts. Then, cut 1"-long pieces from a $\frac{1}{4}$ " dowel and fit them into the head, body, leg, and arm holes. (See the Exploded View drawing.) Next, dry-fit hat and body parts to check matchup of dowel holes. (We suggest using dowel centers for this.) Glue hat, head, and legs in place on body.

Position the jaw lever in the body cavity so that the front of the jaw aligns with the bottom of the face and flush with the chest. Holding the parts in place, use a $\frac{3}{32}$ " bit (or a bit the size of the nail) to drill a hole through the left side of the body, the jaw lever, and into the right side of the body. Remove the head and cut a no. 6 finish nail to 2" for the jaw lever hinge pin. (Don't install.)

Paint on the base colors of the hat, head, jaw lever, body, arms, and legs. Then, glue the arms in place, and insert the hinge pin and glue in place. Make the base and attach the nutcracker.

And now for the details

From a length of $\frac{1}{4}$ " dowel, cut nine slices $\frac{1}{16}$ " thick for buttons. Paint them and let dry. Paint the toy wheel axle hubs for the eyes.

Cut a $\frac{3}{4}$ " square buckle from $\frac{1}{8}$ "-thick scrap and paint. From scrap, shape, assemble, and paint the gun and sword as shown in the Gun Detail and Sword Detail drawings and patterns.

Now, finish painting, glue and attach the accessories, and add finishing touches, such as eye and face details, and craft fur. 🐾

Design: Glenn Crider
Drawings: Jamie Downing
Photograph: John Hetherington

WE USED THESE TOOLS AND SUPPLIES

Stock (See the Bill of Materials)

Bench knife

Bandsaw

Drill/drill press

Small parts

$\frac{1}{4}$ " \times 12" dowel rod

$\frac{7}{8}$ " \times $1\frac{3}{4}$ " dowel (or returned milk can)

three $\frac{3}{16}$ " toy wheel axles

No. 6 \times $\frac{3}{4}$ " brass nail

Craft fur

Braided ribbon

Sandpaper

Scrapwood

Woodworkers glue

Finishing supplies

Black, blue, brown, red, yellow, and white acrylic paints

Bill of Materials

Part	Finished Size			Mati.	Qty.
	T	W	L		
A Body	$2\frac{1}{2}$ "	$2\frac{1}{2}$ "	$3\frac{3}{4}$ "	P	1
B Jaw lever	1"	$3\frac{1}{8}$ "	7"	P	1
C Head	$2\frac{1}{2}$ "	$2\frac{1}{2}$ "	$2\frac{1}{2}$ "	P	1
D Hat	3"	3"	3"	P	1
E Arm	$\frac{3}{4}$ "	$1\frac{1}{4}$ "	$4\frac{1}{2}$ "	P	2
F Leg	1"	$1\frac{5}{8}$ "	5"	P	2
G Base	$\frac{3}{4}$ "	$3\frac{1}{2}$ "	$3\frac{1}{2}$ "	P	1

Material Key: P-Pine
(or other easily worked wood)

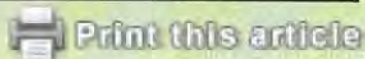

GRENADIER

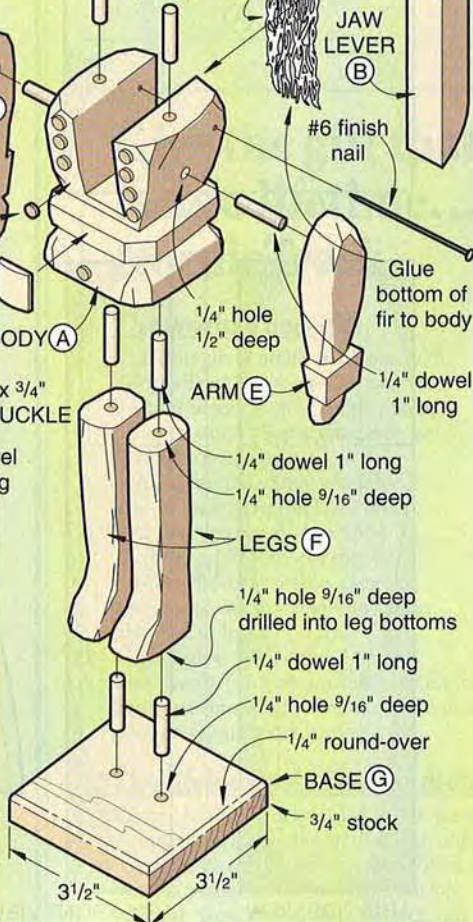
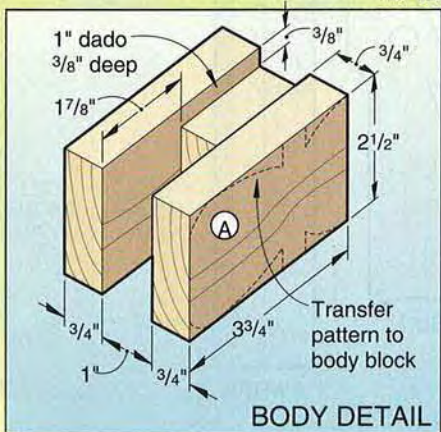
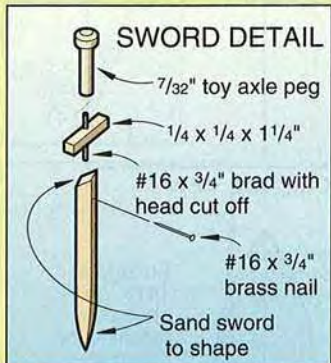
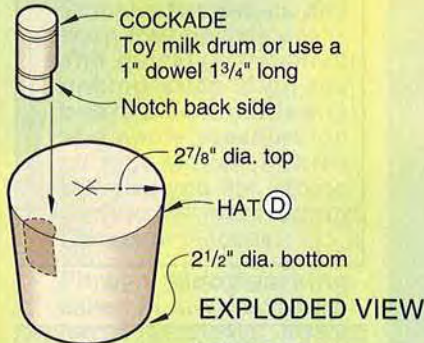
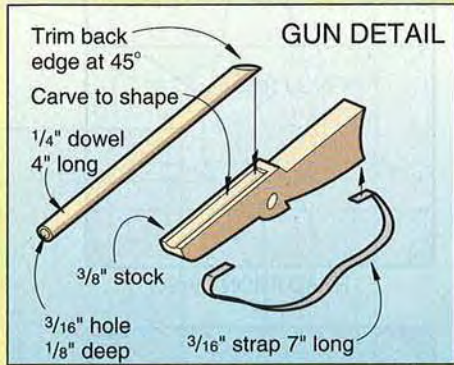

The Ultimate Woodworking Tool!



NEW! 1993-94 Catalog from The Woodworkers' Store Over 200 new, hard-to-find items!

YES! Send me the next four issues of The Woodworkers' Store catalog for only \$2 a year

Name _____
 Address _____
 City _____ State _____ Zip _____

The Woodworkers' Store
 Dept. 33115
 21801 Industrial Blvd.
 Rogers, MN 55374

VIDEO CATALOG OF HISTORIC SHIP MODEL KITS

Discover the world's oldest and most rewarding hobby... model ship building! Watch our 25-minute VHS video and learn the secrets of building museum quality wooden ship models. You'll see the finest selection of authentic ship models- superb replicas you build yourself- close up and in incredible detail. Even if you've never built a model before, you can create a magnificent keepsake to be treasured for many generations. Send \$5.00 for your video today! (Refundable with your first order.) **Free with your video!** 92 page color catalog of ship model kits and accessories.

MODEL EXPO, INC. Dept. WDC3
 P.O. Box 1000, Mt. Pocono Industrial Park,
 Tobyhanna, PA 18466-1000
 Enclosed is \$5.00, to be refunded with my first order.

Name: _____
 Address: _____
 City: _____ State: _____ Zip: _____

Item No. SST900C
 © Model Expo, Inc. 1993

Nutcracker

Continued from page 73

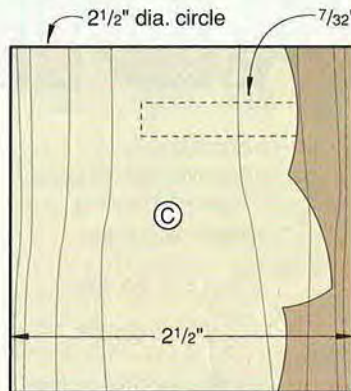

HEAD SIDE VIEW

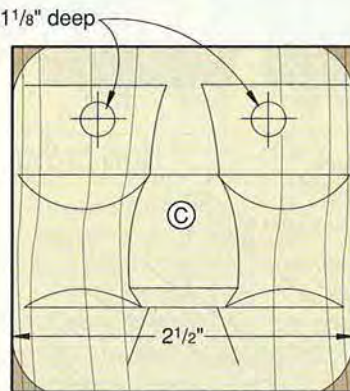

HEAD FRONT VIEW

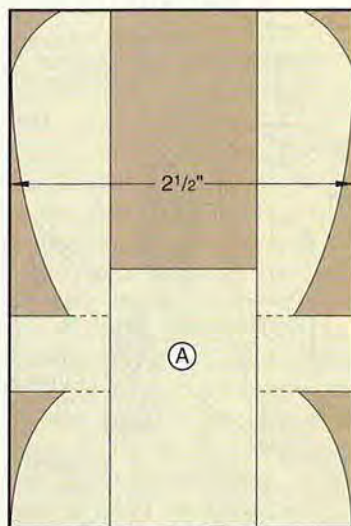

BODY FRONT VIEW

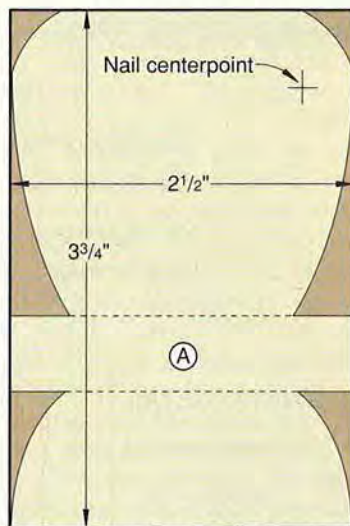

BODY SIDE VIEW

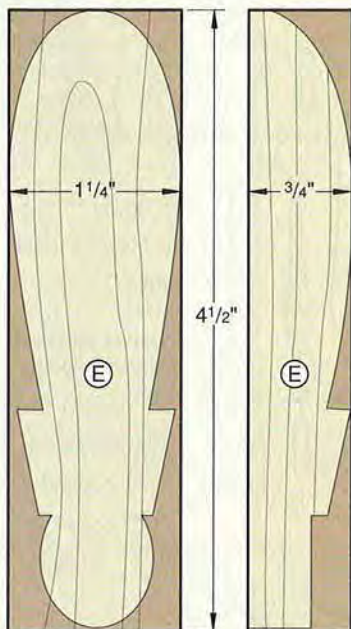

ARM SIDE VIEW

ARM FRONT VIEW

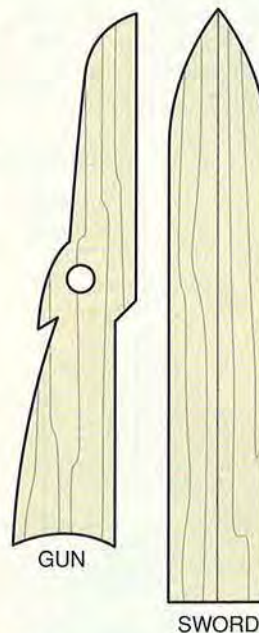

GUN

SWORD

Enlarge at 141% on photocopy machine for full-sized patterns

FAST and EASY Warp-Free Gluing

The PLANO Glue Press clamps boards vertically to make flat panels and warp-free boards easily and quickly. Patented linking arms align the boards automatically and apply pressure on all four sides! PLANO will give you flat, strong panels without using dowels or biscuits.

Fine Woodworking called PLANO "an excellent edge clamp...costs are easily justified."

Save money, time and space! Special packages are priced from only \$499. Call for your FREE literature today!



☎ 1-800-648-4264 ☎

Please send FREE literature on PLANO Glue Press 590

Name _____

Address _____

City, State _____

Phone () _____ Zip _____

ADVANCED MACHINERY IMPORTS
P.O. Box 312, Dept. 590
New Castle, DE 19720
FAX 302-322-3479

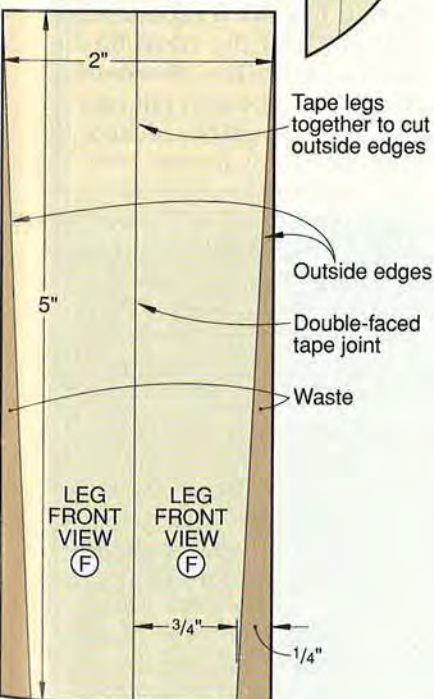
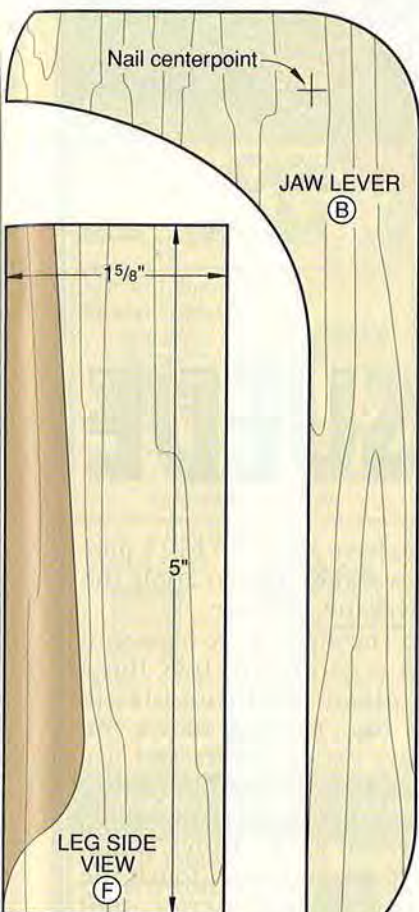

Give the gift that lasts a lifetime... NordicTrack.

The world's best gift.

Give the gift of health and fitness with a NordicTrack exerciser. Our exclusive workout simulates cross-country skiing, called the world's best aerobic exercise by most fitness experts.

Unlike most machines which focus only on the legs, NordicTrack tones both your upper and lower body. The patented flywheel and one-way clutch mechanism provides a smooth, non-jarring workout that won't stress your back or legs.

In as little as 20 minutes, 3 times a week, NordicTrack can provide a lifetime of fitness benefits: weight control, stress reduction, more energy and extra stamina.

The lifelong solution for dieters.

Because NordicTrack works all major muscle groups, you'll burn more fat than with ordinary exercisers. Plus, it boosts your metabolism to burn extra calories. So the weight you lose stays lost. Now for as little as \$339.95, you can give the gift of health and happiness. Give them a NordicTrack.



© 1993 NordicTrack, Inc., A CML Company • All rights reserved.

Call NordicTrack today!

1-800-441-7891 Ext. 08BL3

or write: NordicTrack, Dept. 08BL3,
104 Peavey Road, Chaska, MN 55318-2355

30-day in-home trial!

NordicTrack
A CML Company

We're Changing the Shape of America™

END WOOD ABUSE!

Replace "Old-Fashioned Pin Torture"



with the "Wood-Friendly" Wagner L606 Moisture Meter

- Deep Penetrating, Pin-Free
- Convenient, Pocket Size
- The First Moisture Meter of Its Kind Under \$200



L4.5" x
W2.75" x H1.5"

WAGNER
ELECTRONIC PRODUCTS

326 Pine Grove Rd.
Fogue River, OR 97537
(503) 582-0541
Fax (503) 582-4138

1-800-944-7078

© 1993 WAGNER ELECTRONIC PRODUCTS, INC.

THE PROS CHOICE FOR FINISHING SMALL BOX INTERIORS

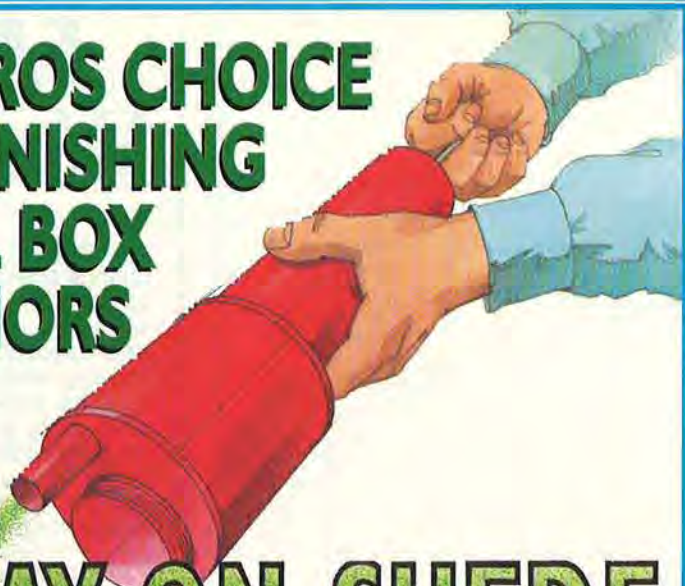

SPRAY-ON SUEDE

Say good-bye to unsightly seam lines of ill-fitting pieces of felt for lining small box interiors. And say hello to a better-looking alternative, DonJer's Suede-Tex, a fibrous, spray-on material. Just follow the simple method described below to apply a professional-looking lining to such finely crafted boxes as the heart-topped jewelry box on page 48.

Note: To try this procedure, you'll need the felt-like flocking fibers, adhesive, and the flocking gun making up the kit. See the Buying Guide at right for our source.

How to apply Suede-Tex to the "Heart-Topped Box"

1 To apply the fibers, first load the gun no more than two thirds full of flocking fibers. A less-than-full gun allows for better propelling of the fibers from the gun. Note that the pump-action gun resembles the kind used to apply dusting powders in gardens.

2 Mask off all but the interiors of the box base and trays. Apply a wet, even coat of DonJer's color-matched adhesive on the unmasked areas using a 1/2"-wide natural bristle or foam brush. Once you have applied the adhe-

sive, you have about 10 to 15 minutes of working time to apply the fibers over the adhesive.

3 Place the heart-box base and trays in a cardboard box lined with a clean, dust-free plastic garbage bag. The bag allows you to collect excess fibers and use them again in your next project.

4 Thoroughly coat all the adhesive-covered areas. Don't skimp on the fibers and don't touch the fiber-covered box interior until the adhesive has dried (about 12 hours). Then, turn the heart-box base and trays upside down to allow the excess fibers to fall into the plastic-lined cardboard box. Gather up the excess fibers.

Buying Guide

Flocking fibers. One 3-oz. bag of Suede-Tex fibers plus color-matched brush-on adhesive, \$14.95 ppd. (Special price for WOOD® magazine readers). Available in bright red, royal blue, kelly green, and 28 additional colors. Each order will include a brochure with detailed application instructions. Add \$35 for the flocking gun. DonJer Products Corp., Ilene Court, Bldg. 8W, Belle Mead, NJ 08502, or call 800/336-6537 to order. 🌱

FREE SHIPPING

Love & Joy

Lg. 27" h x 94" w
Sm. 9" h x 29 w

Deck The Halls

Lg. 28" h x 46" w
Sm. 9-1/2" h x 15-1/2" w

LOVE & JOY

*Get Both Above Small Patterns For Just \$9.95
Both Above Large Patterns For Just \$14.95*

Holiday Helpers

Sm. 6" to 7" tall - \$9.95 Lg. 15" to 22" tall - \$14.95

With these Happy Helpers you could spread a lot of Holiday Cheer! Small size is great for mantle or wall and the large for yard or front porch. Plans are full scale. Easy to follow instructions include materials list. Order today at 800-765-0176.

Please send: Deck the Halls and Love & Joy Lg. Sm.
 Holiday Helpers Lg. Sm.

Name _____
Address _____
City _____ State _____ Zip _____

Enclosed is my check or money order for \$_____ made out to
TIMELESS DESIGNS Add \$2.95 for shipping & handling. *Free!*

Please bill my: MASTERCARD VISA Exp. Date _____
Card # _____ Signature _____

MAIL TO: TIMELESS DESIGNS
P.O. Box 676 • Whitewater, WI 53190
SATISFACTION GUARANTEED

SKIL	
77	7 1/4" WORM DRIVE CIRCULAR SAW ... \$145
1605-02	BISC JOINER W/CS & GLUE SYSTEM ... 125
1875	2 1/4 HP EVS PLUNGE RTR W/BIT SET ... 174
2736-04	12V VSR KYLS W/15 PC BIT SET ... 135
2976-02	3 3/8" CRDLS TIL CTRR, 12V W/H2O BTL ... 159
2977-02	3 3/8" CRDLS CIRC SAW KIT, 12V ... 144
3330	16" SCROLL SAW W/FREE SUPRTWIST ... 135
3370	4" BLT/6" DISC SDR W/SUPRTWIST ... 135
3380	" DRILL PRESS ... 135
3400	10" TABLE SAW W/FREE CARB BLADE ... 179
5657	7 1/4" CIRC SAW W/6 FREE CARB BLDS ... 112
7484	5" RANDOM ORBIT SANDER 10,000 RPM ... 99
5860	8 1/4" WORM DRIVE SAW ... 172
9410	4 1/2" DISC GRINDER ... 59
3810	10" MITER SAW W/FREE CARB BLADE ... 204

Milwaukee	
0228-1	3/8" DRILL, VSR, 3.5 AMP, 0-1000 RPM ... 102
0234-1	1 1/2" 0-850 RPM MAGNUM DRILL ... 119
0375-1	3/8" 0-1300 RPM CLOSE QUARTER DRILL ... 127
0406-1	9.6V KYLS CDLS DRILL KIT W/2BAT, CS ... 169
0407-1	SAME AS ABOVE BUT 12 VOLT ... 174
5371-1	1 1/2" MAGNUM HAMMER DRILL KIT W/CS ... 185
5620	3/8" PISTOL HAMMER DRILL KIT ... 140
5620	2 HP ROUTER, 12 AMPS, 26,000 RPM ... 119
6009	1.3 SHEET FINISHING SANDER ... 119
6010	1.2 SHEET FINISHING SANDER ... 119
6016	1.4 SHEET FINISHING SANDER ... 54
6017	1.4 SHEET DUSTLESS FINISHING SANDER ... 55
6125	5" RANDOM ORBIT SANDER ... 112
6126	6" RANDOM ORBIT SANDER ... 115

Milwaukee	
6127	5" RANDM ORBIT SANDER DSTLS W/CASE ... 146
6142	4 1/2" GRINDER KIT W/CASE, 5 8"-11 SPNDL ... 112
6365	7 1/4" CIRCULAR SAW, 13 AMP ... 120
6368	7 1/4" CIRC SAW W/CASE & CT BLADE ... 137
6369	7 1/4" CIRC SAW W/BRAKE & CT BLADE ... 145
6490	NEW! 10" MITER SAW W/80T CARB BLADE ... 249
6507	VAR SPEED SAWZALL W/BLADES & CSE ... 143
6608	SAME AS 6507 BUT W/PERMANENT CRD ... 143
6511	2 SPEED SAWZALL W/BLADES & CSE ... 137
6527	SUPER SAWZALL W/BLADES & CSE ... 169
6528	SAME AS 6527 BUT W/PERMANENT CRD ... 169
6540-1	CRDLS SCREWDRIVER KIT ... 91
6543-1	SCREWDRIVER 0-1000 RPM, REV ... 131
6767-1	SCREWDRIVER KIT 5 AMP W/CASE ... 123

BOSCH	
ALL BOSCH ROUTER BITS ARE 40% OFF LIST PRICES!	
1001VSR	3 3/8" 1100 RPM DRILL ... 79
1021VSR	3 3/8" 1100 RPM DRILL HEAVY DUTY ... 99
1023VSR	1 1/2" 550 RPM HVY DUTY DRILL ... 109
1024VSR	3 3/8" MIGHTY MIDGET 1050 RPM DRILL ... 108
1025VSR	1 1/2" MIGHTY MIDGET 600 RPM DRILL ... 117
1164VSR	1 1/2" VSR, 2 STAGE HAMMER DRILL ... 140
1194VSRK	SAME AS ABOVE W/METAL CASE ... 154
1195VSR	3 3/8" VAR SPD REV HAMMER DRILL ... 129
1272	3" X 24" BELT SANDER ... 175
1272D	3" X 24" DUSTLESS BELT SANDER ... 183
1273	4" X 24" BELT SANDER ... 182
1273D	4" X 24" DUSTLESS BELT SANDER ... 186
1273DVS	4" X 24" VS DUSTLESS BELT SANDER ... 199
1347AK	4 1/2" MMI GRINDER W/CASE ... 99
1370DEVSK	6" VS DSTLS RNDM ORB SDR KIT ... 250
1420VSR	DRYWALL DRIVER, 4.8 A, 0-4000 RPM ... 84
1561VS	TOP HANDLE JIG SAW, VS ... 144
1561DVS	SAME AS ABOVE BUT DUSTLESS ... 167
1582VSC	CLIC BARREL HANDLE JIG SAW, VS ... 144
1582DVS	SAME AS ABOVE BUT DUSTLESS ... 167
1600	2 1/4 HP "D" HANDLE ROUTER ... 209
1601	1 HP ROUTER ... 134
1602	1 1/2 HP HANDLE ROUTER ... 134
1604	1 3/4 HP ROUTER ... 134
1606	"D" HANDLE 1 3/4 HP ROUTER ... 169
1608	LAMINATE TRIMMER ... 84
1608U	UNDERSCRIBER TRIMMER ... 117
1609K	INSTALLERS KIT WITH 3 BASES ... 173
1609KX	DELUXE INSTALLERS KIT W/4 BASES ... 197
1613	1 3/4 HP PLUNGE ROUTER ... 163
1613EVS	2 HP VAR SP PLUNGE ROUTER ... 183
1614	1 HP PLUNGE ROUTER ... 127
1614EVS	1 1/4 HP VAR SP PLUNGE ROUTER ... 148
1615EVS	3 1/4 HP VAR SP PLUNGE ROUTER ... 243
1655	NEW! 7 1/4" CIRCULAR SAW ... 109
3050VSRK	8.6V, VSR CRDLS DRILL W/2 BAT, CS ... 134
3258	3 1/4" PLANNER ... 136
3282DVS	5" VS DUSTLESS RANDOM ORBIT ... 99
11203	1 1/2" ROTARY HAMMER W/STOP ROT ... 429
11304	THE BRUTE BREAKER HAMMER ... 189
11305	DEMOLITION HAMMER ... 639

SKIL HOLIDAY GIVE AWAY SALE!

Biscuit Joiner Model 1605-02



Purchase this Skil biscuit joiner with case and receive a **FREE** gluing system and 100 new GRABBER clampless biscuits!
OUR PRICE \$125.00

Top Gun 12V Cordless Driver Drill Kit w/2 Batteries & Keyless Chuck Model 2736-04



Purchase this Skil Cordless Drill Kit and receive a **FREE** 15 piece Bit Driver Set!
OUR PRICE \$136.00

10" Table Saw Model 3400



Purchase this Skil Table Saw and receive a **FREE** 10" x 32T carbide blade!
OUR PRICE \$179.00

7 1/4" Circular Saw Model 5657



Purchase the Skil Circular Saw and receive a Contractors' 6 Pack - 6 carbide blades absolutely free!
OUR PRICE \$112.00

2 1/4 hp EVS Plunge Router Model 1875



Purchase the Skil Plunge Router and receive a 4 piece router bit set **FREE!**
OUR PRICE \$174.00

4" Belt/6" Disc Sander Model 3370



Purchase either the Skil 16" Scroll Saw or the 4" Belt/6" Disc Sander and receive a Skil Supertwist **FREE!** Hurry... Limited quantities available.
OUR PRICE \$135.00 EACH

We are pleased to now offer **DEWALT** tools at the lowest prices!

Biscuit Joiner Model DW682K



Includes 100 FREE BISCUITS!

Biscuit joiner kit; 6.5 amp, 10,000 rpm. Includes steel carrying case, dust bag & 100 free biscuits
OUR PRICE \$224.00

12" Compound Miter Saw Model DW705



13 amp, 4000 rpm, electric brake. Precision miters 0-48°, 0-48° bevel capacity. Includes 32T carbide blade.
OUR PRICE \$358.00

12 Volt Cordless Drill Kit Model DW945K2



Heavy duty, 3/8" cordless Versa-Clutch drill kit with keyless chuck, 2 batteries, charger, and steel case
OUR PRICE \$168.00

DEWALT	
DW100	3/8" DRILL, 0-2500 RPM, 4 AMP ... 68
DW102	3/8" DRILL, 0-1200 RPM, 4.5 AMP ... 69
DW103	3/8" HEAVY DUTY DRILL ... 118
DW104	3/8" KEYLESS DRILL, 4.8A, 0-1200RPM ... 99
DW106	3/8" HVY DUTY DRILL W/KYLS CHUCK ... 73
DW111	1 1/2" HEAVY DUTY DRILL ... 128
DW120K	1 1/2" RIGHT ANGLE DRILL KIT ... 209
DW124K	1 1/2" HVY DTY JOIST & STUD DRILL KIT ... 209
DW130	1 1/2" HVY DTY SPADE HANDLE DRILL ... 152
DW160	3 3/8" HVY DTY RIGHT ANGLE DRILL KIT ... 138
DW250	DRYWLL DRIVER, 0-4000 RPM, 4.5 AMP ... 89
DW254	SCREWDRIVER, 0-2500 RPM, 5 AMP ... 87
DW270W	DRYWALL SCREWDRIVER W/50' CORD ... 117
DW280K	SCREWDRIVER KIT ... 125
DW290	1 1/2" IMPACT WRENCH ... 174
DW304K	7 AMP HVY DUTY RECIP SAW KIT ... 138
DW305K	RECIP SAW, VAR SPD, 8.0 AMP ... 159
DW306K	RECIP SAW, VAR SP, 8.0 AMP ... 155
DW316K	4.5 AMP HVY DTY JIG SAW KIT W/CS ... 144

DEWALT	
DW360	7 1/4" SAW W/BRAKE ... 139
DW364	7 1/4" HVY DTY CIRC SAW W BRAKE ... 145
DW402	4 1/2" MINI GRINDER ... 92
DW411	1.4 SHEET FIN SANDER, DUSTLESS ... 57
DW430	3" X 21" DUSTLESS BELT SANDER ... 164
DW431	3" X 21" DUSTLESS BELT SANDER, V SP ... 182
DW510K	1 1/2" HAMMER DRILL KIT, 5.4 AMP ... 165
DW610	1 1/2 HP ROUTER, 9 AMP ... 147
DW614	1 1/4 HP PLUNGE ROUTER ... 143
DW615	1 1/4 HP PLUNGE ROUTER, VAR SP ... 158
DW624	3 HP HVY DUTY PLUNGE ROUTER ... 245
DW625	3 HP HVY DTY PLUNGE RTR, VAR SP ... 275
DW675K	3 1/8" PLANNER KIT ... 159
DW682K	BISCUIT JOINER KIT WITH 100 BISCUITS ... 224
DW704	12" MITER SAW ... 314
DW705	12" COMPOUND MITER SAW ... 358
DW944K	9.6V 3 3/8" CRDLS DRILL KYLS, VSR, W/CS ... 148
DW945K	12V 3 3/8" CRDLS DRILL KYLS, VSR, W/CS ... 168
DW947K	13.2V 3 3/8" CRDLS DRL KYLS, VSR W/CS ... 208

FELKER	
TM1	10" TILE SAW W 1 1/2 HP, INCLUDES BLADE, STAND & MITER GAUGES ... \$895
FC45 12	12" GAS CUT OFF SAW ... 749
TS40	RUBI TILE CUTTER ... 199
TR650-31	8" TILE SAW, 1 1/2 HP ... 499
Kwikset	
Lock Installation Kit Model 136	
Includes jig, latch & strike mortiser, cylinder removing tool, strike locator & lock template	
OUR PRICE \$149.00	
Yem SUPER SPECIAL \$189	
636 OSCILLATING TRIANGULAR SANDER INCLUDES CASE & PAPER ASSORTMENT	

freud	
FREUD ROUTER BITS ARE 40% OFF OF LIST PRICES!	
JS100	BISCUIT JOINER (\$164) AFTER REBATE ... 134
JS100K	JS100 W/1000 BISCS AFTER REBATE ... 157
FT2000E	3 1/2" HP PLNG RTR VS (\$205) AFTER REB ... 176
EB100	EDGE BANDING SYSTEM ... 208
LM72M1010	10" X 24T FLAT TOP RIP BLADE ... 36
LU82M1010	10" X 80T CROSSCUT RIP BLADE ... 49
LU84M1010	10" X 50T ATB COMBO BLADE ... 42
LU85M1010	10" X 80T GREAT WOOD CUT OFF BLD ... 58
LU85M1012	12" X 96T GREAT WOOD CUT OFF BLD ... 93
LU85M1015	15" X 180T GREAT WOOD CUT OFF BLD ... 99
LU87M1010	10" X 24T RIP BLADE THIN KERF ... 39
LU88M1010	10" X 60T CROSSCUT THIN KERF ... 46
LU93M1010	10" X 72T TCH NON FERROUS METAL ... 57
LU91M008	8 1/2" X 48T FOR COMPOUND MITER ... 41
LU91M1010	10" X 48T FOR COMPOUND MITER ... 51
LU92M1010	10" X 80T TCH - BEST FOR LAMINATES ... 59
LU94M1010	10" X 80T TCH PLEXIGLASS BLADE ... 58
LU98M1010	10" X 80T TCH LAMINATES OR WOOD ... 67
TK203	7 1/4" X 24T THIN KERF BLADE ... 28
TK205	10" X 24T THIN KERF RIPPING ... 15
TK303	7 1/4" X 40T THIN KERF FINISH ... 22
TK304	8 1/4" X40T THIN KERF FINISH ... 24
TK306	10" X 40T THIN KERF COMBINATION ... 25
TK906	10" X 50T THIN KERF CROSSCUT ... 30
TK406	10" X 80T THIN KERF FINISHING ... 34
TK606	10" X 80T ATB COMPOUND MITER BLD ... 39
TK806	10" X 80T ATB ULTIMATE CROSSCUT BLD ... 44
SD306	6" X 24T SAFETY DADO WITH CASE ... 112
SD309	8" SAFETY DADO WITH CASE ... 116
WC104	4 PC WOOD CHISEL SET W/CASE ... 46
WC105	6 PC WOOD CHISEL SET W/CASE ... 56
WC110	10 PC WOOD CHISEL SET W/CASE ... 86
FB107	7 PC FORSTNER BIT SET W/CASE ... 57
FB100	16 PC FORSTNER BIT SET W/CASE ... 179
FC107	7 PC CARBIDE FORSTNER BIT SET ... 84
CS105	6 PC CARVING SET W/CASE ... 84
CS112	12 PC CARVING SET W/CASE ... 144
TT108	TURNING TOOL SET W/CASE ... 119
88-100	9 PC BASIC ROUTER BIT SET ... 104
90-100	15 PC ADVANCED ROUTER BIT SET ... 159
91-100	13 PC ROUTER BIT SET ... 179
94-100	CABINET DOOR SET, 1 1/2" SHANK ... 158
95-100	5 PC CABINET & MOULDING BIT SET ... 199
FREUD HOLIDAY BLADE BLOWOUT	
TKHS - 3 BLADE HOLIDAY KIT INCLUDES TK206 - 10" X 24T RIP BLADE, TK906 - 10" X 50T COMBO BLADE, & NEW TK606 - 10" X 80T FINISHING BLADE	
OUR PRICE \$94.00	

INTERNATIONAL TOOL CORPORATION • 1939 TYLER STREET, HOLLYWOOD, FLORIDA 33020

1-800-338-3384

• FREE FREIGHT & SAME DAY SHIPPING ON MOST UPS ORDERS OVER \$25.00 MINIMUM PURCHASE WITHIN THE CONTINENTAL U.S.A.

QUANTITIES LIMITED - NOT RESPONSIBLE FOR TYPOGRAPHICAL ERRORS - PRICES SUBJECT TO CHANGE WITHOUT NOTICE

FAX US YOUR ORDER AT 1-305-927-0291

The CMT™ Orange: The Symbol Of Safety, Our Florida Home And CMT's Superior Teflon® Performance



13-Piece Set

A super deal on 13 of our finest 1/2" shank carbide-tipped bits! All ball-bearing bits include CMT's anti-kick-back design and shielded bearings.

800-505
13-Piece Set
List: \$275.00

Sale: \$199.00



Complete Sets For Incra, JoinTECH, Leigh & Keller Jigs

You've invested in a fine jig, now you need a matching set of carbide tipped bits with the precise geometry the jig demands. Incra, JoinTECH and Leigh sets feature CMT's unique solid hardwood case.

- 800-500 8-pc. 1/4" shank set for Incra & JoinTECHList: \$137.60**Sale: \$ 99.00**
- 800-501 8-pc. 1/2" shank set for Incra & JoinTECHList: \$145.80**Sale: \$109.00**
- 800-502 10-pc. 1/4" & 1/2" shank set for Leigh JigList: \$180.40**Sale: \$129.00**
- 800-617 5-pc. 1/4" shank set for Keller #1601 JigList: \$148.50**Sale: \$118.80**
- 800-618 4-pc. 3/8" & 1/2" shank set for Keller #2401 ..List: \$143.20**Sale: \$114.60**



Fellow Woodworkers,

When I first encountered CMT router bits, some of their features were so visibly obvious that I knew immediately they would have a very positive impact for all woodworkers.

The excellent workmanship and innovative design engineering is not just apparent, it's conspicuous!

Extended use of CMT bits gives testimony to their high grade fatigue-proof steel shanks and their edge holding carbide. Once you try CMT tools, you will agree that they deserve all the applause they are receiving from woodworking journals and woodworking experts world-wide.

Patrick Spielman, Author
Router Basics, Router Handbook, Router Jigs and Techniques



New! CMT's Kitchen Collection

Three sets of superb 1/2" shank bits make up our "Kitchen Collection," carbide tipped bits that cover all your door & drawer needs. Each set includes a Raised Panel bit, matching Rail & Stile cutters, Glue Joint and Drawer Lock bits. Choose your favorite profiles from the selection below.



800-509 Ogee Set



800-510 Standard Set



800-511 Bevel & Radius Set



Your Choice
List: \$299.00

Sale: \$239.00

12-Piece Set

This set of 1/4" shank carbide tipped bits includes chamfer, rabbet, radius, flush trim, cove and ogee bits with shielded bearings. Also included are dovetail, V-groove, mortising, round nose and two straight bits.



800-503
12-Piece 1/4" Shank Set
List: \$224.40
Sale: \$159.00

6-Piece Starter Set

Here's a great introduction to the CMT line! Includes six of our finest 1/2" shank bits including Round Nose, Cove, Rabbeting, Roundover, Ogee and Chamfer profiles. The five ball-bearing bits feature anti-kick-back design.



800-504
6-Piece 1/2" Shank Set
List: \$157.90
Sale: \$119.00

1-800-531-5559
Order toll-free 24 hours a day, 7 days a week



CMT Tools,
5425 Beaumont Center Blvd. Tampa, FL 33634
813-886-1819 FAX: 813-888-6614
Free shipping anywhere in the U.S.A.



1-800-531-5559



1-800-387-7005



(0424) 216897



(0721) 482204



Ask for our free catalog



RESTORE FURNITURE for SECURE INCOME Perfect 2nd Career

Make \$200-\$2,000 a day! Unlimited market; turn-key business. Free workshops. Set-Up Shop for \$2,999-\$9,999! Part-time or full-time. Great for men, women, families.

Make Molds*Veneer*Resilver Strip*Repair*Refinish

Business Preview Video \$8.95 - Catalog \$2.00

MINUTEMAN, INC., Ste. 17

Box 8, Waterloo, WI 53594

1-800-733-1776



High Tech Engraving



See what everyone has been talking about! Engrave on: Wood, Glass, Metal, Stone, Ceramics, Eggshell

- Precise Detail
- No Vibration
- 400,000 RPM
- No heat buildup
- You don't have to be an artist when you use our exclusive stenciling system.

1-800-755-0261 or 414-251-0981

SCM Enterprise • W16N11318 Western Avenue, Germantown, WI 53022



LOOKING FOR PIERCED TIN?

Come to the source . . . COUNTRY ACCENTS® as featured in many national magazines.

Quality handcrafted and reasonably priced panels available in 16 different metals including copper and brass. 100s of designs ready to install in a wide variety of sizes. Panels have a variety of uses:

- Cabinets
- Hutches
- Jelly cupboards
- Pie or food safes
- and MORE!
- Hoosiers
- Ice boxes

Custom size and design a specialty.

Our extensive line of Do-It-Yourself supplies include over 20 types of punches and metal chisels, blank metal stock and patterns for the home crafter.

Send today for 70+ page catalog plus set of metal sample swatches - \$15.95 OR catalog only - \$5.00. For everything in pierced metal . . . Since 1979.

COUNTRY ACCENTS®, P.O. Box 437, Dept. WD-93/5, Montoursville, PA 17754 (717) 478-4127 M-F 9-4 ET • MasterCard/VISA accepted

STEVE WALL LUMBER CO.

Quality Hardwoods and Woodworking machinery For The Craftsman and Educational Institutions

STEVE H. WALL LUMBER CO.

BOX 287 • MAYODAN, N.C. 27027

919-427-0637 • 1-800-633-4062 • FAX 919-427-7588

Ash	4/4	Select	2.10		\$ 65.00
Basswood	4/4	Select	1.50		\$ 53.00
Birch	4/4	Select	2.20		\$ 67.00
Butternut	4/4	1C	1.70		\$ 57.00
Cherry	4/4	Select	2.90		\$ 81.00
Hickory - Pecan	4/4	Select	1.80		\$ 59.00
Mahogany (Genuine)	4/4	Select	2.90		\$ 81.00
Maple (Hard)	4/4	Select	2.30		\$ 69.00
Maple (Soft)	4/4	Select	1.70		\$ 57.00
Poplar	4/4	Select	1.45		\$ 52.00
Red Oak	4/4	Select	2.25		\$ 68.00
Walnut	4/4	Select	3.00		\$ 83.00
White Oak	4/4	Select	2.20		\$ 67.00
Cedar (Aromatic Red)	4/4	1C+Btr.	1.55		\$ 54.00
Cypress	4/4	Select	1.85		\$ 60.00
White Pine	4/4	F.G.	1.00		\$ 43.00
Yellow Pine	4/4	Clear	1.50		\$ 53.00

UPS
Specials

MiniMax
S45 18"
Band Saw
Special Sale
Price
\$1399
Reg. \$1590
FOB Mayodan
Call for best price
on Mini Max
Machines

Above prices are for 100' quantities of kilndried rough lumber sold by the Bd. Ft. FOB Mayodan, NC. Call for quantity discounts. Other sizes and grades available.

Above prices are 20 bd. ft. bundles of clear kilndried lumber 3"-10" wide • 3'-7" long (Random widths & lengths) Surfaced 2 sides or rough. Delivered UPS prepaid in the Continental U.S.

Send \$1.00 For Lumber Catalog

BRANDING IRON

Your Satisfaction Guaranteed

- Convenient torch heating
- Solid Brass—lasts years
- Special wording available
- Electric Models Start at \$48.00
- 2nd line—20 letters/spaces max.
- 1/4" letters
- Distinctive Border
- Add \$3.50 shipping and handling
- OH res. add 6% sales tax



Order by mail from: **BrandMark** TO ORDER CALL TOLL FREE

462 Carthage Dr., Dept. W12-3
Beaver Creek, OH 45434-5865
(513) 426-6843

1-800-323-2570

8:00-5:00 EASTERN TIME

Build "Merrilegs"

Full-size Plan #121 \$16.00 (catalog free with order)

CATALOG 200 full-size professional furniture plans — \$3.00

SEND TODAY!



Full-Size Professional Plan

FURNITURE DESIGNS, INC., Dept. BZ-123
1827 Elmdale Ave., Glenview, IL 60025 — (708) 657-7526

Quality MECHANISMS For Making WOODEN BARREL

- Pens
- Pencils
- Roller Balls
- Fountain Pens

plus other related items.

Wholesale/Retail

Call or Write:

BereaHardWoods.co
6367 Eastland Rd. Brookpark, Ohio 44142
216-234-7949 MasterCard/Visa

HARDWOODS

EXOTIC & DOMESTIC OVER 75 SPECIES

LUMBER • VENEER • TURNING STOCK

COLLECTORS SAMPLE KIT

30 GORGEOUS WOODS Exotic & Domestic from Around the World 1/2" X 3" X 6" Sanded Finish **\$39.00** *ppd in Cont US

Together with Book of Fine Hardwoods **\$51.00** *ppd in Cont US

Over 70 woods shown in full color. Charts compare physical properties. 60 pgs



1-800-423-2450

WOODWORKERS Source

5402 S. 40th Street • Phoenix, AZ 85040
602-437-4415

DELMHORST MODEL J-88 WOOD MOISTURE METER

INSURE THE QUALITY OF EVERY PROJECT VALUE PRICED AT \$110



Easy to read LED Display indicates 10 ranges of Moisture Content between 6% and 20%.
• 3yr. warranty • Complete with carrying case, batteries, and pins.
• Delmhorst offers over 45 years of experience and service second to none!
CALL TOLL-FREE: (800) 222-0638
NEW JERSEY: (201) 334-2557

DELMHORST
INSTRUMENT CO.

51 Indian Lane East, Dept., 931, Towaco, NJ 07082



PRODUCTS THAT PERFORM



Print this article

New accessory helps you "draw" with a router

I have little talent for freehand drawing or routing, but a new product from Sears helped me freehand-rout some great-looking signs. The Rout-A-Copier consists of a 12x20" plastic base with a screw-operated clamp for holding workpieces of any length and up to 11" wide during machining. It also has a clear-acrylic plate supported above the base by four adjustable posts.

To rout your sign, first attach a small, self-adhesive, plastic button to the top of your router, centered above the tool's arbor. Then, hold or tape the design under the clear plate, and trace the image onto the acrylic surface with a washable marker. Secure the workpiece onto the base, place your router between the clear plate and base, and follow the marked

image with the router's plastic button. The device accepts any router, and you need to supply a groove-forming router bit.

I made a variety of signs that included letters and symbols with good success. I had to practice to get used to the feel of the router

and the sometimes-uneven pressure of the clear plate on top of the router.

—Tested by Bob McFarlin

Sears Craftsman Rout-A-Copier, about \$50. Call or visit your local Sears store.

Continued on page 83

Dust Is A BIG Problem!

In every shop dust is a big problem. If you sand, saw, drill, plane, or just sweep you have a dust problem. Even if you own a dust collector,



YOU'RE STILL BREATHING FINE DUST!

Remember how when you work in the basement, you have dust upstairs on the furniture. Or when you hook up a shop vac to your sander, you still have that fine floating dust—the same dust that you're breathing while you work!

TOTAL SHOP has the Answer - The **CleanAirSystem**. This unique system has a large 465 CFM fan that circulates your room air through a series of 3 filters. These filters catch up to 95% of the super fine dust and circulates the same fresh air back into the room. The **CleanAir's** convenient size (25" x 13" x 40"), works most effectively on shops as large as 24 ft x 40 ft.



CleanAir #90175
SALE \$269.00

Shipping \$20

Heavy Duty CleanAir #90177
SALE \$309.00

Shipping \$20

Order Now
1-800-845-9356



PO Box 25429 Greenville SC 29616

Now You Can Save Time and Make Money With The RBI 812 Planer System.



Special Introductory Price
\$849
(Planer Only)

Here's What the RBI 812 "3 in 1" Planer, Molder, Sander Can Do For You!

- Create custom cabinets and fine furniture
 - Customize existing woodwork for a home addition
 - Finish and dimension stock to exactly fit your needs
 - Turn rough lumber into beautiful molding in just minutes
 - Produce uniform surfaces even on long stock
 - Plane lumber from up to 12" wide in just seconds
 - Create hundreds of ornamental moldings or picture frames from hard or soft woods with standard or customized knives
 - Eliminate distortions caused by tedious hand sanding
- Comes Pre-Wired with a 3 HP (TEFC) Motor and our 30-Day Money Back Guarantee • 3-Year Warranty**

Call 800-487-2623 To Order or FREE Info Kit.



rbindustries
The American Tool Manufacturer
1801 Vine Street • PO Box 369
Harrisonville, MO 64701

C127

MAKE TOYS

CLOCKS & WHIRLIGIGS

Door Harps, Dollhouses, Music Boxes, and Dozens more fun Wooden Toys from our plans, parts, kits & supplies. Bulk Price available. Catalog \$1.00.

CHERRY TREE TOYS

Box 369-335,
Belmont, OH 43718
1-800-848-4363, ext. 335-D



WOODWORKER'S CATALOG

Over 4000 products to **BUILD, REPAIR, RESTORE, REFINISH** anything made of wood!

It's the catalog woodworkers rely on—116 pages jam-packed with fine woods, veneers, tools, finishing supplies, and much more—all top quality, all reasonably priced, all with our 60-day no-questions-asked guarantee. For your 2-year subscription send \$1.00 to:



CONSTANTINE
Serving Woodworkers for 181 years

2050 Eastchester Rd., Dpt. 35312, Bronx NY 10461

The professional weather station for people curious about the weather.



Temperature, Barometric Pressure, Wind Speed, Wind Direction, Wind Chill, Highs and Lows, Alarms, Rainfall Option, Humidity Option, Computer Interface Option

For more information or a free catalog, call

1-800-678-3669

or write

DAVIS INSTRUMENTS
3465 Diablo Ave., Hayward, CA 94543

WM2360

WEATHERSEALS



We stock the world's largest selection of silicone rubber window and door weatherseals. Our affordable corner-grooving machine and corner tubeseals make sealing old work effortless, and our custom router bits and flipperseals make new work just as easy. With these seals, even the smallest shop can make windows and doors that work better than many factory-made units. We also offer plastic seals for sliding applications.

RESOURCE CONSERVATION TECHNOLOGY, INC.
2633 North Calvert Street Baltimore, MD 21218
(410) 366-1146 Request Catalog W



28 Page Catalog only \$1.00

Carvers Supply Catalog

Over 1400 items including basswood, tupelo, and butternut cutouts and cutout kits (wildfowl, Santas, and more). Plus tools, eyes, books, patterns and hard to find items (cork decoy kits).



Call or Write:
Jennings Decoy Company

Toll Free 1-800-331-5613
Fax 612-253-9537
601 Franklin Ave. NE Dept. 007
St. Cloud, MN 56304

YOU DESERVE QUALITY HARDWOODS

Order an advantage pack today!

25 Board ft., 30"-60" long, 4"-10" wide, surfaced 2 sides to 13/16", clear one face

Cherry \$79 Poplar \$55
Red Oak \$76 Hard Maple \$72

Thin Stock Packs Also Available

We pay UPS shipping to most destinations in the Eastern time zone, other areas slightly higher. Discover, Visa/MC Accepted. Free catalog w/ order.

Bristol Valley Hardwoods
4300 Rt 64, Canandaigua, NY 14424
1 (800) 724-0132 (ext. 11)

WARREN'S FINEST COMBINATION WHITTLERS/CARVERS KIT IN CUSTOM REDWOOD BOX

Introducing New concept 'Lock-Jaw' handles with 'Lock-Jaw' wrench



1993 WOOD SHOP SPECIAL #COMBI-TCE \$95.95 P.Pd. (USA)

Designed for wood-carvers who appreciate fine quality tools. (Made in USA) Est. 1927. Plus Free Pattern and Instruction Booklet

COMBI-TCE CONTENTS:
(8) Gouges*
(6) Small Blades*
(1) Large Blade*
* All Honed Sharp
(2) Handles (interchangeable)
New concept
(1) ea. Walnut (Palm), and Rosewood
(2) Sharpening Blocks
(1) ea. Abrasive, and Leather
1993 Warren Woodcarving Tool & Supply Catalog FREE WITH ORDER. Catalog only, send \$1.00. *N.Y. State Residents Add State Tax. Shipping Also Taxable

Send Check or Money Order to:

Warren Tool Co., Inc.
2209-1 Rt. 96,
Rhinebeck, NY 12572

Tel. (914) 876-7817 • USA only • CDD UPS Available
Canada and Foreign Please send Money Order U.S. Funds.
Canada Add \$3.00. Foreign Orders Add \$6.50 shipping fee.

GREAT IDEA!

"This has to be the most attractive and practical way yet to cover a pickup bed."

A key locked roll-up hard cover that's weathertight.



for free brochure on the **ROLL-TOP-COVER™**

call or write: Pace-Edwards Co.
100 Commercial Street
Centralia, WA 98531

1-800-338-3697

Heavy Duty Plate Joiner Kit w/Biscuits

\$225. DEWALT
#DW682K High Performance Industrial Tool



DW705 12" compound saw with dust bag \$349.
DW625 NEW 3 hp vs plunge router 269.
DW945K-2 12V drill w/2 batteries 169.
DW615 NEW 1-1/4 hp vs plunge router 159.
DW364 7-1/4" saw with brake 148.
DW254 0-2500 deck scrugun 89.

TOOL GRIB
OF THE NORTH

PO Box 1716

Grand Forks, ND 58206

Dec.

Wood

1-800-358-3096

One-Man Sawmill Turns Timber Into Cash!



30-DAY FREE TRIAL!

Sawmill goes right to the trees...turns out smooth, true-cut lumber - even beginners get excellent results. Just one man (no crew needed) can easily cut enough on weekends to save hundreds of dollars over high lumberyard prices. Factory-Direct selling keeps price low...easy terms...made in USA.

PHONE TOLL FREE 1-800-942-4406 Ext. TW14
TIMBERKING, INC. DEPT TW14
1431 N. TOPPING, KANSAS CITY, MO 64120

CAN'T FIND THE TOOL YOU WANT?

You should be reading



Fine Tool Journal

- Magazine on hand tools for collectors & craftsmen.
- Absentee Auctions
- Tools For Sale
- Historical Information
- Coming Events Calendar
- Each issue at least 48 pgs.
- Published Quarterly

1 Yr. Sub. - \$20.00 • Sample, \$4.00

P.O. Box 4001, Dept. WD-93
Pittsford, VT 05763
(802) 483-2111

RIP AW

The Portable Sawmill.

The "affordable portable" one man band sawmill. Weighs only 45 lbs. Cuts 20" diameter logs into lumber. Minimum 1/8" to maximum 9" thickness. 14"W x 9"H throat capacity. Write or call for free brochure. Videos also available.



Better Built CORPORATION

(508) 657-5636

845 Woburn Street, Dept. W12, Wilmington, MA 01887

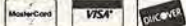

HERITAGE
Building Specialties

PROJECT-PAK®
A WOODWORKERS
DREAM COME TRUE!

- Save money on projects
- Reduce waste by 25-50%
- Eliminate layout headaches

The ONLY way to buy wood!

Call for details & catalog today.

1-800-524-4184

205 N. Cascade • Fergus Falls, MN 56537

WE WORK FOR YOU!

FREE FREIGHT
SAME DAY SHIPPING

Makita
6211DWE



List \$397

12V VSR Cordless Drill Kit w/ keyless chuck, charger, case, & 2 batteries **\$168**

6201DWE 9.6V Cordless Kit w/2 batteries	\$158
LS1030 10" Miter Saw w/blade	\$199
6095DWE 9.6V Cordless Driver-Drill Kit w/Free Battery	\$144
N1900B 3 1/4" Planer Kit w/case & carbides	\$134
BO5000 5" Random Orbit Sander	\$62
2708W 8 1/4" Table Saw 12A w/GT blade	\$299
5007NBK 7 1/4" Circ Saw w/Free case	\$119

Complete Line at the Right Price!

1-800-262-5482

HOME LUMBER CO.

449 WHITEWATER ST., WHITEWATER, WI 53190

C.O.D.

WOOD TOY

- ★ Patterns
- ★ Parts
- ★ Wheels
- ★ Many New Patterns to Choose from.
- ★ Executive toys



SEND \$1.00 FOR NEW CATALOG

toys and joys

Box 628 w Lynden, Wash. 98264

WOODCARVING



IS FUN AND PROFITABLE

Want to carve decoys, statues or gun stocks?

It's easy when you use the Dupli-Carver Series wood carving machines. A patented five axis carving action allows these machines to complete difficult undercuts and contours as no other machine can. Complete machines available starting as low as \$395.00.

SEND \$1.00 FOR OUR FULL LINE BROCHURE AND PRICE LIST AND START PLANNING YOUR FULL OR PART-TIME BUSINESS.



MARLIN DIVISION

terco incorporated

222 1st Ave. N.W. W312 • Watertown, SD 57201
(605) 882-3888 • Fax (605) 882-0778

Wood Moisture Meter

pocket-size
MINI-LIGNO
Range: 6-20%
in 1% steps
Size: 1"x2 1/4"x5 1/2"

\$110
only

Including Case, Battery, Pins for 3/16" or 7/16" measuring depth.

Also available as Mini E, 6-36%



Lignomat USA Ltd.
503-257-8957 800-227-2105

P.O. Box 30145
Portland, OR 97230

FREE BROCHURE!



★THE WOODWORKING SHOWS★
machinery • tools • supplies

VISIT THE SHOW NEAR YOU!

- Arizona
- Atlanta
- Baltimore
- Buffalo
- Charlotte
- Chicago
- Indianapolis
- Kansas City
- Milwaukee
- New Jersey
- No. California
- Portland
- Seattle
- So. California
- St. Louis
- Tampa
- Virginia
- plus others!

Call for free brochure

Monday - Friday 8 am - 5 pm Pacific Time
1-800/826-8257 or 310/477-8521

TracTop®

ARMRESTS

#1 WORLDWIDE SINCE 1980!



EXCLUSIVE SLIDING CUSHION WITH PULL-OUT TRAY
COMFORT • LOOKS CONVENIENCE

Color Choices Install Yourself Return Guarantee

HONDA • ACURA • BMW • AUDI
NISSAN • SAAB • VW • VOLVO

New! FORD Escort & GEO Storm

Other models Free Literature V/MC/DISC

HUSCO ENGINEERING CO., INC.

17 CALVIN ROAD WILTON, CONNECTICUT 06897

Make Thousands
Turn Your Scrap Wood into BIG Profits!

I'm offering 15 of my top money making patterns. These patterns are an assortment of small craft and gift items which you can finish and have ready for sale without painting. Plus, I will send you many time saving - money saving tips from over 20 years experience. In just a few minutes you will be able to make enough from your left over wood to pay for these patterns. Send \$15.00 for patterns and tips to:

Wood Craft

P. O. Box 57

Herculaneum, MO 63048

1 800 757 7895 VISA/MC

BOSCH

ROUTER BITS & SHAPER CUTTERS

SAVE 30%
on any mix of 6 bits or cutters

SUPER SAVER SPECIAL

1/4" STRAIGHT BIT
85250M

1/4" SHANK, CARBIDE TIP, 2 FLUTE, 7/8" CUT LENGTH **\$6.95**

List \$12.40

Add \$5 Shipping & Handling to each order



For catalog or to order
1-800-423-2450

WOODWORKERS Source

5402 S. 40th Street • Phoenix, AZ 85040

Improve your routing with **\$37.95 Pro Model**

The Craftsman's Newest Control

- Patented tool does all:
- * Design
 - * Preview
 - * Mark Layout
 - * Set Stops
 - * Guide Cuts
- Use with any router
- 100's of Applications!
Crafts to Designer furniture
Tabletops to toy wheels
Patented No-hole Pivot works anywhere
Infinite diameter range 1" to 44" plus



Send Check or MO for \$37.95 to: Mark-N-Cut Distributors, Inc. 115 Hubert Siler Road Williamsburg, KY 40769 (606) 549-0524 Dealer inquiries invited Circle Mark-N-Cut™ Made in USA

PRODUCTS THAT PERFORM



Continued from page 80

Hurray! An affordable faceplate system

I often have as many as five or six wooden bowls in various stages of completion lying around my workshop. That's because many times I turn a green bowl to a certain thickness, then remove it from the lathe and allow it to dry as I work on another bowl. I prefer to leave the faceplate attached to each bowl while it dries, but the cost of owning multiple faceplates can really add up.



Recently, I found a product that helps me save money in this area. The Read Faceplate System has a hub with two threaded ends—one male, one female—like the one above. One end of the hub screws onto your lathe's spindle. The other end threads into interchangeable 4"-diameter plates. With this setup you can leave the hub on your lathe and the plate on your bowl as you change from working on one bowl to another.

The system worked without a hitch in my trials. You can buy hubs to fit most major brands of lathes. Each hub has a threaded center hole for accepting a double-threaded screw (provided with each hub) for converting the hub to a screwchuck.

—Tested by Marlen Kemmet

Read Faceplate System, \$28.95 per hub and \$37.50 for a set of five faceplates. Add \$5 for shipping. From Craft Supplies, 1287 E. 1120 S., Provo, UT 84601. Call 800/551-8876 or 801/373-0917.

Continued on page 84

One Stop Wood Shop

Domestic and exotic hardwood plywood and lumber, marine plywood, over 30 species in stock—all under one roof.

Custom cutting services to your exact specifications with little or no waste at competitive prices! We specialize in bundling and shipping.

Call (617) 666-1340 today for catalog and quote.

Boulter Plywood Corp.
24-WD Broadway, Somerville, MA 02145

Sleep On Air Cushion Comfort

• Adjust Firmness to Fit Your Exact Needs.

• Unique air-cushion design contours to your body, providing superior back support and comfort.



• Research shows 94% of back pain sufferers say Select Comfort gives them the back support they need to get a better night's sleep.

Customized Comfort—You Control The Firmness.

Revolutionary Air Support System.

Select Comfort's unique air support sleep system lets you control the feel and firmness of your bed—simply by pushing a button. Your mattress can be firmer than the firmest innerspring or softer than the softest feather bed...helping you sleep more comfortably, reducing back pain and muscle aches, and providing true support. Change the firmness whenever you like to meet your exact preference.

Adjust Your Side Separately.

Inside the mattress are two air chambers. You can adjust your own side independently. With Select Comfort, you satisfy your own needs without compromise.



Select Comfort provides proper back support and contours to your body, distributing weight evenly.



Innerspring mattresses create pressure points and uneven support.

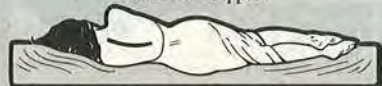

Waterbeds rely on displacement and can cause a "hammock effect," bending your spine unnaturally.

Try Risk-Free for 90 Nights.

Sleep on a Select Comfort for 90 nights. If you are not completely satisfied, return it for a full refund.

15 Year Warranty.

Discover why 96% of Select Comfort users recommend it to their family and friends.

"I am a doctor and often come home exhausted. This mattress is the most comfortable I've tried."

Dr. Connie H., M.D., Clarksville, OH

"For the first time in years, we wake up without aches and pains and have more energy!"

Mr. & Mrs. Dennis C., Lawrenceville, GA

Order Now or Call For Your

FREE VIDEO

and FREE Brochure

1-800-831-1211

YES! Please send me a FREE Video & Information Packet.

Name _____

Address _____

City _____ State _____ Zip _____

Evening Phone (____) _____

Select Comfort Corp.

9301 75th Ave. N.

Minneapolis, MN 55428-1003

© Select Comfort Corp. 1993

Dept 1955

CHAINSAW CARVING VIDEO

EASY STEP-BY-STEP INSTRUCTION TEACHING VIDEO VOLUME I includes 2 projects:

- Dock Pelican
- American Eagle

FUN & PROFITABLE SELL YOUR WORK



VOLUME I

Send Check or Money Order For \$29.95
Plus \$3.90 S/H to:
WOOD CARVING 3 PRODUCTS
P.O. BOX 292526, DAVIE, FL 33329

MAGNATE

WB-15 Woodboxed 15pc Carbide Tipped Router Bit Set



\$89.95

1/4" and 1/2" shank available, sand blasted

TOLL FREE 1-800-827-2316

MAGNATE BUSINESS INTL.

1930 S. Brea Canyon Rd. #170, Diamond Bar, CA 91765

909-861-1185 ext. 128 Fax 800-733-9076

Ask for Free 1993/94 Edition Catalog

WOOD magazine's 335 Great Shop Tips book
FREE (\$9.95 value) with purchase over \$100.

SQUARE DRIVE SCREWS

Simply the Best!

- Square Drive Beats Driver Slippage
- Hardened Steel for Extra Strength
- Deep Thread for Super Grip
- Also Stainless and Brass

Send \$3 for Samples and Catalog

McFEELY'S P.O. Box 3
SQUARE DRIVE SCREWS Lynchburg • Va • 24505
1-800-443-7937 or FAX (804) 847-7136



HEIRLOOM TOYS



- Original designs by professional toy maker featured in Wood magazine
- Collectors' and children's toys
- Patterns, parts and wheels
- Catalog \$2. Free with order
- Introductory Offer: Send \$9.95 for a Model A Pickup pattern and receive free gas pump pattern

Baldwin Toy Co., Inc.
P.O. Box 37014 Omaha, NE 68137-0014

BRANDING IRON

For hard and soft wood

\$2900

Plus \$3.00 for shipping and handling

Nebr. residents add correct sales tax

SATISFACTION GUARANTEED or your money back

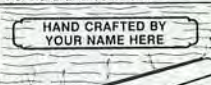

- Shipped in one week
- Solid brass head — raised letters
- 1st Line: HAND CRAFTED BY — as above
- 2nd Line: Your choice — 20 characters/spaces max.
- Electric iron available for \$49.00 + \$3.00

ORDER TOLL FREE ... **1-800-826-7606**

Order by mail from: **NOVA TOOL CO.**

12500 Finigan Rd., Dept. B9
P.O. Box 29341, Lincoln, NE 68529



SAVE MONEY!

KILN DRY LUMBER

MAKE MONEY!

Kiln Dry for others.

As the nation's largest manufacturer of dehumidification Dry Kilns, we can supply you with the same type equipment used by many of the major firms.



1-800-777-NYLE 207-989-4335
Nyle Standard Dryers, Inc.
P.O. Box 1107, Bangor, Maine 04401

Supplement Your Income From Your Home With A Computer!



Begin part-time and still retain the security of your present position. We offer 20 services you can perform for your community from your home. No experience necessary—easy to learn. We provide training and computer. For FREE explanation cassette and literature call:

1-800-343-8014, ext. 184
Computer Business Services, Inc.

CHILD'S ROCKER PLAN

- ★ Full Scale Patterns
- ★ 12"Wx28"D x30"H
- ★ Plans Shipped Same Day



Specify Plan #1293 and send \$6.95 along with \$2.00 shipping & handling

RAN TECH PLANS
P.O. Box 174
Greenville, IL 62246

PRODUCTS THAT PERFORM

SHOP TESTED

Continued from page 83

Pocket-size product keeps rust off tools

Many of us who store our tools in damp places such as basements and garages share a common challenge: how to keep our steel and iron tools from rusting. In my search for a solution to this problem, I recently came across the Microwaveable Air Dryer, a plastic container slightly smaller than a pack of cigarettes that holds moisture-absorbing beads.

I found the product works effectively when placed inside an enclosed area such as a toolbox. In this environment it draws moisture from the trapped air and inhibits rusting. Depending on the humidity level, you need to periodically remove moisture from the Air Dryer by placing it in a microwave oven for a minute or two. I'm going to put one in each of my toolboxes.

—Tested by Chuck Hedlund



Microwaveable Air Dryer, catalog no. 03Q52, \$9.95 plus \$4.50 shipping for orders up to \$25, from Woodcraft Supply, 210 Wood County Industrial Park, P.O. Box 1686, Parkersburg, WV 26102. To order call 800/225-1153. For more information call 800/535-4482.



Why settle for some 2-bit power tool?

The Dremel Moto-Tool is the compact, high-speed rotary tool that's extremely versatile. With variable speeds, ranging from 5,000 to 30,000 RPMs, and over 150 specially designed bits and accessories, it allows you to complete all kinds of tasks, on all kinds of materials.

With the right bit and the right speed you can sand, carve, shape and rout wood. Change the bit, adjust the speed and use the Moto-Tool to grind, cut and deburr metal. You can even use it to shape and cut plastic or polish silver.

If we were to list all the ways you could use the Dremel Moto-Tool, this ad would go on forever. However, you can get a 95 page, detailed guide that explains bits, speeds and 175+ uses, in specially marked Moto-Tool boxes at hardware, home center and hobby stores. Or write to Dremel, Dept. W, P.O. Box 1468, Racine, WI 53406-1468, for a free copy.

DREMEL® MOTO-TOOL®
High-Speed Rotary Tool

1994



Contest

ENTER TODAY!

For rules and entry form, look in the October '93 issue of WOOD Magazine, pages 82&83 or send a self addressed stamped envelope to:

Build-A-Toy Contest
WOOD Magazine
1912 Grand Ave.
Des Moines, IA 50309-3379

Entry Deadline is Feb. 1, 1994

Build a **SHOP OF YOUR OWN**
for prices you could only
dream about

LIMITED OFFER



EASY DO-IT-YOURSELF CONSTRUCTION
PACKAGES INCLUDE STEEL, FRAMES,
SHEETING AND HARDWARE

30X36
Value \$6,552
NOW \$3,359

36x48
Value \$10,349
NOW \$5,317

40x60
Value \$14,779
NOW \$7,731

46x72
Value \$20,008
NOW \$10,935

Other Sizes Available



1-800-843-8275
FAX 612-544-1835

Made in America

WM

CRAFTSMAN EQUIP YOUR SHOP AT GREAT SAVINGS

Catalog of over 300 plans to
build your own tools,
\$1.00, refundable



A wide variety of plans from complete machines & attachments to handtools for home, school & commercial shops. Featured also are accessories for wood and metal cutting lathes, drills, saws, sanders etc., plus things to make of wood and metal.

WOOD-MET SERVICES

3314 WEST SHOFF CIR. DEPT. WOOD
PEORIA, ILLINOIS 61604

Van Dyke's

Presents a
Catalog

with supplies for
upholstery, antique
restoration, wood
working, caning,
brass hardware,
carvings and many
related trades!



40 Years in Creative Arts & Trades

Many Hard-To-Find Items!

SEND \$1.00 FOR CATALOG TO:
VAN DYKE'S RESTORERS
Dept. D55, P.O. Box 278, Woonsocket, SD 57385

"Watch Dog" Bessy Plan



This watchful Bessy guards the presents under your tree. If she's nudged, the "moo" alarm will sound! All patterns drawn **FULL SIZE**. Made from 3/4 and 1-1/2 inch stock. Measures 16-1/2" high x 19" long.

#W1216 "Watch Dog" Bessy Plan.....\$7.99/SET

"Watch Dog" Bessy Hardware Parts

This hardware package contains a white pom pom, rope, turn buttons, cow-moos, black nostrils, Bessy eyes, 1-1/2" wood letters, and screws. Project plan, paint and remaining wood are **not included**.

#1305 Bessy Hardware Parts.....\$6.99/PKG

HOW TO ORDER: List quantity, part number, item, price & total of order. Include \$5.45 delivery charges per order. MN residents add 6.5% sales tax. Mail check or money order.

Credit card customers call
TOLL FREE 1-800-441-9870.

MEISEL HARDWARE SPECIALTIES
P.O. BOX 70 B9 MOUND, MN 55364

Buy **DIRECT** from the
Manufacturer
and... **SAVE!**

NEW!

White Non-Loading SANDING BELTS



The Ultimate Woodworking BELT.

Buy 1-Doz. BELTS... Get 12 FREE!

1"x 30" (12 + 12 Free)	\$18.50	4"x 21" (12 + 12 Free)	\$25.75
1"x 42" (12 + 12 Free)	18.95	4"x 24" (12 + 12 Free)	26.95
3"x 21" (12 + 12 Free)	21.95	4"x 36" (12 + 12 Free)	32.95
3"x 24" (12 + 12 Free)	22.95	6"x 48" (6 + 6 Free)	40.95

(Available 60x, 80x, 100x, 120x, 150x, 180x). Try our NEW White Non-Loading Cloth in Discs, Wide Belts, Edge & Stroke Belts!

NEW!

Hook & Loop SANDING DISCS

Buy any 3 (50 pks)...Get 4th pack FREE.

	80 GRIT	100 TO 400 GRIT	
4 1/2" (8 hole)	\$13.95	\$12.95	<ul style="list-style-type: none"> All grits in solid packs of 50. Coarse grit sizes are available.
5" (5 hole)	13.95	12.95	
5" (8 hole)	13.95	12.95	
6" (6 hole)	16.95	15.95	
6" (8 hole)	16.95	15.95	

TOLL FREE 1-800-428-2222

• S. & H. - \$4.75
• PA residents add 6% sales tax.

**INDUSTRIAL
BRASIVES CO.**
643 N. 8th ST. • P.O. BOX 14955
READING, PA 19612

Fine Woodworking Tools...

Since 1928, demanding craftsmen have found that there's only one source for the finest tools...

WOODCRAFT®

For a FREE catalog
call: 1-800-542-9115

- Starrett • Wood River
- Lie-Nielsen
- Pheil Swiss Made
- Clifton • Record
- Stanley • Sandvik
- Veritas • Ulmia
- Plus Many More

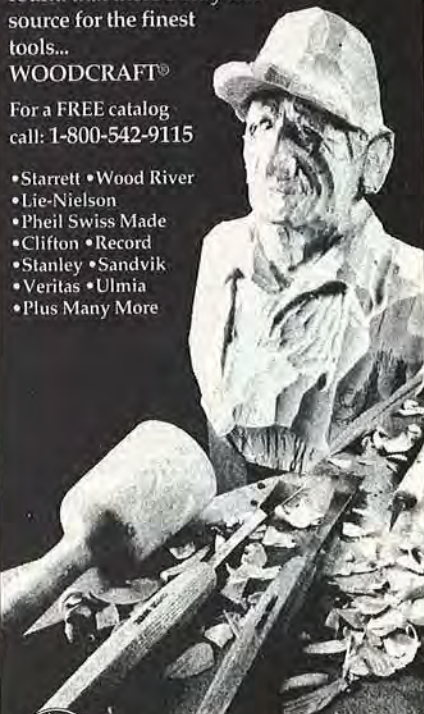

WOODCRAFT®

Woodcraft Supply Dept. 93W125
PO Box 1686 Parkersburg, WV 26102-1686

PORTER+CABLE

100	7/8 HP ROUTER	599
102	DOOR HANGING KIT	328
310	PRODUCTION LAMINATE TRIMMER	142
312	PRODUCTION OFFSET LAMIN TRIMMER	164
314	4 1/2" TRIM SAW	137
315-1	7 1/4" BUILDERS SAW	118
345	SAW BOSS 6" CIRCULAR SAW	104
347	7 1/4" FRAMERS SAW 15 AMP, 10.25 LBS.	128
330	SPEED BLOCK FIN SANDR S57 AFT. RBT.	47
332	QUIKSAND 5" RNDM ORB W/STIKIT PAD	63
333	QUIKSAND W/HOOK & LOOP, DUSTLES	73
334	QUIKSAND W/STIKIT, DUSTLESS	73
351	3" X 21" BELT SANDER	142
352	3" X 21" BELT SANDER W/DUST BAG	147
352VS	3" X 21" VS BELT SANDR W/DUST BAG	158
360	3" X 24" BELT SANDER W/DUST BAG	182
361	3" X 24" BELT SANDER	174
362	4" X 24" BELT SANDER W/DUST BAG	188
363	4" X 24" BELT SANDER	184
368-8	8 1/4" BUILDERS SAW	147
410	UNDERSCRIBE LAMINATE TRIMMER	150
411	MITER FOLD LAMINATE TRIMMER	165
447	7 1/4" FRAMERS SAW W/BRAKE, 15 AMP	138
503	3" X 24" BELT SNDR W/BAG, X HVY DTY	345
504	3" X 24" BELT SNDR XTRA HEAVY DTY	335
506	1/2 SHT FIN SANDER	118
548	BAYONET SAW WORM DRIVE	194
550	NEW POCKET CUTTER	178
556	BISC JOINER W/CASE & TILT FENCE	177
617	7 1/4" BUILDERS SAW	119
690	1 1/2 HP ROUTER W/1/4" & 1/2" COLLETS	139
9690	1 1/2 HP ROUTER W/CASE	139
691	1 1/2 HP "D" HANDLE ROUTER	143
693	PLUNGE BASE ROUTER, 1 1/2 HP	164
695	SHAPER TABLE W/ 1 1/2 HP ROUTER	213
696	SHAPER TABLE	123
2620	3/8" VSR DRILL, 0-1200 RPM W/CHK	99
2621	3/8" VSR DRILL, 0-1200 RPM KEYLESS	99
2640	DRYWALL VSR DRVR, 4.5 A, 0-4000 RPM	79
508	DOVETAIL TEMPLATE	76
5093	MORTISE & TENON JIG	44
5116	OMNI JIG	258
6615	1 1/2" VSR DRILL, 5.5 AMP, KEYLSS CK	123
6631	PLUNGE ROUTER BASE	74
7116	NEW 24" OMNIIJIG	289
7310	LAMINATE TRIMMER, 5.6 AMP	88
7312	OFFSET TRIMMER	122
7319	TILT BASE TRIMMER	99
7335	5" RANDOM ORBIT SANDER, VS	128
7336	6" RANDOM ORBIT SANDER, VS	132
73333	RANDOM ORBIT DUST EXTRACTION	24
7349	BAYONET SAW	115
7518	3 1/4 HP FIXED BASE ROUTER-5 SPEED	262
7519	3 1/4 HP FIXED BASE ROUTER-1 SP	238
7536	2 1/2 HP FIXED BASE ROUTER	197
7537	2 1/2 HP FIXED BASE "D" HNDL RTR	207
7538	3 1/4 HP PLUNGE ROUTER-1 SPEED	238
7539	3 1/4 HP PLUNGE ROUTER-5 SPEED	262
7549	TOP HANDLE BAYONET SAW	143
7649	BARREL GRIP BAYONET SAW	143
7700	NEW 10" LASERLOC MITER SAW	338
9118	PORTA PLANE KIT W/CASE, CRBD BLD.	203
9314	4 1/2" TRIM SAW KIT	148
9315	7 1/4" BUILDERS SAW KIT	138
9345	SAW BOSS 6" CIRCULAR SAW KIT	122
9347	7 1/4" FRAMER SAW W/CASE, 15 AMP	140
9367	3 1/4" PLANER KIT	144
9548	WORM GEAR BAYONET SAW KIT	210
9617	7 1/4" BUILDERS SAW KIT	138
9637	TIGER SAW VAR SPD RECIP SAW KIT	138
9840	CRDLS DRILL KIT W/2 BAT, CS KYLS CK	158
9647	TIGER CUB RECIP SAW KIT	115
9893	12 V, 3/8" CRDLS KIT, VS KEYLESS CHK	148
8653S	SAME AS ABOVE BUT W/2 BATTERIES!	177
97310	LAMNT TRIMMR KIT W/4 BASES & CS	189
97751	1 1/2" VS, 2 SPD HAMMER DRILL KIT	145

RYOBI

BT3000S	10" TABLE SAW WITH STAND	529
AP12	12" PORTABLE PLANER	398
TSS220	8 1/2" SLIDE COMPOUND MITR SAW	438
OSS450	OSCILLATING SPINDLE SANDR	174
D38VSR	3/8" VSR DRILL, 4.0 AMP, 0-2500 RPM	59

QUICK-GRIP BAR CLAMPS

00506	6" BAR CLAMP	14
00512	12" BAR CLAMP	17
00518	18" BAR CLAMP	18
00524	24" BAR CLAMP	18
00536	36" BAR CLAMP	23
05162	2 PC 6" BAR CLAMP GIFT PACK	23

DELTA

31-980	1" BELT/5" DISC SANDER	93
31-280	6" BELT/12" DISC SANDER, 1 1/2 HP	748
31-450	4" BELT/6" DISC SANDER	129
36-220	10" COMPOUND MITER SAW	239
40-560	16" SCROLL SAW, 2 SPEED	179
40-540	20" VS SCROLL SAW	299
22-540	12" BENCH TOP PLANER	399
28-180	BENCH TOP BAND SAW	167
39-760	NEW SIDEKICK 6 1/2" FRAME & TRIM SAW	369
37-070	NEW/6" VS BENCH JOINER	249
50-075	DUST COLLECTOR/SWEEPER, 3/4 HP	245
50-175	NEW KICKSTAND PRTLB WORK STAND	169

DELTA SPECIAL EDITION UNSAW 36-820
3 HP, 1 PHASE W/52" UNIFENCE SAW GUIDE \$1499 PLUS
\$50 SHIPPING ANYWHERE IN CONTINENTAL U.S.A

AEG

TXE150	6" VS DUST FREE RANDOM ORBIT SANDER W/VELCRO PAD	\$144
--------	--	-------

Panasonic

EY618ICRKW	NEW PREDATOR 9.6V CORDLESS KIT COMPACT, LIGHTWEIGHT, HIGHER TORQUE, KYLS CHUCK, 22 STAGE CLUTCH INC 2 BAT, CHRGR & CASE	162
EY6205EQK	12V, 3/8" KYLS CHK, VSR CRDLS W/15 MIN CHRGR, CSE & NEW IRONMAN BATTERY	189
EY6207BC	12V, 1/2" KYLS CHK, VSR, CRDLS W/15 MIN CHARGE & CASE	215

senco

HURRY... WHILE QUANTITIES LAST!

SLP20	NEW PINNER, 5 8" - 1 5 8" CAP W/CS	241
SN200R	ROOFING NAILER	375
SN70	FRAMING NAILER-6 TO 16 PENNY	467
SN325	FRAMING NAILER-6 TO 12 PENNY	384
SFN1-2	FINISH NAILER-1" TO 2" CAPACITY	239

HURRY... WHILE QUANTITIES LAST!

25' x 1" POWERLOCK TAPE	\$8.95
-------------------------	--------

Emglo

AM78HC4V	1 1/2 HP COMPRESSOR	\$299.00
----------	---------------------	----------

'TIS THE SEASON FOR PORTER+CABLE HOLIDAY KITS!



Biscuit Joiner Kit

MODEL 556K



Includes Plate Joiner with Standard Fence, Tilt Fence & 1000 Biscuits. Includes blade, wrenches, case

\$199.00

Bayonet Saw Kit

MODEL 7549K



Includes Top Handle Jig Saw w/case & 10 assorted blades. 4.8 amp motor, electronic speed control, universal blade clamp; orbital

\$152.00

1 1/2 hp Router Kit

MODEL 690K



Includes 1 1/2 hp Router with case, edge guide, & template guide kit with 1/2" & 1/4" collets

\$169.00

10" Miter Saw Kit

MODEL 7700K



Includes 10" Laserloc Miter Saw with dust bag assembly, extension wings, clamp, & 40T carbide blade

Exclusive Laserloc line of cut indicator takes the guess work out of aligning cut mark with the blade. Will cut a 2" x 6" at 90° and a 4" x 4" at 45°! Spindle lock, positive stops, only 36 lbs.

\$379.00

QuickSand™ KITS

MODEL 333K



Dustless Random Orbit Sander with 50 sheets of hook & loop sandpaper & case

\$99.00

MODEL 334K



Dustless Random Orbit Sander with 100 sheets of Stikit sandpaper & case

\$99.00

MODEL 332K

Random Orbit Sander with 100 sheets of Stikit sandpaper & case

\$89.00

6" Random Orbit Sander Kit

MODEL 7336K



Includes 6" VS Random Orbit sander with case, dust extraction system & 100 sheets Stikit paper

\$179.00

9.6V Cordless Drill Kit

MODEL 9840



3/8" Cordless VSR Driver Drill kit with 2 batteries, case, and keyless chuck. Includes exclusive one year battery warranty!

\$158.00

1/4 Sheet Finishing Sander Kit

MODEL 330K



Includes 1/4 Sheet Finishing Sander with case & 2 10 yard rolls of Stikit paper. Price after \$10 rebate

\$84.00

Jorgensen

ITEM	JAW LENGTH	OPEN CAP	OUR PRICE EACH	BOX OF 6
ADJUSTABLE HANDSCREWS				
#0	8"	4 1/2"	11.85	60.90
#1	10"	6"	12.85	70.60
#2	12"	8 1/2"	14.95	80.90
#3	14"	10"	18.95	104.90
#4	16"	12"	24.95	143.90
STYLE #7 2 1/2" THROAT 1 3/4" x 3 3/4"				
3706	5"	6 1/2"	6.20	34.50
3712	6"	8"	6.70	37.50
3718	8"	10"	7.20	40.50
3724	10"	12"	8.20	43.50
3730	12"	14"	9.10	49.50
3736	14"	16"	10.20	55.50
PONY CLAMP FIXTURES				
#50	3 1/4" BLACK PIPE CLAMPS			7.85
	BOX OF 12 S84 90			
#52	1 1/2" BLACK PIPE CLAMPS			6.50
	BOX OF 12 S69 50			
PONY SPRING CLAMPS - 3201HT 1"				
3202HT 2"	1.79	3203HT 3"	1.25	3.89

HITACHI

D100KBE	9.6V, CRDLS DRILL KIT W/2BAT & CS-KYLS	148
DB90VMBE	12V CORDLESS DRILL KIT W/2 BAT	188
D10VC	3/8" DRILL VAR SP, REV, 3.2 AMPS	59
SAT180	7" SANDER POLISHER 6.9 AMP, 2 SP	139
SP18V	7" SANDER POLISHER, VS, 9.2 AMP	149
SV12SA	43/8" PALM GRIP SANDER	48
SV12SD	4 1/2" ORBITAL SANDER W/DUST BAG	125
SV12V	4 1/2" ORBITAL W/BAG, VAR SPEED	142
SB75	3"x21", 2 SPEED BELT SANDER	126
SB10T	4"x24", 2 SPEED BELT SANDER	180
CJ6S/2	TOP HANDLE JIG SAW W/CASE	155
P20SB	3 1/4" PLANER, 3.4 AMP	89
TR6	LAMINATE TRIMMER	92
M8V	VAR SPEED PLUNGE ROUTER, 1 1/4"	149
TR12	3 HP PLUNGE ROUTER	184
M12V	3 HP VAR SPEED PLUNGE ROUTER	224
P12R	12" PORTABLE PLANER	799
P12RA	12" PORTABLE PLANER / 6" JOINER	999
G12SA	4 1/2" GRINDER, 6.9 AMP	79
G18SE2	7" GRINDER, 15 AMP	124

MIRKA Abrasives, Inc.



6" SOLID PSA PAPER - 100 PER ROLL	80-320 GRIT	\$12.95
5" HOLED PSA PAPER - 100 PER ROLL FOR PORTER CABLE 5" HOLED PADS - 80-320 GRIT		12.95
6" SOLID PSA PAPER - 100 PER ROLL	80-400 GRIT	15.95
6" HOLED PSA PAPER - 100 PER ROLL FOR PORTER CABLE 6" HOLED PAD	80 GRIT	17.95
	100-320 GRIT	16.95
5" HOOK & LOOP PAPER FOR PORTER CABLE 5" HOOK & LOOP PADS - 50 PER BOX	80-320 GRIT	10.95
5" HOOK & LOOP PAPER FOR BOSCH 3283DVS 50 PER BOX	80-320 GRIT	10.95
6" HOOK & LOOP PAPER FOR BOSCH 1370DEV5 50 PER BOX	80-320 GRIT	12.95

INTERNATIONAL TOOL CORPORATION

1939 TYLER STREET, HOLLYWOOD, FLORIDA 33020

1-800-338-3384

FREE FREIGHT & SAME DAY SHIPPING ON MOST UPS ORDERS OVER \$25.00 MINIMUM PURCHASE WITHIN THE CONTINENTAL U.S.A.

QUANTITIES LIMITED - NOT RESPONSIBLE FOR TYPOGRAPHICAL ERRORS - PRICES SUBJECT TO CHANGE WITHOUT NOTICE FAX US YOUR ORDER AT 1-305-927-0291

HOLIDAY GIFT LIST



Over 70 great gift ideas for our woodworking readers!

□ Get your hands on one of the new cordless drills from Freud.



Features include: Rohm keyless chuck with lock function, unique ergonomic design, quick stop on switch release for complete control, rare earth Neodyme magnets in the high torque motors. EDS96 - 9.6V, EDS120 - 12V, EDS132 - 13.2V. Call **FREUD** for details, 1-800-472-7307.



□ Heirloom Wood Toy Patterns—The Rainbow Ark is our most popular children's toy. A perfect holiday gift! Send \$2 for our catalog of full-size patterns, kits and finished toys. Original designs based on our exclusive puzzle-concept. Children's and executive's toys. **BALDWIN TOY COMPANY**, P.O. Box 37014 GL, Omaha, NE 68137-0014.

□ CMT Tools' full-color router bit, saw blade and accessory catalog is packed with great gifts for the woodworker.



Call for your copy, and we'll give you a **\$10 DISCOUNT** on your first order! **CMT TOOLS**, 5425 Beaumont Center Blvd., Suite 900, Tampa, FL 33634. 1-800-531-5559.

□ Grandma's Pie Safe Kit—Create a memory with this up-to-date version of an old classic. Stands 54" h. x 32" w. x 12" d. Kit contains scale drawings and plans for wooden cabinet, full cutting and assembly instructions + 8 pieces of tin, 3 sets of piercing designs, a metal punch and chisel plus piercing and finishing how-tos. Only \$50 postpaid. **COUNTRY ACCENTS**, P.O. Box 437 Montoursville, PA 17754.



□ Professional-quality weather stations affordable enough for home use, starting at \$195! Monitor temperature, barometric pressure, humidity, wind speed, direction, chill, rainfall and dew point. Options: NEW (0.01" or 0.2mm) Rain Collector and PC interface for IBM and MAC. Free catalog, call 1-800-678-3669, or write: **DAVIS INSTRUMENTS**, 3465 Diablo Ave., Hayward, CA 94545.



□ NEW! Craft & Woodworking Catalog. Top-quality tools & accessories for your shop. Includes complete information & prices on HEGNER Precision Scroll Saws, blades, & accessories for other scroll saws, HEGNER Lathes & Duplicators, HEGNER Accura Precision combination machine, PLANO Vertical Glue Press, FELDER Woodworking Systems, bar clamps & more. Free catalog. Call 302-322-2226. **ADVANCED MACHINERY IMPORTS**, P.O. Box 312, Dept. 589, New Castle, DE 19720.



□ Here's a complete antique picture frame restoration kit, including training manual and video, that show you how to capture big profits fixing frames. Frame-Kit is a great add-on business or part-time opportunity. Complete furniture restoration catalog: \$2. Free workshops, **MINUTEMAN, INC.**, Dept. 17, 115 N. Monroe, Waterloo, WI 53594. 1-800-733-1776.



□ Beat "cam-out" with the incredible square drive screw. "Do-it yourself dozen" assortment includes 1200 screws, 3 driver bits and 12 storage bins for just \$59.95 + \$7 S&H (48 States only) Save over \$13.00! Catalog \$1, free with order. **MCFEELY'S**, P.O. Box 3, Lynchburg, VA 24505. 1-800-443-7937.



□ Porter Cable #333 random orbit finishing sander. Perfect for swirl free sanding. Exclusive sandtrap canister collects and holds dust while you sand. Uses hook and loop abrasives for quick and easy paper changes. List price \$131, yours for \$68 from **TOOLS ON SALE™**, 216 W 7th St., St. Paul MN 55102. Call toll free 1-800-328-0457.



□ Plymate Saw Guide—Perfect gift for the woodworker. Easy, fast, accurate, portable. One person can now cut 4 x 8 sheets of plywood accurately using a circular saw. Made in USA of sturdy aluminum and tempered hardboard. Order now for Christmas. **OLIVE KNOT PRODUCTS**, 1-800-759-6283.



□ Weatherstripping machine easily grooves old door and hinged window jambs to accept our superior quality silicone rubber seals. Only \$195 for complete kit (seals extra). **RESOURCE CONSERVATION TECHNOLOGY**, 2633 N Calvert Street, Baltimore, MD 21218. 410-366-1146.

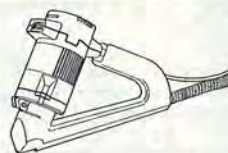

□ This hot branding tool allows the user to brand wood projects quickly and easily. It heats in approximately 1-2 minutes with an ordinary propane torch. Has solid brass head with 1st line reading: **HAND CRAFTED BY** and 2nd line your choice, up to 20 characters and spaces. \$32.00 ppd. 1, 2, 3 and 4 line units also available with standard top line or other copy. Electric units also available. Order TOLL-FREE at 1-800-826-7606. By mail: **NOVA TOOL CO.**, PO Box 29341, Dept. BGL, Lincoln, NE 68529.



□ The Ripsaw Mini Mill weighs 45 lbs. and can be easily handled by one person. Will cut dimensional lumber from logs up to 20" diameter x 26' long. Ripsaw will produce from 1/8" to 9" depth and up to 14" wide lumber. Write or call for free brochure. Video available. **BETTER BUILT CORPORATION**, 845 Woburn Street, Dept. W, Wilmington, MA 01887. 508-657-5636.



□ New for the router. Versatile multi-tool guide is used for designing, previewing, marking layout, setting stops, and guiding cuts. Simply substitute any router for the pencil in the guide and accurately cut patterns you have marked. \$37.95 from **MARK-N-CUT DISTRIBUTORS, INC.**, 115 Hubert Siler Road, Williamsburg, KY 40769. Phone 606-549-0524.



□ Swedish miter makes easy work of cutting perfect picture frames and moldings with its thin, tensioned 18tpi blade. Max size of workpiece at 90°; 6 1/2" wide x 4 1/2" high. 5 pre-set stops. \$128.20 ppd. **GARRETT WADE CO.**, 800-221-2942.



□ Parts for making beautiful gold plated wooden barrel pens, pencils, rollerball pens, fountain pens plus more. Kit and instructions available. Easy to make. Call or write: **THE BEREA HARD WOODS CO.**, 6367 Eastland Rd. Brookpark, OH 44142. 216-234-7949.



□ Like a third hand. Provides that extra support so often needed. Its rugged, heavy-duty, all-steel construction makes it a tool you'll depend on for years. Roller is 13" long, galvanized and ball bearing. Adjusts in height from 25 3/4" to 45". When you're done it folds flat. #HPR-13, \$39.95+ UPS. **HTC PRODUCTS, INC.** Toll free 1-800-624-2027.

□ Mantel Tambour Clock. Molding along crown



and raised accents of Carpathian elm enhance the beauty of the Roman time ring dial. Solid oak kit includes a quartz chiming movement that plays the Westminster melody on the hour, strikes each 1/2 hour & counts the hours. Finished clock is 10" high x 17-1/2" wide x 5-13/16" deep. Order #34553. \$119.95 plus tax, s&h. **KLOCKIT** P.O. Box 636, Dept. WD113, Lake Geneva, WI 53147. 1-800-556-2548.

BOULTER PLYWOOD

One Stop Wood Shop

□ Hardwood plywood, 30 species in stock (exotics made to order). Hardwood lumber and marine plywood all under one roof. Custom cutting services to your exact specifications with little or no waste and at competitive prices! And, we specialize in handling and shipping. Call 617-666-1340 today for catalog and quotations. **BOULTER PLYWOOD CORP.** 24-GL Broadway, Somerville, MA 02145.



□ New power tool eliminates hand sanding. Unique sander sands along edges and into corners, without bouncing off or running away. The secret is distinct triangular sanding pad, combined with a high speed oscillation. German made. Brochure shows sander in action. Call **TREND LINES**. 1-800-767-9999.

□ Personalize your finished projects with BrandMark's solid brass, torch heated or electric branding irons. Makes an ideal gift. Custom wording available. Standard "HANDCRAFTED BY" and your name (20 Letters), \$28.00. Electric \$48.00. Add \$3.00 s/h. Order by phone with credit card or mail check to: **BRANDMARK**, Dept. G-3, 462 Carthage Dr., Beavercreek, OH 45434. 800-323-2570 or 513-426-6843.



□ Penn State's new full color catalog features special pricing on a new award winning air cleaning system & portable panel saw system. Sale pricing on scroll saws, planers, dust collectors, air guns, & many exclusive "one-of-a-kind" woodworking accessories & projects. Free catalog: **PENN STATE INDUSTRIES**, 2850 Comly Road, Philadelphia, PA 19154. 1-800-377-7297.



□ Catalog of over 300 plans to build your own tools.



A wide variety of plans from complete machines and attachments to handtools for home, school and commercial shops. Featured also are accessories for wood and metal cutting lathes, drills, saws, sanders, etc., plus things to make of wood and metal. Send \$1.00 refundable with order. **WOOD-MET SERVICES, INC.** 3314 W. Shoff Cir., Peoria, IL 61604.

□ This 16-piece Forstner Bit Set is what every wood-



worker wants. Bits range in size from 1/4" up to a massive 2 1/8" in 1/8" increments. Forstner bits produce clean-sided, flat-bottomed holes that are perfect for mortising, pocket holes and doweling. Call 24 hours a day, 1-800-235-0272. Order part number C3188 for only \$89.95. **CASCADE TOOLS INC.**, Box 3110, Bellingham, WA 98227.



□ Executive Wood Toys! Now you can create this 1929 Ford van and many others like it from our detailed and easy-to-read patterns. We offer you a complete line of patterns, parts, and wheels. Make this holiday season a time to remember with our Executive Wood Toys. Send \$1.00 for catalog to: **TOYS AND JOYS**, Box 628 GL, Lynden, WA 98264.



□ The Dupli-Carver is a wood duplicating machine that can reproduce three-dimensional carving in wood. The machine uses a stylus (tracer) to follow the contours of a statue or plaque. Two models starting at \$395. **WOODMIZER®**, 8180 W. 10th St. Dept. Q078, Indianapolis, IN 46214. 800-553-0219 or 317-271-1542.

□ New from Calculated Industries, the Construction Master III gives you the power to both work in and convert feet, inches, fractions, yards, board feet, and metric measurements. Instantly solves rafters, stairs, circular problems, and dimensional conversions. Includes user's guide, case, battery and 1-year warranty for just \$69. Available from **ABBEY TOOLS**, 1132 N. Magnolia, Anaheim, CA. 1-800-225-6321.



□ Collectors wood samples—Unique gift for woodworkers. 30 gorgeous woods—1/2" x 3" x 6", sanded and individually labeled. Ideal for collectors, cabinet and furniture makers, designers, architects, and wood enthusiasts. \$39.00 ppd cont. U.S., including **BOOK OF FINE HARDWOODS**, with 70 color pictures, \$51.00 ppd cont. U.S. **WOODWORKERS SOURCE**, 5402 S. 40th Street, Phoenix, AZ 85040 or 800-423-2450.



□ Heavy duty plate jointer kit with biscuits. Dewart plate jointer, 6.5 amp 10,000 rpm motor.



Machined aluminum rack and pinion fence. Tilts 0-90° and has preset depth stops for #0, #10, #20 biscuits. Includes 6 tooth carbide blade, dust bag, dust deflector, vacuum adaptor, Torx screwdriver, wrench and heavy duty steel carrying case. \$225! Free freight and same day shipping. **TOOL CRIB**, P.O. Box 1716, Grand Forks, ND 58206. 1-800-358-3096. VISA, MasterCard, and Discover accepted.

□ Dry your own lumber using our equipment and your insulated chamber. Dehumidification systems from 300 BF to 45,000 BF. Easy to operate equipment offers high quality kiln-dried lumber for pennies per foot. These long-lasting made-in-the-USA units can pay for themselves in one month! Free Catalog. **NYLE STANDARD DRYERS, INC.** P.O. BOX 1107, Bangor, ME 04402. 207-989-4335.



□ Project Plans—Full size patterns for over 400 easy-to-build woodworking projects. Nation's leading source for scroll saw patterns, cow projects, toy plans, yard ornaments, wood furniture, etc. Over 3,000 hard-to-find specialty items. Send \$2.00 for your giant new 96 page catalog. **MEISEL HARDWARE SPECIALTIES**, P.O. Box 70, Mound, MN 55364.



□ Free \$88.00 Blade included with new Milwaukee Miter Saw. In a special limited offer while supplies last, the new heavy-duty 10" MILWAUKEE miter saw now includes a free 80 tooth \$88.00 carbide-tipped blade. To learn more about the many patented MILWAUKEE miter saw features, including a unique axis mechanism and override locking feature, see your nearest MILWAUKEE retailer under Tools/Electric in the Yellow Pages.



□ 30 lbs. of assorted hardwoods. Excellent for small crafts and toys. Random species and thicknesses. All surfaced 2 sides, 1/2" - 2" thick, 3" - 10" wide and 6" - 24" long. Shipped UPS prepaid, \$29.95. **STEVE H. WALL LUMBER CO.**, Rt. 1, Box 287, Mayodan, NC 27027. 1-800-633-4062 or 919-427-0637.

□ Build a historic wooden ship model! The largest selection of authentic wooden ship models—museum quality replicas you build yourself. Models up to 4 feet long with pre-cut wooden parts, metal and brass fittings. Even first time builders can create a magnificent keepsake. Send \$1 for 92-page color catalog. **MODEL EXPO, INC.** P.O. Box 1000, Mt. Pocono, PA 18344.



□ Laguna Tools 18" band saw, 2 HP motor, top and bottom guides. 11" resaw capacity. Heavy duty machine with cast iron table and wheels. Blade from 1/8" to 1" width. Tilt table. Rack and pinion on upper blade guard. Foot brake. Very smooth and quiet. Call 1-800-234-1976 for more information. **LAGUNA TOOLS**, 2081 Laguna Canyon Rd., Laguna Beach, CA 92651.



□ Woodcraft offers over 4,000 of the finest quality woodworking tools, books and supplies available today. 90 day guarantee of satisfaction. Call or write for free 148 page catalog. **WOODCRAFT**, P.O. Box 1686, Dept. 93W12T, Parkersburg, WV 26102-1686. 1-800-542-9115.



□ The secret of success with the SCM system is the ultra-high-speed handpiece, plus an extremely simple stencil design system. You can use a variety of stock stencils supplied by SCM or make your own on a copying machine. Operating at 400,000 rpm, the SCM engraver is the fastest handpiece on the market. Send for information.
SCM ENTERPRISE, W 168 N 11318 Western Ave., Germantown, WI 53022. 1-800-755-0261.



□ The Delta 12" Portable Planer surfaces stock from 1/8" to 6" thick. Solid steel 2-knife ball-bearing cutterhead assures maintenance-free operation. High-speed, double-edged, reversible knives project only .065" above the cutterhead surface reduces kickback & noise. Full 15 amp motor powers cutterhead & feed rolls. Feed rate adjusts under load for optimum planing. Delta 2-year limited warranty. For dealer nearest you 1-800-438-2486. In Canada, 519-836-2840.



Wood Carvers Supply, Inc.

□ Learn how to make & carve wooden canes! Our exclusive book **WALKING & WORKING STICKS** guides you with clear directions & photos for every step; 128pp. Order #290000 \$19.90 post paid. Also ask for our 76 page color catalog with over 2,000 carving tools, books & supplies \$2 (free with order). **WOOD CARVERS SUPPLY, INC.**, P.O. Box 7500-W, Englewood, FL 34295 or call 1-800-284-6229.



□ New! **THE WOODWORKERS' STORE** 1993/94 catalog. 200+ new items, 104 full color pages of domestic and exotic hard-woods, veneers, wood parts, specialty hard-ware, kitchen access., finishing supplies, tools, books, & plans. Many exclusive items and hard-to-find specialties. Orders shipped in 24-48 hours. 39+ years in business! Satisfaction guaranteed. Catalog \$2. 1-800-403-9736. 21801 Industrial Blvd., Dept. 33125, Rogers, MN 55374.



□ The "Wood-Friendly"™ L606 uses advanced electromagnetic wave technology to accurately measure wood moisture content from 6% to 30% to a depth of 3/4". No pins to "abuse" wood and leave ugly holes. Convenient pocket size, easy-to-read analog meter, and low price make it a must for all woodworkers. Free literature. **WAGNER ELECTRONIC PRODUCTS, INC.** 1-800-944-7078.



□ Craft Supplies USA offers the finest selection of woodturning tools, machinery and accessories available anywhere. Also available are pen and pencil kits as well as many other project kits. Send \$2.00 for a 48 page color catalog, refunded with order. **CRAFT SUPPLIES USA**, 1287 E. 1120 S., Provo, UT 84606. Phone 801-373-0917.



□ The **FINE TOOL JOURNAL**. A quarterly magazine for all interested in collecting or using hand tools.

Absentee tool auctions, tool evaluations, articles of interest, etc. Serving the public since 1970. Free brochure gives full details.
THE FINE TOOL JOURNAL, P.O. Box 4001, Pittsford, VT 05763.

□ Jennings 1/2 scale carving kit includes 1 - 10 inch basswood cutout, eyes, carving pattern and paint pattern. Or send \$1.00 for our 28-page carvers catalog full of carving tools, kits, and supplies. (Mallard, CO-MA-HK, \$12.95—Wood Duck, CO-WD-HK, \$12.95) Check, M.O., MCV, Dis. Plus \$2.90 S&H. **JENNINGS DECOY CO.**, 601 Franklin Ave. NE, St. Cloud, MN 56304. 1-800-331-5613



□ The new, improved **ZYLISS** portable vice—amazingly versatile, easily holds any size workpiece for nearly any task. The ideal gift for your favorite do-it-yourself or woodworker. Swiss quality, lifetime warranty plus free video and accessories (value \$304.85) now only \$199.95 plus \$10 shipping and handling. Offer ends 12/30/93. Call **ADVANCED MACHINERY**, 1-800-220-4264.



□ Skil's Biscuit Joiner, Model 1605-02, features a powerful 6 amp, 12,000 rpm motor, adjustable front fence for 90° and 45° corners and dust pickup. Includes carrying case. • **HOLIDAY SUPER SPECIAL** • Free glue bottle and 100 clamppress biscuits with biscuit joiner purchase. To order, call 1-800-338-3384 or write to: **INTERNATIONAL TOOL CORPORATION**, 1939 Tyler Street, Hollywood, FL 33020.



□ **JT-1008** 8" Jointer. \$639.00. Lobo Power Tool's products are stationary woodworking tools designed for home use and for professional woodworkers. Some of our product line includes table saws, band-saws, jointers, planers, shapers and sanders plus many more.
LOBO POWER TOOLS, 9031 E. Slauson Ave., Pico Rivera, CA 90660. 1-800-786-5626.



□ Color catalog featuring complete line of DeWALT Industrial Tools & Accessories, featuring recently expanded line of professional woodworking tools including new routers, planers, and belt sanders. Other tools include a 12" compound miter saw, fixed-based router, plate joiner, orbital action jig saws, and 1/4 sheet palm grip sander. Call 1-800-4-DeWALT for free catalog, and store and service locations.



□ **JET's** new 14" bandsaw with open stand, one piece welded closed stand and three speed models feature micro adjusting blade guides with cool-running "JET Blocks", 15" x 15" worktable, quick connect plug-in wiring and an extra wide cast iron frame for rock solid rigidity. Call for more information or the name of a nearby **JET** dealer, 1-800-274-6848.



□ **Cherry Tree Toys** carries a wide variety of top-quality parts, plans and kits to build toys, clocks, whirligigs, dollhouses, banks and more. Catalog \$1.00. **CHERRY TREE TOYS**, Box 369-335H, Belmont, OH 43718. 1-800-848-4363 ext. 335H.



□ The **Airlite Air Visor** features an impact-resistant polycarbonate visor for eye and face protection. The lightweight headpiece with filter weighs 1.1 pounds. A motor/fan, filter & battery are fitted into the headpiece, air flows directly over the face & visor. Fog-free. Provides relief from non-toxic dusts and prevents possible eye injuries. **RACAL HEALTH & SAFETY, INC.**, 7305 Executive Way, Frederick, MD 21701-8368. 1-800-682-9500.



□ Buy someone (or yourself) some time for Christmas! Don't spend hours with a hand-held belt sander. A Performax drum sander will dimension stock to a precise uniform thickness, clean up glued panels, & finish sand the thinnest veneers. Prices start at \$300. Brochure \$1. **PERFORMAX PRODUCTS, INC.**, 12211 Woodlake Drive, Dept. WD02, Burnsville, MN 55337. 1-800-334-4910 or 612-895-9922.



You Deserve Quality Hardwoods

□ Kiln dried Appalachian Hardwood - surfaced two sides, clear one face.
Advantage Pack - 25 bd. ft. 4'-10" wide - 30" to 60" long. Cherry \$79, Red Oak \$76, Poplar \$53, Maple \$72.
Short Pack - 50 lbs. 4' - 10" wide - 10" - 30" long. Cherry \$58, Red Oak \$56, Poplar \$49, Maple \$54. Includes freight to most destinations in eastern time zone. Visa/MC/Discover accepted.
BRISTOL VALLEY HARDWOODS, 4054 Rt 64, Canandaigua, NY 14424. 1-800-724-0132.
 Receive a free catalog with your order.

□ Our 10" Tilting Arbor Table Saw model #EN3302 is the best buy in today's market. It features a 3 horse power motor, precision lever lock fence syst., magnetic safety switch, and much more. Because of the holiday season, we'll give away a free "Enlon baseball cap and push stick" or "Enlon baseball cap and featherboard" with your purchase. To order call **ENLON IMPORT** at 1-800-888-9697. Offer available 12-1-93 through 2-15-94.



□ Decorate your yard with these easy to make stylish cutouts. Simple to cut out, paint and assemble. Store flat for next season! \$12.95 per plan (Shipping & handling, state and local taxes included if applicable.) Specify cutout: Lg. Reindeer, Med./Sm. Reindeer, Angel, Santa, or Sleigh. Send orders to **WOOD PLANS**, P.O. Box 9255, Dept. GL, Des Moines, IA 50306. 100% money back guarantee. Visa/MC orders 1-800-572-9350.



□ 6211DWE, 12V VSR Cordless Drill Kit with keyless chuck, charger, case and 2 batteries. List price \$397. Sale price \$168.



All States Call Toll Free
1-800-262-5482
HOMELUMBER CO.
 449 WHITEWATER ST., WHITEWATER, WI 53190

Worth writing for...



You can get useful ideas and product information by mail. Use the coupon in this section to order your choice of literature listed below. Each company mails the catalogs or information directly to you.

POWER TOOLS

SCROLL SAW, CRAFT & WOODWORKING CATALOG—Specialty products from the exclusive distributors of HEGNER, the precision saws with SCROLLVERGUEGEN. Complete information on scroll accessories, including blades and lettering guides. Also JET Clamps, HEGNER Lathes, PLANO Vertical Glue Press, and more. Toll-free customer service hotline included! AMI, LTD. \$2.00. *Circle No. 3.*

TOOL CRIB CATALOG—Since 1948, woodworkers, homebuilders, industry and schools across the country have looked to the Tool Crib as their source for power tools and equipment. Our prices are low; our sales people are knowledgeable; and our service is first-rate! We stock over 10,000 tools with top name brands like Black & Decker, Delta, Ryobi, Makita, Powermatic, Jet, Freud, Bosch, Porter Cable, Milwaukee and many more. We offer competitive prices with quality service and same day shipping. Send for your NEW 1993 catalog. It's worth it! TOOL CRIB. \$3.00. *Circle No. 6.*

TRANSPOWER, CP TOOLS INC.—A fine line of quality woodworking machinery, saws, shapers, planers and more. Send for free catalog. CP TOOLS INC. Free. *Circle No. 15.*

TOOLS AND SUPPLIES—for cabinetmaking, antique restoring, woodturning, wood carving, picture framing, chair caning, marquetry and more—over 4000 products in all are featured in Constantine's 1993 Woodworkers' Catalog. 116 pages, full color, with every product guaranteed to please or your money back. 2 year subscription. CONSTANTINE'S. \$1.00. *Circle No. 20.*

ENLON IMPORT CORP. GRAND OPENING—We would like to recognize you as our most important asset. We offer a large selection of fine woodworking machinery, tools and accessories for your business and home workshop. Take advantage of our grand opening specials. Send for catalog. ENLON IMPORT CORP. Free. *Circle No. 35.*

NEW POWER TOOL ELIMINATES HAND SANDING—No more bloody knuckle, sore finger sanding. Unique sander, sands along edges and into corners, without bouncing off or running away. The secret is the distinct triangular sanding pad, combined with a high speed oscillation. German made. Brochure shows sander in action. FEIN POWER TOOLS, INC. \$1.00. *Circle No. 37.*

INCA MACHINERY INFORMATION—Complete information on the famous line of Inca woodworking machines. Designed for precision work by the small to medium sized cabinet shop. Used by thousands of hobbyists and professionals. Table saws, bandsaws, joiner/planers, dust collector, radial arm saw. GARRETT WADE CO. Free. *Circle No. 44.*

HOME LUMBER—For the largest selection of Makita at the right price. We also provide great pricing on Amana Carbides, DeWalt power tools, Bostitch Air Nailers & David White Instruments. Same day shipping, free freight. We accept Visa, Mastercard, Discover, COD. Send for information. HOME LUMBER. \$1.00. *Circle No. 48.*

INTERNATIONAL TOOL CORPORATION CATALOG—features the best tools & accessories at the absolute lowest prices anywhere! Whether you are a home woodworker or an industrial user, you will find an incredible selection featuring Porter Cable, Bosch, Skil, Freud,

Delta, Milwaukee, Hitachi, and many, many more. We offer same day shipping, the most knowledgeable sales staff and free shipping on most UPS orders in the continental U.S. INTERNATIONAL TOOL CORP. Free. *Circle No. 49.*

LOBO POWER TOOLS—Fine crafted woodworking power tool, top quality, affordable prices. A commitment of customer satisfaction, with a full 1 year warranty. We sell a complete line with many options for our band saws, table saws, planers, jointers, double drum sanders, edge sanders, wide belt sanders, power feeders and many, many more. Send today for a free brochure. LOBO POWER TOOLS. Free. *Circle No. 57.*

GET TO THE FINISH LINE FASTER—with a Performax drum sander. Don't spend hours with a hand-held belt sander. Sand ultra-wide stock ultra-smooth in just minutes. Models start at \$300 to \$3495. Select the model that fits your budget and your needs. New metal abrasive fasteners keep sandpaper tight without re-wrapping. PERFORMAX PRODUCTS. \$1.00. *Circle No. 78.*

HAND LAMINATE & WOODWORKING TOOLS—A new catalog is now available that covers 25 groups of special hard-to-find industrial-quality hand tools. Included are VIRUTEX® slitters, PLASTI-CUT® files, laminate shears, scoring cutters, trimmers, plate joiners, and many more. PRACTICAL PRODUCTS CO. \$1.00. *Circle No. 82.*

WOODWORKING TOOLS & ACCESSORIES—While the history of RB Industries goes back 60 years, this is the first time we've brought together all our precision-made tools and accessories in one catalog. The Hawk Precision Scroll Saw, 4-in-1 Woodplaner, Panel Master Door Machine, Router System, and much more. Quality equipment built here in the heart of America. When you buy from us, you deal directly with the manufacturer. Our prices, quality, and 3 year Warranty reflect our commitment. Send today for FREE information. RB INDUSTRIES, INC. Free. *Circle No. 84.*

TOOLS ON SALE™—A division of Seven Corners Ace Hardware, Inc. offers a catalog of over 400 pages of the most popular brands of power tools available anywhere, all at discounted prices. Included are saws, planers, sanders, routers, drills and more from manufacturers such as Milwaukee, Makita, Porter Cable, Black & Decker, Dewalt, Freud, Bosch, Delta, and many more. Now introducing a full range of Werner brand ladders. Tools on Sale™ division of SEVEN CORNERS ACE HARDWARE, INC. \$1.00. *Circle No. 92.*

PORTABLE SAWMILLS—Convert logs into valuable lumber—Wood-Mizer® Products manufactures a line of portable bandsaw mills that allows the novice as well as the experienced sawyer to safely convert standing logs into lumber. Then, with the use of our SolaryDry™ Kiln or Vacu-Kiln™ to dry your lumber, you could increase the value of every board you produce. We manufacture some of the most progressive woodworking equipment on the market today. Product videos available. Send for our 31-page catalog. WOOD-MIZER PRODUCTS. \$2.00. *Circle No. 94.*

HAND TOOLS

MARK-N-CUT—Patented new multi-tool guide is used to design, measure, preview, mark layout, set tool stops, and guide cuts with any standard or plunge base router and other tools. Simply substitute the router for the pencil in the versatile guide for accurate cutting of circular, straight line, and multi-pivot designs you mark. Literature \$1.00—refunded with order. MARK-N-CUT DISTRIBUTORS, INC. \$1.00. *Circle No. 130.*

PERSONAL BRANDING IRONS—Brochure describes branding irons that enable you to put your name on your work quickly and easily. Made especially for branding wood, they are available with 1, 2, 3 or 4 lines of copy.

Changeable date also available. NOVA TOOL CO. \$1.00. *Circle No. 160.*

STAINS/FINISHES

ENVIRONMENTALLY SAFE FINISHING—High-solids lacquers, water-based varnishes, HVLP Sprayers, plus water and alcohol soluble stains and environmentally safe strippers are just a few of the 4000-plus products in Constantine's 1993 Woodworking Catalog. 116 pages of woods, veneers, moldings, trims, hardware, tools, books, plans and more—all guaranteed to please or your money back. 2 year subscription. CONSTANTINE'S. \$1.00. *Circle No. 210.*

PLANS

HEIRLOOM WOOD TOY PATTERNS—First time these original designs are available! A catalog of full-size patterns, kits and finished toys too. Unique patterns for every skill level. We have arks, cars, trucks, trains and much more. Designs are based on our exclusive puzzle concept. BALDWIN TOY COMPANY. \$2.00. *Circle No. 320.*

FULL-SIZE FURNITURE PLANS CATALOG—Illustrates and describes over 200 plans for making furniture of quality found in museums and fine furniture stores. Plans include rolltop desk, cradles, dining tables, chairs, buffets, chests, gun cabinets, poker table, children's furniture, rocking horse, spinning wheels, and more. Bill of materials exploded drawings assist the woodworker. FURNITURE DESIGNS, INC. \$3.00. *Circle No. 345.*

PROJECT PLANS—Full-size patterns for over 500 easy-to-build woodworking projects. Nation's leading source for scroll saw patterns, cow projects, toy plans, yard ornaments, wood furniture, etc. Over 3000 hard-to-find specialty items. Send for your big new 80-page catalog. MEISEL HARDWARE SPECIALTIES. \$2.00. *Circle No. 401.*

WOOD TOY PATTERNS—Patterns for all ages including children's patterns and executive toys. New catalog has many new patterns to choose from including parts and wheels. Send for new catalog today. TOYS AND JOYS. \$1.00. *Circle No. 465.*

BUILD A NEW UTILITY WAGON—for Christmas '93! This hi-tech 6 wheel design has a 2' x 4' cargo box, rear wheel suspension and automotive steering. Made of plywood, hardwood, and simple metal parts. Full sized blueprint pack \$15.95+\$2.50 S/H. Send \$2 for the Wings & Wheels 16 page catalog. WINGS AND WHEELS. \$2.00. *Circle No. 485.*

CRAFT AND GIFT PATTERNS—We have several different sets of unique pattern designs which have proven to be good sellers. Many of them can be made from scrap wood. With these unusual patterns you can actually take the scrap wood you were going to throw away and turn it into money in your pocket. Send \$3.00 for brochure, and we will also send you a free 2" letter and number pattern. WOOD CRAFT. \$3.00. *Circle No. 490.*

WOOD-MET SERVICES CATALOG LISTS SOME 700 PLANS—to build a wide variety of tools and accessories to equip your workshop. They vary from complete machines to hand tools, photo accessories to shop methods. Included are some 80 attachments for your lathes, drill presses & routers, over 60 hand tools, plus sander, welder, shaper, table saw accessories, etc. Others include a portable band sander, metal spinning tools, air compressor, 3/8" spindle wood shaper, wood lathe & chisels & a 12-in. thickness planer. Send for catalog, order plans, build the equipment for your shop and save. WOOD-MET. \$1.00. *Circle No. 496.*

LUMBER

QUALITY EXOTIC LUMBER/TURNING WOODS—We offer a comprehensive selection of fine quality exotic woods. Also available are mechanisms for making wooden barrel pens/pencils/roller balls/ fountain pens. Ebony, Kingwood, Tulipwood, Snakewood, African Blackwood, Cocobolo, Bloodwood, Figured Maple, Spalted Maple, Padauk, etc. Unique and unusual turning woods and burls are also available. Send for catalog. **BEREA HARDWOODS**. \$1.00. *Circle No. 510.*

ONE STOP WOOD SHOP—Domestic and exotic hardwood plywood and lumber, marine plywood, over 30 species in stock—all under one roof. Custom cutting services to your exact specifications with little or no waste at competitive prices! We specialize in bundling and shipping. Send for catalog. **BOULDER PLYWOOD CORP.** Free. *Circle No. 512.*

YOU DESERVE QUALITY HARDWOODS—Bristol Valley Hardwoods is the hardwood store you've been looking for. Domestic & exotic lumber, thin stock, hardwood plywood & flexible veneers, dowels and 25 Sq. Ft. advantage packages. Catalog. **BRISTOL VALLEY HARDWOODS**. \$1.00. *Circle No. 513.*

MORE THAN 4000 WOODS—veneers, inlays, carvings, legs, pegs, tools, moldings, finishes, decorative hardware, plus books, plans and more—everything for people who work with wood! Constantine's 181 years of woodworking experience make it the catalog woodworkers rely on; their 60-day money-back guarantee is your assurance of 100% satisfaction. 2 year subscription. **CONSTANTINE'S**. \$1.00. *Circle No. 515.*

ATTENTION WOOD READERS—If you want to spend more time in your wood shop and less time shopping for wood, **PROJECT-PAK** is for you! Our catalog contains 60 PROJECT-PAKS of projects originally built in **WOOD** Magazine. Send today and enjoy hassle free woodworking. Catalog. **HERITAGE BUILDING SPECIALTIES**. \$1.00. *Circle No. 550.*

MARLING LUMBER CO. "TOOLS"—We stock the full lines of Makita and DeWalt power tools plus most accessories. Also, select products from Hitachi, Amana, and Freud. **FREE FREIGHT** on orders of \$50.00 or more. Knowledgeable help. Most orders ship within 24 hours. **MARLING LUMBER CO.** Free. *Circle No. 570.*

STEVE H. WALL LUMBER CO.—Quality hardwoods and woodworking machinery for the craftsman and educational institutions. 16-page catalog lists 17 species of popular hardwoods at wholesale prices. Also dealers for MiniMax, Freud and ProCut woodworking machines. **STEVE H. WALL LUMBER CO.** \$1.00. *Circle No. 592.*

EXOTIC IMPORTED AND DOMESTIC HARDWOODS—Over 75 species of lumber, bowl blanks, turning squares and veneer. Samples (1/4" x 3" x 6") ideal for craftsmen, furniture and cabinet makers, architects, and designers available. Catalog provides common and botanical name, source, and description of each wood. Send for catalog. **WOODWORKERS SOURCE**. \$1.00. *Circle No. 598.*

VIDEOS

LAGUNA TOOLS VIDEO—Learn why most European workshops are using a central machine center rather than separate machines. 90 min. video presentation of "The Intelligent One Man Shop. The Robland X 31". Send for video. **LAGUNA TOOLS**. \$6.00. *Circle No. 615.*

EPOXIES/GLUES

DETECT UNWANTED GLUE EASILY—before ruining your work! Add **SPOTLIGHT** to your glue, then view the work under the available U-V light. The savings pay for **SPOTLIGHT** with the first otherwise missed spot. **SPOTLIGHT**'s only effect is to make glue highly visible under U-V light. Send for information. **SPOTLIGHT**. \$1.00. *Circle No. 710.*

GENERAL WOODWORKING CATALOGS

CONSTANTINE'S 181ST ANNIVERSARY CATALOG—is packed with woods, veneers, tools and supplies. Choose veneers in more than 81 varieties... inlays, overlays, hardwoods, moldings, trims, caning supplies, finishes, hardware, and tools, tools, tools! Over 4000 products, illustrated in full color and guaranteed to please or your money back. 2 year subscription. **CONSTANTINE'S**. \$1.00. *Circle No. 820.*

THE WOODTURNERS CATALOG—48 color pages of the finest woodturning tools, machinery and supplies

available. Featuring Henry Taylor, Sorby, Richard Raffan and Dale Nish workshops. Catalog price refunded with order. **CRAFT SUPPLIES USA**. \$2.00. *Circle No. 830.*

MASTER TOOLS CATALOG—1992-93 236-page master woodworking tools catalog. Full line of the best hand tools, power tools & accessories, machinery, glues, finishing supplies, workbenches, and much more. Hundreds of books included. All four-color. Lots of technical information. **GARRETT WADE CO.** \$4.00. *Circle No. 855.*

GRIZZLY IMPORTS, INC.—1993 is our 10th year of providing woodworkers with an incredible selection of machines, tools and accessories at prices you can afford. Send for your free 1993 catalog today and celebrate with tremendous savings on all your woodworking needs. **GRIZZLY IMPORTS INC.** Free. *Circle No. 860.*

WOODWORKING CATALOG—48-page full-color catalog of top quality woodworking machines and supplies. See the American made tools! Total Shop is bringing production home. Many tools now made in the U.S.A. Dust collectors, table saws, lathes, drills, you name it we have it. Catalog free! **TOTAL SHOP**. Free. *Circle No. 940.*

COMPLIMENTARY TOOL CATALOG—Woodcraft offers over 4,000 of the finest quality woodworking tools, books, supplies, and cabinet hardware in our complete full color catalog. Craftsmen, cabinetmakers, carvers, woodturners, and hobbyists have depended on Woodcraft since 1928. Backed by Woodcraft's unconditional guarantee. Free technical assistance. **WOODCRAFT SUPPLY CORP.** Free. *Circle No. 955.*

THE WOODWORKERS' STORE CATALOG—New! The Woodworkers' Store 1993/94 catalog with over 200 new items features 104 full color pages of domestic and exotic hardwoods, veneers, wood parts, specialty hardware, kitchen accessories, finishing supplies, tools, books, and plans... Many exclusive items and hard to find specialties. Orders shipped in 24 to 48 hours. Over 39 years in business! Satisfaction guaranteed. Catalog. **THE WOODWORKERS' STORE**. \$2.00. *Circle No. 965.*

KITS

OUR QUEEN ANNE FURNITURE KITS—are ready to assemble and finish. They include dining room table, chairs, hutch, sideboard, a variety of occasional tables, and a personal desk. All are made in solid cherry, oak, walnut, and mahogany. We also stock individual Queen Anne legs for every project. Complete information in our brochure packet. **ADAMS WOOD PRODUCTS**. Free. *Circle No. 1002.*

ATTENTION WOOD READERS—If you want to spend more time in your wood shop and less time shopping for wood, **PROJECT-PAK** is for you! Our catalog contains 60 PROJECT-PAKS of projects originally built in **WOOD** Magazine. Send today and enjoy hassle free woodworking. Catalog. **HERITAGE BUILDING SPECIALTIES**. \$1.00. *Circle No. 1040.*

SHIP MODELING CATALOG—Historic Ship Models—Museum quality replicas you build yourself. Pre-cut wooden parts, metal and brass fittings, cloth sails, plans and instructions. Send for 80 page color catalog. **MODEL EXPO, INC.** \$1.00. *Circle No. 1075.*

BUCKBOARD BENCH KIT—Kit includes, steel springs that give a little, metal arms and back rails, hardware, and complete instructions. Also available kit with oak parts cut to size. Send for information. **THE ROUDEBUSH CO.** 50c. *Circle No. 1085.*

PUBLICATIONS

THE FINE TOOL JOURNAL—Published quarterly. The magazine for craftsmen and collectors who buy and use hand tools; antique, obsolete and modern. We have specialized in this area since 1970. Besides articles dealing with all aspects of hand tools, absentee tool auctions are a regular feature, as are book reviews, modern tool evaluations, and much more. **IRON HORSE ANTIQUES, INC.** Free. *Circle No. 1130.*

SHOP ACCESSORIES

WOOD MOISTURE METER—Insure the quality of every project by using a wood moisture meter. Delmhorst Model J-88 is ideal for a woodworking shop or the serious craftsman. Easy to read LED display indicates 10 ranges of moisture content between 6% & 20%. Send for catalog on our complete line of wood moisture meters. **DELMHORST INSTRUMENT CO.** Free. *Circle No. 1217.*

ECON-ABRASIVES—manufactures abrasive belts up to 52" wide in any grit. We carry hundreds of woodworking related accessories including: Velcro® backed discs,

bar clamps, wood glue, drawer slides, chisels, hinges and hundreds of sanding accessories. Send for our 1992 catalog. **ECON-ABRASIVES**. Free. *Circle No. 1229.*

EASY DOES IT—with HTC'S power tool accessories. Discover many unique items, designed only with you, the dedicated woodworker, in mind. Make your machinery safer, increase the working area of your shop and accomplish nearly impossible tasks easily, quickly, accurately. Full-line catalog and price list. **HTC PRODUCTS, INC.** Free. *Circle No. 1245.*

WOOD MOISTURE METER—Avoid moisture problems such as cracking, warping, splitting, delamination etc. by using a moisture meter, as described in the latest brochure. Moisture Meter Mini-Ligno is designed for serious hobbyists and woodworkers. Attachments for depth measurements and remote reading during air and kiln drying are available. Available Moisture Range 6-20%, 6-36% or 4-30%, 4-60%. Catalog describes complete line of moisture meters. **LIGNOMAT USA, LTD.** Free. *Circle No. 1250.*

ROUTER SPEED CONTROL—Reduces speed electronically without reducing torque. Route at the speed that gives best results with the wood and bit you are using. Speed adjustable from full speed to 0 RPM. Less tear out—stops burning—less wear on bits—easy to use. Send today for information. **MLCS LTD.** Free. *Circle No. 1251.*

LUMBER DRYING—Dry your own lumber using our equipment and your insulated chamber. Dehumidification systems from 300 BF to 45,000 BF. Easy to operate equipment offers high quality kiln-dried lumber for pennies per foot. These long-lasting made-in-the-USA units can pay for themselves in one month! Send for free catalog. **NYLE STANDARD DRYERS, INC.** Free. *Circle No. 1260.*

PLYMATE SAW GUIDE—Easier to use than any other guide on the market. The guide that delivers straight, accurate cuts the first time. For use with a circular saw when cutting large pieces of plywood & sheet materials. Free literature. **OLIVE KNOT PRODUCTS**. Free. *Circle No. 1262.*

"WOOD-FRIENDLY"™ L606 MOISTURE METER—uses advanced electromagnetic wave technology to accurately measure wood moisture content from 6% to 30% to a depth of 3/4". No pins to "abuse" wood and leave ugly holes. Check out boards from top to bottom in just seconds before you buy and avoid the headaches of splitting, warpage, delaminating and failed glue joints. The Wagner L606's convenient pocket size, easy-to-read analog meter, and low price make it a must for anyone working with wood. Literature. **WAGNER ELECTRONIC PRODUCTS, INC.** Free. *Circle No. 1285.*

BITS, BLADES, CUTTING TOOLS

ASK FOR CMT'S CATALOG AND WE'LL GIVE YOU \$5!—CMT Tools will send you our free, full-color router bit catalog and we'll give you a \$5.00 discount on your first order! CMT bits feature anti-kickback design, Teflon coatings and micrograin carbide cutting edges. Our catalog is packed with accessories, project ideas and safety tips—it's one catalog you'll want to keep! **CMT TOOLS, INC.** Free. *Circle No. 1310.*

CASCADE TOOLS—The 1993 Cascade Tools catalog is the finest ever. It's jammed with great buys on SY brand industrial-grade router bits, shaper cutters and an excellent assortment of hard-to-find accessories. You'll have to see it to believe it. **CASCADE TOOLS, INC.** Free. *Circle No. 1315.*

FREUD—Premier line of carbide-tipped sawblades, router bits, shaper cutters and other woodworking tools. Freud offers a full-line on anti-kickback carbide-tipped router bits. Send for a free new router bit catalog. **FREUD**. Free. *Circle No. 1321.*

SUPER-SMOOTH, EXTRA-DURABLE, CARBIDE-TIPPED CIRCULAR SAW BLADES—Get a smooth-as-sanded surface with our all-purpose 40-tooth Woodworker Blade. You will be able to rip and cross-cut 1-2 in. rock hards and soft woods with an unbelievably smooth finish. You will also be able to cross-cut oak and birch ply-veneers with no bottom splinters. Send today for our information pack. **FORREST MFG. CO., INC.** \$1.00. *Circle No. 1322.*

PRODUCTION QUALITY CARBIDE TIPPED ROUTER BITS—MLCS Ltd. has a new 32-page catalog featuring hundreds of high quality carbide tipped router bits, shaper cutters, the Router Speed Control, the "Merle Adjustable Corner Clamp," plus other Professional Woodworking Products. Prices 50% to 70% lower than elsewhere. Value, quality and prompt service guaranteed! **MLCS LTD.** Free. *Circle No. 1350.*

MAGNATE—provides a full line of affordable carbide tipped router bits and shaper cutters. Send for FREE new 1992-93 catalog. **MAGNATE**. Free. *Circle No. 1355.*

HARDWARE/WOOD PARTS

CHERRY TREE TOYS CATALOG—68 pages of plans, parts, kits and supplies for All Skill Levels. Clocks, whirligigs, dollhouses, door harps, banks, and many more attractive items—plus wooden dowels, pegs, wheels, knobs, & more. Tools, paint supplies, stencils, stamps and much more! Bulk prices available. Catalog. CHERRY TREE TOYS. \$1.00. Circle No. 1420.

HARDWARE CATALOG—A unique 48-page catalog of the very finest in classic, traditional solid brass cabinet hardware. All of British or No. American manufacture. Double & single post handles, knobs, escutcheons, standard & specialty hinges, box hardware, brass screws, castors, latches, catches, locks, and more. GARRETT WADE CO. \$3.00. Circle No. 1427.

INCOME OPPORTUNITIES

MAKE MONEY IN FURNITURE RESTORATION THE MINUTEMAN WAY—Earn \$200-\$1000 per day stripping, repairing, refinishing, mirror resilvering, and/or veneering, at home or in shop, spare time or full time. We provide complete training; no experience necessary. Free workshop teaches you latest in furniture restoration. You have to see it to believe it! Business preview video \$19.95. Send for catalog. MINUTEMAN. \$2.00. Circle No. 1661.

MISCELLANEOUS

MECHANISMS FOR MAKING WOODEN BARREL PENS—Pencils/Roller Ball Pens/Fountain Pens. High quality. Low prices. Wholesale/Retail. Plus other related items. BEREA HARDWOODS CO. \$1.00. Circle No. 1900.

LOOKING FOR PIERCED TIN? COME TO THE SOURCE!—70+ page color highlighted catalog introduces you to a treasury of pierced metal panels affordably priced and ready to install in your woodworking projects. Available in a wide variety of sizes, 16 different types of metal (copper & brass, too!) & over 300 designs. Custom size & design a specialty. OR all the materials and tools needed to create it yourself. Catalog includes furniture plans you can order, lantern kits, specialized metal piercing tools and MORE. COUNTRY ACCENTS. \$5.00. Circle No. 1910.

ARMRESTS FOR YOUR CAR—Add a TracTop® sliding cushion front center armrest with pullout tray. Models for foreign and domestic bucket seat cars, Honda, Saab, Audi, Ford, GEO, Volvo, etc. Color choices. #1 worldwide for 12 years! HUSCO ENGINEERING. \$1.00. Circle No. 1960.

THE CUSHION CONTOUR SANDER—is a new concept in pneumatic drum sanding. Sanding sleeves are slid over an air bag (inflated with a hand tire pump) on an arbor to mount it between centers on a wood lathe. Drum effectively takes on profiles, curves, and bevels practically eliminating flat spots and chatter marks. INDUSTRIAL ABRASIVES CO. \$1.00 (refunded with first order). Circle No. 1976.

ROLL-TOP COVER—QUICK & EASY! The Roll-Top Cover instantly rolls out to keep contents dry and secure. When not required it rolls into its small 9½" storage canister for carrying tall loads. The full length handle can be easily operated with one hand from either side of the truck. Send for brochure. PACE-EDWARDS CO. \$1.00. Circle No. 1985.

WEATHERSTRIPPING TOOL—Now you can permanently seal leaky doors and windows in just a few minutes. Our affordable tool (\$195 including motor, carbide bit, and dust-collection hose) cuts an angled groove in the corner of rabbeted jambs. Five sizes of silicone-rubber inserts will seal any gap from 0 to 3/8". Literature and samples. RESOURCE CONSERVATION TECHNOLOGY, INC. \$1.00. Circle No. 1987.

HI-TECH ENGRAVING—You don't have to be an artist with the System One High Speed Engraver (400,000 RPM). The incredible high speed combined with SCM's exclusive stenciling system allows you to produce professional results. You can engrave on wood, glass, metal, stone, ceramic, egg shell. It's as easy as writing with a pen. Send for information. SCM ENTERPRISES. \$1.00. Circle No. 1990.

STEELMASTER BUILDINGS—are available in almost any size for almost any use. From 10' to 100' wide and any length imaginable. Whether you need a back yard shop... an industrial shop... equipment storage building... whatever your requirements, you'll find a Steelmaster that's just the right size for the job. Our buildings are so easy to construct, most owners opt to construct their buildings themselves which adds up to even bigger savings. Send for information. STEELMASTER. \$1.00. Circle No. 2030.

IF YOU ARE INTERESTED IN RESTORING ANTIQUES—this 272-page catalog packed with unusual,

hard-to-find items is just for you. Included are hundreds of essential items for antique restoration including top quality brass reproduction hardware, oil lamps and accessories, numerous wood component repair parts and kits, caning and basketry supplies, everything needed for wood refinishing, related tools, books, and a complete line of upholstery equipment and supplies. All at wholesale prices. Send for this informative catalog. VAN DYKE'S RESTORERS. \$1.00. Circle No. 2077.

LEGAL IVORY—Virtually identical to animal ivory. Tagua is the nut from a tropical palm tree. Ideal for jewelry, knobs, small turnings, inlay, or scrimshaw. Available in 3 sizes. Send for information. WOODWORKERS SOURCE. Free. Circle No. 2090.

"THE WOODWORKING SHOWS" MACHINERY, TOOLS AND SUPPLIES—Hundreds of items from the woodworker demonstrated and sold at discount prices at every "Woodworking Show". In-depth seminars and free workshops on a variety of woodworking topics. Shows are scheduled in 27 cities. Send for free brochure. "THE WOODWORKING SHOWS". Free. Circle No. 2095.

CARVING SUPPLIES

28 PAGE DECOY CARVERS SUPPLY CATALOGUE—Over 1400 items including basswood, tupelo, and butternut cutouts and cutout kits (wildfowl, santas, and more). Plus tools, eyes, books, patterns and hard to find items (cork decoy kits). JENNINGS DECOY COMPANY. \$1.00. Circle No. 2125.

WOOD CARVING MACHINES AND ACCESSORIES—make all types of wood carving easy, fun and profitable. The machines do the work. Whether for sign carving, flat 3-D, decoys, panels, gun stocks or furniture, we have the proper machine for the job. Professional woodcarving for the hobbyist and superior quality for the professional. Begin your hobby or full or part-time business by ordering our catalog and price list. MARLIN INDUSTRIES. \$1.00. Circle No. 2150.

WOODCARVING TOOLS—Whittlers and carvers—Warren Tool Co., Inc. offers a complete catalog of whittling and carving, hand tools, sharpening aids, wood cut-outs, and related wood carving supplies. WARREN TOOL CO., INC. \$1.00. Circle No. 2185.

WOOD CARVERS SUPPLY INC.—Serving with pride since 1955. Family owned & operated with superior customer service & a large selection of quality carving supplies. Each order is inspected 3 times before leaving our warehouse, delivered fast & backed by a 30 day money back guarantee. Discover the joy & relaxation of wood carving. Order our superb color 76 page catalog with over 2,000 items including hand & power carving tools, books, knives & much more. Join 1,000s of happy customers by sending \$2 for a two year catalog subscription. WOOD CARVERS SUPPLY, INC. \$2.00. Circle No. 2190.

1994 GLOBAL CARVING CHALLENGE—AQUATIC LIFE—Over \$15,000 in cash & prizes will be awarded in the 1994 G.C.C. carving contest featuring all forms of aquatic life including a Mythical category. Mail in & hand delivered entries are both welcome. Send for free information. WOOD CARVERS SUPPLY, INC. Free. Circle No. 2191.

CLAMPS

MERLE ADJUSTABLE CORNER CLAMP—Quick & easy to use. It forces your work into square. Fully adjustable from 2½" x 2½" to 69" x 69" in. Perfect for clamping picture frames, cabinets, or anything that requires 90° corner clamping. The Merle Clamp is cast aluminum & steel construction, a true industrial quality tool. Send today for information. MLCS LTD. Free. Circle No. 2250.

CLOCKS

KLOCKIT'S FREE 64-PAGE COLOR CATALOG—is packed with the largest selection of beautiful wood clock kits for all skill levels, a huge selection of quartz and mechanical clock movements, dials and accessories, turned wood parts, music movements, tools and much more for the craftsman! KLOCKIT. Free. Circle No. 2335.

FASTENING PRODUCTS

SQUARE DRIVE SCREWS—Thousands agree—once you try them you will never want to use anything else! The square drive recess virtually eliminates work-damaging driver bit "cam-out," the deep threads result in exceptional holding power, and they are heat treated for strength. Sizes from #4 x ¾" to #12 x 4", with stainless steel, solid brass, brass plated, and zinc plated available. Quantity discounts. Send for literature. MCFEELY HARDWOODS. \$1.00. Circle No. 2450.

Worth writing for...



Better Homes and Gardens®
WOOD Magazine, December 1993
Dept. DCW093
P.O. Box 2713
Boulder, Colorado 80329-2713

TO ENSURE PROMPT HANDLING OF YOUR ORDER FOLLOW THESE INSTRUCTIONS:

- Circle your choice
- Enclose check or money order for cost of booklets plus \$2.00 service charge (no stamps accepted)
- NO FOREIGN ORDERS ACCEPTED
- Send coupon and remittance to address above
- ALLOW 4-6 WEEKS FOR DELIVERY
- Coupon expires January 11, 1995

WOOD SUBSCRIPTION

1. A 1 year WOOD subscription (9 issues) for \$25.00 (U.S. price)—a \$19.55 savings off newsstand rate. Allow 6-8 weeks for first issue. Be sure to include payment with total below. NO FOREIGN ORDERS ACCEPTED ON THIS COUPON; please contact Subscription Dept. directly.

Circle numbers below corresponding to items in this issue. Please include \$2.00 for handling charge.

3.....\$2.00	84.....Free	496.....\$1.00	830.....\$2.00	1229.....Free	1355.....Free	2077.....\$1.00
6.....\$3.00	92.....\$1.00	510.....\$1.00	855.....\$4.00	1245.....Free	1420.....\$1.00	2090.....Free
15.....Free	94.....\$2.00	512.....Free	860.....Free	1250.....Free	1427.....\$3.00	2095.....Free
20.....\$1.00	130.....\$1.00	513.....\$1.00	940.....Free	1251.....Free	1661.....\$2.00	2125.....\$1.00
35.....Free	160.....\$1.00	515.....\$1.00	955.....Free	1260.....Free	1900.....\$1.00	2150.....\$1.00
37.....\$1.00	210.....\$1.00	550.....\$1.00	965.....\$2.00	1262.....Free	1910.....\$5.00	2185.....\$1.00
44.....Free	320.....\$2.00	570.....Free	1002.....Free	1285.....Free	1960.....\$1.00	2190.....\$2.00
48.....\$1.00	345.....\$3.00	592.....\$1.00	1040.....\$1.00	1310.....Free	1976.....\$1.00	2191.....Free
49.....Free	401.....\$2.00	598.....\$1.00	1075.....\$1.00	1315.....Free	1985.....\$1.00	2250.....Free
57.....Free	465.....\$1.00	615.....\$6.00	1085.....50¢	1321.....Free	1987.....\$1.00	2335.....Free
78.....\$1.00	485.....\$2.00	710.....\$1.00	1130.....Free	1322.....\$1.00	1990.....\$1.00	2450.....\$1.00
82.....\$1.00	490.....\$3.00	820.....\$1.00	1217.....Free	1350.....Free	2030.....\$1.00	

Name (please print) _____
Address _____
City _____
State _____ Zip Code _____
Phone (Optional): _____

I AM ENCLOSING:

\$ _____ for priced items
\$ 2.00 for handling
\$ _____ total remittance

DELTA TOOLS			
Model	Description	List	Sale
23-700	Wet/Dry Grinder	234	168
23-680	6" Bench Grinder 1/4 HP	86	75
23-880	8" Bench Grinder 1/2 HP	151	141
11-850	8" Drill Press	199	144
31-050	1" Bell Sander 2.0 amp	104	78
31-460	4" Bell/Disc Sander	198	135
31-340	1" Bell/8" Disc Sander	288	204
31-080	1" Bell/5" Disc Sander	134	89
40-590	16" 2 speed Scroll Saw	266	178
11-990	12" Bench Drill Press	276	209
11-090	32" Radial Bench Drill Press	399	294
43-355	3/4" Shaper 1-1/2 HP	964	709
43-505	1/2" Bench Router/Shaper	399	279
22-540	12" Bench Top Planer	389	305
36-220	10" Compound Miter Saw	350	228
28-180	Bench Band Saw	232	165
28-190	NEW 12" Band Saw	465	375
40-640	20" Bench Scroll Saw	466	305
37-070	NEW 6" vspd Bench Jointer	330	255
14-650	Hollow Chisel Mortiser	361	289
46-700	12" Wood Lathe	548	335
34-761	10" Unisaw 1-1/2 HP	1715	1345
33-990	10" Radial Arm Saw	618	415
37-280	6" Molozized Jointer	488	389
37-154	DJ15 8" Jointer w/3/4"HPmotor	1420	1089
50-179	3/4 HP 2 stage Dust Collector	480	359
70-200	20" Floor Drill Press	1049	810
33-055	8-1/4" Sawback comp w/legs	865	595
34-330	8-1/4" Table Saw 13A	343	234
32-100	Station Plate Jointer	645	529
36-040	8-1/4" Compound Miter Saw	224	159
34-915	30" Unifence	885	628
34-897	50" Delta Unifence	525	385
36-755	10" Tilt Arbor Saw	1264	935
34-444	Contractors Table Saw	812	615
17-900	16-1/2" Floor Drill Press	441	389
40-601	18" Scroll Saw with stand	942	745
22-661	13" Planer with 2HP motor	1436	1175

The following Delta tools have a \$50.00 rebate!
 Price shown is before rebate.
 28-283 14" Band Saw w/mc. stand..... 810 735
 34-445 34" 1/4 HP Saw w/30" Unifence 1200 815
 34-445B 34-444 w/Bies, 50" saw fence 1300 995

MILWAUKEE TOOLS			
Model	Description	List	Sale
6527	NEW Sawzall with case	309	164
6528	above Sawzall w/wired cord	305	168
6125	NEW 5" Random Orbit Sander	200	119
6126	NEW 6" Random Orbit Sander	205	125
6199	12V cordless Drill Kit comp	309	165
6199B	NEW cordless Drill Kit comp	309	165
6402-1	above Drill w/keys chuck & 2 batt.	168	158
0935-1	8.6V cordless Drill with case	284	158
0234-1	3/8" Drill 4.5 amp magnum	215	116
0234-1/2	1/2" Drill 4.5A mag 0-850 rpm	229	122
0244-1	1/2" Drill 4.5 amp 0-1000 rpm	229	123
0222-1	3/8" Drill 3.5 amp 0-600 rpm	189	107
0228-1	3/8" Drill 3.5 amp 0-1000 rpm	186	104
0375-1	3/8" close quarter Drill	229	128
0379-1	1/2" close quarter Drill	260	145
6546-1	cds Screw/20 & 400 rpm	138	82
5399	1/2" D-hole Hammer Drill Kit	325	188
6750-1	Drywall Gun 0-4000 5 amp	168	95
6507	Original SawZall with case	259	139
6014	Orbital Sander 1/2 sheet	214	124
8977	variable temp. Heat Gun	128	75
5397-1	3.8" var. spd Hammer Drill Kit	250	138
5371-1	1/2" var. spd Hammer Drill Kit	375	205
5107-1	1/2" vspd right angle Drill Kit	385	189
6750-1	Drywall Gun 0-4000 5.4 amp	192	108
3300-1	1/2" var. spd right angle Drill	339	189
5680	Router 2 HP - 12 amp	355	198
0235-1	1/2" Drill w/keyless chuck	229	128
6145	4-1/2" Grinder 10,000 rpm	165	99
6142	6145 with case & accessories	204	124
6749-1	Drywall Gun 0-2500 5.4 amp	214	122
6365	7-1/4" Circular Saw 13 amp	214	124
6366	6365 w/blade & carbide blade	224	127
6368	6365 w/nc carb. blade & cse	244	133
6377	7-1/4" Worm Drive Saw	324	182
6256	Top Handle Jig Saw	259	139
6490	10" Miter Saw	444	265

FREUD CARBIDE TIPPED SAW BLADES			
Item	Description	Teeth	List Sale
LU72M10	Gen Pur. A.T.B 10"	60	39
LU82M10	Cut-off 10"	80	43
LU84M11	Camb 10"	50	78
LU85M10	Super Cut-off 10"	80	115
LU72M10	Ripping 10"	24	69
LU73M10	Cut off 10"	60	84
LU87M10	Thin Kerf 10"	24	72
LU88M10	Thin Kerf 10"	60	88
LU98M10	Ultimate 10"	60	128
LU91M10	Compound Miter 10"	60	88
TK303	7-1/4" Finishing	40	38
TK306	10" Finishing	40	28
TK306	10" Combo	50	53
SD306	8" Dado - Carbide	215	119
SD308	8" Dado - Carbide	230	119
F0	1-3/4" x 5/8" Biscuit 1000 Qty.	43	29
F10	2-1/8" x 3/4" Biscuit 1000 Qty.	43	29
F20	2-3/4" x 1" Biscuit 1000 Qty.	43	29
FA	Assorted Biscuits 1000 Qty.	45	29
FB100	16 piece Forstner Bit Set	338	184
94-100	5 pc. Router Bit Dst System	320	163

The following FREUD Tools have a \$30.00 rebate!
 Price shown is before rebate - Expires 1/15/94
 FT2000E3-1/4 HP vspd Plunge Router 400 198
 JS100 Biscuit Jointer with case 334 159

MAKITA TOOLS			
Model	Description	List	Sale
60700D	3/8" vspd Reverse Drill 7.2V	128	74
60710D	3/8" vspd Reverse Drill 7.2V	128	74
60710DK	above Drill w/removable batt.	216	110
50800D	3-3/8" Saw Kit 9.6 volt	270	149
6010SDW	3/8" cordless Drill Kit 7.2V	99	59
ML900	Incandescent Flashlight 9.6V	59	37

6012HDWE 2 speed Drill Kit w/2 batt. 255 129
 6093DW vspd Drill w/utch-complete. 283 139
 6093DWE 6093DW Drill Kit w/2 batteries 296 145
 6093DWD 6093DW Kit w/keyless chuck 291 135
 6095DWE 6095DW Drill Kit w/2 batteries 139 139
 6201DWE NEW 9.6V Drill Kit w/2 batt. 310 155
 6211DWE 12V Drill Kit with 2 batteries 342 168
 63200T-4 9.6 volt Battery 48 30
 63200T-4 7.2 volt Battery 40 28

SIoux TOOLS			
Model	Description	List	Sale
8030	NEW 3/8" var/spd Drill	238	139
8000	3/8" var/spd close qtr Drill	201	123
690	5" Air Random Orbit Sander	139	132
690V9	690 w/ventil dust collection	281	175
658	5" Air Rndm Sander-dual action	261	155

PANASONIC CORDLESS			
Model	Description	List	Sale
EY6205BC	NEW variable speed 12 volt Drill w/15 minute charger & case	353	179
EY6205EQ	Same as EY6205BC but battery has 40% more life & 20% more torque	368	189
EY6282EQ	Var. spd 9.6V Drill w/15 min charger, case & NEW Ironman batt.	315	168
EY6282DKW	9.6 volt Drill Kit w/2 batt.	275	158
EY6181CRKW	NEW 9.6V PREDATOR Compact Drill Kit with 2 batteries - 10% more power than EY6282DKW	158	158
EY6207BCNEW	12 volt 1/2" Drill w/keyless chuck var. speed w/15 minute charger & case	420	222

NEW stock Hitachi Air Nailers!
 PASLODE IMPULSE GUNS
 IM250 Trimpulse Finish Nailer Kit 849 615
 IM325 Impulse Framing Nailer Kit 849 595

1994 TOOL CATALOG AVAILABLE
 Call Toll-Free 1-800-328-0457 in Minn. Call (612)224-4859
 FAX: (612)224-9263
 CHECK • MONEY ORDER • VISA • MASTERCARD • DISCOVER
SEVEN CORNERS ACE HDW. Inc.
 216 West 7th St. • St. Paul, MN 55102 • Est. 1933

New Products from Freud
New Quiet Blades
 F410
 10" - 40 carbide teeth
 List 95 Sale 54

F810
 10" - 80 carbide teeth
 List 135 Sale 76

New Super Dados
 SD506
 6" carbide w/case & shims
 List 292 Sale 165

SD508
 8" carbide w/case & shims
 List 344 Sale 194

TOOLS ON SALE!
 AMERICA'S LOWEST PRICED TOOLS
 FREE FREIGHT TO THE CONTINENTAL STATES ON EVERY ITEM
 48 CONTINENTAL STATES ON EVERY ITEM
 *We reserve the right to verify that the competing price quote is offered in good faith.

DEWALT TOOLS			
Model	Description	List	Sale
DW367-1/4"	Circ. Saw w/bake 13 A	275	145
DW94K-2 3/8"	12V cds Drill Kit w/2 batt	298	169
DW94K-2 3/8"	9.6V cds Drill Kit w/2 batt	277	154
DW4611-1/2"	HP 2 handle Router	270	148
DW4111-1/4"	sheet Palm Sander, 1.7 amp	97	58
DW100 3/8"	Drill, 4 amp, 0-2500 rpm	116	68
DW510K 1/2"	vspd Hammer Drill w/case	298	165
DW682KNEW	Biscuit Joiner with case	428	225
DW705 1/2"	Compound Miter Saw	658	358
DW615 NEW	1-1/4 HP Elect. Pipe Router	290	158
DW625 NEW	3 HP var. spd Plunge Router	269	159
DW675KNEW	3-1/8" Planer with case	280	159
DW4311 NEW	3 x 21 vspd Belt Sander	320	182

PORTA NAILER			
Model	Description	List	Sale
401	Porta Nailer complete	265	198
501	Face Nailer complete	265	195

WERNER LADDERS			
Model	Description	List	Sale
6204	4 Fiberglass	179	65
6205	5 Fiberglass	199	75
6206	6 Fiberglass	225	80

WINTER KIT SPECIALS			
Model	Description	List	Sale
9852K	Porter Cable 9852 Drill Kit w/extra batt	185	185
9853K	Porter Cable 9853 Drill Kit w/extra batt	185	185
7335K	Porter Cable 5" var. spd Random Orbit Sndr w/cse & 1 roll 100X & 150X discs	273	169
7336K	Porter Cable 6" var. spd Random Orbit Sndr w/cse & 1 roll 100X & 150X discs	278	175
555K	Porter Cable Plate Biscuit Joiner with case & 1000 assorted biscuits	339	195
JS100K	Freud Jointer w/cs & 1000 bisc 351	185	185
1581VSK	Bosch Top Handle Jig Saw with case & 30 Bosch blades	305	175
1582VSK	Bosch CLIC Barrel Grip Jig Saw with case & 30 Bosch blades	305	175
JM100K	Ryobi Jointer w/1000 biscuits	475	242

BIESEMEYER FENCES			
Model	Description	List	Sale
B-50	50" Commer. Saw Fence	345	296
T-SQUARE 52 52"	Homeshop Fence	279	238
T-SQUARE 40 40"	Homeshop Fence	259	208
T-SQUARE 28 28"	Homeshop Fence	249	198

WEDGE SMART LEVEL			
Model	Description	List	Sale
SM-PR2	2 FT Level with sensor	120	88
SM-PR4	4 FT Level with sensor	150	105
SM-PR6	78" Level with sensor	180	139
SL224	NEW 2FT Level with sensor	79	55

Max636 FEIN Triangle Sander Kit Sale 185
 LPN672 PONY Air Palm Nailer w/glove Sale 94.99

JORGENSEN ADJUSTABLE HANDSCREWS			
Item #	Length	Cap List	Sale of 6
#0	4-1/2"	19.00	11.89
#1	6"	21.76	12.89
#2	8-1/2"	24.95	14.95
#3	14"	31.61	18.95
#4	18"	42.30	24.95

JORGENSEN STYLE 37-2-1/2" Throat 1/4" x 3/4"			
Item #	Length	List	Sale of 6
3706-1	6"	9.86	6.25
3712	12"	10.92	6.75
3718	18"	12.05	7.25
3724	24"	13.16	8.19
3730	30"	14.70	9.19
3736	36"	16.05	10.19

PONY CLAMP FIXTURES			
Model	Description	List	Sale of 12
50 3/4"	Black Pipe Clamps	13.61	7.89
52 1/2"	Black Pipe Clamps	11.37	6.50

ELU BY BLACK & DECKER			
Model	Description	List	Sale
3338	2-1/4 HP vspd Plunge Router	448	255
3375	1-1/8" Unw. planer 7.2 amp	329	155
3330	Biscuit Joiner with case	569	248
3339	NEW 3 HP wsp Plunge Router	600	275

BLACK & DECKER			
Model	Description	List	Sale
1166	3/8" Drill 0-2500 rpm 4 amp	105	65
1703-1	10" Miter Saw w/73-770 blade	299	185
4011	1/4 sheet Palm Sander	86	59
79-034	Workmate 400	177	109
2694	7-1/4" Super Saw cal.	275	144
2695	8-1/4" Super Saw cal.	308	158

DAVID WHITE			
Model	Description	List	Sale
LP6-20	Sight Level package - 20x	310	198
L6-20	Meridian Level - 20x		



Ross Hart's daughter, Allyson, makes daily use of the painted plywood wheelchair tray her daddy made for her.

WANTED: WOODWORKERS TO MAKE A DIFFERENCE

At *WOOD*® magazine we often hear how readers help others. But Ross Hart, a reader who lives in Roanoke, Virginia, really opened our editorial eyes with his letter.

He wrote, in part: "Allyson, my 5-year old daughter, suffers from a neurological disorder, is confined to a wheelchair, and needs special devices prescribed by her physician or physical therapist. Through this, I have learned of a great need for the skills that sub-

scribers could provide for those who don't have woodworking skills or shop access and can't afford manufactured offerings.

"A lot of handicapped kids need special devices that are usually made from wood: standing tables to help them stand without falling, corner sitters to help with positioning, floorsitters that let the kids watch TV or play, even simple trays. Such devices normally aren't covered by insurance or Medicaid. I have made some of these in my shop, and have designed a few that are unique to my daughter's needs [see photo above]. An article relating these needs would be a tremendous public service. Every woodworker I have met would leap at an opportunity to help others once they knew the need. Your 'Make a

Difference' spot in *Finishing Touches* proves that."

Ross went on to suggest that woodworkers contact their local university hospital, Easter Seal Society, or a physical therapist to find examples of what's needed. We did. And drawings of the simple devices shown *left* are just two examples that would be easy to duplicate in a home shop.

According to Ross, because these devices are built to individual needs, they're much like jigs, and all woodworkers love to build jigs. Many thanks, Ross, for sharing a great giving idea.



A commercially made vestibular board, like the one, *above*, sells for \$100. Retail cost for the standing box, *left*, is \$350.

WOOD WINS OUT

Recent microbiological research at the University of Wisconsin strongly suggests that you can now toss out any plastic cutting boards you might have around. That's because tests there have shown that wooden cutting boards naturally do away with the bacteria of common food-poisoning agents, such as salmonella.

Although researchers can't yet fully explain how wood does it, cutting boards tested eliminated 99.9 percent of all bacteria placed on them within three minutes! Under similar conditions, all bacteria that was placed on knife-scored plastic survived.

However, wooden cutting boards treated with an oil finish acted very similar to plastic ones by upping the bacteria's survival rate over unfinished cutting boards.



Photograph: Ross Hart Illustrations: Jim Stevenson



There's still plenty of time to enter *WOOD* magazine's annual toy contest to benefit Toys for Tots. Deadline is February 1. See the notice on *page 86*.

THE GIANT OF GIANTS

The National Register of Big Trees currently lists a 363'-tall coastal redwood, in California, as the nation's tallest tree. But what may have been the world's tallest tree no longer stands. It was a 417' Douglas fir that was felled in Vancouver, B.C., by loggers in 1902. That giant had a trunk circumference of 45'!

WHAT WOULD WE DO WITHOUT WOOD?

According to Dr. James L. Bowyer, a professor of forestry at the University of Minnesota, wood accounts for 47 percent of all materials—plastic, Portland cement, everything—used in the U.S. each year, on a weight basis. But unlike other materials, wood comes from trees, which are a renewable resource. 🌲

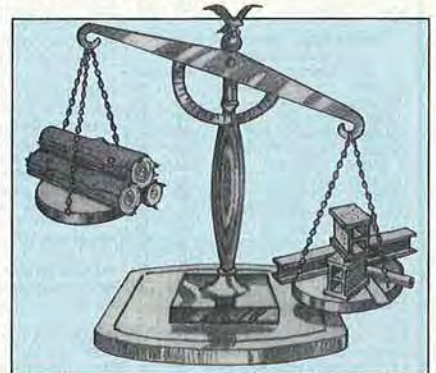

QUICK-CHANGE ARTISTS.

We believe that every hour spent in the shop is precious time.

That cutting a perfect curve on a quality saw should be part of the pleasure.

And that blade changes are a rude interruption of enjoyment and productivity.

We kept little things like blade changes in mind when we designed these saws to make sure they spend more time working than being worked on.

We figure that every quality feature we build into every tool we make will show up on the work that comes out of your shop.

You'll find Delta quality shop tools at your local Delta machinery dealer or at leading home center and hardware stores.

Call toll free and we'll give you the details on the store nearest you.

Delta International Machinery Corp., 800-438-2486. In Canada, call: 519-836-2840.

The Delta Bench Band Saw. Two-wheel design minimizes blade flexing and reduces blade breakage due to metal fatigue. Hinged wheel cover for fast, easy blade changes. Provides 7 1/2" blade to frame capacity, a full 5" under guide. Large 11 3/8" x 11 3/8" tilting table.

Our 16" 2-speed Scroll Saw cuts an inside curve like a sports car at speeds of 850 and 1,725 cut strokes/minute. Deep 16" throat handles large work. Cuts stock up to 2" thick. Features cast-iron frame and tilting table.



Exclusive Quickset™ Blade Tensioning System takes the guesswork out of adjustment and tensioning for different width blades. Proper tension means longer blade life, less down time.



We're pleased to be underwriters of The New Yankee Workshop and The American Woodshop on public television.

It's a snap. Quickset™ Blade Changing System features instant-acting, tension-release lever with patented pivoting chucks and wrench.

Scroll Saw has unique power take-off for mounting accessory flex shaft that powers bits for drilling blade-entry holes for internal cuts. Also powers rasps, brushes, sanding discs and so forth.

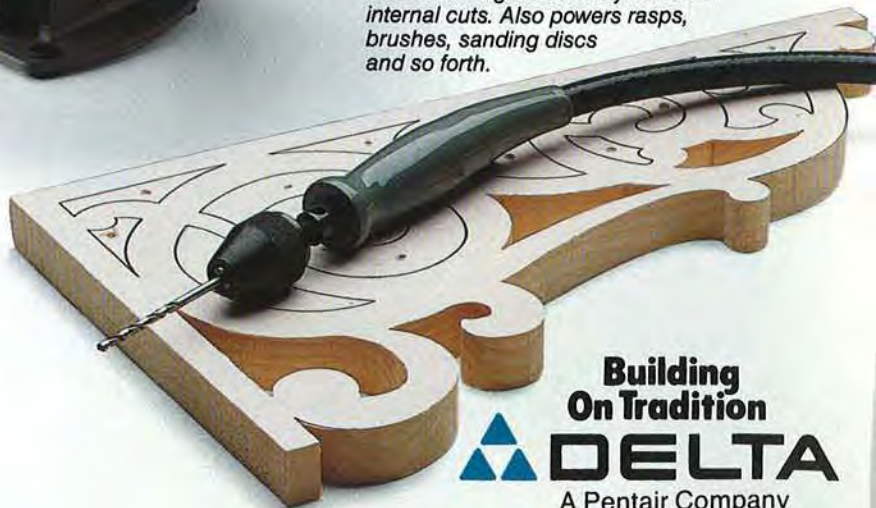

**Building
On Tradition**
DELTA
A Pentair Company

CRAFTSMAN! The Standard In Radial Saws... For Generations

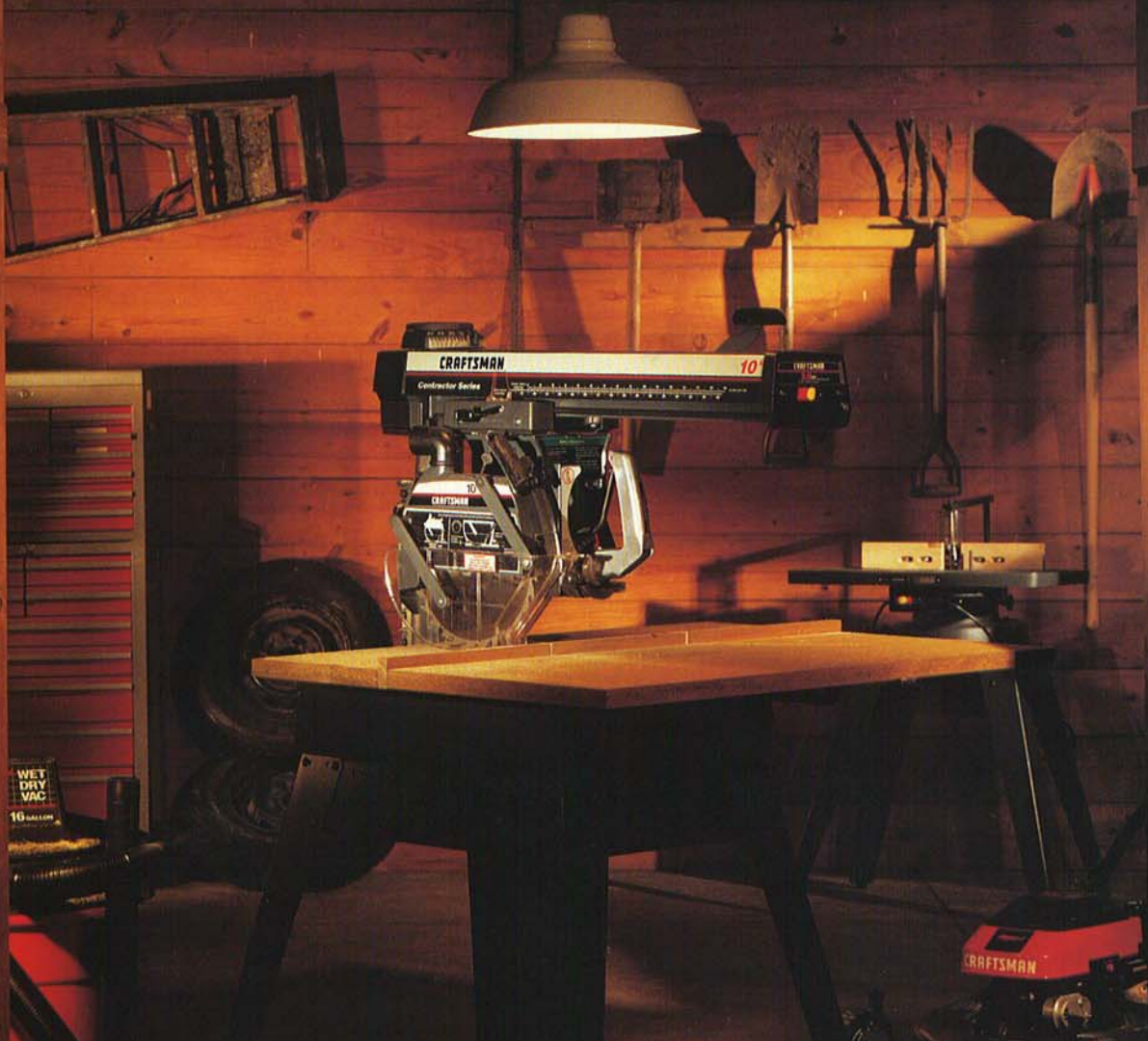

The radial saws that helped make Craftsman a household name are now more accurate and easier to align than ever before.

We built our first radial arm saw in 1956. And we've been building on that design ever since. Our newest radials incorporate improvements such as our revolutionary new blade guard that will make Craftsman an industry leader for generations to come.

You can crosscut, rip, miter, or bevel cut, and with easy to install accessories, you can create dados and decorative molding, route, drill, sand or plane. No other tool lets you accomplish so much with such ease or accuracy.

The new Craftsman radials are on display at your nearby Sears store.

CRAFTSMAN®
Only at Sears