

Better Homes and Gardens®

WOOD

THE WORLD'S LEADING WOODWORKING MAGAZINE
OCTOBER 1998 ISSUE 103

TERRIFIC HOME & SHOP PROJECTS

- Oak nightstand
- Wood-stemmed glasses
- Magazine storage cases
- Drafting/reference center
- Box-joint jig

Build our Craftsman-style

Entertainment Center



U.S.A. \$5.95

Display until September 29

<http://www.woodmagazine.com>

GRIZZLY INDUSTRIAL

PURVEYORS OF FINE MACHINERY

SPECIAL 2 H.P. DUST COLLECTOR OFFER

TOP QUALITY This is the best 2H.P. Dust Collector on the market – period!

BEST SELLING We've been selling this unit for years. We have all the parts, service and expertise for you to buy in total confidence.

UNBELIEVABLE PRICE While others talk big – we deliver! We have sacrificed nothing in quality. We simply buy direct in huge quantities with no middleman and pass the savings on to you.

SPECIFICATIONS:

- 2 H.P. 220V electric motor
- 19" Impeller
- Overall height 78"
- Base 21 1/4" x 33 1/2"
- Air suction 1182 cfm
- 5" main, two 4" intake ports
- Approx. shipping weight 140 lbs.

MODEL G1029

REG. ~~\$279⁹⁵~~

SALE \$249⁹⁵

F.O.B. OUR WAREHOUSE

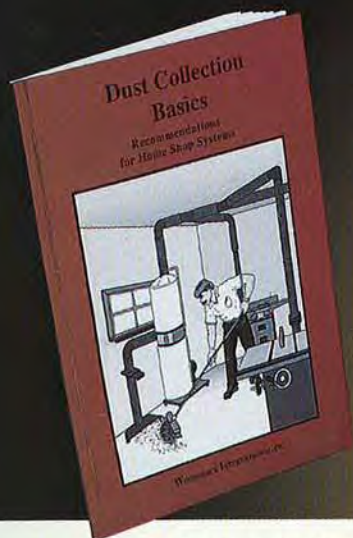

"Dust collection Basics" Book

This incisive book skillfully guides the woodworker through all the steps necessary in the design and construction of an efficient central dust collection system. Fifty pages of concise, carefully illustrated text. **YOUR'S FREE** with purchase of dust collector!

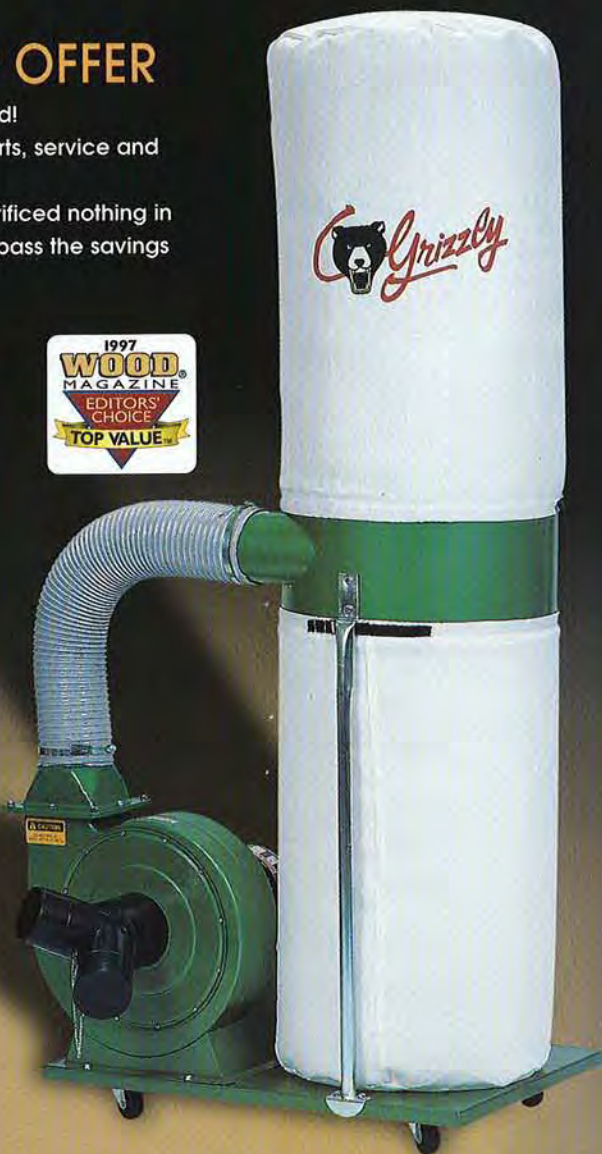

DUST COLLECTION ACCESSORIES KIT #1



- 1-4" x 10' Hose
- 1-Universal Dust Hood
- 2-4" Wire Hose Clamps
- Shipping Weight: 6 lbs., 10 oz.

MODEL G3181

\$19⁹⁵

DUST COLLECTION ACCESSORIES KIT #2



- 2-4" Blast Gates
- 2-4" x 10' Hose
- 1-Table saw Dust Hood
- 1-Universal Dust Hood
- 1-4" Y-fitting
- 10-4" Wire Hose Clamps
- Shipping Weight: 15 lbs., 14 oz.

MODEL G3182

\$51⁴⁹

Circle No. 860

CALL TODAY FOR YOUR FREE 1998 WOODWORKING CATALOG — ORDER 24 HOURS A DAY!

162698658R1

1 - 8 0 0 - 5 2 3 - 4 7 7 7

CUSTOMER SERVICE: (717)326-3806 FAX: (800)438-5901 WEBSITE: <http://www.grizzlyindustrial.com>

VISIT OUR 3 SHOWROOM LOCATIONS:

1821 Valencia St., Bellingham, WA • 4651 Hickory Hill Rd., Memphis, TN • 2406 Reach Road, Williamsport, PA

76E

MEDIA CODE



Better Homes and Gardens®

WOOD®

THE WORLD'S LEADING WOODWORKING MAGAZINE

CONTENTS



Page 50



Page 64



Page 44

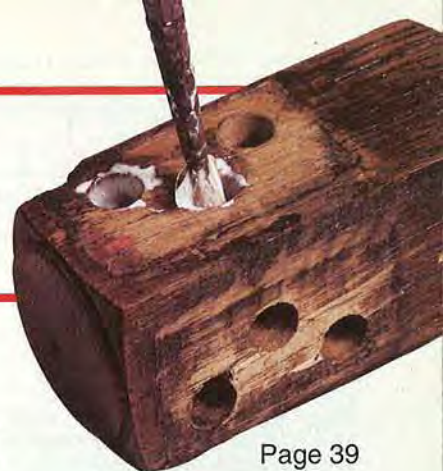

Page 39

35 Woodworking Hall of Fame™

Join us as we induct two influential woodworkers into our prestigious Hall: designer/craftsman Sam Maloof, and TV personality Norm Abram.

39 Fixing up that old joint

Discover the secrets of regluing failed woodworking joints from a professional restorer.

58 Premium dado sets

Find out what goes into a top-quality dado set and which of 14 tested models performed best.

72 Toy contest winners take a bow!

Enjoy the creativity of the winning entries in our final Build-A-Toy® contest.

78 Popular playthings from the past

Take a nostalgic step back to view the toys that kids played with during simpler times.

Projects

44 Box-joint jig

Build a precision shop aid that lets you make microadjustable cuts on your table saw.

50 Well-made magazine cases

Use the jig described *above* to create handy, attractive storage for your favorite magazines.

52 More than a nightstand

Furnish a bedroom or other location with this pleasing Craftsman-era lamp table.

64 Entertainment extravaganza

Now, place all of your home electronics in our fashionable Craftsman-style cabinet system.

74 Goblets with a turner's touch

Impress dinner guests with glassware featuring fancy wooden stems.



Page 52



Page 58

SHORT-SUBJECT FEATURES

2 The Editor's Angle

4 Talking Back

8 Develop Your Shop Skills: Climb Cutting

11 Wood Anecdote

12 For Sharper Tools, Try Waterstones

18 How To Insure A Woodworking Business

20 Tips From Your Shop (And Ours)

28 Ask WOOD

33 How To Make A Zero-Clearance Insert

82 Drafting/Reference Center

84 The Original Cordless Drills

88 Products That Perform

110 Dealing With Dowel Joints

112 Finishing Touches

Editor **LARRY CLAYTON**
 Managing Editor **JIM HARROLD**
 Art Director **C. L. GATZKE**
 Design Editor **JAMES R. DOWNING**
 Senior Editor/Features **PETER J. STEPHANO**
 Senior Editor/How-To **MARLEN KEMMET**
 Assistant Managing Editor/Products **BILL KRIER**
 Senior Editor/Special-Interest **LARRY JOHNSTON**
 General-Interest Editor **DAVE CAMPBELL**
 Associate Art Director **PERRY A. McFARLIN**
 Assistant Design Editor/Project Builder **JAN HALE SVEC**
 Project Builder **CHARLES I. HEDLUND**
 Senior Graphic Designer **CHERYL A. CIBULA**
 Production/Office Manager **MARGARET CLOSER**
 Administrative Assistant **SHERYL MUNYON**
 Art Business Office Secretary **BARBARA HELPS**
 Correspondence Writer **ROBBY PEDERSEN**
 Contributing Editors **KIM DOWNING, DAVE HENDERSON,**
LORNA JOHNSON, ROXANNE LeMOINE, BOB McFARLIN

©Copyright Meredith Corporation 1998
 All rights reserved. Printed in the U.S.A.

Better Homes and Gardens® **WOOD**® magazine (ISSN-0743-894X) is published nine times a year in January, February, March, April, June, August, October, November, and December by Meredith Corporation, 1716 Locust St., Des Moines, IA 50309-3023. Periodicals postage paid at Des Moines, Iowa, and additional mailing offices. Better Homes and Gardens trademark registered in Canada and Australia. Marca Registrada en México. **ONE-YEAR SUBSCRIPTION PRICES:** U.S. and its possessions, \$27; Canada, \$39; other countries, \$47. Canadian GST Reg. #BN 12348 2887 RT. **POSTMASTER:** Send address changes to *Better Homes and Gardens WOOD Magazine*, P.O. Box 55050, Boulder, CO 80328-5050.

CUSTOMER SERVICE INFORMATION: For service on your magazine subscription including change of address, phone toll-free **800/374-9663**. Or, write to *Better Homes and Gardens WOOD Magazine*, P.O. Box 55050, Boulder, CO 80328-5050. Please enclose your address label from a recent issue.

EDITORIAL INFORMATION: Address letters and questions to THE EDITOR, *WOOD Magazine*, 1716 Locust Street, GA310, Des Moines, IA 50309-3023.

ATTENTION RETAILERS: To carry *WOOD* magazine in your store, call 800/659-5990, or write: Select Title Program, *WOOD Magazine*, 900 Kingsland, Batavia, IL 60510.



Better Homes and Gardens

WOOD Online
 at <http://woodmagazine.com>

Have you tried the downloadable **WOOD PLANS**® on **WOOD ONLINE**® yet? If not, this is a great time to check them out. We think they're the best woodworking plans on the internet, with large, clear drawings, sharp photographs, and complete instructions—plans of the quality you expect from *WOOD* magazine. See for yourself by downloading a free plan; just follow the simple instructions on the site. If you're already familiar with the downloadable plans, click over to the plans list to see the new ones available. ♣

THE EDITOR'S ANGLE



Build • a • Gift™

Help us help kids

Enter Our Great New Contest

As regular readers of this magazine know, we ended our successful Build-A-Toy® contest this year with mixed emotions. But when the opportunity arose to continue our sponsorship of the Marine Corps Reserve's Toys for Tots program, we jumped at the chance. So did several of our advertisers when we asked them to participate in our latest effort—Build-A-Gift. So here we are.

This contest differs from our Build-A-Toy contest in a couple of ways. First, the items you submit can range from a jewelry box to a beautiful turned vase, toy, or holiday decoration, to name just a few. In other words, the categories are wide open, as long as the project can fit into a 2x2x2' box.

Second, with this contest, you have more cate-

gories to enter. (See pp. 86-87 for the prizes and the official rules.)

The deadline for entries is November 30, 1998. So if you want to do something to help a needy child this Christmas, tie on your shop apron and start making some sawdust pronto! Who knows, you may win one of the great prizes being offered, perhaps even the 1999 Dodge Dakota pickup.

As in the past, a panel of judges will select the winners, in this case by December 15, 1998. Then, we'll auction off the entries

to raise as much money as possible. And after the proceeds have been tallied, we will purchase as many toys as the money will buy, and we will turn them over to the Marine Corps Reserve for distribution.

Here's hoping that many of you decide to enter. It'll be fun and fulfilling for you. ♣



Thanks for your support.

Larry Clayton

IF ONLY
SURGEONS
HAD IT THIS GOOD.

BOSCH

THERE ARE NO SECOND CHANCES. THAT'S WHY YOU REACH FOR THE LEGENDARY SAW THAT CREATED THE CATEGORY 50 YEARS AGO. THE WHISPER-QUIET MOTOR THAT HUMS OF SUPERIOR ENGINEERING. THE LINEAR COUNTER BALANCE MECHANISM THAT MINIMIZES VIBRATION. THE MACHINE THAT RAISED THE PRECISION CROSSBAR A FEW SIGNIFICANT HAIRS. NO NEED TO SCRUB UP BEFORE OPERATING.

VARIABLE SPEED JIGSAW

5.0 AMP | 45° BEVEL | WWW.BOSCHTOOLS.COM

ENGINEERED FOR PERFORMANCE



BED POSTS IN STOCK

NO MINIMUM
VARIOUS
WOODS



A0802 PENCIL CANOPY
A0808 PLAIN POST
A0801 CANNON BALL
A0800 REEDED POST
A0807 RICED BED
A0803 RICE BED

Adams Wood Products LTD., L.P.
974 FOREST DR., DEPT. M41
MORRISTOWN, TN 37814
TEL 423-587-2942 • FAX 423-586-2188

Circle No. 1002

TALKING BACK

A better way to replace sanding sleeves

I read with interest your recent article on the Dremel contour sander from issue #102. I lost interest in this tool when I discovered replacement sanding sleeves are \$6-\$8 for just five. I found myself using the tool less frequently until I devised this way to make my own sleeves.

First, cut a 3½" strip off a 9"-wide sheet of sandpaper. Then run a fine bead of yellow glue along the inside edge, and wrap the sandpaper tightly around a 1" dowel about 15" long. Don't use too much glue, or it'll squeeze out and stick the paper to the dowel. Now, while holding tight, roll this into a sheet of wax paper. I stretch several rubber bands folded over and criss-cross to hold the sandpaper and dowel in place. After ten minutes, give the dowel a twist to free it from

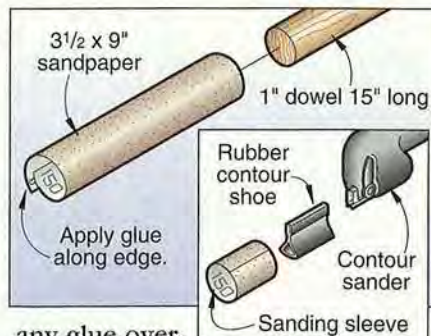

any glue overflow. After the glue sets up, slip the paper off the dowel, and cut into 2½" lengths.

One sheet of sandpaper gives me a dozen sanding sleeves for about 25 cents. I've also made my own sleeves with wet/dry paper, and emery cloth for other purposes.

—Marty Martens, Nanaimo, British Columbia, Canada

Great idea, Marty. We'd like to add this idea: by putting some finish on the dowel, you won't have as many problems with glue sticking the sandpaper to the dowel.

Aniline advice from a pro

I read and enjoyed your article about aniline dyes in issue #104. That is, until the final sentence when you mentioned that any clear finish can be applied to wood dyed with anilines. This statement could lead readers into tragic finishing experiences.

Different aniline dyes dissolve in different solvents — water, alcohol, and oil. You use distilled water as a solvent for water dye, denatured alcohol for alcohol dye, and mineral spirits or lacquer thinner with oil dye. Adding or weakening the solvent of an aniline dye solution lets you control the color. But when you apply a clear finish to dyed wood, *you can not use a finish that has the same base as the dye's sol-*



vent. For example, using water-based polyurethane over a water-based aniline dye will cause the dye to bleed into the clear coat and muddy the finish. Always use a solvent for your aniline dye that is different than the base of your finish.

—Sal Marino of Constantine's Woodworker's Catalog, Bronx, N.Y.

Let us know what's on your mind

We welcome your comments, criticisms, suggestions, and yes, even compliments. We'll do our level best to publish letters of the great-

est benefit to all our readers. Write to us at: Talking Back, *WOOD Magazine*, 1716 Locust Street, GA310, Des Moines, IA 50309-3023.

Better Homes and Gardens® WOOD Advertising & Marketing THE WORLD'S LEADING WOODWORKING MAGAZINE

Publisher WILLIAM R. REED
Advertising Director MARK HAGEN
Manager, Marketing and New Business Development
CATHERINE BJORK
Asst. Advertising Services Manager PAT HENDERSHOTT

Display Advertising: 333 N. Michigan Ave., Suite 1101, Chicago, IL 60601 Phone: 312/853-2890 FAX: 312/580-7906
Eastern Advertising Manager JAMES N. FORD
Western Advertising Manager WILL MURPHY
Administrative Assistant GERALLIE LEGASPI

Direct Response Advertising: 1912 Grand Ave., Des Moines, IA 50309-3379 Phone: 515/284-3785 FAX: 515/284-3343
Direct Response Advertising Manager RICH RAINFORTH
Direct Response Advertising CINDY ANDERSON,
PATRICK MADDEN
Administrative Assistant KRISTI HASEK
Classified Advertising: Phone: 800/424-3090 FAX: 312/464-0512

Circulation Director LIZ BREDESON
Associate Circulation Director KATHI PRIEN
Business Manager JANET DONNELLY
Senior Product Manager RICK GROW
Publishing Director JERRY WARD

MEREDITH PUBLISHING GROUP

CHRISTOPHER M. LITTLE, President
BILL MURPHY, Strategic Marketing; MAX RUNCIMAN, Finance;
DEAN PIETERS, Operations; BRUCE HESTON, Manufacturing;
JERRY KAPLAN, Integrated Marketing; HAL ORINGER, Consumer Marketing; ELLEN DE LATHOUDER, Creative Services



WILLIAM T. KERR, President and Chief Executive Officer
E. T. MEREDITH III, Chairman of the Executive Committee





THIN IS IN

Experience the ultimate thin kerf line

Freud's thin kerf design was created for table saws, miter boxes, and radial arm saws, which makes this series popular with finish and trim carpenters. Popular because each blade is made of 42 Rc steel with razor sharp teeth made of the finest grade of carbide available. Our combination of these materials produces a thin kerf blade which will give smooth crosscuts in hardwood and softwood as well as cutting veneered plywood, chipboard, laminates and delicate molding practically chip free.

In the past, thin kerf blades from other manufacturers have had an inferior reputation due to problems with misaligned teeth, poor blade body tensioning, carbide chipping, flexing and warping. However, this is not the case with a Freud blade. Unlike the other manufacturers, Freud is proud of the quality and technology that goes into each product. Each one of our thin kerf blades are produced by a computer-controlled laser. We have engineered these blades to have a kerf that is 28% thinner than a standard blade. Each blade has strategically placed expansion slots which allow the body of the blade to expand from the centrifugal forces and thermal expansion forces during actual use. Each slot is kept to an extremely narrow width to prevent air turbulence and reduce noise. Every blade is made out of a premium quality steel with a Rockwell hardness of 40-42 Rc. Through tensioning, the body will hold true when overheated. We guarantee the body will remain true up to a temperature of 475° Fahrenheit. As an added feature, Freud offers these blades with a Teflon-S® coating. Freud was one of the first manufacturers to apply DuPont's Teflon® to industrial quality saw blades. This reduces the amount of friction between the blade and the wood and yields a blade that is protected from corrosion and easy to clean. TCS Teflon coated blades also have 38% less pull on the saw. This translates into over 1/3 more cutting power. As a bonus, the smoother cutting action means less wear and tear on the motor.

Your needs as a woodworker are unique. At Freud, we understand your needs and can provide the quality and dependability you have come to expect. We also feel that safety is essential. Anyone who has been involved with woodworking has experienced saw blade kickbacks from overfeeding. These can be very dangerous and can happen so quickly that it is impossible to react before injury occurs. Freud's thin kerf series of saw blades have an anti-kickback design which reduces the effects of these kickbacks. Each tooth is preceded by a limiter which restricts tooth bite to the maximum safe amount. By incorporating all these features into one series of blades, Freud can offer a superior line of blades that will answer the needs of all woodworkers. Give our thin kerf series a try and see why "Thin Is In".

("Information courtesy of DuPont Teflon® Industrial Coatings")
Red is a trademark of Freud USA, Inc.

freud®

Precisely What You Need.

For any comments or questions about our products we can be reached at
1-800-472-7307 High Point, NC
1-800-263-7016 Mississauga, Ontario
freudinc@aol.com

Won, two,



Thanks. For giving us your Best. Strategic Vision's 1998 Total Quality Award for "Best Ownership Experience" in the Full-Size Pickup class went to Dodge Ram.† We should probably point out, Ram is the only full-size pickup that's ever won. Let alone won four. And Durango won, too. For "Best Ownership Experience" among Mid-Size Sport Utility Vehicles.† Winning like this could get habit-forming. And we have you to thank for that.



The New Dodge

For more information, call 1-800-4-A-DODGE, or visit our Web site at www.4adodge.com

†Strategic Vision's 1998 Vehicle Experience Study™ surveyed 32,191 Oct.-Nov. new vehicle buyers of 200+ models after the first 90 days of ownership.

three, four.

Dodge Ram—1995, 1996, 1997, 1998 Total Quality Award™ “Best Ownership Experience” Full-Size Pickups

Won, too.

Dodge Durango—1998 Total Quality Award “Best Ownership Experience” Mid-Size Sport Utility Vehicles



Climb Cutting

A good way to up the quality of your routed pieces

Sometimes, it makes sense to go in the opposite direction of prevailing wisdom. Such is the case with climb cutting—the practice of running a handheld router in a clockwise motion around the edge of a workpiece.

How this procedure gives you smooth routed edges

As shown at *bottom*, when you feed a router in the “typical” (counter-clockwise) direction, the bit’s cutting edges lift the grain of the workpiece. But, in a climb cut, the bit pulls the grain down as its cutting edges enter the workpiece.

So, with a climb cut you don’t get the splintering that you often get with a bit fed counter-clockwise. And, climb cutting has a burnishing effect on the wood, leaving an exceptionally smooth routed surface. For those reasons we climb cut most of the time we rout an edge with a handheld router.

How to make a climb cut

Climb cutting takes a little getting used to, so practice this technique with small router bits and scrap softwood. Remove no more than $\frac{1}{8}$ " of stock when using small bits, and restrict yourself to about $\frac{1}{16}$ " of stock removal when using larger bits such as $\frac{1}{2}$ " cove bits. Use sharp bits, and never climb cut with bits over 2" in diameter.

When you climb cut, your router will want to run away from you, so hold on firmly with both hands. The workpiece should be clamped down—not simply sitting on a router mat.

Because a climb-cutting bit does not tend to pull into the workpiece, you don’t have to lower your bit to increase its cut for each successive pass. Simply set the bit to its full cutting depth and remove a little more stock with each cutting pass. You’ll be surprised at how quickly you can rout edges, and how much control you have over this “freehand” process provided you take light cuts.

Although you get little splintering with a climb cut, it still makes

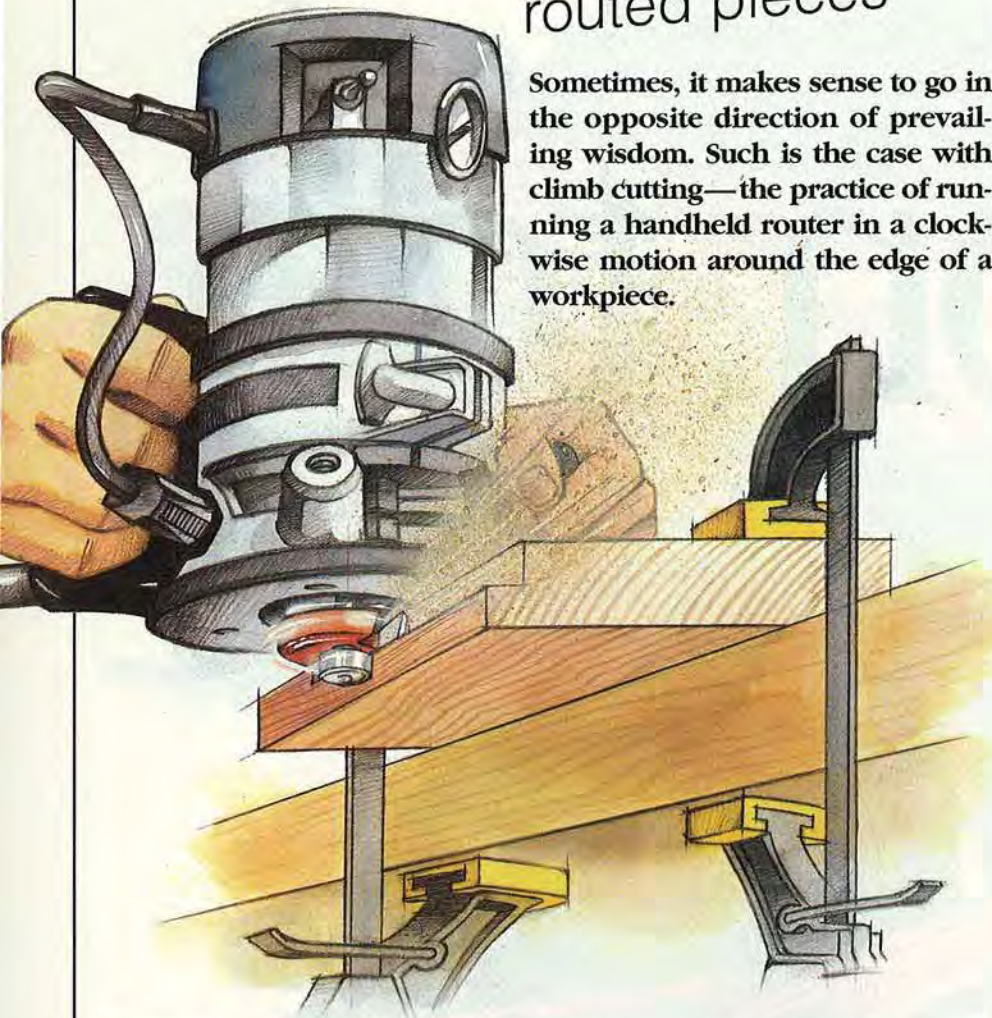

HOW CLIMB CUTTING GIVES SMOOTHER RESULTS

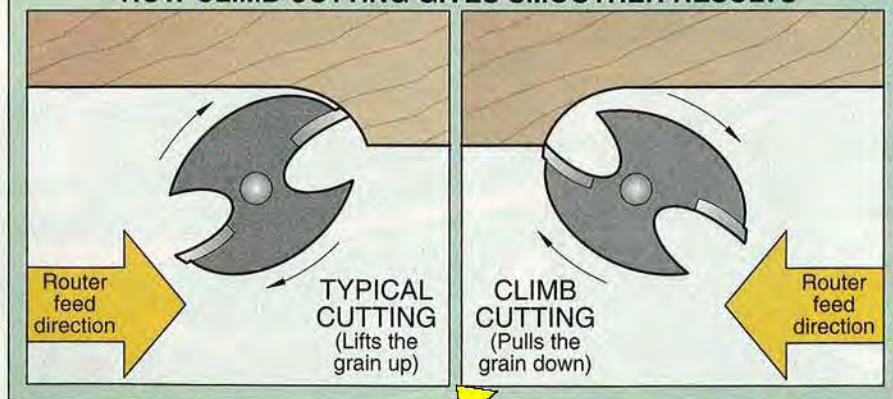

Continued on page 10

POWERMATIC® III®

MODEL 66 Tilting Arbor 10" Table Saw

Select either Powermatic Model 66 and you've made the best choice.

It's a win win situation. Select the Powermatic Model 66 Industrial Standard Edition table saw and equip it with optional accessories to fit a precise need in your shop... or select the well-equipped Model 66 Home Workshop Special Edition and you have the best 10" Table Saw made. Check out the special savings available on both today.

But hurry, these are limited-time offers.

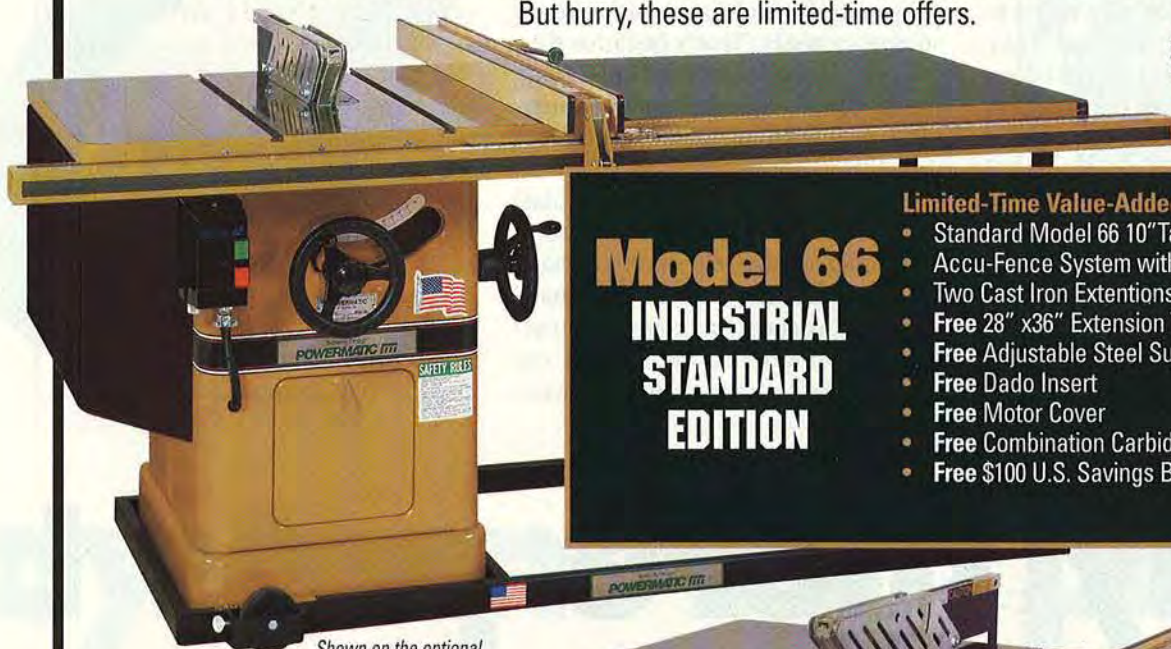

Shown on the optional
Mobile Base

Model 66 INDUSTRIAL STANDARD EDITION

Limited-Time Value-Added Package:

- Standard Model 66 10" Table Saw
- Accu-Fence System with 50" Rail
- Two Cast Iron Extensions
- Free 28" x36" Extension Table
- Free Adjustable Steel Support Legs
- Free Dado Insert
- Free Motor Cover
- Free Combination Carbide-Tipped Blade
- Free \$100 U.S. Savings Bond

Model 66 HOME WORKSHOP SPECIAL EDITION

- Standard Model 66 10" Table Saw
- Accu-Fence System with 30" Rail
- One Cast Iron Extension
- 3-HP, Single-Phase 230v Motor only
- Free 28" wide by 24" long Extension
- Free Motor Cover
- Free Combination Carbide-Tipped Blade
- Free \$100 U.S. Savings Bond



Made in the U.S.A.*

*These machines are
made of high-grade
American cast iron

Shown on the optional Mobile Base

Circle No. 81

POWERMATIC® III® BETTER BY DESIGN™

Call 1-800-248-0144 for Your Nearest Powermatic Dealer • Internet Home Page: <http://www.powermatic.com> or e-mail, powermatic@worldnet.att.net

Continued from page 8

sense to follow the traditional wisdom of routing the ends of a workpiece before routing the edges. If you see some "fuzzing" of the grain when you climb cut, you probably have a dull bit. (Some woods, such as butternut and willow, will fuzz even with sharp bits.)

When not to climb cut

Under many circumstances, it still makes sense to feed a router in a counter-clockwise direction. That's because a bit fed that way tends to "pull" into the workpiece, template, or straightedge that you guide it against. This tendency to "hug" whatever you guide the router against serves you well when it's essential that the router not wander off course. For example, when cutting a dado, or the groove for holding a tambour door in the example *right*, the cut must follow its guiding edge exactly.

And, remember to always feed a workpiece in the typical right-to-left direction when using a router table. If you try to climb cut, the bit will pull the workpiece away from you, creating an unsafe situation, not to mention poor-quality cuts.

However, if you have the luxury of owning a power feeder mounted to your router table or shaper, climb cutting produces silky-smooth moldings with these stationary tools. That's because the power feeder controls the workpiece for a rock-steady cut, and your hands never come close to the cutting edges.

With man-made materials such as Corian or medium-density fiberboard (MDF), there's no advantage to climb cutting. That's because these materials have no natural grain that might tear out.

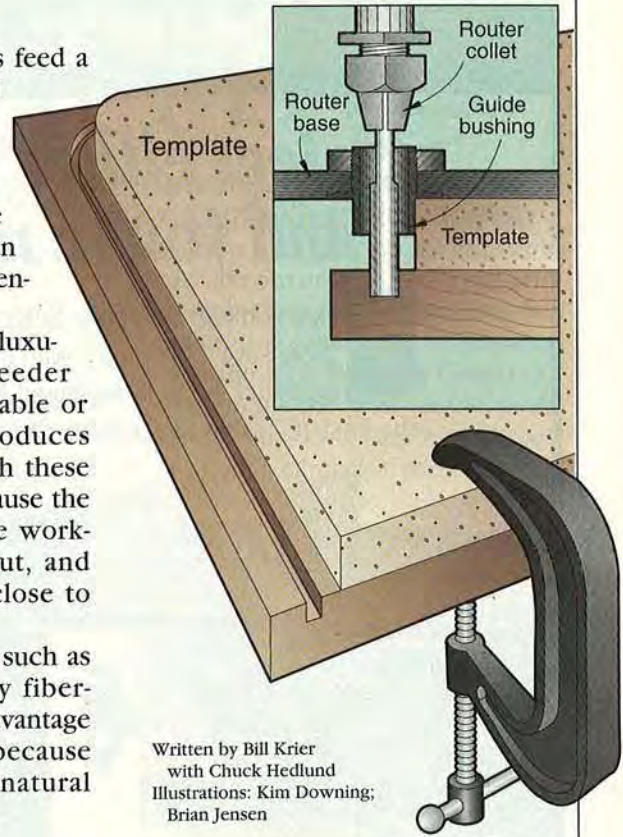

Written by Bill Krier
with Chuck Hedlund
Illustrations: Kim Downing;
Brian Jensen

Why more pros b



It's a fact: More people who make a living with their tools buy their tools at The Home Depot®. That's because we carry all the best brands of power tools that are available anywhere. Everything from light-duty to heavy-duty.

Milwaukee

RYOBI.

DEWALT

BOSCH

PECAN Hickory's nuttiest cousin

Some trees become known for attributes other than their wood. The shapely crown of the American elm, for instance, far exceeds the reputation of its boards. And so it is with the pecan tree (*Carya illinoensis*).

A cousin of the hickories, the pecan was notable for its sweet nuts long before the coming of white explorers. The Indians of the Lower Mississippi River Valley were so thankful for its nutty bounty that they associated the tree with the Great Spirit.

Spanish explorer and gold seeker Hernando DeSoto discovered the pecan when his party crossed the Mississippi River in 1541. According to his chronicles, the Spaniards relished the nuts from the trees because of their comparatively thin shells. But DeSoto wasn't a horticulturist, and failed to bring back samples.

The American trappers and traders of later centuries were more enterprising. From their excursions in the new frontier west of the Allegheny Mountains, they returned with furs to sell and pecan nuts to share. Thomas Jefferson heard of these "Mississippi nuts" and got some to plant at Monticello. He also gave some to his agriculturist friend, George Washington, who set them in a row at Mount Vernon.

That began the extensive propagation in the United States of the pecan as a nut tree. Today, cultured varieties of the species occupy orchards from Georgia to California and Oregon.

And what of the wood? The hard, strong, close-grained stock is valued for veneer and chairs. But throughout the South, it's the pecan nut of praline fame that draws the most applause. 🌰



Illustration:
Jim Stevenson

During the Civil War, Confederate soldiers could always rely on a snack of pecan nuts stashed in their knapsacks.

Buy from our pros.

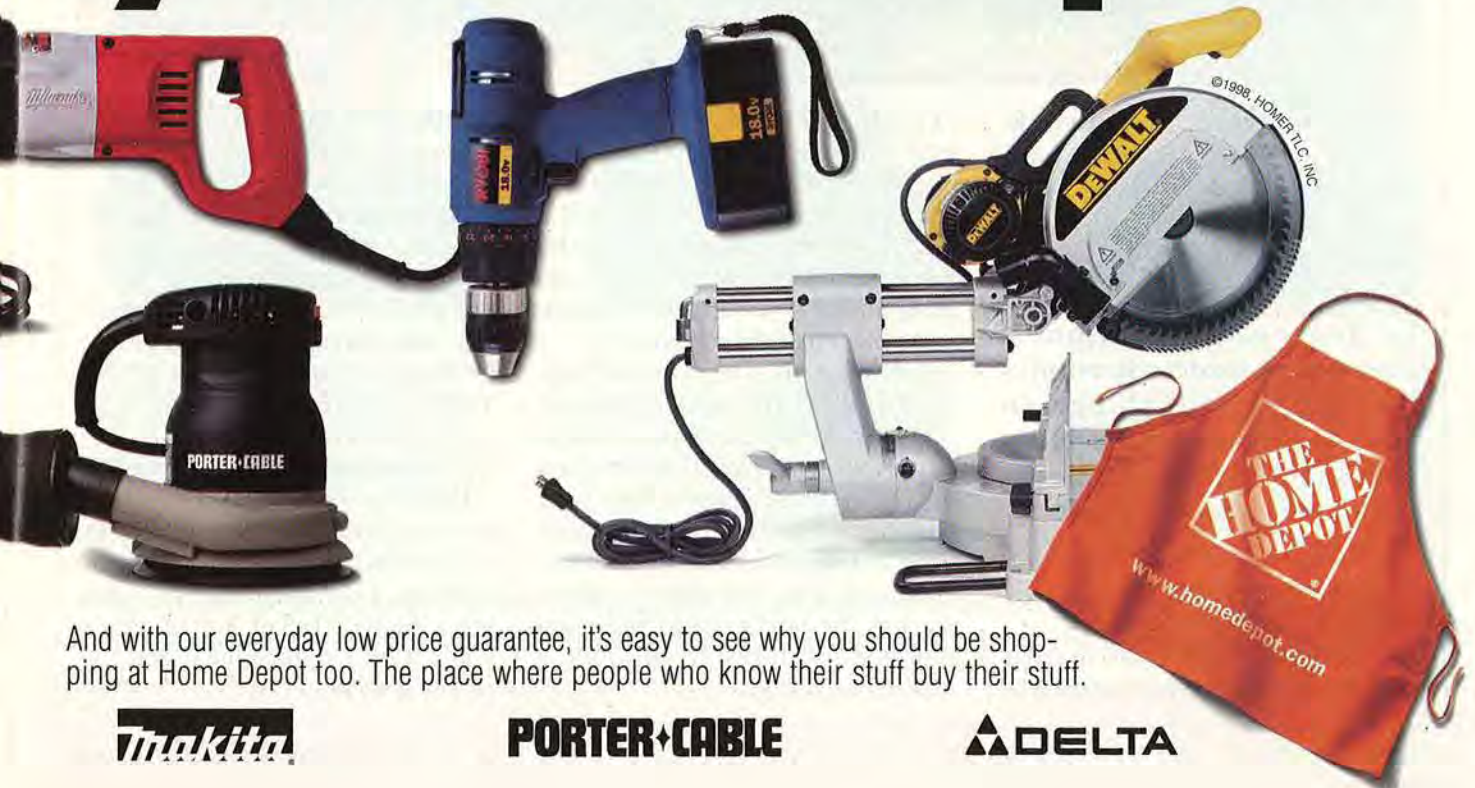

And with our everyday low price guarantee, it's easy to see why you should be shopping at Home Depot too. The place where people who know their stuff buy their stuff.

JUST ADD WATER

For sharper tools, try waterstones



Keep the stone's surface wet as you sharpen. A sharpening guide helps avoid gouging the surface.

More and more woodworkers are finding that the path to perfectly sharpened edge tools leads them through water. For that's what lubricates the increasingly popular Japanese waterstones. These man-made whetstones offer a big advantage in sharpening tools—an abrasive surface that constantly renews itself as you work.

Why waterstones outsharpen oilstones

A waterstone's soft abrasive particles break off in use, constantly,

exposing new, sharp edges. As you continue sharpening, those broken-off crystals crumble into smaller and smaller pieces. The crumbled crystals mix with the water on the stone's surface, creating a slurry—in effect, a honing and polishing compound.

Compare this with what happens to the hard abrasive particles which make up many other kinds of whetstones. Instead of breaking off through use, they round over and become dull. At the same time, oil residue and metal particles pack into the stone's pores, glazing the surface and reducing the stone's ability to produce a really sharp edge.

Study this for a good grade

Japanese waterstone grades cover a range from 150 to 8000 grit, but those numbers don't relate directly to U.S. grades. For example, the abrasive action of a Japanese 150-grit stone approximates a 100-grit U.S. one; the Japanese 1000, a U.S. 500; and the Japanese 4000, a U.S. 1000. It's better to relate waterstone grades to each other than to try converting them to U.S. grades.

Here are some points that will help you when buying waterstones:

- To remove a lot of metal fast, for restoring a damaged edge or changing a blade's bevel, for instance, you'll want a waterstone in the 150- to 250-grit range.

Continued on page 17

CMT™ A perfect SET UP



item 800.505.11

The CMT 13 Piece Set includes a selection of our most popular bits in the most requested cutting diameters: 3 Straight bits (1/4", 1/2" and 3/4"), a 1" Flush Trim bit, 1/2" Mortising bit, 1/8" Round Nose bit, a 90° V-Groove bit, a 1/2" -14° Dovetail bit, 1/2" Cove bit, 3/8" Rabbeting bit, 3/8" Roundover bit, 1/4" Ogee bit and a 1-3/4" - 45° Chamfer bit. Beautifully packaged in our hardwood case and marked with each profile on the outside for easy reference.



item 800.515.11

The CMT Sommerfeld 6 Piece Cabinetmaking Set features the uniquely designed Raised Panel bit with Back Cutter that mills both the front and back of the floating panel in one pass and the new cove profile Drawer Front bit. You also get the Ogee Rail and Stile matched pair, Ogee Door Edge bit and Super-Duty Flush Trim bit. Cathedral, French Provincial, Classic Country or Roman style templates are available separately from the CMT catalogue along with a companion video by Marc Sommerfeld.

If you work wood,
get set with the only **ORANGE** one



PLYWOOD GROOVE SET

The CMT Plywood Groove Set has been specially designed with bit diameters slightly smaller than purported plywood thicknesses so you get accurate, tight fitting joints. Each bit guarantees super clean grooves in the three most popular thicknesses of plywood: 1/4", 1/2", and 3/4".

item 811.501.11



ROUNDROVER SET

The CMT Roundover Set gives you the maximum flexibility when doing edge work and borders by putting the most requested diameters in one package - 1/4", 3/8", and 1/2".

item 838.501.11



RABBETING SET

The CMT Rabbeting Set includes a 1-3/8" diameter micrograin carbide tipped rabbeting bit and 6 interchangeable bearings (hex key and screw included) to let you flush trim and make 6 different rabbet depths ranging from 1/8" to 1/2".

item 835.502.11

These CMT sets give you only the best - quality super strength steel shanks and bodies and micrograin carbide-tipped bits, each one protected with CMT's trademark orange Teflon® coating. There's no better value for the price.

Circle No. 1312

FOR THE NAME OF THE CMT DEALER NEAREST YOU OR A COPY OF OUR CATALOGUE CALL CMT USA

CMT USA, Inc. 307-F Pomona Drive Greensboro, NC 27407 Toll free 1-888-CMT-BITS Free fax 1-800-268-9778 cmtusa@aol.com
CMT Utensili Srl Via della Meccanica - 61020 Chiusa di Ginestreto PS - Italia - cmtsrl@pesaro.com www.cmtutensili.com

© 1997 CMT Utensili Srl - TM: CMT, the CMT logo and the orange color applied to tool surfaces are trademarks of CMT Utensili Srl



3.5-HP,
VARIABLE-SPEED ROUTER



4-POSITION, 1/2-HP
ORBITAL-ACTION SAW



7.5-AMP,
1-HP IMPACT WRENCH



CRAFTSMAN 3-AMP, 5"
RANDOM-ORBIT SANDER



5-1/2" TRIM SAW

INTRODUCING 18 VOLTS OF PURE ADRENALINE. HANG ON TIGHT.

This is the drill that will give you a boost. Check out the new 18-volt cordless from Craftsman. Our most powerful cordless ever. Capable of driving through brick and concrete. Fully equipped with 345 lbs. per inch of torque, a two-speed gearbox, a 24-position clutch, 1400 RPMs and two rechargeable batteries. It's a drill you're gonna want to hold on to. And it's available only from Sears.

CRAFTSMAN

MAKES ANYTHING POSSIBLE

THE WORLD'S FIRST VIRTUAL WOODWORKING SHOW™



**"Enjoyed the show.
Hope you'll do a
repeat."**

**"The bargains were
terrific"**

Just a few of the comments made by
many of the visitors who attended the
first exhibition of
WOOD SHOW ONLINE™

Announcing the return of

WOOD SHOW ONLINE™

September 11th through September 21st

November 27th through December 7th

Just in time for the holidays!

WOOD SHOW ONLINE makes it easier than ever to access up-to-the-minute product information on what's new in the woodworking tool industry.

Talk with the experts and fellow-woodworkers and, take advantage of many show specials and more seminars!

Don't miss the excitement.

Watch for pre-registration

dates on our web site at

www.woodmagazine.com

Invite your friends along and enjoy WOOD SHOW ONLINE.

**From the editors of "the world's
leading woodworking magazine."**

Here's what to expect:

- **Booths with show specials**
 - **Seminars**
 - **Chat rooms**
 - **Discussion groups**
- And much more!**

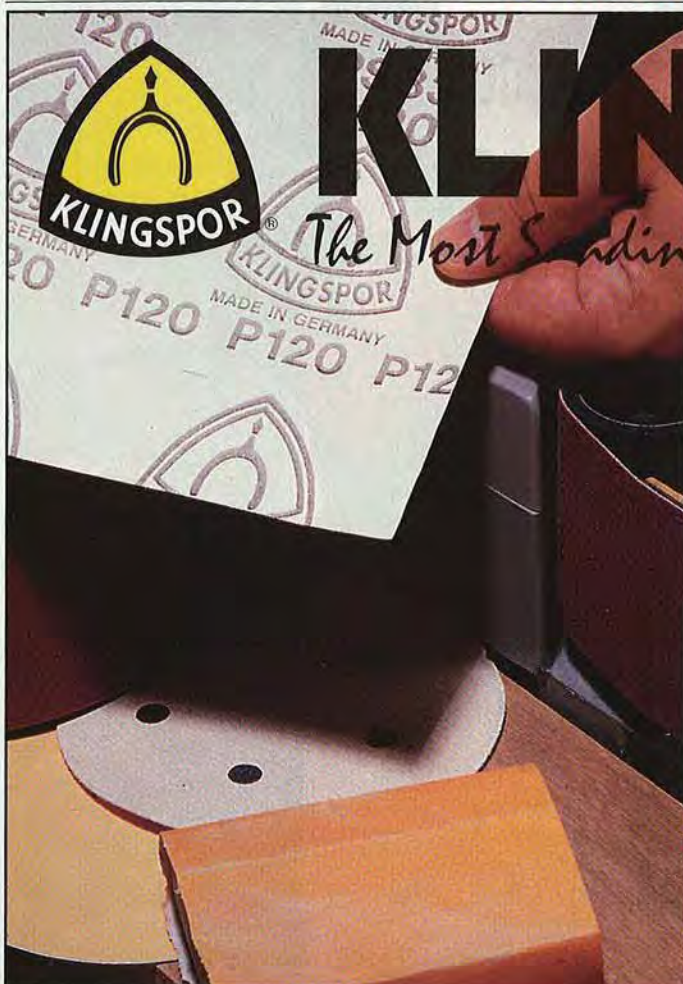

KLINGSPOR

The Most Sanding Power for Your Money!®

The Most Sanding Power For Your Money says it all - it's getting the best value out of your sanding supplies. Excellent performance from only the highest quality products combined with service & ship times matched by no other abrasive company at a price that's fair & competitive - with this combination, you'll save time & money in your sanding operations. Are you getting all of this from your current abrasives supplier?

Available from:

KLINGSPOR'S
Sanding Catalogue

P.O. Box 5069, Hickory, NC 28603-5069

Toll Free 1-800-228-0000 • Fax 1-800-872-2005

www.sandingcatalog.com • www.woodworkingshop.com
Call, write or fax today for your free catalog.

Continued from page 12

STONE HOLDER FOR SHALLOW TRAY

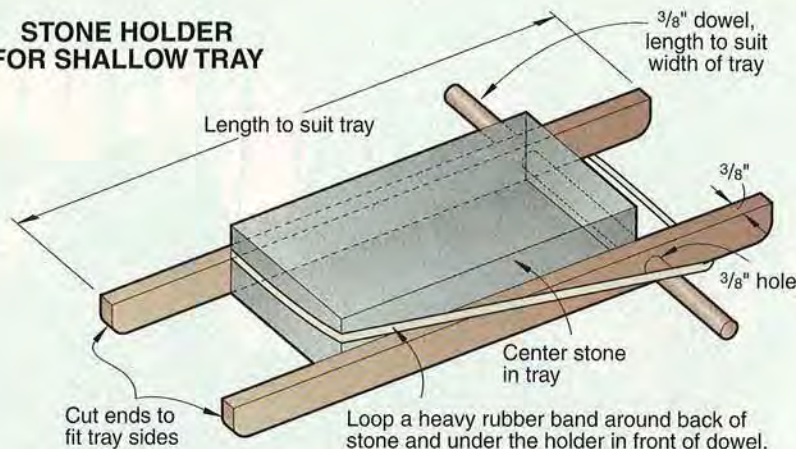

- You can count on an 800-, 1000-, or 1200-grit waterstone for general-purpose sharpening. The 800-grit stone is a good all-around choice if you sometimes have to sharpen nicked or heavily used edges.

- For honing and polishing a sharpened edge, select a 4000-grit or finer stone, sometimes called a finish stone.

- A pair of stones will suffice for normal tool sharpening—an 800, 1000, or 1200 and a 6000 or 8000. If you often deal with damaged edges, add a more aggressive 150- or 250-grit stone to your set.

- Individual waterstones cost from \$20-\$40 on average, with some ultrafine (8000-grit) finish stones running as high as \$75. You can buy combination stones, with a coarser grit on one side and a finer one on the other, for \$25 to \$50.

First, whet the stone's thirst

Waterstones are intended to be used wet. So before sharpening,

soak the stone for 10 to 15 minutes in clean water. (We bathe ours in a drywall-compound tray, shown *above right*. You can use any small pan deep enough to submerge the stone in.) While sharpening, keep the stone's surface wet. (We squirt water on the stone from a bicyclist's water bottle; any squeeze or spray bottle would do the job.)

All the water, along with the slurry of abrasive and steel particles that forms on the stone's wet surface, makes sharpening messy. To contain the mess and protect your benchtop, place the stone on a cookie pan or similar shallow tray. Hold the stone in the center, using spacer blocks or a simple fixture like the one shown in the illustration and *opening photo*.

For better sharpening and to protect the stone from accidental gouging, always hold the tool in a sharpening or honing guide, as shown in the *opening photo*.

Dry your stone for storage

Some woodworkers store waterstones in water-filled buckets or plastic boxes. That's okay for coarse and medium stones, but not for fine-grit finish stones. They should be stored dry.

We prefer to store all waterstones dry—or maybe damp would be a more accurate adjective. It's less hassle: You don't have to stash



Contain the sharpening mess with a shallow tray, such as a cookie pan. Other useful items include (clockwise from top) a plastic box for stone storage, a water bottle to rewet the surface periodically, a tray for soaking the stones, and a sharpening or honing guide (shown holding a plane iron ready for sharpening).

sloshy boxes of water in your shop, and you won't end up growing odd organisms if you fail to change the water often enough.

After use, just rinse the stone, pat it dry, and stick it into a lidded plastic box. (The stone will remain damp for a while, so keeping it in the original cardboard box isn't practical.) Protect waterstones from freezing temperatures—water that remains in a stone can freeze and crack it.

A flat stone sharpens best

Sharpening plane irons, chisels, and other tools calls for a flat stone. But, because sharpening action constantly shears abrasive particles from the waterstone, its surface can become dished. It's easy to flatten a stone again, though. Here's how:

Place a piece of 120-grit wet-or-dry sandpaper, abrasive side up, on a piece of glass or some other true, flat surface. Wet the sandpaper, then rub the stone on it in a figure-8 motion. Check the stone's face with a straightedge.

Flatten your waterstones after every few uses, rather than waiting for them to become noticeably dished. Even if you flatten a stone after every use, it will still last a long time. 🌱



Some waterstones, like the 6000-grit finish stone, come mounted on a wooden base. Also shown, a general-purpose 800-grit waterstone.

Photographs: Hetherington Photography Illustration: Roxanne LeMoine

Playing the Insurance Game

Woodworkers pose a risk for insurance purposes, but you can take steps to lower it



Woodworking is risky business. In an insurance company's view, combining sawdust, products made of wood, hazardous and flammable glues and finishes, and electrical machinery that can generate sparks makes an explosive situation that many insurers want to avoid. And keep in mind that most homeowners' policies limit coverage to \$2,500 for business-use items on premises and \$250 away from home. So for protection, separate business coverage is a must. But most professional woodworkers have trouble getting property insurance and sometimes casualty, liability, or even health and life insurance at reasonable rates.

Some woodworkers take chances without insurance

In Ohio, Ray Murray makes bunk beds and children's play forts in addition to less risky furniture. He can't find a company to provide product liability insurance for the beds, and the premium for play sets is so high he goes without. Instead, Ray has customers sign liability waivers. Then, he hopes nothing goes wrong.

Worse still, when Ray's health insurer found out that he was a

woodworker, the company canceled him. Once canceled, he couldn't find other coverage, except for a health maintenance organization required by state law to enroll anyone (albeit at a rate of over \$700 a month).

Fortunately, things can sometimes get better. David Smith, a woodworker with manufacturing and retail operations in Ohio and Florida, found insurance coverage expensive when he started more than a decade ago. Now, with a larger business and a good track record, David has reasonable rates from a major carrier, Nationwide Insurance (800/421-1444).

To impress carriers, reduce risks

Woodworkers looking for insurance can reduce risks to increase the chances of finding some at reasonable rates, according to Chris Kendall, administrative manager for commercial lines at Cincinnati Insurance Cos. (call 513/870-2000 for referral to an independent agent). His company covers woodworkers and other small businesses across the nation. He suggests the following steps to help obtain insurance:

- Ground all electrical equipment and buildings.
- If you smoke, quit, and don't let anyone in your shop smoke.
- Keep a clean shop. Proof of janitorial service helps.
- Spray or paint in an appropriate booth or have it done.
- Use dust-collection equipment.
- Store flammable and hazardous materials in locked cabinets away from sources of combustion. Keep paperwork, such as receipts from licensed hazardous waste haulers or dumps, to prove you dispose of hazardous materials properly.
- Keep your inventory of expensive woods to a minimum. If possible, store wood in a building separate from the workshop, just in case of fire.
- Reduce your liability by keeping customers out of your shop. Do business in a separate room.

Many of these steps are expensive. But the trade-off for not spending money on safety is paying higher insurance rates or simply going without insurance. ♣

Written by Jack Neff, a Batavia, Ohio, business writer and author of *How to Make Your Woodworking Pay for Itself*.
Photograph: John F. Schultz

\$50 REBATE

Any Delta 14" Bandsaw – open or closed base. This one's a Delta classic.

\$50 REBATE

Delta Sanding Center® Belt / Disc Sander. (Model 31-280)

\$100 REBATE

This one will handle just about anything you've got to joint. The Delta DJ-30 12" Jointer (Models 37-360/1) stands ready to take on a whole tree if you've got one.

\$100 REBATE

(Model 37-350 with electricals) DJ-20 8" Jointer. A mass of cast iron and precision.

\$200 REBATE

Put more productivity and large capacity planing into your shop with the Delta DC-580 20" Planer (Models 22-450/1). Delta will put a couple hundred bucks back into your pocket.

\$50 REBATE

Any of our 2000 Series 10" Contractor's Saws® with Premium Fence. (10" Contractor's Saw® II is not part of this rebate offer.)

\$50 REBATE

DC-380 15" Planer with stand and extension wings. (Models 22-675Y/6Y)

The Great Rebate.

\$100 REBATE

Any model Unisaw® – right or left tilt – Biesemeyer or Unifence®. You spec your dream saw. We'll put a hundred bucks back in your pocket.

Maybe the greatest rebate offer we've ever made. Delta workhorses, every one. The Delta stuff you really wish you had. With a little extra incentive to push you over the edge. A check in the mail from Delta, for a limited time, that is. (Through December 31, 1998.) So pick up the phone and call for the name of your nearest participating Delta dealer. Delta International Machinery Corp., 800-438-2486.

**THE
POWER
OF THE
PROS**



A Pentair Company

www.deltawoodworking.com

Proud sponsor of *The New Yankee Workshop* with Norm Abram and *The American Woodshop* with Scott Phillips.

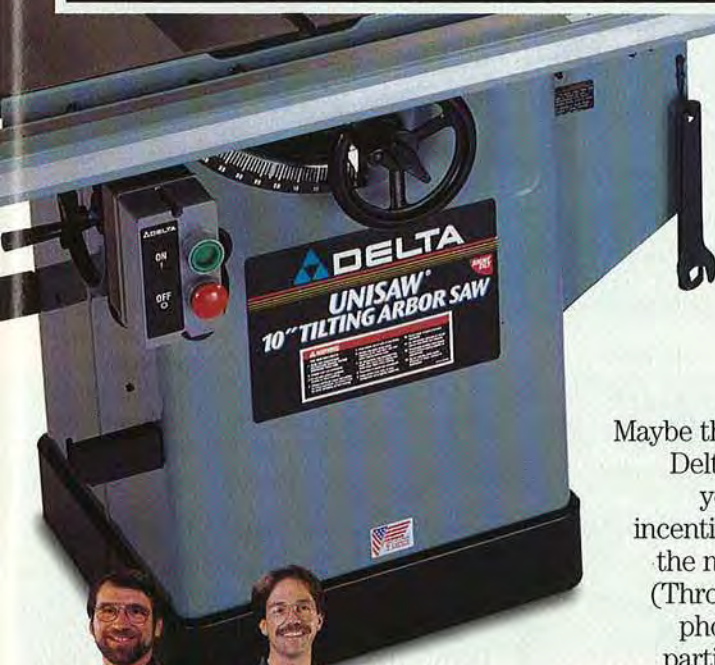



John Gottschalk finished as our Top Shop Tip winner for his method of attaching a dust-collection hose.

A carpenter by trade, John Gottschalk now has a desk job as project superintendent for a contracting firm. But you won't find him sitting around in his free time. When he gets home, he supervises his own wood projects and farms 80 acres of land near Hemlock, Michigan.

John describes himself as "time-poor," but he's banked enough hours to build projects ranging from a Burmese teak coffee table to a walnut humidor with lacewood inlays. His need for speed led him to create the quick-disconnect hose clamps, *right*.

If you've come up with a time-saving solution for your shop, it may be worth \$40. In each issue we pick one tip as our Top Shop Tip, and if it's yours, you'll win a tool prize valued at \$250 or more. To submit a tip, send a letter, with your daytime phone number and a photo or drawing of your idea, to:

Tips From Your Shop (And Ours)
WOOD® Magazine
 1716 Locust Street, GA-310
 Des Moines, IA 50309-3023

We try to publish only original shop tips, so please send your idea to *WOOD* magazine only. And please note that we cannot return submissions. Thanks!

Dave Campbell
 GENERAL-INTEREST EDITOR

Clamps team up for quick dust disconnect

In my small shop I have to move the larger stationary tools out of the way when I'm not using them. That means I am always connecting and disconnecting dust-collection hoses from my equipment.

I needed a hookup I could quickly secure and separate, so I made my own from a steel spring clamp and a hose clamp from an auto parts store. After cutting the hose clamp in the middle, I pop-riveted the cut ends to the jaws of a spring clamp.

Now, I squeeze the jaws open, slip the clamp over the dust hose, and release the jaws. My invention holds the hose fast



Top Shop Tip submitter John Gottschalk receives a Ryobi WDP1850 Wood Drilling System for his efforts. Nice job, John!

and, because the threads of the hose clamp are still intact, I can adjust the tension or size as needed.

—John Gottschalk, Hemlock, Mich.

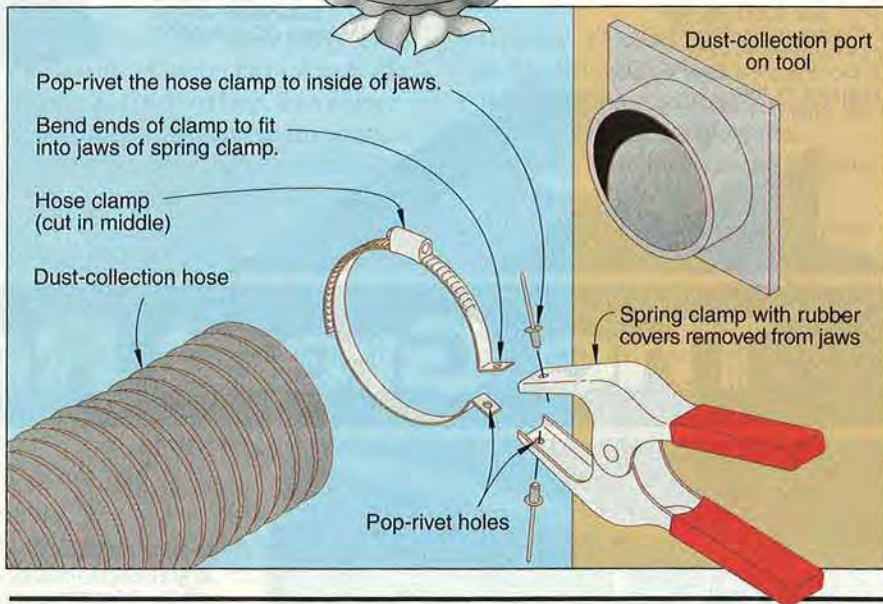

Paint roller cover makes a great contour sander



The graceful curves of some projects aren't well suited to sanding with a power contour sander. To sand these contours, I wrap a piece of sandpaper around an old (but still soft) paint roller cover. The nap of the roller gives plenty of cushion and contours itself to the workpiece. Use a 4"-long roller, or cut a longer roller to fit. For tighter curves, use a smaller-diameter trim roller.

—Jan Svec, Assistant Design Editor,
 WOOD magazine

Continued on page 22

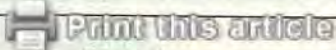



THE BEAUTY
OF OUR NEW
STAIN IS HOW
QUICKLY
IT WORKS.



Now your Sherwin-Williams store has a line of interior wood stain that not only dries quickly, but also comes in over 40 beautiful colors, including eight fun colors. New Wood Classics™ dries so quickly, you can complete a staining project in hours instead of days. Discover the beauty of Wood Classics in your home. Call 1-800-4-SHERWIN (1-800-474-3794) for a store near you.

When only the best will do. Ask Sherwin-Williams.™



PAINT, STAIN AND
WALLPAPER STORES

Continued from page 20

Save on drawer hardware with this simple slide

Look in the cabinet hardware section of any woodworking supply catalog, and you'll find a myriad of drawer slides. As a cabinetmaker, my father designed a simple slide system for drawers that's effective and inexpensive.

As shown in the drawing below, two centered guide rails run from

the face frame to the cabinet back. The drawer rides on the bottom guide, which is captured by a pair of runners attached to the drawer bottom. The runners end 1½" from the back of the drawer. The top guide prevents the drawer from tipping down as it opens. The drawer back, standing ¼" taller than the

sides, keeps the drawer from falling out when fully open. However, when you want to remove it, taper cuts on the bottom-back edges of the drawer sides provide the clearance. For durability, use hardwoods for the drawer sides and guides, and periodically apply paraffin wax to all the wear points.

—J. Norman MacLeod, Binghamton, N.Y.

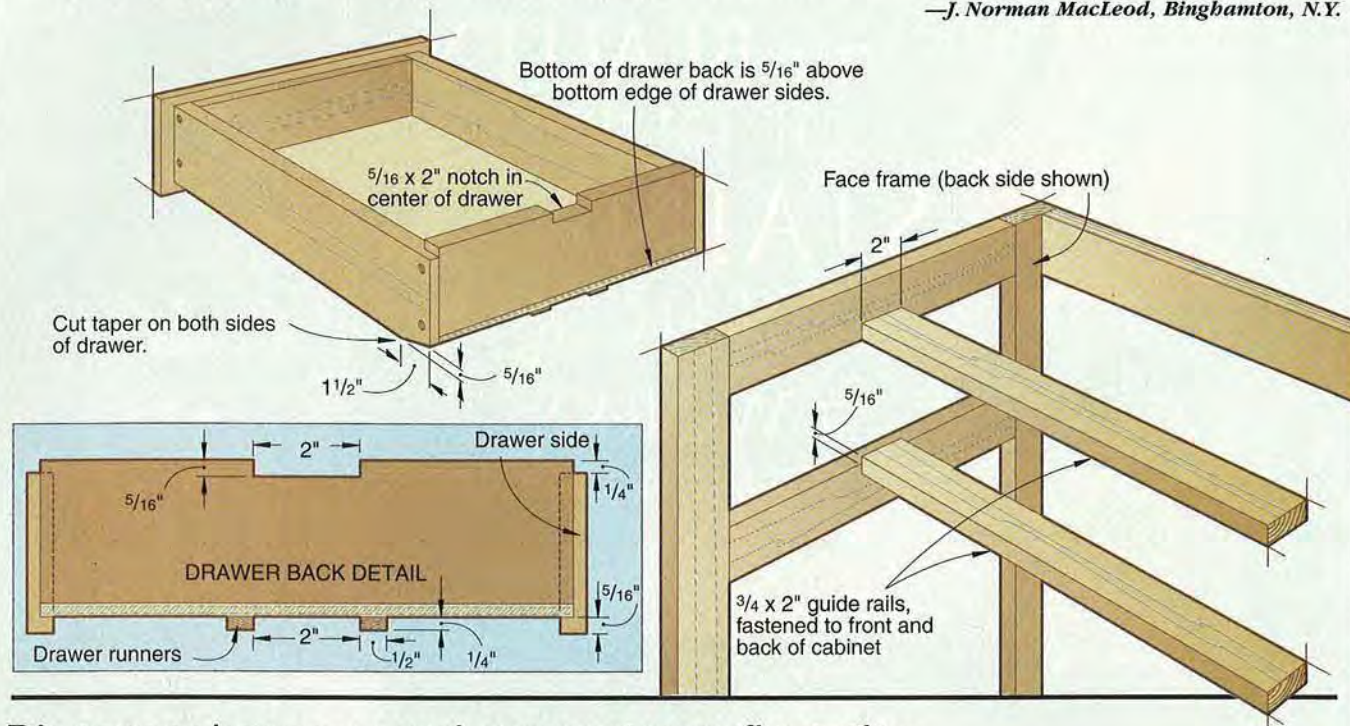

Dispenser keeps waxed paper at your fingertips

It seemed like whenever I needed waxed paper to protect my bench from glue squeeze-out, the waxed paper was buried in a drawer. I either had to dig it out with messy hands or stop and clean up before I went for it.

To put waxed paper within easy reach, I built a wooden box, just big enough to hold the waxed paper in its original box. To keep the roll from jumping out, I drilled a 1½" hole in each end, cut matching holes in both ends of the waxed paper box, and slid a 1" dowel rod through the whole works. Then, in each end of the dowel, I drilled a hole and slipped a hairpin hinge pin through the hole to keep the dowel in place. With the box screwed to the wall, I never hunt for waxed paper.

—Martin Cecil, Owensboro, Ky.

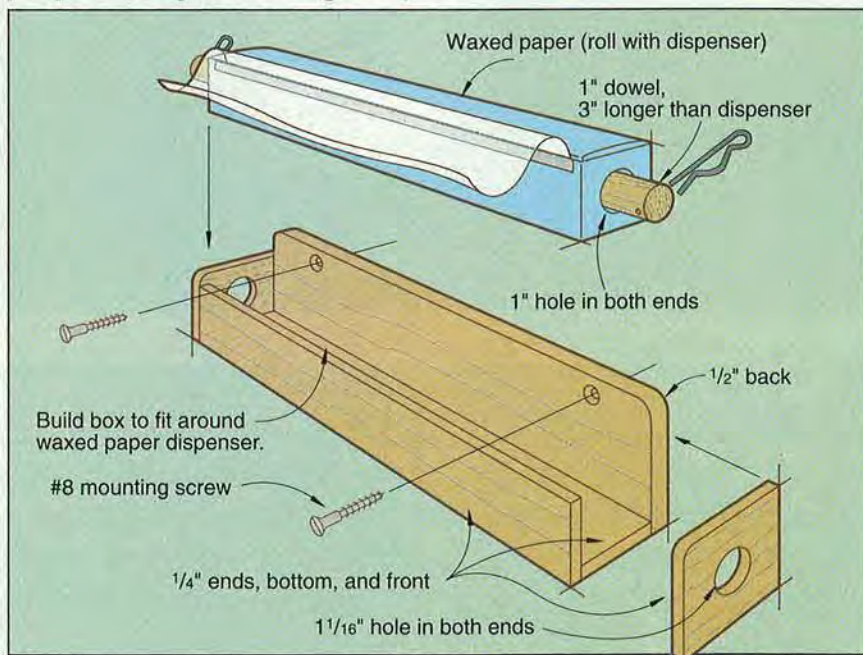

Continued on page 24

What would you build if quality power tools were affordable?

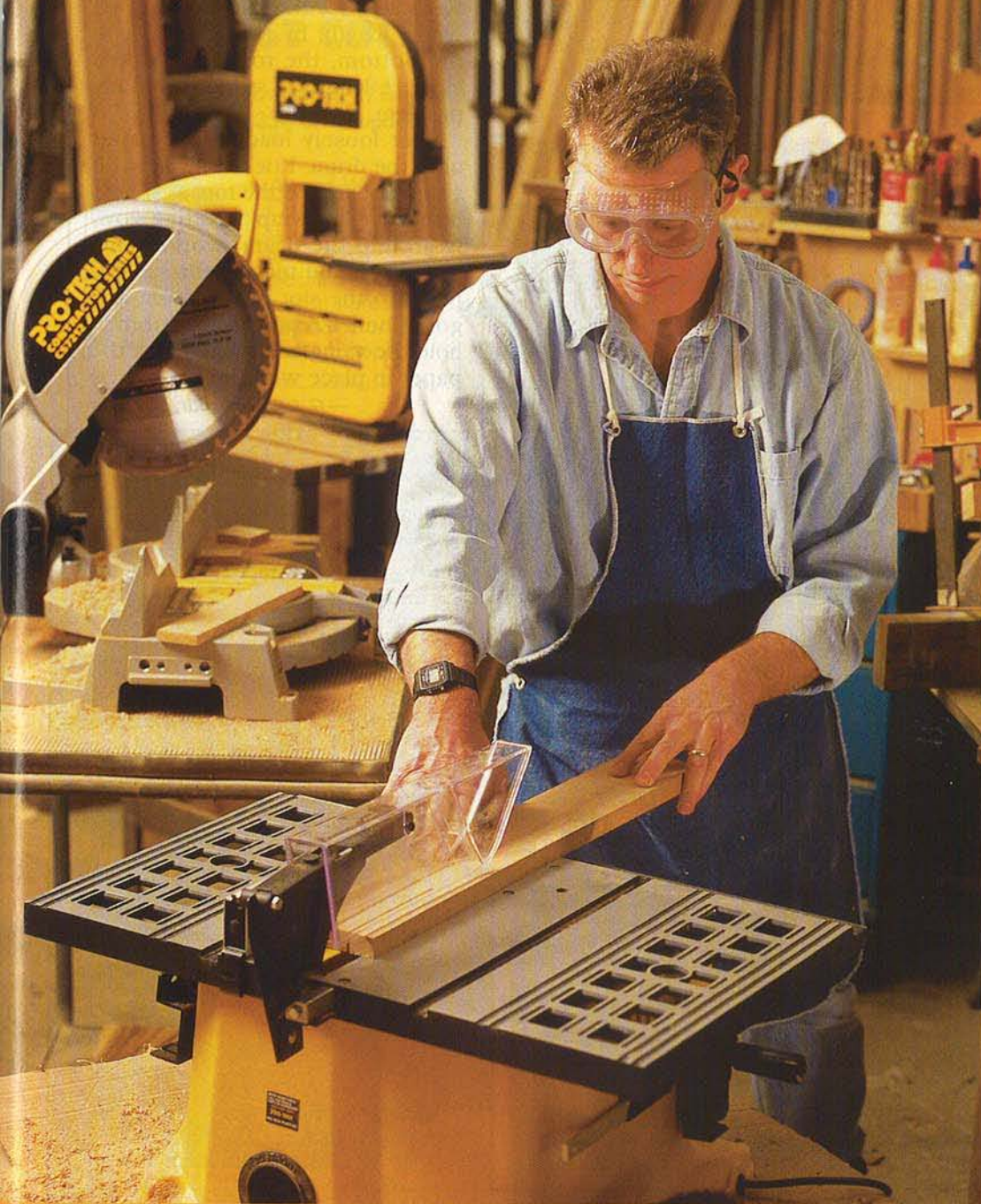

What woodworking projects are you not tackling because you can't afford the right power tools? The answer is none at all if you're already using products from Pro-Tech's value line of affordable, high-quality power tools. *For the nearest dealer or a free product catalog, call us at 800-888-6603.*

PRO-TECH

Building On Value™
Since 1985

Trips to the lumber yard will never be the same with the...



PACE EDWARDS ROLL-TOP-COVER™

This durable hard tonneau cover gives your truck added security with style and retracts in seconds to give you full use of your truck bed whenever additional space is needed.
Roll-Top...We've got you Covered!

www.pace-edwards.com
for more information call toll free 1 888 ROLL-TOP

Circle No. 1985

TIPS FROM YOUR SHOP (AND OURS)

Continued from page 22

String puts an end to sandpaper slippage

Loading fresh sandpaper onto my sanding drum (the type that takes sandpaper sheets) used to make me crazy. I couldn't keep the paper tight against the drum along its whole length; by the time I got to the bottom, the top had worked loose. A length of string solved my problem.

After loosely loading the paper onto the drum, I tie the string with a slipknot around the top, as shown below. Next, I wrap the string slowly around the drum, working my way down and tucking the sandpaper into the slot in the drum as I go. When I reach the bottom, I hold the string taut while I lock the paper in place with the key.

—G. J. Warmbrodt, St. Louis

"JUST A CUT ABOVE THE REST!"



Copyright-1998 rbindustries. All rights reserved

CALL 1-800-487-2623 FOR YOUR FREE FACT KIT TODAY!

rbindustries, inc.

America's Woodworking Machinery Manufacturer

1801 Vine Street • Harrisonville, MO 64701

H108

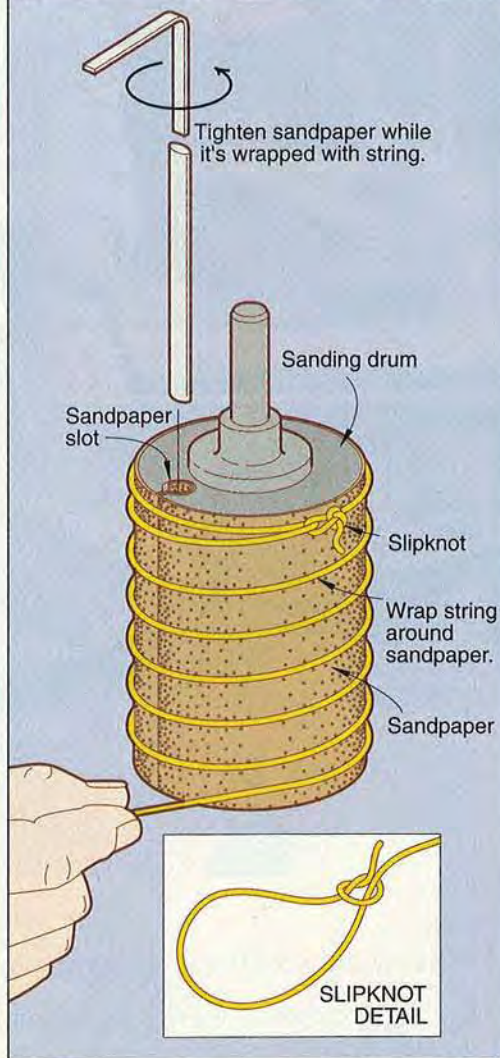

Continued on page 26

Visit the RBI Home page at
www.rbiwoodtools.com

Top Rated PSI Dust Collection Systems ON SALE NOW!

THIS ONE-TIME ONLY SUPER DUST COLLECTOR SALE ENDS ON JANUARY 30, 1999



SUPER DC250 DUST COLLECTOR

- Powerful 2-1/2 hp motor
- 1350 CFM capacity

Award Winner!*
Our most powerful system is perfect for multiple machine and long runs. It's great for any home or commercial shop!

FREE!
50' HOSE
\$40 Value

With 5 Micron Super High Filtration Bags!

Was \$354.95 • Save \$20
NOW ONLY
\$334⁹⁵ FOB PHILA.

THESE MODELS INCLUDE:

5 MICRON COLLECTION BAGS

Captures the finest sawdust. 6 times better filtration than the bags sold with our competitor's collectors.

FLEXIBLE COLLECTION HOSE

Strong, flexible and durable. Reinforced with .050 wire- no grounding required!

DC3-5 PORTABLE DUST COLLECTOR-AIR HANDLER

- 1-1/2 hp motor • 750 CFM



Penn State Industries

FREE!
8' HOSE
\$12 Value

With 5 Micron Super High Filtration Bags!

Was \$214.95 • Save \$10
NOW ONLY
\$204⁹⁵ UPS \$21

Award Winner!* Compact, powerful, and portable, this lightweight 50 lb. unit can be moved to the job or mounted as an air handler!



DC1B-5 DUST COLLECTOR

- Efficient 1 hp motor
- 700 CFM capacity

Award Winner!*
Our most popular system connects to almost any machine! The "Y" outlet allows two 4" connections.

FREE!
8' HOSE
\$12 Value

With 5 Micron Super High Filtration Bags!

Was \$219.95 • Save \$10
NOW ONLY
\$209⁹⁵ UPS \$29



DC2-5 DUST COLLECTOR

- Powerful 110V 1-1/2 hp motor
- 900 CFM capacity

Provides nearly the same performance as units with 2 hp and up. Suitable for long runs of hose.

FREE!
50' HOSE
\$40 Value

With 5 Micron Super High Filtration Bags!

Was \$309.95 • Save \$10
NOW ONLY
\$299⁹⁵ UPS \$40



COMPLETE CYCLONIC DUST COLLECTION SYSTEMS

We've combined the motor blowers from our award winning collectors with our super efficient cyclone to create two outstanding collection systems!

With 5 Micron Super High Filtration Bags!

HOME SHOP SUPER SYSTEM

- 1-1/2 HP Motor
- 750 CFM
- 90 lbs • 88" high

ITEM #CYDC3
FOR ONLY
\$499⁹⁵ UPS \$40

PROFESSIONAL SUPER SYSTEM

- 2-1/2 HP Motor
- 1350 CFM
- 140 lbs • 92" high

ITEM #CYDC250
FOR ONLY
\$599⁹⁵ FOB PHILA.

AIR CLEANING SYSTEMS

Clean the air you breathe!

Removes sawdust, dry-wall dust and more! The features of these lightweight, galvanized steel units were highest rated by Wood Magazine. The two filter system removes dust and impurities with a 12" x 24" washable pre-filter, and a High Efficiency internal bag filter. Requires no outside venting. 110V motor.



For shop size:
20' x 20' x 8'
#AC465/465 CFM
SALE PRICE
\$239⁰⁰ UPS \$14

For shop size:
20' x 42' x 8'
#AC930/930 CFM
SALE PRICE
\$339⁰⁰ UPS \$20



CALL, WRITE, OR VISIT OUR WEB SITE FOR A FREE CATALOG!

Penn State Industries
Order Toll Free
1-800-377-7297

2850 Comly Road, Philadelphia, PA 19154 • www.pennstateind.com



VISIT US ON THE WEB!

Start Your Own Business CUSTOM ENGRAVING

No Experience Necessary • No Artistic Ability Needed

• 400,000 RPM
Engraving Tool

• Unlimited
Potential

• Complete
Stencils



There is no experience necessary because SCM has developed a business opportunity that will have you producing professional engraving in a few short hours – just by tracing lines! *It's That Easy!*

Engrave on... • Glass • Wood • Metal • Stone • Marble • Eggs

To Find Out
Just How Easy It Is
Call Now For Details...

1-800-755-0261



W140 N5946 Lilly Road • Menomonee Falls, WI 53051 (414) 252-3989

Circle No. 2165

Great Clamps – Low Prices

Clamps From Garrett Wade

These are German made with the expected high quality design and workmanship – and at less than \$4.50 each, they are a phenomenal value.

Light, strong and easy to use (throat depth 2½") with vinyl capped swivel ends and wooden handles. It's terrific to have a bunch around the shop. The Clamp size (listed below) is the maximum opening.

We cannot recommend these enough. Ten of each saves you considerably. Real value doesn't come any better than this.

Regular Sale

37F02.10 4" Cab. Clamp(10) \$59.95 **\$42.50**
37F02.20 8" Cab. Clamp(10) \$65.95 **\$46.75**
37F02.30 12" Cab. Clamp(10) \$71.95 **\$49.95**

Combo. Set consists of 10 of each of the 3 sizes of clamps. 30 Clamps total- only \$4.40 each.

37F20.10 Combo. Set \$197.85 **\$132.25**

Garrett Wade

161 6th Avenue
New York, NY 10013

Shipping Charges

Sets of 10 are \$6.95
Sets of 30 are \$9.95



FREE GARRETT WADE CATALOG

Our high quality Woodworking Catalog has thousands of tools to choose from. Visit our web site at www.garrettwade.com or call us at the numbers below.

CALL TOLL-FREE 800-221-2942 or fax 800-566-9525

Circle No. 44

TIPS FROM YOUR SHOP (AND OURS)

Continued from page 24

Nifty pipe coupler for 4" PVC dust collector

It's not uncommon to see 4" PVC drain-waste-vent (DWV) pipe used in a shop for dust collection—it's inexpensive and seals airtight. But, a normal DWV coupler makes a poor joint with the flexible 4" dust hose from your machinery.

To make my own coupler, I took a short scrap piece of DWV and cut a ⅝"-wide slot down the side, as shown *below*. I squeezed the piece—closing the slot—and slipped it into the dust-collection pipe, leaving just enough to attach the flexible hose on the other end.

When I released the piece, it flexed out and held fast inside the DWV. I slipped the flexible hose over my new coupler (sanding a bevel on the outside edge makes the job easier) and fastened it with a hose clamp for an airtight fit.

—Jim Downing, Design Editor,
WOOD® magazine

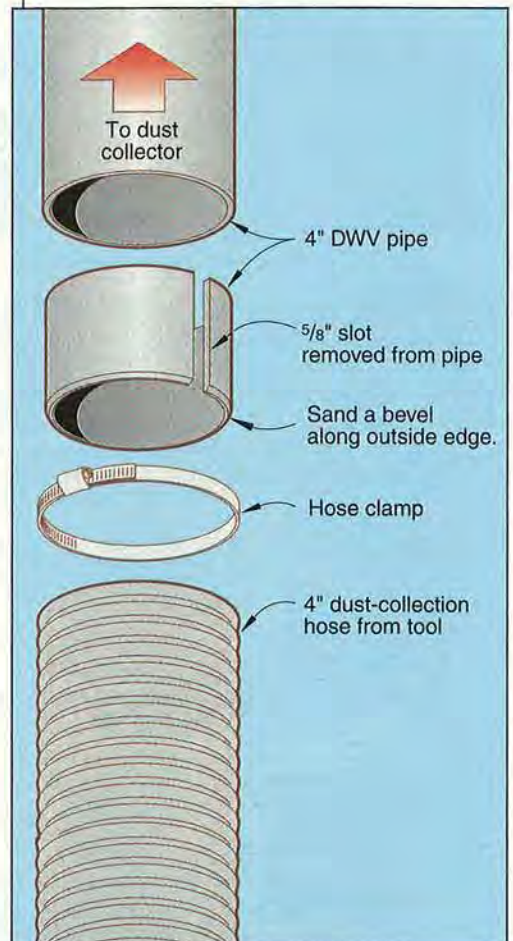

A gripping idea for drawing diagonals

When drawing diagonal lines on a small piece of wood, or lines on the end of a turning square, it's hard to hold the stock steady. I've found that a cabinet scraper works well. There's enough tooth on the side of the scraper to grip the wood and hold it until you draw the lines.

—Redmond Blair, Burnaby, B.C.

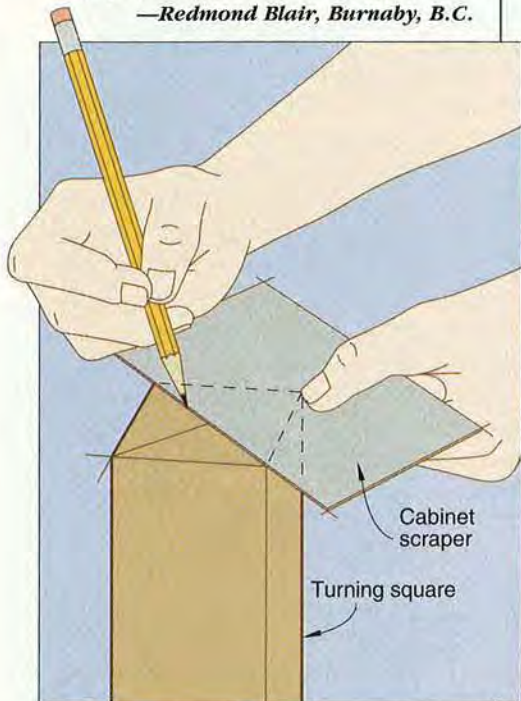

A FEW MORE TIPS FROM OUR WOODWORKING PROS

- Not happy with the results you're getting from your dado set? We uncovered many of the reasons a set may not be cutting up to par. See our review of premium dado sets beginning on *page 58*.
- Instead of boring and chiseling mortises, and sawing tenons for furniture joints, you can form them as you glue up parts. See how we used this technique in making the nightstand on *page 52*.
- You can "turn" simple round parts with abrasives and your drill press. See *pages 74-77* for details. ♣

STEVE WALL LUMBER CO.

Quality Hardwoods and Woodworking machinery For The Craftsman and Educational Institutions

Ash	4/4	Select	2.25		\$ 75.00
Basswood	4/4	Select	1.95		\$ 61.00
Birch	4/4	Select	2.40		\$ 79.00
Butternut	4/4	1C	2.00		\$ 67.00
Cherry	4/4	Select	3.75		\$ 96.00
Hickory - Pecan	4/4	Select	2.00		\$ 69.00
Mahogany (Genuine)	4/4	Select	3.70		\$ 96.00
Maple (Hard)	4/4	Select	2.80		\$ 83.00
Maple (Soft)	4/4	Select	2.20		\$ 70.00
Poplar	4/4	Select	1.55		\$ 62.00
Red Oak	4/4	Select	2.40		\$ 78.00
Walnut	4/4	Select	3.35		\$ 93.00
White Oak	4/4	Select	2.40		\$ 77.00
Cedar (Aromatic Red)	4/4	1C+Btr.	1.65		\$ 64.00
Cypress	4/4	Cypress	2.25		\$ 72.00
White Pine	4/4	F.G.	1.15		\$ 53.00
Yellow Pine	4/4	Clear	1.80		\$ 63.00

Above prices are for 100' quantities of kilndried rough lumber sold by the Bd. Ft. FOB Mayodan, NC. Call for quantity discounts. Other sizes and grades available.

Above prices are 20 bd. ft. bundles of clear kilndried lumber 3"-10" wide • 3'-7' long (Random widths & lengths) Surfaced 2 sides or rough. Delivered UPS prepaid in the Continental U.S.

Circle No. 592

NOW AVAILABLE

Thin Craft Wood

1/4" • 3/8" • 1/2"

Sizes Available

4/4 Log Run
Walnut
100 bd. ft. \$145

Also Available
Exotic Lumber

STEVE H. WALL LUMBER CO.

BOX 287
MAYODAN, N.C. 27027
336-427-0637
1-800-633-4062
FAX 336-427-7588

Email: wallwood@netmcr.com
Website: www.walllumber.com

Send \$1.00 For Lumber Catalog
Prices Subject to Change Without Notice



High Performance
Solid State Circuitry
Trigger Safety Lock

Flush Front Gets
into Tight Corners

10 Foot Cord

All-Steel
Channel & Track

High Carbon Heat-
Treated Working Parts

Patented Jam-
Proof Mechanism

One Year Limited
Contractor's Warranty

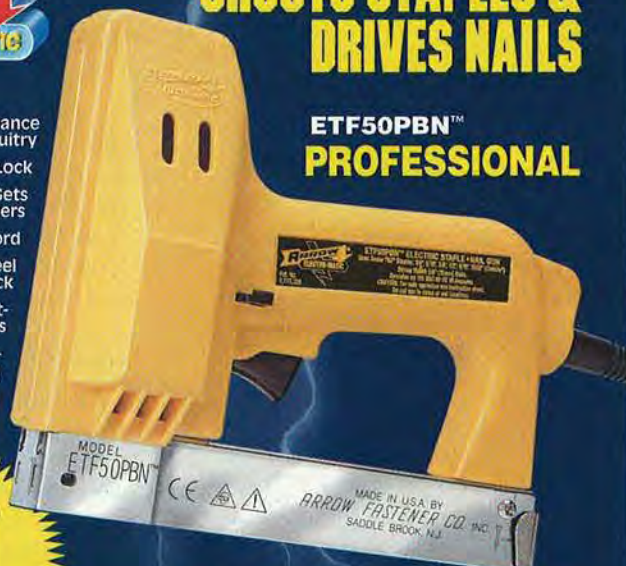

SHOOTS STAPLES & DRIVES NAILS

ETF50PBN™ PROFESSIONAL

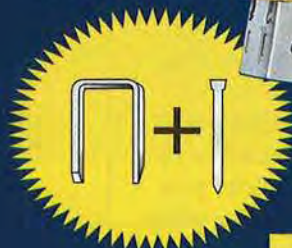

NEW

ELECTRIC POWER PLANT

The powerful ETF50PBN Electric Staple and Nail Gun shoots 6 different size staples: 1/4", 5/16", 3/8", 1/2", 17/32" Ceiltile and 9/16". It also drives a 5/8" nail.

One heavy duty versatile tool lets you do thousands of jobs from installing insulation and carpeting to trimming a door or building a toy.

The dual purpose Professional ETF50PBN is available wherever fine tools are sold.

MADE IN
USA
HECHO EN E.U.A.

UL
LISTED

SAF



ARROW FASTENER COMPANY, INC., 271 MAYHILL STREET, SADDLE BROOK, N.J. 07663
ARROW FASTENER (U.K.) LTD., 14 BARCLAY ROAD, CROYDON, SURREY CR0 1JN
JARDEL DISTRIBUTORS, INC., 6505 METROPOLITAN BLVD. EAST, MONTREAL, QUEBEC H1P 1X9
website: www.arrow-fastener.com

How to flatten bubbled veneer

I recently obtained an antique gaming table. The mahogany veneer that covers the top is in good shape, except for a bubble in one spot. Is there a way to repair this without replacing or refinishing the veneer?

—Charles R. Wanager, Decatur, Ill.

Most bubbles in veneer happen when heat and moisture penetrate the veneer and dissolve the old animal hide glue. Once the glue dissolves, the veneer swells and lifts, causing a bubble.

What you want to do, Chuck, is reactivate the glue (if there's enough under there) and then clamp the veneer flat. Sometimes, you can apply a moist towel with a hot iron to reactivate the glue, but if there's finish on the table, moisture probably won't be able to penetrate. In this case, you need to get the water under the surface. To do this, make a $\frac{1}{8}$ "-long cut at the base of the bubble with a razor blade. Now, use a glue syringe to squeeze a few drops of water into the bubble, and apply a hair dryer or hot iron over a protective cloth to heat up the old glue so it can mix with the new

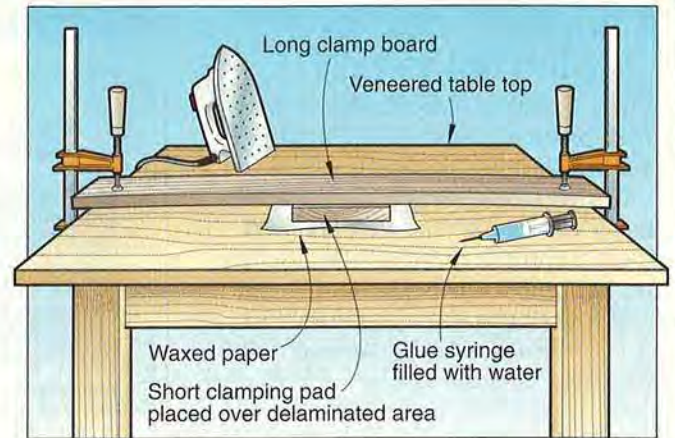

water. Be sure to check the surface often. Too much direct heat can blister the finish.

Once the glue softens, quickly press the bubble flat. Clamping in the middle of a table can be awkward. Try putting a short board directly on the bubble. Then, lay a long board over the top and clamp it to the ends of the table as shown *above*. After the glue has had time to cool and set, check to see if the bubble stays flat. If it doesn't, chances are there wasn't enough glue in there to begin with. Use your syringe again to insert new glue, and then clamp once more.

Estimating board feet on the stump

How do you calculate the number of board feet in a standing tree? Is there a formula or method used for this purpose?

—Hollis Gilbert, Herndon, Ky.

In the woods, Hollis, lumbermen use a scaling stick and some trigonometry to calculate the number of board feet in a tree. Without a scaling stick, you can come close by following this procedure and the chart at *right*.

First, estimate the usable height. Do this by marking your height on the trunk. Then, back off about fifty paces from the tree, and imagine how many times you can multiply your height up to the first defect, fork, or place where the trunk narrows to less than 10" in diameter.

Next, figure the trunk's circumference. To do this, measure the distance around the tree, at chest

Circumference at breast height (inches)	Merchantable height (feet)					
	8	16	24	32	54	40
Yield in board feet						
57	72	122	168	207	292	248
63	90	156	212	262	366	317
69	111	194	262	328	450	392
75	137	236	319	400	550	470
82	165	281	381	480	650	565
88	195	331	450	560	760	670
94	227	383	520	650	890	770
101	260	440	600	740	1,020	890
107	294	500	680	840	1,160	1,010
113	330	565	770	960	1,310	1,140

height, with a steel tape. Now that you know the height and circumference, simply use the chart *above* to find the board footage.

Have a question for our woodworking experts?

No matter how simple or perplexing your woodworking problem, we would love to hear from you. We'll do our level best to publish answers to the questions that

interest the greatest number of our readers.

You can write to us at: Ask WOOD®, 1716 Locust Street, GA310, Des Moines, IA 50309-3023.

Or, have your questions answered by fellow woodworkers. Just join one of our internet discussion groups at: <http://woodmagazine.com>

Continued on page 30



Okay, Maybe We Don't Supply *Everything* You'll Need In Your Shop.

But with over 7,000 of the finest woodworking tools and supplies from around the world, no one can cover more of your woodworking needs than Woodcraft.

No matter how you like to shop, Woodcraft is there!

- Stores nationwide.
- A FREE 168 page catalog.
- A website with on-line catalog - www.woodcraft.com

For the store nearest you or for a free catalog call: 1-800-542-9115



WOODCRAFT
Helping You Make Wood Work™



Proud sponsor of "The American Woodshop" hosted by Scott Phillips on PBS.

For maximum safety and comfort Woodcraft recommends that you always wear pants and shoes in your shop.

Circle No. 955

Dept. C98W11P

WOOD TOYS



- ★ EXECUTIVE TOYS
- ★ CONSTRUCTION EQUIP.
- ★ TRAINS
- ★ CARS & TRUCKS



- ★ PATTERNS
- ★ PARTS
- ★ WHEELS, ETC



TOYS and JOYS, Box 628 W, Lynden, WA 98264

Circle No. 465

ASK WOOD

Continued from page 28

Keeping glue lines, in line

For many years I've had a persistent problem with gluing pieces of wood together. Even months after adhering, hard lines of glue emerge at many of the joints. It doesn't seem to matter what types of glue or finish I use in attempts to fix this problem, but I've noticed this doesn't happen when I build with exotic woods such as cocobolo and purple heart. I've had to refinish several projects because of the glue lines. Can you help?

—Kenneth Mussen, Glendora, Calif.

Ken, we suspect that the blame lies within the wood you're using. Most lumber is kiln-dried to about 8 percent moisture content. Then it's shipped all over the country. Places like Southern California have dryer air than the wood is acclimated to. So, you get this lumber, build something, and the wood continues to dry for several months. Finishes only slow the inevitable. As the wood dries, it shrinks. However, once glue sets up, it's stable—it doesn't shrink along with the wood. So, when the wood around the glue becomes smaller, the glue line sticks out. The exotic woods you mentioned are more stable because they're resinous and don't continually dry out.

The solution to your problem is to buy your wood well before you use it. Stack the boards as shown *below* with stickers (thin spacers) between them for about six months so they can get used to your dry desert air.

Woodshop Solutions.

FACTORY SAVINGS UP TO 60%

100% USEABLE SPACE!

Now is the time to build the workshop of your dreams. Get the protection and work space you need with an affordable SteelMaster Building – the strongest, most flexible clearspan protective shelter money can buy. Expertly crafted and easily assembled for years of maintenance-free enjoyment.

HUGE FACTORY DISCOUNTS GOING ON NOW!

STEEL BUILDINGS



FREE SUBSCRIPTION

9 FREE ISSUES

of BETTER HOMES & GARDENS

WOOD

with your purchase.



RESIDENTIAL & COMMERCIAL USE

SAVE ON SELECT SIZES

25x24 • 30x46
40x56 • 50x116

- FREE Storage
- Immediate Delivery
- 100% financing available
- Heavy Wind & Snow Loads
- FREE State Certified Blueprints
- Superb Quality - 20 Year Guarantee
- Easy do-it-yourself construction



Call Toll Free: 1-800-888-4606

STEELMASTER. for a FREE COLOR CATALOGUE

Circle No. 2030

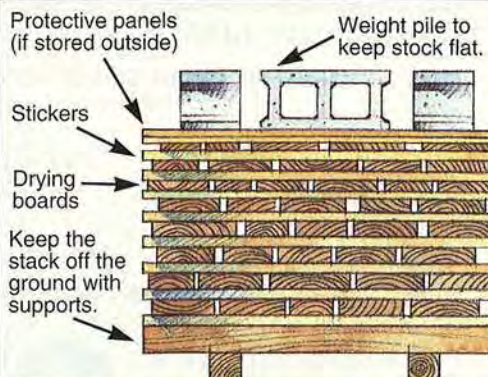

How does a cyclone work?

I'm a beginning woodworker starting to set up my shop. Issue #100 of WOOD® magazine just came in time as I have been thinking about which type of dust collector to buy. I'm intrigued by your cyclone dust collector (pages 54-61), but just don't understand how the dust in the cyclone falls into the trash can and doesn't get sucked up into the center tube. Can you explain this to me?

—Nick Danke, St. Louis

Without getting into complex physics, Nick, here's the short answer. Due to the placement of the inlet pipe, the air and debris enter the cylinder in such a way that they swirl around the inside. Centrifugal force spins shavings and dust particles out against the side of the cyclone. There, friction slows the air. Since the ability of an airstream to suspend particles is dependent on speed, this slower layer of air lets the particles drop down into the trash can. The outlet is situated in the center of the cylinder, away from the sides where all the particles are, so it exhausts mostly clean air.

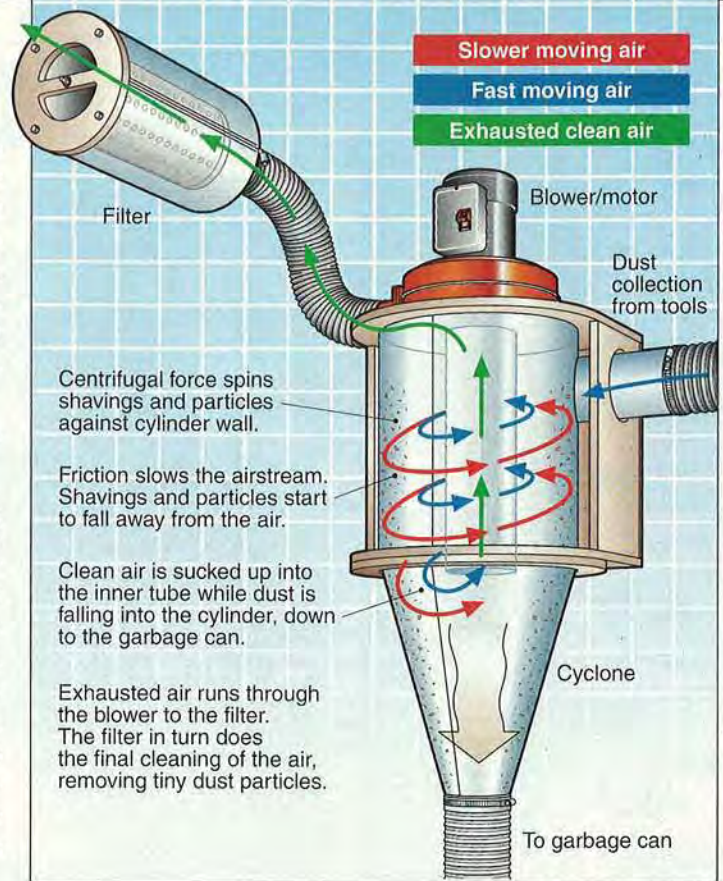

Continued on page 32

TOOL TALES No. 3

[REAL STORIES OF LEATHERMAN® TOOLS AND THE PEOPLE WHO USE THEM.]



THE TRUCK DIED ON THE RHINO TRAIL. AAA WAS PROBABLY OUT OF THE QUESTION.

I was in Rwanda, Africa, providing health care to refugees. A beat-up '68 truck was our only transportation. And my Leatherman Tool was our only tool. It helped us do everything from replacing battery cables to tearing apart brakes. Overall the Leatherman tool was tough as a war hog tank and much more versatile.

Sincerely,
Rene Anne Pizzo,
Oregon City, Oregon



PST II

NEEDLENOSE PLIERS
HARD WIRE CUTTERS
STRAIGHT / SERRATED KNIFE
DIAMOND-COATED FILE WITH SHARPENING GROOVE
CROSS-CUT FILE
8" / 20cm RULER
CAN/BOTTLE OPENER
THREE FLAT SCREWDRIVERS
PHILLIPS SCREWDRIVER
SCISSORS
25 YEAR WARRANTY

Perfect for travels in Africa, or less exotic continents.

Leatherman® makes the original go-anywhere, do-anything tool. We don't know when you will need it. But you will need it. P.O. Box 20595 Portland, Oregon 97294. (800)-762-3611 <http://www.leatherman.com>

LEATHERMAN® [ONE TOOL. A COUPLE THOUSAND USES.]

BINKS

HVLP Spray Gun

Use with only 1-1/2 H.P. compressor! Now you don't have to rely on a limited turbine. Great for a wide range of materials. Includes gun and one quart cup, 25 ft. 3/8" air hose with connection and air regulator with gauge.

#BK5 98-1121

CALL FOR SPECIAL PRICE!



PORTER-CABLE

18-Gauge Brad Nailer Kit

18 ga., 2" brad nailer kit accepts 3/4" - 2" brad nails. Quick-release nosepiece so you can quickly clear jams without disassembly.

#PCT BN200 List Price \$248.00

SUPER SALE \$131.50



DELTA

12-1/2" Planer

Features: •Quick change knife system •Exclusive cutterhead-snipe control lock •Easy-to-read English and Metric scale.

#DEL 22-560 List Price \$568.00 **SALE.....\$378.90**

BONUS: Free Extra Set of Planer Knives (\$27.90 value)



BOSCH

1613EVS 2HP Plunge Router \$188.00

1615EVS 3" HP Plunge Router \$299.00

1276DVS 4x24 Variable Speed Belt Sander \$218.00

3315K 12V Cordless Drill Kit w/ Case & 2 Batteries \$159.00

3615K 14.4V Cordless Drill Kit w/ 2 batt., case & charger \$173.90

3107DVS 5" H.D. R/O Sander-Polisher \$94.60

3725DVS 6" H.D. R/O Sander-Polisher \$131.00

3915 10" Slide Compound Miter Saw \$335.00

NEW! 1295DH 5" Swift Sand R/O Palm Sander \$86.50



PORTER-CABLE

NEW! 557 Plate Joiner Kit

•Does mini size biscuits & standard size 7/8 amp motor. •Tilt-fence does not have to be removed for flush cuts. •7-position depth stop •Fence lets you position your cut from outside face •Includes case, dust bag, 2" & 4" blades & extra biscuits.

SUPER SALE \$197.90



DELTA

30" Fence CTE 2731 \$23.90

52" Fence CTE 2747 \$28.90

Uni-Saws With Biesemeyer or Uni-fence

NEW! 36-800 White Classic Edition Uni-saw w/50" Biesemeyer Fence \$1599.00*

36-830 3HP, w/30" Uni-fence \$1399.00*

36-831 3HP, w/30" Biesemeyer T-Square Fence \$1399.00*

36-820 3HP, w/52" Uni-fence (Special Edition)..... \$1499.00*

36-821 3HP, w/50" Biesemeyer 52" T-Square Fence \$1499.00*

34-445Z Contractors Saw w/30" Uni-fence and \$200 in accessories FREE \$785.00*

34-182 Tenoning Jig \$86.90

11-990 5SP Drill Press \$192.00

*** Price After Delta Rebate**

RYOBI

RYB WDS1600P 16/32" Drum Sander with FREE stand (\$85.00 value) only \$568.90

RYB DB150 Detail Biscuit Joiner \$68.90



PORTER-CABLE

Brad, Finish & Framing Nailer Kits

All kits include case

NEW! CDA250 15G Cordless Angle Finish Nailer \$277.00

BN125 18G "1-1/2" Brad \$89.00

NEW! CF14001 HP Compressor w/ FREE air hose & couplers (\$21.30 value) \$199.50

DA250A 15G 1-1/2" Finish \$234.90

FN 250A 16G 1-1/2" Finish \$183.00

NS150 18G 1-1/2" Crown Stapler \$168.00

FR350 Full Round Head 2"-3-1/2" Framing Nailer Kit \$287.00

FR350 Full Round Head 2"-3-1/2" Framing Nailer Kit \$287.00

14-650P 1 H.P. Hollow Chisel Mortiser with FREE 1/4" & 3/8" Genuine DELTA Mortiser Bits (\$87 value)..... \$274.95

50-840 1 HP 650 CFM Dust Collector \$222.00

50-850 1 HP 1200 CFM Dust Collector \$328.90

50-851 2 HP 1200 CFM Dust Collector \$492.00

36-865 Versa-Feeder \$239.00

22-675Y 15" Planer with FREE 50-655 sand (a \$260.55 value) \$1135.00*

28-275 14" Open Band-Saw \$497.90

28-280 14" Enclosed Band Saw 1 HP \$679.00

28-280Z 14" Closed B/S w/\$225 accys FREE.....\$779.00*

SENCO

NEW! 910001N 58- 1 1/2" Brad Nailer w/case \$99.75

NEW! 920001N 58- 2" Brad Nailer w/case \$134.50

NEW! 900001N 1/2- 1" (1/4" crown) Stapler \$119.90

NEW! 950001N 1/2- 1 1/2" (1/4" crown) Stapler \$144.50

SLP20 Brad Nailer \$208.95

SFN1+ 1-2" Finish Gun \$292.95

SFN401-2" Finish Gun w/case \$348.90

SKS Med. Duty Stapler \$248.00

NEW! PPO600 Framing Nailer \$358.90

SCN40R Roofing Nailer \$387.90

SN60 Full Round Head Nailer \$388.90

PC0701 A9 Palm Nailer.....\$159.00



690 1" HP Router \$142.00

691 1 1/2" HP HDL Router \$159.00

7539 3" HP Plunge Router - Plus Free Fine Depth Adjuster (\$26.50 Value) \$294.90

7518 3" HP SSP FB Router \$279.90

693 Plunge Base Router \$178.00

693 Plunge Base Only \$82.00

6911 D-Handle Base Only \$72.00

42000 8 pc. Template Guide Kit \$29.95

97310 Laminate Trim Kit \$192.50

697 Router Table w/ 1 1/2" H.P. Router \$233.00

698 Router Table w/out motor \$133.50

9862F 12V Cordless Drill Kit w/ Free Flashlight.....\$158.90

9872 14.4V Cordless Drill Kit w/ two batteries, case & charger \$182.00

31-780P Oscillating Spindle Sander Bonus Buy: Includes Sanding Spindle Set (\$65.70 Value).....\$217.95

31-780 Osc. Spindle Sander \$192.50

36-235 12" Compound Miter Saw \$308.00

40-650 Q-3 18" Scroll Saw \$398.90

37-190 6" Deluxe Joiner \$429.00

37-350A 8" Joiner w/stand \$1337.90*

43-379 Special Edition Shaper \$1335.00

43-505 Router/Shaper \$299.95

50-345 Universal Mobile Base \$48.40

31-280 Sanding Center \$749.00*

STANLEY BOSTITCH

RN45B-1 1/2-1 1/2" Coil Roofing Nailer \$367.90

N805B-1 2"-3 1/2" Framing Stick Nailer \$348.00



ITW DeWalt

The top name in spray finishing is ready for your woodworking needs.

FLG-622-322 HVLP Suction Gun \$159.95

FLG-311-318 HVLP Gravity Gun \$169.95

9444 Sander Kit \$103.50

330 Speed Block Sander \$68.00

332 5" QS Palm Sander \$59.90

333 5" QS R/O Dst Sdr H&L \$64.90

334 5" QS R/O Dustless Sdr \$64.90

352VS VS Belt Sander \$177.00

7335 5" VS R/O Sander \$132.00

97355 5" VS R/O Sander with Dust Collection & Case \$149.00

552 Prod. Pocket Cutter \$589.90

7800 Drywall Sander \$348.80

5554 1000 Pc. Asst. Biscuits \$22.50

BIESEMEYER

78-900 50" Right 12" Left Fence System \$339.00

FEIN

FEIN Turbo II - Dust Free Vacuum

Powered by 2-stage motor w/ bypass control to assure motor runs cool even if the hose or filter is blocked. Excellent Quality!

FIN 9-55-13 \$247.95



QUICK-GRIP

AMT 53006 4-1/2" Micro \$7.50

AMT 00506 6" Bar Clamp \$12.95

AMT 00512 12" Bar Clamp \$15.45

AMT 00518 18" Bar Clamp \$16.70

AMT 00524 24" Bar Clamp \$17.95

AMT 00536 36" Bar Clamp \$20.55

AMT 550 50" Bar Clamp \$24.65



JDS COMPANY

JDS 350 550 CFM Filtration System.....\$259.00

JDS 8-12 1570 CFM Filtration System \$488.00

DEWALT

DW733 12 1/2" Planer \$419.95

DW788 Scroll Saw with FREE stand (a \$79 value) \$448.00

DW 682K Biscuit Joiner with FREE 100 Biscuits (8 value) \$188.00

DW621 2 HP VS Router \$197.50

DW625 3 HP Router \$275.00

DW421 Sander \$69.95

DW 423 5" EVS R/O Sander w/H&L & Dust Collector \$78.45

DW 708 12" Compound Sliding Miter Saw \$644.00

DW 991KS-2 14.4V Combo Drill & Saw Kit w/case \$337.90

DW 995KS-2 18V Combo Drill & Saw Kit w/case \$377.00

DW 321K 5.8A Jig Saw Kit \$162.00

DW972K-2P 12V Cds. Drill w/2 Batt. & FREE flashlight \$188.95

DW991K-2P 14V Cds. Drill w/2 Batt. & FREE flashlight \$208.95

DAREX

DRILL DOCTOR

Sharpen drills almost as easily you sharpen pencils

#2-1/2" & #1-1/4" Chucks

#DRX 750SP \$155.90

#2-1/2" Chuck #DRX 500SP \$119.95



Trakita

LS1211 12" Compound Miter Saw \$658.90

3901 Plate Joiner w/ Free 100 Biscuits (\$8 Value) \$205.00

3612C 3HP Plunge Router with Brake.....\$258.90

9820-2 Blade Sharpener \$224.00

GEO600 Die Grinder \$85.95

6222DWLE 9.6V Crdis Drill, 2 Batt. & Flashlight \$117.95

6213DWAE 12V Cordless Drill Kit \$169.00

6233DWAE 14.4 Cordless Drill Kit \$183.00



Milwaukee

MLW 6496-6 10" Slide Compound Saw with FREE Deluxe Folding Stand \$564.50

MLW 6266-6 Orbit Action Jig Saw \$158.00

MLW 0234-6 1/2" Electric Magnum Drill \$133.00

MLW 0235-6 1/2" Electric Magnum Drill (Keyless) \$133.00

MLW 6546-6 Cds. Screwdriver Kit \$88.50



ASK WOOD

Continued from page 31

You, too, can rid your saw of rust

I've recently inherited a Montgomery Ward Power Kraft tablesaw from my grandfather. It runs great, but the table is covered with rust. Is there anything I can do to remove the rust? If so, how can I prevent the table from rusting again?

—Charles Walker, Delano, Calif.

Charles, we'll venture out on a limb here and say that you're not alone in your rusty dilemma. A tablesaw has many bare metal surfaces that see moisture, scratching, and hard use. Rust thrives in that environment.

Since they're made of the same material, we'd attack that rusty table-saw the same way a body man would rid a car of rust. Spread some paste auto-body rubbing compound around on the rusted surface with a rag. Don't be afraid to use a little elbow grease. As long as the rust is only on the surface, and hasn't begun eating through the metal yet, it'll begin to disappear. You may have to attack the metal with sandpaper or a grinder if more advanced rusting exists.

Use mineral spirits to wash the residue away. What's left is a fresh metal surface that's immediately vulnerable to new oxidation and rust. So, protect the table before rust gets a new foothold. Use several coats of ordinary paste car wax on bare metal surfaces. With wax, the wax's protection will fade away, so re-apply a fresh coat every couple of months.

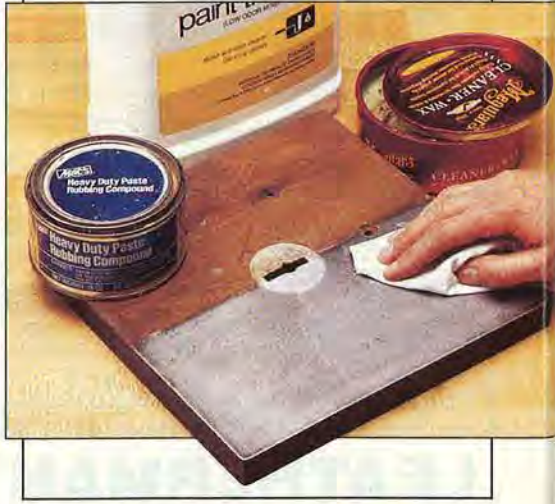

A&I Supply

Route 29 • N. Pekin, IL 61554

email: aisupply@mtco.com

FREE SHIPPING! 1-800-260-2647

(On orders over \$75 in the Cont. U.S.)

Ask For Our **FREE** 164-Page Catalog!

24 Hr. Fax Orders: (309) 382-1420

Limited Quantities & Prices Subject to Availability

Circle No. 1

VISA MasterCard DISCOVER AMERICAN EXPRESS

How to make a zero-clearance insert

While testing the premium dado sets reviewed on pages 58-63, we discovered that some sets will make clean, chip-free, cross-grain cuts in veneered materials only if you use them with a zero-clearance insert in your tablesaw. (You'll need a separate insert for each width of dado cut you make.)

You may be wondering how this handy gadget gets its name. Because you raise the running dado set through the insert to make its opening as shown at right, there's zero clearance between the sides of the set's outside teeth and the insert. The surface of the insert completely supports the veneer of the workpiece and prevents it from chipping as the teeth exit the cut.

To make one, use your saw's metal insert as a template. With double-face tape adhere the metal insert to a piece of plywood, hardboard, or any other stable material. Use either ¼" or ½" material—whichever is just slightly thinner than your metal insert. Saw just outside the plate and trim the wood insert to the exact shape of the metal insert with a flush-trim bit in



Hold the zero-clearance insert down with your tablesaw fence as you cut through the insert (but not your fence!).

your router table (see illustration below). Set the zero-clearance insert flush with your tablesaw top by applying small strips of tape to the underside of the insert where the tablesaw supports it. Hold the insert down with your tablesaw's fence and raise the running dado set through it. ♣

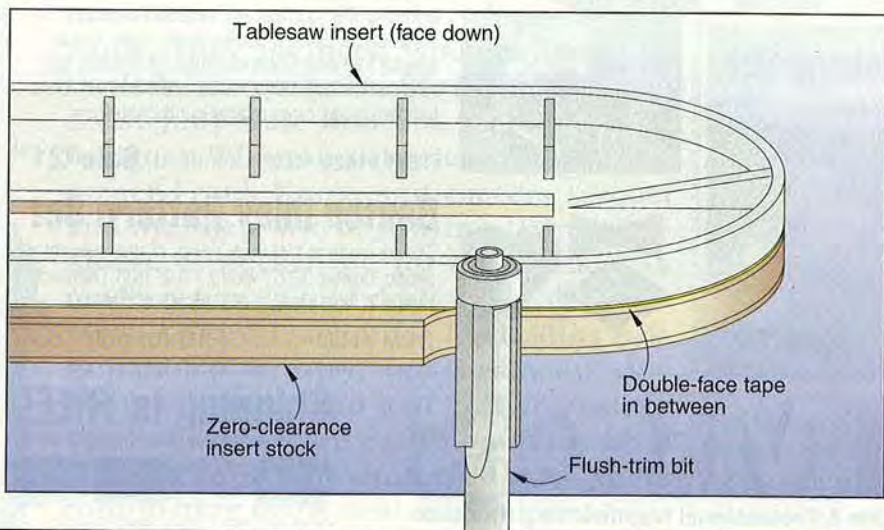

The
Professional's
Choice

for over 60 years

Titebond®
Original Wood Glue
• Dries strong
• Dries fast
• Dries clear

Tech Service
1-800-347-GLUE
Customer Service
1-800-669-4583

Make perfect Raised Panel Doors

with your 1/4" or 1/2" Router, or your 1/2" or 3/4" Shaper.

It's simple, inexpensive, and easy with professional production quality MLCS carbide tipped door sets! Our reversible combination bit makes a matching rail and stile frame. The panel raising bit with ball bearing guide makes a perfect raised panel every time!

Includes Instructions and Professional Tips!

Raised Panel Door Sets *Ball bearing included

SET #	BIT STYLE	LRG. DIA.	SET PRICE
#1301	1/4" Shank Router	*2"	\$69.95
#1302	1/2" Shank Router	* 3-1/2"	\$79.95
#1303	1/2" & 3/4" Shaper	4-5/8"	\$99.95

Raised Panel Door Instructional Video

#1438 Special Sale Price\$9.95



*Raised Panel Router Bit



*Reversible Combination Rail & Stile Bit
Works with stock from 11/16" to 7/8"



1/4" Shank Carbide Tipped Router Bits

Professional Production Quality Guaranteed!

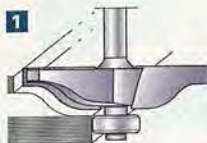

1 OEGE RAISED PANEL
#1423 2" Large Diameter\$29.95

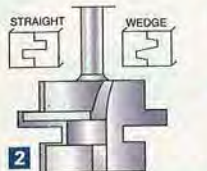

2 TONGUE AND GROOVE
#1333 Straight\$29.00
#1335 Wedge\$29.00



3 BULL NOSE
#1330 1/2" Dia. of Circle\$16.00
#1331 3/4" Dia. of Circle\$21.00

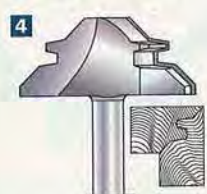

4 LOCK MITRE BIT
#1433
2" Dia., Stock thickness: 1/2"-3/4" ..\$37.50



5 RABBETING KIT
4 depth of cuts: 3/8", 7/16", 5/16", 1/4".
Set: 1/4" shank rabbeting bit, 4 bearings (3/8", 1/2", 5/8", 3/4") & hex key.
#1425 1-1/4" Large Diameter ..\$25.00



6 BRASS PILOTED
Rout into tight spaces and sharp corners. These bits have Brass Pilots, measuring only 5/32" in dia., instead of usual 1/2" bearing.
#1428 1/8" R Round Over\$16.00
#1429 1/4" R Round Over\$17.00
#1430 3/8" R Round Over\$19.00



7 SOLID CARBIDE UPCUT AND DOWNCUT SET
2 flute flat bottom cutters. Upcut spiral ideal for mortise and tenon joints. Downcut will plunge cut and plane edges.
#1437 1/4" dia., 3/4" cutting length
Special Set Price\$19.95

Round Over/Beading Bit Set

1/4" shank, Carbide Tipped, 4 Round Over Bits with 1/2" OD bearing: (1/8", 1/4", 3/8", 1/2"), plus 3/8" OD bearing & allen wrench.



ITEM #1434
\$72 Individually **Sale \$39.95**

Biscuit Joining Set

5/32" Slot Cutter-1/4" Shank and 250 #20 Biscuits

Instruction sheet included.



ITEM #1385
REG. \$35.00 **Sale \$29.95**



The Award Winning

MERLE ADJUSTABLE CORNER CLAMP

- Adjustable, uniform clamping pressure on all corners • Great for wide cabinet frames (for center or edges)
- Forces a frame into perfect square
- Almost NO capacity limitation, ships with 23 ft. reel of steel banding!
- Aluminum & Steel construction

ITEM #1420
REG. \$39.95 **Sale \$24.95**



The Can-Do Clamp

- Join picture and cabinet frames
 - Clamps to 2-34" wide
 - Easy Mounting • Use as bench vise
- Sturdy aluminum clamp is great for framing, drilling, doweling, and more.
- High clamping pressure
 - Movable jaws • Two swivel points

ITEM #1367 REG. \$29.95 **Sale \$24.95**

Solid Brass Router Inlay Kit

Makes perfect fitting recesses and inlays!

Easy to use inlay kit follows a 1/4" thick pattern template of almost any shape to produce the recess. Fits Porter Cable, Black & Decker or any router with an adaptor for Porter Cable bushings. Kit includes 1/8" solid carbide downcut spiral bit, brass bushing, brass template guide, brass retainer nut & instructions.

ITEM #1426 REG. \$35.95 **Sale \$21.95**

Router Inlay Pattern Set

They're made of 1/4" thick, tough, shatter resistant plastic. Bowtie: 3-1/2" wide x 1-1/2" high. Diamond: 5" wide x 3" high. Heart: 4-1/2" wide x 4" high.

ITEM #1436 **All 3 for only \$23.95**



Call us for your **FREE CATALOG**

Expert technical help before and after sale

©1998



Router Bits & Professional Woodworking Products

Circle No. 1350, 2250

ORDER TOLL FREE **1-800-533-9298**
24 HOURS A DAY!

Shipping is FREE!

*IN CONTIGUOUS USA FOR ALL ITEMS



Order By Credit Card or Send Check To:
MLCS, P.O. Box 4053DV, Rydal, PA 19046

www.mlcswoodworking.com

WOOD® magazine's

Woodworking Hall of Fame™

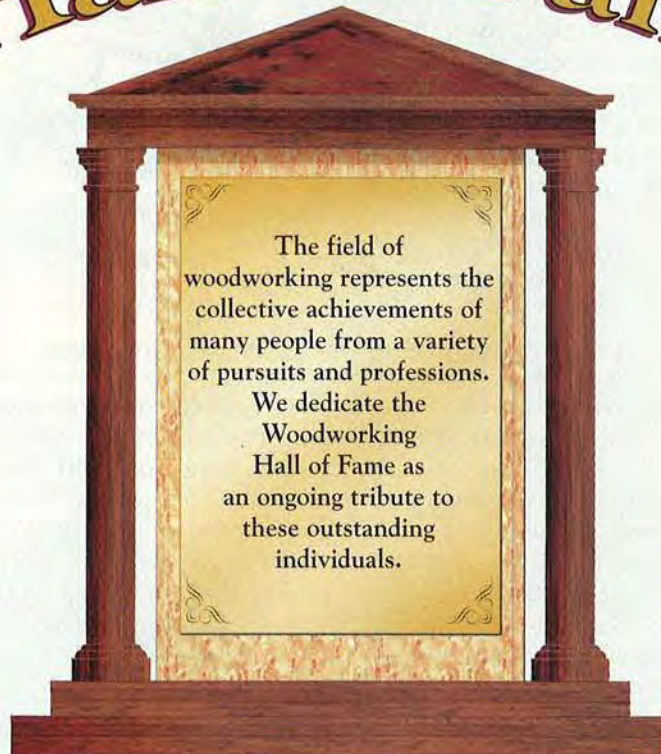

The field of
woodworking represents the
collective achievements of
many people from a variety
of pursuits and professions.
We dedicate the
Woodworking
Hall of Fame as
an ongoing tribute to
these outstanding
individuals.

Presenting the 1998 Inductees

In the November 1997 issue of **WOOD**® magazine we introduced the 10 inaugural members in our Woodworking Hall of Fame. They included woodturner Rude Osolnik, marqueterian Silas Kopf, intarsia artist Judy Gale Roberts, woodworking designer Wharton Esherick, ornamental turner Frank Knox, and carvers Lemuel and Stephen Ward. Joining them were Alonzo G. Decker, Jr., for achievement in modern power tool design and development, Gifford Pinchot for his leading role in national forestry, and Gustav Stickley for furniture design and craftsmanship. The inductees were each honored with a decorative plaque engraved with their contribution to the field of woodworking.

Samuel S. Maloof (1916-): For design and craftsmanship in furnituremaking



Without formal training, Sam Maloof began his woodworking building furniture for his parents in 1934. But his work was that of a graphic artist until 1948, when he received his first furniture commission. From that time on, the California craftsman has made his living by build-

ing furniture that some say has the spirit of Danish design. Maloof, though, believes that he simply creates furniture that people can be comfortable living with. He says, "If you're not preoccupied with

making an impact with your designs, something that looks good today will look good tomorrow.”

Maloof's pieces reflect this: symmetry, joints integrated with the lines, and oil finishes. His 1983 book, *Sam Maloof, Woodworker*, told of his work and philosophy. His furniture resides in the collections of the Smithsonian's Renwick Gallery, New York's Metropolitan Museum of Art, the Boston Museum of Fine Arts, the Los Angeles County Museum of Art, and others. Sam Maloof was the first woodworker elected a Fellow of the American Crafts Council. In 1987 he was honored with a MacArthur Foundation "Genius" grant. The Rhode Island School of Design awarded him an honorary doctorate in 1995.

Maloof still works 10 hours a day in his Alta Loma, California, studio and teaches a few semi-

nars a year. He says, "Each day is a renewal of my life. How good it is to be able to work at something that is so satisfying." Presently, Sam Maloof prepares for the first retrospective exhibit of his work to be held at the Smithsonian's Renwick Gallery in the year 2,000.

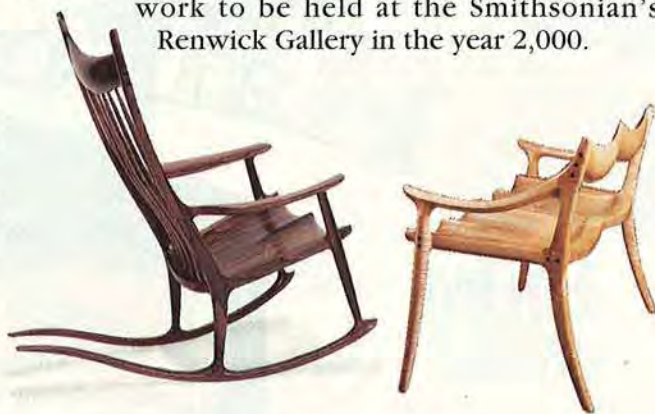

Norm Abram (1950-): For popularizing the woodworking craft



Learning much of his craft from his father, Norm Abram, of Milford, Massachusetts, was a building contractor when he left the trade in 1979 to appear with host Bob Vila on the Public Television series *This Old House*.

With Bob Vila's departure and Steve Thomas' arrival in the late 1980s, Abram was in place for his own show. *The New Yankee Workshop* was launched in 1988 by Boston's channel WGBH and now plays to nearly 300 stations and four million viewers each week.

With a friendly presentation, Norm Abram brings to his audience projects that he has adapted from popular styles in the United States and Europe. His straightforward approach that emphasizes

power tools and new gadgetry takes much mystery away from the craft. Over 10 years, he has taught how to build 124 classic projects that adhere to his tenets: "Integrity of craftsmanship, and a practical, artistic value." His name has become synonymous with woodworking, and he continues to be a beacon for those wishing to join the movement toward wood. ♣



How we choose our candidates

To be considered for induction into the Woodworking Hall of Fame, candidates must:

- Have made (need not be living) or be making a significant impact in the North American woodworking field through one (or more) of the following areas—design, craftsmanship, education, research, product development, and public service on a regional or national level.
- Have made or be making their contribution(s) in the 20th century.

A selection committee made up of *WOOD*® magazine staff members annually gathers the nominees received from our staff and readers and votes in the year's inductees. Names are announced in the October issue. To submit a candidate for nomination, send a short biography of the person along with a statement indicating his or her accomplishments to *WOOD* Magazine's Woodworking Hall of Fame, 1716 Locust St., GA310, Des Moines, IA 50309-3023.

You take care of the craftsmanship.
We'll deal with the blotching and lapping.



We're as passionate about wood as you are. Passionate about displaying its beauty and protecting it properly. And totally consumed with the notion of controlling color and consistency throughout your entire project. We concentrate on the finishing touches, so you can enjoy the process of creating.



Olympic® Interior Products are a group of professional quality stains and finishes that let you match what's in your mind's eye. We've engineered these stains with our exclusive *Absorption Control*™ formula, which allows you to achieve expected results without having to contend with

blotching, streaking or lap marks.

Top off your work with *Olympic*® Antique Oil Finish or your choice of Oil or Water Based Polyurethanes, engineered with our *Smooth Flow*™ formula, to provide maximum protection and durability. Call 1-800-441-9695 for a retailer near you.

OLYMPIC
INTERIOR PRODUCTS

Visit us at www.ppgaf.com.

GRIZZLY INDUSTRIAL, INC.™

PURVEYORS OF FINE MACHINERY



Z SERIES
COMBO SANDER
 6' x 48" BELT — 9" DISC

- Cast iron table, disc and body
- Quick belt-release mechanism
- Dual voltage motor pre-wired for 110V
- 3450 R.P.M., ¾ HP, 10/5 amps
- 2300 S.F.P.M. belt speed
- F. O. B. our warehouse

MODEL G1014Z
ONLY \$169⁹⁵

AN INCREDIBLE SELECTION OF SANDERS!



THOUSANDS OF SANDING BELTS, DISCS, SLEEVES AND SHEET STOCK!
 CALL FOR YOUR SPECIFIC SIZE

COMBINATION SANDER
 4' x 36" BELT — 6" DISC

- Quick-release lever for fast belt changing
- Quality ½ H.P. motor; 3450 RPM; 4 Amps
- Heavy-duty cast iron body
- Table tilts 45°
- 1½" dust port
- Machine weighs 46 lbs.

MODEL G1020
ONLY \$119⁰⁰



12" DISC SANDER

- 110V, ¾ H.P. TEFC motor
- Lg. 15½" x 8¼" extruded aluminum table
- Miter gauge fits in T-slot
- Table tilts from 0 - 45°
- Accepts 12" PSA discs
- 2½" dust port
- Shipping weight approx.: 65 lbs.
- F. O. B. our warehouse

MODEL G5499
ONLY \$199⁹⁵



COMBINATION SANDER
 1' x 42" BELT — 6" DISC

This versatile bench top sander is ideal for the small shop.

- ½ H.P. motor
- Belt sander pivots 90°
- Weighs approx: 30 lbs.

MODEL G3105
ONLY \$119⁹⁵



HEAVY-DUTY COMBINATION SANDERS
 6' x 48" BELT — 12" DISC

- Table size for belt: 7½" x 14½"
- Table size for disc: 7" x 16½"
- Approx. shipping weight: 155 lbs.
- F. O. B. our warehouse

MODEL G1183 ONLY \$399⁰⁰
 5,000 F.P.M. belt speed, 3450 RPM

MODEL G1276 ONLY \$439⁰⁰
 2,500 F.P.M. belt speed, 1725 RPM



4' X 24" OSCILLATING BELT SANDER

Get two sanders in one! Converts from an oscillating spindle sander to a non-oscillating spindle sander.

- Platen size: 6¼"
- ½ H.P. direct-drive motor
- 1½" dia. x 4¼" tall spindle
- Quick release lever
- Table tilts to 45°
- Shipping weight: 48 lbs.

MODEL G1173
ONLY \$179⁹⁵



OSCILLATING SPINDLE SANDER

- Built-in 4" dust collection port
- Cast iron 25" x 25" table tilts to 45° • Ten spindle sizes
- Heavy-duty 1 H.P. 110/220V TEFC motor
- 1720 R.P.M. spindle speed
- Spindle oscillates at 75 S.P.M.
- Stroke length: 1½"
- Shipping weight: 345 lbs.
- F. O. B. our warehouse

MODEL G1071
ONLY \$495⁰⁰



6" x 80" FLOOR MODEL EDGE SANDER

- 1½ H.P. TEFC motor
- 22" x 10½" cast iron table
- Belt speed: 1,800 F.P.M.
- 60° - 0° - 60° table tilt
- 90° belt tilt
- Graphite coated platen
- 110V/220V, 16/8 Amps
- Mechanical ON/OFF switch
- End table: 4" x 8" • 4" Dust Port
- Ship. wt: 252 lbs. • Platen: 6¼" x 29¼"
- F. O. B. our warehouse

MODEL G1140
ONLY \$450⁰⁰



KNIFE BELT SANDER / BUFFER

- 1 H.P. single phase motor; 110V
- Cast iron body
- All ball bearing construction
- Belt size: 2" x 72-80" range
- Belt speed: 3600 FPM
- Auxiliary arbor accepts buffing wheels, drum sanders or flap wheels
- Shipping weight: 115 lbs.
- F. O. B. our warehouse

MODEL G1015
~~WAS \$349⁰⁰~~
NOW \$295⁹⁵



24" DRUM SANDER

- 5 H.P. drum motor; 220V single-phase operation
- Handles lumber up to 23½" wide
- Chain driven conveyor feeds at 11 FPM
- Drums travel at 2400 surface FPM
- Work is held by three pressure rollers
- Shipping weight: 500 lbs.
- F. O. B. our warehouse

MODEL G1066
ONLY \$1095⁰⁰



Circle No. 860

CALL TODAY FOR YOUR FREE 1998 WOODWORKING CATALOG — ORDER 24 HOURS A DAY!

163198658

1 - 8 0 0 - 5 2 3 - 4 7 7 7

CUSTOMER SERVICE: (717)326-3806 FAX: (800)438-5901 WEBSITE: <http://www.grizzlyindustrial.com>

VISIT OUR 3 SHOWROOM LOCATIONS:

750
 MEDIA CODE

1821 Valencia St., Bellingham, WA — 4651 Hickory Hill Rd., Memphis, TN — 2406 Reach Road, Williamsport, PA





Fixing Up That Old Joint

A seasoned
pro's approach
to regluing

"You can't glue air. You have to build up the wood for a tight, surface-to-surface fit."

Bob Flexner



Old furniture's initial glue-up lasts only so long. Joints eventually give in to wood movement, hard use, and time, and you will have to reglue. To show you how a pro gets ailing furniture back on its feet, we dropped in on antique restorer and finishing expert Bob Flexner.

In his Norman, Oklahoma, shop, Bob Flexner has enjoyed restoring old furniture for more than 20 years because of the challenges involved in solving problems. And he gets really frustrated when he sees bad furniture repairs that only complicate already existing problems. "Bad repairs only serve to destroy a piece of furniture," he exclaims. "And there's only so much of this

fine furniture from the past around. If it's poorly repaired, it's only a matter of time before the repairs break down. Then the furniture follows, and ends up in the landfill."

Bob divides furniture repair into two aspects: making parts and gluing. "But all of a craftsman's numerous woodworking skills come together in the gluing," he strongly believes. "If you can't glue the

Continued

Reglue That Old Joint

"White glue [or yellow glue] won't bond to hide glue—the joints first must be thoroughly cleaned."

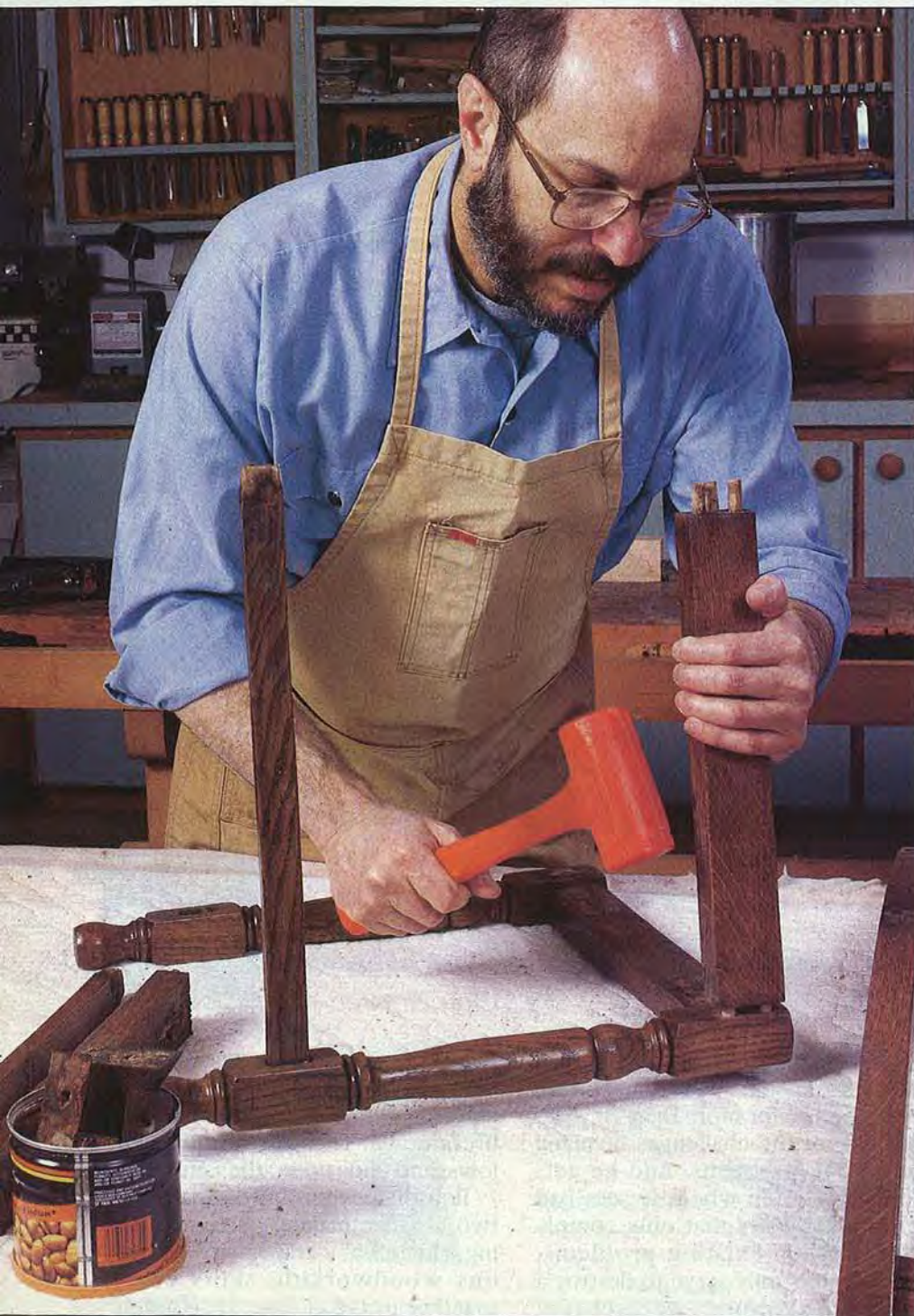

To protect the wood when knocking an old chair's joints loose, Bob Flexner relies on a dead-blow hammer and a cushioned tabletop. Solid hits make the job go quickly.

piece to make it structurally strong, it won't last, no matter how well you're able to reproduce parts. To me, there are two parameters to remember for repairing with white and yellow glues: clean wood, and tight, wood-to-wood contact."

To demonstrate the right way to reglue, Bob salvaged a pair of turn-of-the-century oak straight-backed chairs from a local used furniture shop. "They're wobbly because the joints have failed over time," he notes. "You can expect the same from any type of furniture in which traditional woodworking glues—hide glue, white glue, or yellow glue—have been used. Yet, if you heed the following steps, your repairs will keep that furniture around another 100 years."

How to put the hits on old furniture

Because white and yellow woodworker's glues weren't developed until World War II, furniture made prior to that date was built with hide glue and comes apart rather easily, according to Bob. For that task, his favorite tool is a shot-filled dead-blow hammer, since it doesn't mar the wood.

For knocking apart joints, Bob sets up the chair on a large table covered with a cushiony blanket—again to protect the wood, as shown *left*. It's as the disassembly begins that he often encounters poor repairs, such as nails driven into the joints, or metal brackets and other hardware. "Bad repairs like that often cause the wood to split," he points out.

"It's essential that you inspect the piece you're working on for metal, then remove it before you attempt a repair," he says. On this day, he finds no nails or other metal in the chair he's dismembering. However, had he discovered nails, for instance, Bob would gently work them out of the joint with electrician's sidecutters, doing as little damage to the wood as possible.

"Joints fail because of the natural shrinking and swelling of the wood during seasonal changes," he notes,

tapping a leg to loosen it from the stringer. "This puts stress on the glue and eventually causes it to break down." For the most part, the joints come easily apart with a few blows.

As he frees each piece of the chair, Bob places it in position on the blanketed table. "Keep the pieces in some sort of order so that you'll be able to put them back together right," he emphasizes. Continuing, he deftly works his way through the chair's subassemblies until he meets resistance.

"Because this chair was made with hide glue, I can simply undo this tough joint by injecting a little denatured alcohol into the joint with a syringe," he notes. "In a few seconds, the alcohol crystallizes the glue and I can break the bond. If the alcohol leaves a white mark on the finish, just remove it with fine steel wool dampened in linseed oil.

"If you come across white or yellow glue in the joints, you can still get them apart by injecting vinegar or warm water," Bob advises. "It takes minutes longer, but you'll be able to get them apart. Epoxied and superglued joints are another story—they're almost impossible to reverse—a reason you shouldn't use them in the first place. Acetone or lacquer thinner may work, but you're likely to damage the finish."

Clean wood bonds to clean wood only

The chair apart, Bob focuses on cleaning the joints, as in the photos *right*. This craftsman has racked up years of experience with hot hide glues. And because even old hide glue can be reactivated to bond with fresh-mixed, hot hide glue, that's his adhesive of choice for professional repairs (and to preserve antique value).

"To most of today's woodworkers, though, mixing, heating, and applying it isn't familiar. So I'll use

Continued



For a good bond, Bob uses a cabinet scraper to take off the aged hide glue from a square tenon.



Left: Regluing a chair with white or yellow glue requires cleaning out all the old glue from a mortise joint like this.

With a kitchen brush, the restorer works water into mortises and dowel holes to dissolve remaining hide glue.



" I use my hand plane to take off a thin shaving...then wrap the curl around the tenon, tearing off what I don't need for thickness."

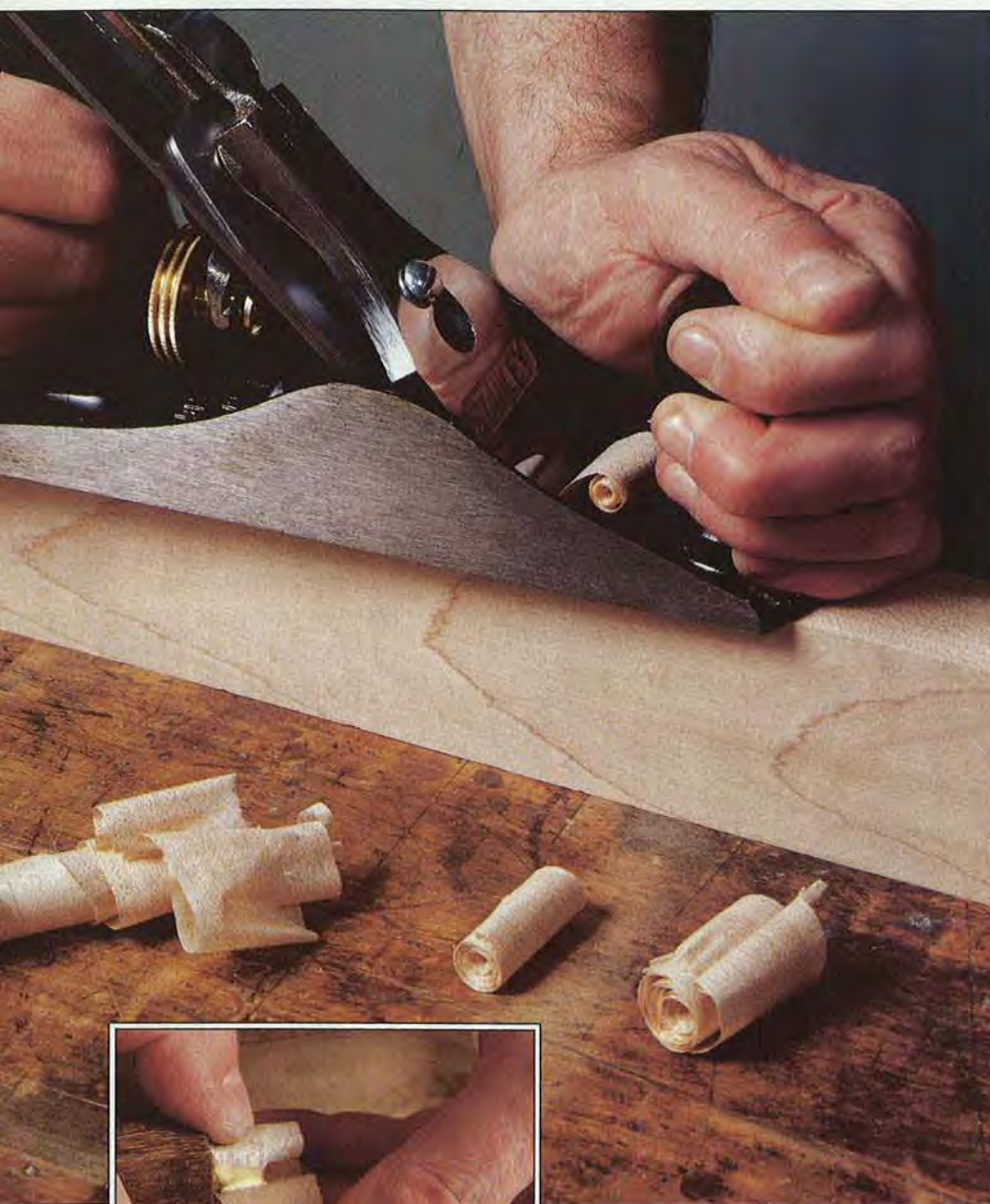

With a hand plane going with the grain, Bob shaves a tight curl of hard maple that he'll use to build up a worn round tenon.

Using yellow glue because of its greater tackiness, he attaches the curl of maple to the tenon, then rolls it to spread glue. Its shape holds it in place without a clamp.

white glue in this chair because of its longer open time," he says. "But because white glue [or yellow glue] won't bond to hide glue, the joints first must be thoroughly cleaned."

The cleanup becomes nearly effortless. First, the restorer scrapes away any old glue buildup on joint surfaces with a knife or cabinet scraper. Then, with a cloth dampened in warm water, he wipes the tenons and mortises. "When the surfaces become sticky, you'll know the glue is dissolving," Bob says. "For mortises and dowel holes, it helps to use a small kitchen brush or metal pan scrubber that fits into the hole to work the surfaces. When the glue is dissolved, you can feel the clean wood with your finger. Remember, though, that when the wood is finally clean, allow it to completely dry before beginning the regluing."

What to do when joints need restructuring

A not-uncommon problem Bob finds is worn joints, either from use, improper machining in the first place, or as the result of the cleaning operation. "Because you can't glue air, you have to build up the wood for a tight, surface-to-surface fit," he cautions.

To build up a square tenon, for example, Bob cuts a slightly oversize piece of veneer of appropriate species and thickness from sheet stock on hand. He makes sure that the veneer matches the grain direction of the tenon, then glues it in place. For an even bond, Bob clamps a small, flat piece of wood—with a barrier of waxed paper under it—to the tenon. A spring clamp holds the piece until the glue dries.

"Depending on how bad it's worn, I sometimes have to add a piece on both sides of the tenon," says Bob. "And I might have to build up the narrow top and bottom, too." After the built-up tenon has dried, he trims away any excess with a craft knife or sharp chisel.

You can build up round tenons, too, but with a little different

method. "With those, I clamp a maple board onto my workbench and use my hand plane to take off a thin shaving [as shown *opposite*]. I use maple because it holds together—the shaving won't split," he explains. "Next, I apply glue to the tenon—this time yellow glue because it gets tacky faster— then wrap the curl around the tenon, tearing off what I don't need for thickness. A little twist with my fingers spreads the glue. Its natural curl will keep it in place without using a clamp."

Bob has learned that even a little dried glue from his fingers may prevent a later bond. So he sands the built-up tenon after the curl has dried with 220-grit paper.

To rebuild a chair, reglue section to section

Ready to reglue, Bob gathers his materials: white glue, a small brush, pipe clamps with padded ends, and a damp cloth. The chair parts he so carefully arranged in the order of disassembly get more scrutiny. "To simplify the regluing, you should glue up one section of chair, then glue up another, and finally glue the sections together," Bob advises.

"To be sure everything aligns, you might want to dry-fit the pieces before you glue, especially noting the length of any dowels you've installed [See the companion article, "Dealing with Dowels", on page 110]. Then, sand down any oversize dowels or build up small ones like tenons."

Spreading glue from a wide-necked container with a brush instead of straight from the bottle goes faster and produces a more even coat, according to Bob. And he works swiftly doing that. First come the mortises or dowel holes ("You gain open time doing them first"). He's careful to coat just the sides and not fill the holes ("The tenons or dowels will spread the glue evenly"). After clamping, he wipes off any excess glue.

Bob can get by with only two pipe clamps. The reason? "The joints should be so tight-fitting that once



The curved backs of some chairs require a shop-made jig of scrap plywood to achieve parallel clamping when pulling the joints together in reassembly.

I've pulled them together, they'll stay, and I can remove the clamps to clamp up another section." He avoids juggling little pieces of scrapwood for pads and instead uses plastic pads fastened directly to the clamps.

"After I've pulled all the joints together with the clamps, I remove the clamps and check to see how the chair stands on my table," he says. "If it rocks a little, it means one of the legs is off. I can remedy that by reclamping that side at a slight angle to draw a leg up or down. At first, it takes some experimentation, but when you use white

glue, you have plenty of time to spare for adjustment."

For a chair with parallel lines, the clamping goes easy. But for a chair with nonparallel lines, like an Empire-style chair with its curved back, some problem-solving again enters the picture.

"I make clamping jigs from scrap plywood. One edge I saw out to profile the chair's curve, the other I leave straight [see photo *above*]," says Bob in describing his solution. "That gives me parallel clamping surfaces. And I've got quite a collection of them because few chairs are ever alike." ♣

Ready to learn more about furniture repair?

You can order Bob's 90-minute video *Repairing Furniture with Bob Flexner* by sending a check or money order for \$19.95 (U.S.

ppd.) to Bob Flexner, P.O. Box 214, Norman, OK 73070. It covers veneer repair and patching, fixing breaks, matching parts, and more.

Written by Peter J. Stephano Photographs: Bob Hawks Graphic design: Perry McFarlin

Box-Joint Jig

A
WOOD
MAGAZINE
EXCLUSIVE

I've always liked box joints, and here's why. They offer both strength and unique good looks. Although not as refined as dovetail joints, they can be cut on a tablesaw or router table using a simple shop-built jig. Not only that, but I can use a box-joint jig on virtually any width or thickness of stock. Our jig combines simplicity of construction with micro-adjustability. Interchangeable indexing pins allow you to cut box joints of any size without having to build a different jig each time.

Jan Hale Svec
Jan Hale Svec
Assistant Design Editor

View from
back side of jig



Let's start with the fence assembly

1 Cut the jig fence (A) to the size listed in the Bill of Materials and shown on the Parts View drawing on the top of *page 48*. (Due to its stability, strength, and lack of voids we used $\frac{3}{4}$ " [18mm actual] Baltic birch plywood.)

2 Mark the location, and cut the $\frac{3}{4} \times 3\frac{1}{2}$ " notch along the bottom of the fence (A) where dimensioned on the Parts View drawing. Then, mark the location, and cut the $1\frac{3}{4}$ " dado $\frac{1}{4}$ " deep in the front face of the fence.

3 Measure the exact thickness of your plywood, and cut a groove along the back side of the fence (A) where shown on the Parts View and Exploded View drawings. The groove should be as wide as your plywood is thick. And, the groove should be up from the bottom edge of your ply-

Box-Joint Jig

Bill of Materials

Part	Finished Size			Matl.	Qty.
	T	W	L		
A fence	3/4"	5 1/2"	26"	BP	1
B backing plates	1/4"	1 3/4"	5 1/2"	HB	4
C base	3/4"	5"	26"	BP	1
D support	3/4"	2 1/8"	26"	BP	1
E handle	3/4"	4"	4 5/8"	BP	1
F guide	3/4"	1 1/4"	10 1/2"	BP	1
G adjustment block	3/4"	2 1/2"	1 1/2"	BP	1
H index slide	3/4"	2 1/2"	8 1/4"	BP	1
I indexing blocks	3/4"	2 1/2"	5 3/4"	BP	4
J miter-gauge guides	3/8"	3/4"	10"	B	2

Materials Key: BP—birch plywood, HB—hardboard, B—birch

Supplies: #8x3/4" flathead wood screws, #8x1 1/4" flathead wood screws, 3/8" carriage bolt 3" long with a flat washer and plastic knob; 10-32 all-thread rod 4" long with two locknuts, two flat washers, 10-32 threaded insert, and mating knob; 3/8" carriage bolt 4 1/2" long with a flat washer and plastic knob; 10-24 flathead machine screw 1" long with mating flat washer and nut; key stock; clear finish.

BUYING GUIDE

Hardware kit. All the hardware listed in the Supplies listing above. WOOD KIT BJJ1, \$17.95 plus \$3.95 shipping. Schlabaugh and Sons Woodworking, 720 14th Street, Kalona, IA 52247 or call 800/346-9663 to order.

Easy-to-assemble kit. All the pieces listed in the hardware kit above, plus all the Baltic birch plywood and solid-birch pieces cut to the size listed in the Bill of Materials. WOOD KIT BJJ2, \$79.95, plus \$8.50 shipping. Schlabaugh and Sons Woodworking, 720 14th Street, Kalona, IA 52247 or call 800/346-9663 to order. Or e-mail at schsons@kctc.net

2 Mark the location and cut the 7/16" slot in the base where shown on the Parts View. Then, mark the centerpoint, and drill the 1 3/32" hole through the base.

3 Cut the base support (D) to size. Using the dimensions on the Parts View, locate the hole centerpoints, and drill the five counter-sunk holes in the support. With the back edges and ends flush, glue and screw D to C. Make sure the screwheads don't protrude below the support and scratch your table saw top later.

4 Glue the fence (A) to the front edge of the base (C), keeping the ends flush. Check that the fence is square to the base. This is important for accurate cuts later.

5 Transfer the full-size handle (E) pattern from the pattern insert to your stock, and cut the handle to shape. Rout 1/8" round-overs on the handle where noted on the Exploded View drawing. Drill a mounting hole through the bottom of the base (C), and glue and screw the handle to parts A and C.

For perfectly placed fingers, add the adjustment block

Note: The distance between the dado blade and the indexing pin has to be equal to the width of the slot the dado blade will cut. This will ensure that the fingers and notches are exactly the same size and that the mating pieces fit together correctly. The adjustment block assembly allows you to adjust the distance between the blade and indexing pin to achieve a perfect fit of the box joints.

1 Cut the adjustment block guide (F), adjustment block (G), and index slide (H) to size.

2 Cut the 1/2" notch in the adjustment block (G) where shown on the Parts View drawing. Then, drill a 7/32" hole through the center of the notch. Glue the block to the base (C), flush with the back face of the fence (A) and flush with the end of the base where shown on the pattern insert.

3 Drill the holes in the index slide (H) where shown on the

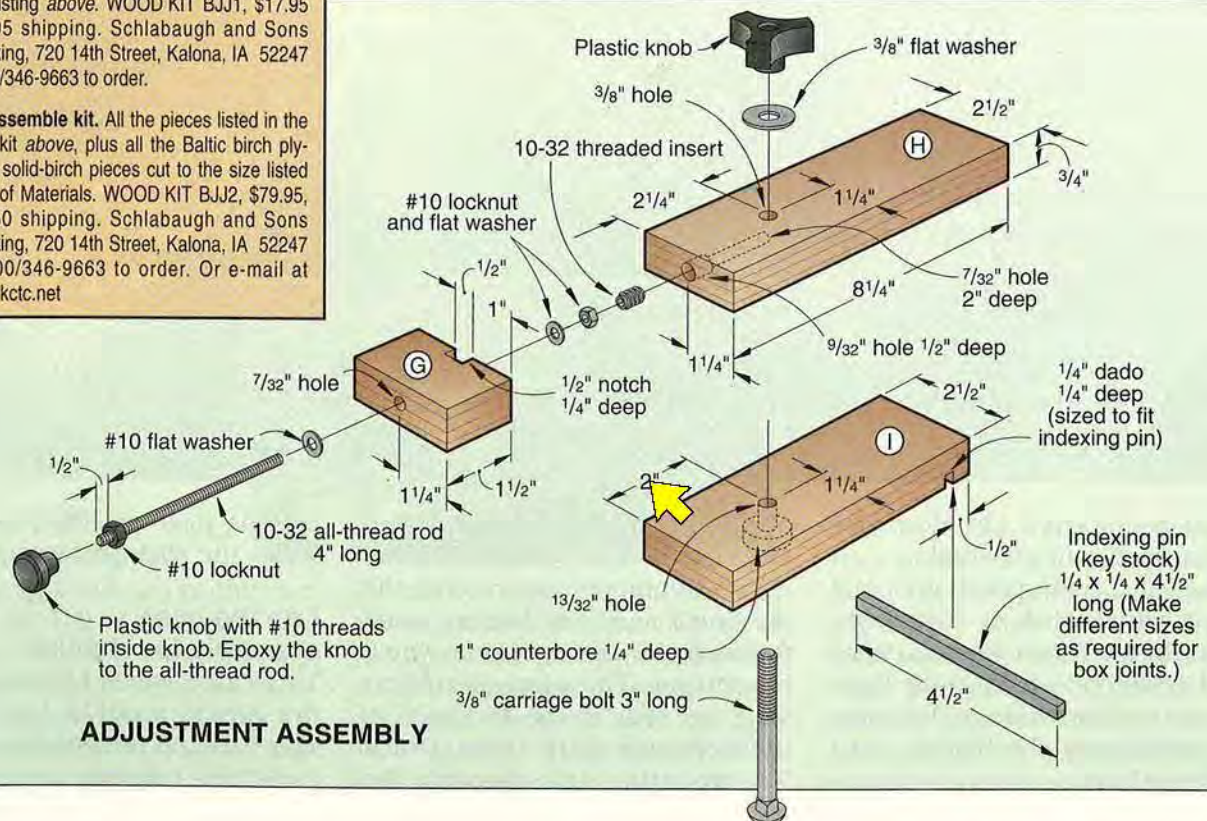

ADJUSTMENT ASSEMBLY

Adjustment Assembly drawing and pattern insert. Drive a 10-32 threaded insert into the $\frac{3}{32}$ " counterbore, centered in the end of the index slide.

4 Using the index slide (H) and adjustment block (G) as spacers, screw the adjustment block guide (F) in place. The index slide should slide between the guide and fence (A) without slop.

5 Secure the adjustment block (G) and index slide (H) together with a 10-32 all-thread rod 4" long, locknuts, washers, and a plastic knob in the configuration shown on the Adjustment Assembly and Parts View drawings.

Let's form the indexing blocks for different sized fingers

1 Cut the indexing blocks (I) to size. Cut extras depending on how many sizes of box joints you wish to cut. We recommend four ($\frac{1}{8}$ ", $\frac{1}{4}$ ", $\frac{1}{2}$ ", and $\frac{3}{4}$ "). Drill a $1\frac{13}{32}$ " hole with a 1" counterbore $\frac{1}{4}$ " deep on the bottom side of each block where located on the Adjustment Assembly drawing.

2 For a $\frac{1}{4}$ "-wide index pin, fit your tablesaw with a $\frac{1}{4}$ "-wide dado blade, and cut a $\frac{1}{4}$ " dado $\frac{1}{4}$ " deep located $\frac{1}{2}$ " in from the end of the index block. Be careful to keep

the dado perpendicular to the front edge of the indexing block. where shown on the Adjustment Assembly drawing.

3 From $\frac{1}{4}$ " key stock, crosscut an index bar $4\frac{1}{2}$ " long, and epoxy it into the $\frac{1}{4}$ "-wide dado, keeping the back end of the key stock flush with the back edge of the indexing block.

4 Repeat steps 2 and 3, keeping the dados $\frac{1}{2}$ " from the end for the other sizes of indexing pins. We used metal key stock (used to secure pulleys to spindles) for the $\frac{1}{8}$ " and $\frac{1}{4}$ " pins and Baltic birch plywood for the $\frac{1}{2}$ " and $\frac{3}{4}$ " pins.

5 Secure an indexing block (I) to the bottom side of the base with a 3"-long carriage bolt as shown on the Exploded View drawing. When the index blocks are not being used, you can secure them to the top side of the base where shown on the same drawing.

Attach the miter-gauge guides, and add the finish

1 Cut the miter-gauge guides (J) to size according to the width and depth of the miter-gauge slots in your tablesaw. The thickness should be $\frac{1}{16}$ " less than the depth of your miter-gauge slots. Test-fit the miter-gauge guides in the

miter-gauge slots so the top surface of each guide protrudes just above the surface of your tablesaw. Doing this keeps the bottom surface of the jig from rubbing on the tablesaw top.

2 Mark a line on each guide $2\frac{1}{4}$ " from the back end. Then, adhere a 5"-long piece of double-faced tape to each guide starting at the line just marked. See the Exploded View drawing for reference.

3 As shown in the drawing below, position the jig assembly onto the guides, being careful to keep the jig square to the blade. Press down firmly to adhere the tape-covered guides to the bottom of the jig assembly.

4 Turn the base assembly over, and drill and countersink six mounting holes through the guides and into the bottom of the jig base (C). Leaving the double-faced tape between the guides and base, screw the guides to the base bottom with #8 $\times\frac{3}{4}$ " flathead wood screws.

5 Remove the hardware, then finish-sand all the wood pieces. Apply a clear finish to the parts to seal the parts and keep them clean over time. Reattach the hardware and reassemble the jig.

6 If you used solid stock for the miter-gauge guides (J), apply a bit of paraffin to the sides and bottom of the two guides for easier sliding of the guides in the tablesaw miter-gauge grooves.

Continued

CUTTING DIAGRAM

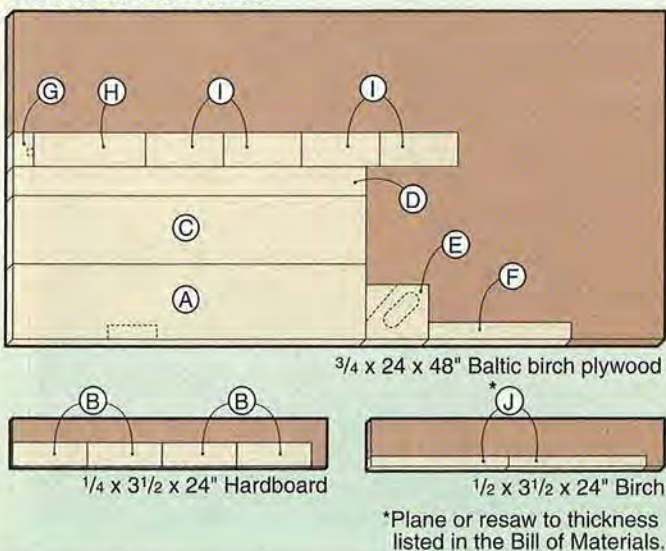

tablesaw slots. Then, using thin strips of plastic or wood, shim the guides in the

POSITIONING THE MITER-GAUGE GUIDES

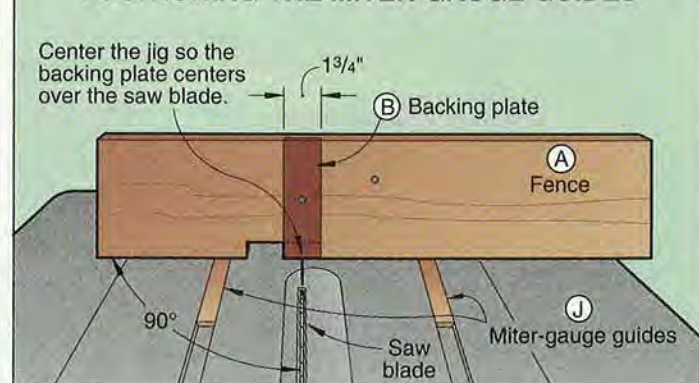

Box-Joint Jig

PARTS VIEW

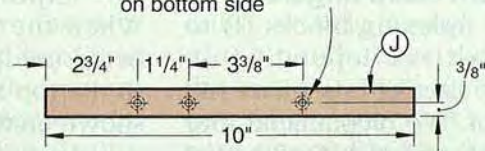
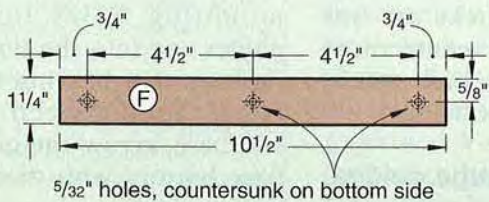
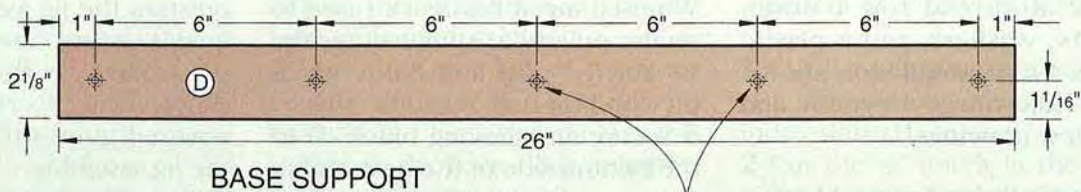
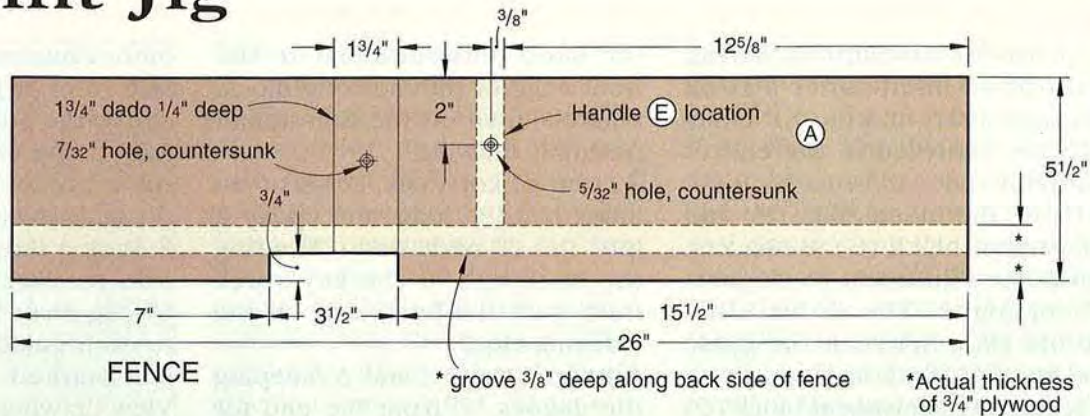

Note: Size width and thickness to fit miter-gauge slots on your tablesaw.

GUIDE

MITER-GAUGE GUIDE

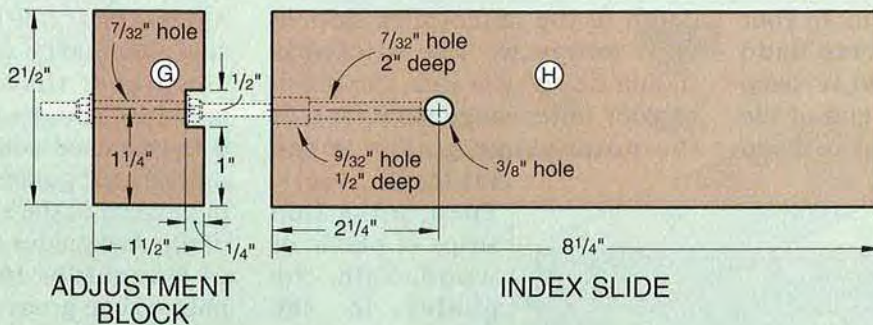

ADJUSTMENT BLOCK

INDEX SLIDE

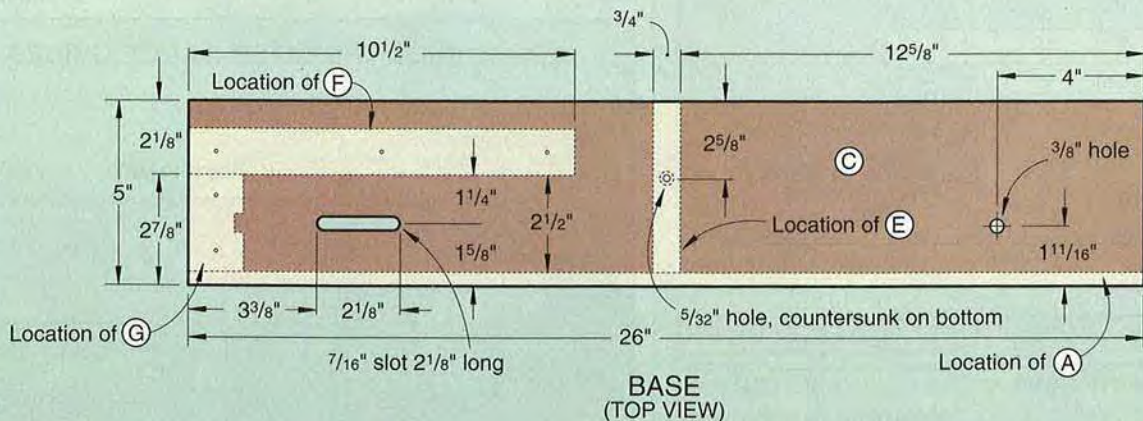



How to make your box-joint jig do its thing

Adjust or shim the dado blade to the same thickness as the wood being box-jointed. Raise the blade to the same height as the thickness of the material being cut *plus* 1/2". As shown in *photo A*, adjust the distance between the blade and indexing pin so the distance is equal to the width of the blade. It may be necessary to remove the backing plate (B), and notch it to get the pin close enough to the blade. As shown in *photo B*, slide your stock against the pin, and

make the first cut. Position the notch just cut onto the index pin, and make the second cut as shown in *photo C*. Repeat until the piece is completely cut across one end. For the mating piece, place the first test piece on the index pin so just one finger is on the blade side of the pin. Position the second piece firmly against the first piece, and make the cut as shown in *photo D*. Remove the first piece, and make the cuts along the end of the second piece.

Test-fit the two pieces together. Chances are you'll need to adjust the distance between the blade and pin. If the fit is too loose, turn the knob clockwise to increase the distance between the pin and blade. If the fit is too tight, turn the knob counterclockwise to decrease the distance.

Test-cut scrap material until the joints fit perfectly. With the index pin properly located, lock the index slide in place with the large plastic knob. ♣

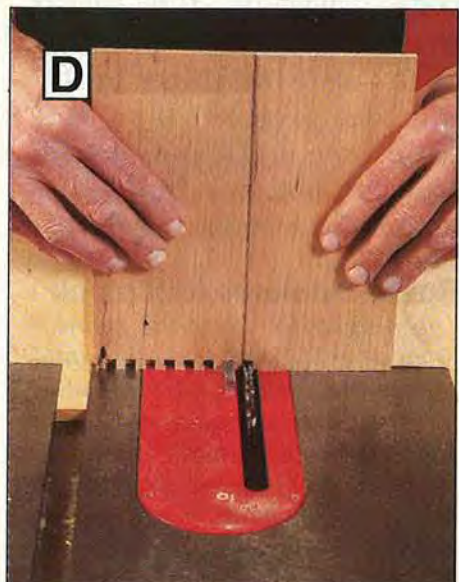
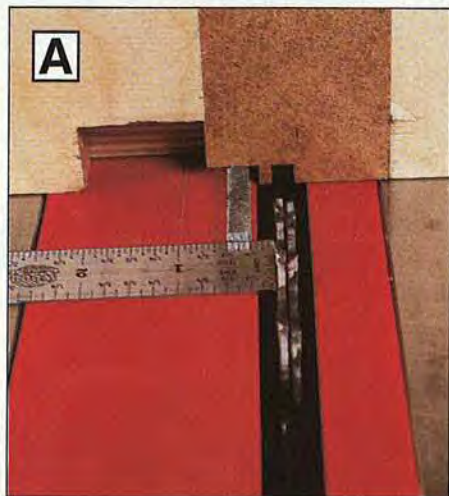

Produced by Marlen Kemmet Project Design: Jan Hale Svec; Gary Webster Illustrations: Kim Downing Photographs: John Hetherington

It's a Keeper



Do you keep back issues of **WOOD**® magazine for reference—and for those build-someday projects? If so, this handsome and handy magazine file box is a build-now (and build-a-bunch) project.

Rustle up some thin stock

The magazine file calls for 1/4"-thick stock 11 1/2" wide. You could construct the file of plywood. But if you want to use solid mahogany as we did, here's how.

1 Joint one edge of a 3/4×6×30" piece of mahogany. Resaw it into two 3/8"-thick pieces.

2 Edge-glue the two resulting pieces along the jointed edges,

both sawn surfaces facing up. (This is called *book-matching*.)

3 Plane the book-matched stock to 1/4" thick. Plane several pieces of scrapwood to the same thickness for setting up the box-joint jig later.

4 Rip the piece to 11 1/2". Refer to the Bill of Materials, and cut parts A, B, and C to finished length plus 1/16". (The extra length allows you to make the joint fingers 1/32" longer. You can then sand the joints flush after assembly.) Leave the parts overwidth at 11 1/2" for now. Mark a bottom edge on each piece.

Tackle the box joints next

1 Refer to the article beginning on page 44 for instructions on building and using our box-joint jig.

2 Install a 1/4" dado blade on your tablesaw. Adjust the saw's cutting depth to 3/32".

3 Install the jig's 1/4" indexing pin.

(If you're cutting the box joints with another type of jig, install it and set it up for 1/4" fingers 3/32" long, following applicable instructions.)

4 Saw fingers in two pieces of scrapwood, and test the joint for fit. Adjust and retest as necessary.

5 With the jig properly adjusted, saw fingers on both ends of parts A, B, and C, starting with a finger at the bottom of each side (A) and mating fingers on parts B and C.

6 Rip the sides (A) and back (B) to finished width, sawing the waste off the top edge. (For appearance, you could make the parts slightly

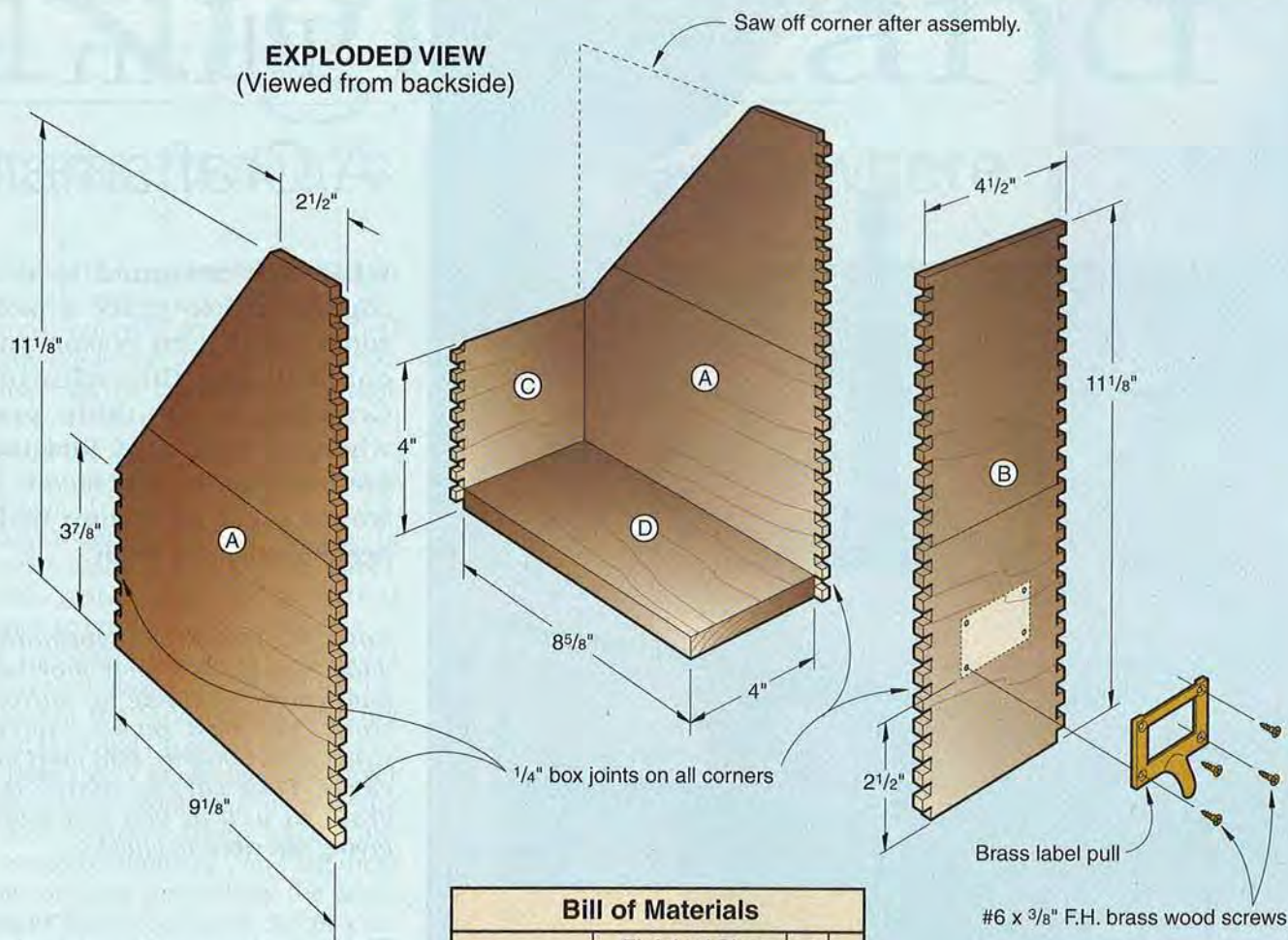

Part	Finished Size			Mati.	Qty.
	T	W	L		
A* side	1/4"	11 1/8"	9 1/8"	M	2
B* back	1/4"	11 1/8"	4 1/2"	M	1
C* front	1/4"	4"	4 1/2"	M	1
D bottom	1/2"	4"	8 5/8"	M	1

*Make oversize initially, then cut to finished size in accordance with how-to instructions.

Materials Key: M—mahogany

Supplies: Drawer pull with card holder, semigloss clear lacquer.

wider if necessary to avoid cutting through a finger.) Cut the front (C) to the same width as A and B, but not to the finished width shown. Sand the inside faces.

Build the box, cut a corner

1 From scrapwood, cut four clamping cauls, two that measure 3/4 x 7 3/4 x 11 1/4" and two that are 3/4 x 2 3/4 x 11 1/4".

2 Cut the bottom (D) to the dimensions shown in the Bill of Materials. Dry-assemble parts A, B, C, and D to check fit.

3 Apply white glue to the inside edges of each joint finger, using a small brush. (White glue's longer open time allows you to glue and assemble all the joints before it

starts to dry.) Apply glue along the edges and ends of the bottom.

4 Assemble the file box. Position the clamping cauls on the sides and ends, and clamp the assembly with band clamps. (We used three.) Ensure that the bottom is flush and the joints are tight. Clamp until the glue dries. Sand the joints flush.

5 Lay out the angled cutting line on one side of the file box. Bandsaw the angle, cutting with a fine-

toothed blade. (To minimize chip-out, apply wide masking tape along the cutting line on the inside of the side that will be up when you saw and the outside of the one that will be on the bottom.) Plane or sand the sawn edge smooth and straight.

6 Finish-sand the box, using progressively finer sandpaper from 150- to 320-grit. Sand slight round-overs on the opening's edges.

7 Apply a clear finish. (We sprayed on several coats of semigloss lacquer, sanding between coats.)

8 Attach a brass file handle where shown. Poke screw pilot holes with an awl. (We installed the 2 1/2 x 1 1/2" Large Card Holder with Pull, available for about \$6 from Woodcraft Supply, 800/225-1153.)



More Than a A Craftsman

While we designed it as a nightstand to grace a bedroom, there's no reason you couldn't put this winning Craftsman-style table anywhere in the house. Imagine, for instance, how perfectly it would serve as a lamp table beside your easy chair.

Note: We made the nightstand's wide panels with their mortises and tenons by gluing up narrow stock. For best results, select straight, flat boards, and joint the edges. Take care to match the grain as well as you can when laying out stock to glue up.

First, make a few fixtures

1 Referring to the Gluing Fixtures chart on the *opposite page* cut scrapwood to size for fixtures AA-EE. (We cut a piece of hardboard for AA, and made parts BB-EE from MDF.)

2 Saw notches in fixtures BB and CC as shown in the Gluing Fixtures drawing.

Glue up the sides

1 Rip and crosscut parts A and B to the sizes shown in the Bill of Materials on *page xx*.

2 Form the decorative cutouts in the meeting edge of each part A.

To do this, photocopy the Cutout Full-Size Pattern on *page xx*. Cut out the pattern copy to make a template. Position the template on the parts where indicated, and trace the cutout line. Saw the cutouts, using a bandsaw with a $\frac{1}{8}$ " blade, a scrollsaw, or a jigsaw.

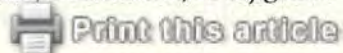

Nightstand

beauty that's at home anywhere

3 Glue the centers (A) and fillers (B) into two side panel center sections, referring to the Side Panels drawing in the *WOOD PATTERNS*® insert in the middle of the magazine. Both ends of each panel should be flush. Clamp.

4 Cut parts C-F to the sizes shown. To make parts D, E, and F, tape together four 30" lengths of 3/4x3/4" stock into a 3"-wide panel, and crosscut each set of parts at once to ensure identical lengths.

5 Dry-assemble the side panel outer sections from parts C-F, following the Side Panels drawing and the Glue-Up detail, *right*.

Here's how to assemble the outer sections in pairs, as shown in the photo *right*. Open three bar clamps to about 12", and lay them out on your bench. Lay the alignment board (AA) on them, centered between the jaws. Cover the board with waxed paper.

Separate the four taped-together parts D, E, and F into two taped-together pairs. Then, referring to the Side Panels drawing and the photograph, lay one part C, the paired parts D, E, and F, and another part C on the clamps. Slip the spacers (DD) into the mortises where shown. Place fixture BB on the top (tenon) end, and pull the parts tight with another clamp positioned lengthwise, as shown.

Ensure that all parts fit together snugly, then loosen the clamps. Apply glue to the *outside edges only* of the taped-together parts D, E, and F where they join the parts C. Clamp until dry, removing the glue from the tenon end of parts D, along with any squeeze-out.

6 Remove the tape to separate the two side outer sections (C/D/E/F assembly). Dry-assemble the outer

Continued

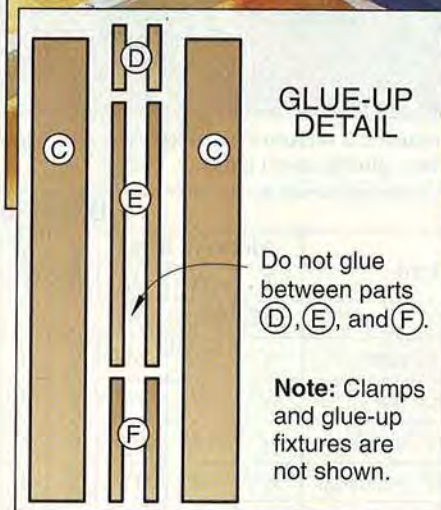
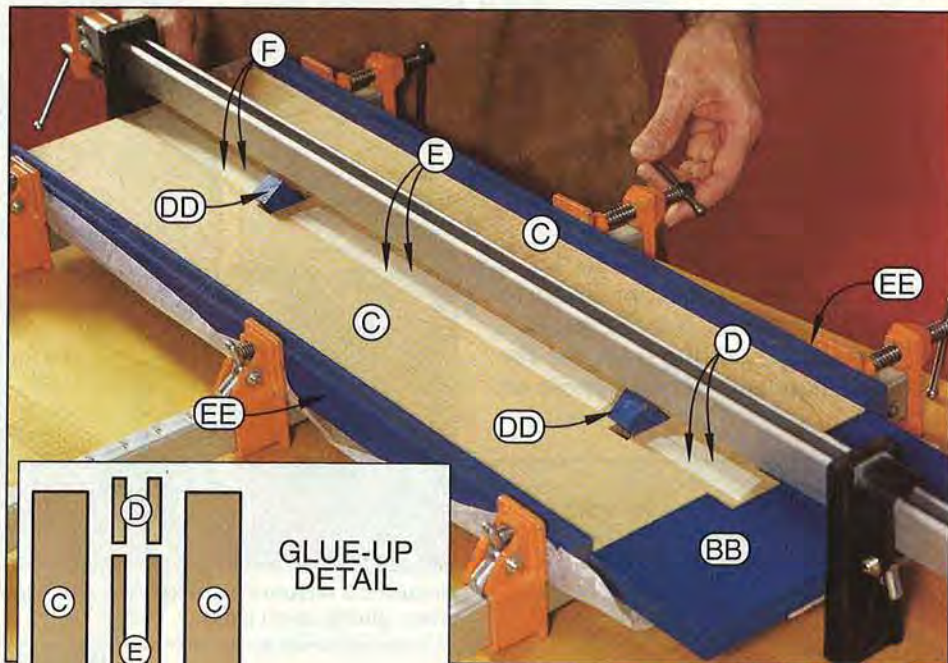

The lengthwise bar clamp pulls the mortise and tenon components (D, E, and F, taped together in pairs) into position. Fixtures BB and DD ensure correct tenon length and mortise size.

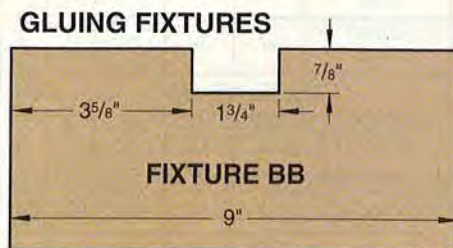

Gluing Fixtures						
Part	Finished Size			Matl.	Qty.	
	T	W	L			
SIDE PANEL						
AA	alignment board	1/4"	6"	32"	S	1
BB	single tenon gauge	3/4"	4"	9"	S	1
CC	double tenon gauge	3/4"	4"	18"	S	2
DD	spacer	3/4"	1"	1 1/4"	S	2
EE	long caul	3/4"	1 1/4"	28 1/8"	S	2
Material Key: S—scrapwood						

Nightstand

sections to a center section (A/B assembly). After positioning the assemblies in the cross clamps, pull the top (tenoned) ends flush, using fixture CC as shown *right*. Then, glue and clamp.

7 Saw a $\frac{1}{8}$ " spline slot in the inside face of each side panel where shown. To do this, position your table saw's fence $2\frac{1}{8}$ " from the center of the blade on the right side. Place a stopblock to set the kerf's length, and cut the slot in the right side panel. Move the fence to the left of the blade and repeat the operation to form the slot in the left side panel.

8 Lay out the cutting lines for the sloped edges and arched bottom on

Continued

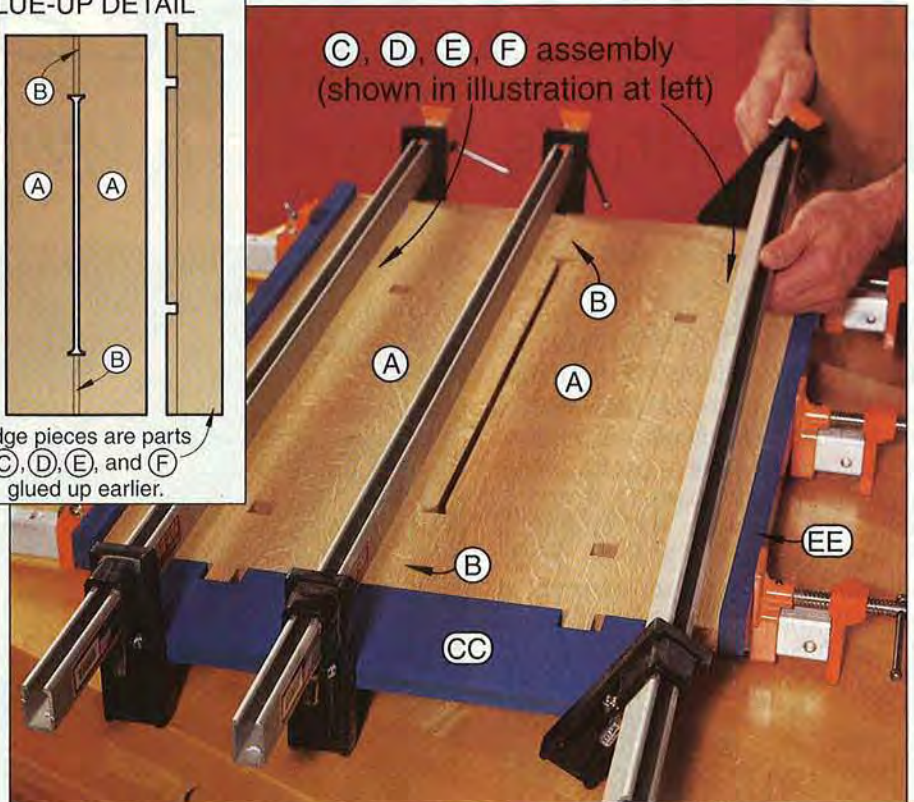
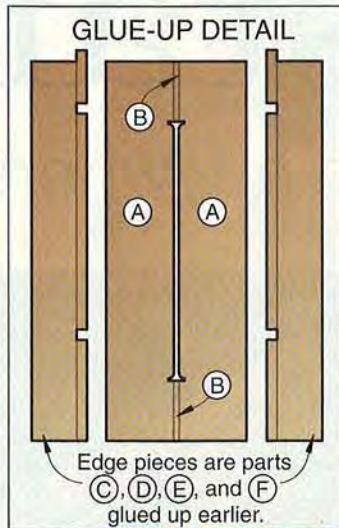

Fixture CC ensures a straight top when gluing up the side panel. Keep surfaces flush when gluing up all parts.

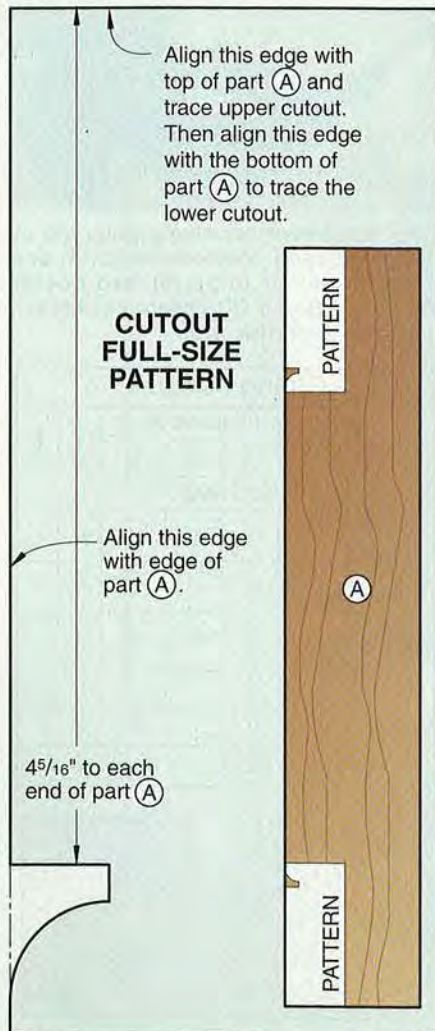

Bill of Materials											
Part	Finished Size			Mati.	Qty.	Part	Finished Size			Mati.	Qty.
	T	W	L				T	W	L		
SIDE PANEL						TOP					
A center	3/4"	47/8"	27 1/4"	O	4	L** center	3/4"	10"	22"	O	1
B filler	3/4"	1/4"	45/16"	O	4	M** edge	3/4"	3 1/4"	22"	O	2
C outside	3/4"	3 1/4"	27 1/4"	O	4	N** mortise end	3/4"	3/4"	1"	O	4
D* mortise top	3/4"	3/4"	3 7/8"	O	4	O* mortise center	3/4"	3/4"	18 1/2"	O	2
E* mortise center	3/4"	3/4"	15 1/2"	O	4	DRAWER					
F* mortise bottom	3/4"	3/4"	7 1/4"	O	4	P side	1/2"	2 15/16"	13"	O	2
SHELVES AND APRON						Q front	1/2"	2 15/16"	17 7/8"	O	1
G shelf center	3/4"	10"	18 1/2"	O	2	R back	1/2"	2 9/16"	17 7/8"	O	1
H lower edge	3/4"	1 1/2"	18 1/2"	O	2	S bottom	1/4"	11 3/4"	17 7/8"	OP	1
I tenon	3/4"	3/4"	20 1/4"	O	4	T face	3/4"	4 13/16"	18 3/8"	O	1
J upper edge	3/4"	3/4"	18 1/2"	O	2	Materials Key: O—white oak, quartersawn; OP—oak plywood.					
K back apron	3/4"	4 7/8"	18 1/2"	O	1	Supplies: Mission-style drawer pull (see Buying Guide), #8x1" flathead wood screws, 3/4"x17 gauge wire nails, clear finish.					
*Cut from longer stock in sets of four or pairs, in accordance with how-to instructions.						Buying Guide					
**Make longer initially, then trim to finished length in accordance with how-to instructions.						Mission-style small pull, 2 3/4"x1 3/4", catalog no. 123875, about \$7 (call for current price and shipping charges). Woodcraft, 800/225-1153.					

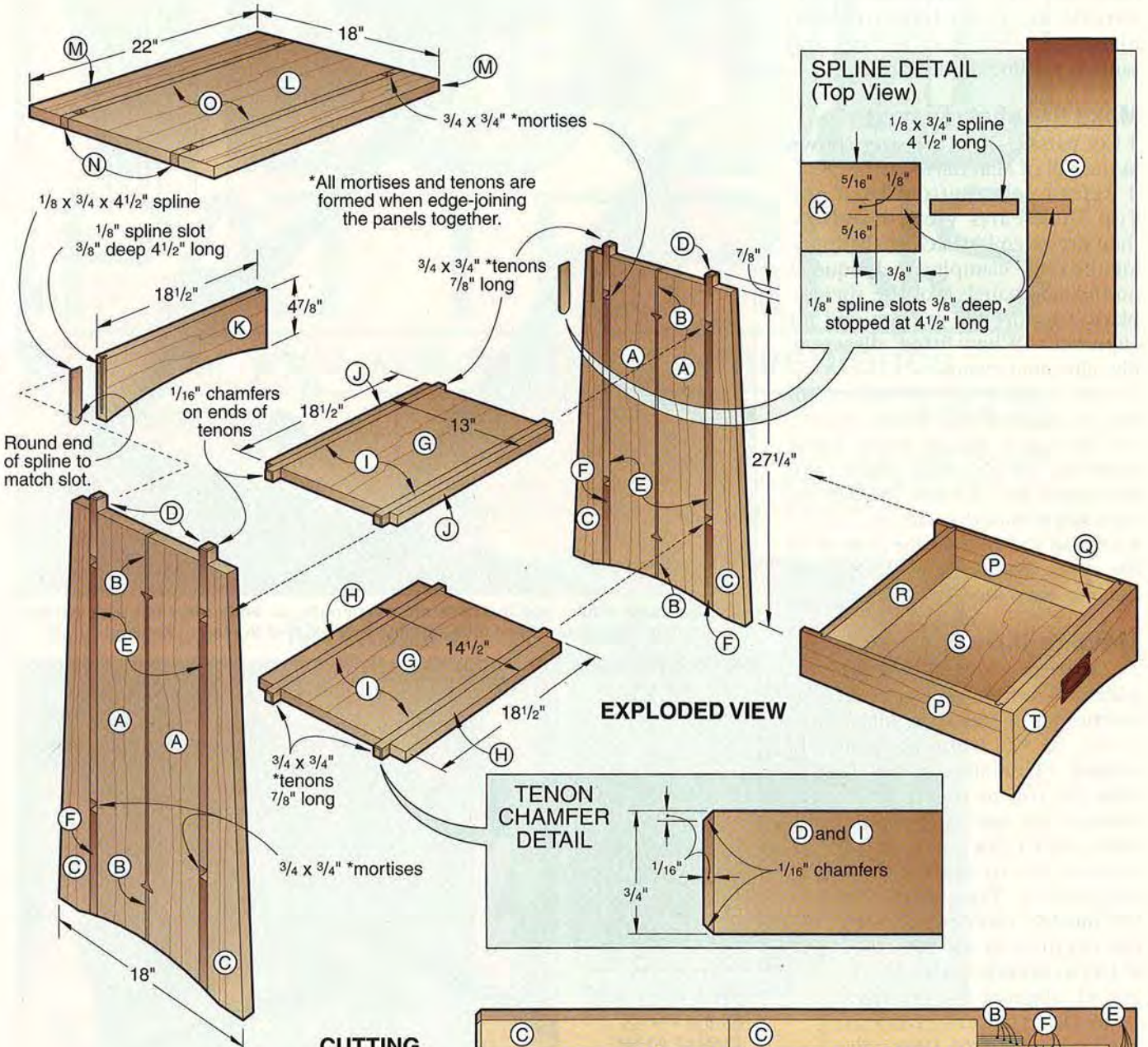

CUTTING DIAGRAM

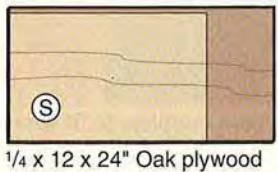
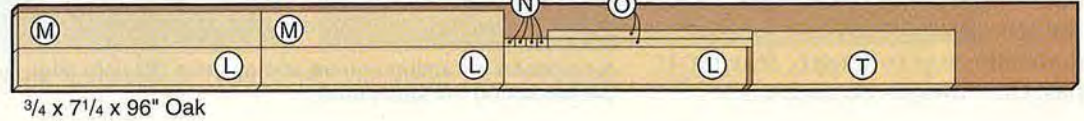
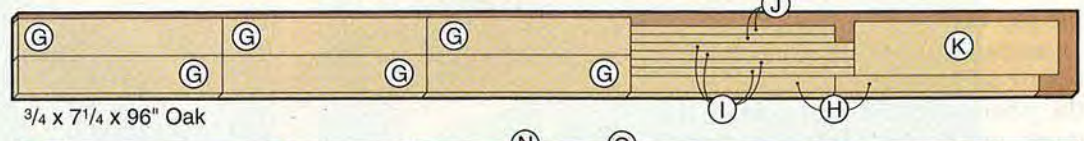
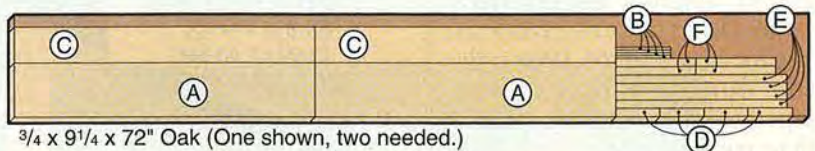

Nightstand

each side panel. Bandsaw slightly outside the lines. Joint or hand-plane the edges to the line, and sand to the line on the arch.

Make the shelves next

1 Cut parts G-K to the sizes shown in the Bill of Materials.

2 Refer to the Bottom Shelf and Top Shelf Parts View drawings, then dry-assemble each shelf, applying the same clamping technique as on the side panels. For the shelves, place a fixture CC at each end for alignment. When fitted, disassemble, glue, and clamp.

3 Form a spline slot in each end of the back apron (K) where shown on the Back Apron Parts View drawing. (We used a router and slot-cutter bit.) Center the slot on the thickness of the part.

4 Lay out the arch on the bottom of the apron. Bandsaw slightly outside the line, then sand to the line.

Move to the top

1 Cut parts L and M to size, adding 1" to the length shown on the Bill of Materials. Make parts N $\frac{1}{2}$ " longer than shown. (This allows you to trim the top to length after gluing it up, leaving perfectly flush ends.) Cut the mortise centers (O) to the finished size shown. Tape stock for the mortise centers together, and cut them in one pass.

2 Dry-assemble parts M, N, and O, aligning the mortises with the spacers (DD) as shown *above right*. Glue only the outside edges of the taped-together mortise parts N and O to parts M.

3 Remove the tape to separate the two edge assemblies (M/N/O). Dry-assemble the edge assemblies to the top center (L). Align the mortises across the top, using a framing square and spacers DD as shown in the photo *right*. Then, unclamp the parts, apply glue, and clamp until the glue dries.

4 Cut the top to length, leaving 1" past the mortises on each end.

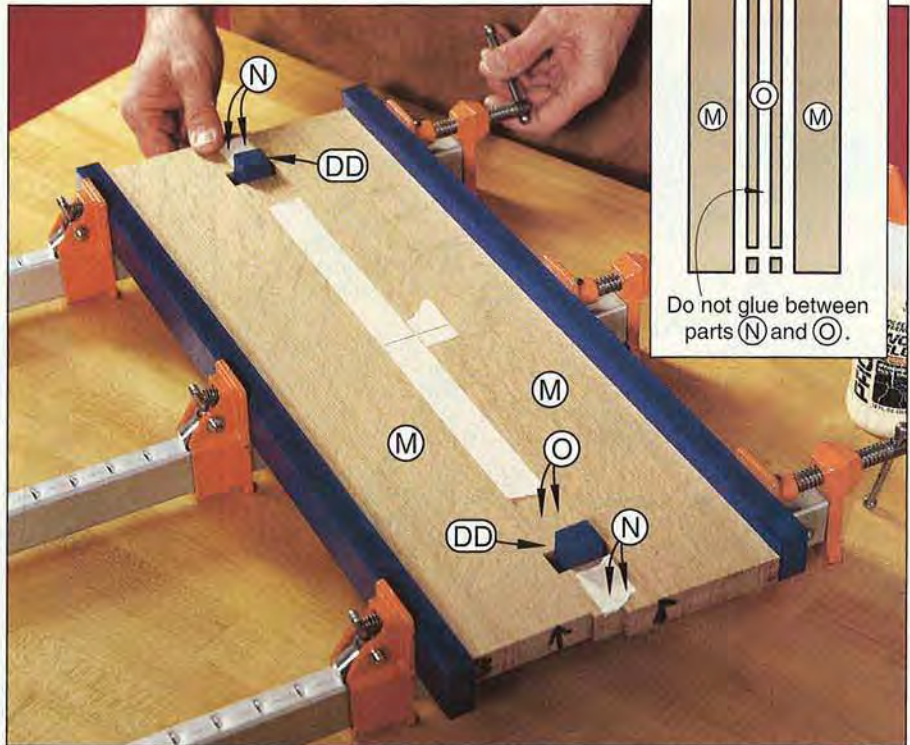

The top's outer edges and mortises are overlength, so ends need not look perfect. After joining these assemblies to the center, you will trim the top to finished length.

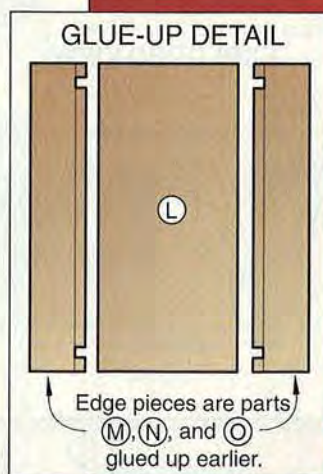

A carpenter's framing square and spacers DD help align the top's mortises to fit over the tenons on the side panels.

Put all the panels together

1 Chamfer the tenon ends, referring to the Tenon Chamfer detail. (We chamfered the tenons with a file; sanding would work, too.)

2 Cut two $\frac{3}{4} \times 4\frac{1}{2}$ " splines from $\frac{1}{8}$ "-thick hardboard or plywood. Shape them to fit into the curved ends of the slots.

3 Sand the side panels, shelves, back apron, and top. Be careful not to round the tenon corners or make the tenons smaller when sanding.

4 Referring to the Exploded View drawing, dry-assemble the side panels, shelves, and back apron (K) with splines. Arrange clamps and protective pads, then disassemble the parts.

Apply glue to the joints. (We recommend white glue for this large assembly—it allows longer working time.) Reassemble the parts, and clamp. Check for square by measuring diagonally across the back. Wipe off glue squeeze-out.

5 Without gluing, fit the top over the tenons on the side panels. Arrange your clamps and pads, then remove the top. Apply glue, reinstall the top, and clamp.

A drawer completes it

1 Cut drawer parts P and Q to the dimensions shown.

2 Form a $\frac{1}{4}$ " groove $\frac{1}{4}$ " deep in the sides (P) and front (Q) where shown. (The bottom [S] slides into these grooves. If the material you're using for the bottom doesn't measure exactly $\frac{1}{4}$ " thick, adjust the groove width to match the actual thickness. The bottom of the groove should be $\frac{1}{8}$ " from the bottom edge of the sides and front.)

3 Cut parts R, S, and T to size. If you changed the dimensions of the groove in parts P and Q, you'll need to adjust the width of the drawer back R accordingly. Its width should equal the distance from the top of the groove to the top edge on parts P and Q.

4 Cut the $\frac{1}{4}$ " dados in the sides (P) where dimensioned.

5 Rabbet the ends of the front (Q) and back (R) as indicated.

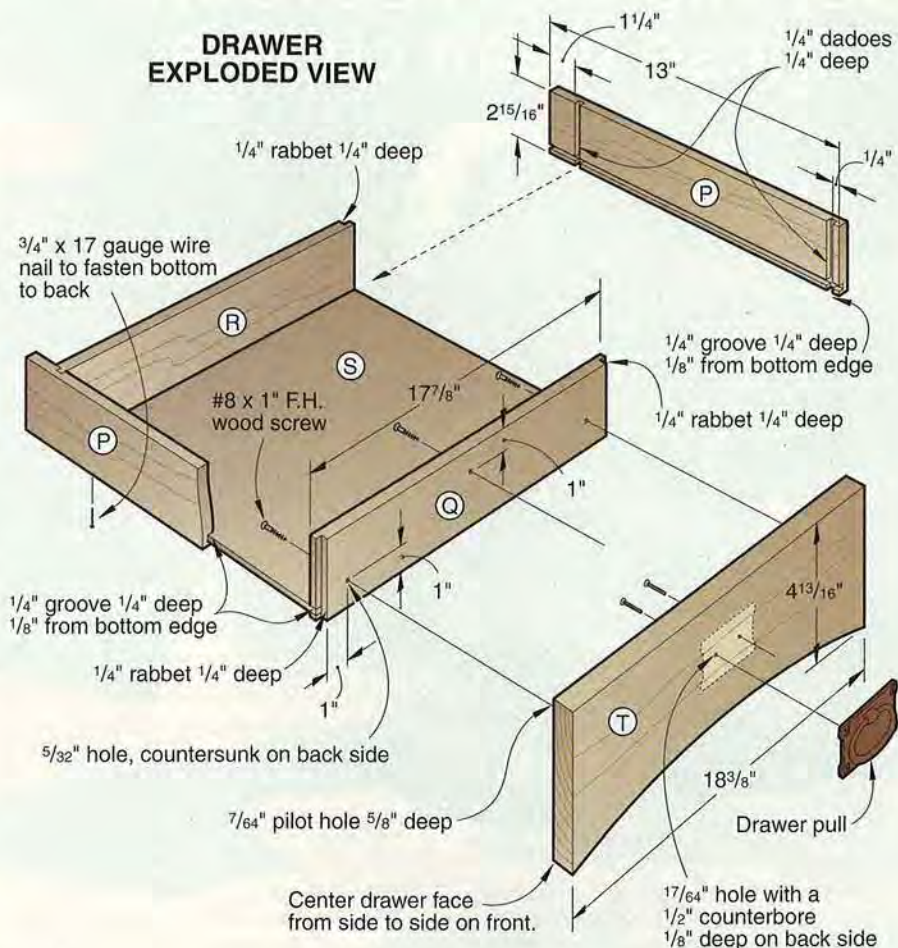

6 Glue and clamp the sides (P), front (Q), and back (R) together. Check for square by measuring diagonally across the bottom.

7 Slide the bottom (S) into the side and front grooves. Nail it to the back (R) with $3/4$ " x 17 wire nails. (For easier nailing, drill pilot holes through the bottom into the edge of the back.)

8 Lay out the arch on the drawer face (T), and bandsaw slightly outside the line. Sand to the line.

9 Drill three $5/32$ " holes through the front (Q) where shown. Countersink them on the inside of the drawer. Clamp the face (T) to the front, flush with the top and both ends. From inside the drawer, drill three $7/64$ " pilot holes $5/8$ " deep into the face.

10 Lay out locations for the drawer-pull holes on the front of the face.

Drill $17/64$ " holes through the face, with $1/2$ " counterbores $1/8$ " deep on the back side.

Now, let's finish it up

1 Finish-sand the drawer and nightstand. (We sanded with progressively finer abrasives from 150- to 320-grit.) Remove all dust.

2 Apply a clear finish. (We sprayed on three coats of semigloss lacquer, sanding between coats with 320-grit abrasive.)

3 Install the drawer pull on the face (T), then screw the face to the drawer front. Finally, slide the drawer into place. 🍀

Project Design: James R. Downing
Illustrations: Kim Downing; Lorna Johnson
Photographs: Marty Baldwin;
Hetherington Photography

PREMIUM

Get into the groove with
these clean cutters



DADO SETS

With cabinet-grade $\frac{3}{4}$ " hardwood plywood costing up to \$80 per sheet, it makes sense to machine such precious materials with tooling that yields clean cuts. For dado work, that means using one of the 14 premium models priced between \$90 and \$290 we tested for this article.

A few words about the sets in our test

For this article we reviewed 8"-diameter sets—the most popular size for tablesaws that accept 10" blades. Several manufacturers sell 6"-diameter blades similar to those we tested. These sets sell for about \$10–\$20 less than their big brothers. They make sense if you have a saw with a universal motor, or induction motor of less than $1\frac{1}{2}$ horsepower. An 8" set yields dados up to about 2" deep, and a 6" set cuts to about 1" deep on most saws. You may find the capacity of an 8" set handy for cutting tenons or deep finger joints.

Our tested blades cut dados from $\frac{1}{4}$ " to $1\frac{3}{16}$ " wide. Some of the manufacturers rightly claim that you can cut a dado as wide as $2\frac{9}{32}$ " wide with their sets—if you use every chipper and shim in the set. But, we find trying to do that impractical. Why? If you put a stack of blades wider than $1\frac{3}{16}$ " on most tablesaws you will be left with little arbor thread for the arbor nut to hold on to.

How we tested the sets

As you can see in the chart at the end of this article, we tested the dado sets with a tablesaw and radial-arm saw. We precisely adjusted both machines to eliminate arbor runout as a source of poor cuts. On the tablesaw we

Left: Product tester Bob McFarlin made hundreds of cuts in various materials to arrive at our performance grades.

Fast facts

- Only sets costing \$180 and up will give you clean cross-grain cuts in hardwood plywoods. But, you can improve the performance of others greatly with the addition of a zero-clearance insert for tablesaws. We'll tell you all about these inserts, and how to make them.

- For clean cuts, buy a set with negative-hook teeth. For fast cuts and easy workpiece feeding, get a set with positive-hook teeth.
- If you're considering a shimless set, read this article carefully. We had mixed results with these products.

also adjusted the fence parallel with the miter-gauge slot and blade body (an out-of-parallel fence can turn even the best dado set into a rough cutter). With both machines we cut oak plywood, solid oak, solid pine, and melamine-coated particleboard.

On the tablesaw we made $\frac{1}{2}$ "-deep, $\frac{3}{4}$ "-wide cuts, both cross-grain, and with-grain in 8"-square test pieces guided along the fence. Nearly all of the sets excelled in the with-grain cuts, but some chipping popped up in cross-grain cuts. To verify those cross-grain results, product tester Bob McFarlin outfitted a precision miter gauge with a custom-designed aluminum backplate and air-powered hold-down clamp. (See photo left.) With this rock-steady setup, he made another series of crosscuts.

Still, some of the sets made chips with cross-grain cuts, so we repeated the cross-grain tests with a zero-clearance insert in the tablesaw. (See page 33 for information on making inserts.) This made a dramatic improvement in many of the sets, as you can see in the chart and in the photo above right.

If you just don't want to hassle with making zero-clearance inserts—you'll need one for each width of dado cut you make—buy a dado set that excels even without inserts. You'll spend at least \$180. But, you can save some money by making inserts. Just buy



Several of the tested sets made chip-free cross-grain cuts in oak plywood only when used with a zero-clearance insert in the tablesaw. Without an insert, the results were poor.

a blade, such as the Delta 35-535 at \$95, or the Freud SD208 at \$90, that crosscuts plywood with good results if you use an insert.

In the radial-arm saw portion of the chart, you will see that we made cross-grain cuts by both *pulling* and *pushing* the set through the workpieces. The pulling motion produced better results with most of the sets, but we found it to be an unsafe practice. Even when we reduced the size of the test cuts to $\frac{1}{4}$ " deep and $\frac{1}{2}$ " wide, the dado sets tended to climb or lurch toward us. Pushing the set through the workpiece reduced the climbing, but also lowered the quality of the cuts. Our advice: Don't use a radial-arm saw for dado work.

PREMIUM DADO SETS

3 key features that separate great sets from good sets

• **Well-made, accurate chipper**s make a difference. Many of the top-performing sets in our test have four-tooth chippers that tend to chip out less when the set exits its cut. The four-tooth chippers don't "hammer" the bottom of the cut, vibrate less, and feed through the cut more smoothly.

The better-performing sets have raker teeth on their chipper blades that are precisely ground to the same height as the raker teeth on the outer blades. (Outer blades have beveled and raker teeth as shown *below*. Chippers have only raker teeth.) If the raker teeth on the chippers are not ground to the same height, or if the arbor hole is slightly sloppy, the set will not cut a flat bottom.

We also found that several of the sets have features that make them easier to stack together in precise widths. In the past few years some manufacturers—CMT, Forrest, Jesada, and Freud with its SD508 set—have added a $\frac{3}{32}$ "-thick chipper. (Other sets have only $\frac{1}{4}$ ", $\frac{1}{8}$ ", and $\frac{1}{16}$ " chippers.) With the $\frac{3}{32}$ " chipper we could arrange the sets for precise cutting widths with less shimming.

Our stacking procedure was further simplified with the Forrest set because of the precise thicknesses of its plates. As you can see

in the chart, we stacked together all of the sets without shims for what—in theory—should have been $\frac{1}{4}$ ", $\frac{1}{2}$ ", and $\frac{3}{4}$ "-wide cuts. Only the Forrest set was exactly $\frac{1}{4}$ " and $\frac{1}{2}$ " wide without shims. For a $\frac{3}{4}$ "-wide cut, it and the CMT, Freud SD208, and Systematic 1740 were off by .005" or less. In the chart we show in thousandths of an inch how much the sets exceeded (+ readings) or fell short (- readings) of the desired cutting widths.

• Outer blades that slice cleanly virtually eliminate tearout.

The sets that leave no splinters or chips on dado edges have beveled teeth with sharp cutting edges free of any micro-chips in their carbide surfaces. We also found in our testing that the blades with negative-hook teeth make consistently better cuts in all materials, especially when making cross-grain cuts without zero-clearance inserts. As shown in the photo *below*, negative-hook teeth angle back from an imaginary line running from the center of the blade to its outside. On the other hand, positive-hook teeth pitch forward from that imaginary line.

So why do manufacturers make dado sets with positive-hook teeth? Because positive-hook sets feed with greater ease and speed,

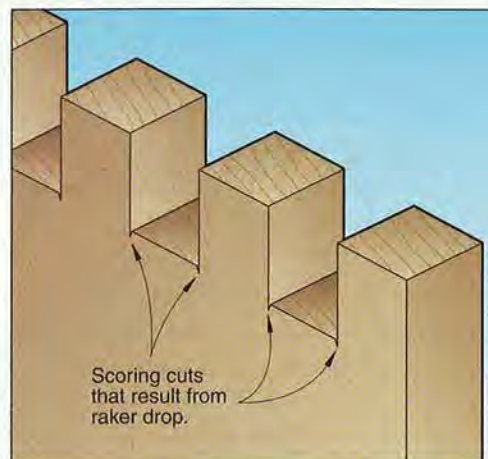

especially in hardwoods—an important consideration for production work.

• Raker drop affects the final look of the cut.

For clean dado walls, manufacturers grind the tips of the beveled teeth slightly higher than the raker teeth. This produces a tiny V-shaped scoring cut in the dado corners as shown *above*. We refer to the depth of this V cut as raker drop, and in the chart we list this dimension for each set. If you frequently use a dado set for cutting box joints or other cuts where the end of the dado cut is exposed, choose a set with little raker drop.

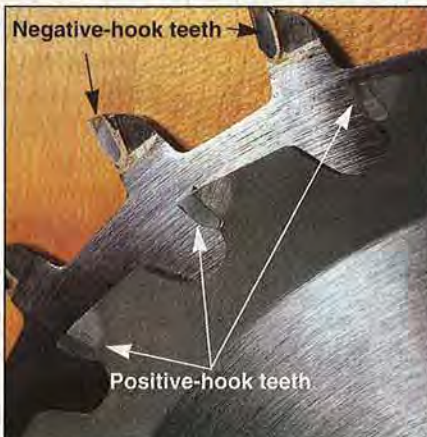
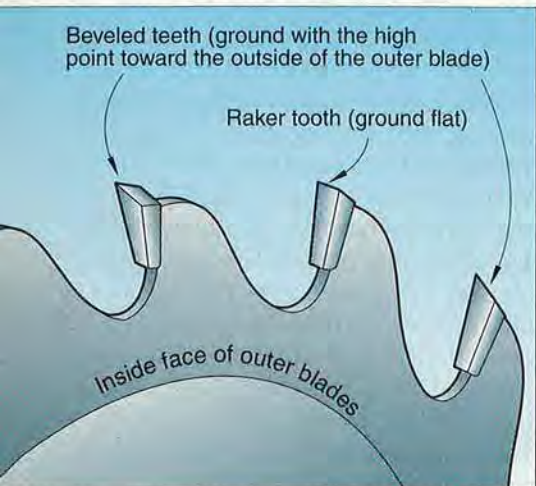

Negative-hook teeth cut more cleanly than positive-hook teeth that cut with greater ease and speed.



Of the various shims available we prefer magnetic ones for handling ease.

Here's the skinny on shims

Because of the varied thicknesses of sheet goods and solid stock, you almost always have to use shims to adjust the width of a dado cut so the material fits into it properly. More than half of the tested sets come with shims. (Two products don't require shims—more on that later.) As you can see in the photo *previous page bottom right*, shims come in numerous shapes, materials, and thicknesses.

Of the various types, we especially liked the Systimatic shims. They were the only ones that went on and off easily, and proved impossible to drop into the saw cabinet. You place these magnetic shims directly on the blade and they stay there when you put the blade on the saw arbor. The drawback: they come only in .010", .012", and .015" thicknesses (plastic shims come as thin as .002"). So when using them you may need a few thin sheets of paper for fine-tuning the width of some cuts. (The magnetic shims hold paper shims against the blade body.)

Easy-to-adjust, shimless sets: Have they arrived?

Two of the tested sets—the Freud Dial-A-Width Dado, model SD608, and Craftsman Excalibur Elite (also available as the DML Thoroughbred)—require no shims. Both products have a center hub that you turn to change the width of cut (see photo *above right*), but that's where all similarities end.

Like the other sets in this test, the Freud has two outer blades and a full set of chippers. After you assemble the set for the approximate cut width, you dial the red aluminum hub for fine width adjustments. As you rotate the hub, each click adjusts the cut width .004" in either direction. Reassembling the set for use



The Freud SD608 (left) and Craftsman Excalibur Elite do not require shims.

on saws that tilt the blade to the left or right was a snap.

Although the adjustment feature worked perfectly, there were many dado sets in our test that produced slightly cleaner cuts at a lower price. Because of the added width of the hub, we found that we could safely make cuts up to only $\frac{3}{4}$ " wide. At that point, only half of the threads on the arbor nut of our General 350-1 tablesaw were engaged on the threads of its $1\frac{1}{4}$ "-long arbor.

The Craftsman set has one chipper. You leave it in place for cuts from $\frac{1}{2}$ " to $1\frac{3}{16}$ " wide, and remove it for $\frac{1}{4}$ "- to $\frac{1}{2}$ "-wide dadoes. The product comes set up for table-saws that tilt the blade to the left (Craftsman, Powermatic 66, Jet Xacta Saw Left, and left-tilting versions of the Delta Unisaw). We tested the set on a General right-tilting saw. Disassembling it and reassembling it for use on that saw proved nothing short of difficult. All things considered, including cutting performance (see chart), we can't recommend this \$200 product.



No matter which set you purchase, inspect it closely for chipped or unbrazed teeth.

Give your dado set a good once-over before using it

Before you put one of these dado sets on your saw, inspect it carefully for defects. In our test samples we found chipped teeth, teeth that were not completely brazed on (see photo *above*), and uneven plastic coatings.

All of the manufacturers will replace blades with defective teeth. In the case of the plastic coating—a rust-preventive measure found on all of the Freud sets except the SD208—you'll need to

Continued

PREMIUM DADO SETS



The Freud SD308, SD508, and SD608 sets come with a plastic coating that you need to remove with a solvent.

remove it with a solvent such as acetone or lacquer thinner. As shown *above*, this plastic layer can be uneven, preventing the blades and chippers from being stacked flush and parallel with each other.

Several of the tested blades have factory-glued-on shims on the inside surface of the outer blades. These shims must be used at all times because they provide clearance between the outer blade plates and the chipper teeth. In our two samples of the Freud SD308, these shims did not stick well to the plastic coating.

Here are the sets we rate tops in three price ranges

• Over \$200:

If you want excellent dado cuts in all materials, with or without zero-clearance inserts, buy the Forrest Dado King. It's high priced at \$290, but comes with \$45 in sharpening coupons.

• \$150-\$200:

The nod here goes to the Freud SD508, CMT, and Jesada sets. These products performed with equal excellence in a tablesaw. The Freud was slightly better in a radial-arm saw, but you'll need to clean off its plastic coating. All of these sell for about \$180.

Written by Bill Krier Product testing: Bob McFarlin

HERE'S HOW WELL 14																
BRAND	MODEL	NUMBER OF CHIPPERS	TEETH PER CHIPPER	NUMBER OF BEVELED TEETH PER OUTSIDE BLADE	NUMBER OF RAKER TEETH PER OUTSIDE BLADE	TOTAL NUMBER OF TEETH IN SET	(N) NEGATIVE OR (P) POSITIVE HOOK ANGLE	RAKER DROP (1) (INCH)	SHIMS INCLUDED (2)	TABLESAW PERFORMANCE (3)						
										WITH ZERO-CLEARANCE INSERT						
										CROSS-GRAIN OAK PLYWOOD	WITH-GRAIN OAK PLYWOOD	CROSS-GRAIN SOLID OAK	WITH-GRAIN SOLID OAK	CROSS-GRAIN PINE	WITH-GRAIN PINE	MELAMINE-COATED PARTICLEBOARD
AMANA	658030	4	2	20	4	56	P	.012	P	F	E	G	E	G	E	E
	658040	4	2	38	8	100	N	.012	P	G	E	E	E	E	E	E
CMT	230-02408	6	4	12	12	72	N	.008	P	E	E	E	E	E	E	E
CRAFTSMAN	Excalibur Elite 32608	1	10	16	6	54	P	.015	Not Req'd.	G	E	G	E	E	E	E
DELTA	35-535	5	2	20	4	58	P	.018	No	G	E	G	E	E	E	G
	35-560	5	2	21	3	58	P	.017	No	F	E	G	E	G	E	F
FORREST	Dado King	6	4	12	12	72	N	.010	No	E	E	E	E	E	E	E
FREUD	SD208	5	2	6	6	34	N	.008	S	G	G	G	E	E	E	G
	SD308	5	2	20	4	58	P	.020	No	F	E	G	E	G	E	G
	SD508	6	4	12	12	72	N	.006	S	E	E	E	E	E	E	E
	SD608	5	4	12	12	68	N	.010	Not Req'd.	F	E	G	E	G	E	E
JESADA	108-240	6	4	12	12	72	N	.010	P	E	E	E	E	E	E	E
SYSTEMATIC	1740	5	2	20	2	54	P	.008	M	F	E	G	E	E	E	E
	1755	5	6	36	6	114	P	.010	M	F	E	E	E	E	E	E

NOTES:

- Radial distance from tip of bevel tooth on outside blade to top of raker tooth on outside blade. This will be the depth of the tiny V in each corner of the cut. If you use the dado set for cutting box joints, the lower this number the better.
- (M) Magnetic shims marked with thickness. (P) Plastic shims color-coded for thickness. (S) Steel shims not marked with thickness. (No) No shims included.
- E** Excellent
G Good
F Fair
P Poor

If you prefer a blade with faster and easier feed, consider the Systematic 1740. This blade did everything well except cross-grain cuts in oak plywood.

• Under \$150:

The bargain in this test turned out to be the Freud SD208. At about \$90, it performed on a par with blades costing \$50 to \$60 more. It has a trouble-free, black-anodized finish.



Photographs: William Hopkins Illustrations: Kim Downing

PREMIUM-PRICED 8" DADO SETS MAKE THE CUT

												RADIAL-ARM SAW PERFORMANCE (3)			ACCURACY OF CUT WIDTH WITHOUT USING SHIMS (4)						COMMENTS
												PULLING THROUGH CUT			PUSHING THROUGH CUT						
												WITHOUT ZERO-CLEARANCE INSERT									
CROSS-GRAIN OAK PLYWOOD	CROSS-GRAIN SOLID OAK	CROSS-GRAIN PINE	MELAMINE-COATED PARTICLEBOARD	CROSS-GRAIN OAK PLYWOOD	CROSS-GRAIN SOLID OAK	CROSS-GRAIN PINE	MELAMINE-COATED PARTICLEBOARD	CROSS-GRAIN OAK PLYWOOD	CROSS-GRAIN SOLID OAK	CROSS-GRAIN PINE	MELAMINE-COATED PARTICLEBOARD	FLATNESS OF BOTTOM OF CUT (3)	1/4" CUT	1/2" CUT	3/4" CUT	WEIGHT OF FULL SET (POUNDS)	COUNTRY OF MANUFACTURE (5)	SELLING PRICE (6)			
P	G	G	G	E	E	E	E	P	G	G	G	G	+015	+015	+025	4.52	IS	\$150	Fast feed rate, but chips plywood in crosscuts.		
P	E	E	E	E	E	E	E	P	E	E	E	G	+012	+012	+025	4.67	IS	235	High-quality set, but it shouldn't chip plywood in crosscuts considering its price.		
E	E	E	E	E	E	E	E	G	G	G	G	G	+007	+010	+002	5.67	IT	180	Excellent cuts with tablesaw. Includes a 3/32" chipper. Slow feed rate. Identical to Jesada set.		
P	G	E	G	G	G	G	G	P	F	F	F	F	No shims used with this product			5.04	US	200	Complicated and difficult to set up. Other sets this expensive cut better.		
P	G	G	G	G	E	E	G	P	G	G	F	F	+017	+030	+065	4.15	NZ	95	Good results considering the price. Chips plywood in crosscuts. Fast feed rate.		
P	G	G	F	F	G	G	G	P	F	F	P	G	+005	+010	+015	4.30	CA	155	Doesn't perform well considering its price.		
E	E	E	E	E	E	E	E	E	E	E	E	E	G	.000	.000	-.005	5.74	US	290*	The top set in the test. Slow feed rate.	
F	G	E	G	G	G	G	G	F	G	F	G	E	-.010	-.010	-.005	5.42	IT	90	Best value under \$150. Slow feed rate.		
P	G	G	F	G	G	G	G	P	F	F	P	G	+005	+015	+020	5.56	IT	125	Two test sets showed excessive micro-chips on teeth. Glue applied at factory does not hold shims to outer blades. Fast feed rate.		
E	E	E	E	E	E	E	E	E	E	E	E	E	G	+003	+007	+013	8.65	IT	180	Excellent results in all materials. Includes a 3/32" chipper. Slow feed rate. Best overall results in sets under \$200.	
P	G	G	E	G	G	G	G	G	G	G	G	G	+002	+010	+013	8.54	IT	225	Easy to adjust because it's shimless. Excessive plastic coating on blades requires cleaning. Two test sets showed excessive micro-chips on teeth.		
E	E	E	E	E	E	E	E	G	G	G	G	G	+005	-.005	-.010	5.65	IT	180	Excellent cuts with tablesaw. Includes a 3/32" chipper. Slow feed rate. Identical to CMT set.		
P	G	E	E	E	E	E	E	G	G	G	G	G	+010	+005	+005	5.11	US	160	Fast feed rate, but chips plywood in crosscuts.		
P	E	E	E	E	E	E	E	G	G	G	G	G	+025	+015	+015	8.63	US	270	Medium feed rate. Excellent results in tablesaw except for chipping in plywood crosscuts.		

4. Measured in inches. Outside blade and chippers were assembled for the listed widths with no shimming.

5. (CA) Canada
(IS) Israel
(IT) Italy
(NZ) New Zealand
(US) United States

6. Based on mail-order prices at time of article's production.
(* Includes \$45 sharpening coupon.

WHERE TO CALL FOR MORE INFORMATION:

Amana 800/445-0077	Craftsman Call or visit your local Sears store	Forrest 800/733-7111	Jesada 800/531-5559
CMT 888/268-2487	Delta 800/438-2486	Freud 800/472-7307	Systematic 800/426-0000



Entertainment Extravaganza

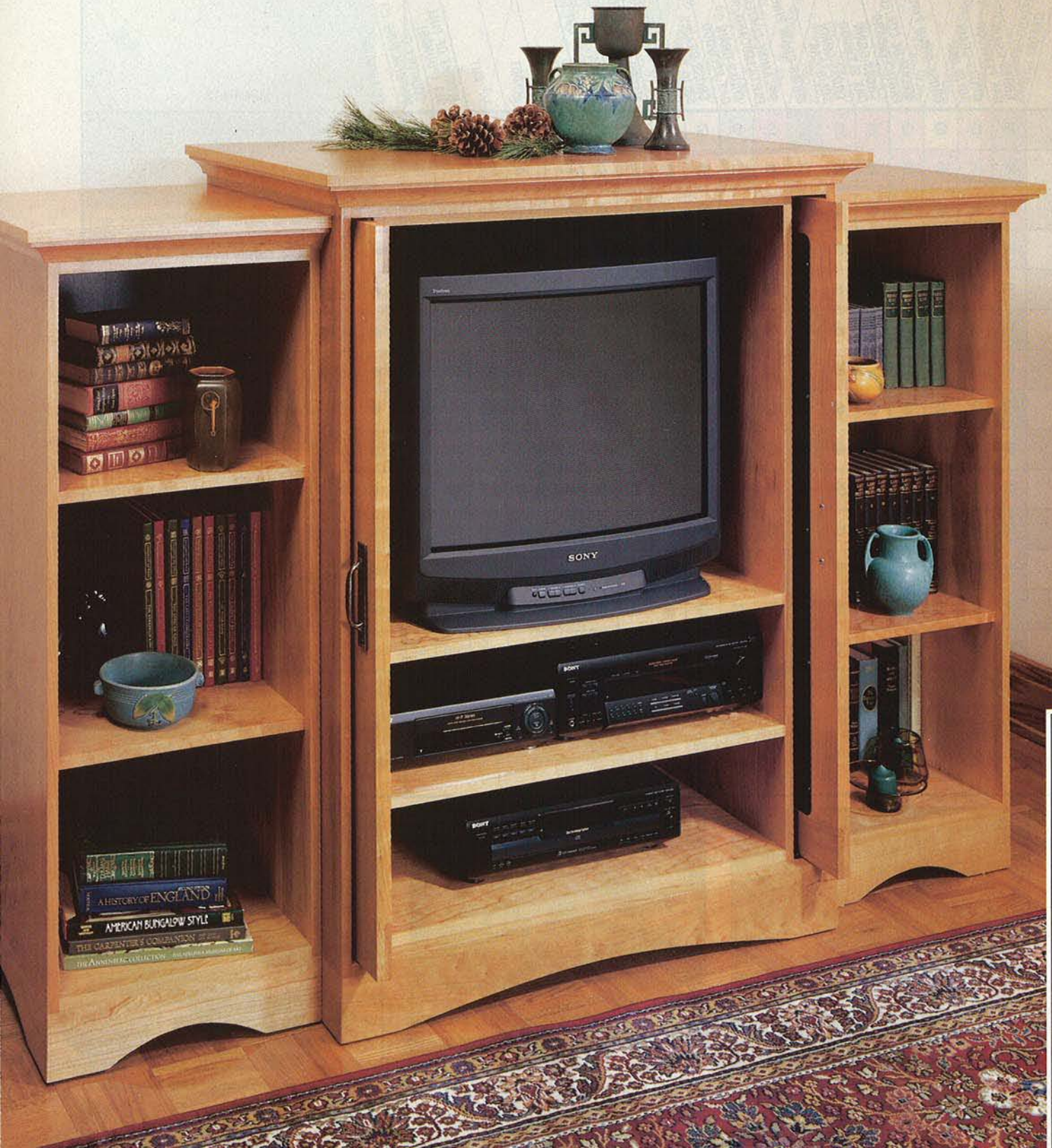

A handsome storage system for your home electronics, and a whole lot more

 [Print this article](#)

Give your CD sound system, TV, and VCR a fitting home with this three-piece cabinet combination. The main attraction, the center cabinet, offers room for a 27" television. Flipper doors pull out from the interior and neatly hide the screen when not in use. Optional matching side cabinets abound with room for practically everything else.

Begin your project-building with the carcass

1 Cut the sides (A), bottom (B), and top (C) to size from $\frac{3}{4}$ " cherry plywood. Or, for a less expensive alternative, stain birch plywood (we prefer a gel stain) to look like cherry.

2 Cut the rabbets in the sides (A) and bottom (B) and top (C) and

grooves in the top (C) where indicated on the drawing below.

3 Glue and screw the carcass (A, B, C) together, checking for square. Remove excess glue.

4 Measure the rabbeted opening, and cut the back (D) to size. Drill the mounting holes through the back side of the back panel and into the rabbet in the carcass.

Continued

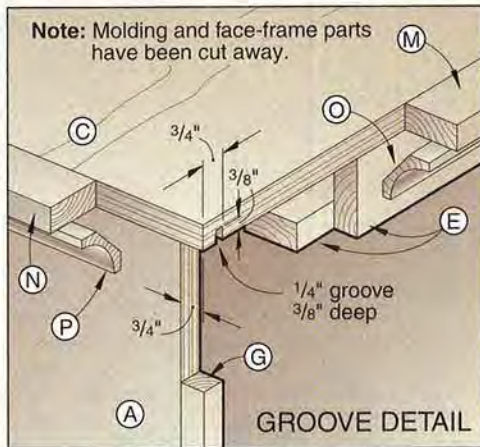

- #6 x $\frac{3}{4}$ " F.H. wood screws
- $\frac{9}{64}$ " shank hole, countersunk
- $\frac{3}{32}$ " pilot hole $\frac{1}{2}$ " deep
- 2" vent slots 10" long, top and bottom

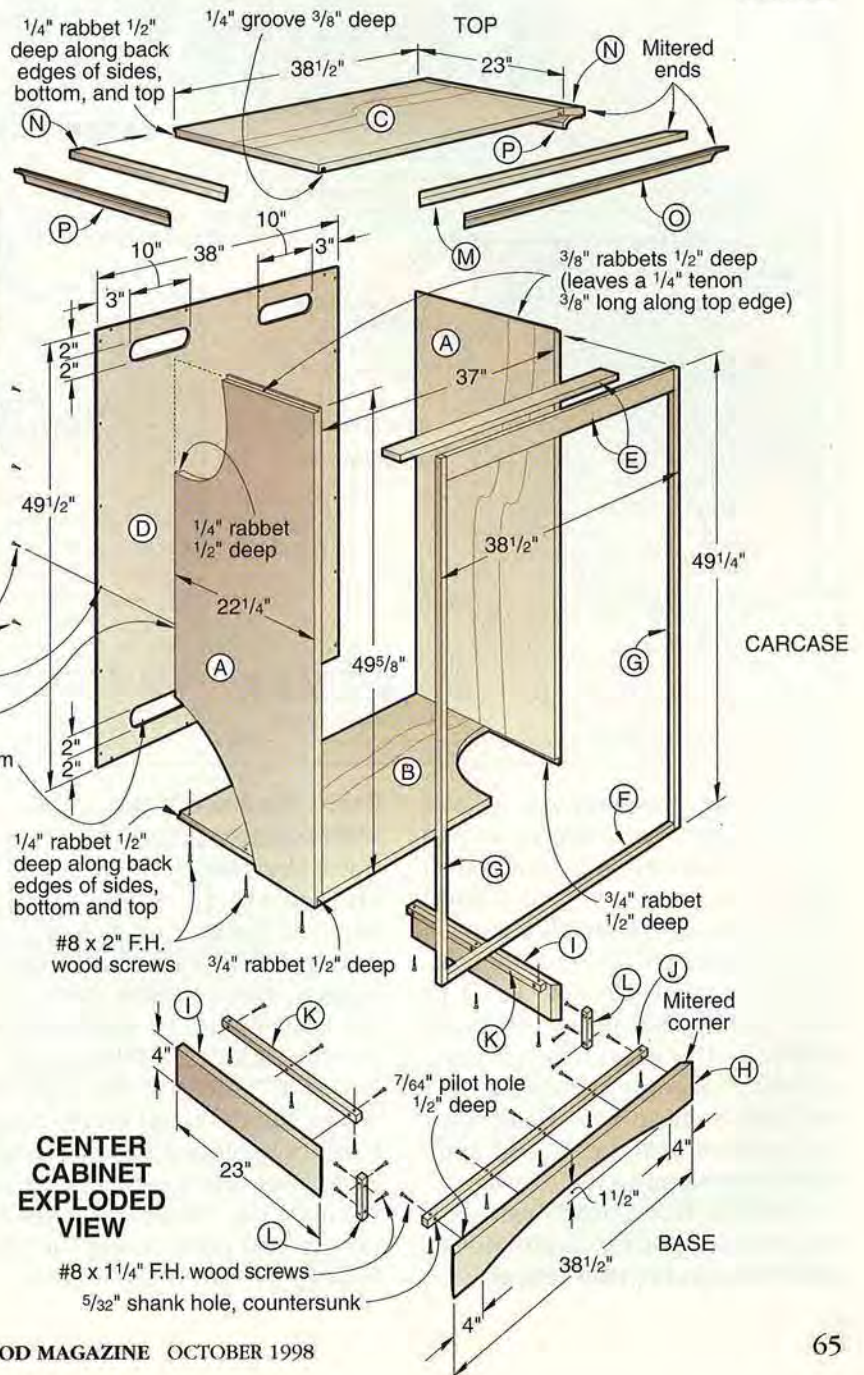

Center Cabinet Bill of Materials

Part	Finished Size*			Mati.	Qty.	Part	Finished Size			Mati.	Qty.
	T	W	L				T	W	L		
CENTER CABINET CARCASE						DOORS					
A sides	3/4"	22 1/4"	49 5/8"	CP	2	Q stiles	1 1/16"	3"	46"	C	4
B bottom	3/4"	22 1/4"	38"	CP	1	R top rails	1 1/16"	3"	18 5/16"	C	2
C top	3/4"	23"	38 1/2"	CP	1	S btm. rails	1 1/16"	3 1/2"	18 5/16"	C	2
D back	1/4"	38"	49 1/2"	BP	1	T panels	1/4"	13 1/16"	40 1/4"	BP	2
FACE FRAME						INSERT CABINET					
E top rail & cleat	3/4"	2 1/4"	37"	C	2	U muntins	1/2"	1/2"	39 1/2"	C	4
F btm. rail	3/4"	3/4"	37"	C	1	V muntins	1/2"	1/2"	12 5/16"	C	4
G stiles	3/4"	3/4"	49 1/4"	C	2	W door stops	3/4"	3/4"	5"	C	4
BASE						INSERT CABINET					
H front	3/4"	4"	38 1/2"	C	1	X sides	3/4"	20"	46 3/16"	CP	2
I sides	3/4"	4"	23"	C	2	Y shelves	3/4"	20"	31 3/4"	CP	4
J cleat	3/4"	3/4"	35 1/2"	C	1	Z banding	1/4"	3/4"	46 3/16"	C	2
K cleats	3/4"	3/4"	21 1/2"	C	2	AA banding	1/4"	3/4"	31 1/4"	C	4
L cleats	3/4"	3/4"	4"	C	2	*Initially cut parts marked with an * oversized. Trim to finished size according to the how-to instructions.					
TOP						Materials Key: CP—cherry plywood, BP—birch plywood, C—cherry					
M front	3/4"	1 3/4"	42"	C	1	Supplies: #6x1/2" flathead wood screws, #6x3/4" flathead wood screws, #8x1 1/4" flathead wood screws, #8x2" flathead wood screws, #12x1 1/2" flathead wood screws, primer, paint, clear finish.					
N sides	3/4"	1 3/4"	24 3/4"	C	2						
O* cove front	3/4"	2 1/8"	41 1/2"	C	1						
P* cove sides	3/4"	2 1/8"	24 1/2"	C	2						

Buying Guide: Hardware. Heavy-duty flipper-door system: slides, catalog no. 89822, \$43.99 each (2 needed). Overlay carrier strip and hinges, catalog no. 90239, \$32.99 each (2 needed). The Woodworkers' Store, 4365 Willow Drive, Medina, MN 55340. To order call 800/279-4441.

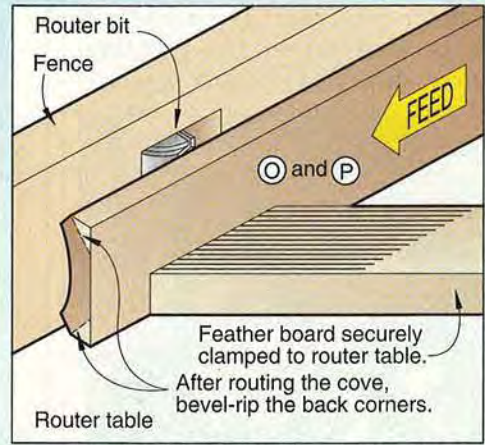
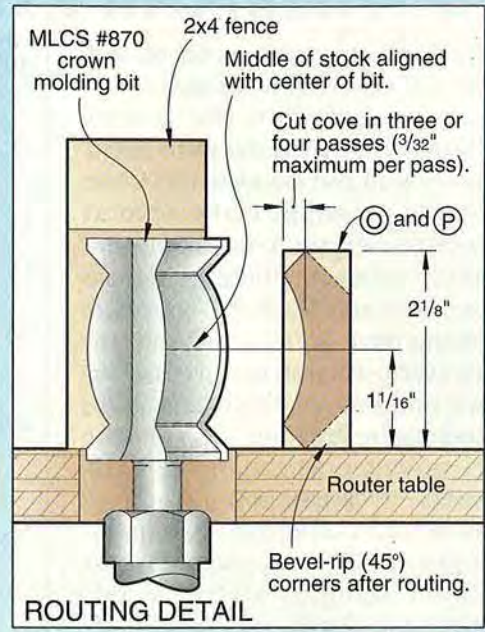

CENTER CABINET CUTTING DIAGRAM

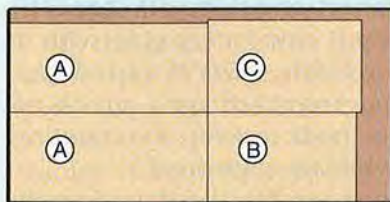

3/4 x 48 x 96" Cherry plywood

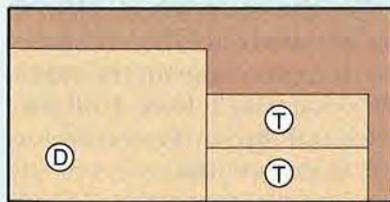

1/4 x 48 x 96" Birch plywood

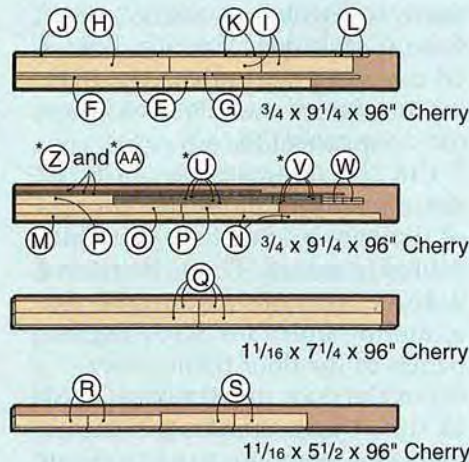

3/4 x 48 x 96" Cherry plywood

*Plane or resaw to the thickness listed in the Bill of Materials.

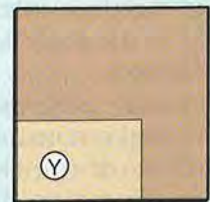

3/4 x 48 x 48" Cherry plywood

Entertainment Extravaganza

2 To form the cove molding, cut the front cove (O) and sides (P) to the sizes listed in the Bill of Materials plus 2" in length. Then, as shown in the Routing the Cove Molding drawing, make several passes to rout the cove along one surface of each piece of stock. (We used an MLCS #870 crown molding bit.)

3 Bevel-rip the back edges of the cove molding at 45° where indicated on the drawing.

4 Next, miter-cut the pieces to fit around the carcass top.

5 Glue and clamp the cove molding pieces (O, P) in place. (To do this, we clamped a cleat to the carcass top. Then, we used a 1¼"-diameter dowel and another set of clamps to pull the cove molding tight as shown in *photo A* below.)



Use a dowel and clamp block when clamping the cove molding to the top of the cabinet.

Construct a pair of half-lapped doors

1 Cut the door stiles (Q) and rails (R, S) to the sizes listed in the Bill of Materials.

2 Fit your tablesaw with a dado blade, and cut mating half laps on the ends of the stiles and rails where shown on the Door drawing. (We test-cut scrap pieces first to verify the depth of cut before cutting the stiles and rails.)

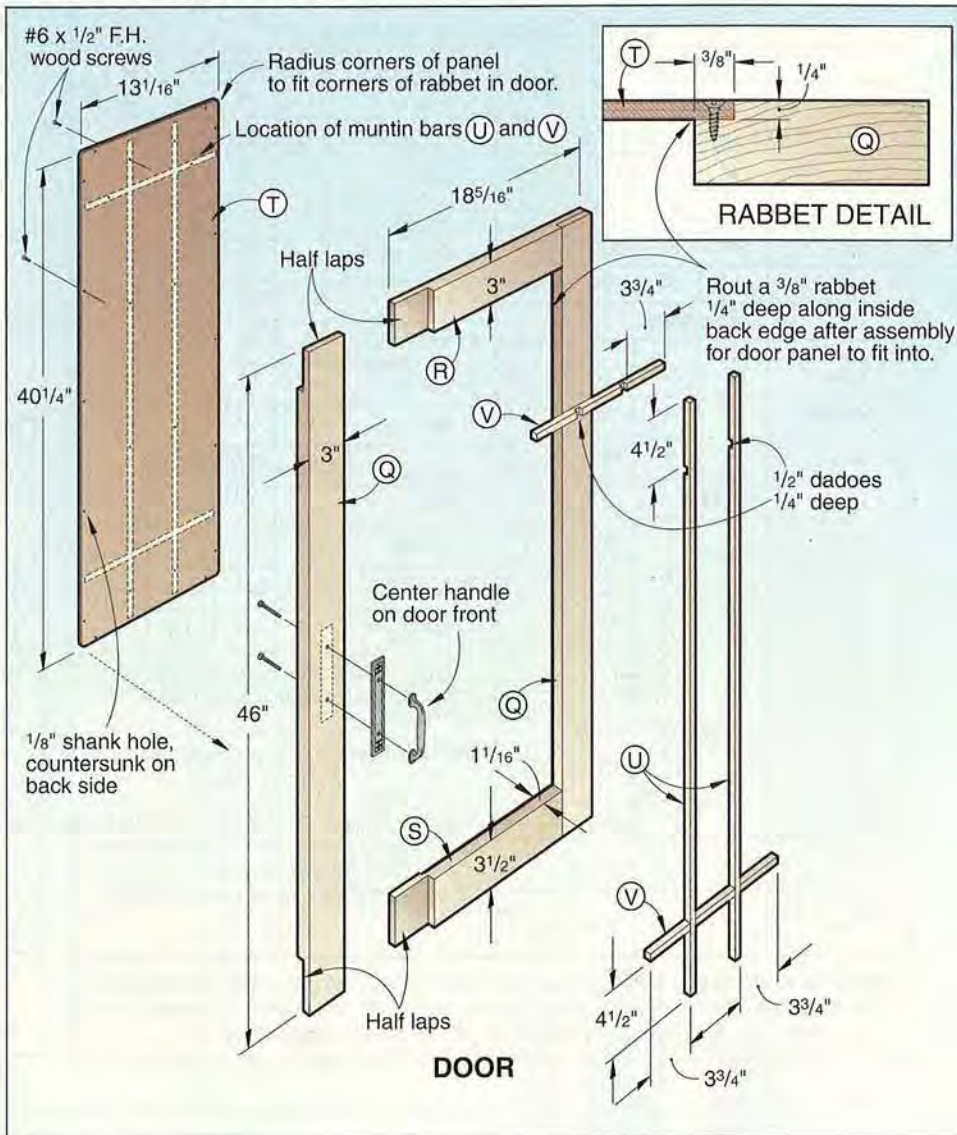

3 Glue and clamp the door stiles and rails together, measuring diagonally to check for square.

4 Sand each door smooth. Rout a 3/8" rabbet 1/4" deep along the back inside edge of each door to house the door panel (T).

5 Cut the door panels (T) to fit the openings. Round the corners of the panels to match the round-routed corners. Then, mark the hole centerpoints and drill the mounting holes for screwing the panels to the door frames later.

6 Cut the door muntin bars (U, V) to size. Using the dimensions on the Door drawing, mark and cut the dados on the muntins. (We did this on our tablesaw.)

7 Glue and clamp the muntins together, checking for square. Wipe off any excess glue with a damp cloth. (We clamped the pieces together on a piece of sheet goods to keep the muntins flat while the glue dried.)

8 Dry-assemble the door frames with the back panels (T) in place. Position the muntins (U, V) in place, and mark the hole centerpoints for screwing the muntins to the door panels later. Drill the countersunk mounting holes for attaching the muntins.

9 Cut the four door stops (W) to size and screw them to the inside face of the cabinet where shown on the Section View drawing.

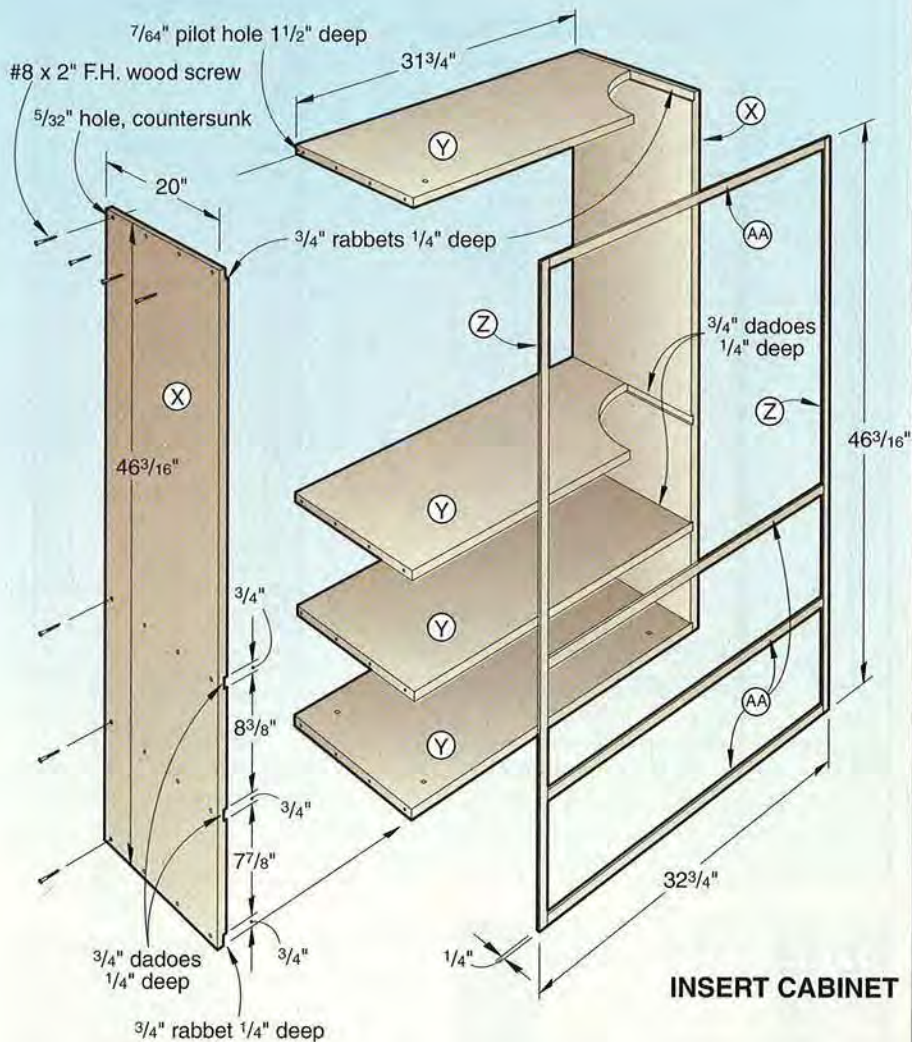

INSERT CABINET

Construct the TV insert to fit inside the center cabinet

1 Cut the insert cabinet sides (X) and shelves (Y) to size from cherry plywood. Cut the front banding (Z, AA) to size from solid stock. The insert not only supports your electronics but also hides the flipper-door hardware.

2 Mark and cut the dados and rabbets where shown on the Insert Cabinet drawing above. For ease in access, finish the cabinet pieces now. Then, glue and screw the insert cabinet together, checking for square. Next, glue and clamp the cherry banding to the front of the insert cabinet. Sand the pieces flush.

Apply the finish before adding the flipper-door hardware

Note: Because installing the slide hardware requires precision and takes some time, you'll want to install it only once. For those reasons, finish the cabinet now.

1 Finish-sand the cabinet.

2 Paint the back (D) and door panels (T).

3 Screw the door panels in place, then screw the muntins to the panels.

Now, install the flipper-door hardware

Note: The hardware system comes with an installation instruction manual. We've added several

how-to photos and instructions to clarify some of the steps.

1 Cut two spacers, one measuring 1×1×21" long and the other the thickness of your door by 12" long. As shown in photo B, use the 21" spacer to position the bottom slide 1" above the bottom of the carcass. Then, use the 12" spacer to position the slide the exact thickness of your door (ours measured 1 1/16") from the front edge of the cabinet. See the Section View drawing for dimensioning particulars.



B Use spacers to position the bottom slide where dimensioned on the Section View drawing.

2 Drill the pilot holes and screw the bottom slide in place. Repeat for the other side of the cabinet.

3 Attach the top slide and hinge carrier to the bottom slide. Then, using the hinge carrier to hold the top slide parallel to the bottom slide, screw the top slide in place as shown in photo C on the next page. Again, use the 12" spacer to position the top slide the thickness of your door from the front of the cabinet.

4 Cut a scrap piece of stock the same size as one of the door stiles (Q). You'll use this in step 6.

5 Mount your hinge base plates to the hinge carrier, working from the center of the hinge carrier out. See the Section View drawing for reference. Position

Continued

Entertainment Extravaganza



C Locate the top slide's position in the cabinet, drill the mounting holes, and screw the slide in place.

the scrap stile along the edge of the hinge carrier. Then, place a $\frac{1}{8}$ " spacer between the scrap stile and carcass. This will provide an even reveal at the top and bottom of the door frame later. Clamp the scrap stile in place. Use a square to mark the center of each hinge onto the scrap stile as shown in photo D.

6 Do not drill the holes in the doors until you've verified the locations in the scrap stock. To do this, fit your drill press with a fence and $1\frac{3}{8}$ " Forstner bit (same size as 35mm bit). Drill the hinge holes 1" from the back edge of the scrap stile.

7 Mount the hinges to your scrap stile. Attach the four hinges to the base plates attached to the hinge carrier. As stated in the hinge instructions, adjust the hinges as necessary for an even reveal between the edge of the stile and the carcass side. (We found it easier to adjust the hinge locations on the scrap stile than to do this on the assembled doors.) Once adjusted, unsnap the hinges from the hinge plates. Repeat for the other hinge assembly.

8 Install the cable blocks and then the cable system.

9 Use a square to carefully transfer the hole locations from the scrap stile to the doors. Bore the

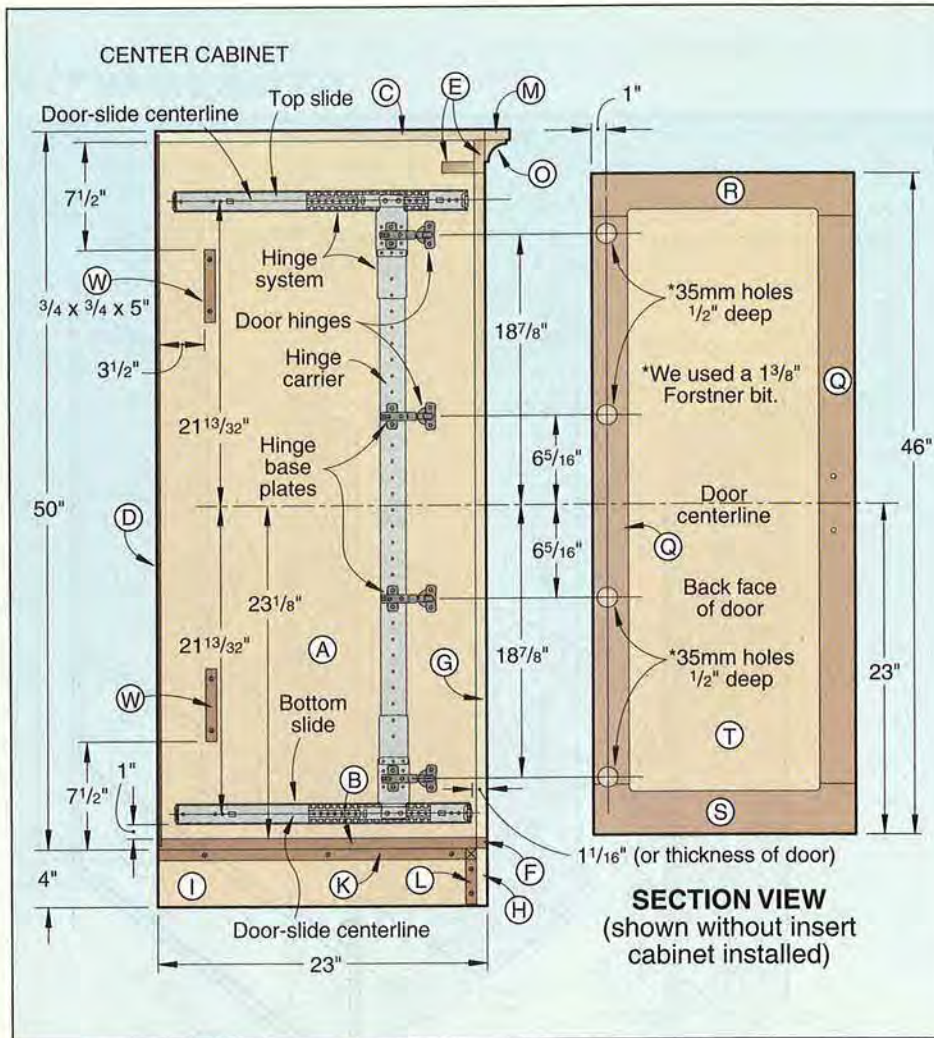

D Transfer the hinge hole centerpoints to scrap stile, and drill the holes to verify hole locations before drilling the holes in the door stiles.

holes where marked. Remove the hinges one at a time from the scrap stile, and insert them into the $1\frac{3}{8}$ " holes in the door in the same sequence. Once you have the hinges in place, reattach the hinges to the hinge base plates. Double-check for proper alignment. Repeat for the other door.

Make the side cabinets for ample storage

1 Build the side cabinets using the same construction procedures used to construct the center cabinet. See the Side Cabinets Bill of Materials and Cutting Diagram for part sizes. Review the Side Cabinet Exploded View drawing for further reference. Note that the side-cabinet molding which butts the center cabinet is cut at a 90° angle for a flush fit against the center cabinet.

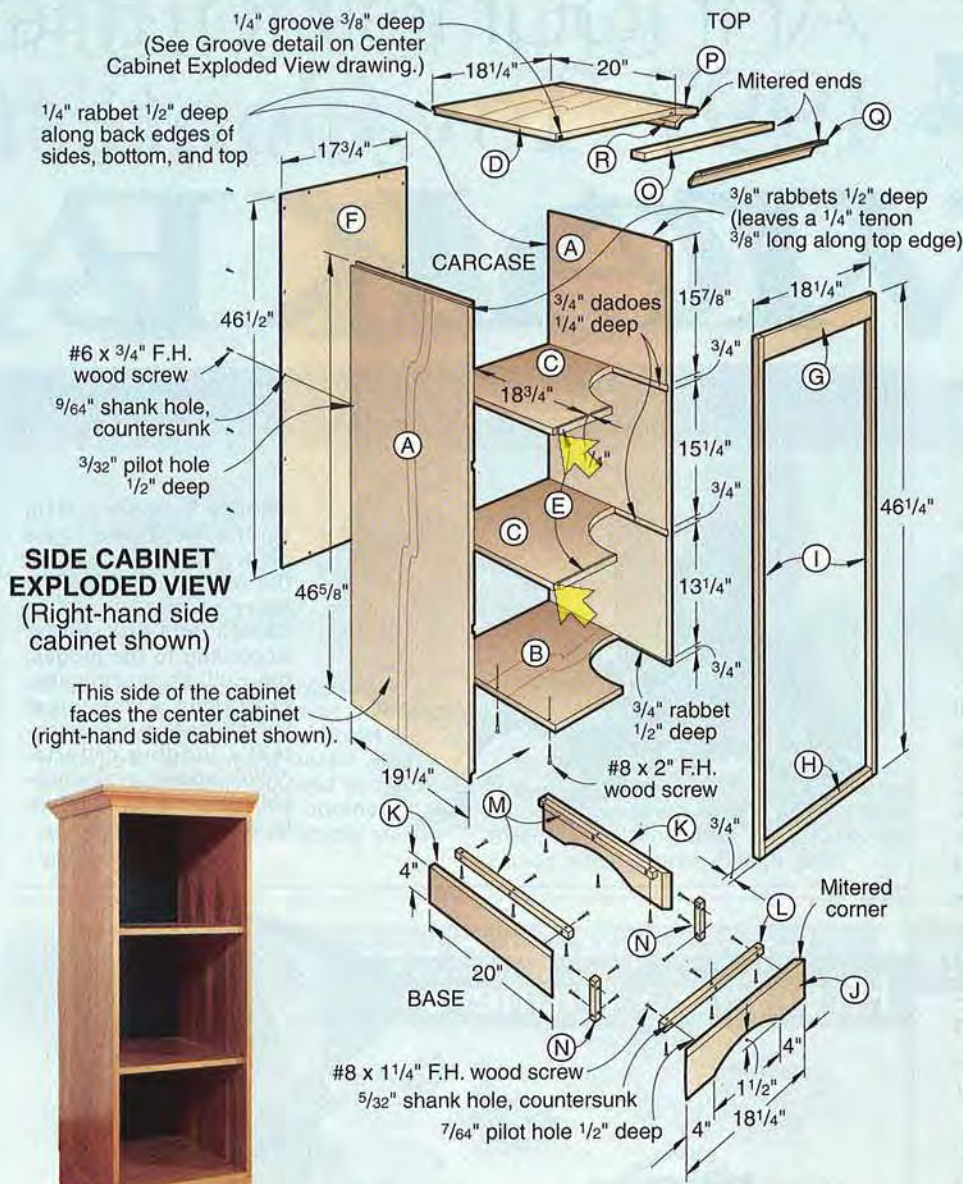

Side Cabinets Bill of Materials					
Part	Finished Size			Mati.	Qty.
	T	W	L		
SIDE CABINET CARCASSES					
A sides	3/4"	19 1/4"	46 5/8"	CP	4
B bottoms	3/4"	19 1/4"	17 3/4"	CP	2
C shelves	3/4"	18 3/4"	17 3/4"	CP	4
D tops	3/4"	20"	18 1/4"	CP	2
E banding	1/4"	3/4"	17 1/4"	C	4
F backs	1/4"	17 3/4"	46 1/2"	BP	2
FACE FRAMES					
G top rails	3/4"	2 1/4"	16 3/4"	C	2
H btm. rails	3/4"	3/4"	16 3/4"	C	2
I stiles	3/4"	3/4"	46 1/4"	C	4
BASES					
J fronts	3/4"	4"	18 1/4"	C	2
K sides	3/4"	4"	20"	C	4
L cleats	3/4"	3/4"	15 1/4"	C	2
M cleats	3/4"	3/4"	18 1/2"	C	4
N cleats	3/4"	3/4"	4"	C	4
TOPS					
O fronts	3/4"	1 3/4"	20"	C	2
P sides	3/4"	1 3/4"	21 3/4"	C	2
Q cove fronts	3/4"	2 1/8"	19 3/4"	C	2
R cove sides	3/4"	2 1/8"	21 1/2"	C	2
Materials Key: CP—cherry plywood, BP—birch plywood, C—cherry					

Finish, assemble, and add your components

1 Finish-sand the side cabinets, and apply the finish.

2 Paint the side cabinet backs (F), and screw them in place.

3 Position the side cabinets against the center cabinet. If a gap exists between the cabinets, drill mounting holes through the side cabinet sides (A) and into but not through the center cabinet sides (A). Position the holes so the screws won't be highly visible. Use wood screws to pull the cabinets tight to each other, eliminating the gap. 🐿️

Written by Marlen Kemmet Project Design: James R. Downing Illustrations: Kim Downing Photographs: Hopkins Associates; Hetherington Studio

SIDE CABINETS CUTTING DIAGRAM (enough for two cabinets)

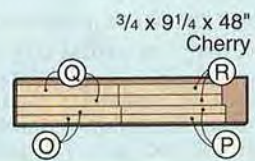
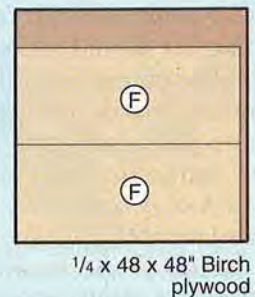
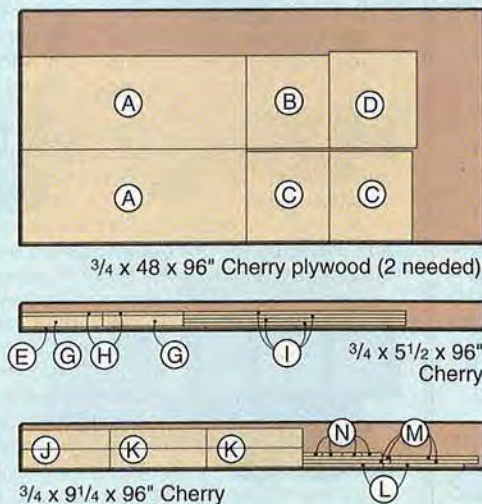



Announcing the 1997 Toy Contest **TAKE**

Who can help but marvel at a wonderful wooden toy? Certainly that was the case with our judges for *WOOD*® magazine's 1997 Build-A-Toy contest. For nearly a day, they picked up, examined, tinkered with, and yes, even played with the year's entries.

There were the usual assortment of cars, trucks, cradles, puzzles, rocking horses, pull toys, and doll furniture. Many were carefully thought out and skillfully executed. Some approached perfection. A few were appealingly folksy. But all toys were truly great because they reflected the efforts of readers to help make a needy child happy at Christmas. And they did, because all entries were auctioned last November, with the proceeds going to the U.S. Marine Corps Reserve's Toys for Tots program.

Since its inception in 1989, the Build-A-Toy contest has raised nearly \$85,000 to benefit underprivileged children during the holidays through Toys for Tots. The *WOOD* magazine staff feels proud of that. So should all our readers who have entered and the companies that have donated prizes during the past nine years. However, 1997 marks the final year of the Build-A-Toy contest. Instead, we're launching a new version—the Build-A-Gift™ contest! See page 66 for details. So here's hoping that the prizewinning toys shown on these pages inspire you in your woodworking, and prompt you to enter our new contest. 🌲

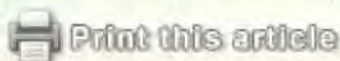

Best Toy Entry



George Schnare's farm truck captured the judges' hearts, votes, and the top place—Best Toy Entry—with its prize of \$3,000 in Delta tools. According to the judges, the Hull, Massachusetts, craftsman's whimsical vehicle best met the contest's judging criteria: child's appeal, craftsmanship, originality, durability, safety, and finish.

First Prize Winners



Dee E. Cook took First Prize, professional, and \$2,000 in DeWalt tools. The Lawrenceville, Illinois, reader's jack-in-the-box barn camper and truck was as intriguing as it was well built and neatly completed with a fine finish.

First Prize, home hobbyist, went to David Gooding, a Garden Prairie, Illinois, woodworker. His unique fish-in-a-bucket game brought him \$2,300 in Craftsman stationary machines.



First Prize, junior craftsman, was won by Chris Reising, Des Moines, Iowa. His effort in the maple dump truck was rewarded with \$1,000 in Skil power tools.

last of a line Winners A BOW!

Grand Prize Winners



Grand Prize, home hobbyist, was captured by Bill Jorritsma of Yucaipa, California. His Caterpillar Model 637-E push/pull, twin-engine tractor scraper was so realistically detailed you could almost hear the mighty engines roar. His prize was \$2,500 in Grizzly stationary power tools.

Robert C. Benson, Tyler, Texas, won the Grand Prize, professional, of \$2,500 in Bosch portable power tools with his carved rabbit rocking chair in pine.

Grand Prize, junior craftsman, was awarded to Elton G. Eby, of London, Kentucky. His well-crafted fire truck with extension ladder and hose earned him a \$1,400 RIB Hawk Ultra scrollsaw.

Second Prize Winners



Home hobbyist Jim Christian of Vancouver, Washington, walked away with Second Prize in his division and \$750 in Skil tools for this amusing take-apart jolopy of a car.

Ryan Augustine of Bloomington, Minnesota, took Second Prize, junior craftsman, and \$750 in Dremel tools with a fish, rabbit, and bird featuring interchangeable heads.

Second Prize, professional, was claimed by Howard Clements, Knox, Pennsylvania. His model land/sea/air rover of clear-finished maple and walnut won him a \$1,050 Milwaukee sliding compound miter saw.

Third Prize Winners



Jack Dalton, Jackson, South Carolina, won Third Prize, home hobbyist, and \$500 in Dremel tools with a three-wheeled motorcycle.



Third Prize, professional, and \$500 in Porter-Cable tools went to George F. Campbell, Philpot, Kentucky, for building this P-40 Mustang fighter.



Third Prize, junior craftsman, and \$500 in Meisel Hardware merchandise went to Joseph Reising, a young Des Moines, Iowa, reader, with his mini sports car.

Citation and special award winners

Best use of wood. Jack Dalton, Jackson, South Carolina; \$300 Campbell Hausfeld HVLP spray system.

Best model. Bill Jorritsma, Yucaipa, California; \$185 in clamps from American Tool Company.

Best pull toy. William E. Fischer, Norfolk, Virginia; \$300 in various MLCS woodworking products.

Best clear finish. Dee E. Cook, Lawrenceville, Illinois; \$250 in Formby's finishing supplies.

Best painted, dyed finish. William E. Fischer, Norfolk, Virginia; \$250 in Formby's finishing supplies.

Best educational toy. Howard L. Clements, Knox, Pennsylvania; \$250 in Constantine's merchandise.

Best transportation toy. Art Bartelme, Fort Pierce, Florida; \$399 Vicmarc mini lathe from Craft Supplies USA.

Best action toy. Ronald D. Carter, Geff, Illinois; \$170 in bits and clamps from American Tool.

Best entry/shop class. Mechanicsburg Area Intermediate School, Mechanicsburg, Pennsylvania; \$250 in Delta tools, \$1,000 in 3M supplies, \$375 in clamps and saws from American Tool, \$250 in Klockit merchandise.

GLASSES

Wood stems give

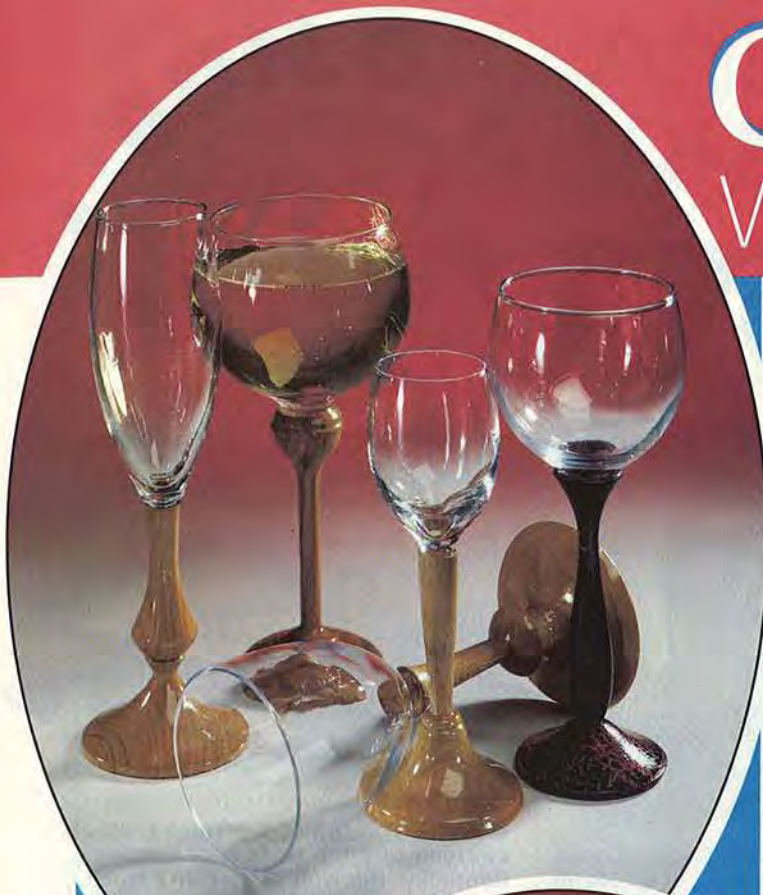

Many turners love making ornamental goblets. Here's a new spin on them that combines a turned stem with a glass bowl. They're not only pretty and practical, they're fast and fun to make, too.

Project prep

Stock: 3×3" turning square approximately 4-6" long, depending on pattern, any species.

Lathe equipment: Chuck or 3-4" faceplate, 60° cone revolving tail center.

Tools: 3/4" roughing gouge, 1/4" and 1/2" spindle gouge, 3/4" skew, parting tool.

Lathe speeds: Roughing, 500-800 rpm; turning, 1200-1500 rpm; sanding, 800-1200 rpm.



First, break some glasses

Before turning the wooden bases, buy some inexpensive glassware and break the bowls off the stems. Starting with the glass allows you to size the hole in the turned piece to fit it. (We paid \$1-\$5 each for a variety of stemmed wine and cocktail glasses, including some acrylic ones, at a decorative-imports store.) Here's how to break the bowl from the stem without bloodshed. Wear eye protection throughout, of course.

1 With a small triangular file, scratch a mark on the glass stem about 3/8" below the bottom of the bowl, as shown *opposite page, photo A*.

2 File a nick all around the stem at the mark. It only needs to be deep enough to scratch the surface. Or, you could grind around the stem with a fine, sharp-edged abrasive stone in a handheld rotary tool. Wear a dust mask if you do this.

3 Drape a towel or shop rag around the glass. Then, holding the glass by the bowl and the stem, place your thumb behind the nick as shown *opposite page, photo B*, and gently snap the stem at the nick. A sharp rap with the file handle will break it, too.

4. If you have acrylic stemware, saw through the stem with a coping saw or a fine-toothed backsaw.



Print this article

with a turner's touch

special sparkle to glassware

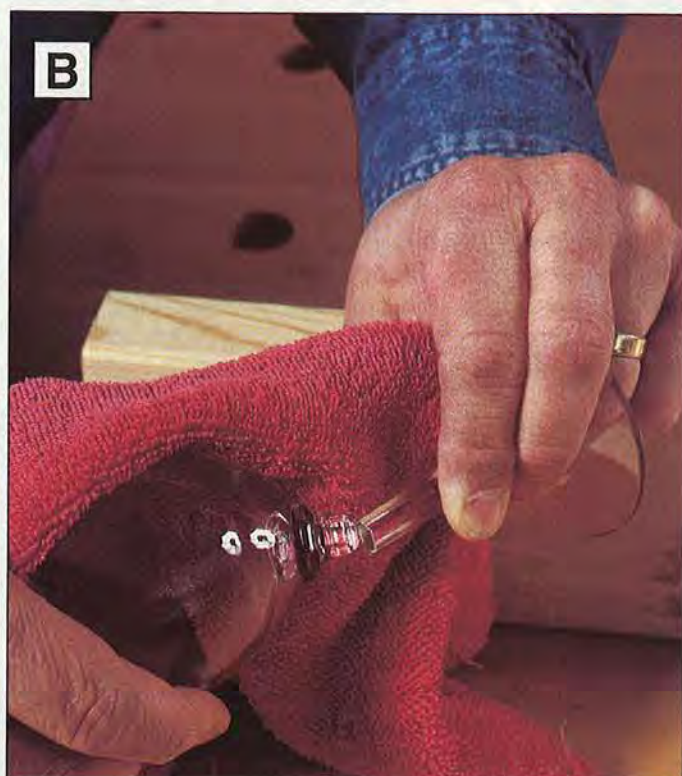
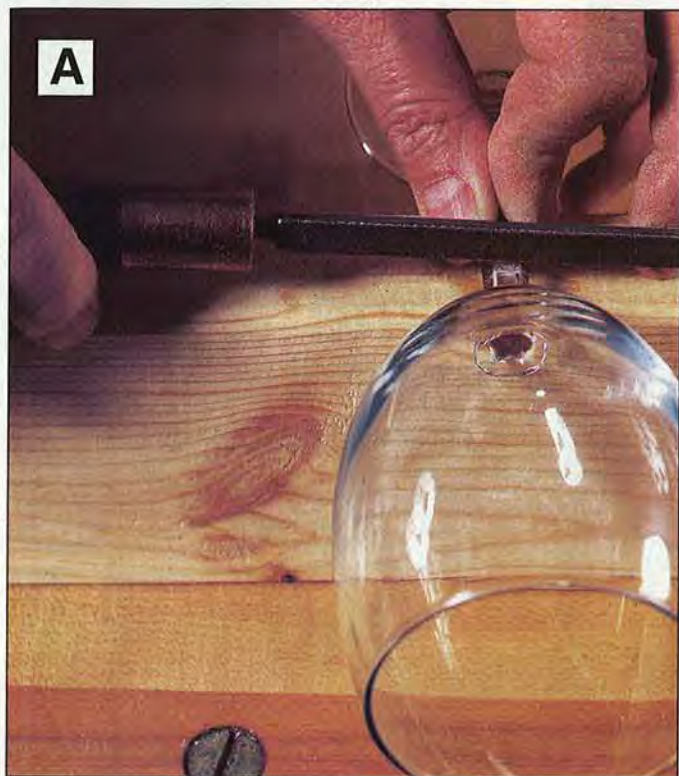

A Score the glass stem all around with a file. Support the stem with a scrapwood block.

B A sharp rap along the scored line or a quick snap breaks off the stem cleanly.

Then, turn bases for them

1 Locate the center on each end of a piece of 3×3" stock of the length shown for the base you're turning. (See the Full-Size Half-Patterns in the *WOOD PATTERNS*® insert in the middle of the magazine.) For a design of your own, make the blank about 1½" longer than the turning's finished length.

2 Measure the diameter and length of the stem stub on your glass. Bore a hole of that diameter and depth in one end of the blank. Use a drill press, and clamp the blank to a vertical fence to ensure a true hole.

A few of our glasses fit neatly into a straight ⅜" hole. But decorative beads or fillets where the stem joined the bowl on other glasses dictated counterboring or tapering the hole in some blanks. A hand-held rotary tool and carving bits proved useful for fitting bowls to

holes. The half-patterns show several hole configurations we used.

3 Mount the blank between centers, supporting the bored end with a 60° cone center in the tailstock. The shoulder of the hole should seat against the cone, as shown in the Tailstock drawing. Round the blank down to its largest diameter.

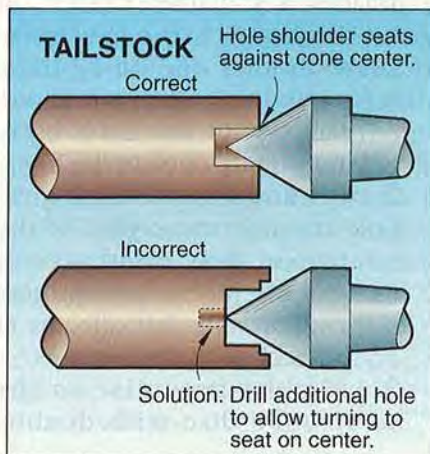

4 Mark the overall length of the stem turning on the rounded blank, measuring from the tailstock end. With a parting tool, cut in to about 1" diameter on the headstock side of the mark. Form a tenon at the headstock end to fit into your lathe chuck. If you don't have a chuck, turn a 1" tenon 1" long at the headstock end of the blank. Dismount the workpiece.

5 Mount your chuck on the headstock, and grip the blank in it. Bring up the tailstock and cone center to center the turning.

If you don't have a chuck, attach a piece of scrapwood about 1½" thick to a 3-4" faceplate. Mount the assembly on the lathe, then round the edge and true the face. Bore a ⅜" hole 1½" deep in the center. Carefully enlarge the hole until the tenon on the blank fits snugly into it. Press the tenon into the hole,

Continued.

GLASSES

then bring up the tailstock to center the workpiece.

6 Referring to the half-pattern for the design you've chosen, mark locations of the turning's major features on the blank. With the parting tool, cut into the workpiece at each point, establishing a diameter of the dimension shown plus $\frac{1}{16}$ ".

7 Employing spindle gouges and a skew chisel, turn the blank to rough shape, with the diameters about $\frac{1}{16}$ " oversize. Then, make a final light cut, preferably with freshly sharpened tools, to bring the stem to finished dimensions.

It's nearly time for a toast

1 Sand the turning with progressively finer grits from 100 to 320. After sanding the rotating turning with each grit, shut off the lathe, and sand with the grain to minimize cross-grain scratching.

2 Part off the turning at the bottom of the base. Cut in with the parting tool, aiming the tool slightly toward the tailstock to form a concave base. (This helps the turning sit without rocking.)

3 Apply a finish of your choice. We sprayed gloss polyurethane varnish on our bases, except one. That one received a dark red crackle finish, using a kit purchased from a craft-supplies shop. Mask the hole when applying the finish.

4 Glue the glass bowl into the stem hole with slow-setting epoxy adhesive (it's waterproof). To align the glass bowl, place the assembled stemmed base and bowl on a level surface, stand back, and sight across the top of the glass to another known level surface in your shop. View it from several sides.

Form the glue squeeze-out into a bead or fillet around the base of the glass. Wipe away the excess.

5 In use, hand-wash and dry the glasses, holding the top downward to keep hot, soapy water from running down the outside into the glued joint. Wipe the base and stem with a damp cloth.



Here's a method for making a wooden base and stem like the one shown above without using a lathe or turning tools. Start by breaking a glass, as described earlier.

Saw and sand the base

1 Draw a 3"-diameter circle on $\frac{1}{2}$ "-thick stock for the base. Draw another one on $\frac{3}{4}$ "-thick scrapwood to make a workholder. Bandsaw or scrollsaw both, staying slightly outside the line.

2 Drill and countersink a $\frac{3}{8}$ " hole through the center of the scrapwood disc. Insert a $\frac{3}{8}$ " \times 2" flathead machine screw through the countersunk face. Secure it on the back with double nuts.

3 Affix the base disc to the scrapwood disc with double-



faced tape, putting the tape on the side that will be the bottom of the base. Chuck the assembly in your drill press.

4 With the drill press running, sand the edge of the discs true and round, using a hand sanding block or a sanding disc chucked in a portable drill. Then, sand the face to the pattern contour, as shown in *photo A*. Finish-sand with progressively finer grits from 100 to 320. Mark the center of the base by holding a pencil against the center of the spinning disc.

Shape and sand the stem

1 For the stem, mark the center on each end of a $\frac{3}{4}$ " \times $\frac{3}{4}$ " \times 2 $\frac{3}{4}$ " piece of stock. With your drill press, bore a $\frac{3}{8}$ " or $\frac{1}{2}$ " hole (depending on the stem diameter of your glass) $\frac{1}{2}$ " deep in the end that will be the top of the stem. Push a dowel center into the hole, as shown in *photo B*. The center will serve as a bearing when shaping the stem.



A

After trueing the edge, sand the face of the base to shape. A disc sander chucked in a portable drill would do the job, too.

A dowel center serves as the lower bearing for sanding the stem. The point fits into the hole indicated by the arrow.



C

Sand or file the stem to shape. Chamfer the corners of the blank first to make the job go faster.



B

2 Clamp a piece of hardwood scrapwood (maple or birch would be a good choice) to the drill-press table. Chuck a $\frac{1}{16}$ " bit in the drill press, and drill a hole about $\frac{1}{4}$ " deep into this auxiliary table.

3 Change to a $\frac{1}{4}$ " bit in the drill press. Stand the stem blank on the auxiliary table, the point of the dowel center in the hole. Drill $\frac{3}{8}$ " deep into the center of the blank. Drill

to the same depth in the center of the base.

4 Glue a $1\frac{1}{2}$ " length of $\frac{1}{4}$ " dowel rod into the hole in the stem.

5 Using knives, planes, or other tools, cut away the corners of the stem blank, and roughly taper it.

6 Cut a 1" disc from $\frac{1}{8}$ " hardboard, and drill a $\frac{1}{4}$ " hole through the center. Slide the hardboard washer over the

dowel, then chuck the dowel in the drill press. Extend the drill-press quill to engage the dowel center's point in the auxiliary-table hole. Lock the quill.

7 With the drill press running at a low to medium speed, sand the stem to shape, as shown in *photo C*. Contour it initially with coarse sandpaper, then follow up with progressively finer grits for finish-sanding.

8 Remove the hardboard washer, and trim the dowel to $\frac{5}{16}$ " long. Glue the dowel into the hole in the base. (We used moisture-resistant woodworker's glue.) Ensure that the stem stands straight.

9 Allow the glue to cure, then apply a durable clear finish. Glue the glass bowl into the stem, as described under the heading "It's nearly time for a toast." ♣

Project concept: Mark Reschke
 Turnings by Rus Hurt; Larry Johnston
 Photographs: Marty Baldwin;
 Hetherington Photography
 Illustrations: Roxanne LeMoine;
 Lorna Johnson

Popular Playthings

Throughout history, woodworkers have played a major role in toy production. Here are some of their wooden marvels that live on today.

Historians disagree about when the first “toys” appeared. Primitive peoples, say authorities such as Richard O’Brien (*The Story of American Toys*, Abbeville Press, 1990), had little time to create playthings for their children. A dried gourd served as a rattle to amuse a baby. A child-size bow allowed a boy to learn the hunter’s ways.

Archaeologists, though, attest to the fact that as societies grew more civilized, toys as we think of them became more prevalent. Most toys, such as the ones you’ll read about here, began in wood.

The English called them babies

Although remains of small clay figures that appear to be dolls have been excavated from Egyptian tombs of 2000 B.C., anthropologists believe them instead to be offerings to the gods. In classical Greece and Rome, however, dolls were plentiful. A most elaborate wooden doll, her body sculpted and fitted with movable limbs joined by pinned sockets, was discovered in the coffin of a young girl in Rome. It was traced to the second century B.C.

Little is known about dolls or toys in England and France before



So-called Dutch dolls of wood were exported from Holland to England, Europe, and America. Sold at prices almost everyone could afford, they could be dressed as the owner chose.

the 15th century. Then, trade with Germany introduced a number of wooden toys, dolls among them. By Queen Elizabeth’s reign in the 1550s, dolls, or “babies” as people called them, were so popular that Sir Walter Raleigh brought many with him on his explorations to the New World as gifts for the natives of Virginia.

In the 18th century, English dolls—with carved wooden heads and lathe-turned bodies—became

the most attractive ever made. These babies were carefully dressed in current fashions.

As the 1800s came, a new type of doll appeared in England. Shown *left*, it was referred to as the Dutch doll because Holland was its primary origin. With a carved wooden head, simply painted features, and jointed body, the Dutch doll was sold in a variety of sizes at reasonable prices for the next 100 years.

Little houses not meant to be touched

Dollhouses as we know them—with roofs, windows, doors, and walls—first appeared in the homes of the English and European wealthy during the late 1600s. Furnished with handmade furniture, silk draperies, and even silver candlesticks, they reflected in miniature the status of their owners, and were usually not meant to be played with.

In the 1800s, dollhouses made especially for children were more commonplace, see photo *opposite top*. They ranged from simple two-room structures destined for tabletops to massive—and costly—showplaces. One dating to Queen Victoria’s time in the 1870s measures over 9’ long, stands 5’2” tall, and has 12 rooms more than 2’ deep. It was made, however, for two brothers, who filled its drawing room with squads of toy soldiers!

France goes crazy over a child’s game

The Renaissance in Europe inspired men and women to all sorts of endeavors, even games. In

from the Past



Dollhouses date back to the 1500s. This one is an 1835 Greek Revival style built for Albertina Shelton Taylor of New York City and called the Shelton Taylor Baby House.

France, a fad for a childish game of skill called *bibloquet* mesmerized the nation for 100 years.

It seems that in 1585, King Henry III developed a passion for this game, which amounted to catching a round wooden ball in a turned, goblet-type cup to which it was attached with a string, *below*. Cup-and-ball took off like a rumor among the ladies and men of court, then spread to the masses and adjoining countries. No one knows why it went out of favor a century later, or can point to another

France's King Henry III started the fad of playing cup-and-ball; it lasted 100 years.

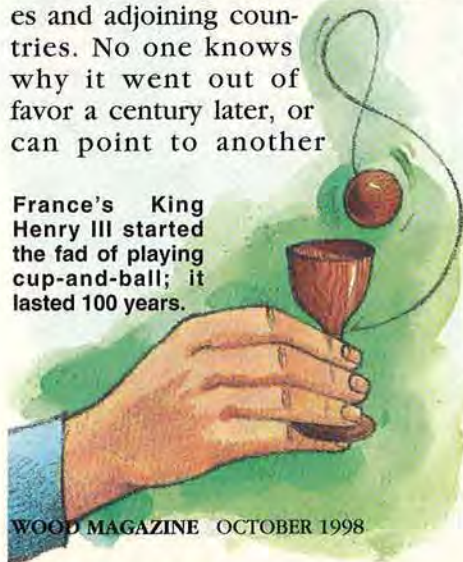

activity that replaced it, but toyshops still carry modern versions of this once immensely popular toy.

Only the law could stop jumping jacks

Another peculiar toy frenzy swept France in the mid-1700s, one not unlike today's Tickle-Me Elmos and Beanie Babies. This was the *pantin*, or jumping jack.

The toy, such as the one *above right*, made of flat wooden sticks similar to tongue depressors, had joints at the arms and legs. By means of a string, the pantins were made to dance and jiggle. People of all classes were intrigued by this puppet, especially when the figures were painted to satirize political figures.

The pantin craze lasted about five years. The government ended it by banning the toy for fear that women would bear babies with twisted limbs like the jumping

French police ended the frenzy for the pantin or jumping jack. It was banned to avoid birth defects.



jack! The little puppet lived on in America, though, as a still well-known folk toy.

Noah's ark was never meant to sail

No one knows for certain where or when the first Noah's ark appeared. But Bavaria in southern Germany, where spruce forests supplied stock for carvers and woodturners who made toys, was a likely source. By the early 1700s, the trade there became so large that 600 tons of toys were exported annually.

The earliest examples of Noah's arks—dating to about 1800—definitely were designed and built as land-based playthings because they had wheels. And they could be had in any size. One in the London Museum has 364 animals.

To produce the animals for Noah's arks in quantity, German woodturners used a special technique. A block of spruce was turned to a ring in the shape of an animal in cross section, then each figure was sawn away from the ring. A carver would then finish shaping the pieces, and a painter would add the colors.

Charles Dickens wrote about the wonders of a Noah's ark in his

Continued

Popular Playthings from the Past

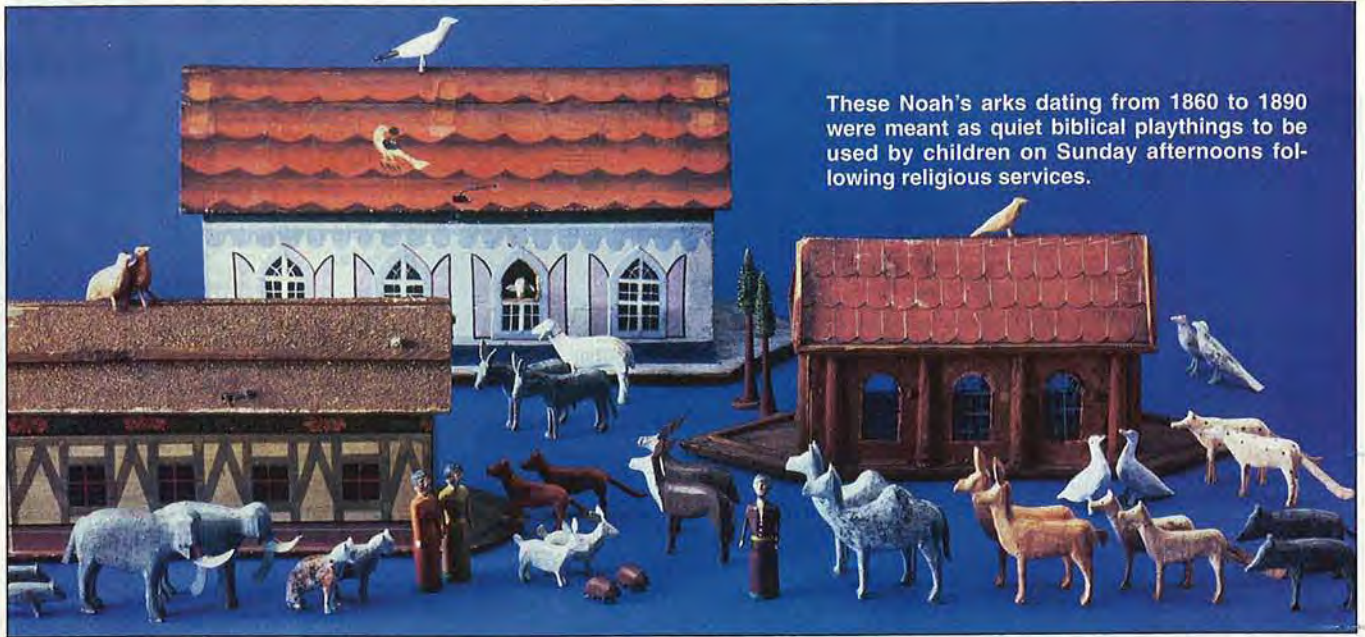

These Noah's arks dating from 1860 to 1890 were meant as quiet biblical playthings to be used by children on Sunday afternoons following religious services.

story *Under the Christmas Tree*. But in the religiously proper time when they became popular, such toys, shown *above*, were probably reserved for Sunday playtimes following church services.

They rode steeds of stable stock

Hobbyhorses, often nothing more than a stick with a crude head, are detailed in early European paintings and woodcuts. Rocking horses also hark from medieval times. However, these were the wooden

first steeds of young noblemen.

Astride them, they began learning knightly tournament and battle skills. The prototypes were nothing more than two slabs of wood joined in an A-shape atop a platform. But by the 1800s the rocking horse at its finest was delicately carved, painted, fitted with real horse-hair manes and tails, then balanced on two curved rockers. Lesser models, *below*, might still be slabs with the bodies rendered in painted outline on their flat sides.



Rocking horses were first built as crude platforms in medieval times. This painted version dates to 1890.

Tops evolved from a long history of revolution

Ancient Egyptians played with tops molded from clay. In Greece and Rome, children played with wooden tops turned on pole lathes. In Renaissance Europe, wooden tops were spun by means of whips.

In the 1800s, a skill game called diabolo was played on both sides of the Atlantic. An hourglass-shaped spool of wood was spun by the manipulation of a string tied between two sticks. Part top, part yo-yo, diabolo is said to have been very difficult to master. ♣



Playing an 1800s skill game called diabolo required a person to use two sticks joined by string to roll a top-like wooden spool.

PORTER-CABLE

BN125	18 ga. bradnailer kit 5/8" - 1 1/4"	89
BN200	18 ga. brad nailer kit 3/4" - 2"	139
CF1400	1 hp pancake compressor	199
CF2400	hp side stack compressor	324
DA250	15 ga. angle finish nailer kit 1 1/4" - 2 1/2"	199
DA250A	15 ga. angle finish nailer kit 1 1/4" - 2 1/2"	238
FN250A	16 ga. finish nailer kit 1" - 2 1/2"	188
FR350	framing nailer w/case 3 1/2" capacity	289
NS100	narrow crown stapler kit 1/2" - 1"	94
NS150	narrow crown stapler kit 1/2" - 1 1/2"	157
332	Quicksand 5" rmdm orb w/stikit pad	62
333	Quicksand w/hook & loop, dustlis	67
335	6" Quicksand w/reversible pad	84
347K	7 1/4" framers saw, 15 amp with case	128
352VS	3" X 21" belt sander dustless w/var sp	174
360	3" X 24" belt sander w/dust bag	218
360VS	3" X 24" belt sander, vs with dust bag	232
362	4" X 24" belt sander w/dust bag	228
362VS	4" X 24" var spd belt sander w/dust bag	238
556	bisc joiner w/case & tilt fence	136
557	deluxe plate joiner kit	104
690	1 1/2 hp router w/1/4" & 1/2" collets	239
691	1 1/2 hp "d" handle router	168
697	shaper table w/ 1 1/2 hp router	232
698	shaper table	134
6931	plunge router base	82
7116	new 24" omnijig	317
7335	5" random orbit sander	138
7518	3 1/4 hp fixed base router-5 speed	288
7539	3 1/4 hp plunge router-5 speed	299
7549	electronic speed jig saw	99
7810	power tool triggered wet/dry vac	266
9444VS	var. speed profile sander kit	118
9862	12v cordless drill kit w/2 batt & case	174
9872	14.4v cordless drill kit w/2 batt. & case	198

INTERNATIONAL



CORPORATION

2590 Davie Rd., Davie Florida 33317

VISIT OUR WEB SITE AT [HTTP://WWW.INTERNATIONALTOOL.COM](http://www.internationaltool.com)

WE ACCEPT
VISA,
MASTERCARD,
DISCOVER, &
AMERICAN
EXPRESS

BUSINESS
HOURS:
MON-FRI 8-5 PM
SATURDAY:
8-12 EST

ALL CHECKS
WILL BE HELD
10 BUSINESS
DAYS

BOSCH

1274DVS	3" x 21" vs dustless belt sander	168
1276DVS	4" x 24" vs dustlss belt sander	224
1278VSK	compact belt sander kit	128
1295DH	5" random orbit sander/polisher	82
1584VS	clic barrel handle jig saw, vs	149
1587AVSK50	50th anniv jig saw kit w/16 blades	156
1613EVS	2 hp var sp plunge router	198
3615K	14.4v cdlis drill kit w/2 batteries	174
3725DVS	5" dustless vs random orbit sander	144

ALUFX

0232SP	18 ga brad nailer 3/8" - 1 1/4"	68
0241NK	18 ga brad nailer 3/8"-1 9/16" kit	96
0249NK	18 ga brad nailer 5/8"-2" w/cs & brads	118
0566T	angle finish nailer 1"-2 1/2"	202
EZ-1	nailer/stapler kit 5/8" capacity	96
EZ-2	nailer/stapler kit	138



636 oscillating triangular sander \$178
Includes case & paper assortmnt
FEIN TURBO II VACUUM \$248.00

DELTA

11-990	12" drill press	183
22-540	12" bench top planer	309
22-560	new 12" portable planer	389
23-710	sharpening center	164
28-280	14" band saw with 1 hp motor	749
31-080	1" belt/5" disc sander	88
31-460	4" belt/6" disc sander	124
31-695	6" belt/9" disc sander	399
31-780	b.o.s.s. oscillting spindle sndr	193
36-800	great white unisaw	1699
37-070	new 6" vs bench jointer	269
37-190	deluxe 6" jointer	499
40-540	16" VS scroll saw	178
40-650	Q-3 scroll saw	449

Panasonic

EY6100EQKW	12V kit w/keyless chuck, 2 ironman bat, charger & case,	184
EY6230FQKW	15.6V cordless kit complete	208

Makita

6095DWE	9.6v cdlis drill kit w/2 bat	129
LS1211	12" compound miter	789
LS1013	10" dual comp miter saw	578

DEWALT

DW423	5" dslis rmdm orb vs sndr, vlcro	84
DW621	2 hp vs dustless plunge router	214
DW682K	biscuit joiner kit	199
DW708	new sliding comp miter saw	645
DW733	new 12 1/2" portable planer	439
DW744	10" portable table saw	524
DW788	new 20" var speed scroll saw	445
DW972K2	12v cdlis kit/w batt & cs	184
DW991K2	14.4v cordless drill kit w/2 bat	204
DW995K	18v 1/2" drill w/batt, chrgr & cs	228

HITACHI

C8FB2	8 1/2" slide compound miter saw	458
C10FC	10" compound miter saw	219
C10FS	new 10" slide comp miter saw	714

POWERMATIC III

15	15" planer	1295
64	1 1/2 hp table saw w.accu-fence	745
66	3 hp, 1 ph 10" t.a. saw w/50" fence	1995
66	5 h.p, 1 ph 10" t.a. saw w/50" fence	2095

freud

JS100	biscuit joiner	94
JS102	bisc. joiner w/var. angle fence	118
FT2000E	3 1/4 hp vs plungerouter	204
LU84M010	10" x 50t atb combo blade	40
LU85M010	10" x 80 t atb for mirror finish!	58
SD508	new 8" super dado set	167
TR215	8 1/2" sliding comp miter saw	238



Most tools under 70 lbs. shipped Fed Ex Express Service for \$9.00... call for details!
FAX US YOUR ORDER AT 1-954-792-3560

1-800-338-3384

• FREE FREIGHT & SAME DAY SHIPPING
ON MOST UPS ORDERS OVER \$50 MINIMUM PURCHASE
WITHIN THE CONTIGUOUS U.S.A.

Circle No. 49

WILLIAM ALDEN COMPANY
WOODWORKING

35 pc Master Drill & Driver System

"The Finest Quality Set We've Ever Seen! We're Proud to Place Our Name on It." - William Alden



NEW
MODULAR
DESIGN

A.

A. Industrial Self-Centering Drill and Driver Set

Self-Centering tool for professional mounting of hinges, brackets, strikeplates, or any object that requires precise alignment.

- Three sizes - #6, #8, #10
- Heavy Duty design with extra strong magnet

- Built-in Hex Key
- Self-cleaning drill bit nozzle,
- Includes:
- Industrial Drill & Driver Shaft with Built-in Hex Key
- #6, #8, #10 Self Centering Drill and Driver Insert
- 3-#2 Phillips Bits



B.

B. Modular Drill & Driver Set

- Pre-Drill, Countersink, Counterbore and drive the screw!
- #6, #8, #10 and #12 sizes included
- Heavy Duty Modular design with extra strong Magnet
- Replaceable Drill bits

- Includes:
- Industrial Drill and Driver Inserts #6, #8, #10, #12
- 1/2" Hex Coupler
- 3-Replacement Drill Bits (3/32", 7/64", 1/8")
- 2-replacement set-screws
- 8 Insert Bits (P1, 2-P2's, P3, R1, R2, 4/5 slotted, 6/8 slotted)



C. Master Screw Guide Pack

- Magnetically Holds Screw
- Extends reach & protects fingers & Work surface
- 2 Sizes - Compact & Long Version Includes:
- Long Version Screw Guide (with P2)
- Compact Version Screw Guide (with P1)
- 6 Insert Bits (2 P2's, 2-6/8 Slotted, 2 R2's)



D. William Alden Mechanical Lead Carpenters Pencil

Includes pencil and tube of replacement leads

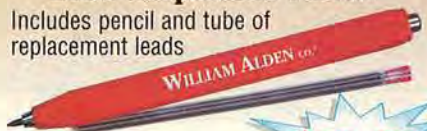

7,000 Product Catalog, \$5⁰⁰ Value FREE with Order

Call 1-800-249-8665 to Order! Mention Code 0156 for Free Shipping 913-111 Master Driver System **\$39.99**

Circle No. 4

AT-THE-READY Drafting/ Reference Center

Keep reference material close at hand with this two-project setup. Simply swing the table up when you need to take a few notes or consult reference material. When you're not using it, collapse the brackets and the table folds back against the



wall. The cabinet, with its drop-down door, provides necessary storage for books, magazines, tool catalogs, and other shop-related papers. Fit the table with an inexpensive stool, and you've created a comfortable workstation. 🌲

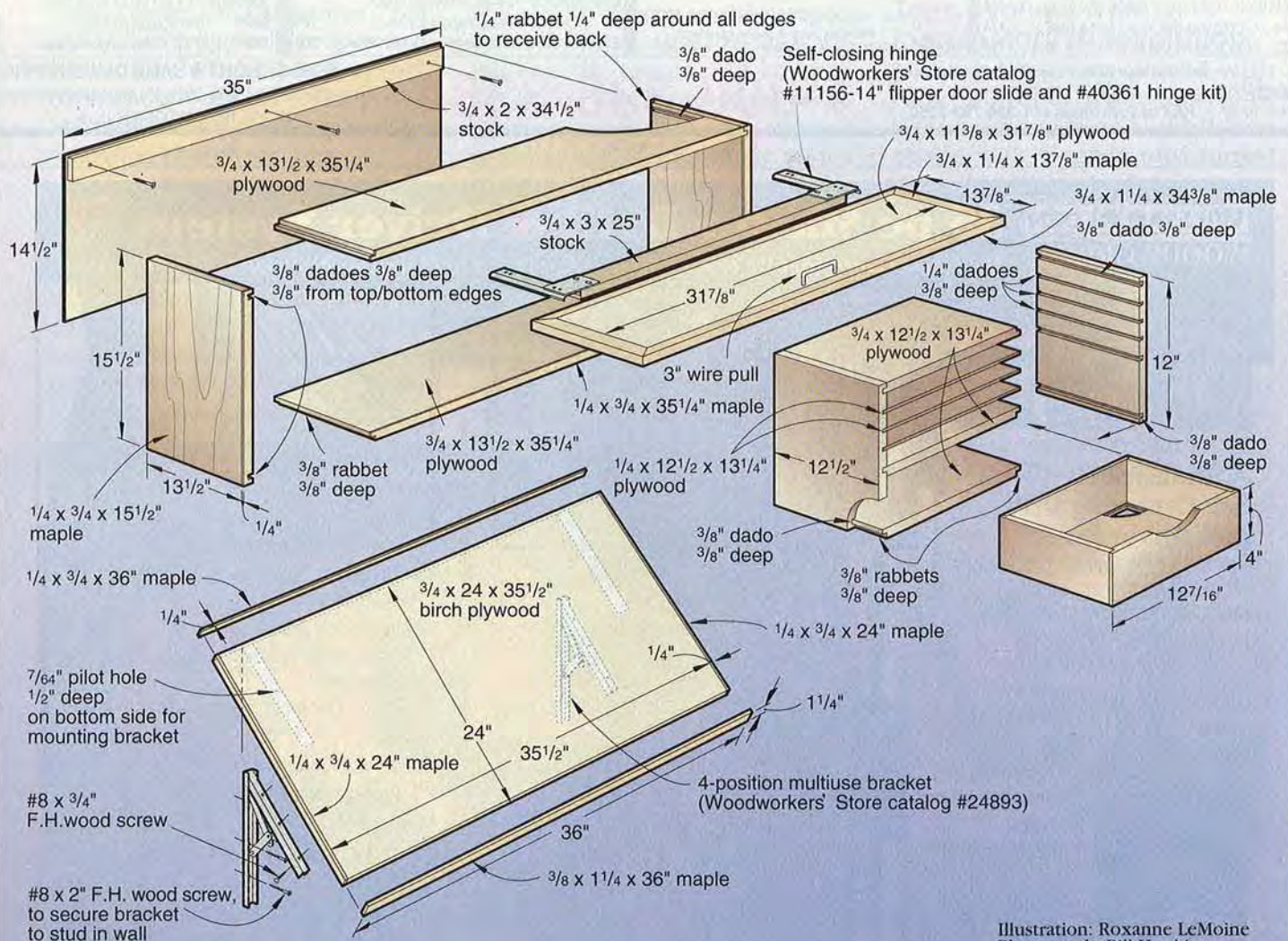

Illustration: Roxanne LeMoine
Photograph: Bill Hopkins



JESADA TOOLS™

Premium router bits made in the United States of America

Mirror-finish grinding makes other router bits obsolete!

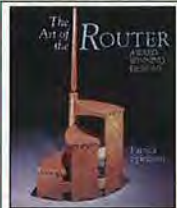

144 pages of color photos, detailed plans and drawings.
AOR-001 \$19.95

By Patrick Spielman, author of *The Art of the Router* and more than 50 other woodworking books. How smooth is the carbide on a Jesada tool? So smooth, so precise and so highly-polished that you'll have to see it to believe it! Jesada bits and cutters were recently tested for the

quality of the carbide surface's finish. The results were comparable to the finest polished glass mirrors, and that's a finish you will not find anywhere in the industry.



655-502
Jesada's 1/2" shank, 2" diameter **Lock Miter Junior Bit** joins wood 3/8" to 11/16" thick.
List: \$84.90
Sale: \$69.40

How does Jesada achieve such a superb finish? It takes a combination of the right tools, the right techniques and above all, patience. Jesada has made a huge investment in the finest grinding equipment available anywhere: the 5-axis computerized grinder. They've equipped these machines with the highest quality diamond grinding wheels. They use only a 100% oil-based coolant as opposed to the more common water-based coolants. And they take their time, lots of time!

The Rabbeting bit shown below is a great



Jesada bits take up to 6 times as long to grind as our competitors' bits, but the difference shows in the performance. Of course, Jesada bits have lots of other features too!

example. This bit takes about 4-1/2 minutes to grind to a mirror finish. Jesada's competitors may take as little as 45 seconds on a rabbeting bit. That may make their bit cheaper than Jesada's, but the difference shows up in the performance of the tool. First, a polished surface allows for a finer cutting edge, so Jesada bits cut cleaner and longer than tools with a more-coarse finish. Second, the highly polished surface sheds most of the pitch and gum that would cling to the imperfections of a coarse surface. Could Jesada grind the bit in 45 seconds? Sure, but they would never be satisfied with the results, and I don't think you would be either.

Is a mirror finish worth all this extra effort? I'm sure that it is, but I think you should convince yourself. Why not try one of the specially-priced sets on this page.

Jesada's **Rabbet-Master Plus™ Set** would be an ideal choice. This set cuts rabbets from 1/8" to 1/2" deep & flush trims as well! The set includes an 1-3/8"-diameter carbide tipped rabbeting bit, seven ball bearings and an allen key.

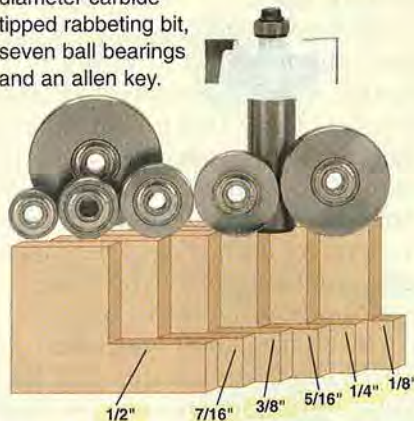

Item	Description	List.	Sale
600-639	1/4" Shank Rabbet-Master Set	\$51.30	\$38.90
600-640	1/2" Shank Rabbet-Master Set	\$53.90	\$39.90

Perhaps you're one of thousands of woodworkers who already have a Rabbet-Master Plus™ Kit, or maybe you just need a different selection of bits. You can evaluate Jesada quality with a money-saving **Three-bit Set**. These sets include three of Jesada's most popular bits at about half the regular catalog price. You'll get a 1/4" radius Roundover, 1/2" diameter Straight and a Flush Trim bit with micrograin car-

bide edges, mirror-finish grinding and Jesada's white PTFE coating.



Item	Description	Reg.	Sale
600-701	1/4" Shank 3-bit Set	\$69.60	\$34.90
600-702	1/2" Shank 3-bit Set	\$72.70	\$36.90

Or choose one of Jesada's **Ply-Groove™ Sets** These sets are the solution to the problem of sloppy plywood joints. Use 23/32" bits for 3/4" plywood, 31/64" for 1/2" and 15/64" for 1/4". Each set includes bits that match up to the real size of 1/4", 1/2" and 3/4" plywood.

Rout joints like this:



Item	Description	List.	Sale
600-624	1/4" Shank Ply-Groove Set	\$61.20	\$45.90
600-625	1/2" Shank Ply-Groove Set	\$65.90	\$49.90

Whatever bits you choose, I think you'll agree that Jesada quality makes old fashioned bits obsolete!

Complete online catalog!

<http://jesada.com>

E-Mail: jesada@packet.net

Call for our Free Catalog



\$5.90 shipping & handling on all orders

To order, call toll-free 24-hours:

1-800-531-5559

Toll Free FAX: 1-800-870-7702

Export orders: (813) 891-6160 FAX: (813) 891-6259

JESADA TOOLS,

310 Mears Boulevard, Oldsmar, FL 34677



In Canada: 1-800-387-7005



In the U.K.: 0800 371822



In Australia: 1300 301335

The color white on router bits is a trademark of Jesada Tools.

Bit Braces and Hand Drills

The original cordless drills

Today we often rely on a portable power drill—probably a cordless one—for making holes. Not too long ago, though, home woodworkers didn't have it quite so easy. Back then, drilling a hole ¼" or smaller usually called for a hand drill and twist bit, like the one shown at left in the photo *above right*. Larger holes were the province of the brace, at right in the photo, and auger bit.

A bit about braces

Bit braces first appeared in Europe in the 1400s, though the underlying mechanics—the principle of the crank—had been known in China centuries before. By the dawn of the 20th century, the brace had evolved to the tool we recognize.

Often termed the American Pattern brace, this type differs from earlier designs in two key elements. The first, the screwed shell chuck with self-centering jaws, came along in the 1860s. The second, a ratcheting drive for the chuck, began to appear shortly thereafter.

The chuck securely grips bit shanks of different diameters, and makes changing them a snap. (Bits for braces typically feature square tapered tangs, shown in the foreground, *above right*.) The ratchet provides continuous circular motion even when the handle swings back and forth through only a portion of its sweep. This allows boring in close quarters and also improves efficiency—a

user can swing the handle in the range that gives the best leverage.

The Stanley brace shown, dating from the 1940s, was ordinarily used with auger bits. But, it could also take other tooling, including twist drills with square taper tangs, countersinks, and screwdriver bits. Virtually identical braces are still manufactured today.

A high-end hand drill

The geared hand drill, an American innovation, arrived on the scene in the 1870s. It soon became standard workshop equipment, and remained so until deposed by low-priced portable electric drills.

The hand drill is a fairly simple machine to use: You turn a hand crank, which is attached to a large wheel. Gear teeth around the large wheel mesh with a pinion attached to the chuck. Typically the chuck makes about 3-5 revolutions for each spin of the crank. This provides faster bit speed—but less power—than a brace.

The hand drill excelled in drilling smaller holes, such as pilot holes for screws. (The hand drill's three-jaw chuck would grip round-shanked twist drills up to ¼", sometimes ⅜".) The high bit speed made drilling through metal easier, too.

The drill shown, a two-speed model made by Goodell-Pratt Co. of Greenfield, Massachusetts, represents the deluxe end of the hand drill range. Sears, Roebuck



and Co. priced this model at \$2.22 in the 1922 catalog. Other hand drills in the catalog ranged in cost from 43¢ to \$1.34. (The best bit brace listed for \$1.77.)

Its two speed ranges—marked fast and slow—give this drill about 4⅔ and 1⅓ chuck revolutions per crank turn. To change speeds, you pull out a spring-loaded knob (shown *below*), rotate it 180 degrees, and let it pop back in. The lower speed range comes in handy for drilling larger holes. ♣

Rotating a pull-out knob changes speeds on the two-speed hand drill.



Photographs: Hetherington Photography
Tools courtesy of F.E. Hanson

FORREST'S BUY ONE & SAVE - BUY MORE & SAVE MORE SALE THRU 11/31/98

Buy any sawblade or dado in this ad and save 10% off the sale price! Buy additional sawblade(s) or dado(s) and save even more! 15%-20%!

Call Forrest now for details — (800) 733-7111 or (973) 473-5236 NEW WEEKDAY HOURS 9 AM - 6PM EST

EXCLUSIVE! FREE OFFER

\$23 Value!

144 pages full of photos! Checklists to help you keep every power tool in your shop working perfectly. A find-it-fast trouble-shooting chart tells you how to identify and fix problems. Easy-to-follow photo sequences show you how to get exact alignment every time.



Published by Popular Woodworking Author - Sal Maccaronc

OR Measure Twice, Cut Once or 300 Great Shop Tips or Forrest Logo cap FREE with any saw blade or Dado listed & purchased from this ad. You must mention you saw this offer in WOOD® Magazine, when ordering.

Offer Expires Nov. 31, 1998. One book per order. **ORDER NOW SUPPLIES ARE LIMITED.**

FREE shipping thru 11/31/98 FREE \$45 in sharpening coupons with each order placed by 11/31/98

Mention Wood® Magazine to receive discount and free coupons and free shipping. Coupons valid thru 11/31/98 and good on all makes of carbide blade and dado set sharpening.

WOODWORKER II—6" - 7 1/4" - 14"

With this one ALL PURPOSE blade you can RIP & CROSSCUT 1"-2" ROCKHARDS and SOFTWOODS resulting in a SMOOTH AS SANDED surface. PLY-VENEERS of OAK and BIRCH will crosscut with NO BOTTOM SPLINTER at moderate feed rates.

- DOUBLE HARD and 40% STRONGER C-4 CARBIDE
- Ends blade changing
- Ends scratchy saw cuts
- Ends second-step finishing
- Ends cutting 1/16" oversize to allow for RESURFACING
- BUY AND SHARPEN 1 BLADE INSTEAD OF 3

5/8" holes, boring thru 1-1/4" add \$7.50. Larger at Time Basis—Shipping \$4.50

WOODWORKER II	LIST	SALE	10%	20%
14"X40TX1"	\$215	\$149	\$134	\$119
14"X30TX1"	\$195	\$139	\$125	\$111
12"X40TX1"	\$183	\$129	\$116	\$103
12"X30TX1"	\$162	\$119	\$107	\$95
10"X40TX1/8" or 3/32"	\$156	\$119	\$107	\$95
30T 1/8" or 3/32"	\$135	\$99	\$89	\$79
9"X40T	\$146	\$109	\$98	\$87
30T	\$125	\$99	\$89	\$79
*8-1/4"X40TX 3/32"	\$136	\$99	\$89	\$79
8"X40T 3/32"	\$136	\$99	\$89	\$79
30T	\$115	\$89	\$80	\$71
7-1/4"X30T 3/32"	\$112	\$69	\$62	\$55
*6"X40T 3/32"	\$136	\$89	\$80	\$71

*NEW for Sears & Makita Table Saws **New For Saw Boss

\$21 VALUE FREE 10" ORANGE PLASTIC BLADE RUNNER-CARRIER! SHIPPED WITH 6", 8" & 10" DADO SETS. HOLDS UP TO 10 BLADES, 5 PER SIDE ON CENTER BOLT OR DADOS.

DELUXE DADO-KING! AS LOW AS \$184 NET AFTER USING SHARPENING COUPONS

WORLD'S NO. 1 DADO - NO CHIP ON PLYS & MELAMINE



C-4 Carbide Tips—4 on each chipper with special negative face hooks. Shims & 3/32" Chipper. Cuts 1/8" to 29/32" wide!!

	LIST	SALE	10%	15%
6" D. 5/8" Bore NEW	\$299	\$269	\$242	\$229
8" D. 5/8" Bore	\$321	\$289	\$260	\$245
10" D. 5/8" & 1" Bore	\$389	\$349	\$314	\$297
12" D. 1" Bore	\$499	\$449	\$404	\$382

(Bore up to 1-1/4" Add \$25 — Plus \$5.50 S&H)

CUTTING PROBLEMS?

Call the factory for FREE technical help!! 1-800-733-7111 973-473-5236

FLASH NEWS!!

OUR \$79 - \$89 30T & 40T OUTPERFORMED (E-EXCELLENT) 23 other 40T & 50T premium blades both foreign & domestic on Ply, Melamine, MDF and Oak/Rip!

Editors' Choice and Top Rating over 18 competing combo saw blades! "The 10"x40T earns our Editors' Choice award for the best performance, regardless of price. The 10"x40T produced super-smooth ripped edges in 3/4 in. pine and oak, with absolutely no saw marks visible to the eye...we also got excellent crosscuts, surpassed only by an 80-tooth dedicated crosscut blade." See American Woodworker April 1998, pp. 64-69.

BLADE DAMPENERS-STIFFENERS

FOR BETTER CUTS on all brands of blades, use our large 1/8" DAMPENERS-STIFFENERS against one side.

4"	\$21
5"	\$24
6"	\$25

7" AND LARGER AVAILABLE
REDUCES NOISE 50%-75%

CHOPMASTER FOR SLIDING COMPOUNDS & MITER SAWS

New specs, 5° Neg. Pts. & flat, runs out less than .002 for perfect, tight, smooth, splinter-free miter joints.

TAKE EXTRA 10% - 20% OFF COMBO SALE!

NEW SIZES AVAILABLE	LIST	SALE
Delta Sidekick 6-1/2"x40Tx5/8"	\$149	\$89
Sears 8-1/4" & Delta 8-1/4"x60Tx5/8"	\$170	\$99
Hitachi 8-1/2"x60Tx5/8"	\$179	\$109
DeWalt 8-1/2" & Ryobi 8-1/2"x60Tx5/8"	\$179	\$109
Delta 9"x80Tx5/8"	\$204	\$119
Ryobi-Makita & all 10"x80Tx5/8"	\$207	\$129
DeWalt, Makita, B&D, Hitachi 12"x80Tx1"	\$229	\$139
Ryobi-Makita 14"x100Tx1"	\$266	\$179
Hitachi 15"x100Tx1"	\$277	\$189

For good general purpose cuts use Woodworker II 30T & 40T or Woodworker I. Use small stiffener where possible.

In Stock Blades made for Special Uses:
• Gang Saws • Panel & Scorer • Picture Frames (Miter-Master)
• Solid Surface • Thin Rim • Plastic/Acrylic (No-Melt)
Also made to order Blades available within 3 weeks, at competitive prices!

THE ONE BLADE THAT LEAVES A SMOOTH-AS-SANDED SURFACE!

SAVE ANOTHER \$45 to \$90 AFTER USING SHARPENING COUPONS

WOODWORKER I - CROSSCUT — 7 1/4" - 14"

For TABLE and RADIAL SAW — 10% to 20%

NON-SPLINTERING PLYS	LIST	SALE
14"x60Tx1"	\$224	\$159
12"x60Tx1" or 5/8" 1/8"K	\$198	\$139
10"x60Tx5/8" 3/32"K	\$162	\$129
8-1/4"X60T	\$150	\$109
8"X60T	\$150	\$109
7-1/4"X60T	\$150	\$109

OTHER SIZES AVAILABLE — 7 1/4" - 14"

DURALINE HI-A/T FOR TABLE & RADIAL SAWS PORTABLE & PANEL SAWS

5/8" HOLES. Boring up to 1-1/4" \$7.50 extra. Larger holes—time basis. Shipping \$4.50. Faster feed rates & absolute splinter control. Stops splintering on OAK/BIRCH PLY VENEERS & MELAMINE

SIZES AVAILABLE	LIST	SALE	SIZES AVAILABLE	LIST	SALE
7-1/4" x 60T x 3/32" K	\$149	\$129	300mm x 100T x 1/8" x 30mm	---	\$197
8" x 80T x 1/8" & 3/32" K	\$202	\$169	12" x 100T x 1-1/8"K	\$253	\$215
220mm x 80T x 1/8" x 30mm	---	\$167	14" x 80T x 1"	\$232	\$197
9" x 80T x 1/8" & 3/32" K	\$207	\$179	14" x 100T x 1"	\$266	\$226
10" x 80T x 1/8" & 3/32" K	\$207	\$159	16" x 80T x 1"	\$262	\$223
12" x 80T x 1-1/8"K	\$212	\$181	16" x 100T x 1"	\$294	\$243

SPECIAL COMBO SALE EXTRA 10%-20% OFF

Above 1" bore standard. CARBIDE IS THE HARDEST OF THE C-4 GRADES AND 40% STRONGER, NOT WEAKER! FOR 50% TO 300% LONGER LIFE.

Standard C-2 Carbide (below, left) and FORREST still sharp Oxidation and Corrosion Resistant Sub-Micron C-4 Carbide (below, right). Each shown after cutting 3,500 feet of MDF. Similar results obtained cutting particle board, melamine, and plywood.



STILL SHARP AFTER 3,500 FEET OF CUTTING!

WE RECOMMEND OUR FACTORY SHARPENING as some local sharpening creates problems with MICRO-CHIPPED EDGES reducing blade life & cutting quality. 2-4 DAYS ON THESE AND ALL MAKES OF FLAT FACE & CONCAVE CARBIDE TIP SAWS. Ship via UPS. Typical 10x40T \$17.00, 60T \$19.00. Add return UPS \$5.00, \$1.00 each additional blade.

FOR SPECIAL PRICE COUPONS MENTION WOOD® MAGAZINE. PHONE TOLL FREE! 1 (800) 733-7111 (In NJ: 973-473-5236) FAX: 973-471-3333

CANADA SALES: C/MR RON COLLIER 3644 SCHUMANN RD. BAY CITY, MI 48706 800-229-4814 517-684-0402 FAX



WESTERN CANADA: CALL EUROPEAN SHARPENING 403-287-0850 403-287-1622 FAX

BUSINESS OPEN ACCOUNTS AVAILABLE



FL, NJ, NY Residents Please Add Sales Tax Shipping Charges with book: Sawblades \$9; Dado \$10; Stiffener \$2 SATISFACTION GUARANTEED OR FULL CASH REFUND.

Fine American saw making & sharpening since 1946. DEALER INQUIRIES WELCOME

(800) 733-7111 or (973) 473-5236

FORREST MANUFACTURING COMPANY, INC. • 457 RIVER ROAD, CLIFTON, NJ 07014 • FAX (973) 471-3333

It's our birthday, but

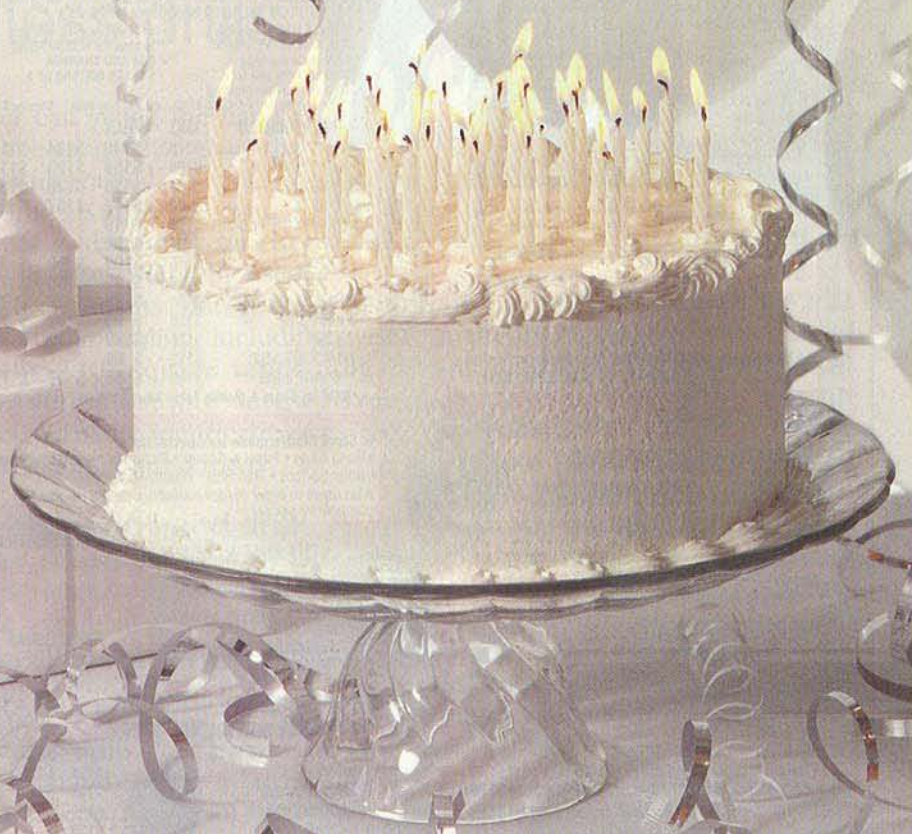

We're celebrating our 40th birthday,
and for a limited time, we're packaging
our best-selling woodworking tools
with the accessories you want,
priced to save you up to 71%.*

We've wrapped these Limited Edition



tools in the rich white of JET's distinctive
industrial metalworking machinery.

They are a reflection of the pride we
take in the beauty of a well-crafted
tool. There's a package with your name
on it at your local JET dealer.

Call (800) 274-6848 or visit www.jettools.com for a catalog or the name of a JET dealer near you!

* Savings vary by tool.

you get the presents!



6" Jointer
with two sets
of blades: \$499
Save \$71.91

14" Bandsaw
with rip fence and
mitre gauge: \$569
Save \$64.48

3HP 10" Tablesaw
Both left- and right-tilt XACTA
saws with table and legs: \$1,399
Save \$178

1200 CFM
Dust Collector
with 5 micron bag: \$399
Save \$70.93

15" Planer
with enclosed stand
and rollers: \$1,199
Save \$150

16 1/2" Drill Press
with mortise attachment
and 5-piece chisel set: \$439
Save \$88.48



Easy-to-use Slip Stop limits Forstner bit depth

Forstner bits pose a problem when it comes to setting a positive stop for hole depth. You can limit drill-press quill extension, but that calls for a lot of figuring if, for instance, you want to drill same-depth holes in stock of different thicknesses. Now, the Slip Stop provides a simple, effective way to limit depth.

I found it a snap to install a Slip Stop on a bit and adjust it. First, from the several collets provided I picked the one that fit my bit shank. (Each stop comes with a blank collet, too, that you can drill to fit an odd-sized shank.) Then I slipped the stop onto the bit, slid the collet into the stop body, and screwed on the brass nut. Fine

adjustments also proved easy—loosen the brass nut and move the stop up or down the shank.

A slip clutch allows the three spinning arms to stop as soon as they contact the workpiece. This prevents marring the surface, as well as letting you know you've reached the desired hole depth.

Slip Stops come in six sizes for bits from 5/16" to 2 1/8". The bright yellow stops appear to be well-made from brass and high-quality plastics, and worked flawlessly in my tests. They're available individually, in a set of six, or in a kit with six stops and two quick-change hubs—the best value, in my estimation, for home-shop use.

—Tested by Larry Johnston



PRODUCT SCORECARD

Slip Stops for Forstner bits	
Performance	★★★★★
Price	About \$10 each; kit, about \$30; set, \$50, plus shipping
Value (Kit)	★★★★★
Woodworker's Supply, 1108 North Glenn Rd., Casper, WY 82601-1698, call 800/645-9292, Fax 800/853-9663.	

Compact belt sander proves powerful performer in tight spots

Bosch's new 1278VS compact belt sander takes care of such a variety of sanding chores so effectively that it practically makes this most tedious operation in woodworking enjoyable.

The 1278VS sands right into corners, angles, and recesses, under or behind obstructions, and along edges. And while it reaches into all these tight spots with the ease and agility of a detail sander, it sands with the aggressiveness of a belt sander.

A key element in this kind of versatility is the 3/16"-diameter roller at the sanding head's tip. This small tip, together with the head's 40° angle, gets the 1 1/2"-wide sanding belt into places unreachable by other belt sanders. The tip extends about 1" beyond the end of the machine. You can sand flush against one side, on either the top or bottom of the belt, and at the tip.

I found this versatile sander easy to handle, too. The 15"-long housing allows a one- or two-handed grip. An auxiliary side handle can be attached, too. The on-off switch sits conveniently on top of the housing. The speed adjustment knob is at the back.

The powerful sander can remove lots of material quickly at maximum speed. Turn to a lower setting on the infinitely variable speed control, and you can sand more delicately. In the shop, I rounded corners with a speed setting of 2 1/2 to 3. For work outdoors on a deck railing, I turned it all the way up to 5. In all cases, I found the tool very controllable.

The belt tracks well, even under heavy pressure. Tracking adjustments are easy, with a single-knob

control. It's easy to remove the belt, too; a single lever releases two idler rollers, and the belt slips right off the side. A dust port at the back of the housing works effectively when connected to a shop vacuum or dust collector.

When I placed the sander in its optional stand (as shown), it became even more useful. The stand—a table, in function—clamps to your bench in any of three positions. An adjustable fence fits in either of two positions and you can sand on either face of the belt, giving lots of options for sanding small parts. If you buy one of these compact belt sanders, I recommend you buy the stand, too, to take full advantage of the tool.

—Tested by Bob McFarlin



PRODUCT SCORECARD

Bosch 1278VS Compact Belt Sander	
Performance (with stand)	★★★★★
Price	With auxiliary handle, case, and ten belts, about \$140; stand, about \$35.
Value	★★★★☆
S-B Power Tool Co., 4300 W. Peterson Ave., Chicago, IL 60646-5999. Call 773/286-7330. Internet: http://www.boschtools.com	

Continued on page 98

TOOL CRIB

OF THE NORTH



DEWALT
High Performance Industrial Tools

PRICE GUARANTEE
Best Price That We Can Get

Save \$60.00 Off New!

12-1/2" Portable Thickness Planer DW733R

\$369^{95*}

Save \$70.00 Off New!

10" Portable Table Saw DW744R

\$429^{95*}

Save \$100.00 Off New!

12" Sliding Compound Miter Saw DW708R

\$549^{95*}

FREE CATALOG!

Our full color 100 page catalog features our most popular selling tools at the lowest prices!

1-800-582-6704

DEWALT
High Performance Industrial Tools



20" Variable Speed Scroll Saw DW788R

\$349^{95*}

Save \$50.00 Off New!

*Items are Factory Reconditioned to Perform Like New, With the Same Warranty as New!

Save \$20.00 Off New!

DEWALT

5" HD Random Orbit Palm Sander DW421R

\$54^{95*}

Save \$50.00 Off New!

DEWALT

18 Volt, HD Cordless Drill/Driver Kit DW995KR

\$179^{95*}

Save \$20.00 Off New!

DEWALT

HD Plate Jointer Kit w/Case DW682KR

\$169^{95*}

Save \$35.00 Off New!

DEWALT

7-1/4" HD Circular Saw DW364R

\$119^{95*}

Save \$20.00 Off New!

DEWALT

HD Deck Screwdriver 0-2,500 RPM DW254R

\$69^{95*}

Save \$20.00 Off New!

DEWALT

6 Amp, VS Reciprocating Saw Kit DW304KR

\$99^{95*}

Save \$50.00 Off New!

DEWALT

12" Compound Miter Saw DW705R

\$299^{95*}

Save \$90.00 Off New!

DEWALT

18 Volt, HD Cordless Combo Pack w/2 Batteries DW995KS-2R

\$299^{95*}

Save \$45.00 Off New!

DEWALT

12V, 3/8" VSR Drill/Driver Kit w/2 Batteries DW972K-2R

\$139^{95*}

Save \$60.00 Off New!

DEWALT

14.4V, 5-3/8" Cordless Saw Kit DW935KR

\$169^{95*}

Save \$70.00 Off New!

DEWALT

14.4V, HD Cordless Combo Pack w/2 Batteries DW991KS-2R

\$269^{95*}

Save \$50.00 Off New!

DEWALT

18V, 5-3/8" HD Cordless Saw Kit DW936KR

\$199^{95*}



To Order or for Technical Support, call Toll Free (US or Canada)

1-800-358-3096

Mention Discount Code #71-098

FAX US YOUR ORDER! 1-800-343-4205 • CATALOG REQUESTS! 1-800-582-6704

Visit Our Web Site at <http://www.toolcribofthenorth.com>

Any comparable National ad in this issue. We reserve the right to verify competitors price and stock. Limited to stock on hand.

Box 14040 • Grand Forks, ND • 58208-4040

•• FULL LINE DISTRIBUTOR •• FREE FREIGHT IN 48 CONTIGUOUS USA •• FACTORY AUTHORIZED SERVICE •• ERRORS AND PRICES SUBJECT TO CHANGE ••

100% SATISFACTION GUARANTEED!
*** FREE SHIPPING!**
FOR ALL ITEMS SHOWN BELOW!

HARBOR FREIGHT TOOLS



ORDER FROM OUR WEB SITE FOR EXTRA SAVINGS!

<http://www.harborfreight.com>

CENTRAL MACHINERY



6" x 12" MINI WOOD LATHE

Create projects from miniature to full-size. Heavy duty, cast iron construction for minimum vibration and high strength. Light weight and compact size allow bench top mounting or taking it on the job. Dual speed range for absolute cutting control.

- Distance between centers: 12-1/2"
- 3-1/8" wide tool rest with adjustable height
- Swing over bed: 6"
- MT1 spindle
- 120V, 60 Hz, 3.2 amp motor
- 25"L x 4-3/4"W x 9-1/2"D
- Speed range - Low: 275 to 3050; High: 400 to 4450

~~\$179⁹⁹~~ **\$129⁹⁹**

ITEM 34837-5FPA

CENTRAL MACHINERY



1" BELT/ 5" DISC SANDER

Remove the belt back plate and sand all types of curves and odd shapes. With the back plate in place, you can apply pressure for faster stock removal.

- Motor: 1/3 HP, 2.4 amp, 60 Hz, 110V, 3450 RPM
- Dust collection
- Table: 5" x 5", tilts to 45°
- Belt length: 30", 3450 FPM belt speed
- Shipping weight: 19 lbs.

ITEM 34951-1FPA **\$49⁹⁹**

DRILL MASTER



TIN COATED FORSTNER BIT SETS

Titanium nitride runs cooler, cuts easier, and lasts longer than standard steel! Includes 3/8" shanks and individually organized wooden case. Rockwell hardness range from 55-65 HRC.

20 PC. SET
 • 20 sizes from 1/4" to 3/4" by 16ths, 7/8", 15/16", 1" to 2" by 8ths
~~\$42⁹⁹~~ **\$32⁹⁹**

ITEM 31130-3FPA

16 PC. SET
 • 16 sizes from 1/4" to 2-1/8" by 8ths
~~\$39⁹⁹~~ **\$29⁹⁹**

ITEM 32404-8FPA

CENTRAL MACHINERY



12" DIRECT DRIVE BENCH TOP DISC SANDER

Get sharp, accurate finishes without burning or marring. Direct drive disc won't slip. Table tilts to 45°; 2" dust collection outlet; fan-cooled brushless motor; miter gauge, base pads prevent creeping; safety switch. Includes 60 grit, 12" sanding pad.

- 1 HP, 120V, 14.0 amps
- No load speed: 1793 RPM
- Wheel diameter: 12"
- Base: 13" x 10"
- Shipping wt.: 92 lbs.

~~\$129⁹⁹~~ **\$99⁹⁹**

ITEM 37297-1FPA

12" SANDING DISCS

GRIT	ITEM	PACK OF 2
36	38001-0FPA	\$5⁹⁹
60	37958-0FPA	\$5⁹⁹
120	37959-0FPA	\$5⁹⁹
240	37960-0FPA	\$5⁹⁹

CENTRAL MACHINERY



10" PLANER

- 2 HP, 110V, 1 phase, 11 amp, 8000 RPM
- 5-1/8" working distance
- 10-1/8" x 9-1/8" feed table
- 19" x 16-5/8" x 16" overall dimensions
- 10-1/8" blade size
- 2-blade cutter head
- 61 lbs. shipping weight
- Stand sold separately

~~\$239⁹⁹~~ **\$199⁹⁹**

ITEM 32377-3FPA

PLANER STAND

- 20" x 10" x 27"
- Shipping weight: 20 lbs.

ITEM 32969-2FPA **\$32⁹⁹**

SET OF REPLACEMENT BLADES

ITEM 32970-2FPA **\$21⁹⁹**

2 PC. HIGH SPEED STEEL REPLACEMENT BLADE SET

ITEM 36068-1FPA **\$29⁹⁹**

Pittsburgh



2 PC. 3/4" HEAVY DUTY PIPE CLAMP

Constructed from heat-treated cast iron, these durable clamps keep your work rock steady. Just screw the handle side onto a 3/4" threaded pipe and slide the spring loaded end on. You're ready to go! Pipe not included.

- Handle screw operating range: 2-1/8"
- 1-1/2" throat depth
- Weight: 2-7/16 lbs.

ITEM 31255-1FPA **\$3⁹⁹**

1/2" PIPE CLAMP

- 1-1/2" throat depth
- Weight: 1-4/5 lbs.

ITEM 37056-2FPA **\$2⁹⁹**



RADIAL ARM SAW KIT

Award-winning patented design features easy setup with most 7-1/4" and 7-1/2" circular saws. Makes fast accurate bevels, rips, miters, and crosscuts. Ruggedly built and completely portable.

- Saw and table wood not included
- Maximum miter & bevel: 45°; Rip capacity: 15-3/4"; Crosscut: 12-3/4"; Length: 24"; Height: 22"; Weight: 23 lbs.

ITEM 33576-1FPA **\$59⁹⁹** **\$49⁹⁹**

CENTRAL MACHINERY



10", 2 HP, BENCH TABLE SAW

Die cast aluminum table 25-3/4" x 16", has adjustable 17-7/8" x 2" rip fence and inch/metric scale for precise cutting. Blade adjustments control angle and depth of cut.

- Maximum depth of cut at 90°: 3-1/8"; at 45°: 2-1/2"
- Shipping weight: 36 lbs.
- Miter gauge adjusts 0° - 60° left and right
- Motor: 2 HP, 115V, 60 Hz, 10 amp, 4500 RPM
- Blade capacity: 10" with 5/8" arbor
- Blade sold separately, below

ITEM 35715-2FPA **\$119⁹⁹** **\$79⁹⁹**

10" 40 TOOTH CARBIDE TIP SAW BLADE

• 5/8" arbor **\$9⁹⁹**
 ITEM 00529-4FPA

CENTRAL MACHINERY



12" BANDSAW

Precision three-wheeled design cuts material up to 12" wide and makes bevel cuts from 0 to 45°. Electronic variable speed from 0 to 2645 feet per minute. Includes miter gauge. Blade sold separately.

115V, Table: slotted cast aluminum: 13-1/2" x 13-1/2"; Work cap.: 12" x 4-5/8"H; Requires 62" blade; Overall dim.: 25"L x 13-1/2"W x 23-3/4"H; Shipping wt.: 32 lbs.

~~\$116⁹⁹~~ **\$89⁹⁹**

ITEM 01629-3FPA **\$4⁹⁹**

BANDSAW BLADE

• 6 TPI
 ITEM 31236-5FPA

CENTRAL PNEUMATIC CONTRACTOR SERIES



18 AND 19 GAUGE AIR FINISH NAILER

Excellent balance and 2-1/2 lb. weight make this brad tacker easy to use in tight spots. With a loading capacity of 105-18 gauge brads, get more done with less down time. Using brads from 5/8" to 1-3/16", it will perform a variety of demanding tasks, from picture frames to solid, homemade furniture.

- Air consumption: 3.5 CFM at 75 PSI
- Uses 18 and 19 gauge brads
- 1/4" NPT inlet

~~\$29⁹⁹~~ **\$29⁹⁹**

ITEM 36618-5FPA

CHICAGO Electric Power Tools

3/8", 14.4 VOLT CORDLESS DRILL KIT WITH KEYLESS CHUCK

- Variable speed, reversible: 0 to 600 RPM
- Includes 6 pc. drill bit set, 6 pc. screwdriver bit set, magnetic extension bit, charger, battery, Jacobs® keyless chuck, and carrying case
- 6 torque settings

~~\$69⁹⁹~~ **\$39⁹⁹**

ITEM 34793-2FPA

29 PC. HIGH SPEED STEEL DRILL BIT SET

Contains 29 jobber length HSS bits from 1/16" to 1/2" by 64ths. • Steel index

• 3/8" cutdown shanks **\$9⁹⁹**
 ITEM 02642-5FPA

* Within the 48 States / \$3.95 handling on all orders. No per item shipping and handling charge.

Call To Order or Ask for Free Catalog:
 Order 24 Hours a Day/7 Days a Week
 Most Phone Orders Shipped in 48 Hours



FAX TOLL FREE: 1-800-905-5220

1-800-423-2567

CHARGE IT!



Or Send Check or Money Order to: Harbor Freight Tools, 3491 Mission Oaks Blvd. Box 6010, Camarillo, CA 93011

FREE SHIPPING!

FOR ALL ITEMS SHOWN ON THESE TWO PAGES!

LOW PRICE GUARANTEE! • PRICES EFFECTIVE THRU 3-1-99

WE'LL BEAT ANY COMPETITOR'S PRICE ON ANY IDENTICAL ITEM - EVEN IF IT'S AN ADVERTISED SPECIAL



CONTROLLED PRESSURE, NON-MARRING HARDWOOD CLAMPS

SAVE UP TO 40%

These hand screws will clamp without scratching or marring your workpiece. Hardwood jaws distribute pressure evenly, and can easily be adjusted for non-parallel surfaces and odd shapes.

JAW LENGTH	JAW CAPACITY	ITEM	PRICE
6"	3"	06986-3FPA	\$2 ⁹⁹
7"	4-1/2"	06987-3FPA	\$3 ⁹⁹
8"	4-3/4"	04852-4FPA	\$4 ⁹⁹
10"	6"	04853-3FPA	\$5 ⁹⁹
12"	8-1/2"	04854-3FPA	\$6 ⁹⁹

CENTRAL MACHINERY



DOVETAIL MACHINE

Just place stock and pull cam handles to positively lock material in place. Allows cutting tails, pins, half blind, and standard dovetails. Accepts stock up to 12" wide and 1-1/4" thick. Includes 1/2" template.

~~\$59⁹⁹~~ \$49⁹⁹
ITEM 34102-4FPA

CENTRAL MACHINERY

DRILL 1/4", 3/8", & 1/2" SQUARE HOLES

MORTISING MACHINE

Make a square hole in the fraction of the time it takes by hand! Easier layout for professional mortise and tenon joints in furniture, cabinets, and restoration projects. Fence with hold down clamp keep workpieces from lifting off the table. Large capacity - up to 5" maximum height. Includes fence, work-piece clamp, and 1/4", 3/8", and 1/2" mortising chisels and bits.

- 10-7/8" x 7-3/4" base • 13-3/8" x 6" table
- 3580 RPM spindle speed
- 60 lbs. shipping wt.
- 5" max. workpiece height • 5" throat
- Accepts .745" chisel shanks
- 1/2 HP, 110V, 2.3 amps

ITEM 35570-5FPA \$149⁹⁹

CENTRAL PNEUMATIC



INDUSTRIAL HVLP SPRAY GUN

Get better adhesion than standard sprayers and save over 40% in paint/material costs. This sprayer maintains 75% transfer efficiency and reduces working pressure to 10 PSI. No need to buy costly HVLP system, this gun does it for you. Low cost, quality finishes, and meets strict state and local environmental codes! Easy to use - well balanced with a textured grip handle.

- 2 position nozzle adjusts spray pattern
- 1 quart cup • Air inlet: 1/4" NPT
- CFM: 9.5 @ 50 PSI
- PSI: 50-70

~~\$79⁹⁹~~ \$59⁹⁹
ITEM 07901-1FPA

CENTRAL MACHINERY

6-1/8" JOINTER PLANER



- 1-3/4 HP motor handles hardwoods, softwoods, and plastics
- Variable speed from 16,000 to 32,000 CPM
- Adjustable fence tilts 45° for precise edging and chamfering
- Heavy duty die cast aluminum table
- Includes safety switch and 1-1/4" I.D. dust collection outlet
- Dimensions: 6-1/4" x 28" table; 28" x 2-5/8" fence
- Capacities: 6-1/8" planing width; 1/8" max. cutting depth

~~\$199⁹⁹~~ \$172⁹⁹
ITEM 34434-2FPA
1 SET REPLACEMENT BLADES
• Includes one pair high speed steel blades for the above planer
\$29⁹⁹
ITEM 34451-1FPA

WE CARRY OVER 4000 ITEMS!
CALL TODAY FOR A FREE CATALOG SUBSCRIPTION!

Chester

CROSSCUT SAW GUIDE



Cut precise angles from 30° to 150°. Perfect for wall studs or roof rafters. Makes trim cuts as small as 1/32".

~~\$12⁹⁹~~ \$8⁹⁹
ITEM 35012-3FPA

CENTRAL MACHINERY

LARGE CAPACITY 22" SCROLL SAW



Perform precise cutting requiring little to no sanding. Smooth action professional machine with all ball bearing construction for minimal vibration and long life. Perfect for the most intricate patterns. Includes dust blower assembly.

- Maximum thickness of cut: 2"
- Table tilt: 0° to 30° left • Throat: 22"
- Includes 5" pin blade
- 110V, 2.2 amps, 1750 RPM
- Ship. wt.: 60-1/2 lbs.

~~\$119⁹⁹~~ \$99⁹⁹
ITEM 36328-3FPA

5" SCROLL SAW BLADE ASSORTMENT 6 PACK
• 10 through 25 TPI \$7⁹⁹
ITEM 01846-2FPA

CENTRAL PNEUMATIC CONTRACTOR SERIES



HEAVY DUTY 16 GAUGE BRAD TACKER

This unit packs extra punch to cleanly drive extra long brads every time. Use for cabinetry and carpentry jobs, also paneling, casings, and other construction applications. Features solid aluminum magazine with sliding cover.

- 60 to 100 PSI • 1/4" NPT inlet
- 3/4" to 2" brad length; 16 gauge
- 100 brad capacity
- 4-1/2 lbs. tool wt.

~~\$89⁹⁵~~ \$72⁹⁹
ITEM 31317-1FPA

CENTRAL MACHINERY

5 SPEED BENCH DRILL PRESS



- 2" stroke, 8-1/4" swing
- Speeds: 620, 1100, 1720, 2340 and 3100 RPM
- 1/3 HP motor moves at 1720 RPM
- Table: 8-1/4" square • 1/2" chuck
- 8-1/4" maximum distance spindle to table
- 22-1/2" high, 47 lbs.

~~\$48⁹⁹~~ \$39⁹⁹
ITEM 05901-4FPA

DRILL PRESS WITH KEYLESS CHUCK
• No more lost chuck keys.
\$49⁹⁹
ITEM 34231-6FPA

HOLE SAW SET



Cut smooth, clean, accurate holes through wood, drywall, or even plaster up to 1" thick! Ideal for plumbers and electricians.

11 PC. HOLE SAW KIT
Includes 8 tool steel cups sized 3/4", 7/8", 1-1/8", 1-1/4", 1-1/2", 1-3/4", 2", and 2-1/2", plus 1/4" and 3/8" mandrels, a 1/4" bit, a hex wrench, & a blow mold case.
~~\$9⁹⁹~~ \$5⁹⁹
ITEM 01263-4FPA

10 PC. LARGE HOLE SAW KIT
Includes cutting cup sizes 2-1/2", 3", 3-1/2", 4", and 5", plus 3/8" mandrell, drive plate, hex wrench, & blow mold case.
~~\$11⁹⁹~~ \$8⁹⁹
ITEM 36222-2FPA

CENTRAL MACHINERY

4" x 36" BELT/6" DISC SANDER



Adjustable belt sands inside and outside curves. Cast aluminum sanding disc features a cast aluminum table that locks in any angle from 0° to 45°. Table can be repositioned for use with belt or disc. Includes: 7-1/2" x 5" cast aluminum table, miter gauge, and adjustable backstop, 4000 FPM belt speed; 1725 RPM disc speed; 1/3 HP, 1725 RPM, 115V, single phase.

LIMITED QUANTITIES
~~\$79⁹⁹~~ \$59⁹⁹
ITEM 05154-6FPA
SANDING BELT CLEANER
• Increase the life of your sanding belts and discs up to 500%
• 8-1/2" x 1-1/2" x 1-1/2"
\$3⁹⁹
ITEM 30766-0FPA

CENTRAL MACHINERY

EVEN TURNS BOWLS



14" x 40" WOOD LATHE

Create beautifully turned pieces of furniture with this four speed lathe. Comes with chuck plate. Mount on your workbench. Motor: 1/2 HP, 110V, 60 Hz, 3.4 amps; Speeds (RPM): 1125, 1640, 2360, and 3450; Swing over bed: 14"; Tool rest: 12" x 3/4"; Distance between center: 40"; Bed: 2 lengths; 1-3/4" steel tubing; Drive: V-belt; Overall size: 57-1/2" x 8-1/2" x 14"; Shipping weight: 88 lbs.

~~\$129⁹⁹~~ \$99⁹⁹
ITEM 31082-6FPA

* Within the 48 States / \$3.95 handling on all orders. No per item shipping and handling charge.

Call To Order or Ask for Free Catalog:
Order 24 Hours a Day/7 Days a Week
Most Phone Orders Shipped in 48 Hours



FAX TOLL FREE: 1-800-905-5220

1-800-423-2567

CHARGE IT!



Or Send Check or Money Order to: Harbor Freight Tools, 3491 Mission Oaks Blvd. Box 6010, Camarillo, CA 93011

Better Homes and Gardens®

WOOD Magazine's 1998 Build-a-Gift™ Contest

You could win this fabulous Dodge Dakota truck or any one of the other sensational prizes by entering **WOOD Magazine's 1998 Build-a-Gift™** contest.

At the same time, you'll be benefiting the Toys for Tots program. Whether you're a hobbyist or a professional woodworker, everyone who enters a project can compete for all prizes.



GRAND PRIZE!
1999 Dodge Dakota



The wood treasures you enter in the Build-a-Gift contest will be auctioned in December 1998.

All proceeds benefit the U.S. Marine Corps Reserve Toys for Tots program. Tens of thousands of dollars have been

raised over the last nine years to purchase toys for less-fortunate children at Christmastime. You, as a woodworking artisan, really can make a difference.

So set aside time right now to plan and build your gift-contest entry. Read the rules and guidelines on the next page and get your entry in by November 30, 1998, and help us help kids.

Entry details are also available on our website, WOOD Online at <http://www.woodmagazine.com>



Build • a • Gift
Help us help kids

The New Dodge
 Bondex PLASTIC WOOD
 DELTA
 DEWALT High Performance Industrial Tools
 Grizzly INDUSTRIAL, INC.
 JESADA TOOLS

KLINGSPOR
 KLOCKIT
 LEATHERMAN
 MLCS Router Bits & Professional Woodworking Products
 Makita
 MEISEL HARDWARE SPECIALTIES
 Milwaukee

PRO-TEK
 RYOBI
 STOREHORSE FOLDING SAWHORSE
 Varathane
 WAGNER
 ZINSSER
 BULLS EYE SHELLAC
 Adams Wood Products

WOOD® Magazine's 1998 Build-a-Gift™ Contest Prizes and Sponsors

All entries will be judged on craftsmanship, originality, durability and finish. Toy entries will include the aforementioned judging criteria with the inclusion of safety, kid-appeal, and play value. Durability will not apply to scroll saw entries.

GRAND PRIZE - Best of Show

- Dodge Dakota Truck - \$16,900 estimated retail value

Best Originality

- Delta \$1,700 Unisaw Model 36-820
- Delta \$800 14" Band Saw Model 28-280
- Flecto Varathane Clear Wood Finish supply valued at \$120

Best Toy

- Grizzly Industrial, Inc. Stationary Power Tools valued at \$2,500

Best Craftsmanship

- DeWALT Tools valued at \$2,000

Best Use of Wood

- DeWALT Tools valued at \$2,000

Best Transportation Vehicle Replica

- Milwaukee Electric \$1,050 Compound Miter Saw Portable Power Tool, Model #6496-6
- Flecto Varathane Clear Wood Finish supply valued at \$120



Best Furniture (medium)

- Ryobi assorted tools valued at \$1,000
- Flecto Varathane Clear Wood Finish supply valued at \$120

Best Clear Finish

- Zinsser \$500 cash award plus \$50 worth of Zinsser's Bulls Eye Shellac

Best Furniture (small)

- Makita \$481 14.4V Cordless Drill Kit

Best Scroll saw Project

- MLCS \$350 Gift Certificate

Best Turning Project

- Meisel Hardware Specialties \$250 Gift Certificate
- Bondex Plastic Wood brand products valued at \$50
- Leatherman \$50 Pocket Survival Tool
- Klingspor's \$30 best-selling 20 lb. box of assorted sandpapers

Best Carving Project

- Klock It \$250 Gift Certificate
- Bondex Plastic Wood brand products valued at \$50
- Leatherman \$50 Pocket Survival Tool



Best Dyed or Painted Finish

- Wagner Spraytech HVLP Sprayer valued at \$189
- Bondex Plastic Wood brand products valued at \$50
- Leatherman \$50 Pocket Survival Tool

Best Doll House Furniture

- Pro-Tech Power, Inc. \$169 Scroll saw
- Bondex Plastic Wood brand products valued at \$50
- Leatherman \$50 Pocket Survival Tool

Best Doll House

- Storehorse, Inc. \$165 in merchandise: Storehorse Folding Sawhorses & Accessories, Store stool, and Store bench
- Bondex Plastic Wood brand products valued at \$50
- Leatherman \$50 Pocket Survival Tool

Best Holiday Home Accessory

- Jesada \$129 Six-piece 1/2" Shank Router Bit set Model #600-504
- Bondex Plastic Wood brand products valued at \$50
- Leatherman \$50 Pocket Survival Tool

Winners of each of the following categories receive all of the prizes below.

Best Educational Toy / Best Holiday Ornament / Best Home Decorative Accessory

- Leatherman \$50 Pocket Survival Tool
- Klingspor's \$30 best-selling 20 lb. box of assorted sandpapers
- Bondex Plastic Wood brand products valued at \$50

Other Contributors:

Adams Wood Products Ltd., L.P.

Prize values given are suggested retail price.

WOOD Magazine's 1998 Build-A-Gift Contest Entry Form

There is a limit of five (5) entries per person. Please provide the following information for each entry submitted.

My entry is best suited for the following category: _____

My entry is an original design. I certify that I have designed and built this project myself. Should my entry win, I agree to cooperate with WOOD Magazine to supply builder's notes and a bill of materials for publication.

Signature _____

Date _____

My entry is built from plans.

Signature _____

Date _____

Name _____

Address _____

City _____ State _____ Zip _____

Phone (_____) _____

Send projects to: WOOD Magazine's Build-a-Gift Contest, c/o Kristi Hasek—Level B, 1912 Grand Avenue, Des Moines, IA 50309

1998 BUILD-A-GIFT PROJECT ENTRY DEADLINE: November 30, 1998

CONTEST RULES

- 1.) No purchase necessary to enter or win.
- 2.) Entries must fit into a box no larger than 2'x2'x2'. The primary material should be wood but may incorporate other materials.
- 3.) For toy entries please follow Consumer Product Safety Commission guidelines: non-toxic wood finishes only; no parts smaller than 1-1/4" square on toys or gifts for children under three years of age; no sharp corners or points; pull strings on children's toys longer than 12" should not have beads or other attachments that could tangle and form a loop.
- 4.) Entries must be received by November 30, 1998. All entries must be postpaid; collect entries will be refused. Attach an entry label, photocopy of an entry label, or a 3-1/2"x5" card with entry information and your name and address to each entry. Up to 5 entries per person allowed. Winners limited to one prize per entry.
- 5.) Projects built from existing plans, and projects built from original designs will be eligible for all prizes.
- 6.) Entry constitutes permission to use winner's name, hometown and photograph for promotional purposes, unless prohibited by law. Employees and immediate family members of Meredith Corporation and co-sponsors and their affiliates and subsidiaries are ineligible. Open to USA residents only.
- 7.) Winners will be selected and notified by mail on or about December 15, 1998 and will receive the prize directly from the

- manufacturer/distributor. For a list of winners, send a separate, self-addressed stamped envelope after January 4, 1999 to BUILD-A-GIFT, 333 N. Michigan Ave., Suite 1101, Chicago, IL 60601.
- 8.) All entries will be offered at an auction under the supervision of Meredith Corporation and all proceeds from such auction will be donated to the U.S. Marine Corps Reserve Toys for Tots program.
- 9.) A panel of representatives from the U.S. Marine Corps Reserve, Meredith Corporation, and woodworking experts will judge all entries on or about December 4, 1998 on craftsmanship, originality, durability, and finish. Toy entries will be judged on craftsmanship, originality, durability, finish, safety, kid appeal and play value. Durability will not apply to scroll saw entries. All decisions of the panel are final.
- 10.) Original design entries: Project must be your own original design and not made from published patterns. A different approach to an existing project could qualify.
- 11.) Winners are responsible for applicable taxes.
- 12.) Best of Show Prize: 1999 Dodge Dakota Truck. Approximate retail value \$16,900. Taxes, license, insurance, registration fees and all other incidental expenses are sole responsibility of winner. Vehicle will be available for winner to pick up from a dealer authorized by Dodge on or about December 30, 1998. No prize substitution or transfer or cash in lieu of prize.

FROM

Better Homes and Gardens®

WOOD MAGAZINE

GET A JUMP

FUN-TO-DISPLAY LAWN ORNAMENTS!



MOOSE
#OFS-1046 (48" high), \$12.95



LARGE SLEIGH
#OFS-1011 (56" long X 35" high), \$12.95
MEDIUM/ SMALL SLEIGH
#OFS-1032
(33" long x 20" high / 11" long x 7" high), \$12.95



TWINKLING CHRISTMAS TREE
#OFS-1030
(65" high X 53 1/2" wide), \$12.95



ANGELIC CHORUS #OFS-1019 (4' high), \$12.95



MR. SNOW
#OFS-1033 (49" high), \$12.95
MRS. SNOW & CHILD
#OFS-1034 (45" high / 30" high), \$12.95



LARGE REINDEER
#OFS-1003 (4' high), \$12.95
MEDIUM/ SMALL REINDEER
#OFS-1018 (28" high / 9" high), \$12.95



FATHER CHRISTMAS
#OFS-1044 (5' high), \$12.95



LARGE POLAR BEAR & CUB
#OFS-1036 (3' high / 2' high), \$12.95
MEDIUM/ SMALL POLAR BEARS
#OFS-1048 (18" high / 6" high), \$12.95



LARGE PENGUINS #OFS-1045 (3' high), \$12.95
MEDIUM/ SMALL PENGUINS
#OFS-1047 (16" high / 5" high), \$12.95

ON THE HOLIDAYS!

SENSATIONAL GIFTS!



NEW!

ROCKING HORSE
TS-1012, \$12.95



TRIO OF QUILT HANGERS
IFS-1008, \$9.95



DOLLHOUSE IN A BOX TS-1002, \$9.95



COUNTRY QUILT RACK
IFS-1004, \$9.95



HEIRLOOM CEDAR AND OAK CHEST
IFS-1009, \$9.95



SEWING CABINET IFS-1013, \$12.95



NEW!

BABY'S FIRST CRIB
IFS-1010, \$9.95

FUN-TO-MAKE, EASY-TO-USE PLANS

Build it better... build it easier with these easy-to-make project plans from the editors of **WOOD®** magazine.

- All projects are fully **SHOP-TESTED** for your guaranteed success
- Exploded-view drawings for quick, accurate assembly
- Complete, step-by-step instructions
- Easy-to-use, full-sized patterns
- Can be completed in a weekend or less

Starting At
Only \$9.95 each!

SPECIAL MULTI-PLAN DISCOUNT!

\$2.00 OFF total order on 2 plans

\$4.00 OFF total order on 3-4 plans

\$6.00 OFF total order on 5 or more plans

100% MONEY-BACK GUARANTEE
All Better Homes and Gardens® **WOOD PLANS®** are fully guaranteed. If you're not completely satisfied, just let us know. We'll give you a full refund or quick exchange.



ORDER TODAY!

No added charges! Postage, handling, state and local taxes are included in prices!
For fastest service, call toll free

1-800-572-9350

or fax your order **1-515-265-2995** 7 a.m.-9 p.m. CST, Monday-Friday
Visa and MasterCard accepted. Please have your order ready when calling.

You may also complete this coupon and send it, along with your check or money order to:
WOOD PLANS, P.O. Box 9255, Dept. WD1098, Des Moines, IA 50306

Name _____
Address _____
City _____ State _____ Zip _____

RUSH THESE PLANS TO ME:

Stock #	Qty.	Plan Name	Price Each

Payment (U.S. funds):
 Check Money Order
 VISA **MasterCard**

Exp. Date _____
 Credit Card # _____
 Signature _____

Sub Total _____
 Less MULTI-PLAN DISCOUNT (if any) _____
TOTAL _____

WOODWORKER'S RESOURCE

You can get useful ideas and product information by mail. Use the envelope in this section to order your choice of literature listed below. Each company mails the catalogs or information directly to you.



POWER TOOLS

A & I SUPPLY—Large selection, very modest pricing, superb service. All UPS orders over \$75 freight-free in Continental USA. Free catalog in USA. **A & I SUPPLY**. Free. Circle No. 1.

SCROLL SAW, CRAFTS & WOODWORKING CATALOG—Our 1998 catalog features Hegner scroll saws, Apollo HVLP sprayers, Zyliss vises and Plano glue presses. **ADVANCED MACHINERY**. \$1.00. Circle No. 3.

THE WILLIAM ALDEN CO.—The catalog everyone is talking about. Power tools, clamps, accessories. All first quality at the lowest possible prices every day! **THE WILLIAM ALDEN CO.** Free. Circle No. 4.

FREE WOODWORKING TOOL CATALOG—Tool Crib of the North's catalog features the finest and most requested woodworking and construction tools available. **TOOL CRIB OF THE NORTH**. Free. Circle No. 6.

TRANSPOWER, CP TOOLS INC.—A fine line of quality woodworking machinery, saws, shapers, planers and more. Send for free catalog. **CP TOOLS INC.** Free. Circle No. 15.

INCA MACHINERY & MULTICO MORTISERS—Complete information on Inca Woodworking Machines and English-made Multico Mortising Machines. Designed for quality, precision work by hobbyists or professionals. **GARRETT WADE CO.** Free. Circle No. 44.

HARBOR FREIGHT TOOLS CATALOG—Carries over 4,000 tool and machinery items, all orders over \$50 are shipped free, lowest prices guaranteed. Free catalog subscription. **HARBOR FREIGHT TOOLS**. Free. Circle No. 46.

INTERNATIONAL TOOL CORPORATION CATALOG—Features the finest tools and accessories at the guaranteed lowest prices. Free freight and same day shipping on most orders. **INTERNATIONAL TOOL CORP.** \$2.00. Circle No. 49.

GRANBERG INTERNATIONAL—Manufacturers of portable chain saw tools—the Alaskan Saw Mill, Mini-Mill, Small Log Mill and sharpening accessories. Mill your own quality lumber! **GRANBERG INTERNATIONAL**. Free. Circle No. 52.

AWARD-WINNING DUST COLLECTION—Air cleaners, dust collectors, cyclone systems, hose, connectors, adaptors, hoods, remote switches, etc. 40-page free catalog. **PENN STATE INDUSTRIES**. Free. Circle No. 75.

HUGE VARIETY OF PENCRAFTING PRODUCTS—Including: 24 kt Kits, lathes, duplicator and templates, wood and finishing supplies. 40-page free catalog. **PENN STATE INDUSTRIES**. Free. Circle No. 75.

PERFORMAX PRODUCTS, INC.—Eleven models with patented features. Abrasive plane dimension, fine finish sand. 200 dealers nationwide offer demonstrations. Reduce hand sanding today. **PERFORMAX PRODUCTS, INC.** \$0.50. Circle No. 78.

RBINDUSTRIES—Hawk scroll saws, Universal wood planers, drum sanders, Panelmaster II, all American made, 5 year warranty. Buy factory direct. Free catalog. **RBINDUSTRIES, INC.** Free. Circle No. 84.

TOOLS ON SALE™—Offers a catalog of over 500 pages of the most popular brands of power tools available anywhere at discounted prices. **SEVEN CORNERS ACE HARDWARE, INC.** \$1.00. Circle No. 92.

PORTABLE SAWMILLS—Convert logs into valuable lumber, whether you're a novice or experience sawyer, using a Wood-Mizer portable bandsaw mill. Personal sawmills start at \$4,495. Send for our catalog. **WOOD-MIZER PRODUCTS**. \$2.00. Circle No. 94.

10 TOOLS IN 1!—Make the most of your workshop space with the easy to use Supershop. Free info pak. **SUPERSHOP**. Free. Circle No. 100.



HAND TOOLS

JAPAN WOODWORKER CATALOG—Woodworkers have discovered the secret of better quality work. 2 year subscription to 88 page catalog. **THE JAPAN WOODWORKER**. \$2.00. Circle No. 190.



PLANS

PLANS! PATTERNS!—Huge assortment of popular, shop-tested designs... over 1,500 full-size patterns! Illustrated catalog plus sample pattern. **ACCENTS IN PINE**. \$2.00. Circle No. 310.

AMERICAN FURNITURE DESIGN CO.—Furniture plans by America's leading craftsmen. 36x48 CAD format and comprehensive instructions. Morris chairs, rolltop desk, 80+ designs. Catalog. **AMERICAN FURNITURE DESIGN CO.** \$3.00. Circle No. 314.

ARMOR CRAFTS—Woodworker's plans and supplies. Over 100 high-quality plans, specialty hardware and other supplies offered by Armor. Catalog. **ARMOR PRODUCTS**. \$1.00. Circle No. 315.

FURNITURE DESIGNS, INC.—Since 1968, foremost designers of plans for fine furniture. Furnish your house, build for customers. Catalog. **FURNITURE DESIGNS, INC.** \$3.00. Circle No. 345.

GATTO PLAN SUPPLY—Realistic and highly detailed plans of classic & antique cars, trucks, tractor rigs, motorcycles, construction equipment, farm tractors, fire trucks, steam engines, jets, and many more designed for beginners to advanced woodworkers. **GATTO PLAN SUPPLY**. \$1.00. Circle No. 355.

COLOR CATALOG OF UNIQUE PLANS—Deck & patio furniture, picnic tables, Adirondack designs, garden benches, arbors, trellises, bridges, wishing wells, children's furniture, futon designs, futon bunk. **SPECIALTY FURNITURE DESIGNS**. \$3.00. Circle No. 445.

TOYS AND JOYS, INC.—Executive wood toys, patterns, parts, wheels for making cars, trucks, trains, construction equipment. New 32-page catalog for the advanced toymaker. **TOYS AND JOYS, INC.** \$1.00. Circle No. 465.

SCROLLSAW PATTERNS—Up to 74" clocks, 300+ patterns, books, clock parts, saw blades, tools, wood, and more. **WILDWOOD DESIGNS, INC.** Free. Circle No. 475.

WOODY GLIDER SWING PLANS AND HARDWARE KITS—Make building a beautiful, high-quality glider swing fast and simple. Brochure. **WOODY™ GLIDER SWINGS**. Free. Circle No. 498.



LUMBER

QUALITY EXOTIC LUMBER—Turning wood, burls, figured wood. Hand selected for your needs. Also manufacturer of pen kits. **BEREA HARDWOODS CO.** \$1.00. Circle No. 510.

STEVE H. WALL LUMBER CO.—Quality hardwoods, plywood, and exotic lumber. Will ship UPS or motor freight, wholesale prices. Catalog. **STEVE H. WALL LUMBER CO.** \$1.00. Circle No. 592.

HARDWOODS—Over 100 quality woods from around the world. Lumber veneer, turning stock. Quantity discounts. UPS or truck shipment. Satisfaction guaranteed. **WOODWORKERS SOURCE**. \$1.00. Circle No. 598.



VIDEOS

FELDER BF 6-3-1 WOODWORKING CENTER—See the versatility and precision of a Felder combination machine on real woodworking projects video for \$10. **FELDER USA**. \$10.00. Circle No. 608.



EPOXIES/ GLUES

REPAIR, REBUILD WITH QUIKWOOD EPOXY PUTTY STICK—Hand-mix, apply, shape. Hardens in minutes. Drill, carve, sand, finish. **POLYMERIC SYSTEMS, INC.** Free. Circle No. 690.



GENERAL WOODWORKING CATALOGS

WOOD, VENEERS, INLAYS, CARVINGS—Plus hardware, glues, finishes, tools, books and more—all 100% guaranteed. Fast, friendly service, too. Where? Constantine's, of course! **CONSTANTINE'S**. Free. Circle No. 820.

THE WOODTURNERS CATALOG—Offers a complete line of pen and pencil kits along with the widest selection of turning tools and supplies anywhere—all at the best prices. **CRAFT SUPPLIES USA**. \$2.00. Circle No. 830.

GRIZZLY INDUSTRIAL, INC.—208 pages packed with thousands of woodworking machines, tools, and accessories—all at unbeatable prices. Catalog. **GRIZZLY INDUSTRIAL INC.** Free. Circle No. 860.

HIGHLAND HARDWARE WOODWORKING CATALOG—Giant catalog of hard-to-find woodworking tools loaded with detailed product descriptions and informative techniques. **HIGHLAND HARDWARE**. Free. Circle No. 870.

WOODCRAFT—Our free catalog features over 6,000 woodworking tools, books, lumber and hardware. Same day shipping and an unconditional guarantee! **WOODCRAFT SUPPLY CORP.** Free. Circle No. 955.

THE WOODWORKERS' STORE—Our catalog helps woodworkers do it right! New products, innovative tools, and hard-to-find specialties. Satisfaction guaranteed! Catalog. **THE WOODWORKERS' STORE**. Free. Circle No. 965.





KITS

QUEEN ANNE KITS—Dining chairs & occasional tables, ready to assemble & finish, plus furniture components—solid cherry, oak, mahogany, walnut. Free catalogue. **ADAMS WOOD PRODUCTS**. Free. Circle No. 1002.



PUBLICATIONS

FREE CRAFTS AND WOODWORKING CATALOG—Over 800 books on woodcarving, furniture making, wooden toys, construction, more. Most \$2.95—\$6.00. **DOVER PUBLICATIONS**. Free. Circle No. 1118.

KLOCKIT.ED—Using our clock projects, your school or organization can develop a program that teaches planning, product design, marketing, & sales. **KLOCKIT.ED**. Free. Circle No. 1130.



SHOP ACCESSORIES

ECON-ABRASIVES—Complete line of sandpapers and woodworking-related accessories, custom-made abrasive belts, any size or grit. Catalog. **ECON-ABRASIVES**. Free. Circle No. 1229.

INDUSTRIAL ABRASIVES CO.—Quality, low-priced sanding belts, discs and sleeves made to your specifications. Associated specialty woodworking items. Catalog. **INDUSTRIAL ABRASIVES CO.** Free. Circle No. 1238.

KLINGSPOR'S SANDING CATALOGUE—64 pages of industrial quality sanding products now offered to the home hobbyist at unbelievable low prices. Included are sanding & finishing machines, industrial sandpaper and shop helpers. **KLINGSPOR ABRASIVES, INC.** Free. Circle No. 1240.

MOISTURE METERS FOR WOOD—Pin-type meters that measure moisture in veneer to logs. Send for free catalog. **LIGNOMAT USA, LTD.** Free. Circle No. 1250.

LUMBER DRYING—Dry your own lumber using our equipment and your insulated chamber. Dehumidification systems from 300 BF to 45,000 BF. Easy to operate equipment offers high quality kiln-dried lumber for pennies per foot. These long-lasting made-in-the-USA units can pay for themselves in one month! Send for free catalog. **NYLE STANDARD DRYERS, INC.** Free. Circle No. 1260.

SUPERGRIT® SANDING/REFINISHING CATALOG & CLOSE-OUT SHEET—Belts, discs (PSA or Hook & Loop), sheets (aluminum oxide, garnet, silicon carbide), rolls, pads, etc. **RED HILL CORP.** Free. Circle No. 1267.



BITS, BLADES, CUTTING TOOLS

ROUTER BITS & SAW BLADES—The only orange one. New products in free catalog—order yours. **CMT USA, INC.** Free. Circle No. 1312.

FREUD—Premier carbide-tipped sawblades, router bits and shaper cutters. A full-line of anti-kickback carbide-tipped router bits. Catalog. **FREUD**. Free. Circle No. 1321.

JESADA TOOLS' FREE CATALOG—Packed with bits, blades, cutters, knives and more; plus accessories, project ideas and safety tips. **JESADA TOOLS**. Free. Circle No. 1335.

PRODUCTION QUALITY CARBIDE TIPPED ROUTER BITS—Large discounts. Also, raised panel door sets, shaper cutters, solid carbide bits, Forstner bits, the Merle Clamp and a variety of woodworking tools and supplies. **FREE** shipping. **MLCS LTD.** Free. Circle No. 1350.

SUPER CARBIDE TIPPED ROUTER BITS AND SHAPER CUTTERS—Offered at the lowest prices for items of such high quality. Catalog. **WOODLINE ARIZONA INC.** Free. Circle No. 1395.



HARDWARE/ WOOD PARTS

FREE WOODCRAFT CATALOG FROM CHERRY TREE!—68 full-color pages of plans, parts, kits and supplies for all skill levels. Clocks, whirrigs, dollhouses, door harps, banks and many more attractive items—plus wooden dowels, pegs, wheels, knobs, & more. Tools, paint supplies, stencils, stamps and much more! Wholesale prices available. Catalog. **CHERRY TREE TOYS**. Free. Circle No. 1420.



INCOME OPPORTUNITIES

RESTORE FURNITURE—Complete system features stripping, repair, finishing, parts duplicating, veneering, resilvering. Wholesale products, free classes. Catalog. **MINUTEMAN**. Free. Circle No. 1661.



MISCELLANEOUS

ANDERSON MANUFACTURING UNDERBED STORAGE DRESSER—Top quality, solid wood, ready-to-assemble kits provide convenient space-saving storage. 3-16 drawers. Starts at \$159. Free 48-page catalog. **ANDERSON MFG. CO.** Free. Circle No. 1795.

HANDMADE PIERCED TIN—80+ page colorful catalog. 100's of designs & sizes, 18 types of metal, do-it-yourself materials, tools, & kits, too! **COUNTRY ACCENTS**. \$5.00. Circle No. 1910.

WIRELESS DRIVEWAY ALARM—An alert sounds in the house when someone enters the drive. Be sure to order our free literature. **DAKOTA ALERT, INC.** Free. Circle No. 1914.

FUTURE STEEL BUILDINGS—Multi-purpose, arch-type structures. Ideal backyard shops & garages. Many models & sizes. Complete kits for the do-it-yourselfer. Free information. **FUTURE STEEL BUILDINGS**. Free. Circle No. 1945.

TRUCK OWNERS, THE ROLL-TOP COVER™ IS QUICK AND EASY!—Secure your truck bed with our retractable tonneau cover. **PACE-EDWARDS CO.** Free. Circle No. 1985.

PLANNING TO BUILD?—We manufacture a complete range of steel buildings, tested and built to withstand wind, snow, rain and seismic conditions. **PIONEER STEEL MFG., LTD.** Free. Circle No. 1986.

STEELMASTER BUILDINGS—The leader in arch-type steel buildings. Ideal for backyard shops, garages and much more. **STEELMASTER**. \$1.00. Circle No. 2030.

RESTORING ANTIQUES?—292-page catalog packed with everything needed for woodfinishing related tools, books. Essential items for antique restoration including brass hardware and lamps. Wholesale prices. **VAN DYKE'S RESTORERS**. \$1.00. Circle No. 2077.

WHOLESALE GLASS BROKERS—High-quality glass shipped to you from the finest manufacturers. Table tops, tempered glass, shelves, beveled glass, tinted, custom shapes; 1/4" to 3/4" thick, etc. Catalog. **WHOLESALE GLASS BROKERS**. Free. Circle No. 2079.

LEGAL IVORY—Virtually identical to animal ivory. Tagua is the nut from a tropical palm tree. Ideal for jewelry, knobs, small turnings, inlay, or scrimshaw. Available in 3 sizes. Send for information. **WOODWORKERS SOURCE**. Free. Circle No. 2090.

PEN AND PENCIL PRODUCTION SYSTEMS—State of the art mini-lathes, all components, including wood, at best prices. **WOODWRITE, LTD.** Free. Circle No. 2098.



CARVING SUPPLIES

ADD VALUE TO ANY WOODWORKING PROJECT—Ultra high speed engraving with stencil pat-

terns insures professional results. Engraves on any surface. **PARAGRAPHS**. \$1.00. Circle No. 2160.

HI-SPEED ENGRAVING—400,000 RPM's. Engrave on wood, glass, metal, eggs. It's as easy as drawing with a pen. No artistic talent needed. Send for information, catalog. **SCM ENTERPRISES**. \$1.00. Circle No. 2165.

WOOD CARVING & WOOD SIGN MAKING MACHINES—Make wood signs and wood carvings easy, quickly and accurately. Signs, gun stocks, decoys or furniture parts. **TERRCO, INC.** \$1.00. Circle No. 2175.

TURNERS AND CARVERS—Largest selection of Henry Taylor turning and carving tools in USA. Also Sorby, OneWay, Foredom, Stewart, Glaser & Sherline. **THE CUTTING EDGE, INC.** \$1.00. Circle No. 2180.

ULTRA SPEED PRODUCTS—The ultimate in precision carving, engraving & inlaying. As simple as tracing lines. Affordable, \$170.00 package, includes everything you need to get going. Video & catalog available. **ULTRA SPEED PRODUCTS, INC.** Free. Circle No. 2185.



WOODTURNING SUPPLIES

WOODTURNING TOOLS, PROJECTS, & SUPPLIES!—Best selection anywhere. Sorby, OneWay, Delta, Glaser. Complete line Sorby turning, carving, and woodworking tools. **WOODCRAFTERS OF OKLAHOMA**. Free. Circle No. 2195.



CLAMPS

MERLE ADJUSTABLE CORNER CLAMP—Adjustable, uniform clamping pressure on all corners. Forces a frame into perfect square. Almost no capacity limitation. Ships with 23 foot reel of steel banding. Aluminum and steel construction. **MLCS LTD.** Free. Circle No. 2250.



CLOCKS

KLOCKIT—The leading supplier of clock-making supplies for over 25 years: Quartz and mechanical movements, clock inserts, dials, easy-to-follow plans and kits for all skill levels. **KLOCKIT**. Free. Circle No. 2335.

CLOCK PARTS CATALOG—Clock parts, kits, dials, hands, tools, hardware, quartz and mechanical movements, inserts, watches, gifts and novelty items. Your satisfaction guaranteed. **S. LAROSE, INC.** Free. Circle No. 2375.



FASTENING PRODUCTS

SQUARE DRIVE SCREWS—Can make your woodworking easier. Over 80 color pages of the best fasteners and other woodworking supplies. **McFEELY'S**. \$1.00. Circle No. 2450.



SHOWS & SEMINARS

THE WOODWORKING SHOWS* MACHINERY, TOOLS AND SUPPLIES**—Hundreds of products for the woodworker demonstrated and sold at discount prices at every "Woodworking Show". In-depth seminars and free workshops on a variety of woodworking topics. Shows are scheduled in 27 cities. Send for free brochure. ***THE WOODWORKING SHOWS. Free. Circle No. 2900.



Continued from page 88

Powerful portable collector aggressively grabs the dust

Most newer power tools come equipped with dust collection ports, but how do you catch the dust from hand tools or tools without ports? Penn State's DC720 Portable Dust Collector might be the answer.

Three quiet fans pull debris into the DC720's 10x20" filter, which pulls out and cleans easily. I put a lot of hours on this machine, throwing dust from finishing- and belt-sanders, mini-lathes, and the fine black dust that comes from polishing aluminum with a buffing wheel. Every time, the filter came clean with just a few shakes and a blast from my air compressor.

The DC720 comes with three clear plastic doors that attach to the metal cabinet and each other with hook-and-loop fasteners. As a test, I positioned these doors to set up a miniature sanding booth in front of the filter. Working inside this

booth, the DC720 caught virtually 100 percent of the dust generated.

Dual 115-volt outlets on the side of the cabinet allow you to plug power tools or a work light directly into it. Because of its portability, I found myself using it all over the shop, even with tools that had conventional dust collection. And its small size makes it easy to store.

—Tested by Bob McFarlin

PRODUCT SCORECARD

Penn State Industries DC720 Portable Dust Collector

Performance	★ ★ ★ ★ ★
Price	\$207.95 ppd.
Value	★ ★ ★ ★ ☆

Penn State Industries, Dept. 962, 2850 Comly Road, Philadelphia, PA 19154. Call 800/377-7297, ext. 962.



Continued on page 106

The Joy of Sanding

Right!? Who would believe a job as tedious and dusty as sanding could be a joy?

Thousands of Performax owners do. With their Performax® drum sander... no more sawdust in their faces, no more high and low spots on their finished pieces.

Imagine the satisfaction of sanding a wide surface (up to 32") to within .010" uniform thickness across its full width. Or sanding stock as short as 2 1/4" without a carrier board or scuffed up fingers. Fantasize sanding to as smooth a surface as you wish without any elbow grease.

Proudly Made in the USA

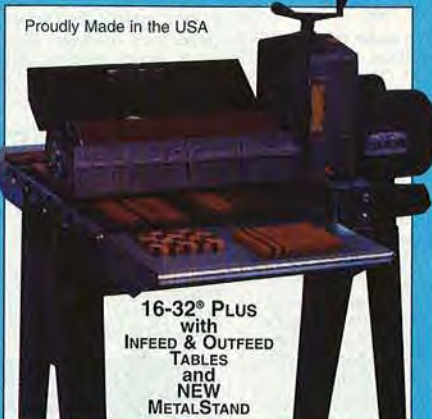

16-32" Plus
with
INFEED & OUTFEED
TABLES
and
NEW
METAL STAND

PERFORMAX
PRODUCTS, INC. X

12257 Nicollet Ave. So.
Burnsville, MN 55337

1-800-334-4910 Fax (612) 895-5485

Make your
woodworking the
pleasure it was
meant to be.
Call us today for
a free brochure
and the dealer
nearest you.

NEW - READY-TO-WRAP ABRASIVES

Circle No. 78

Having Fun Making Money...

A Dream Come True for anyone
who loves to work with their hands

Engraving • Airbrushing • Sandblasting



Keith Hone... a career woodworker now enjoys making money with his Paragraphic Engraving System. Using simple patterns that he just traces and our new ultra-high speed drill (amazing 300,000 r.p.m.) It allows even a non-artist to produce professional results fast and easy.

For your free demonstration video call today!
(refundable deposit required)

Paragraphics
CORPORATION

1-800-624-7415
1455 W. Center Orem, Ut 84057
Financing Available

Circle No. 2160

The Best Place To Buy Your Tools!

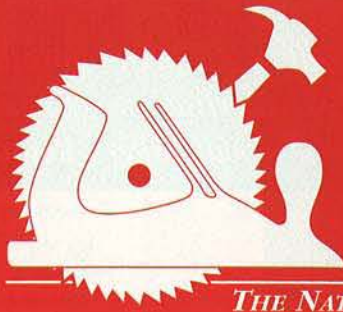

★ THE WOODWORKING SHOWS ★

tools • supplies • education

THE NATION'S PREMIER WOODWORKING TOUR

- ★ Watch live demonstrations before you buy
 - ★ Get answers from factory reps
 - ★ Free Seminars and Workshops
 - ★ See the latest tools and accessories
 - ★ Savings by the truckload

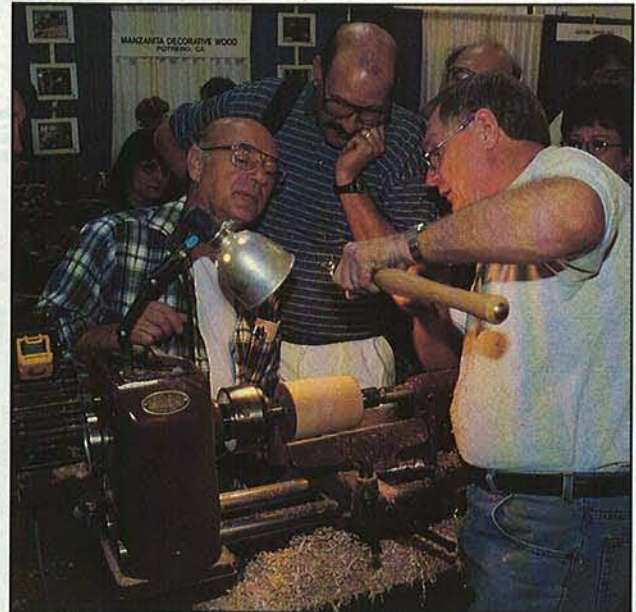

VISIT THE SHOW NEAR YOU!

WINSTON-SALEM
NEW ORLEANS
CLEVELAND
CHICAGO
TWIN CITIES
MILWAUKEE
DALLAS
OREGON

September 11-12-13
September 18-19-20
September 25-26-27
October 2-3-4
October 9-10-11
October 16-17-18
October 23-24-25
Oct. 30-31-Nov. 1

Joel Coliseum
Pontchartrain Center
I-X Center
Odeum
Minnesota State Fairgrounds
Midwest Express Center
Big Town Exhibition Hall
Portland Expo Center

...and 22 Additional Locations

Call for free brochure Monday - Friday, 8:30 am -5:00 pm Pacific Time
1-800-826-8257 e-mail: woodshow@earthlink.net

Circle No. 2900

★ BEALL ★ CMT ★ DELTA ★ DEWALT ★ EAGLE AMERICA ★ FOREST ★ HEGNER ★ INCRA ★ JDS ★ JOINTECH

★ KREG ★ LEIGH ★ MAKITA ★ OLDHAM ★ PERFORMAX ★ PORTER-CABLE ★

★ AND MORE! ★ ZYLISS ★ TORMEK ★ SORBY ★ S-B POWER TOOL ★ RYOBI ★ INDUSTRIES

Woodworker's Marketplace

This section features advertisers offering products by mail. Additional information can be found in the Woodworker's Resource section. Please contact the advertiser directly or use the Circle No. to the right of each ad to request information through the Woodworker's Resource envelope.

 Print this article

FUTURE STEEL
FACTORY-DIRECT WHOLESALE PRICES!!

Call for your FREE Catalog!



Many Models & Sizes Available
Ideal Multi-Purpose Structures
All-Steel 100% Clear-Span Interior

Easy Self-Assembly for the "Do-it-Yourselfer"

1-800-668-5111 ext.1333

Circle No. 1945

Save Money—
saw your own lumber

With a Wood-Mizer!
LT15 Personal Sawmill



- Cut logs up to 28" D. x 9' L.
- Extra bed sections permit longer lengths.
- Easily transportable.

\$4495
(Shown with optional loading ramps)

Free \$2 Catalog*

Wood-Mizer®
8180 West 10th Street Dept. QQ121
Indianapolis, IN 46214-2400
www.woodmizer.com

1-800-553-0219

* With purchase of All Products Video @ \$10

Circle No. 94

WOOD MOISTURE METERS



- For the Woodworker -
Moisture problems such as shrinking or warping can ruin the best piece ever built. Measure the moisture with a moisture meter to be sure the wood is dry. Call for new color brochure.

- Lignomat USA -
Po Box 30145
Portland, OR
97294 -- USA

Lignomat :: 800-227-2105

Circle No. 1250

Installing hinges is easy with our Exclusive Jig-it® Systems!



ONLY \$29.99

Order today at
1-800-403-9736 or call for a
FREE catalog with our complete selection!

www.woodworkerstore.com

ROCKLER
WOODWORKING AND HARDWARE

The NEW name for... Since 1954 "Our commitment to hardware is NOW in our name."
The Woodworkers' Store
Hardware, Wood, Tools & More!®

Department 98083

Circle No. 965

Be a Furniture Restoration Specialist
Discover Minuteman

Complete Shop Concept

Strip • Repair
Touch-Up • Fake Grain
Marbelize • Resilver • Refinish
Duplicate Parts • Repair Frames • Veneer

Why Minuteman?

- Proven, Low-Risk, Cash Return
- Low Start-Up Costs; Expert Training
- Environmentally Friendly System
- Wholesale Supplies
- Handy Sample Kits Available
- Systems From \$1,500-\$11,000
- 28 Years Experience; 3,000+ Shops

No Experience Necessary
◆ Part-Time, Full-Time ◆
Ideal for Men & Women

FREE 2-Day Business Exploration Seminar
No Obligation to buy!
Register Now - Limited Seating!

Call For FREE Catalog
MINUTEMAN, INC.
Ste. 17, P.O. Box 8, Waterloo, WI 53594
1-800-733-1776

Circle No. 1661

www.supergrit.com

Supergrit® SANDPAPER

HOOK & LOOP

4 1/2" 8 Hole	\$12.00/50
5" 5 or 8 Hole	\$12.50/50
6" 6 or 16 Hole	\$16.00/50
5" Solid "E"	\$15.00/50
6" Blue Zirc	\$25.00/50
12" Solid Red Resin	\$12.00/6

BELTS—A.O. RESIN

1 x 30	\$.75	4 x 24	\$1.10
1 x 42	\$.75	4 x 36	\$1.40
3 x 21	\$.85	6 x 48	\$3.50
3 x 24	\$.90	6 x 89	\$6.20

SHEETS—9" x 11", A.O.

60D, 80D	\$14/50
100C	\$24/100
120C, 150C	\$23/100
180A, 220A	\$19/100

3M 4" Diam. Paint & Rust Stripper
Reg. \$7.50 ea.
Sale \$4.50 ea.
2+ \$4.00 ea.

DRUM SANDER
ABRASIVE ROLLS
Hook & Loop
Cloth/Paper
Width 1" to 6"

SAND-O-FLEX
\$20.00



Refills \$6.50 ea./2+

PC PROFILE SANDER SUPPLIES

H&L Diamonds	\$15.00/50
2 1/2" x 5 yd. P.S.A.	Rolls \$4.75 ea./2+

GOLD MIRKA® PSA DISCS
WHITE A.O. RESIN
RHYNO® DISCS as low as \$16.00/100

Grits 60-320

MasterCard
VISA

RED HILL CORP.
P.O. BOX 4234
GETTYSBURG, PA 17325

FREE 48 PAGE CATALOG
& Incredible close-out sheets.

800-822-4003

Circle No. 1267

Steel Buildings

**FACTORY DISCOUNTS
UP TO
\$5,000.00!**

Ideal for:

- Storage of sporting equipment, home improvement supplies, boats and autos
- As a workshop for the do-it-yourselfer
- As a small business location

Limited Time Offer

800/891-6733 ask for ext. 1018

visit our website - www.steelspan.com



ask for ext. 1018

visit our website - www.steelspan.com



Models
Included

- 20 x 30
- 25 x 40
- 30 x 60
- 45 x 75
- 51 x 100
- 55 x 125

other sizes
available



The Japan Woodworker's Catalog is . . .

loaded with the best tools you can get your hands on. In our catalog you will find a huge selection of Japanese saws, waterstones, chisels, planes, carving tools, cutlery and books. Send \$2.00 for our catalog and supplements during the next two years.

THE JAPAN WOODWORKER
1731 Clement E-32, Alameda, CA 94501
Phone 1-800-537-7820

Circle No. 190

The Woodworker's Dream



QUIKWOOD®

**Repair,
Rebuild,
Restore All
Types of
Wood**

- Quikwood® Epoxy...when fillers, putty, or glue won't do:
- Shapes like modeling clay; sets like wood in 1/2 hour
 - Easy to sand/carve, drill/tap, paint/finish
 - Solvent-free; won't stink or shrink!
 - Bonds to wood, metal, masonry, ceramics and most rigid plastics.

FREE BROCHURE AVAILABLE
888-4-FIX WOOD (ext. 2209)
(434-9966)
www.polymeric.com Polymeric Systems, Inc.

Circle No. 690

FREE! CherryTree

Woodcrafting Catalog



See our Lighthouse Birdfeeder & dozens more NEW projects!

- Clocks & Parts
- Whirligigs
- Toys
- Wood Parts
- Craft Supplies & more!

Affordable prices, guaranteed quality & fast delivery!

Check out our WebSite at:

www.cherrytree-online.com

Name: _____
Address: _____
City: _____
State: _____ Zip: _____

Cherry Tree • Box 369-W108
Belmont, OH. 43718-0369
or call **TOLL FREE**
1-800-848-4363 ext. W108

Circle No. 1420

WOODCRAFTERS

OF OKLAHOMA

LARGEST & BEST SELECTION ANYWHERE:

- Turning Tools
- Pens & Pencils
- Turning Blocks & Squares
- Pen Blanks



FREE CATALOG

116 S.E. 74th • Oklahoma City, OK 73149

TOLL FREE 888-333-7513

Circle No. 2195

Make Your Workshop PAY OFF BIG!



**NOW!
Plane, Mold,
Sand and
Saw with
Infinitely
Variable
Power-Feed!**

30-Day Free Trial!

FREE FACT KIT

1-800-821-6651 ext. PW30
WOODMASTER TOOLS, INC., DEPT. PW30
1431 N. TOPPING, KANSAS CITY, MO 64120

MAKE YOUR OWN WIND-POWERED TOYS!

EASY-TO-MAKE WHIRLIGIGS

Anders S. Lunde

Easy-to-follow, illustrated manual features models for whimsical, wind-powered toys: Flying Puffin, Halley's Comet, Colonial Dame, more. Inexpensive to make; only simple tools needed. 112pp. 8 1/2 x 11. 28965-6 Pa. \$7.95



Over two dozen models!

To Order: List title, author, and code number. Add \$5.00 s & h. NY residents, add sales tax. Send to: Dover Publications, Dept. WM, 31 E. 2nd St., Mineola, NY 11501. FREE Dover Crafts and Woodworking Catalog (59111-5) available upon request.

Circle No. 2450

NEW "HYBRID" TRIMMER/MOWER™!

Takes the place of both your hand-held trimmer and steel-bladed mower!

The DR® TRIMMER/MOWER™ rolls *light as a feather*™ on two BIG WHEELS! TRIMS far easier, better, more precisely than hand-held trimmers. Plus MOWS everything from whole lawns (even wet!) to tough, waist-high growth with ease! Rocks, roots, stumps, etc., do it no harm because the "DR®" has no steel blade to bend or dull. Perfect for ALL mowing and trimming around smaller properties, vacation homes, etc., or for finish-up mowing and trimming after riding mowers on larger parcels. A delight for anyone to use!



MADE IN USA
Patented
Toll FREE 1(800) 438-3223

Please mail this coupon today for FREE DETAILS about the Revolutionary DR® TRIMMER/MOWER™, including prices and specifications of Manual and Electric-Starting Models, and "Off-Season" Savings now in effect. There is no obligation.

Name _____
Address _____
City _____ State _____ ZIP _____

To: **COUNTRY HOME PRODUCTS®**, Dept. 4149T
Meigs Road, P.O. Box 25, Vergennes, VT 05491

Circle No. 1118

SQUARE DRIVE SCREWS



Simply the Best

Square Drive Beats Driver Slippage
Deep Thread for Super Grip
Hardened Steel for Superior Strength
Made in the US or Canada!

Send \$5 for Samples, Catalog, & \$5 Off Coupon

McFEELY'S PO Box 11169 • Dept WD
SQUARE DRIVE SCREWS Lynchburg • VA • 24506-1169
Call Toll Free: 1-800-443-7937

© 1997 CHP, Inc.

FREE TOOL CATALOG!



Your Best Work Starts With Us!

With over 6,000 of the finest woodworking tools in the world, Woodcraft can help you work more efficiently and skillfully than ever. Call for your Free copy today.

1-800-542-9115
WOODCRAFT®
 Helping You Make Wood Work™

www.woodcraft.com
 210 Wood County Industrial Park Dept. 98WI10S
 PO Box 1686, Parkersburg, WV 26102-1686

Circle No. 955

FREE SANDING BELTS

BUY A DOZEN GET A DOZEN FREE

- FULL MONEY BACK GUARANTEE!!**
- 1x3017.95/doz + 12 free
 - 1x4218.50/doz + 12 free
 - 3x1818.95/doz + 12 free
 - 3x2119.95/doz + 12 free
 - 3x2421.25/doz + 12 free
 - 4x2124.95/doz + 12 free
 - 4x2425.95/doz + 12 free
 - 4x3635.95/doz + 12 free
 - 6x4840.95/1/2doz + 6 free
 - 6x8966.95/1/2doz + 6 free

Grits available: 36X to 320X
 All belts A/O Resin Bond Cloth
 w/bi-directional butt splice

Full Line of 9x11 Sheets

ALSO AVAILABLE: Stroke Sanding Belts; Belt Cleaning Sticks; Inflatable Drums and Sleeves; Cloth/Paper Discs (PSA/Hook & Loop) Drum Sanding Rolls; Wide Cloth and Paper Belts or any size belt you may require and MUCH MUCH MORE!!

Call For Price Quotes • Orders • Free Catalog

Please add \$5.00 S & H / PA Residents add 6% Sales Tax
 • • • Money Orders • Checks

1-800-428-2222

Mon. - Fri. 8am - 4:30pm EST

Fax: 1-610-378-4868
 Anytime

INDUSTRIAL ABRASIVES CO. 642 N. 8th St. Dept. W
 P.O. Box 14955
 Reading, PA 19612

Circle No. 1238

ONE-MAN SAWMILL

Turns Your Timber Into

CASH!



30-Day Free Trial!

Call NOW for FREE FACTS!

1-800-942-4406 ext. SW54

TIMBERKING, INC. Dept. SW54
 1431 N. TOPPING, KANSAS CITY, MO 64120

Semi-Annual Exotic HARDWOOD SALE!

SAVE 25%-60%
Mix or Match for Your Best Price
 100 Board Feet Your Best Buy!

Description	Sale	20+	100+
PURPLE HEART	\$3.99	\$3.59	\$3.41
JATORA (Brazilian Cherry)	\$3.99	\$3.59	\$3.41
AFRICAN PADUAK	\$6.74	\$6.07	\$5.76
MAHOAGANY (6'-7' lengths)	\$3.99	\$3.59	\$3.41

WOODWORKERS SOURCE
 IT IS FAST AND EASY!! **800-423-2450**
 www.woodworkerssource.com
YOUR SATISFACTION GUARANTEED!!

Circle No. 598, 2090

Workshops • Garages

Manufacturer Direct **Special Limited Offer**
SAVE UP TO 45%



EASY Do-It-Yourself Construction
 Saves You Time & Money

27'x48' \$6,539

\$12,760 Value

Pkgs. include steel frames & endwalls, galv. sheeting, trim & complete assembly plans. Some other sizes available

16 COLORS TO CHOOSE FROM!

MIRACLETRUSS®

1-800-663-0553

FAX 612-544-1835

www.miracletruss.com

WOOD

RIP SAW

The Portable Sawmill.

The "affordable portable" one man band sawmill. Weighs only 45 lbs. Cuts 20" diameter logs into lumber. Minimum 1/8" to maximum 9" thickness. 14"W x 9"H throat capacity. Write or call for free brochure. Videos also available.



Better Built CORPORATION
 (978) 657-5636

789 Woburn St., Dept. WD10, Wilmington, MA 01887
 Fax: (978) 658-0444



ARTS & CRAFTS STYLE CHAIR & FOOTSTOOL

Introducing the finest plan on the market today! Pages of directions and 36 by 48 CAD generated plan. This comfortable chair has a 4 position back. Dim. - 34 inches wide by 40 inches high by 39 inches deep

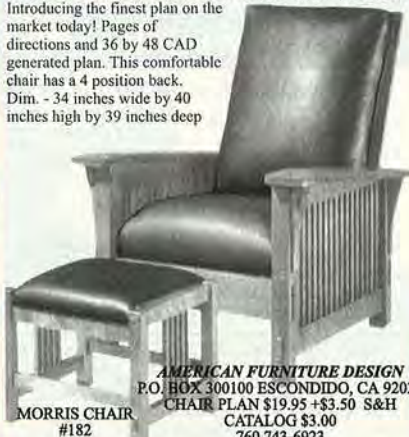

MORRIS CHAIR #182

AMERICAN FURNITURE DESIGN
 P.O. BOX 300100 ESCONDIDO, CA 92030
 CHAIR PLAN \$19.95 + \$3.50 S&H
 CATALOG \$3.00
 760 743-6923

Circle No. 314

WOOD® BACK-ISSUE SALE!

Complete your idea library today with classic projects, tips, techniques, and more from WOOD Magazine!

Buy more, save more!

- 1 issue — just \$6.95
- 2 issues — \$5.95 each
- 3 or more — \$4.95 each

Send the month and year of the issue(s) you want, along with your check or money order to: **WOOD Magazine, P.O. Box 9255, Dept BI-SA, Des Moines, IA 50306.** NO ADDED CHARGES! Postage, handling, state and local taxes included in price.

FOR FASTEST SERVICE, CALL TOLL FREE 1-800-572-9350

7 a.m. - 9 p.m. CST. (MasterCard and VISA accepted.)





PLAN #27 — \$11.97

WOOD WORKERS & TRAIN LOVERS - You'll be the envy of all your friends when you show them this exact replica of the 1949 READING T-1 Steam Freight Locomotive & Tender. This "trace & cut-out" PLAN also has easy to follow instructions for assembly. Complete with Track instructions, details include 8 working Drivers, working Trucks, and even a swinging Bell.

Send \$11.97 U.S. check or money order for the above PLAN to:

GATTO PLAN SUPPLY
55 Dogwood Road
Hamburg, PA 19526

For a brochure only of other plans available - send \$1.25

Circle No. 355

Woodworking on the World Wide Web

Better Homes and Gardens®
WOOD ONLINE™

A WOODWORKING INFORMATION SERVICE FROM THE EDITORS OF WOOD® MAGAZINE

<http://www.woodmagazine.com>

Quality Kiln Drying

It's Easy and Affordable with a Nyle DH Kiln! Made in USA

Call for free facts on our compact, easy to use dehumidification kilns.

800-777-NYLE

<http://www.nyle.com>



Kilns from 300 BF and up!

EASY PAYMENTS AVAILABLE



FREE Booklet!

To learn more about drying lumber, call for a FREE copy.



nyle
DRY KILN SYSTEMS

PO Box 1107 Bangor ME 04402-1107

Circle No. 1260

SAWMILLING WITH A BAKER PORTABLE BAND SAWMILL IS NOW FASTER THAN EVER!

16 ft. and 24 ft. Models Available



16 ft. model shown here with 38HP diesel engine

Lake States Logging Congress Sept. 10-12 Greenbay, WI

Gasoline, Diesel, or Electric Power

- Variable-speed drive
- Faster log handling
- Easy-to-read round measurement dial
- Dual chain-driven carriage
- Improved fence arms
- Saws into clean wood--not the bark
- Improved leveling system
- Improved bunk spacing and much more

BAKER Products
SAWMILL DIVISION

P.O. Box 128
Ellington, MO 63638
Fax: (573) 663-2787
www.baker-online.com
(573) 663-3133

The Amazing Walk-Behind Brush Cutter!
NEW DR® FIELD and BRUSH MOWER

CLEAR & MAINTAINS meadows, pastures, woodlots, wooded and rough non-lawn areas with ease. **CUTS** tall grass, weeds, brambles, tough brush and even hardwood saplings up to 1" thick.

CHOPS/MULCHES most everything it cuts. Leaves **NO TANGLE** of brush to pick up like hand-held brushcutters and sicklebar mowers. Perfect for *low-maintenance wildflower meadows, European-style woodlots, walking paths, or any area you only want to mow once a month or once a season!*

- Up to 14 HP
- 4 Speeds
- Power Reverse



Mows up to 1 acre per hour!

TOLL FREE (800) 438-3223

Pat. Pend.

Please mail this coupon TODAY for complete **FREE DETAILS** of the DR® FIELD and BRUSH MOWER including prices, specifications, and "Off-Season" Savings now in effect. There is no obligation.

Name _____ WOO
Address _____
City _____ State _____ Zip _____
To: **COUNTRY HOME PRODUCTS®**, Dept. 4149F
Meigs Road, P.O. Box 25, Vergennes, VT 05491

©1998 CHP, Inc.

Anderson™ BEDROOM ORGANIZER

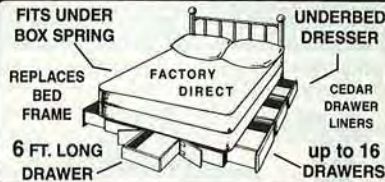

PUT A DRESSER UNDER ANY BED

Increase drawer storage with this beautiful, top quality, solid wood, dust proof, underbed dresser. Fits under any mattress. Shipped UPS
ORDER 48 PAGE CATALOG 621

1-800-782-4825

Circle No. 1795

FREE Clockmaking Catalog

Clockmaking Gets Students Ticking!

KLOCKIT.ED, America's leading supplier to clock-makers for 27 years, wants to introduce you and your students to the **Wonderful World of Clockmaking.**



Using clock projects, your school or organization can develop a program that teaches planning, product design, marketing and sales.

1-800-556-2548

Call for your **FREE** catalog today.

Name _____
Address _____
City _____
State _____ Zip _____

KLOCKIT.ED Dept. WDS108

P.O. Box 636, Lake Geneva, WI 53147
<http://www.klockit.com>

Circle No. 2535

AMAZING SCROLLSAW FRETWORK PATTERNS
Easy to advanced designs

- Clocks
- Photo frames
- Jewelry boxes
- Candle holders
- Furniture



Clock movements Plywood

Silhouettes on Christmas religion farming western nature transportation & more.

Books Saw blades Hardwoods

FREE catalog

WILDWOOD DESIGNS
P.O. Box 676-WD
Richland Center WI 53581

1-800-470-9090

Circle No. 475

FELDER Woodworking Machines

Order now! \$10,- + S&H

WOODWORKING VIDEO

See the benefits European Woodworkers have enjoyed for years on this 100 min Video

Find out what difference the use of a

- precision sliding table saw
- tilting shaper
- tilting router spindle and
- the latest planer technology

will add to your woodworking.

Real life examples performed on a FELDER combination machine with minimal space requirements.



W6400, 06/08/10/98, 0172

FELDER USA

4003 Seaport Blvd. · W. SACRAMENTO, CA 95691
Phone 800-572-0061 · Fax 916-375-3194 www.felder.co.at

Circle No. 608

GUARANTEED LOWEST PRICES



OTHER SHAPES AVAILABLE

BUILD A BETTER BUILDING

- Easy to Assemble
- Quick Delivery
- Built to Last
- Straight Sides
 - Trussless
 - All Steel
- 20 Year Guarantee



HUGE SAVINGS

FACTORY DIRECT
1-800-668-5422

Sizes 500-20,000 sq. ft.

Strongest for
Wind & Snow

Heavy 22, 20 &
18 ga. steel

Maintenance Free

SALE PRICE

FOR EXAMPLE-25' X 40'

\$3,844

FRONT ENDORSEMENT NOT INCLUDED



STEEL BUILDINGS <http://www.pioneersteel.com>

Circle No. 1986

Classic Heirloom Cradle

You can easily build this classic cradle which will become a cherished family heirloom to pass from generation to generation. Two sizes available... Baby or Doll.



Full Size Plans

Baby size Plan (21 x 35) \$14.95 ppd.
Doll size Plan (10 x 18) \$8.95 ppd.

Spindles available in Oak or Maple. See our catalog which is sent free with your order.

M/C VISA orders call toll-free 1-800-292-8296
ARMOR Box 445 A, East Northport, NY 11731

Circle No. 315

**The Cutting Edge
Turner's & Carver's Supply**

JML-1014



NEW!

JET

Midi-lathe
10" Swing
14" Centers
1/2 HP Motor

All Cast Iron Construction -Weights 60 lbs
#2MT Head & Tail w/ 1" x 8 tpi Headstock • 6 speeds
\$359.00 Freight Prepaid in Continental US

Call for Free Catalog

7123 SouthWest Fwy
Houston TX 77074
713/ 981-9228

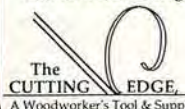

fax 713/ 981-6104

www.cuttingedgetools.com

Circle No. 2180

THE WOODTURNERS CATALOG

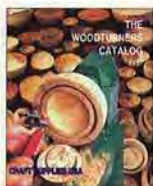

Features:

- Woodfast Lathes
- Vicmarc Mini Lathes
- Artisan™ Pen and Project Kits
- Henry Taylor Tools
- McNaughton System
- Dale Nish Workshops and much more....

Craft Supplies USA is the **Number One** source for the finest woodturning supplies, tools, and workshops with unsurpassed prices and service.

CALL TOLL FREE 1-800-551-8876 TO ORDER
a **FREE** 88-page color copy of The Woodturners Catalog

CRAFT SUPPLIES USA 1287 EAST 1120 SOUTH PROVO, UT 84606

Circle No. 830

**Heavy Glass
Table Tops**

FACTORY DIRECT DISCOUNT PRICING



- Table Tops
- Shelves
- Doors
- Display Cases
- Entertainment Centers
- Tempered Glass

WGB GLASS ■ SHAPES ■ THICKNESSES ■ EDGE DESIGNS

TABLE TOPS BY PHONE

SATISFACTION GUARANTEED!

FOR FREE IDEA CATALOG AND PRICE LIST SEND POST CARD TO:

WGB GLASS 19785 W. 12 MILE RD., STE. 357
SOUTHFIELD, MI 48076

TO PLACE ORDERS: CALL 1-800-288-6854

Circle No. 2079

**400,000RPM Air/CO2
Hand Inlay, Engraving
& Fine Relief Carving.**
simple as tracing lines



ULTRA SPEED PRODUCTS, INC.
18500 E. ASCHOFF, ZIGZAG OR 97049
503-622-4387 FAX 503-622-3252

www.mornet.com/ultraspeed

\$170(delivered) includes handpiece, foot control, air filter, video, 2 burs, lubrication system, stencil sample, operators manual and bur catalog.

Video is available for a refundable \$14 + \$3 S&H

Circle No. 2185

FREE TOOL CATALOG

Helping You Become a Better Woodworker



highland hardware

Our giant tool catalog gives more than just manufacturer's specs. We provide detailed tool descriptions, useful techniques, as well as a schedule of educational seminars.

Call toll free for **FREE** catalog
1-888-500-4466

Visit us on the Internet at <http://www.highland-hardware.com>

Circle No. 870

Better Homes and Gardens®

WOOD®

WOODWORKING RETAILERS:

Now you can carry Better Homes and Gardens® WOOD® Magazine in your store.

America's best-selling woodworking magazine, WOOD is chock-full of exclusive shop-tested woodworking projects your customers will enjoy making—using *your* inventory!

Think of the sales potential! Your profit from selling the magazine is only the beginning.

To order multiple copies for your store, call the toll-free number below.

WOODWORKERS: If you want your favorite woodworking store to carry WOOD, call the toll-free number below.

DIAL
1-800-659-5990
TODAY!
Ask for Operator 97

Circle No. 345

ARMOIRE/ENTERTAINMENT CENTER

Full-Size Plan



Build this elegant Armoire designed for storage or Entertainment Center to hold TV, VCR.

Overall size: 68" high, 38" wide, 21" deep.

Plan #195 (ppd).....\$25.50
Catalog (free with order) ...\$3.00



Since 1968, the best plans available
FURNITURE DESIGNS, INC., Dept. BE-108
1827 Elm Dale Ave., Glenview, IL 60025 — 800-657-7692
www.furnituredesigns.com

Circle No. 445



Lighthouse

64"H 16"W 30"L

Plan #197

\$8.00

Windmill

4'H 28"W 28"L

Plan #195

\$8.00

Templates

\$3 S/H
per order

SPECIALTY FURNITURE DESIGNS

797 W. Remus Road, Dept. W-52

Mt. Pleasant, MI 48858 • **1-800-892-4026**

Color Catalog \$3.00, FREE with order. Visa/MC/Disc. MI add 6%

For All Your Woodcarving & Sign Carving Needs

Terrco provides a full line of machine carving and sign carving equipment. Beginning models are the T-110 single spindle bench carver and our CM614 single spindle sign carver.

Intermediate models include the K-Star, a two-spindle heavy duty bench model, and the Northstar, a heavy duty floor model available in one to eight spindles.

Our advanced model is our Master Carver series, which is an extremely heavy duty floor model with from eight to forty spindles.

Write or call for more information.

Terrco, Inc.

222 1st Ave. NW
Watertown, SD 57201
USA
(605) 882-3888
Fax (605) 882-0778



Model T-110 Dupli-Carver



Model CM614 Sign Carver



Multi-Spindle Carving Machine

It's Your TURN To Make Pens In 2 Minutes



The WoodWrite Mini-Lathe Model 160 (shown) comes assembled, mounted, aligned and ready to run. Complete with: 1/3hp AC Induction motor; 400-5700 rpm; 16-1/2 inches between centers; 5-1/2 inch swing over bed; E-Z Glide crank; tool mount & carbide tipped cutting tool; exclusive high efficiency dust collection manifold. Model 260 - all of the above PLUS a motorized saddle drive. Model 360 - same as the 260 PLUS automatic stop switches on head & tail stocks. Call, write, or Fax for details.

2121 Abell Lane, Sparks, MD 21152 USA
Tel: 1-888-966-3974 or 410-771-4444
Fax: 410-771-4879
e-mail: woodwrite@worldnet.att.net

WoodWrite Ltd.

Quality MECHANISMS For Making WOODEN BARREL

- ✎ Pens
- ✎ Pencils
- ✎ Roller Balls
- ✎ Fountain Pens

plus other related items.

Wholesale/Retail

Call or Write:

BereaHardWoods.co.
6367 Eastland Rd. Brookpark, Ohio 44142
440-234-7949 Master Card/Visa

CONSTANTINE WOODWORKER'S CATALOG

Over 5000 products to **BUILD, REPAIR, RESTORE, REFINISH anything made of wood!**

104 pages jam-packed with fine woods, veneers, tools, finishing supplies and more - shipped fast and fully guaranteed, at discounts of 5% to 15% on orders of \$50 or more!



CONSTANTINE

Serving Woodworkers for 186 years
Dept. 35810, 2050 Eastchester Rd., Bronx NY 10461
CALL TOLL FREE 1-800-223-8087

VAN DYKE'S RESTORERS®

Supplies for woodworkers and antique restorers

Van Dyke's is proud to present a re-birth of another classic, the three legged piano stool. Kit comes in unfinished solid oak. Call or write for our FREE 288 page catalog.

WB-S6291 - Decorative edge with brass legs . . . \$99.95

WB-S6292 - Decorative edge with iron legs. . . . \$82.95

WB-S6293 - Smooth edge with brass legs . . . \$86.95

WB-S6294 - Smooth edge with iron legs. . . . \$79.95



Order Toll Free 1-800-558-1234
VAN DYKE'S RESTORERS
Dept. 60048, P O Box 278
Woonsocket, SD 57385

WIRELESS DRIVEWAY ALARM



A bell rings in your house anytime someone walks or drives into your place.

- Free Literature -

A complete line of wireless security equipment.

DAKOTA ALERT, INC.

BOX 130, ELK POINT, SD 57025
Ph: 605-356-2772

FROM LOG TO LUMBER with the *Alaskan Saw Mill* attachment (available in 24", 30", 48" and 56" sizes)

As seen in June 97 issue of Wood Magazine

CUT LUMBER ON SITE WITH THE ALASKAN MKIII: BEAMS, BOARDS, SIDING AND CUSTOM CUTS.

RIPPING CHAIN AND OILER KITS ALSO AVAILABLE



GRANBERG INTERNATIONAL
PO BOX 425 RICHMOND, CA. 94807-70425
PHONE 510.237.2099 OUTSIDE CA. 800.233.6499
FAX 510.237.1667
E-MAIL granberg@aol.com
http://www.granberg.com



We've got quartz and mechanical clock movements, fit-ups, hardware, plans, tools and more! Call or write for your FREE catalog, #BHW2

S.LaRose, Inc.
3223 Yanceyville St.
Greensboro, NC 27405
Phone: (336) 621-1936 • www.slarose.com
E-Mail: SLAROSE@worldnet.att.net

OVER 1500 PATTERNS

Huge variety of FULL SIZE woodcraft patterns!

Fun • Profitable • Fast Service • Guaranteed

✓ Pick from our most popular pattern sets & order today!

- EACH SET INCLUDES:
 - 125 Pattern BEGINNER'S BONANZA plus "Shop Secrets".
 - SHOW STOPPERS II-22 Craft Show best-sellers!
 - 25 fun & profitable "wind-action" WHIRLIGIGS.
 - YARD CHARACTERS-Arnhish, Dutch, bending lady, more!
 - Eye-catching DUTCH WINDMILL - 5 feet tall.
 - COUNTRY CRITTERS- 100 Patterns, decorative projects.
 - Over 30 CHRISTMAS decorations & centerpieces!
 - 200 CREATIVE CUT patterns for scroll, band or jigsaw.
 - Decorative country SHELF ASSORTMENT, many options!
 - COUNTRY CLASSICS- 25 top-selling country designs.
 - Create over 20 "Quick & Easy" BIRD HOUSES.
 - 100 YARD ORNAMENTS- Animals, bird, signs & more!

Send \$8.00 per set or...SAVE!
Pick 3 for \$19.50 • 6 for \$36.00
or All 12 for only \$60.00!!!
ILLUSTRATED CATALOG \$2.00 (Free wording)
CALL TODAY!
24 Hr. Fax-Voice Mail (603) 332-4579
Mention offer # MA108

ACCENTS
Dept. MA108
P.O. Box 7387
Gonic, NH 03893

Circle No. 2175

Circle No. 820

Circle No. 2098

Circle No. 2077

Circle No. 1910

Circle No. 1914

Circle No. 52

Circle No. 510

Circle No. 2375

Circle No. 310

WOOD®
CLASSIFIED MART
 For rates: 1-800/424-3090 Fax 312/464-0512

AUTOMOTIVE

SEIZED CARS FROM \$175. Porsches, Cadillacs, Chevys, BMW's, Corvettes. Also Jeeps, 4WD's. Your Area. Toll Free 1-800/218-9000 Ext. A-14094 for current listings.

FINANCIAL SERVICES

FREE CASH GRANTS! College, Scholarships, Business, Medical bills. Never repay. Toll Free 1-800/218-9000 Ext. G-14094.

FINISHING/RESTORATION

LINE BOXES EASILY. Spray-on suede, 31 colors. Free Brochure, DonJer Products, Ilene Court-Bldg, 8W, Bellemead, NJ 08502. 1-800/336-6537.

INSTRUCTION/EDUCATION

WOODWORKING COURSE. Computer-Based CD-ROM Training, Windows 95/98, Interactive. Introductory priced \$59.00. White Mountain Design, Visit www.whitemountaindesign.com 613-837-1800.

INVENTIONS

IDEAS, INVENTIONS, NEW PRODUCTS! One of America's leading invention firms can help you submit to industry. Patent services. Call 1-800/288-IDEA.

JOB/BUSINESS OPPORTUNITIES

EASY WORK! EXCELLENT PAY! Assemble Products at Home. Call Toll Free 1-800-467-5566 EXT. 11856.

\$100.00 PER HOUR, woodworking from your garage, full or part-time, no selling. Free Brochure: Satinwood 1-800/456-4987.

MUSIC/SUPPLIES

PLANS, KITS, SUPPLIES for musical instruments: harps, dulcimers, psalteries, banjos, guitars, more. Musicmaker's Kits, Dept. B98, PO Box 2117, Stillwater, MN 55082. 612/439-9120.

PLANS/KITS/PATTERNS

FURNITURE PLANS. Rolltop desk, Cradle, Winerack, and many conventional designs. Catalog \$3.00: Lake Superior Design, Box 751, Grand Marais, MN 55604-0751.

TOOLS/EQUIPMENT

BAND SAW BLADES: Low tension Swedish Silicon Steel "TIMBERWOLF" bands. 1/16" thru 1 1/4". Free Catalog 1-800/234-7297. Email timberwolf2@worldnet.att.net HOME PAGE timberwolf1.com

CUSTOM BRANDING IRONS. As low as \$56.25! Any design, logo, signature. Hollowood, Tubular plywood! Many diameters, species. Maple Bench Tops. 30 different sizes. BrandNew. 800-964-8251. VISA/MC.

SAND WITH SCROLL SAWS! SCROLLSANDER™ attaches like blade! 4 Sanders \$6.95. 1/2" or 1/4" width. \$2.95 s&h/order. 702-345-1660. Visa/MasterCard/Check.

WOOD/LUMBER

CUSTOM CUT WOOD. Specializing in Osage Orange (\$12.95/ft.) and other quality woods. Cut to your specifications. No minimum order. spradlin@adams.net 217-285-4336.

FREE
Clockmaking Catalog

**Your Handcrafted Clocks
 Make Treasured Gifts!**

Your complete source of clockmaking supplies.

Classic designs available in kits or easy-to-follow plans. New intarsia kits and plans,

gear clocks, and the **HOT Radio Controlled Movements!** Projects available for every skill level!



For Your
FREE CATALOG
 Call
1-800-556-2548

KLOCKIT® Dept. WD108
 P.O. Box 636, Lake Geneva, WI 53147
<http://www.klockit.com>

Circle No. 2335

PRODUCTS THAT PERFORM



Continued from page 98

This tape measures, and remembers for you. You make a mental note: Rip a piece of stock to 3 3/8", then crosscut five pieces from it, three 9 1/16" long and two 3 3/8" long. Then you turn to your tablesaw. Oh boy, what was that width... 3 3/16"? Better check the plans again.

Forget remembering. The digital voice recorder in the Zircon Repeater 25 tape measure lets you record up to 20 seconds' worth of dimensions, assembly instructions, or anything else you need to remember. Then, just press a button to hear your reminders.

It's handy to use. Just hold down the red recording button while you speak into the microphone holes in the case. Hold it down again to record another. You can record five or six separate messages in the time available. Each press of the play button plays back one memo, going through them in sequence. Sound quality is good, and the messages come through loud and clear. Listen to the memos again by pressing the rewind button, which takes you back to the first message.

And the Repeater works well as a tape measure, too. The inch-wide 25' blade extends 7' and sometimes 8' before buckling. No bulkier than a standard 1"×25' tape, it took the abuse of ten 4' drops without affecting the Repeater's functions. ♣

—Tested by Bob McFarlin

PRODUCT SCORECARD

The Zircon Repeater 25	
Performance	★★★★★
Price	\$37.99 plus \$5 shipping and handling. (May be less in stores.)
Value	★★★★☆
Zircon Corp., 1580 Dell Ave., Campbells, CA 95008. Call 800/245-9265. Internet: http://www.zircon.com	



HEGNER Scroll Saws
 THE EXPERTS' CHOICE

“I have personally owned and enjoyed HEGNER Saws for over twelve years. HEGNER's smooth, quiet performance is only one of it's many unique advantages. Choose a HEGNER and you'll enjoy scrolling the way it's meant to be.”

— Patrick Spielman
 America's #1 Woodworking Author and Publisher of Home Workshop Magazine

For over twenty years, HEGNER Scroll Saws have been the experts' choice because of features like space-saving design, fast and easy blade changes, unmatched reliability, and superior warranties. Call for your FREE Catalog today.



Home Workshop Magazine is packed with detailed project patterns and instructions, news, tips and techniques. Subscribe now for only **\$19.95 per year** (6 issues). Call to subscribe now.

If you order a HEGNER saw before December 31, 1998, we will give you a **FREE** one year subscription to Home Workshop Magazine; or, if you are already a subscriber, we will extend your subscription for one year.

Call for your **FREE** Catalog or to order your Home Workshop subscription now.

1.800.727.6553

ADVANCED MACHINERY
 P.O. BOX 312 • DEPT. 809 • NEW CASTLE DE 19720 • WWW.ADVMACHINERY.COM

Circle No. 3

14" BAND SAW
\$ 250.00



DRUM
BRUSH SANDER
\$ 295.00



6" JOINTER
\$ 325.00



3 HP 16" PLANER
\$ 695.00



10" HEAVY
DUTY
TABLE SAW
\$ 995.00



26" PLANER
\$ 1,195.00



TRANSPOWER

CP TOOLS, INC. 611 DUGGAN AVE., Azusa CA 91702

Tel: 626-815-9897

Fax: 626-815-9807

Order Desk: 1-800-654-7702

Circle No. 15

Semi-Annual Exotic HARDWOOD SAVE 25%-60% SALE!

Mix or Match
for Your Best Price

100 Board Feet Your Best Buy!

Description	Sale	20+	100+	Description	Sale	20+	100+
Purple Heart	\$3.99	\$3.59	\$3.41	Mahogany (6-7' lengths)	\$3.99	\$3.59	\$3.41
Jatoba (Brazilian Cherry)	\$3.99	\$3.59	\$3.41	Morado* (Bolivian Rosewood)	\$9.99	\$8.99	\$8.54
African Paduak	\$6.74	\$6.07	\$5.76	Peroba			
Spanish Cedar	\$5.24	\$4.72	\$4.48	Rosa*	\$7.99	\$7.19	\$6.83
				Goncalo Alves*	\$7.99	\$7.19	\$6.83

*Certified, sustain yield lumber.

All lumber priced by the board foot, random width 4" and wider, random length 3'-8", 4/4 stock, surfaced 2 sides. Limited to stock on hand. Sale good thru 10-31-98.



WOODWORKERS
Source

IT IS FAST AND EASY!!



OVER 100 WOODS AVAILABLE
CALL ON YOUR FAVORITE

800-423-2450

www.woodworkerssource.com

YOUR SATISFACTION GUARANTEED!!

Circle No. 598, 2090

SUPER SHOP

Own the ultimate home shop 10 tools in 1 machine

The SuperShop® and Shopsmith® are the world's most popular multipurpose wood tools and both are quality tools—we invite you to compare features and consider which machine can bring the most value and function to YOUR workshop.

Call today for your **FREE SuperShop info pak and special limited-time offer.** Now is a great time to get a deal on a SuperShop!

Call now—
(800) 345-6342

Ask for operator WDW

or write:

SuperShop • Dept. WDW, PO Box 1517
Ann Arbor, MI 48106-1517

SuperShop® or Shopsmith® You can SEE the difference



SuperShop Model 720®

Weight: 480 lbs.
Casters: Standard
Spindle: 3" 4-bearing
Carriage travel: Rack and pinion
Vertical lift: Lift by hand with LiftAssist torsion spring
Speed range: 32-7200 rpm
Tool mount: Self-centering, industrial R-8 collet
Metalworking capabilities: Yes
Optional powerfeed: Yes



Shopsmith Mark V®

Weight: 180 lbs.
Casters: Optional (Cost extra)
Spindle: 2-1/4" 2-bearing
Carriage travel: Push by hand
Vertical lift: Lift by hand
Speed range: 700-5200 rpm
Tool mount: Setscrew
Metalworking capabilities: No
Optional powerfeed: No

"This isn't the Cadillac, this is the Mercedes® of combination woodworking tools. My old 5-in-1 is going to be very lonely over in the corner."

—Edward Zych (TN)

"I looked closely at both machines before buying. The Shopsmith® is a toy compared to the SuperShop®. My SuperShop has taken everything I've thrown at it."

—Joe Galgoczi (PA)

*Current prices at time of publication.

Circle No. 100



There's a new kid on the portable power tool block

If you appreciate the finest things in woodworking tools, and can foot the bill for them, you should know about a new line of portable power tools coming to America. Festo Tooltechnic—a German brand long available in Europe—is being distributed in the U.S. through Toolguide Corp. of Carson City, Nevada (888/337-8600). By calling Toolguide you can arrange for a demonstration or to view a videotape about Festo tools.

The current U.S. lineup consists of 14 products including two portable circular saws, a power hand planer, router, jigsaw, shop vacuum, two cordless drills, two half-sheet finishing sanders, detail sander, two random-orbit sanders, portable work stand, and various accessories.

With selling prices ranging from \$268 for the detail sander and \$292 for the jigsaw to \$463 for a

portable circular saw (with rail guide), you won't find these tools in the bargain basement of your local tool distributor. But if precision, durability, ergonomics, and

effective dust collection mean a lot to you, give this new line a look. We will include Festo products in upcoming reviews of portable power tools. ♣



Power. Precision. Price.

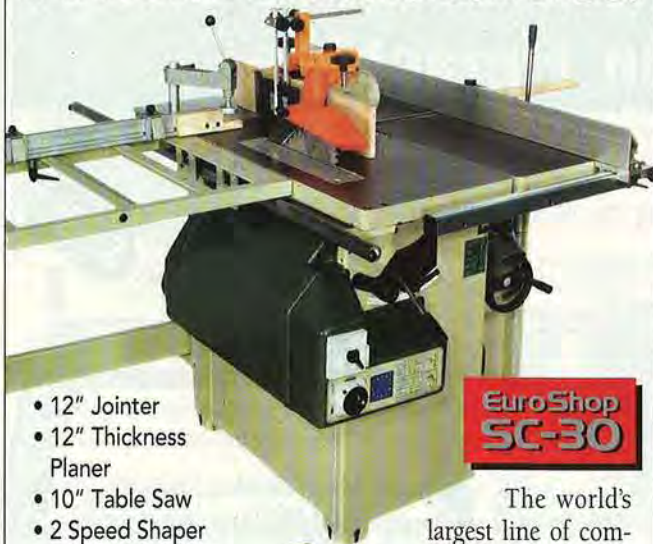

- 12" Jointer
- 12" Thickness Planer
- 10" Table Saw
- 2 Speed Shaper
- Sliding Table
- Slot Mortiser/Horizontal Borer
- 3 3HP 230V Motors

**EuroShop
SC-30**

The world's largest line of combination woodworking centers just got bigger. Find out why the pros select EuroShop. Call:

800-203-0023

**OLD WORLD
MACHINERY CO.**
San Clemente, CA

Find out why EuroShop bandsaws are the best.



Econ-Abrasives

WE MAKE ABRASIVE BELTS ANY SIZE, ANY GRIT!

Standard Abrasive Sheets

CABINET PAPER

	50/pk	100/pk
60D	\$16.70	\$30.00C
80D	15.60	27.80C
100 thru 150C	14.50	25.60C

FINISHING PAPER

80A	\$ 11.15	\$18.90C
100 thru 280A	10.00	16.70C

NO LOAD PAPER(white)

100 thru 400A	\$12.25	\$21.25C
---------------	---------	----------

C = 100 SHEETS

Velcro® Vacuum Discs

8 Hole pattern for Bosch sanders

Dia.	Grit	Price
5"	60	\$.48ea
5"	80	.46
5"	100 thru 320	.45

* Available in 5 hole pattern *

*Wide Belts*Rolls*Flap Wheels
*Pump Sleeves*PSA Discs
*Router & Wood Bits*Wood Glue

ABRASIVE BELTS

Belts are resin bond cloth with a bi-directional splice, specify grits.

1X30	\$.81 ea	3X24	\$.93 ea
1X42	.81 ea	3X27	.96 ea
1X44	.81 ea	4X21 3/4	1.06 ea
2 1/2X16	.85 ea	4X24	1.10 ea
3X18	.86 ea	4X36	1.35 ea
3X21	.90 ea	6X48	3.50 ea
3X23 3/4	.93 ea	6x89	6.24 ea

OTHER SIZES ON REQUEST

HEAVY DUTY SPRING CLAMPS

Clamps come w/PVC tips and grips.



Size	Price
4"	\$1.75 ea
6"	2.25
8"	3.50

JUMBO ROUTER PAD(24" x 36")

It will not allow small blocks of wood to slip out under router or sanding applications. ROUTER PAD ONLY \$8.95ea.

JUMBO BELT CLEANING STICK ONLY \$8.80

*MasterCard, VISA, C.O.D. or Check
*SATISFACTION GUARANTEED!!!
*CALL FOR FREE CATALOG
- TX & NV add appropriate sales tax
- Continental U. S. shipping add \$5.50

Econ-Abrasives



P. O. Box W1628
Frisco, TX 75034
(972)377-9779

TOLL-FREE ORDERING LINE (800)367-4101

WOODLINE Bits & Cutters feature:

- Tough European Carbide
- Euro Anti-Kickback Design
- Super-slick Non-stick finish.



WOODLINE ARIZONA, Inc

P.O. Box 1530 • Payson, AZ 85547

Great Router Bits & Shaper Cutters!

"Why pay more or accept less!"

Get your **FREE** catalog and see our great selection of Bits and Cutters
1-800-472-6950

Roundover Bits with Bearing

1/4" Shank	Radius	
WL-1040	1/16"	\$9.
WL-1041	1/8"	\$9.
WL-1042	3/16"	\$9.
WL-1043	1/4"	\$9.
WL-1044	5/16"	\$10.
WL-1045	3/8"	\$11.
WL-1046	1/2"	\$13.

1/2" Shank

WL-1049	1/8"	\$9.
WL-1042-5	3/16"	\$9.
WL-1050	1/4"	\$9.
WL-1044-5	5/16"	\$10.
WL-1051	3/8"	\$12.
WL-1052	1/2"	\$13.
WL-1053	5/8"	\$16.
WL-1054	3/4"	\$18.
WL-1055	7/8"	\$25.
WL-1056	1"	\$27.
WL-1057	1-1/8"	\$30.
WL-1058	1-1/4"	\$30.

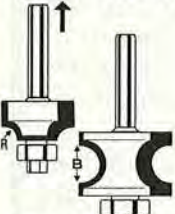

Bullnose Bits with Bearing

1/4" Shank	Bead	
WL-1100	1/4"	\$12.
WL-1101	3/8"	\$14.
WL-1102	1/2"	\$16.
WL-1103	5/8"	\$18.
WL-1104	3/4"	\$19.

1/2" Shank

WL-1110	1/4"	\$12.
WL-1111	3/8"	\$14.
WL-1112	1/2"	\$16.
WL-1113	5/8"	\$18.
WL-1114	3/4"	\$19.
WL-1115	1"	\$22.
WL-1116	1-1/8"	\$25.
WL-1117	1-1/4"	\$28.
WL-1118	1-1/2"	\$32.

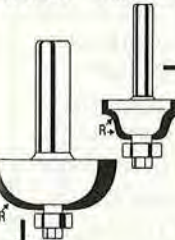

Cove Bits

1/4" Shank	Radius	
WL-1159	1/8"	\$10.
WL-1160	3/16"	\$10.
WL-1161	1/4"	\$11.
WL-1162	3/8"	\$13.
WL-1163	1/2"	\$14.

Cove Bits (continued)

1/2" Shank		
WL-1169	1/8"	\$10.
WL-1170	1/4"	\$11.
WL-1171	3/8"	\$13.
WL-1172	1/2"	\$14.
WL-1173	5/8"	\$18.
WL-1174	3/4"	\$20.

Chamfer Bits

1/4" Shank	Degree	
WL-1180	15°	\$10.
WL-1181	25°	\$10.
WL-1182	45°	\$12.
WL-1183	45°	\$14.

(for up to 3/4" material)

1/2" Shank		
WL-1184	45°	\$10.
WL-1185	11-1/2°	\$12.
WL-1186	15°	\$12.
WL-1187	22-1/2°	\$12.
WL-1188	30°	\$14.
WL-1189	45°	\$15.
WL-1190	45°	\$22.

(for up to 1-1/4" material)

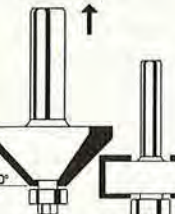

Rabbeting Bits

1/4" Shank	Kerf	
WL-1220	1/2"	\$11.
WL-1220-2	1/16"	\$10.
WL-1220-3	1/8"	\$10.
WL-1220-4	1/4"	\$10.
WL-1220-5	3/8"	\$10.

1/2" Shank

WL-1225	1/2"	\$11.
WL-1225-2	1/16"	\$10.
WL-1225-3	1/8"	\$10.
WL-1225-4	1/4"	\$10.
WL-1225-5	3/8"	\$10.
WL-1225-6	3/4"	\$12.

Roman Ogee Bits

1/4" Shank	Radius	
WL-1230	5/32"	\$13.
WL-1231	1/4"	\$15.

1/2" Shank

WL-1235	5/32"	\$13.
WL-1236	1/4"	\$15.

Double Roman Ogee

1/4" Shank	Radius	
WL-1240	5/32"	\$18.
WL-1241	1/4"	\$20.

1/2" Shank

WL-1245	5/32"	\$18.
WL-1246	1/4"	\$20.

Ask about our unique "Does It All" ROUTER TABLE

Classical Ogee Bits

1/4" Shank	Radius	
WL-1250	5/32"	\$18.
WL-1251	1/4"	\$20.

1/2" Shank

WL-1252	5/32"	\$18.
WL-1253	1/4"	\$20.

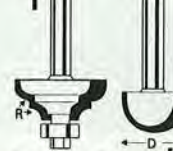

Core Box Bits

1/4" Shank	Diameter	
WL-1370	1/8"	\$10.
WL-1371	1/4"	\$8.
WL-1371-1	3/8"	\$9.
WL-1372	1/2"	\$10.
WL-1373	3/4"	\$12.

Roundnose/Core Box

1/2" Shank	Diameter	
WL-1375	1/4"	\$8.
WL-1375-1	3/8"	\$11.
WL-1376	1/2"	\$12.
WL-1377	3/4"	\$14.
WL-1378	1"	\$16.

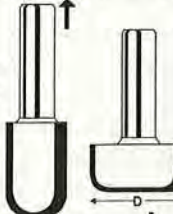

Bowl & Tray Cutter

1/4" Shank	Diameter	
WL-1380	7/16"	\$13.
WL-1381	3/4"	\$15.

1/2" Shank

WL-1385	3/4"	\$15.
WL-1386	1-1/4"	\$18.

Dado & Planer Bit

1/4" Shank	Diameter	
WL-1390	3/4"	\$12.

1/2" Shank

WL-1391	3/4"	\$12.
WL-1392	1"	\$14.
WL-1393	1-1/4"	\$15.
WL-1394	1-1/2"	\$16.
WL-1395	2"	\$28.

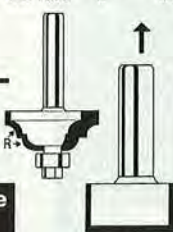

Pattern Cutting Bit

1/4" Shank	Diameter	
WL-1400	1/2"	\$12.
WL-1401	5/8"	\$12.
WL-1402	3/4"	\$12.

1/2" Shank

WL-1405	3/4"	\$15.
WL-1406	1-1/8"	\$16.

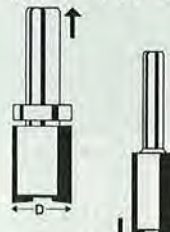

Straight Bits

1/4" Shank	Diameter	
WL-1001	1/8"	\$10.
WL-1002	3/16"	\$5.
WL-1002-5.5	5.5mm	\$5.

(for undersized 1/4" plywood)

WL-1003	1/4"	\$5.
WL-1004	5/16"	\$5.
WL-1005	3/8"	\$5.
WL-1006	15/32"	\$5.

(for undersized 1/2" plywood)

WL-1007	1/2"	\$6.
WL-1008	9/16"	\$6.
WL-1009	5/8"	\$7.
WL-1010	23/32"	\$8.

(for undersized 3/4" plywood)

WL-1011	3/4"	\$9.
WL-1012	1"	\$10.

1/2" Shank

WL-1020	15/64"	\$5.
WL-1021	1/4"	\$5.
WL-1019	5/16"	\$5.
WL-1022	3/8"	\$5.
WL-1023	7/16"	\$5.
WL-1024	15/32"	\$5.

(for undersized 1/2" plywood)

WL-1025	1/2"	\$6.
WL-1027	5/8"	\$8.
WL-1028	23/32"	\$8.

(for undersized 3/4" plywood)

WL-1029	3/4"	\$9.
---------	------	------

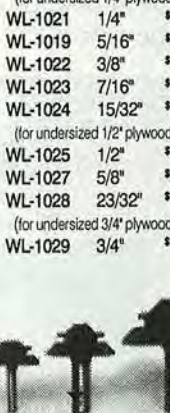

Corner Lock Mitres

For up to 5/8" material WL-1420-2 1/4" shank \$25.
For 1/2" to 3/4" material WL-1420-1 1/2" shank \$30.
For material 3/4" to 1-1/4" WL-1420 1/2" shank \$38.

For the Shaper Lock Mitre

WL-1581 \$40.

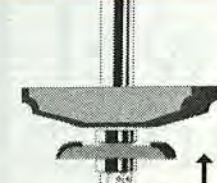

Horizontal Panel Raiser with Undercutter

1/2" Shank		
WL-1346	Ogee	\$49.
WL-1347	Traditional	\$49.
WL-1348	Convex (Cove)	\$49.
WL-1359	12° Facecut with Quarter Round Wave	\$49.
WL-1363	Wave	\$49.

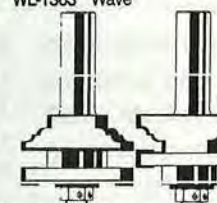

2-piece Rail & Stile Cutter Sets

1/2" Shank	Set	
WL-1360	Ogee Profile	\$59.
WL-1361	Roundover	\$59.
WL-1362	Cove & Bead	\$59.

1-piece Rail & Stile Cutter Sets

Just raise the cutter to make the matching cut. No changing or reversing. 1/2" Shank

WL-1365	Ogee Profile	\$49.
WL-1366	Roundover	\$49.
WL-1367	Cove & Bead	\$49.
WL-1368	Wedge	\$49.
WL-1374	Dbt Roundover	\$49.

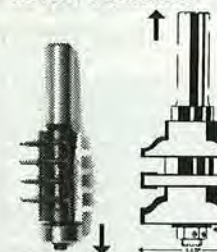

Finger Joiner Router Bit

WL-1429 \$39.
For the Shaper WL-1580 \$89.

Reversible Glue Joint

WL-1430 1-3/4" Diam \$35.
For the Shaper WL-1706 \$35.

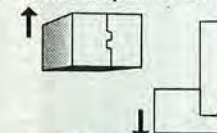

Drawer Corner Lock

Makes drawer side separation virtually impossible. 1/2" Shank WL-1435 For 1/2" material \$30.

SHAPER CUTTERS 3/4" BORE

Corner Round

WL-1509	1/8"	\$22.
WL-1510	1/4"	\$24.
WL-1511	3/8"	\$26.
WL-1512	1/2"	\$26.
WL-1513	3/4"	\$30.
WL-1514	1"	\$32.
WL-1515	1-1/4"	\$38.

Bead

WL-1520	1/4"	\$24.
WL-1521	3/8"	\$26.
WL-1522	1/2"	\$26.
WL-1523	3/4"	\$28.
WL-1524	1"	\$30.

Flute

WL-1530	1/4"	\$24.
WL-1531	3/8"	\$26.
WL-1532	1/2"	\$26.
WL-1533	3/4"	\$28.
WL-1534	1"	\$30.

Rabbeting/Straight

WL-1540	1/4"	\$24.
WL-1541	3/8"	\$26.
WL-1542	1/2"	\$26.
WL-1543	3/4"	\$28.
WL-1544	1"	\$30.
WL-1545	1-1/2"	\$32.
WL-1546	2"	\$48.

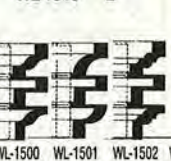

SHAPER CUTTERS 3/4" BORE 1-piece Rail & Stile

Just raise the cutter to make the matching cut. No changing or reversing.

WL-1500	Roman Ogee	\$89.
WL-1501	Roundover	\$89.
WL-1502	Cove & Bead	\$89.
WL-1503	Dbt Roundover	\$89.

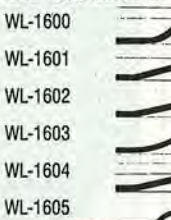

Panel Raisers (Shaper Cutter)

3/4" Bore		
WL-1600	Ogee	\$59.
WL-1601	15° Facecut	\$59.
WL-1602	18° Traditional	\$59.
WL-1603	Convex (Cove)	\$59.
WL-1604	12° Facecut with Quarter Round	\$59.
WL-1605	Wave	\$59.

• All Major Credit Cards Accepted • Shipping is only \$3.75 per order • Most items in stock • Same-day shipping!!

Order Toll Free 1-800-472-6950 • 24 hours a day • 7 days a week

Dealing with dowel joints

How to make old ones good as new

Follow pro craftsman Bob Flexner through the steps of repairing dowel joints, and see how to reglue others in the article on page 39.

Norman, Oklahoma, furniture restorer Bob Flexner's research has shown that dowel joints were popular in furnituremaking following the Industrial Revolution. Machine-made dowels were readily available, and drilling holes and installing them was quick compared to mortise-and-tenon joints.

"You *can* treat a dowel joint like a mortise-and-tenon. Clean the

dowel, clean the hole, then reglue," Bob comments. "But, you're taking a chance because the dowel is a separate piece of wood that may come loose in the side you didn't reglue."

That's why in valuable antique furniture, he carefully and completely removes all the dowels, cleans them, and reuses them in the reglue. This tactic also keeps all parts original to preserve the piece's value.

"On more common furniture, I tend to replace all the dowels for structural integrity. A vise on my workbench keeps both hands free," he says.

To get dowels out, Bob first lightly taps them on the ends, hoping to loosen the dried glue. Then, with a pliers he wiggles the dowels and pulls out those that will come. "Forcing those that won't only splits the dowels," he notes. "It's better to saw them off and drill out the hole."

Before Bob saws off a dowel, he records any angle that it may have with a bevel tool. Then, he refers to the angle later when he drills out the hole for a new one.

"Because American dowels are normally $\frac{3}{8}$ " or $\frac{7}{16}$ " in diameter, I want to use a drill bit $\frac{1}{16}$ " smaller," Bob explains. "And a brad-point bit easily centers in the hole so you don't damage the sides. When you get to the end of the hole, you'll feel a little jolt. That's the air pocket between the dowel and dowel-hole bottom. Now what's left is a $\frac{1}{2}$ "-thick rim of dowel around the hole. Remove it and the hole is back in original shape."

With a small, dull chisel, he breaks what's left of the dowel away from the hole wall while avoiding enlarging it, then he shakes the resulting pieces out. With a dull $\frac{3}{8}$ " drill bit (or $\frac{7}{16}$ " for the larger size hole), Bob cleans the remaining glue from the hole sides. Any remaining dried glue he removes with a needle-nosed rasp. Glue on flat surfaces of mating pieces he takes off by hand with a cabinet scraper. ♣



Use a small, dull chisel to remove the remaining pieces of dowel left in the holes.



Before sawing off a stubborn dowel, make sure to record any angle that it may have coming out of the hole.



With his drill and a brad-point bit $\frac{1}{16}$ " smaller than the dowel hole, Bob drills out the old dowel.

Written by Peter J. Stephano Photographs: Bob Hawks Graphic Design: Perry McFarlin

Delta Tools	Model	Description	List Sale
31-895	6"	Belt/9" Disc Sander	441 217
23-710	New	Sharpening Center	217 145
23-880	6"	Bench Grinder 1/4 HP	80 69
31-460	4"	Belt/Disc Sander	198 119
40-560	16"	2 speed Scroll Saw	230 155
40-540	16"	var/spd Scroll Saw	249 179
11-990	12"	Bench Drill Press	255 184
11-090	32"	Radial Bench Drill Press	405 279
43-505	1/2"	Bench Router/Shaper	398 299
22-540	12"	Bench Top Planer	350 259
28-195	10"	Band Saw	399 309
22-560	12"	Planner w/ extra knives	389
36-665	Versa Feeder	Stock Feeder	259
36-220	10"	Compound Mitre Saw	394 199
28-185	Bench Band Saw		213 168
36-240	10"	Sliding Mitre Saw	589 339
37-070	6"	v/spd Bench Jointer	351 265
14-650	Hollow Chisel Mortiser		380 239
33-990	10"	Radial Arm Saw	981 799
17-900	16-1/2"	Floor Drill Press	490 349
37-190	8"	Deluxe Jointer	603 445
36-285	8-1/4"	Builders Saw w/ stand	266
36-210	10"	Compound Mitre Saw	344 199
34-555	Sliding Table		487 289
36-250	10"	Slide Compound Saw	825 449
31-780	Oscillating Spindle Sander		253 194
31-780K31-780	w/ 31-781 spindle set		209
46-700	Q2 Wood Lathe		575 465
40-650	Q3 18"	Scroll Saw	389
36-905	30"	Unifence	346 255
36-906	50"	Unifence	444 325
34-444	10"	Contractors Table Saw	579

The following tools have a \$50.00 rebate! Price shown is before rebate.

36-455	10"	Contractors Table Saw w/ 30" unifence, cast iron wing, 34-914 table blade, & carbide blade	596
22-675	DC380	15" Planer	1175
28-275	14"	Band Saw 3/4 HP	595
28-280	14"	Band Saw 1 HP motor with enclosed stand	739
28-280Z	14"	Band Saw 1 HP w/ 50-274 mobile base, 28-843 rip fence, & 28-266 cool blocks	839
31-280	Sanding Center w/ stand		789

NEW Single Stage Dust Collectors			
50-840	1 HR,	650 CFM	270 225
50-850	1-1/2 HR,	1200 CFM	309
50-851	2 HR,	1500 CFM	455

MILWAUKEE TOOLS			
6527	NEW	Sawzall with case	343 169
6537-2	6527	w/quick lok blade change	224 175
0407-2212V	Drill	w/keys chuck&2 batt	360 175
0224-1	3/8"	Drill 4.5 amp magnum	236 132
0234-6	1/2"	Drill 4.5A mag 0-850 rpm	255 134
0235-1	1/2"	Drill w/keyless chuck	255 142
0244-1	1/2"	Drill 4.5A mag 0-600 rpm	255 134
0222-1	3/8"	Drill 3.5 amp 0-1000 rpm	213 119
0228-6	3/8"	Drill 3.5 amp 0-1000 rpm	207 109
0375-1	3/8"	close quarter Drill	255 148
0379-1	1/2"	close quarter Drill	288 165
6546-6	cds	Scorwdr 200 & 400 rpm	150 89
6547-6	6546-1	w/bits, 1/4" chuck & c&is	108 108
5399	1/2"	D-handle Hammer Drill Kit	356 219
5397-1	3/8"	v/spd Hammer Drill Kit	275 145
5371-6	1/2"	v/spd Hammer Drill Kit	360 194
3107-6	1/2"	v/spd right angle Drill Kit	234
3300-1	1/2"	v/spd right angle Drill	378 219
6142	4-1/2"	Grinder w/cse & acc.	224 129
6490-6	10"	Mitre Saw	496 265
6491	6490	w/ carbide blade & bag	594 328
6494-6	10"	Compound Mitre Saw	585 315
6266-6	Top Handle	Jig Saw	315 159
6496-6	10"	Slide Compound Saw	1050 569

FREUD CARBIDE TIPPED SAW BLADES			
Item	Description	Teeth	List Sale
LU72M010	Gen Pur. A.T.B. 10"	40	69 42
LU82M010	Cut-off 10"	60	93 44
LU84M011	Comb 10"	50	78 45
LU85M010	Super Cut-off 10"	80	115 59
LU72M010	Ripping 10"	24	68 38
LU73M010	Cut off 10"	60	84 49
LU87M010	Thin Kerf 10"	24	72 45
LU88M010	Thin Kerf 10"	60	88 49
LU98M010	Ultimate 10"	80	128 68
LU91M010	Compound Mitre 10"	60	84 49
F410	Quiet Blade 10"	40	95 49
SD308	8" Dado - Carbide		230 119
SD506	8" carbide w/case & shims		344 168
FB100	16 pieces Forstner Bit Set		338 194
94-100	5 pc. Router Bit Door System		320 169
FT2000E	Plunge Router		350 205
JS102	Biscuit Jointer		350 219

HITACHI TOOLS			
CBF92	8-1/2"	Slide Compound Saw	169 449
CI10F	10"	Slide Compound Saw	162 899
C15F	10"	Mitre Saw	1346 645
NV45AB	Coll Roofing Nailer		935 379
CI09A	NEW 10"	Table Saw	632 319

MAKITA TOOLS			
Model	Description	List Sale	
5090DW	3-3/8" Saw Kit 9.6 volt	280 155	
DA391D	3/8" angle Drill 9.6V	166 114	
DA391DW	3/8" angle Drill Kit 9.6V	341 189	
ML290	Incandescent Flashlight 9.6V	14.95	
6095DWE3	6 volt Drill Kit w/2 batt	125	
6095DWE2	6095DWE w/flashlight	139	
6095D	6095DW Drill only & cse	Special	
63200T-4	9.6 volt Battery	47	30
63200D-4	7.2 volt Battery	39	28
6203DWHE	9.6V 3/8" Drill Kit w/2 batt	351 159	
6201DWHE	12V 3/8" Drill Kit w/2 batt	368 175	

CORDLESS DRILLS			
WITH 2.0 AMP HIGH CAPACITY BATTERIES			
6213DWA	12V 3/8" Drill Kit	325 169	
6213DWA	14.4V 3/8" Drill Kit	358 205	
9900B	3"x21" Belt Sander w/bag	347 179	
99240B	3"x24" Belt Sander w/bag	360 182	
N1900B	3-1/4" Planer with case	263 149	
9121B	4-3/8" Planer	352 205	
N4549	4" Disc Grinder 4.6 amp	118 65	
270800R38"	Angle Drill	355 185	
DA008	8-1/4" Table Saw	637 295	
6405	3/8" Drill Rev. 0-2100 rpm	115 65	
5951B	1/2" Drill Rev. 6 amp	270 159	
9401	4" x 24" Belt Sander w/bag	458 235	
9007NKB7-1/4"	Circ Saw w/ case	250 125	
LS1011	10" Slide Compound Saw	995 429	
LS1211	12" Slide Compound Saw	1620 695	
3901	Plate Joiner Kit	376 209	
3612C	3 HP Plunge Router	492 269	
LS1040	10" Compnd Mitre Saw	460 259	
LS1013	10" Dual Compound Slide Mitre Saw	1088 599	
905010	5" Random Orbit Sander	142 72	
LS1220	NEW 12" Compound Mitre Saw	379	
9227C	NEW 7 9/16" Polisher	350 195	
5J401	NEW 16" Bench Scroll Saw	300 175	

SENCO AIR NAILERS			
SFN1+	Finishing Nailer 1" - 2"	w/ cs	448 299
SN325	Nailer 1-7/8" - 3-1/4"		665 365
SLP20	Pinner w/cs 5/8" - 1-5/8"		422 229
SKS	Stapler 5/8" - 1-1/2"		390 279
SN70	Framing - Clip Hd 2 - 3-1/2"		725 449
SN65	Framing - Full Hd 2 - 3-1/2"		709 379
SN600	NEW Framing 2 - 3-1/2"		699 369
SFN40	Finish Nailer 1-1/4" - 2-1/2"		569 349

NEW Accuset Nailers by SENC0			
A100LS	Finish Stapler 1/2" - 1"		180 119
A150LS	Finish Stapler 1/2" - 1-1/2"		220 149
A125BN	Brad Nailer 5/8" - 1-1/4"		160 99
A200BN	Brad Nailer 5/8" - 2"		215 139

BOSTITCH AIR NAILERS			
Model	Description	List Sale	
N80S-1	Stick Nailer	Super Sale	325
RN45	Coll Rod Nailer 3/4" - 1-3/4	845	279
N60FN-2K	Finishing Nailer w/ case	557	275
BT35-2K	Brad tacke 5/8" - 1-3/8" with case		279 125
CWC100	1 HP Pancake Compressor	440	305
M11FS	Flooring Stapler 15 gauge	902	529
S32SX-1K	Finish Stapler-1/2" - 1-3/8" with case & oil		269 145

JORGENSEN ADJUSTABLE HANDSCREWS					
Item#	Jaw Opening	Length	Capacity	List Sale	Box of 6
#0	8"	4-1/2"	20.35	12.10	66.95
#1	10"	6"	23.30	12.90	71.95
#2	12"	8-1/2"	26.75	14.90	83.95
#3	14"	10"	33.65	18.55	105.75

PONY CLAMP FIXTURES			
Model	Description	List Sale	
50	3/4" Black Pipe	15.45	8.50 92.50
52	1/2" Black Pipe	12.65	6.95 74.95

PANASONIC CORDLESS			
Model	Description	List Sale	
EY6100FQKW	12V 3/8" Drill kit w/ 2 Ironman batteries, 15 min. charger, & case		379 179
EY6101FQKW	12V 1/2" Drill w/ 2 Ironman batteries, 15 min. charger, & case		324 199
EY6290FQKW	NEW 15.6V Drill Kit with 2 Ironman batteries, 30 minute charger & case		425 209
EY3503FQKW	NEW 5-3/8" 12V Wood Cutting Saw Kit		500 259

BIESEMEYER FENCES			
Model	Description	List Sale	
T-SQUARE 52	52' Homeshop	360	275
T-SQUARE 40	40' Homeshop	335	265
T-SQUARE 28	28' Homeshop	325	245

SAY AIR NAILERS			
Model	Description	List Sale	
0241SC	Brad Nailer 3/8" - 1-9/16"		160 99
0626SK	1/4" Crown Stapler 3/8" - 1-1/4"		96

STABILA LEVELS			
25010	10" die cast Torpedo Level	43	29
24640	24" Level w/ hand holes	62.20	43
24670	48" Level w/ hand holes	79.70	58
24610	48" Level w/ angle setter w/ rail		89

1998 TOOL CATALOG AVAILABLE
Call Toll-Free 1-800-328-0457 In Minn. Call (612)224-4859
FAX: (612)224-8263 • www.7cornershdw.com
CHECK • MONEY ORDER • VISA • MASTERCARD • DISCOVER
SEVEN CORNERS ACE HDW. INC.
216 West 7th St. • St. Paul, MN 55102 • Est. 1933

We are one of the last mail order companies to provide

FREE FREIGHT!

Order with confidence from Tools On Sale™.

There are no hidden charges.

TOOLS ON SALE™
AMERICA'S LOWEST PRICED TOOLS
FREE FREIGHT TO THE 48 CONTINENTAL STATES ON EVERY ITEM
PRICES SUBJECT TO CHANGE WITHOUT NOTICE

DEWALT TOOLS			
Model	Description	List Sale	
DW309KNEW	Recipro Saw 10 amp.	310	169
DW378GNEW	7-1/4" Framers Saw	218	169
DW222	3/8" Drill, 0-1200 rpm, 6.7 amp		184 99
DW231	1/2" Drill, 0-850 rpm, 7.0 amp		240 129
DW236	1/2" Drill, 0-850 rpm, 7.8 amp with keyless chuck		264 149
DW124K	1/2" right angle Drill	590	329
DW321K	Top Handle Jigsaw Kit	300	164
DW364	7-1/4" Circ. Saw w/brake	294	162
DW610	1-1/2 HP 2 handle Router	266	149
DW411K1/4	sheet Palm Sander w/ cse&8	548	159
DW682K	Biscuit Joiner with case	448	199
DW705	12" Compound Mitre Saw	734	359
DW625	3 HP v/ spd Plunge Router	279	279

DW625	router comes with DW6913 edge guide!		
DW621	2 HP Plunge Router	400	218
DW621	comes with Free DW6956 line height adjuster!		
DW675K	3-1/2" Planer with case	292	164
DW677K	3-1/4" Planer w/ case	260	155
DW431	3 1/2" v/spd Belt Sander	338	188
DW421	5" Palm Plan. Orb Sander	144	74
DW423	Palmgrip Random Orbit Sander	170	94
DW421	& DW423 come with Free DW4317 case!		

DW673K	Laminate Trimmer Kit	364	188
DW272	Drywall Gun, 0-4000, 6.3 amp	160	95
DW276	Drywall Gun, 0-2500, 6.5 amp	160	95
DW935K	14.4V 5-3/8" Trim Saw Kit	444	237

DEWALT CORDLESS DRILLS			
DW952K	2-3/8" v/spd w/ two 9.6V XR batteries	284	129
DW972K	2-3/8" variable speed w/ two 12V XR batteries	362	182
DW972KQ-2	Above drill kit with 15 minute charger		222
DW904	12 volt		

Scrollsawing's new frontiers

"About 97 percent of our scrollsaw sales are to woodworkers, but the other three percent includes some unconventional users," says Jim Beckerdite, director of field sales for Harrisonville, Missouri's rbindustries, Inc. The company manufactures Hawk scrollsaws, planers, sanders, and other wood-working machines.

Jim has met artists and entrepreneurs across the nation who put

Cleanly cutting cloth quilting squares requires a layer of stiff cardboard or 1/4" plywood at top and bottom and a cardboard insert every 15 layers. Tape keeps the fabric from shifting.



the company's scrollsaws to unusual challenges. One is a caterer in Reno, Nevada. She saws frozen steaks into the shape of company logos, then serves these logo steaks off the grill at business functions.

Judy Tyler, a quilter in Holly Pond, Alabama, found cutting out squares with scissors tedious. One day she watched a craftsman demonstrate a scrollsaw. Now, Tyler saws out all the squares for a quilt in about 20 minutes. Depending on the fabric and the machine, a scrollsaw can cleanly cut through 50-60 layers of cloth (see photo left).

Scrollsaws cut glass, too, notes Jim. Watch public television's *Stained Glass with Vicki Payne*. Payne regularly scrollsaws irregular shapes. Judy Suttlemeyer, a Laramie, Wyoming, jewelry artist, uses her scrollsaw to saw precious metals for earrings, pendants, pins, and other wearables. Jim has also heard of scrollsaws in regular use cutting coins, Corian, and marble.

China: The Great Wall and lots of trees

Although China only recently rescinded restrictions on the use of lumber and wood products for building construction, the country has always had plenty of trees. According to the Western Wood Products Association, China ranks as the world's fifth largest forest land owner and eighth largest commercial timber owner. The country's greatest use of wood to date, though, has been for cooking and heating fires.



What a relief!

Raleigh, North Carolina, woodcarver George Thomas captured a familiar autumn scene around most of the nation with his relief carving, "Wayside," shown here. Measuring 34x70" and less

than 2" thick, the stained basswood scene of a farmer with his produce at roadside earned George *WOOD* Magazine's People's Choice Award and the accompanying \$500 prize at last year's International Wood Carvers Congress held at the Putnam Museum in Davenport, Iowa.

Sponsored by the Affiliated Wood Carvers, Ltd., the woodcarving show and competition is held annually the last full week in June and draws top international carvers. For more information, write to the Affiliated Wood Carvers, Ltd., P.O. Box 104, Bettendorf, IA 52722. 🌲

This relief carving of a farmer with his roadside produce was awarded *WOOD* Magazine's People's Choice Award at the International Wood Carvers Congress.

Photographs: Bill Krier;
International Woodcarvers Congress
Illustration: Jim Stevenson

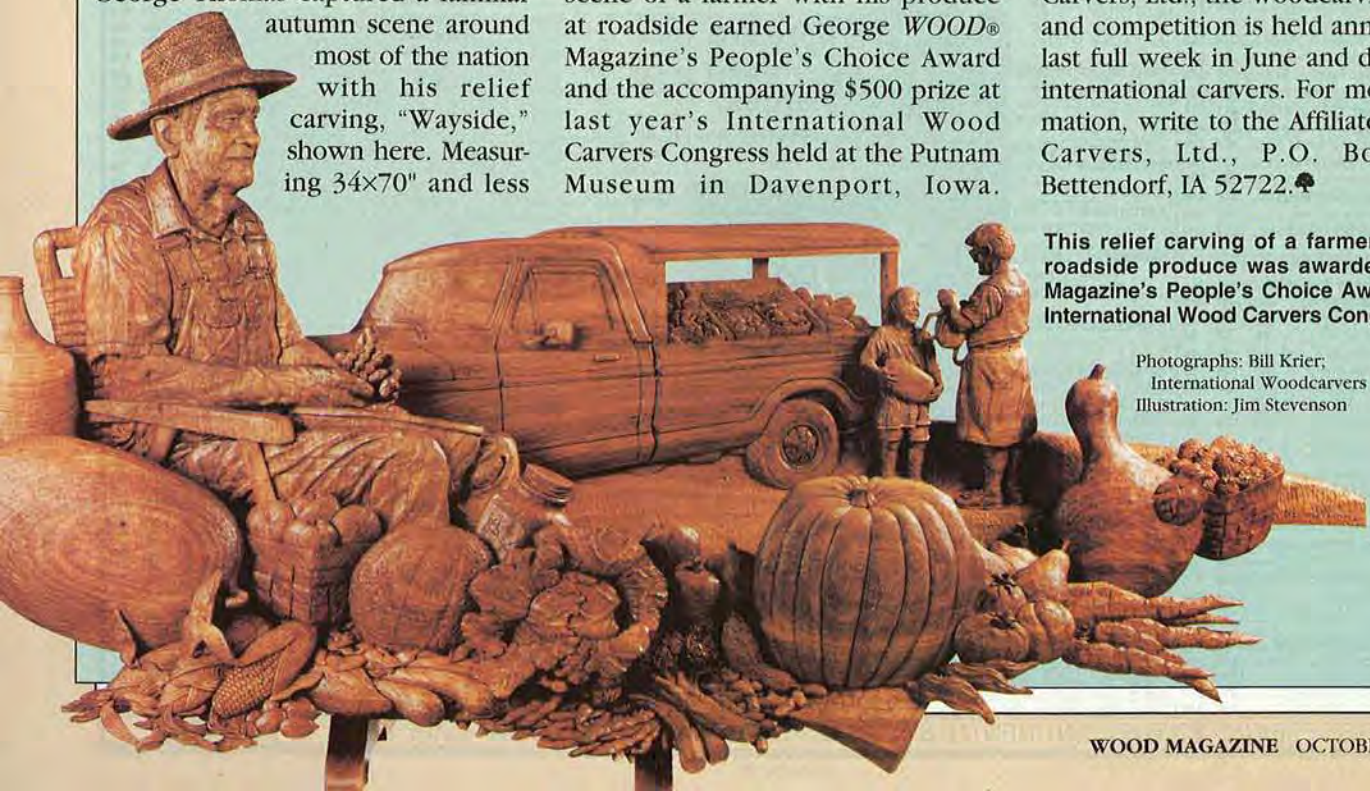

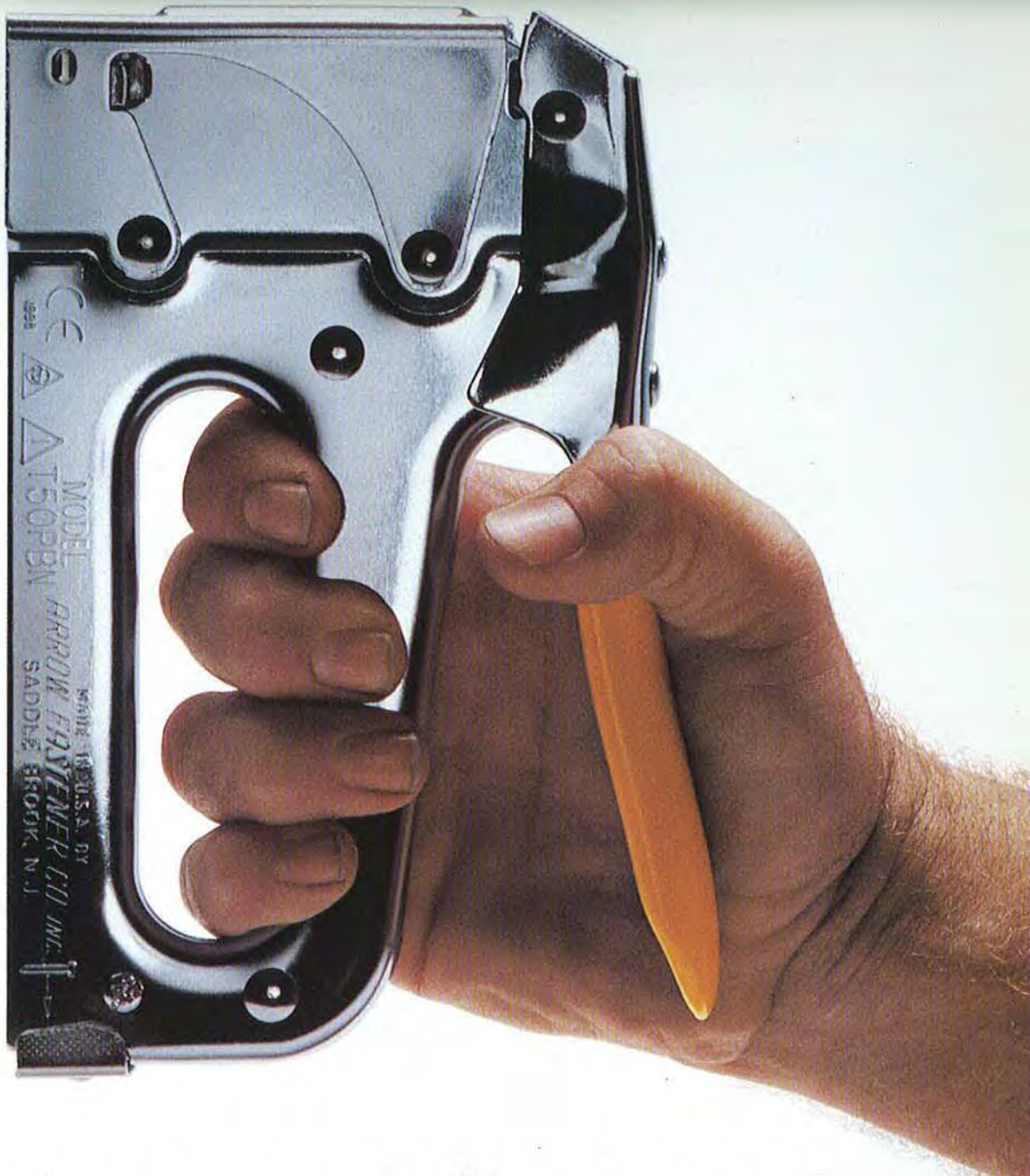

Want your nails done?

IT'S A NAIL GUN. IT'S A STAPLE GUN. AND IT'S NEW FROM ARROW.

Polish off just about any job with Arrow's versatile T50PBN hand stapler. This amazing new gun shoots six sizes of staples as well as 5/8 inch brad nails. Plus, it's jam-proof and slip-proof.



It's made in the U.S.A. with solid steel components, not plastic parts like some other staple guns. Where can you get this handy little tool? Where else? The Home Depot.



Makita

Ultimate Cordless



Model 63430WA

Intense Power

404 in/lbs of Raw Torque

25% Longer Run Time than the Competition

Industrial Metal Gear Housing

1/2" Keyless Chuck

It's a Real Saw

Huge 6-1/2" Blade for Cutting 2x's at 45°

50% Longer Run Time – 47 2x10s Per Charge

20% Faster Cutting than the Competition

50° Bevel for Maximum Capacity



Model 56200WA



Cuts a 2x4 at 45°

18VOLT

6 1/2" Circular Saw
& 1/2" Drill

For more information,
call 1-800-4-MAKITA.

18V
2.0Ah

WOOD PATTERNS

For your woodworking convenience

OCTOBER 1998

ISSUE 108

Dear Reader: As a service to you, we've included full-sized patterns on this insert for irregular-shaped and intricate project parts. You can machine all other project parts using the Bill of Materials and the drawings accompanying the project you're building.

Wooden Stems Nightstand Box-Joint Jig



Page 74



Page 52



Page 49

© Copyright Meredith Corporation, 1998. All rights reserved. Printed in the U.S.A.

BOX-JOINT JIG FULL-SIZE PATTERN

See page 44

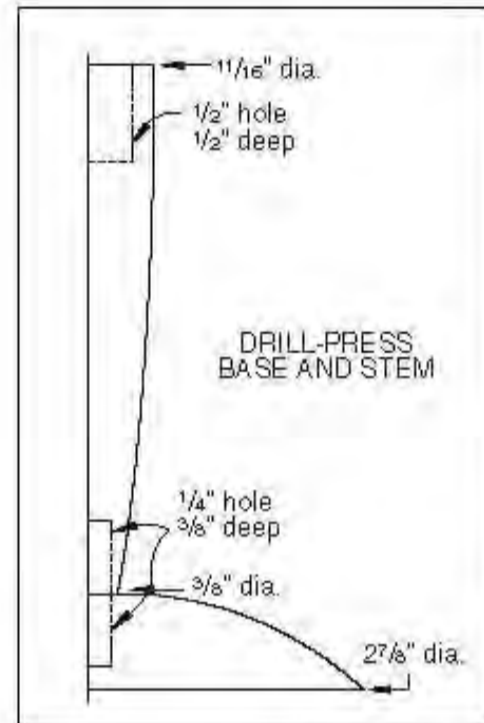
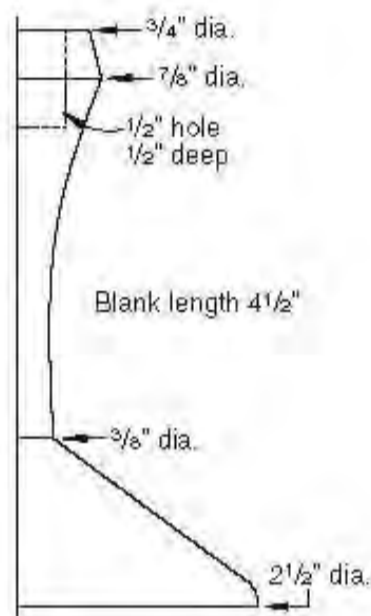
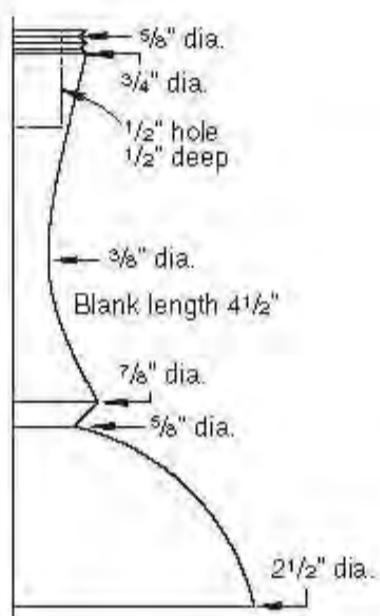
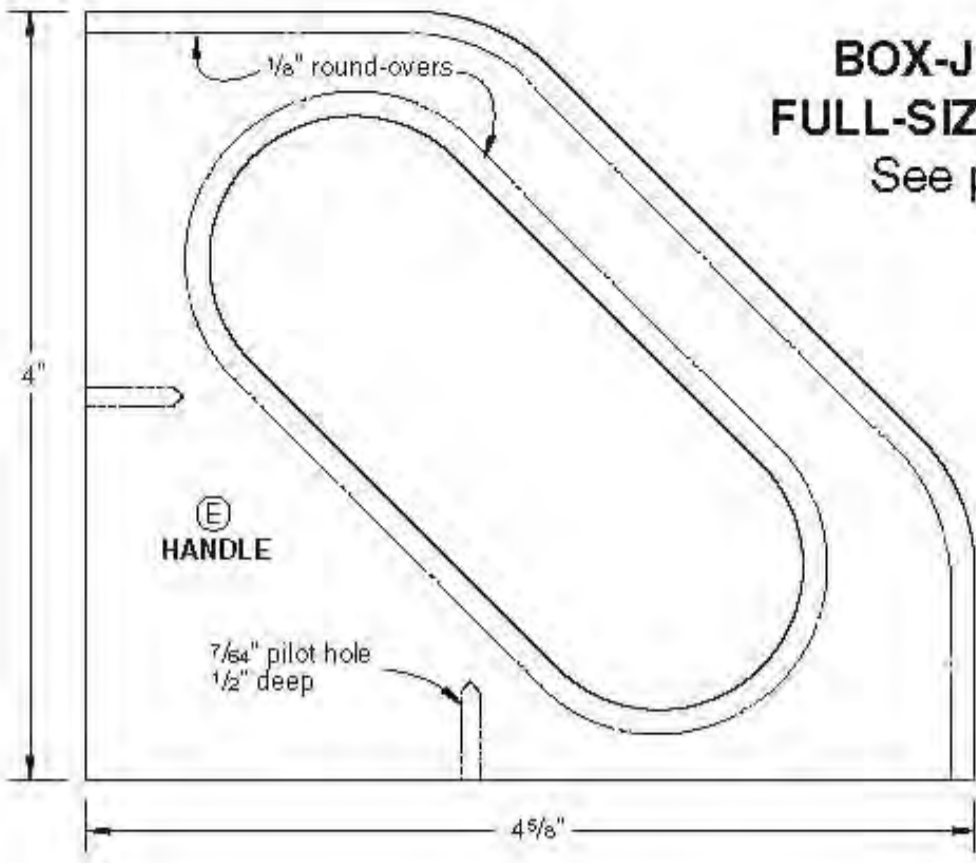

WOODEN STEM GLASSES FULL-SIZE PATTERNS

See page 74

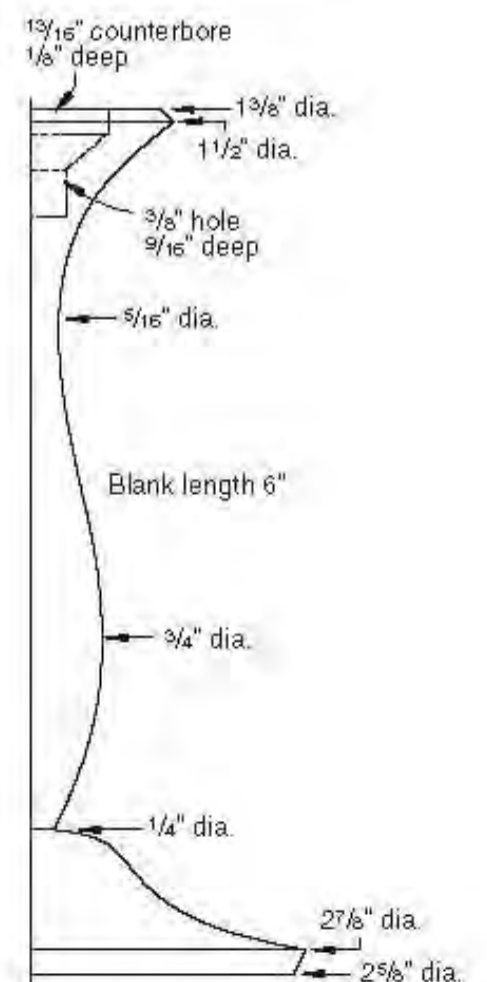
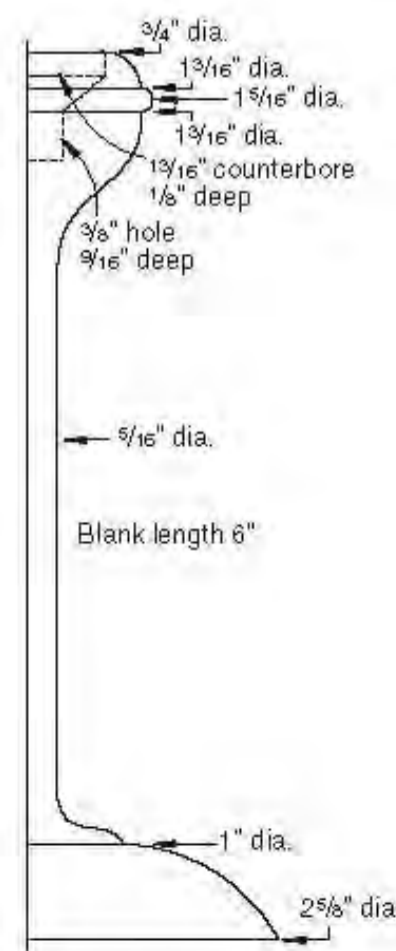
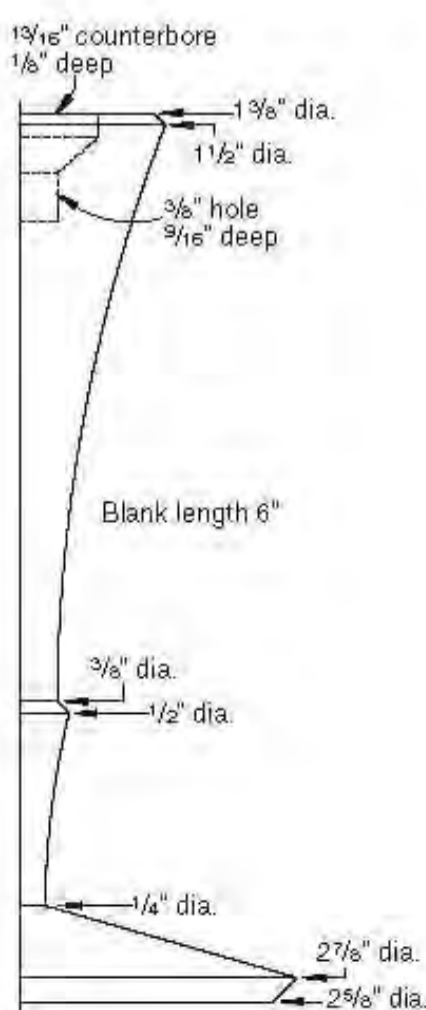
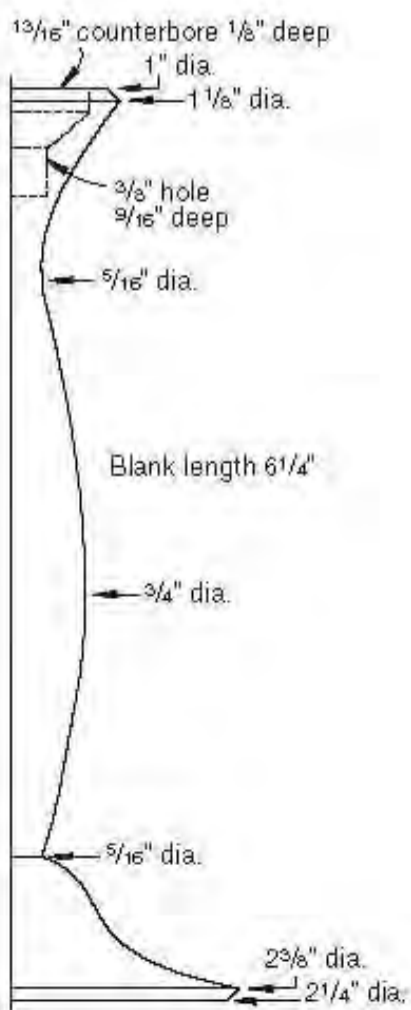
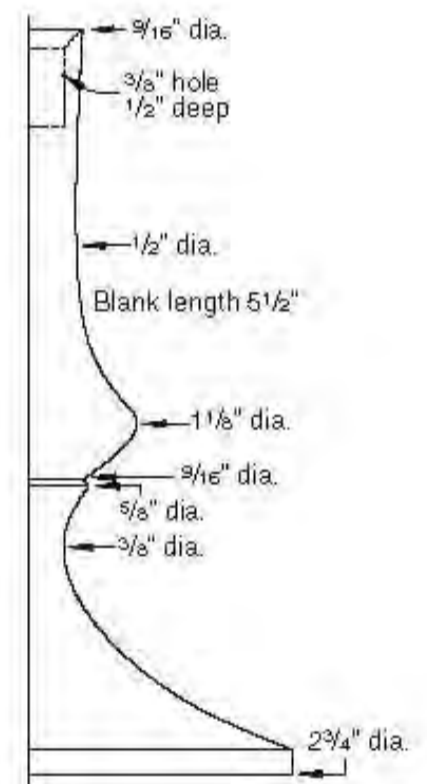
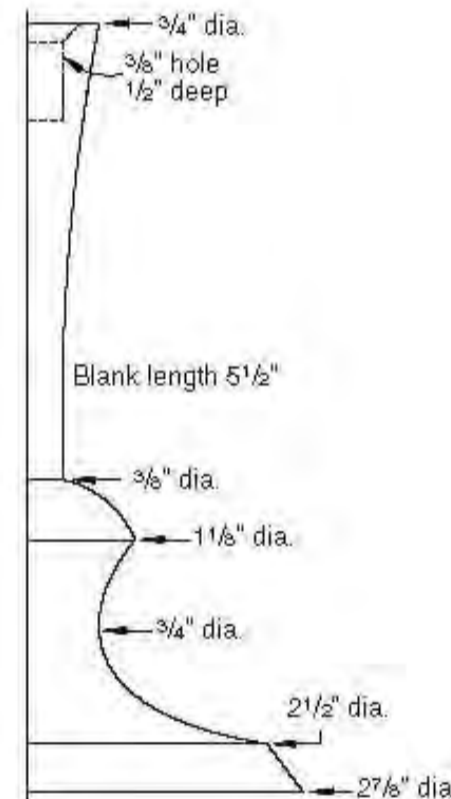
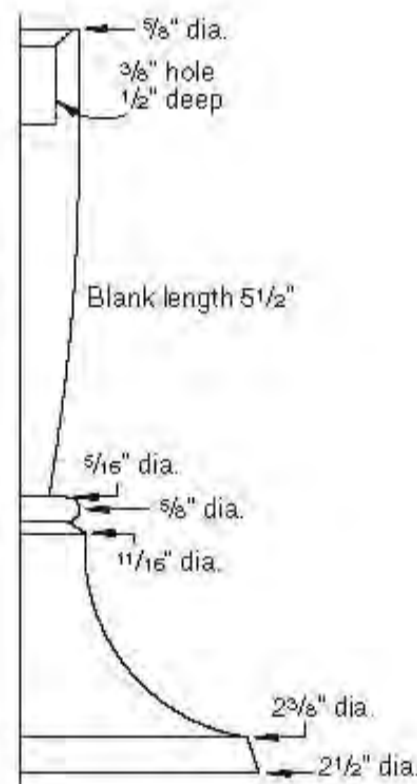

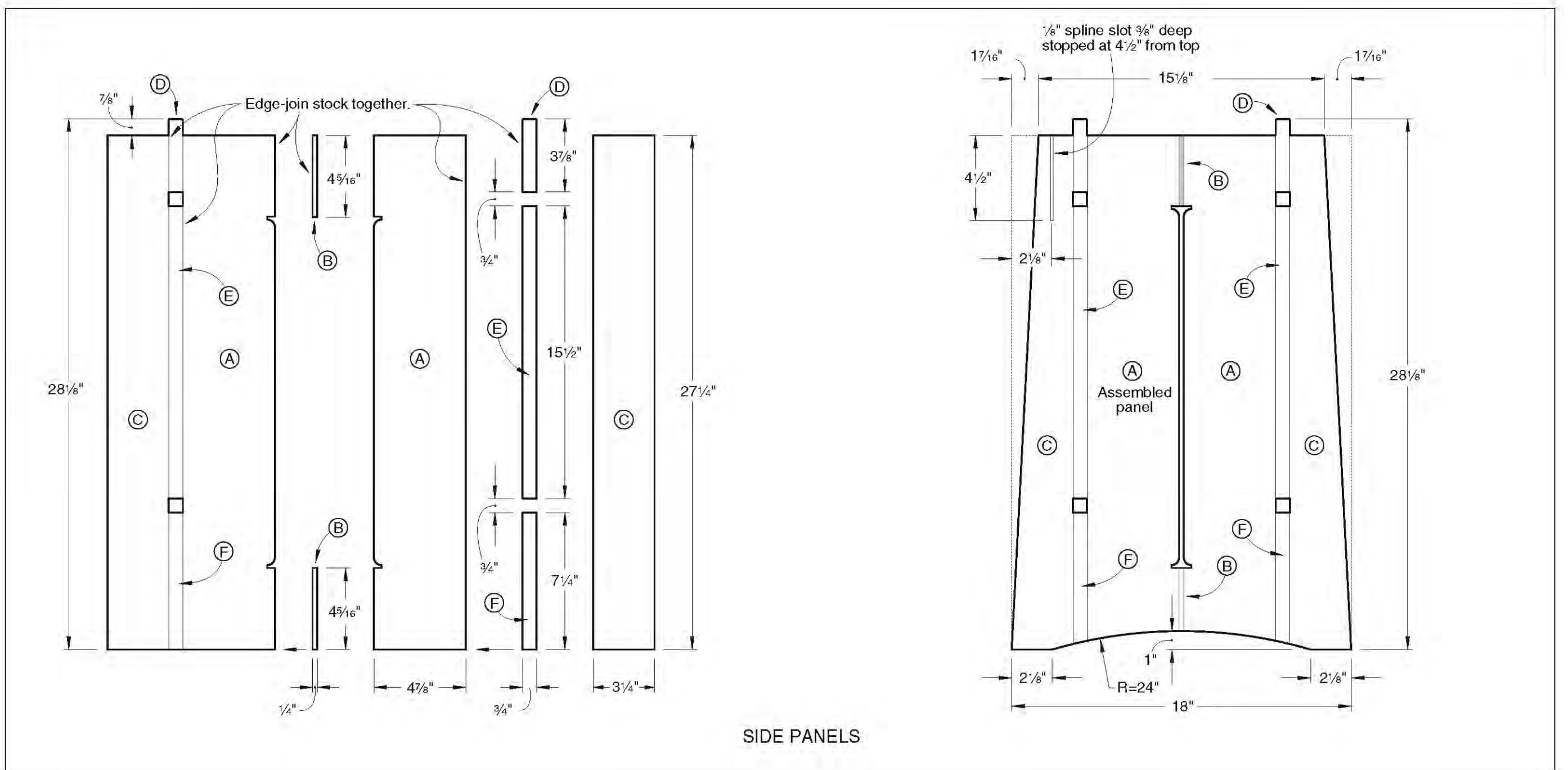

SIDE PANELS

PARTS VIEW

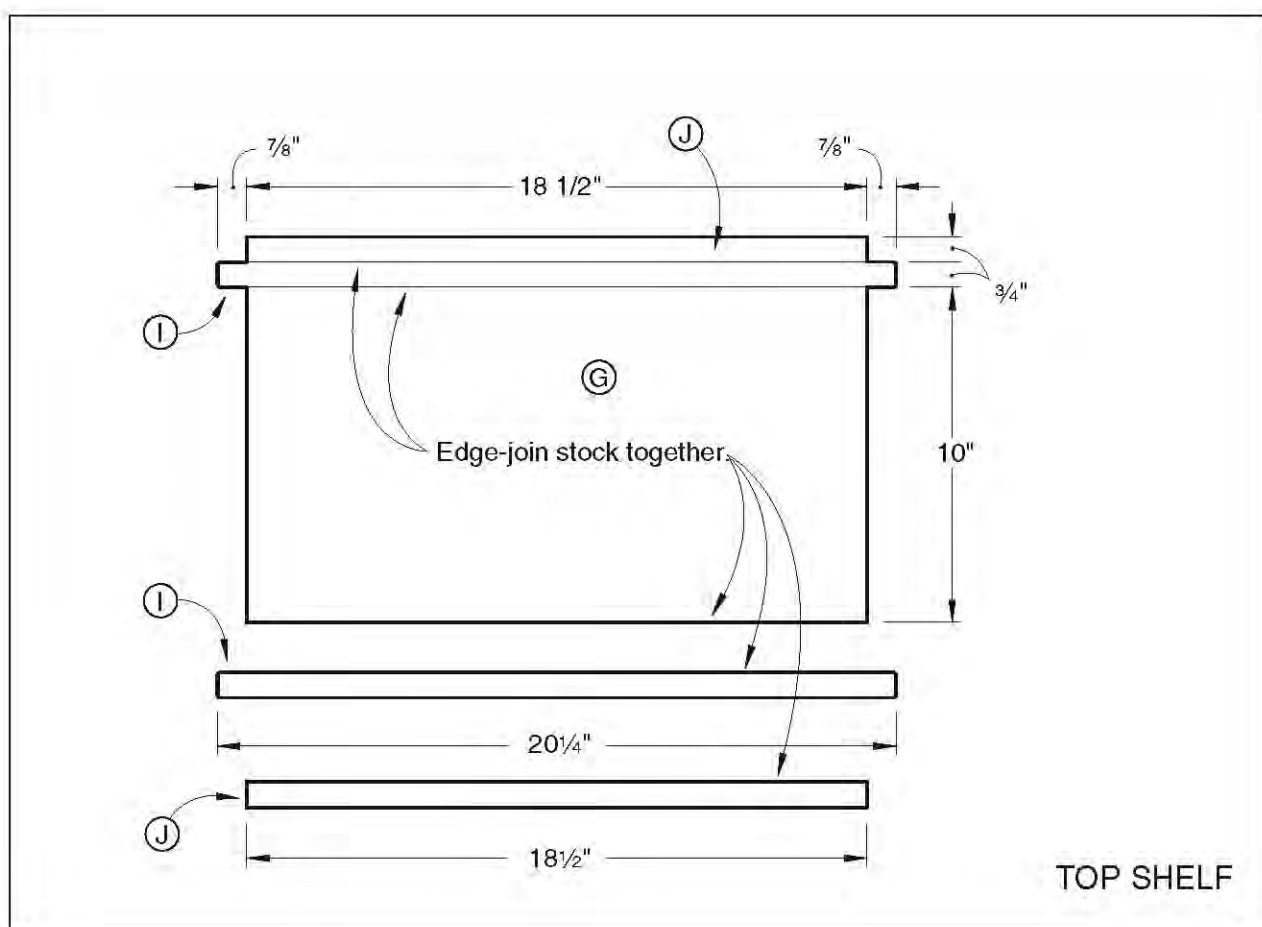

TOP SHELF

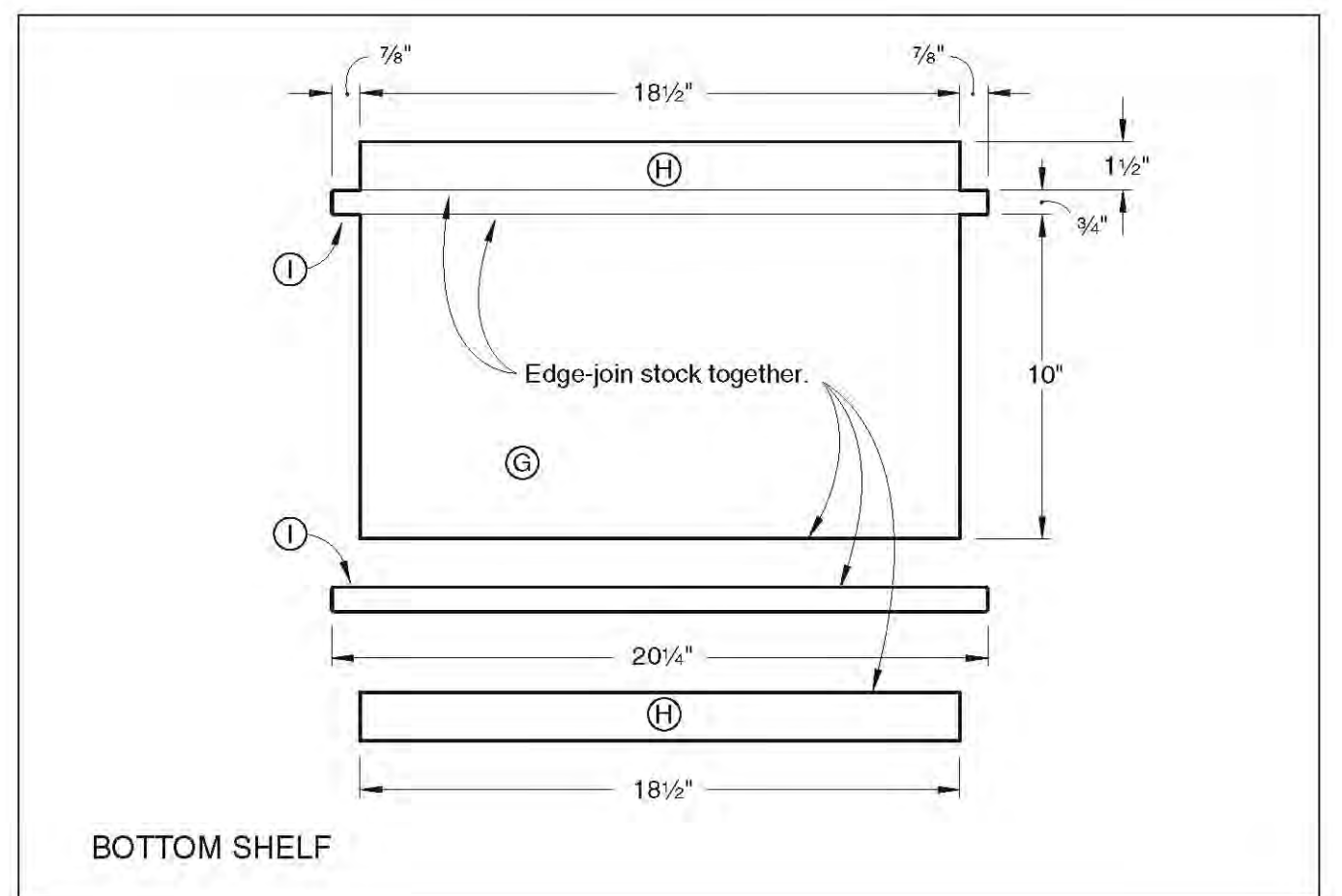

BOTTOM SHELF

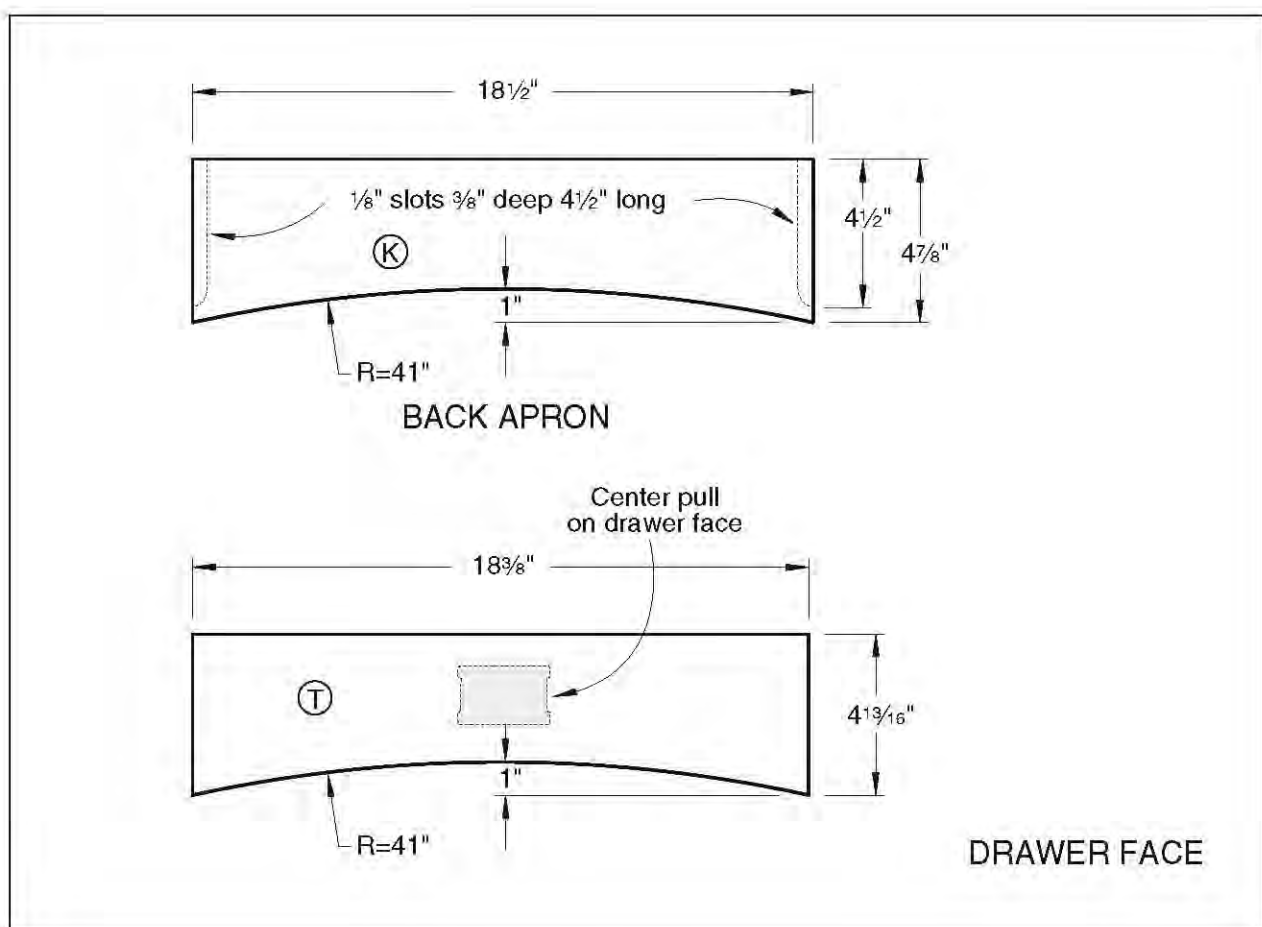

NIGHTSTAND
See page 52

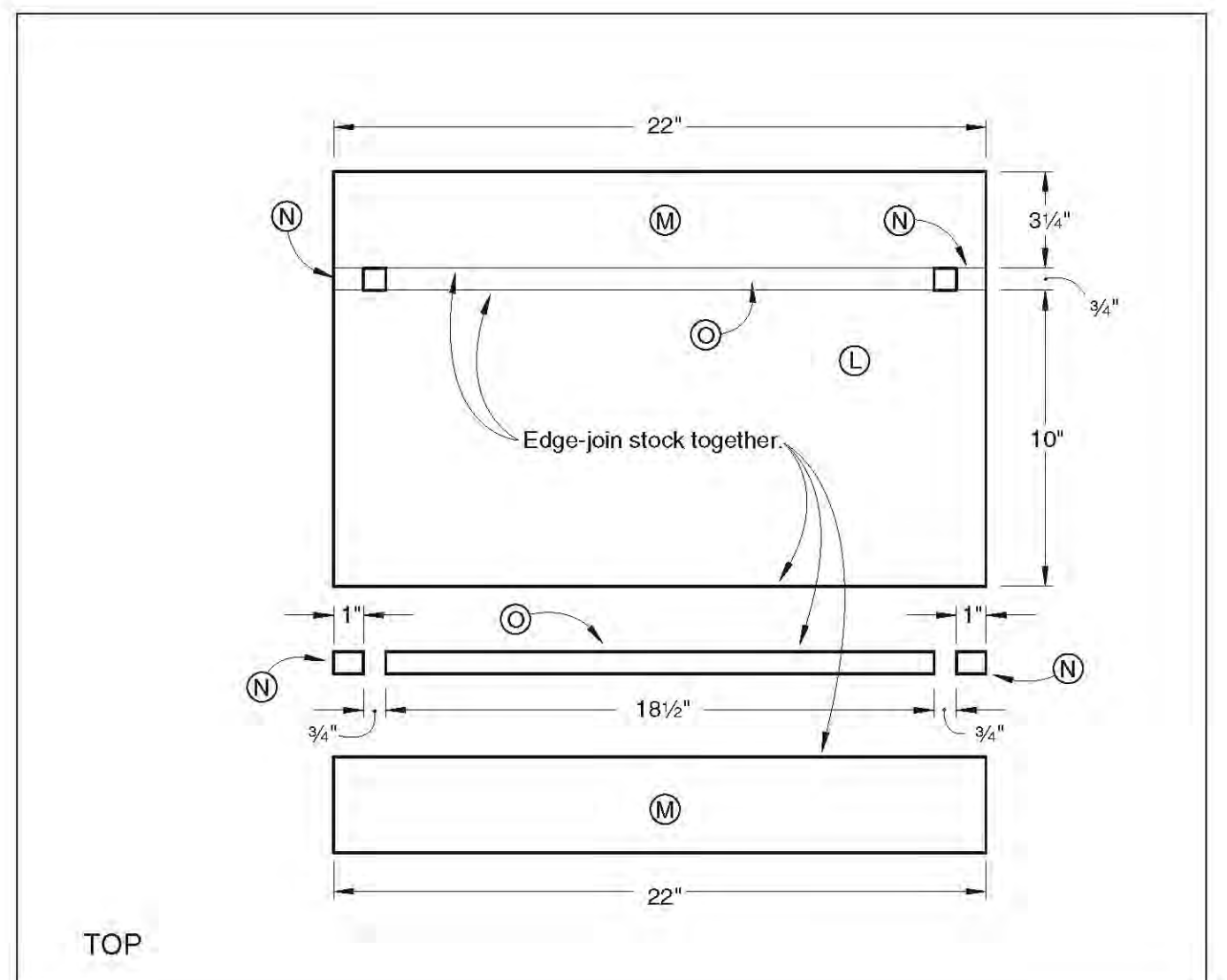

TOP