

HOME-IMPROVEMENT EXTRA **CUSTOMIZED WOOD FLOORS** after page 92

Better Homes and Gardens®

WOOD®

THE WORLD'S LEADING WOODWORKING MAGAZINE

ISSUE 122 MARCH 2000

Handy and handsome

FOLDING TRAY TABLES

See page 82

Impressive Projects!

- Walnut Hall Table and Mirror
- Miniature Gas-Pump Clock
- Sandbox Dump Truck
- Sportsman's Turned Walking Stick

ROUTER-TABLE ROUNDUP

We help you select the right one for your shop See page 66

<http://www.woodmagazine.com>





downloaded from www.cro-wood.com

Better Homes and Gardens®
WOOD®

THE WORLD'S LEADING WOODWORKING MAGAZINE

CONTENTS



Page 49



Page 62



Page 76

45 The Story Of Wood

Discover how to identify unfamiliar North American hardwoods.

49 Furniture Designs To Go

Meet Doug Green, a Maine woodworker who has developed a unique line of take-apart furniture.

66 Router-Table Roundup

Find out which of the 16 shop-tested models suits your woodworking needs.

76 Outstanding Banding

Learn how to make fancy inlays for enhancing projects—it's easier than you might think.

111 Extra! Customized Wood Flooring

Get up to speed on available products, design possibilities, and wood floor installation.

Woodworking projects

54 Exceptional Entry Suite

This matching hall table and mirror will dress up any entry—traditional or contemporary.

62 Gas From The Past

Reminiscent of days gone by, this novel gas-pump clock tells both the time and temperature.

72 One Huge Hauler

Your kids or grandkids will spend many happy hours with this sandbox dump truck.

82 Folding Tray Tables

Handsome inlay banding makes this project a welcome addition to your home's decor.

88 Woodturner's Walking Stick

Just the thing for a walk in the woods, this hiker's companion includes a compass.



Page 54



Page 82



Page 72

SHORT-SUBJECT FEATURES

4 The Editor's Angle

6 Talking Back

10 Great Ideas: Double-Duty Clamp Rack

15 Safe Starting With A Gouge

16 Workshop Puzzler

18 Router-Bit Review: Multi-Profile Bit

25 Hot Off The Internet

28 Ask WOOD

34 Need To Know: Cutting Huge Holes

38 Tips From Your Shop (And Ours)

111 Products That Perform

128 Finishing Touches

Where do we find all those great project designs, anyway?

Every year, we take a serious look at several hundred woodworking projects for possible inclusion in the magazine. Our in-house designers (Jim Downing, Jan Svec, and Chuck Hedlund), with help from others on the staff, select what they consider to be the best of the best for your building pleasure.

As you may imagine, choosing just the right projects is tricky business. Some readers want to see more large-scale furniture, and others prefer quick-to-make gift items. Still others come to *WOOD* magazine looking for attractive carving and turning projects, children's toys, or scrollsaw projects. You name it. Our strategy always has been to provide you with a well-rounded project menu from which to choose.

Jim, Jan, Chuck, and other staffers come up with many of the projects on their own. But we also depend heavily on the woodworkers and designers we meet in our travels around the country.

Typically, we venture out about a dozen times a year in search of projects, interesting craftspeople, and article ideas we think you might like. Almost always, we hit pay dirt.

On a scouting trip to the San Francisco area a while back, I once again met and chatted with a fair number of woodworkers I'd never met before. One of the most interesting is Ken Byers, who along with his wife, Jeanne Tillemans, operates Shaker Works West in San Francisco.

Photographs: Larry Clayton



Ken Byers, a new woodworking acquaintance of mine, showing his meticulously crafted miniature Shaker and country reproductions.

They produce miniature museum-quality reproductions of Shaker and country furniture. That's Ken

in the photo above. After viewing his beautiful work and chatting with him for a while, I feel that if we ever need help with a Shaker or country project, we could count on Ken's expertise. You can reach him at www.etropolis.com/mini/shaker or e-mail him at mekendar@pacbell.net.

Earn \$\$\$\$\$ By Being One Of Our Freelance Scouts

We'll pay you a \$100 finder's fee every time you tip us off to 1) a project we publish in *WOOD* magazine, 2) any woodworker we feature in a craftsman profile, or 3) any other article idea we use. You may not get rich, but you can feel good knowing that you have contributed to keeping *WOOD* magazine the very best woodworking publication around.

To tip us off, send a snapshot of the project or the craftsman (his name and address), or a short note describing your article idea, to:

My Article Idea
WOOD magazine
 1716 Locust Street, GA310
 Des Moines, IA 50309-3023

Larry Clayton

Editor **LARRY CLAYTON**
 Managing Editor **JIM HARROLD**
 Assistant Managing Editor/Products **BILL KRIER**
 Senior Editor/Features **PETER J. STEPHANO**
 Senior Editor/Special-Interest **LARRY JOHNSTON**
 General-Interest Editor **DAVE CAMPBELL**
 Senior Design Editor **JAMES R. DOWNING**
 Assistant Design Editor/Project Builder **JAN HALE SVEC**
 Shop Manager/Project Designer **CHARLES I. HEDLUND**
 Senior Associate Art Director **PERRY A. McFARLIN**
 Assistant Art Director **CHERYL A. CIBULA**
 Production/Office Manager **MARGARET CLOSNER**
 Administrative Assistant **SHERYL MUNYON**
 Art Business Office Secretary **BARBARA HELPS**
 Reader-Contact Specialist **BEN VON RUDEN**
 Contributing Editors **KIM DOWNING, DAVE HENDERSON, LORNA JOHNSON, ROXANNE LeMOINE, BOB McFARLIN, CARSON ODE**

©Copyright Meredith Corporation 2000
 All rights reserved. Printed in the U.S.A.

Better Homes and Gardens® *WOOD*® magazine (ISSN-0743-894X) is published nine times a year in January, February, March, April, June, August, October, November, and December by Meredith Corporation, 1716 Locust St., Des Moines, IA 50309-3023. Periodicals postage paid at Des Moines, Iowa, and additional mailing offices. *Better Homes and Gardens* trademark registered in Canada and Australia. Marca Registrada en México. **ONE-YEAR SUBSCRIPTION PRICES:** U.S. and its possessions, \$27; Canada, \$39; other countries, \$47. Canada Post Publications Mail Sales Product Agreement No. 1369350. Canadian BN 12348 2887RT. **CANADIAN RETURN ADDRESS:** *Better Homes and Gardens* *WOOD* magazine, 2744 Edna Street, Windsor, Ontario, N8Y 1V2. **POSTMASTER:** Send address changes to *Better Homes and Gardens* *WOOD* magazine, P.O. Box 37439, Boone, IA 50037-0439.

CUSTOMER SERVICE 800/374-9663: Use this number for subscription services, changes of address, billing questions, questions for our editorial staff, questions about how to reach an advertiser, or to place an advertisement in our magazine. **To order back issues 800/346-9663. Subscription mailing address:** *Better Homes and Gardens* *WOOD* magazine, P.O. Box 37439, Boone, IA 50037-0439. Please enclose your address label from a recent issue. **Editorial mailing address:** The Editor, *WOOD* magazine, 1716 Locust Street, GA310, Des Moines, IA 50309-3023. Reprints are \$5 per article.



Better Homes and Gardens®
WOOD Online®
 at www.woodmagazine.com



Don't keep your computer equipment piled on an old table or desk any longer. Instead, build this handsome three-

piece corner combo designed especially for a computer. Build all of the components or just the parts you need. You can get the plans right now from the downloadable project plans page on *WOOD ONLINE*. It's plan no. DP00015, and it only costs \$5.95.

ROPE TURNINGS OAK and MAPLE



A0913
IN STOCK
NO
MINIMUM

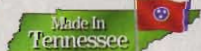

FREE CATALOGUE



Adams Wood Products™ L.T.D., L.P.
974 FOREST DR., DEPT. M44
MORRISTOWN, TN 37814
TEL 423-587-2942 • FAX 423-586-2188
www.adamswoodproducts.com

Circle No. 1002

Better Homes and Gardens WOOD Advertising & Marketing THE WORLD'S LEADING WOODWORKING MAGAZINE

Publisher **WILLIAM R. REED**
Associate Publisher **MARK HAGEN**
Ancillary Sales and Internet Manager **MARLEN KEMMET**
Advertising Services Manager **PAT HENDERSHOTT**

Chicago Advertising Office: 333 N. Michigan Ave., Suite 1101,
Chicago, IL 60601 Phone: 312/853-2890 FAX: 312/580-7906
Advertising Managers **JAMES N. FORD, WILL MURPHY**
Direct Response Advertising **CAROLYN DAKIS**
Marketing Specialist **GERALLIE LEGASPI**
Sales Assistant **MARGARET TRAVIS**

Des Moines Advertising Office: 1716 Locust St., GA204,
Des Moines, IA 50309-3023 Phone: 515/284-3575 FAX: 515/284-3343
Senior Salesperson **RICH RAINFORTH**
Direct Response Advertising **NATASHA KUCHERENKO**
Administrative Assistant **KRISTI HASEK**

Classified Advertising: Phone: 800/424-3090 FAX: 312/464-0512

Publishing Director **JERRY WARD**
Circulation Director **LIZ BREDESON**
Associate Circulation Director **KATHI PRIEN**
Business Manager **JANET DONNELLY**
Senior Product Manager **RICK GROW**

MEREDITH PUBLISHING GROUP

CHRISTOPHER M. LITTLE, President
ELLEN DELATHOUDER, Creative Services;
BRUCE HESTON, Manufacturing; **KARLA JEFFRIES**, Consumer
Marketing; **JERRY KAPLAN**, Group Sales; **BOB MATE**, Integrated
Marketing; **BILL MURPHY**, Strategic Marketing; **HAL ORINGER**,
Consumer Marketing and Interactive Media; **DEAN PIETERS**,
Operations; **MAX RUNCIMAN**, Finance; **THOMAS L. SLAUGH-**
TER, Licensing and New Media



WILLIAM T. KERR, President and Chief Executive Officer
E. T. MEREDITH III, Chairman of the Executive Committee

TALKING BACK

A nail keeps router pad rolled

I found the router pad storage idea in issue #116's shop tips very practical and decided to build it. But when it was completed, I rolled up the pad as was shown and discovered that the rubber pad has a tendency to unroll itself. To keep it rolled tight, I drilled a hole through the dowel and into the bracket, then inserted a nail. Now it stays neatly in place.

—Guy Boisseau, Quebec

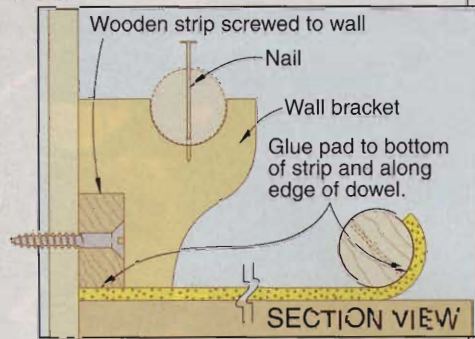

No free nails!

Thank you for the short article on square nails in "Ask WOOD" in issue #117. However, the writer left the impression that our sample kit was free. In fact, the price of the set is \$9.95 ppd., which includes 20 patterns of steel cut nails mounted on card stock that carries a brief history of nail-making.

—William T. Driscoll,
Gen. Mgr., Tremont Nail Co., Wareham, Mass.

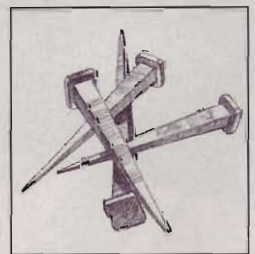

Quick-Fit system was Grizzly

The dust-collection ductwork and fittings featured in IDEA SHOP® 2000 in issue #119 were inadvertently credited to the wrong supplier. The duct and fittings are part of the Quick-Fit system available from Grizzly Industrial (800/523-4777).



Here's how to keep your brush in suspense

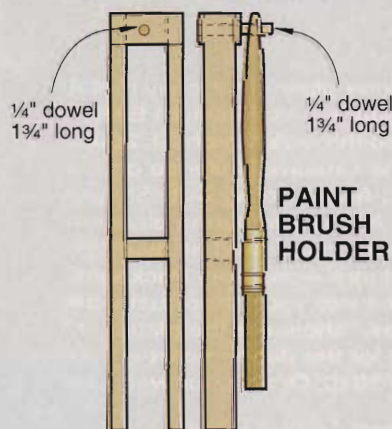

Regarding your advice about caring for brushes in issue #117, I have something to add. If I am going to use the same brush for a number of days, I place it in a large, covered glass jar and use a simple scrap wood fixture (shown at left) to suspend it. Then I pour in the proper solvent to cover the bristles and about 1/4" of the ferrule, and screw the lid on the jar. When I need the brush to continue my finishing job, I take it out and dry the brush's bristles with paper towels.

—Calvin Ditch, Sun City, Calif.

We would like to hear from you

We welcome your comments, criticisms, suggestions, and yes, even compliments. We'll publish letters of the greatest benefit to our readers. Write to: Talking Back, WOOD Magazine, 1716 Locust St., GA310, Des Moines, IA 50309-3023

Continued on page 8

Continued from page 6

An addenda to outdoor wood

I design and sell decks and screen porches, so I was especially thrilled to see the two-part article on building outdoor projects in issues #115 and 116. But I would like to add some of my own observations.

Wood used outside does not *always* cup away from the center of the tree. It usually cups toward the sun because wood swells when wet, then the sunny side dries and shrinks first, which causes upward cupping. So always use the prettiest side up for decking.

Regarding new pressure-treated southern yellow pine, it should be allowed to dry for a week or two (in dry weather), then finished. Some producers now treat wood with paraffin wax in conjunction with CCA preservative to reduce weather checking. This wood should be finished when water no longer beads on it.

On a final note, South American hardwoods require sealing of the board ends to reduce checking. And due to their hardness, they do require pre-drilling even when using self-tapping screws. By the way, another decking wood is Pacific Coast cypress, which is even more weather and insect resistant than redwood or red cedar.

—Rodney Brooks, Greenville, S.C.

Thanks for your comments, Rod. Mark Knaebe, a researcher with the U.S. Forest Service's Forest Products Laboratory, in Madison, Wis., basically agrees with you, but notes that pressure-treated wood must be thoroughly dry only before painting, although painting decks isn't recommended. Also, all types of outdoor wood benefit from end-sealing. And regarding Pacific Coast cypress, that's actually a trade name for Alaska yellow cedar. Because it's denser and more oily than redwood or western red cedar, it could be more insect and weather resistant than either.

It's a Yankee in the photo

On page 46 of issue #115 there's a photo showing men working on Chris-Craft boats, and you mention electric screwdrivers in the caption. I think that if you look a little harder you'll see that the workers are using good old Yankee No. 30A, spring-loaded, hand-powered, ratchet screwdrivers. I still have my Dad's.

—Bill Andrews, Wheaton, Ill.

Yes, Bill, that does look like a Yankee screwdriver that the man in the center of the photo is using to set screws.

But the collection curator at the Mariners' Museum in Newport News, Va., calls our attention to the men at the second boat back, who are using electric drills, not electric screwdrivers as we called them in the referenced article.



Practical crank for panel clamps

Three cheers and a 21-gun salute regarding the article on building panel clamps in issue #112. I had to build them as soon as possible. However, using a locked wing nut or a wrench to tighten the clamps was just too much hassle. Instead, I designed this crank to make everything a bit simpler.

—Larry LeRoy, Dolores, Colo.

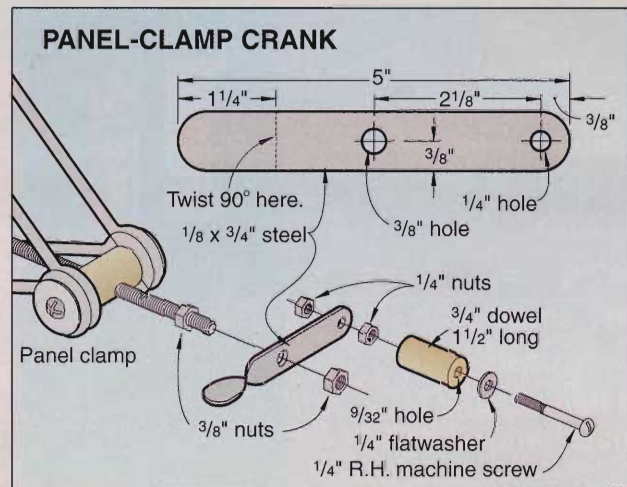

More panel-clamp improvement

I made the panel clamps in issue #112. But facing the panel edges with waxed paper doesn't work well enough because the paper becomes torn or wadded up in use. I experimented with facing the "gluing" edge of the clamps with Formica and thin plexiglass adhered with Titebond II. Each worked equally well and the panel came loose easily.

—Russell G. Clausing, Overland Park, Kan.

Thanks for the good tip, Russ. Our projects builders, though, would use contact cement on the plastic laminate and double-faced tape on the acrylic.

On a metric note

I'd like to point out the superiority of the metric system. Whether building a piece of furniture or making a home repair, the metric system lends itself to both speed and more accuracy.

Consider, for example, dividing the measurement $21\frac{13}{16}$, or 554 mm in metric. In metric, you can arrive at 277 mm by mental calculation. But calculating half of $21\frac{13}{16}$ isn't that easy or error-free.

I suggest that magazines such as yours follow the current industrial practice, which entails listing all dimensions in fractions and showing the metric equivalent directly above in parentheses.

—Melvin W. Brzostek, Womelsdorf, Pa.

Melvin, when the United States as a whole shifts to metrics, WOOD® magazine will be sure to follow.

Double-Duty Clamp Rack

It can hold lumber, too!

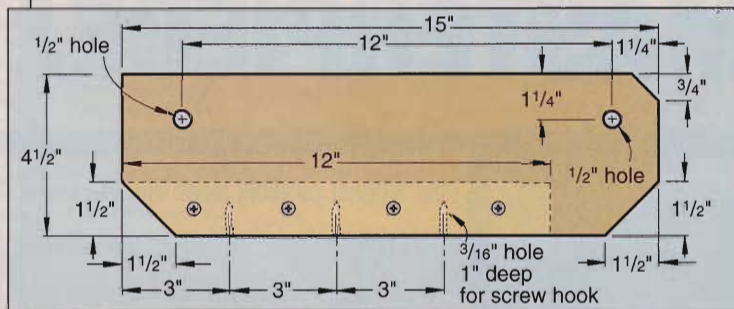
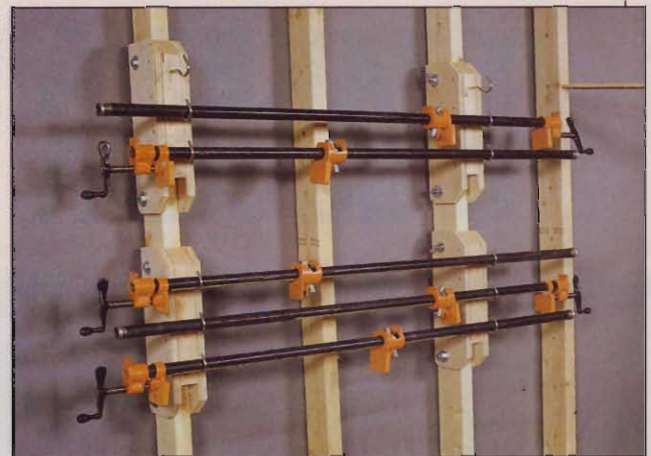
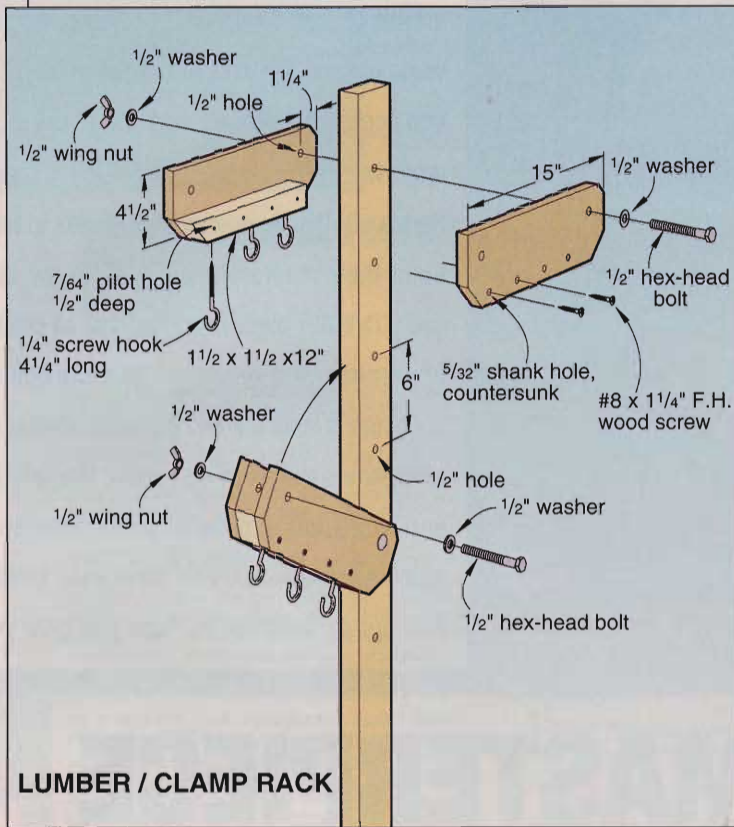

Lumber inventories in the typical home woodworking shop always vary. If you stock up on material to make a big project or a lot of holiday gifts, the stacks of lumber on the floor can become a traffic hazard. But if you build a permanent home for those planks, the space sits idle when your wood supply dips.

Here's one solution—foldable racks that can keep pipe clamps tucked against the wall, but drop for instant

lumber storage when you need it.

With sides of 3/4" plywood and center blocks of 2x material, these brackets are strong and easy to make. The rear pivot point rotates around a 1/2" bolt that's placed in the wall stud or, if the wall studs are covered, in a 2x4 upright secured to the top and bottom of the wall. The series of holes (on 6" centers) in the stud or upright lets you position the brackets right where you need them, and also pro-

vides a locking bolt location when they're folded.

The clamp-holding feature requires just three 1/4x4 1/4" screw hooks threaded into each center block. They'll hold 1/2" and 3/4" pipe clamps, as well as clamp styles with square or rectangular bars. Find all the needed hardware at your local hardware retailer or home center. ♣

Illustrations: Roxanne LeMoine
Photographs: Hetherington Photography

SAFE STARTING WITH A GOUGE

Every between-centers lathe project you do begins with using a gouge. Done incorrectly, it can be dangerous. Here's how to do it right and safely.

To get a piece of stock from square to round on a lathe, woodturners turn to gouges. Using one properly makes it a quick and easy task. Remember the following advice, and you'll be able to do it, too.

Cut with the line of support

When a turning gouge's steel circular shaft touches the tool rest, only a small section actually contacts it. This is the supported area. Trying to cut with any part of the gouge to the left or right of this area can result in grabbing of the work and damage to the wood, or worse.

You'll see this effect if you rest a gouge on your workbench. Hold the handle as you normally would, then press down on the left or right side of the gouge—the areas not contacting the bench. The tool twists. Now push on the part of the gouge in contact with the table. Nothing happens because that part of the tool is supported by the table. Cutting on the lathe with a gouge works the same way. Use the supported area and all you have to do is guide the tool.

With the gouge on the tool rest, imagine a line from the handle to the cutting edge passing through the point of contact between the tool and the tool rest. That's your support line, as shown in the drawing at right. And where it reaches the cutting edge is where the tool should contact the wood. If you roll the tool left or right, the line moves and the point of contact with the wood moves with it.

Bevel controls cut depth

Lowering the gouge's cutting edge onto the upper surface of the workpiece gives you greater control over the depth of cut and lets the tool sup-

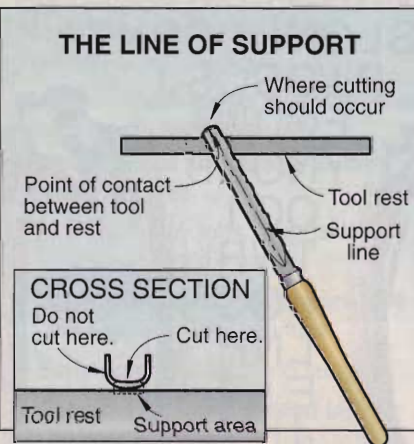
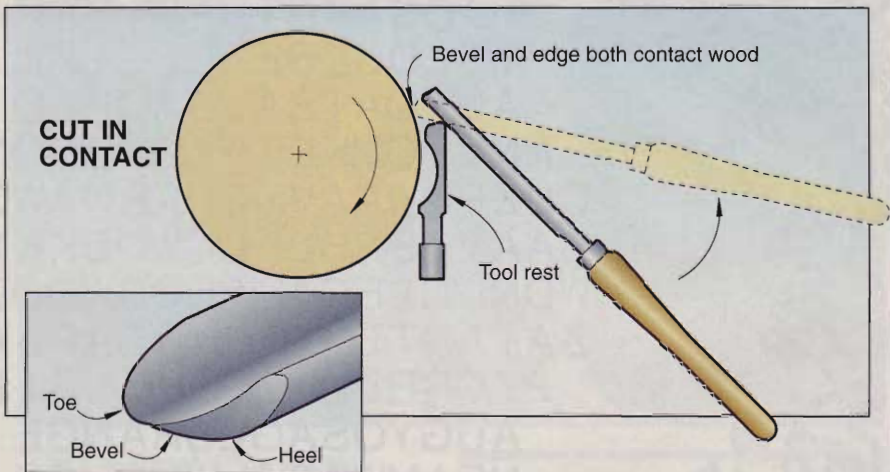

port itself, as shown in the drawing above top. Start with the handle lowered and the cutting edge above the work. Then slowly raise the handle.

First, the heel of the tool, then the bevel edge comes in contact with the wood. You'll feel it, and know precisely where the wood is in relation to the cutting edge. Continue raising the handle slowly, lowering the cutting edge into the wood. With very little practice, you'll be able to produce paper-thin shavings under precise control.

"Where Safety Begins" is written by Mike Gililand, a safety consultant and lifelong woodworker. If you have a safety-related question, send it with an SASE to: The Safety Man, WOOD Magazine, 1716 Locust St., GA310, Des Moines, IA 50309-3023. Not all questions received will be published, but all will get a reply.



Keep the bevel in contact

Much to the surprise of many woodturners, the best results happen when both the cutting edge and the tool's bevel contact the wood at the same time. When the tool's bevel is flat against the wood, the edge makes a clean cut and the depth of cut is controlled by the tool. Raising the handle creates a deeper cut because the bevel no longer controls its depth.

Practice locating this bevel-controlled position. And keep the suggestions below in mind. You'll find woodturning becomes safer, easier, faster, and produces better results.

- Always wear a face shield. It will protect you from flying chips or other objects imbedded in the wood (especially green wood).
- Before you turn the lathe on, check its speed setting. Out-of-round pieces generally require slow speeds, such as 800 rpm. For later shaping cuts, speed up the lathe to 1,500 rpm.
- For better tool stability, position the tool rest within 1/2" of the workpiece. To test for clearance, rotate the work by hand with the lathe turned off. ♣

Drawings: Lorna Johnson

The woodiest tree in the forest....

CBT
 EEYORPK
 LPKPCAAMF
 PFPOROEPZAI
 AOSAKETHEBIDR
 MSLDUESEERLSLRD
 AULOATSALBAOEW
 KNTIOMKETPICMGMON
 CUZPDWAAVIRRKRNAW
 BAAYAERHLVUCW
 WDNLNLECAMPHORWOODQ
 ZAI AATLTOUSDOFARRAM
 PTCRRLALNYODALEIL
 AUGYOSAGEORANGE
 NEAMWBCILWVIUCN
 WWSLONLLSPXTL
 PWOSOSJ
 EGDWA
 YNOBB
 OOI
 TWR
 UGC
 LNH
 EIR
 JKD

Here's an unusual tree—it's made up of three dozen species of wood. They include native hardwoods, a softwood or two, some familiar exotic woods, and some you may never have heard of. We marked the first one on the list to get you started. Now it's up to you to find the others. They may read up, down, across, or diagonally, but not backwards. You'll use some letters more than once.

Here are the woods you should find.

Afrormosia
 Aspen
 Basswood
 Blackwood
 Bocote
 Brazilwood
 Camphorwood
 Canarywood

Chakte kok
 Cypress
 Elm
 Eucalyptus
 Fir
 Goncalo alves
 Granadillo
 Ironwood

Jelutong
 Kingwood
 Koa
 Lignum vitae
 Madrone
 Makore
 Manzanita
 Maple

Myrtlewood
 Osage orange
 Padauk
 Paper birch
 Pau amarello
 Pine
 Purpleheart
 Teak

Walnut
 Wenge
 Yellow birch
 Yew

Illustration: Brian Jensen



MULTI-PROFILE BIT

What to know before you buy this heavyweight cutter

With cutting wings about 2" in height *and* diameter, a multi-profile bit is among the largest router bits you can buy. Also known as a multi-form bit, this considerable mass of steel and carbide doesn't come cheap. You can expect to pay upwards of \$60 for high-quality versions of this bit.

Because of its hefty size, only use this bit mounted in a router-table application. And for safe and effective machining, your router should have a motor of at least 2 hp, a collet that accepts 1/2" shanks, and variable-speed control so you can slow it down to about 15,000 rpm. Also, be sure your router table and fence have bit openings of at least 2 1/4".

Is this big bit right for you?

Although we have a multi-profile bit in the WOOD® magazine shop—we

have to tell you like it is—we just don't use it a lot. That's because we have a full array of round-over, ogee, and cove bits, to name a few types. But if you own a limited number of bits, or you just like to design your own profiles, this bit may be what you need. By varying the height of the bit and the orientation of your workpiece, and making multiple passes, you can produce an unlimited array of profiles. Just a few of the possibilities are shown *below*.

Keep these points in mind when using a multi-profile bit

Because the pilot bearing doesn't come into play with most of the cuts you make with this bit, you will typically need to guide your workpieces against a fence. For that reason, you can't rout curved edges when cutting most profiles.

When cutting with the lower portion of the bit—below its widest point—you need to take several safety precautions. First, keep foremost in your mind that a large portion of the bit is exposed above the workpiece surface. Keep your hands well clear of the bit, use a fence-mounted guard that shields the bit, and employ pushsticks as often as possible.

The portion of the bit above and overhanging the workpiece also can create a potential for kickback. Should the workpiece lift up during routing, it could strike the spinning bit and go flying. To prevent this calamity, hold the workpiece down firmly with featherboards mounted to the fence on both the infeed and outfeed sides of the bit.

Written by Bill Krier with Chuck Hedlund
Photograph: Marty Baldwin
Illustrations: Roxanne LeMoine

SOME OF THE PROFILES YOU CAN CUT WITH A MULTI-PROFILE BIT

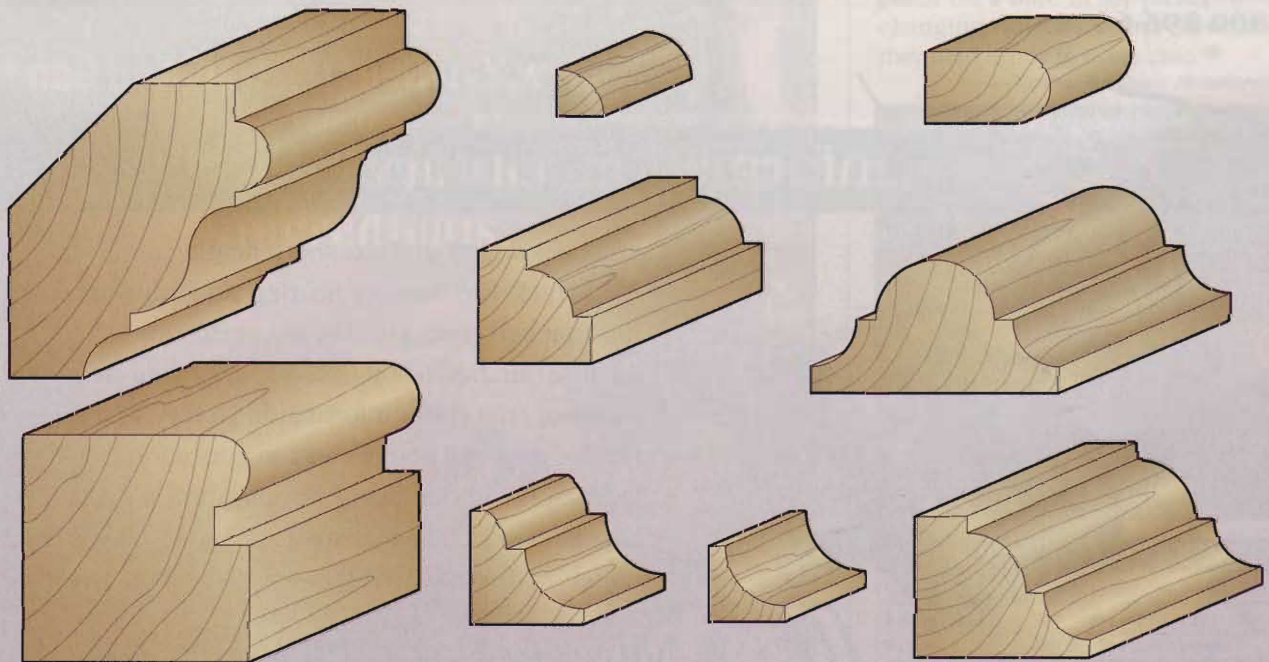

WOODWORKERS TO THE RESCUE

Comments, answers, and ideas from our **WOOD ONLINE®** discussion groups

How to resuscitate hard putty

I have several cans of Famowood Wood Putty that has hardened with time. What is the solvent used in this product that I can add and salvage the remaining putty?

—Steve Slaughter, Beaver Dam, Ky.

● If you can't find Famowood's solvent, try acetone or methyl ethyl ketone (MEK). These are available readily in the paint departments of stores. MEK evaporates quicker than acetone, so if you are planning to fill something like screw holes, you might want to choose the acetone to help with shrinkage. I also thin the product for normal usage. This practice makes it easier to pack the putty into small spaces.

By the way, when I'm done using the solvent-based fillers, I always add a capful of the solvent to the can before I close it up. This helps slow the hardening of the material in the can. I store the cans on their lids to also slow the hardening.

—Jim Frye, Toledo, Ohio

● Steve, we called Eclectic Products, the maker of Famowood. A company representative said acetone will work in a pinch, but suggested that you use Famosolvent, a blend of solvents formulated specifically for Famowood. This blend evaporates more slowly than acetone. If you don't find Famosolvent where Famowood is sold, call Eclectic Products at 800/767-4667.

—WOOD® Magazine

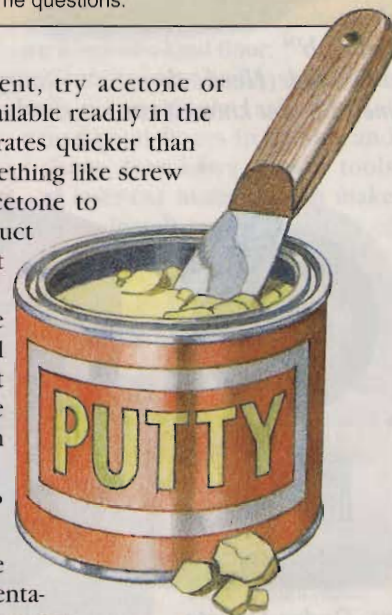

Problems with planing cherry

When I use my Delta planer to plane cherry boards, it takes little chips out of the wood. That doesn't happen with walnut or pine. I only take a very small amount of wood with each pass. Any suggestions for planing cherry?

—Mark Eyer, address unknown

● On some pieces, it is hard to find the right feed direction for the board as the grain changes direction midway in the piece. What I try to do is examine the grain on the edge of the piece that I'm about to plane. The wood will tend to fracture along the grain lines. So, visualize the planer blade cutting into the wood; if it will tend to cut along the grain lines, you're more apt to get chipping. Reverse the feed direction of that piece and see what happens.

—Bob Chapman, Monclair, N.J.

● I have planed a lot of cherry and never had your experience. I suggest you check your blades for sharpness.

—Ron Evers, Beeton, Ont.

● As already suggested, use sharp knives and take light cuts. Also, run your boards through the planer at an angle (approximately 30-40°). This helps with any type of highly figured wood.

Although slower, you can do the rough stock removal with a planer, then use a drum sander. Follow that with cabinet scrapers. ♣

—Robert Schaub, Salem, Ore.

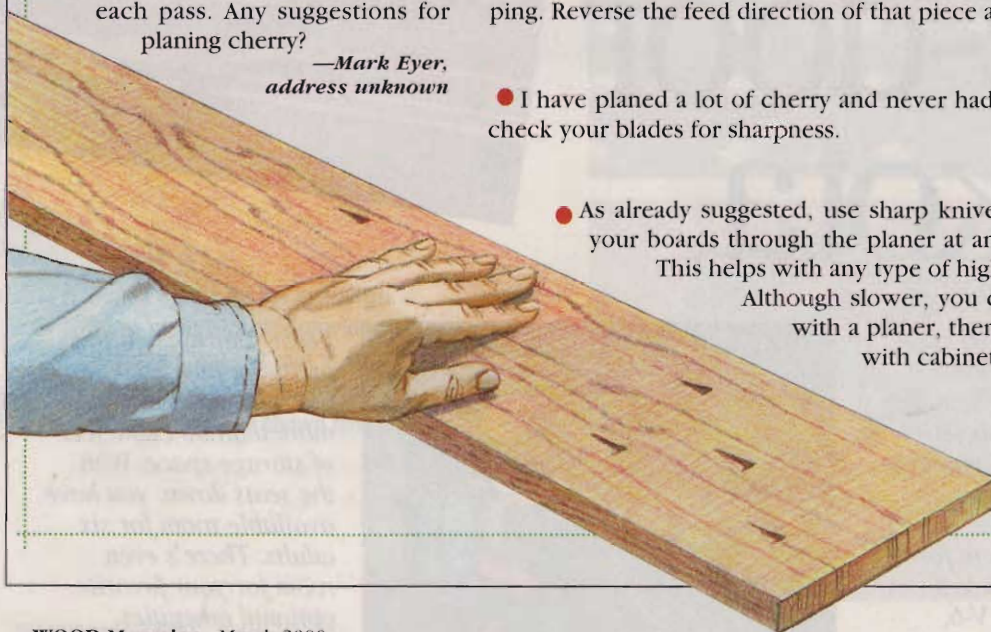

Are You Stumped?

If you've got a question that you think would interest other readers, we would like to hear from you. Write to: Ask WOOD®, 1716 Locust St., GA310, Des Moines, IA 50309-3023. For an immediate answer to your question, try posting it on one of our 10 internet discussion groups at: www.woodmagazine.com

Light turns wood dark: Any cures?

I use hardwoods for most of my projects, and I particularly like padauk and purpleheart. It's disheartening, however, to see my padauk projects turn from a deep red to near black within a month's time. One turning, kept in a drawer, hasn't been affected. Is there anything I can do to deter or prevent this color change? (I finish primarily with polyurethane.)

Tom Vullo, Brooklyn, N.Y.

Your frustration puts you in plenty of company, Tom, because color change due to ultraviolet (UV) light occurs with virtually every wood species, and most woodworkers are confounded by it. Padauk and purpleheart provide two good examples of unwanted changes, but many woods improve with moderate exposure to light—mahogany, cherry, bubinga, Osage orange, and madrone, to name a few. Trouble is, the photochemical reactions that create color changes, both good and bad, are difficult to predict even within the same species.

A senior botanist at the U.S. Forest Products Laboratory in Madison, Wisconsin, offered, "Keep it in your sock drawer," as the best advice for avoiding wood discoloration, and he was only half kidding. However, the FPL and other finishing experts we talked to did acknowledge that some marine varnishes offer a higher degree of protection against UV rays and so may slow the process. Still, the UV inhibitors in these finishes get "spent" and must be renewed with repeated applications.

One glimmer of hope did come from Jim



Dumas, the president of Certainly Wood in East Aurora, N.Y. First, he mentioned a wipe-on sealant called "303 Protectant," available through Overton's marine supplies catalog at 800/334-6541. It's not really a finish, but more of a sunscreen for things rather than people. He said he's had good luck with this product on boats and on padauk millwork in his home. He also said some turners even use Armor-All on their lathework because it, too, blocks UV rays. In any case, try it out on scrap stock first.

Dumas also mentioned another variety of padauk, known as narra (*Pterocarpus indicus*), that holds its color much better than the more common African or Andaman varieties you're probably using. Narra is harder to find and can cost more than twice as much as African padauk, but Certainly Wood stocks the veneer and sometimes narra lumber. Call them at 716/655-0206 for information.

Be careful when disposing of oily rags

I recently heard of a wood shop in my area that burned down. The cause was oily rags that spontaneously combusted. How does this happen, and how do I keep it from happening in my shop?

—Joe Freeman, Portland, Ore.



Joe, some organic substances, such as linseed oil, heat up when exposed to oxygen. This reaction can take several hours to occur, and is what causes the liquid to become solid. Most of the time the heat dissipates slowly and harmlessly into the air.

However, if you ball up an oily rag, and throw it in a trash can, the heat produced within the rag ball feeds on itself, increasing in intensity until the rag reaches its ignition temperature and spontaneously combusts.

To properly handle oily rags, spread them out on a concrete floor, clothes line, or in an airtight metal container. Once dry, you can put them in the trash.

Continued on page 32

Continued from page 28

Conflicting advice on motor voltage—110 versus 220: Which is best?

I've been told by many woodworkers that I should run my machines on 220 volts because they will run cooler, last longer, cost less to operate, and have more power. But the instruction manual for my 6" jointer states "Contrary to popular belief, rewiring your power tool to operate on 220 volts will not increase its power or energy efficiency." Who's right?

Jeff Nerell, Santa Ana, Calif.

Technically speaking, Jeff, there's some truth in both claims. Either way, the performance of the magnetic field inside the motor is identical. What makes the difference is the supply system, namely the household wiring that is providing electrical current to the machine.

The 1½-hp motor on a staffer's old Unisaw offers a good example. It came wired to run on 110 volts, and drew just under 20 amps, the real measure of its energy consumption. A 110-volt circuit provides only one "hot" line, though, so that single 12-gauge wire must carry all the current (and the heat it generates). The result is a voltage drop in the electrical circuit itself, which can create excess heat and a loss of torque in the motor. Running the machine on a 220-volt circuit divides the amperage load between *two* 12-gauge wires, each carrying only about 10 amps. Voltage drop is minimal, so the motor performs better and experiences no torque loss. The net energy use remains the same. It's the delivery system that makes the difference.

Don't rush to rewire all your machines, though, Jeff. As a general rule, single-phase induction motors up to 1 hp will gain little or no advantage when wired to run on 220 volts. With a 1½-hp machine that has to be job-site friendly, leave it wired for 110 volts. If it stays in your shop and you've got a circuit for it, you should notice some improvement with an upgrade to 220 volts. Virtually any 2-hp or larger motor needs a 220-volt circuit.

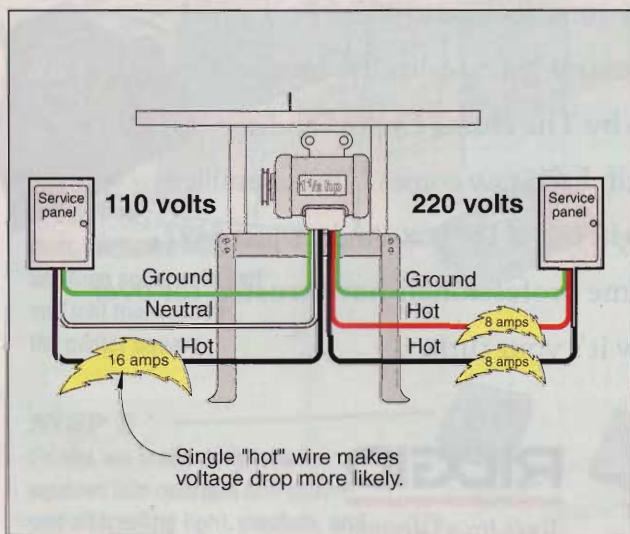

What to expect when working teak?

About 40 years ago I came into the possession of some teak lumber, the same material used in ship decking. I've kept it dry and carefully stored, and I'd like to use it to make a small table. I know almost nothing about the working properties of teak, except that it's very hard and that screw holes must be predrilled. What can I expect when I start working with this material?

Howard Hayes, Toms River, N.J.



Howard, you're right to be cautious when working an unfamiliar wood for the first time, especially a tropical species. Some contain toxic oils or extractives that can trigger respiratory or skin reactions.

Fortunately, teak is not a highly reactive species, but it does have some characteristics worth knowing. First, it tends to dry very slowly and sometimes inconsistently, but because your stock has seasoned for 40 years, that hardly poses a problem. As you might guess from the wood's density, though, teak is tough on tools. The sheer hardness accounts for some of this, but the bigger blame falls to the silica, which the tree's roots extract from the surrounding soil. This abrasive crystalline substance, concentrated more in wood from plantation-grown or juvenile trees, brutalizes tool edges. Use carbide-tipped tooling when you can, and have spares for planer knives or other cutters that are made from high-speed steel.

Teak also contains natural oils, which can make it tough to glue and finish. Just before gluing, wipe the surfaces with lacquer thinner, then moisten them slightly. Use polyurethane glue for your adhesive.

On the plus side, teak is very stable, strong, and nearly impervious to water and insect damage if cared for properly. It's great for long-lasting outdoor projects, and can be finished easily with a wipe-on oil. Lacquer is another acceptable finish, but for interior projects only. 🌳

Hints For Huge Holes

Here are some ways to bore (and rout) the big ones

When a project calls for a big hole, do you let out a little groan? Lots of woodworkers do. But big holes need not pose problems. Here are some easy ways to do the job.

Chuck in a colossal cutter

Chucking a big bit into your drill press offers the easiest method for hogging out a large hole. Large Forstner or multispur bits will drill flat-bottomed holes that don't go through the part as well as through-holes. (Forstner bits have smooth rims; multispur bits carry teeth along their rims, as shown in the photo at *right, center*.) Holesaws and adjustable circle cutters offer two more choices for big through-holes.

Comparing the cutters

✓ Forstner and multispur bits are available in diameters up to 4" from several suppliers, including Woodcraft (800/225-1153) or Woodworker's Supply (800/645-9292). Sizes generally increase in 1/8" increments beyond 2". Bits imported from the Far East cost \$20-40 each; European- or American-made ones can cost more.

✓ An adjustable circle cutter like the one shown at *right, bottom* will produce holes up to 8" in diameter. The quality of the cut usually won't equal that of the Forstner and multispur bits, but will be better than a holesaw. The capability of boring odd-size holes is a plus for this tool, widely



A large holesaw is one way to make holes big enough to reach through.

available from hardware stores, home centers, and tool dealers.

✓ Holesaws, like the one shown in the photo *above*, come in diameters up to 6". Often used by contractors, big holesaws are available at hardware stores, lumberyards, and large home centers. Interchangeable blades—usually sized in 1/8" steps—attach to a separate arbor. Holesaw prices are similar to those of the Far East Forstner and multispur bits.

Big-cutter cautions

Here are some points to remember when using these outsized tools.

- ✓ Use a drill press, and clamp the workpiece to the table.
- ✓ Run the tool at a slow speed, about 250 rpm or less, to minimize burning of the workpiece.
- ✓ When boring dense hardwoods, such as hard maple, opt for a Forstner or multispur bit rather than the holesaw or circle cutter.



A Forstner bit (right, with the smooth rim) or a multispur bit (left, with the toothed rim) bores a large hole easily.

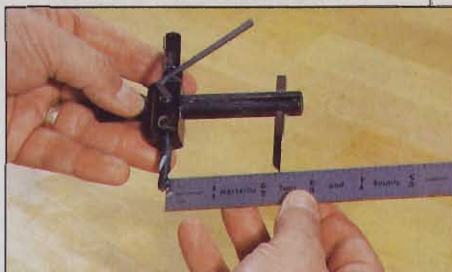

You can set the circle cutter to make any size hole. Measure the radius of the hole (half the diameter) from the center of the pilot bit to the outside of the blade.

Continued on page 36

"All my tools should be this good!"

The **Accu-Miter®** is a professional miter gauge that makes perfect angles easily. Shot-pin action assures dead-on accuracy for common angles — plus a precise protractor scale for everything in between!

Optional accessories: manual clamp—pneumatic clamp—3/8" x 3/4" miter bar—

Call or write for our free brochure.

800 Dutch Square Blvd., Suite 200, Columbia, SC 29210
1-800-382-2637 / SC 803-798-1600
www.thejdscompany.com

Precision Woodworking Equipment

JDS COMPANY

We do not recommend operating without the saw blade guard, as is shown here.
US Patent #5,038,486

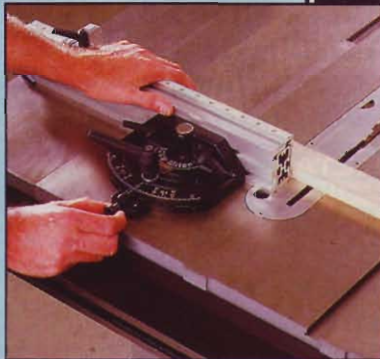

4-WAY MONEY-MAKER!

● PLANES ● MOLDS
● SANDS ● SAWS



Turn a \$2 rough board into \$25 worth of finished trim right in your own shop! Make over 350 standard moldings, tongue & groove, picture frame stock, any custom design. QUICKLY CONVERTS from Planer/Molder to Drum Sander or power-feed Multi-Blade Rip Saw! Made in U.S.A. Choose from 12", 18" and 25" Models.

Variable Feed Makes The Difference!

Just a twist of the dial adjusts the Woodmaster from 70 to over 1,000 cuts per inch. Produces a glass-smooth finish on tricky grain patterns no other planer can handle. Plenty of American-made "muscle" to handle low-cost, "straight-from-the-sawmill" lumber. 5-Year Warranty, Easy Terms.

FREE FACT KIT

1-800-821-6651 ext. PW44

Woodmaster Tools, Inc.
1431 N. Topping Ave. Dept. PW44, Kansas City, MO 64120
www.WoodmasterTools.com

WHAT WOODWORKERS NEED TO KNOW

Continued from page 34

Huge Holes

- ✓ When boring deep with a Forstner or multispur bit or holesaw, clear the chips frequently by pulling the bit out.
- ✓ To prevent tearout when boring with an adjustable circle cutter, cut most of the way through; then finish the cut from the other side, inserting the tool's pilot bit into the guide hole.

Try routing a small hole larger

In many cases you can bore a smaller hole then enlarge it, using a router, a rabbeting bit, and a pattern bit, as shown in the photo below. The length of the pattern bit presents this technique's principal limitation: The bit's maximum cutting depth limits the depth of a hole that doesn't go through a part. For a through hole, it's slightly less than twice the cutting depth of the bit, because you can work from both sides.

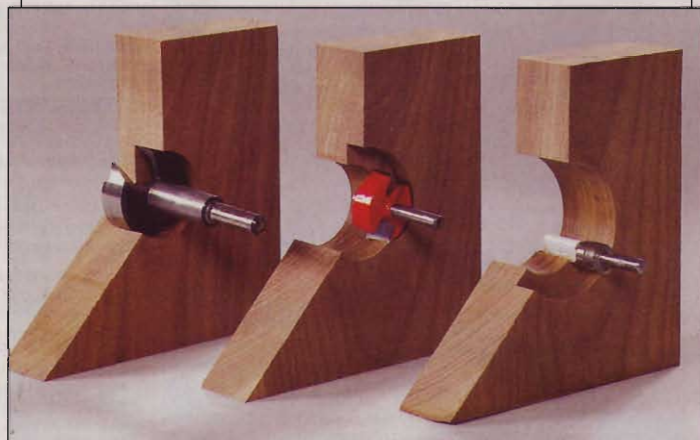

You can rout a hole larger with a rabbeting bit, (center) and a pattern bit (right).

Here's how the process works:

1 Bore the starting hole, shown at left in the photo.
2 Chuck a 1/4", 3/8", or 1/2" rabbeting bit in your router. Rout around the top of the hole, as shown in the center piece in the photo. The diameter of the enlarged hole will equal the diameter of the original hole plus *twice* the width of the rabbet. So, for instance, if you bore a 1 3/8" hole and rout a 3/8" rabbet around the opening, you'll make a 2 3/8"-diameter hole.

3 Swap the rabbeting bit for a pattern-routing bit. Then, with the top-mounted guide bearing riding in the rabbet, rout the hole to size, as shown in the piece at the right in the photo. You can repeat steps 2 and 3 any number of times to make an even larger hole.

For a non-through hole that's *shallower* than the pattern bit's length, you'll have to build up the workpiece's top surface temporarily with scrapwood before you drill and enlarge the hole, calculating the thickness to yield the desired hole depth in the workpiece. ♣

Photographs: Hetherington Photography



Top Shop Tip winner Frank Snock gets acquainted with his current shop-away-from-home at RAF Lakenheath, England, before tackling a new project.

Imagine packing up your shop—lock, stock, and barrel—every few years and moving it to a different home. During Frank Snock's 13 years serving in the U.S. Air Force, he's done that a lot, and currently our Top Shop Tip winner makes his home in the land where they call rabbits "rebates": jolly old England.

Currently, his power tools are in storage because they're not wired for the UK's 220-volt, single-line system. But, thanks to the wood shop at Royal Air Force base Lakenheath, Frank can still build projects like his "Morris futon"—a futon-sofa based on the Morris chair in *WOOD* magazine issue #112. You can be sure he'll use his setup gauge, shown at right, to align the saw before he begins.

Share a shop tip with our readers, and we'll share some green with you—\$75, to be exact—if we publish it. And, if your tip is deemed the best of the issue, you'll also get a tool prize worth at least \$250. So get those ideas on paper, including drawings or photos and your daytime phone number, and send them to:

Tips From Your Shop (and Ours)
WOOD Magazine
 1716 Locust St., GA-310
 Des Moines, IA 50309-3023

Or, e-mail them through our homepage at www.woodmagazine.com.

To help us print only original shop tips, please send your ideas only to *WOOD* magazine. Sorry, but we can't return your submissions. Thanks!

Dave Campbell
 GENERAL-INTEREST EDITOR

Use a dial caliper to align your tablesaw

When I move to a different Air Force base, one of the first things I do is check the alignment of the tools in the base's wood shop. Lacking an expensive dial indicator or alignment tool, I built a simple jig that uses my dial caliper to do the duty.

First, I cut an 18" hardwood runner to fit the saw's miter slot so that the bar stands about 1/8" proud of the saw table, as shown below. In the hardwood clamp block, I cut a dado within a dado: The first fits the dial caliper snugly to the bar, while the second provides clearance for the depth bar to move unrestricted.

Whenever I want to tune up the saw, I slide the dial caliper under the clamp block and tighten the screws.



A new Dremel 1680 variable-speed scrollsaw and an assortment of blades will be waiting for Frank Snock when he comes back across the pond. Thanks, Frank!



Then, using the depth bar, I check the measurement at the front and back of the blade and adjust the saw until the measurements are equal. I find I can easily tweak the saw to within .001"—far better than my old combination square.

—Frank Snock, Sobam, England

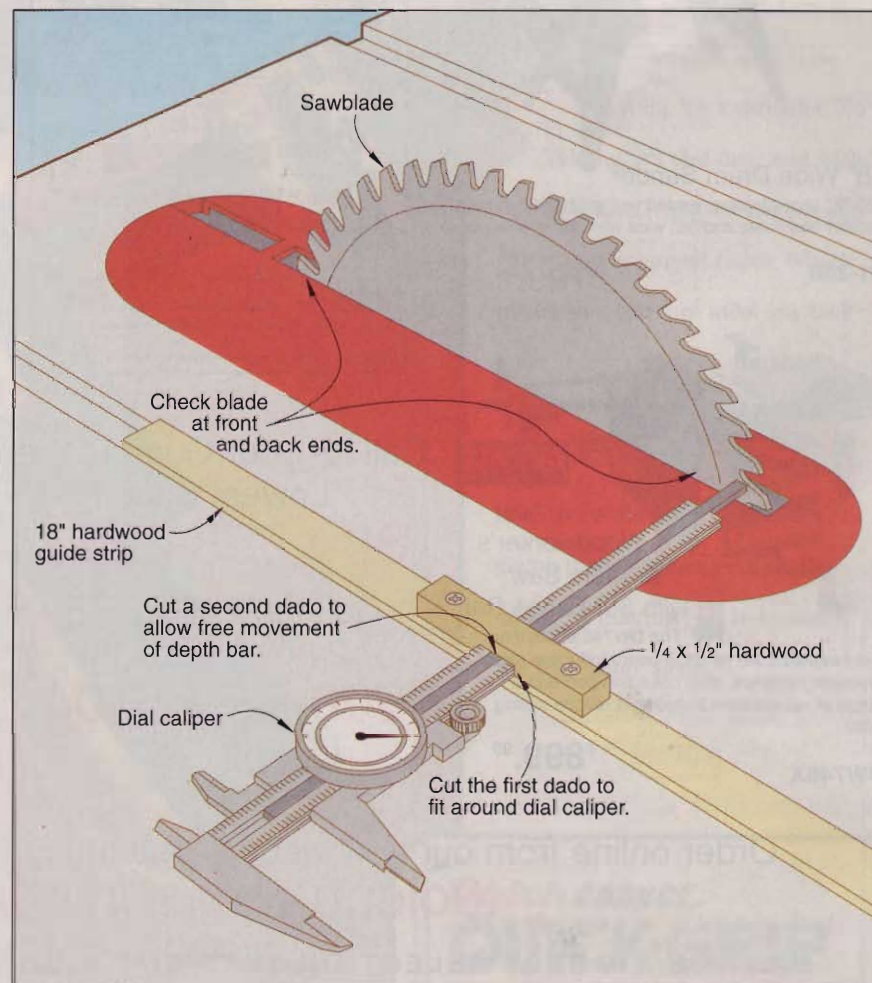

Continued on page 40

Continued from page 38

Use half-holes to drill a bunch of whole holes

Recently, I built the cribbage board project in *WOOD*® magazine issue #26, and while doing so, came up with a quick and accurate method for drilling repetitive sets of holes. With it, you can duplicate virtually any spacing, as long as the holes are in a straight line.

Start by drilling your hole pattern in a piece of $\frac{3}{4} \times \frac{3}{4}$ " hardwood the same length as your workpiece. To make the pattern strip, rip the hardwood piece through the center of the holes, as shown at *right*, using your band-saw. Make a simple auxiliary table and fence for your drill press, and bore a $\frac{1}{4}$ "-diameter slot in it as shown. Then glue a $\frac{1}{4}$ " dowel into the slot.

On your workpiece, mark the center of the first hole of each row. Align the center of the first pattern strip slot with that mark and attach the pattern strip to the edge of the workpiece.

Place the workpiece on your auxiliary table so that the first pattern-strip slot captures the dowel. Position the auxiliary table until the bit centers on your hole location, then clamp the auxiliary table in place.

Now, it's simply a matter of drilling the first hole, then "clicking" the dowel into each slot on the pattern strip. When you finish the first row of holes, reposition and reclamp the auxiliary table for the first hole of the next row, and so on. If your workpiece is too wide to drill all

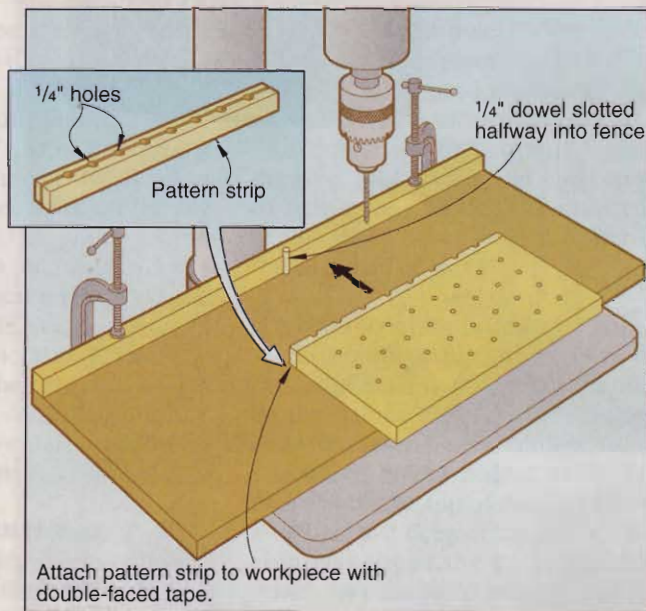

the rows from one side, simply attach the offcut from your pattern strip to the opposite edge of the workpiece, and work from that edge.

—Ian Beaton, Kamloops, B.C.

Routermania!

Make your router operations, faster, easier and more accurate with these exciting new products!



Revolutionary Router Lift

\$199.99

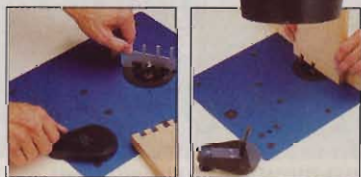

Each revolution of the knob adjusts your bit height .050". Remove knob for machining.



Our Exclusive Router Table

from \$149.99



Router Table Extension

from \$99.99

There's no better value on the market than our exclusive **Router Table**, now also available as a space-saving **Extension Table**. Plus, try our revolutionary **Router Lift** and start making micro-adjustments right from the top of your table.

Ask for your **FREE** catalog



ROCKLER®

WOODWORKING AND HARDWARE

Department 10805



The NEW name for... Woodworkers Store

ByPhone

Call our order entry department 1-800-493-9736

ByFoot

Call 1-877-ROCKLER for the retail store closest to you

ByNet

Shop online at www.rockler.com

Backward blade solves sizable scrollsaw stew

Sometimes when I'm scrollsawing a large workpiece, the saw's support arm gets in the way when I need to turn the piece. When I get in a bind like this, I remove the blade and put it in backwards—that is, with the teeth facing the back of the saw. I continue sawing, now *pulling* the workpiece into the blade until I run into another blockage, at which point I return the blade to its proper, teeth-front orientation.

—Jack Franke, Kansas City, Mo.

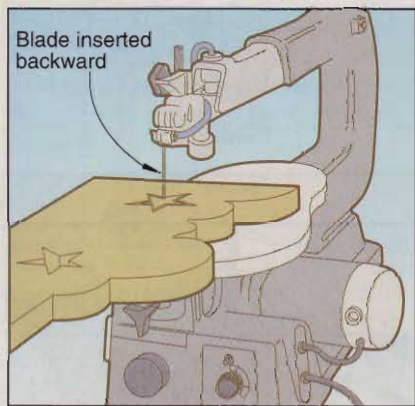

Small solution for boring long stock

You don't need a big stationary drill press to bore holes in the ends of long workpieces. Make a drill guide block by drilling a hole the same size as your desired hole through a piece of scrap, then attaching the block to a piece of 1/4" hardboard or plywood. Clamp the guide to your long stock, as shown in the drawing below, and bore the hole with your portable drill. The guide block keeps the bit on the straight and narrow.

—Jim Downing,
WOOD® magazine
senior design editor

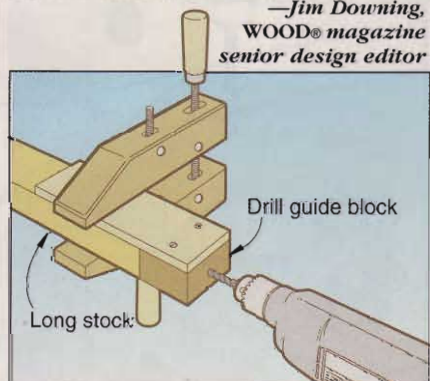

Continued on page 42

STEVE WALL LUMBER CO.

Quality Hardwoods and Woodworking machinery For The Craftsman and Educational Institutions

Ash4/4	Select	2.25	\$ 77.00
Basswood4/4	Select	1.95	\$ 63.00
Birch4/4	Select	2.50	\$ 81.00
Butternut4/4	1C	2.20	\$ 69.00
Cherry4/4	Select	4.20	\$ 98.00
Hickory - Pecan4/4	Select	2.30	\$ 72.00
Mahogany (Genuine)4/4	Select	3.70	\$ 98.00
Maple (Hard)4/4	Select	2.80	\$ 85.00
Maple (Soft)4/4	Select	2.20	\$ 72.00
Poplar4/4	Select	1.55	\$ 64.00
Red Oak4/4	Select	2.40	\$ 80.00
Walnut4/4	Select	3.45	\$ 95.00
White Oak4/4	Select	2.40	\$ 80.00
Cedar (Aromatic Red)4/4	1C+Btr.	1.65	\$ 66.00
Cypress4/4	Select	2.25	\$ 74.00
White Pine4/4	F.G.	1.15	\$ 55.00
Yellow Pine4/4	Clear	1.80	\$ 65.00

Above prices are for 100' quantities of kilndried rough lumber sold by the Bd. Ft. FOB Mayodan, NC. Call for quantity discounts. Other sizes and grades available.

Above prices are 20 bd. ft. bundles of clear kilndried lumber 3"-10" wide x 3'-7" long (Random widths & lengths) Surfaced 2 sides or rough. Delivered UPS prepaid in the Continental U.S.

UPS
Specials

SEE OUR
CATALOG ON
THE WEB!

NOW AVAILABLE

Custom Made
Raised Panel
Doors

4/4 Log Run
Walnut
100 bd. ft. \$155

Also Available
Exotic Lumber

STEVE H. WALL
LUMBER CO.

BOX 287
MAYODAN, N.C. 27027

336-427-0637

1-800-633-4062

FAX 336-427-7588

Email: wood@walllumber.com

Website: www.walllumber.com

Send \$1.00 For Lumber Catalog

Prices Subject to Change Without Notice

Circle No. 592

Prototype

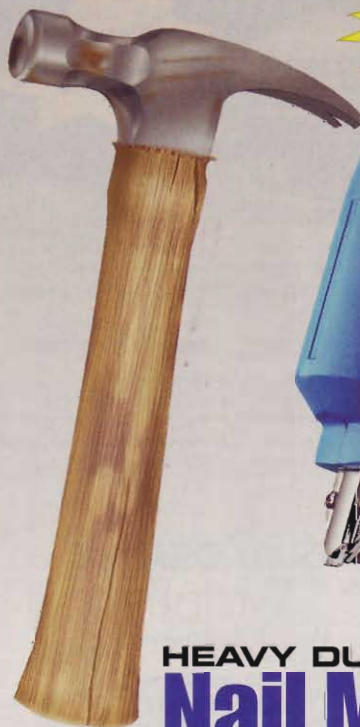

New!

ARROW
ELECTRO-MATIC

Finished
Product



HEAVY DUTY ET100™
Nail Master™
ELECTRIC BRAD GUN

Grab hold of the all-new ARROW ET100™ and experience the beauty of ergonomically designed comfort. Its non-slip cushioned grip and superb balance assures effortless work, even during long jobs.

In addition to performing routine nailing jobs, this powerful 10 amp brad nailer is specially angled to handle difficult corner, edging and framing jobs. No scratched or damaged surfaces.

The ET100™ provides nail driving muscle without the burden of an air compressor. It shoots 3 different size brads.

Solid state circuitry, a hardened carbon steel delivery system for jam-proof performance, and both trigger and surface contact safety locks combine to offer increased years of safe, accurate, trouble-free service.

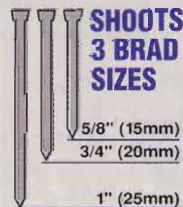

ARROW
Celebrating our
70th Anniversary

The ET100™ is available wherever fine tools are sold.

Arrow Fastener Co., Inc., 271 Mayhill Street, Saddle Brook, New Jersey 07663
Canada: Jardel Distributors, Inc., 6505 Metropolitan Blvd. East, Montreal, Quebec H1P 1X9
United Kingdom: Arrow Fastener (U.K.) Ltd., 14 Barclay Road, Croydon, Surrey CR0 1JN
www.arrowfastener.com

© 1999 Arrow Fastener Company, Inc.

For All Your Woodcarving & Sign Carving Needs

Terrco provides a full line of machine carving and sign carving equipment. Beginning models are the T-110 single spindle bench carver and our CM614 single spindle sign carver.

Intermediate models include the K-Star, a two-spindle heavy duty bench model, and the Northstar, a heavy duty floor model available in one to eight spindles.

Our advanced model is our Master Carver series, which is an extremely heavy duty floor model with from eight to forty spindles.

Website: www.terrco.com
E-mail: info@terrco.com

Terrco, Inc.

222 1st Ave. NW
Watertown, SD 57201
USA

(605) 882-3888
Fax (605) 882-0778

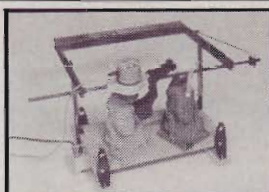

Model T-110 Dupli-Carver



Model CM614 Sign Carver

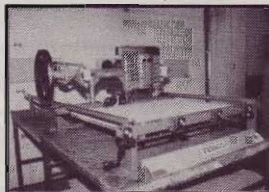

Multi-Spindle Carving Machine

Circle No. 2175

TIPS FROM YOUR SHOP (AND OURS)

Continued from page 41

Handscrew holds while drill press makes holes

In my furniture-making business, I often need to drill holes in the edge of small, unusually shaped pieces. Rather than make a work-holding jig for each shape, I clamp the piece into a handscrew and drill the hole on my drill press as shown *below*. The clamp keeps my hands out of danger and secures the workpiece for a nice, clean hole.

— Bob Jay, Port Orchard, Wash.

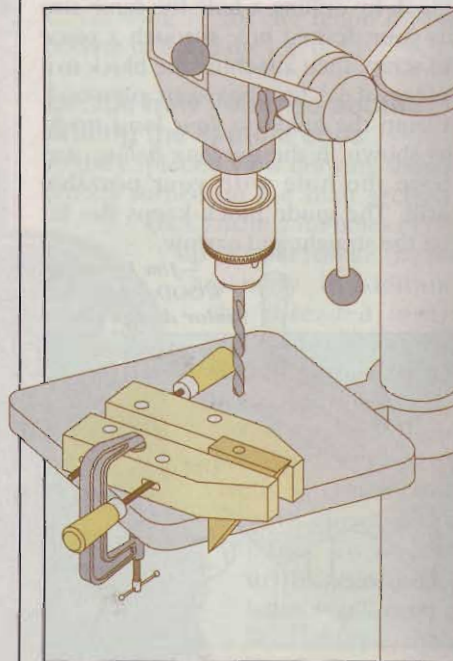
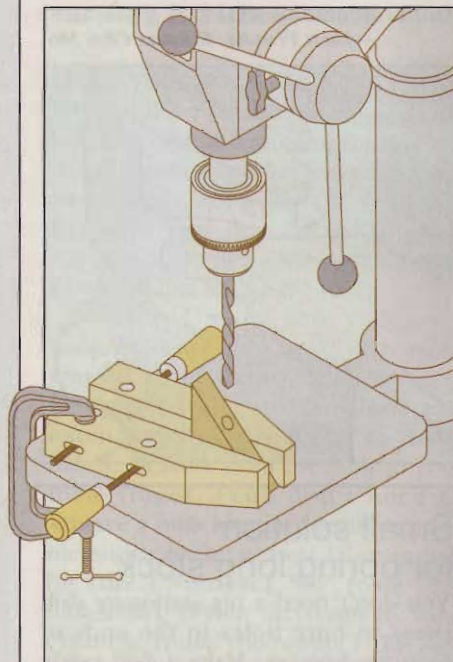

Take your hobby on the road.



Franchise Info
www.guardsmanwoodpro.com
Now Online!

As a Guardsman WoodPro franchise partner, you'll have confidence knowing you're backed by the largest producer of furniture finishes in North America, supplying over 500 furniture manufacturers. Your customers will also have peace of mind knowing that the same company who made the finish on their furniture is repairing and restoring it.



Finish Repairs



Waterbased Refinishing



Furniture Enhancing



Upholstery Repairs



Cabinet Refurbishing



Structural Repairs

Initial Advantages

- Low Overhead
- Exclusive Territories
- Inventory Packages
- Training Programs
- Marketing Programs

Ongoing Advantages

- Field Support
- Regional Workshops
- National Advertising
- National Service Accounts
- R & D on New Products and Services

GUARDSMAN WOODPRO®

The most trusted name in furniture repair.™

For information, call:
(800) 496-6377

In Canada: (888) 966-3232
www.guardsmanwoodpro.com

Target Markets!

San Francisco • Portland • Albuquerque
Seattle • Chicago • Miami • St. Louis • San Diego
Las Vegas • Atlanta • Cincinnati • Los Angeles
Pittsburgh • Baltimore • New York City • Boston

Investment range: \$15,000 - \$25,000.
Offer made by Prospectus only.
Unit & Master Franchises available worldwide.



A Business Unit of Lilly Industries, Inc.

Twin-slot tablesaw inserts pull double duty

I get twice as much mileage out of my shop-made zero-clearance inserts as most guys because I use the same plate for both full- and thin-kerf blades. How? When I make a new insert, I first cut the blade slot with my full-kerf blade, then rotate it 180°, load up my thin-kerf blade and cut a thin-blade slot. I mark each slot, as shown *below*, so I know which slot to use with which blade.

—Al Agnew, Salem, Ill.

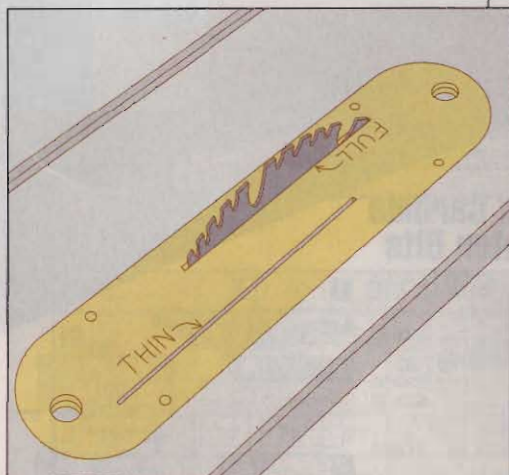

A FEW MORE TIPS FROM OUR WOODWORKING PROS

- Routing small parts can be tricky—and dangerous. On *page 62* we show you how a router-table overlay and taped-on handles can make it easier and safer.

- See *page 73* for a surefire way to keep laminations from slipping and sliding when you're trying to clamp them. It's in the top photograph on that page.

- You can rip thin strips of stock to the same thickness on your table-saw without fear of binding and kickback. The trick lies in the placement of an auxiliary fence, as you'll learn on *page 81*.

- Ever wondered about using your lathe to drill perfectly centered holes in your turnings? We explain how to do just that in the walking stick article on *page 88*.♣

Wood Workers...

Secure your tools & equipment with the Roll-Top-Cover™

The Roll-Top retractable hard tonneau rolls up automatically to allow full access to your truck bed. The PowerBolt™ electric tailgate lock protects your tailgate from theft and secures the bed of your truck like the trunk of your car.

1-800-413-8378 www.pace-edwards.com

Circle No. 1985

The missing link between man and craftsman.

Gorilla Glue® makes serious woodworkers more successful. It's incredibly strong, 100% waterproof and excellent for hardwoods, softwoods and hard-to-glue exotics. You'll get nearly invisible glue lines and stable joints. Plus, Gorilla Glue won't gum up your tools like yellow glue does. Discover a higher form of creation. Call 800-966-3458 for a dealer, or find out more at www.gorillaglue.com.

THE TOUGHEST GLUE ON PLANET EARTH™

Circle No. 650

What Wood Is That?

If you can't tell the difference between a board of white ash and one of red oak, here's some help for common North American hardwoods.

Field identification guides for living trees offer plenty of tips for telling one species from another. Leaves, bark, overall shape, twigs, and other characteristics give you all the clues needed.

For wood of questionable identity, though, you must rely on a different set of clues. Wood technologists call them "keys." The following basic ones help you identify unfamiliar native hardwoods that you might come across.

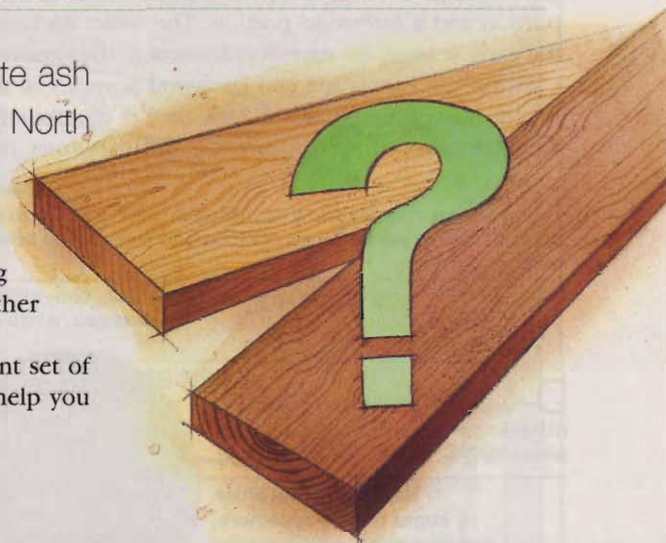

First, check wood's color

Boards accumulate dust, dirt, and a dull patina of oxidation that cloud identification. Create a fresh surface the size of your hand with a cabinet scraper, knife, or razor blade on the tangential surface (the top or bottom of a flatsawn board).

This scraping also should give you an idea of the mystery wood's hardness relative to wood you're familiar with. Walnut should be instantly recognizable.

So should the pinkish tan of red oak. Grain pattern might ring a bell, too. Broaden your ability by studying the color and grain of wood at your supplier, and as you work different species in the shop.



Maybe your nose will tell you

Wet a fresh surface with a little water or saliva. Doing this "activates" the wood, even if it's old and dry as a bone. Now take a sniff. If it has an odor, does it smell like any wood you've worked in the shop?

No wood smells as medicinal as saffron. Maple has a distinctive odor, too. And some people think walnut has a nutty smell.

Still no clue, take a closer look

When a strange wood's color, grain, and scent fail to name it, examine its fingerprint. Professionals turn to their microscopes for a close-up look. Yet, a hand lens of 10X magnification, available at jewelry stores and from opticians, lets anyone do practically the same thing. This type of investigation, however, requires a look at a freshly cut section of end grain.

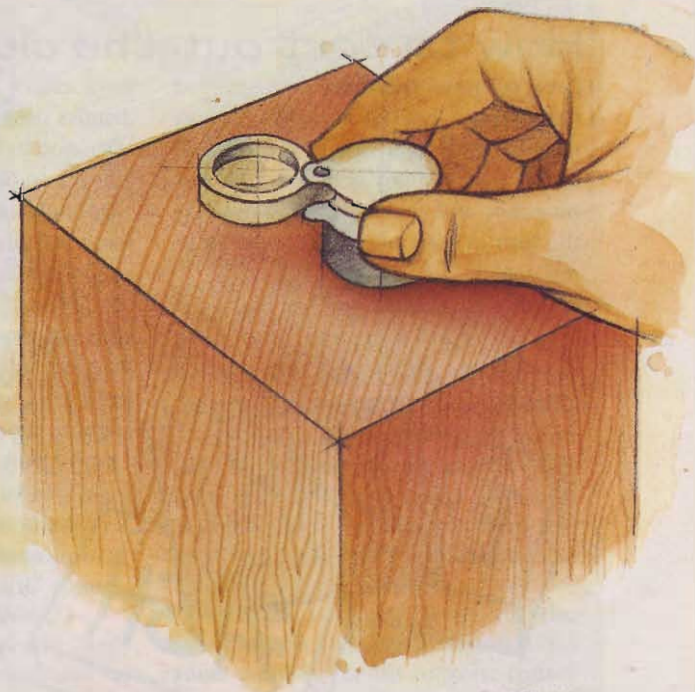

Continued

Study the pores

Hardwoods that grow in the earth's temperate (non-tropical) zone display annual growth rings in their wood's end grain. These growth rings have both an *earlywood* portion and a *latewood* portion. The wider earlywood reflects the rapid growth of the early season; the narrower latewood, the slower growth of the later season.

Within the earlywood and latewood portions of the growth ring you'll find *pores*. It's the size of the pores and how they're distributed in the growth rings that classify a hardwood as either *ring-porous*, *diffuse-porous*, or *semi-ring-porous*.

Ring-porous species show a sharp distinction in the size of the pores of the earlywood when compared to those in the latewood portion of the ring.

Ash, elm, hickory,
red oak, white oak

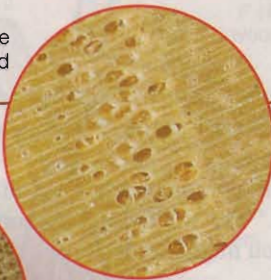

Diffuse-porous species show little difference in pore size no matter where they appear in the growth ring.

Basswood, red alder,
sugar maple, sycamore,
yellow birch, yellow poplar

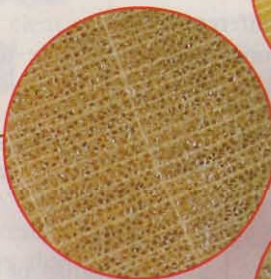

Semi-ring-porous trees have a gradual change in pore size across the ring.

Black cherry, black walnut,
pecan, tanoak



A few genus of trees, such as the hickory (*Carya*), fall into more than one classification. That's because species within the genus—in this case the true hickory, notably shagbark, and pecan, also a hickory—are different in their pore size and growth-ring distribution.

How to sort out the clues

Let's suppose that your unidentified wood has a plainsawn grain pattern that looks much like red oak, and seems just as hard and heavy. It has no scent and lacks aroma as well as the hint of pink normally common to red oak.

With a hand lens, you see that your mystery wood's growth rings have the tell-tale signs of a ring-porous species.

Rays aren't evident, though, so you dismiss the notion that it's an oak. It's also not as hard, heavy, or brown enough to be a hickory.

How about elm? Not likely because your sample doesn't have an odor, and its grain still reminds you of red oak. From the list, you've eliminated all candidates except ash. It could be that; but white ash or black? With the hand lens, you look at the end grain again. Your wood has large earlywood pores and wide growth rings.

You've read that black ash usually grows slowly in damp, cool conditions. That means its growth rings would be narrower. So white ash is your answer.

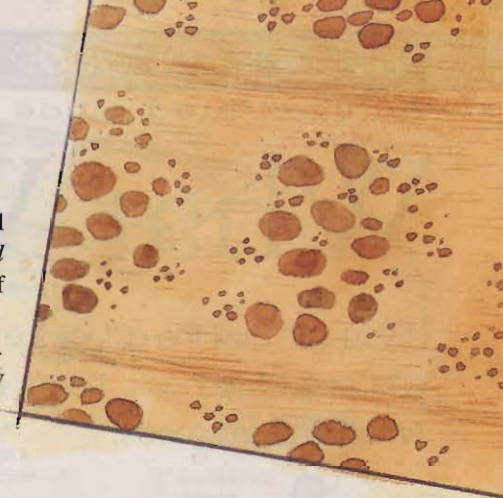
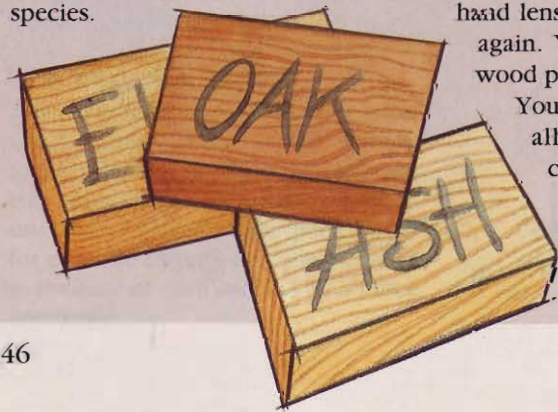

Rays help, too

When cells join to form a flat band of tissue that extends horizontally from its origin to the bark, it's called a *ray*. If the band happens to be several cells tall and wide as well, it's an *aggregate ray*. When a ray connects to the pith (innermost part of the tree), it becomes a *medullary ray*.

In commercial timber trees, only beech, the oaks, sycamore, tanoak (not a true oak), and red alder have large, conspicuous rays. In beech, the oaks, and sycamore, you can see them without magnification.



Collect some samples

To solve mysteries in wood identification, it helps to have on hand a collection of wood samples that have been positively identified and labeled. Blocks about 3x5" work nicely. Woodworkers Source (800/423-2450) offers a nice collection of 30 such samples, plus the four-color, 60-page *Fine Hardwoods Selectorama* for \$59 ppd.

Wood identification requires some study. If you want to get really serious about it, here's a good book to help you out: *Identifying Wood—Accurate Results with Simple Tools*, by R. Bruce Hoadley, The Taunton Press Inc., Newton, Conn., 1990, about \$40. 🌲

Illustrations: Brian Jensen
Photographs: Ripon Microslides

A man with grey hair, wearing a blue button-down shirt and light-colored trousers, is leaning on a wooden chair. He is in a workshop or factory setting, with other wooden chairs visible in the background. The lighting is warm and focused on the man and the chair he is leaning on.

Furniture Designs To Go

For Maine woodworker
Doug Green, his patented
take-apart furniture
marks the start
of a dream

Continued

Furniture Designs to Go

Inside the meticulously preserved, 130-year-old brick building on Portland, Maine's waterfront, there's a showroom full of solid cherry furniture. Its beauty is captivating. But its joinery is genuinely ingenious.



Shoppers in Green Design Furniture's gallery-like space admire the dining tables, chests, chairs, computer desks, beds, and bookcases made from rich, lustrous wood. The lines of the pieces look contemporary, yet somehow appealingly familiar. None of the showroom's visitors, though, realize from their first encounter that most of the furniture before them easily disassembles to lie flat in a box for shipping or moving. Until they're informed, they see nothing of the line's unique, patented, fastenerless joinery system that makes quick take down and assembly possible. But to Doug Green, the innovative woodworker who created the pieces and their means of joinery, that's the mark of good design.



The five pieces of furniture in this showroom setting have a retail value of about \$8,000, and each can be disassembled quickly for Federal Express shipping.

From woodworker to industrial design: a path of creativity

"I realized only fairly recently that before I was ever a woodworker, I was an inventor," says Doug Green, the 44-year-old founder and head of Green Design Furniture. As a kid in Scarsdale, New York, he regularly took things apart and reassembled them in different form. At age 10, he was inspired to rewire his room so that switches on his bed's headboard controlled lights and music. He was born a tinkerer.

"I went to college right here in Maine," Doug continues, "then I taught preschool. But I got caught up in the handcrafts movement of the late 1970s. And as a hobby, I began woodworking—in a small way—with a Dremel tablesaw and a Dremel router to make little boxes."

After two years of teaching, Doug got completely hooked on woodworking, bought a full line of tools, quit teaching, and opened a little shop in Topsham, Maine. "I was doing custom furniture and repairs, and did it for two or three years before getting a job as a cabinetmaker with Thos. Moser," recalls Doug. "At that time he had six cabinetmakers, up in the old Grange Hall in New Gloucester. Each cabinetmaker was completely responsible for a piece of furniture—a great learning experience for me."

Doug worked for Moser for a year, and during that time followed his natural inclination to find better ways to do something by designing jigs that sped up a process or refined it. "It was fun, finding more efficient ways of doing things," he says. "The foreman once called me over to say that I was the most productive cabinetmaker in the shop. But he couldn't figure it out because I didn't, and still don't, move fast. However, I do think about efficiency. For instance, I built a jointer jig to cut octagonal tapers on bed posts. That allowed me to make 10 pencil-post beds in the time it used to take to make two."

This phase of Doug's career would soon end, though. "I was talking to a lady at a party," he remembers, "and she said, 'Oh, you're an industrial designer.' 'What's that?', I thought. I

had never heard of one. No career counselor had ever mentioned it. The title was new to me, although it did conjure an image of designing boilers for factories."

With that image in mind, the young woodworker set out to do some research. The result: enrollment in the graduate program for industrial design at The Pratt Institute in Brooklyn, New York.

A look at the world through designing eyes

Doug believes that his new direction was partly due to boredom. "I think I had reached the level of competence as a craftsman that the challenge was no longer there," he says. "I knew when I started a piece just how long it was going to take—it was completely predictable and no longer an exciting journey. I had started to look at design, too, and didn't see anything really new and interesting coming out of the crafts movement."

Pratt Institute's industrial design program was nuts and bolts, according to Doug. It blended current manufacturing technology with creativity to arrive at a product. It was about materials and processes, and how things were made in the world—and conceptual problem solving.

"As an industrial designer, you have to have the freedom to think about things," Doug explains. "Sometimes, when you become too expert in a field of knowledge, your expertise limits your ability to ask questions and to innovate. At Pratt, I was taught to become a generalist."

After graduate school, the fledgling industrial designer worked for a lighting company. Doug stayed with them for about a year, then went on his own as a consultant. "A year later, the company I had worked for hired me to design a fixture for them, a modular fixture with interchangeable, locking reflectors," says Doug. "That fixture's connecting device later became Green Design Furniture's logo."

Easy-to-assemble furniture goes to the patent office

In the late 1980s Doug began sketching an idea for a take-apart sofa made

Presto! A table without any fasteners

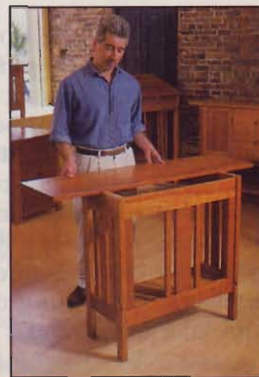

Doug Green has a patent on his easy-to-assemble furniture that features the sliding, tapered dovetail joint.

of the fewest possible components. It also had to be lightweight and easily assembled and disassembled. In 1989, he started prototyping his idea, but in chair form.

"When I left Maine, I stored my woodworking equipment in the shop of a woodworking friend," says Doug. "So I used to come up to Maine to prototype, and in 1989-1990, I came at least twice for a week or so at a time. In New York, I'd make models of foam core [a cardboard-like material], then turn them into scale wooden ones in the Maine shop."

Doug experimented with many types of joinery, and finally decided

on the sliding dovetail as the key. "It took me a long time to figure out how to do the long, tapered dovetails that enable the parts of a piece of furniture to interlock," he says. "When I finally got the chair done, it was a creaky and unattractive piece of furniture with Baltic-birch plywood sides, seat, and back. Everybody who saw it thought that it was a very strange-looking piece of furniture, and it was. Yet, the joinery technique worked."

Driven with the idea, Doug rented larger work space in Yarmouth, Maine, and went to work making furniture with the dovetail joinery. He made everything—tables, case pieces,

Continued

Furniture Designs to Go

and desks. By the time Doug was finished, he had 15 pieces of furniture.

"I'd also started working with a brilliant patent lawyer, Abbot Spear, a then 87-year-old Maine attorney. He came out of retirement to work on the project," Doug comments. "He filed a patent for me in 1992 that had 30 plans for creating different structures using the sliding dovetail as interlocking joinery, and it was awarded in 1995. The reason that it is a patentable idea was that during the patent search, we found out that the field of self-assembling, or fastener-free, furniture was all tab-and-slot, puzzle-type furniture. Mine was the first where joinery was part of the furniture, and it wasn't visible when the piece was assembled. The patent involved the order in which the pieces went together, too. So it's not the sliding dovetail that's patented, it's how you create the structures.

"My idea was to get a patent on the process, then license it to a big furni-

Thatcher Anderson runs the 3-hp., vertically mounted router that follows a linear tract to cut the male half of the tapered dovetail.

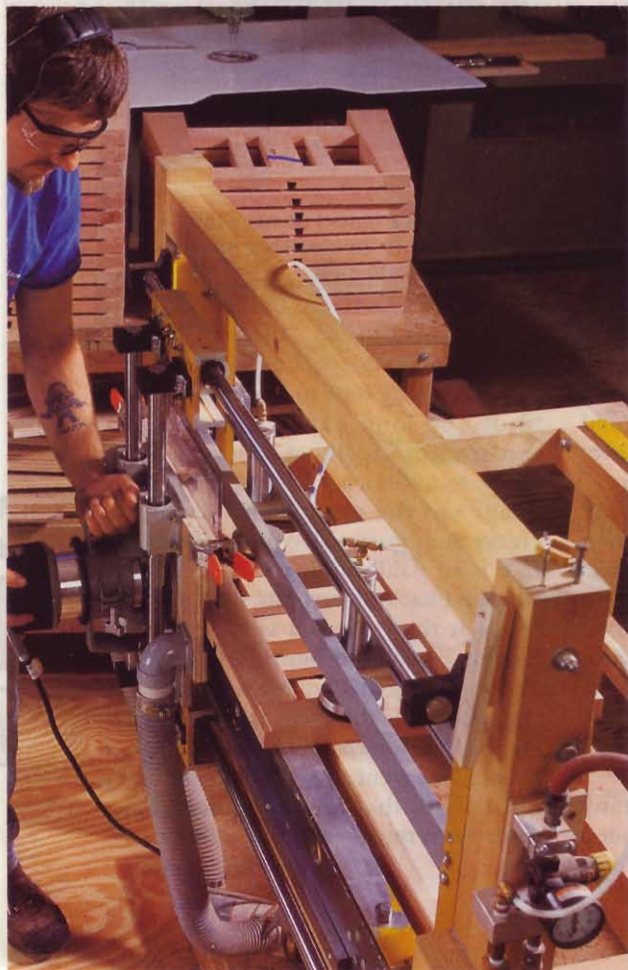

ture manufacturer and get a royalty from every piece of furniture of my design that they sold," Doug continues. "My patent-applied-for furniture and I got a lot of attention in 1993. Then, I painfully realized that the furniture industry as a whole isn't real progressive in terms of design. As a result, I had this great idea, and no one seemed to want it because it would involve restructuring how they make furniture. One CEO told me that they couldn't keep their machinery accurate enough to produce the precision needed in my furniture, and they doubted that they could train their workers either."

The birth of a business: Green Design Furniture

Doug did have offers from large furniture companies to buy his design outright, but after working on it for three years, he wasn't about to give it away. So Green Design Furniture was born.

"Looking back on what's happened, it's like this idea had a will—a mind of its own," says Doug. "This space [the former pottery factory] became the company's first store. The furniture I built with the help of one other guy in a little shop in Brunswick, Maine. That was in 1994. Now I have nine people in production and a second store in Freeport."

Today, about 80 percent of Green Design Furniture's business comes via its catalog, which customers order from advertisements in *The New Yorker* magazine and *The Wall Street Journal* newspaper. At this writing, the company's mailing list contained 30,000 names. "Last year, 35% of the people who ordered from us the first time, placed a second order," Doug says. "A typical first-time order is one piece, but we have people who order \$10,000 to \$12,000 worth of furniture at a time. A lot of that happens on the second or third order."

There's a definite customer service aspect to this type of

business, too, according to Doug. "Because our furniture is shipped knock-down, it can go by Federal Express faster and at a reasonable cost to the customer. For example, we got a call this morning from a woman in Chicago who ordered an eight-drawer dresser. We can put that on the FedEx truck today, and it will get to her two days from now. And with conventional furniture and freight, there's a 24 percent chance that it will be damaged before it gets to the customer."

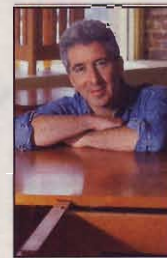

"My furniture looks like a traditional style, but it's modern, with sophisticated ergonomics. A

style can be modern without being disconnected from a traditional appeal."

—Doug Green

We have less than one percent damage. And the furniture doesn't seem to be bothered by humidity changes. I don't know whether it's the built-in tolerances, the cherry wood that all moves at the same rate, or the joinery, but we don't have trouble."

And because the customers handle each component in assembly, there's nowhere to hide anything less than the best, even to the inside of a drawer. That's why the craftsmen at Green Design Furniture must keep the quality level high, from the wood, to the joinery, to the finish. Doug explains: "We're such a micro dot on the radar screen nationally, our reputation for quality and customer satisfaction is of major importance."

Inside the shop, furniture components travel on wheels

Although Doug's furniture prototypes were done in ash, maple, cherry, and white oak, Green Design Furniture

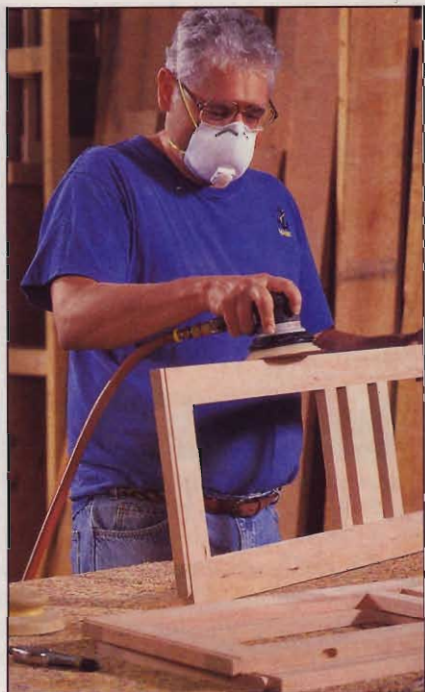

Finisher Steve Bodge uses pneumatic equipment to sand a furniture component in the Green Design shop. In the finishing area, the component will receive two sprayed coats of clear conversion varnish.

now produces—except by special order—only in cherry.

Unlike any shop that builds furniture in batches, at Green Design you'll never see it—except for straight-backed chairs—being assembled until just prior to shipping. Because Doug has designed the furniture to assemble without fasteners, the components, such as table-leg assemblies and tops, can be shaped, joined, sanded, and finished individually. And the parts travel from work station to work station on carts. At shipping time, workers test-fit a furniture piece's components, make any necessary corrections, then disassemble them and wrap for shipment.

"When we set up for a production run, we do the setup for each pattern. When we get the fit, we then can run all the pieces," says Doug. "Making furniture this way combines traditional woodworking with this machining process. The first part of each production run is building components: ripping, planing, jointing, edge-jointing—getting them to uniform dimensions.



Doug Green often pauses to talk about production techniques with his craftsman in the company shop. Woodworkers John Vandis and Greg Martin intently listen.

When the components are done, we start the machining of mortises and tenons, and routing the dovetails."

It's the dovetails that prove critical. "The engineering for the sliding dovetail is difficult because it's tapered," Doug says. "That means that it's wider at the front and narrower at the back, so that it locks when fully joined. We cut the female dovetail, which opens five thousandths of an inch—little more than a hair—at an inverted pin router to match the male tapered dovetail. I have designed three different router tables to make the male dovetails with accuracy. What we're using is the third generation.

"Basically, it's a pattern router with a linear motion bearing," he adds. "It's a precursor to a CNC [computer numerical control] machine that we'll design someday to do the male dovetail with perfect accuracy. Until then,

we've been able to closely simulate CNC technology manually."

There's little doubt that Doug Green will in the future have a CNC machine of his design. With childhood heroes like Henry Ford and Thomas Edison, it's little wonder that his greatest pride comes from his furniture's patent credit. That reads, "Doug Green, Inventor." ♣

Interested in seeing the Green Design collection?

For a colorful brochure of Green Design Furniture's complete line, send \$5 (ppd. U.S.) to Green Design Furniture, 267 Commercial St., Portland, ME 04101. You also can visit Green Design's website at www.greendesigns.com.

Written by Peter J. Stephano
Photographs: Jeffrey Stevensen



Exceptional Entry Suite

Let this elegant
hall table and mirror
greet your guests
in grand style

Some furniture styles and pieces seem to work in almost any setting, traditional or contemporary. We think this classic walnut table and mirror duo certainly qualifies for that claim. Simple lines and understated details make it easy to build, and even easier to mix with other furniture pieces. Place the set in an entry hall, and the drawer provides a home for keys, gloves, and other items you want to keep handy at the door.

Let's build the table

Legs first: Give the table something to stand on

Note: Some of the machinery setups required for this table, especially the routing procedures, are identical to those you'll need for the mirror. We suggest that you read through the procedures for both projects before you start working on either. You'll save a lot of time if you cut stock for both the table and mirror beforehand and machine the shared details using your original setups.

1 Rough-cut the four legs (A) from 8/4 stock, leaving enough extra thickness and width to remove the sawblade marks with a jointer or planer.
2 Once the leg blanks are milled square, trim them to 31" long. Then sand or rout a 1/8" chamfer on the bottom end of each leg to prevent splintered corners.

3 Mark two inside faces on each leg so you know where to rout the dovetail slots where the rails install. (See the Leg Assembly drawing.)

4 Set up a 1/2" dovetail bit in your router table and adjust the fence exactly 7/8" from the center of the bit. Cutting depth setting should be 3/8".

5 Clamp a stopblock to the router table fence where it will stop the cut length at 4". Try a test cut in scrap stock, and reset the block as necessary, then repeat the test cut to confirm the correct setting.

6 Rout the dovetail slots in the two inside faces of each leg (Photo 1).

7 Set the legs aside for now, but keep them handy. Later you'll be using the router table again to machine the bead detail along each corner.

Riding the rails—the other half of the dovetail joints

1 Cut to size the side rails (B), front rails (C), rear rail (D), drawer rails (E), base rails (F), and stretcher (G).

Note: For the best look, cut the front rails (C) from opposite ends of the same board, leaving a center section large enough for the drawer front (J). This technique will result in a grain pattern that flows virtually uninterrupted across the entire front of the table.

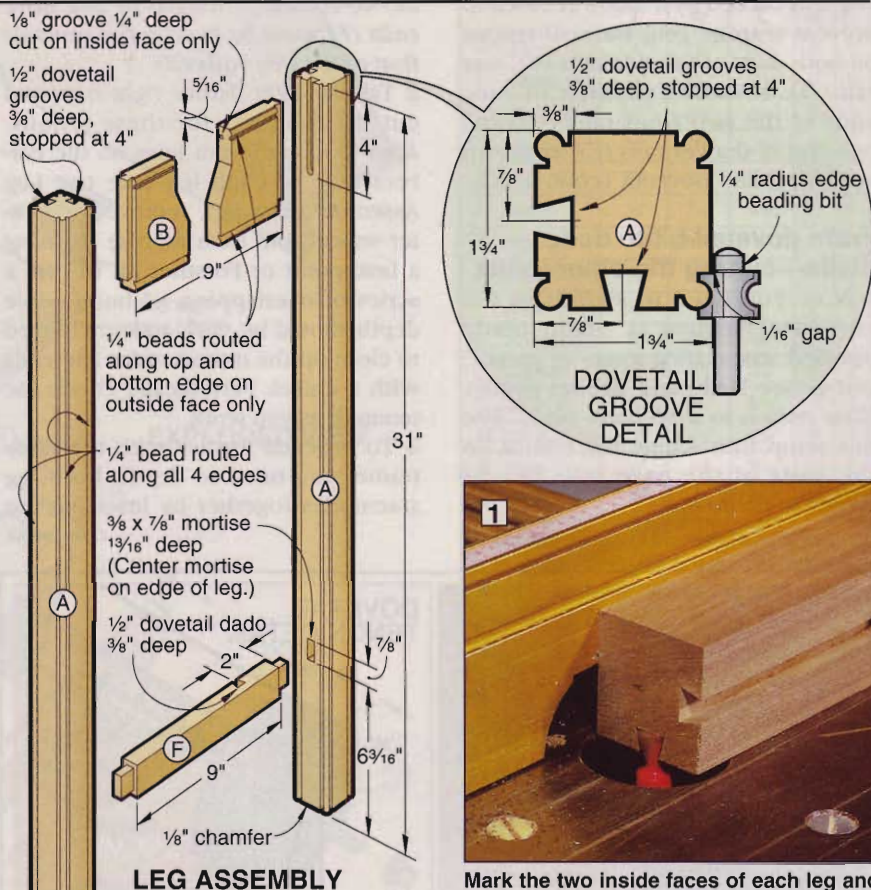

LEG ASSEMBLY

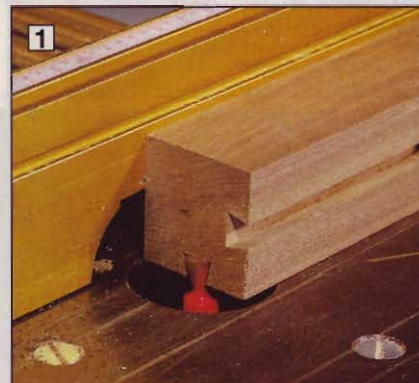

1 Mark the two inside faces of each leg and rout 4"-long dovetail slots at the top. A stopblock limits the workpiece travel.



2 Clamp a follower block to the base rails to guide the dovetail cut and to prevent tearout when the bit exits.

2 Layout dovetail dados where shown on the Leg and Frame Assembly drawings for parts D and F.

3 With the dovetail bit still mounted in your router table, adjust the fence position to cut the dovetail dados in the rear rail (D) and the base rails (F). Use a follower board to prevent tearout and to stabilize the workpiece while routing it, as in Photo 2.

4 Next, attach a 4" or taller auxiliary fence to the main fence. Don't change the bit height, but adjust the fence so two passes—one on each face of the rail stock—will leave the tenon centered on the ends of the rails. Test on scrap stock first, and make sure the test dovetail tenon fits snugly into the dovetail dado that you routed into the legs earlier.

Continued

Entry Suite

5 With each workpiece standing on end and backed by a follower block to prevent tearout, rout dovetail tenons on both ends of the side rails (B), rear rail (D), stretcher (G), the outside ends of the two front rails (C), and one end of drawer rails (E), as shown in *Photo 3* and Dovetail Tenon detail.

From dovetail bit to dado blade—cutting the other joints

1 Now you need to switch to the tablesaw; with a 1/4" dado blade installed, cut mating joints in parts C and E (see Dado and Rabbet detail). Now switch to a 3/4" dado blade. Use this setup to machine the tenons on the ends of the base rails (F), as shown in *Photo 4*.

Note: For the legs to align, the shoulder-to-shoulder length of the base rails (F) must be exactly the same as that of the side rails (B).

2 Take a slight detour right now and cut the mortises for these tenons. After marking layout lines on the correct face of each leg (see the Leg Assembly drawing), remove the center waste from each mortise by using a brad-point or Forstner bit to drill a series of overlapping 3/8" holes. Hole depth should be 1 3/16", and you'll need to clean up the mortise sides and ends with a chisel. Periodically check the tenon fit as you work.

3 To proceed further with the table frame, you need to dry fit both leg assemblies together by inserting the

Continued

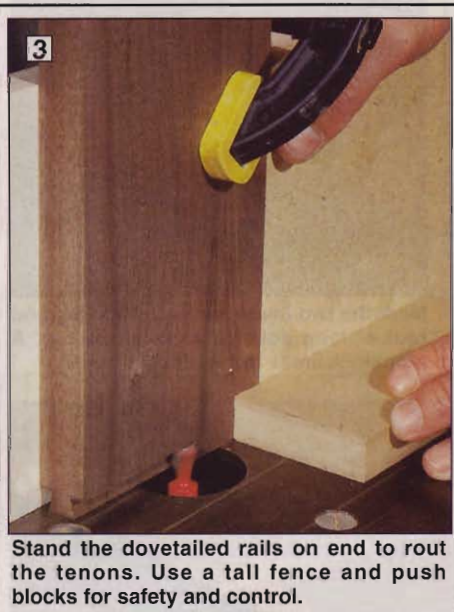
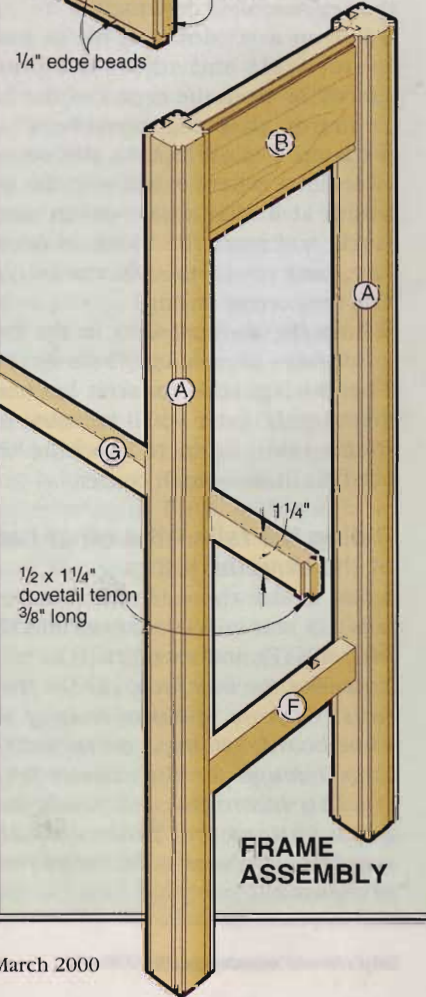
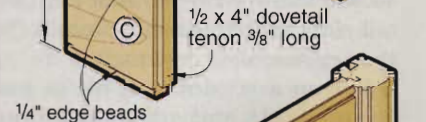
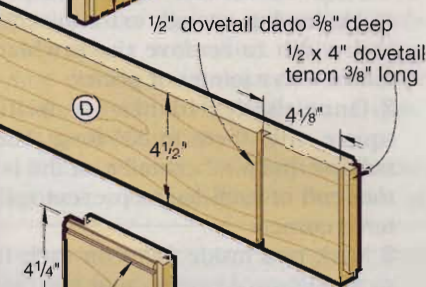
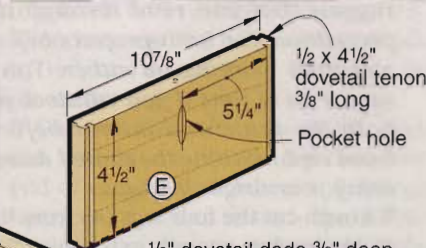
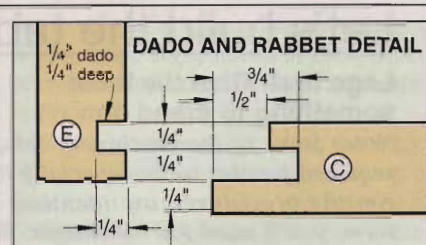

Stand the dovetailed rails on end to rout the tenons. Use a tall fence and push blocks for safety and control.

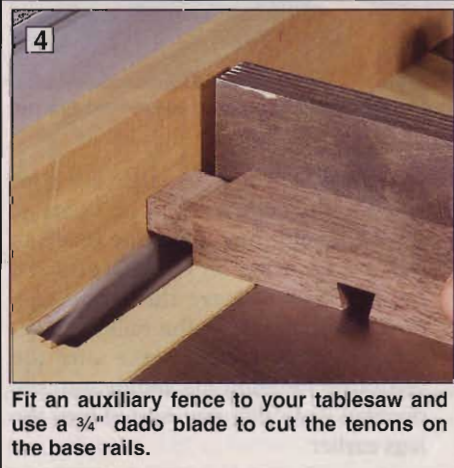
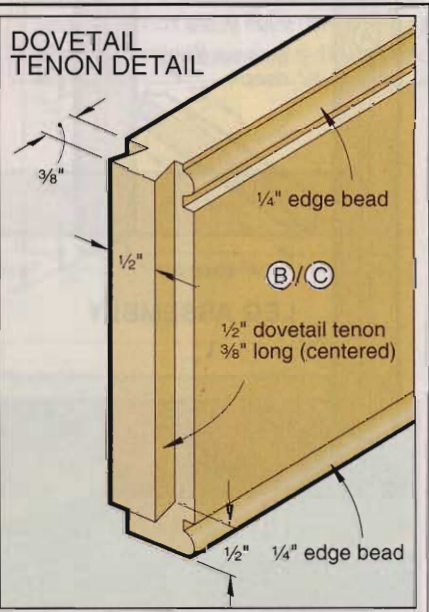

Fit an auxiliary fence to your tablesaw and use a 3/4" dado blade to cut the tenons on the base rails.

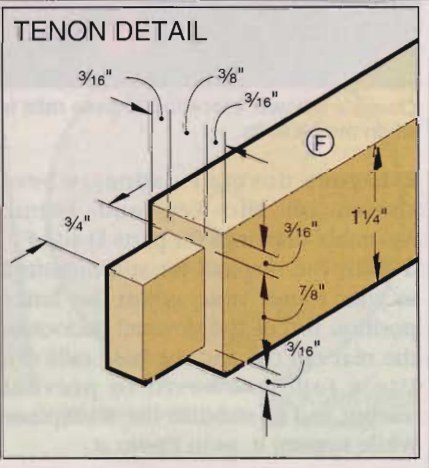

Bill of Materials

Part	Finished Size			Mati.	Qty.
	T	W	L		
A legs	1 3/4"	1 3/4"	31"	W	4
B end rails	3/4"	4 1/2"	9 3/4"	W	2
C front rails	3/4"	4 1/2"	47 1/8"	W	2
D rear rail	3/4"	4 1/2"	31 1/4"	W	1
E drawer rails	3/4"	4 1/2"	10 7/8"	P	2
F base rails	3/4"	1 1/4"	10 1/2"	W	2
G stretcher	3/4"	1 1/4"	32 1/4"	W	1
H tabletop	1 1/16"	14"	36"	EW	1
I drawer guides	5/16"	3/4"	9 3/4"	P	2
J drawer front	3/4"	4 7/16"	21 3/8"	W	1
K drawer sides	1/2"	4 7/16"	10 1/4"	P	2
L drawer back	1/2"	3 15/16"	20 7/8"	P	1
M drawer bottom	1/4"	10"	20 7/8"	Ply	1
N drawer stops	1/4"	1/2"	3"	P	2

Materials Key: W—walnut, EW—edge-glued walnut, P—poplar, Ply—walnut plywood.

Supplies: #8x3/4" flathead wood screws, #10x1/2" panhead sheet metal screws, #6x1 1/2" panhead pocket hole screws, 1" brads, 1 pint polyurethane gloss varnish, 1 pint polyurethane semigloss varnish. See additional items for mirror project.

Buying Guide: In addition to the lumber and supplies shown above, the following items (or appropriate substitutes) are required for this project. All are available from Woodcraft, P.O. Box 1686, Parkersburg, WV 26102, 800/225-1153. Brass knobs (2), no. 02U24, and tabletop fasteners (4), no. 27N10.

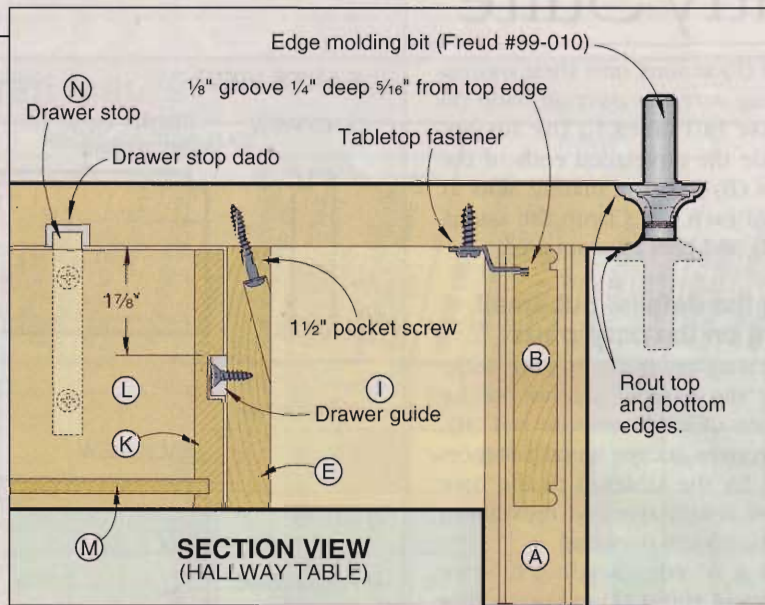

Edge mold along front and sides. Do not rout back edge.

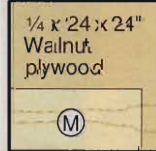
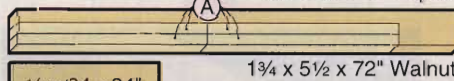
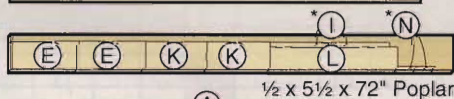
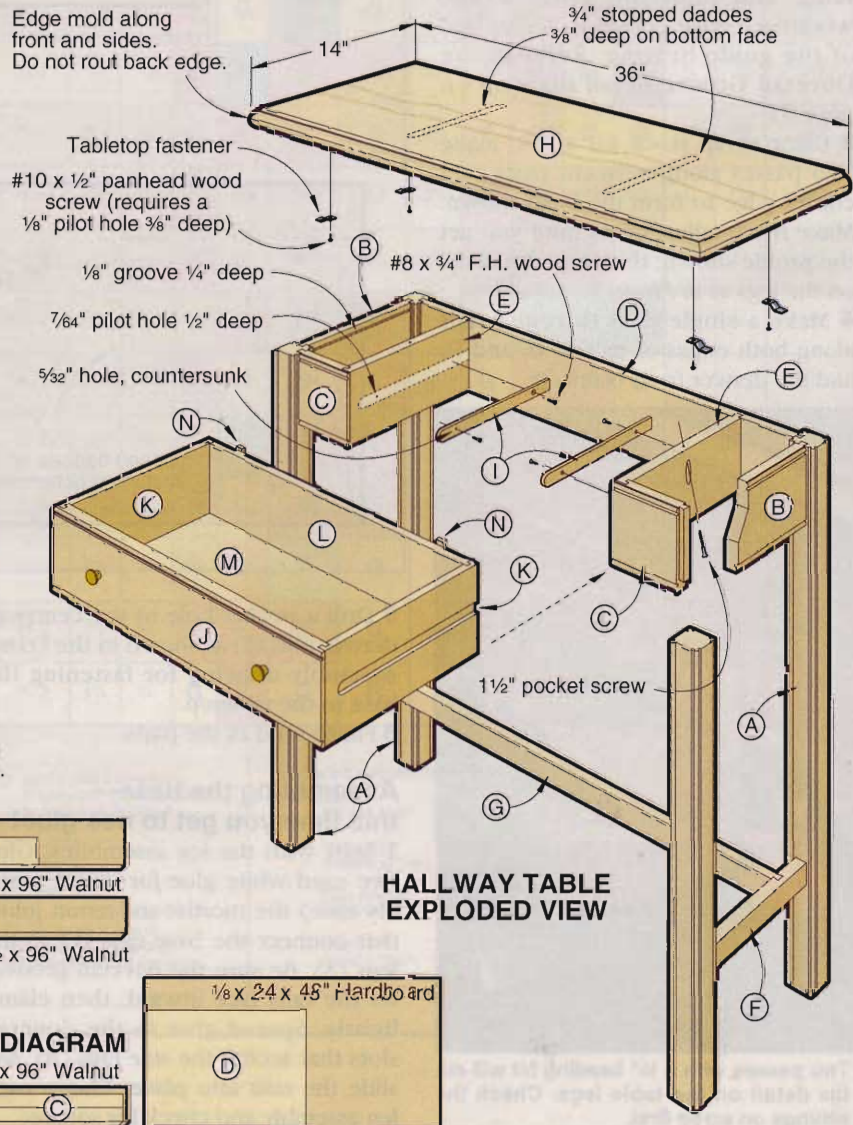

HALLWAY TABLE CUTTING DIAGRAM

*Plane or resaw to thickness listed in the Bill of Materials.

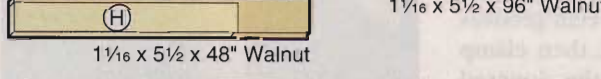
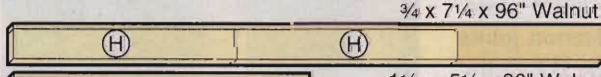
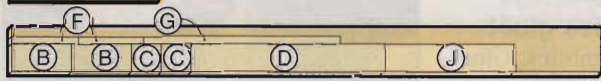

HALLWAY MIRROR CUTTING DIAGRAM

1 1/4 x 5 1/2 x 96" Walnut

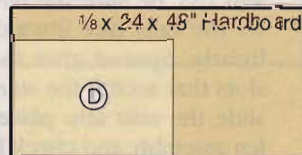
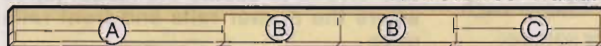

Entry Suite

base rail (F) tenons into their mortises, making sure the dovetail dado on each base rail faces to the inside. Then slide the dovetailed ends of the side rails (B) into the mating slots at the top of each leg. Clamp the assembly lightly and check for square.

Dialing the details: put small touches on the base parts

1 With a standard blade on your table saw, cut the narrow groove on the inner face of each outside rail (B). These grooves accept metal fasteners that will fix the tabletop to the base but allow seasonal wood movement (see Section View drawing).

2 Install a $\frac{1}{4}$ " edge-beading bit (we used a Freud #80-122) in your router table, and adjust the fence so the workpiece edge comes to within $\frac{1}{16}$ " of the guide bearing. Refer to the Dovetail Groove detail drawing on page 55.

3 Using scrap stock for a test, make two passes along adjacent faces of a corner edge to form the bead shown. Make fence adjustments until you get the profile shown; then rout the detail on the legs as in *Photo 5*.

4 Make a single pass to rout beads along both edges of rails B, C, and D, and the drawer front blank (J).



5 Two passes with a $\frac{1}{4}$ " beading bit will cut the detail on the table legs. Check the settings on scrap first.

PARTS VIEW

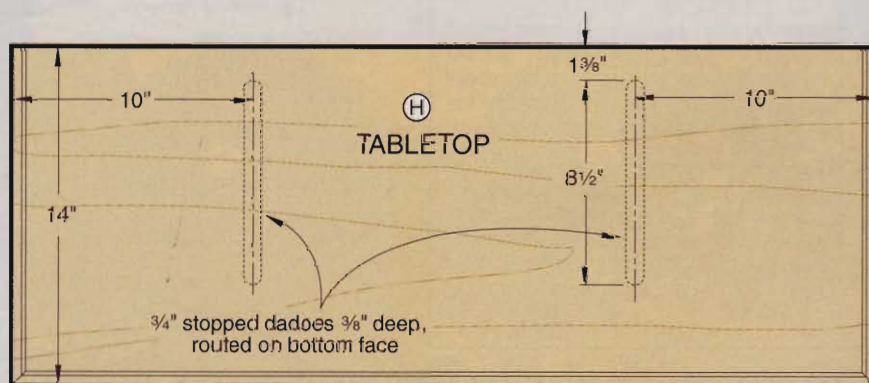
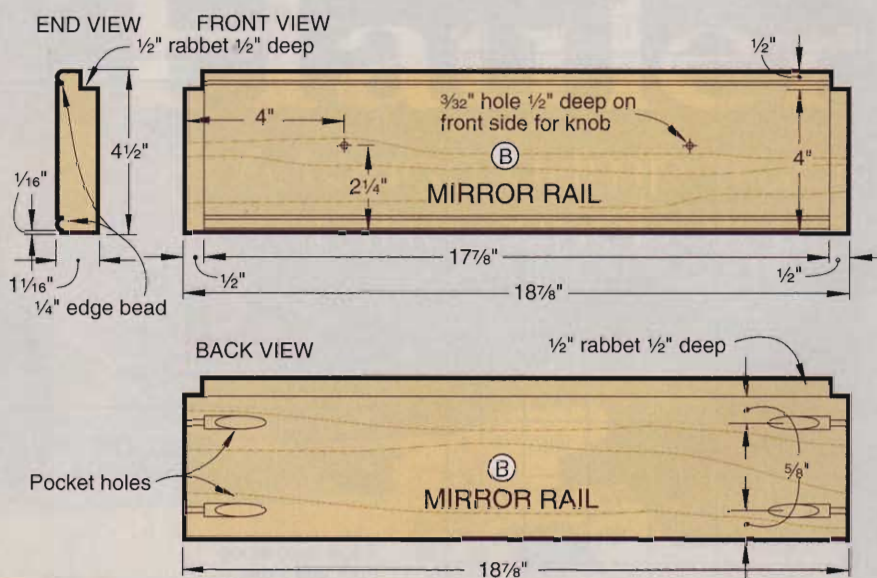

5 Drill a pocket hole in the center of drawer rails (E) as shown in the Frame Assembly drawing for fastening the base to the tabletop.

6 Finish sand all the parts.

Assembling the base—this time you get to use glue!

1 Start with the leg assemblies. Glue (we used white glue for longer assembly time) the mortise-and-tenon joints that connect the base rails (F) to the legs (A). Be sure the dovetail grooves on the rails face inward; then clamp lightly. Spread glue in the dovetail slots that accept the side rails (B), and slide the rails into place. Clamp each leg assembly and check for square.



Use screws to secure the rabbet joints where the drawer rails and front rails meet.

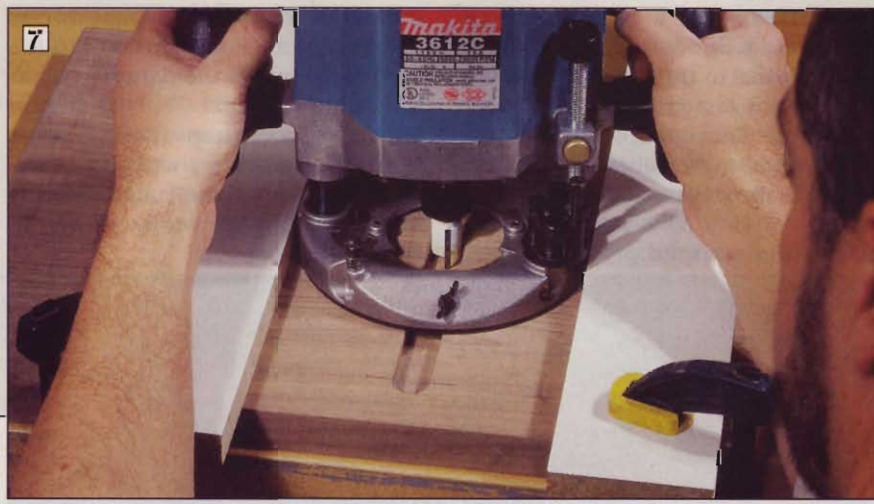
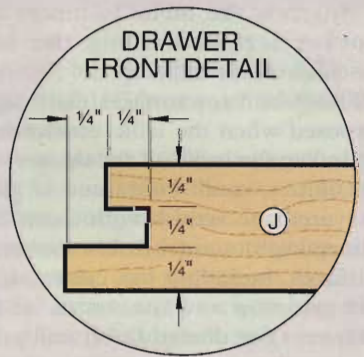
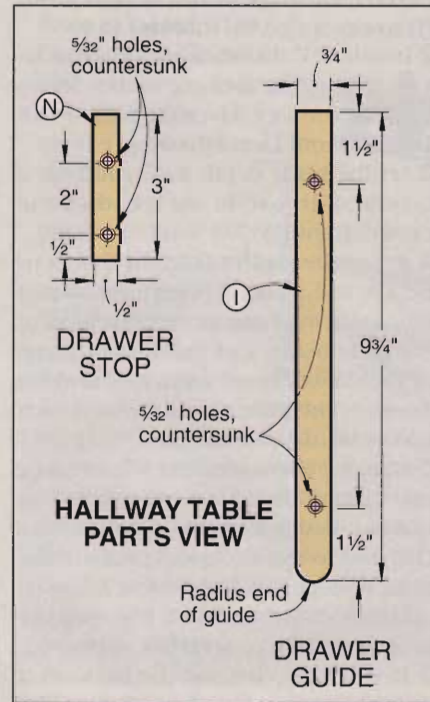
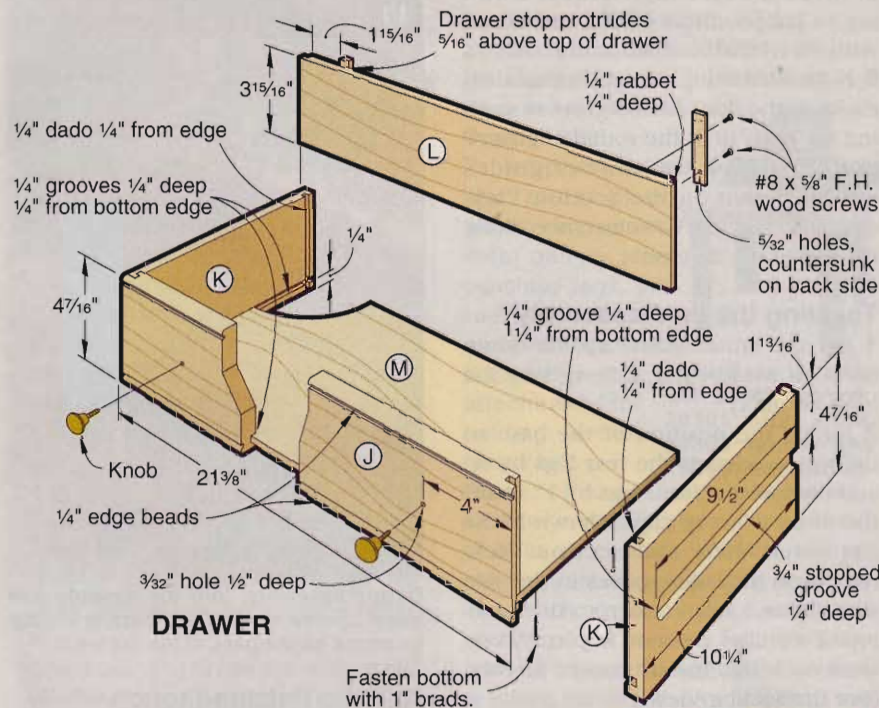

Clamp guide boards in place to rout drawer stopped dados in the underside of the tabletop.

2 Use a similar procedure to install the stretcher (G) and the rear rail (D). To avoid frame twist we assembled upside down on a flat surface.

3 Glue the front rails (C) to the legs; then glue the drawer rails in place. Drill countersunk pilot holes and drive screws to secure the rabbet joints where the drawer rails meet the front rails, as shown in *Photo 6*.

4 To insure the correct drawer opening width we clamped a 21 1/2" long spreader between the ends of C.

**Capping it off—
make a top for the table**

1 Mill 5/4 stock to 1 1/16" thickness and edge-glue a panel together for the

table top (H). Make it slightly over-size; then trim to finished dimensions.

2 Rout a decorative profile along the front and side edges of the tabletop, but leave the rear edge square. (See the Section View.) We used an edge molding bit in a table-mounted router to create a profile that creates a cove, fillet, and round-over detail. To duplicate our design, use the cutter full-depth when routing the top edge, and readjust to cut just the round-over along the underside.

3 Clamp the tabletop face down onto

your workbench, and layout the stopped dados where shown on the Parts View drawing. Use a 3/4" straight bit to rout the drawer stop dados as shown in *Photo 7*.

**Fill out the center
with a custom-fitted drawer**

1 Using the Bill of Materials and the Drawer drawing as a guide, cut the drawer guides (I), the drawer sides (K), the drawer back (L), and the drawer bottom panel (M). If you

Continued

Entry Suite

haven't already cut the drawer front (J) to exact size, do that also.

2 Install a $\frac{1}{4}$ " dado blade in your table-saw to cut the locking rabbet joints for the drawer assembly. (See the Drawer Front Detail drawing.)

3 Set the blade depth to $\frac{1}{2}$ ", and cut a centered groove in each end of the drawer front (J).

4 Reset the dado blade for a $\frac{1}{4}$ " cut depth, and install a "sacrificial" wood fence that you can scoot right next to the dado blade. Cut the inside tongue of the drawer front short, as shown in *Photo 8*; then cut the rabbets on each end of the drawer back (L).

5 Remove the sacrificial wood fence and change the fence setting to $\frac{1}{4}$ " to cut the dados in the drawer sides (K), and to cut the grooves along the bottom edges of the drawer front (J) and sides. This groove accepts the drawer bottom panel (M).

6 Dry-fit the parts for the drawer. If everything goes together, glue up the assembly, and use a square to check for 90° corners. Then slide the drawer bottom panel in from the rear and use 1" brads to fasten it to the bottom edge of the drawer back.

7 After the glue joints have dried, remove the clamps, and use a $\frac{3}{4}$ " straight bit in a table-mounted router to cut the stopped grooves in the

drawer sides. (See the Drawer drawing.) Clamp on the guides and fasten with #8 $\times\frac{3}{4}$ " flathead wood screws.

8 Now fit the drawer guides to slide easily in the drawer side groove, sanding the ends to fit the rounded groove ends. Position the drawer guides where shown on the Section View drawing, leaving $\frac{1}{16}$ " clearance along the top of the drawer.

Tackling the final assembly

1 Lay the tabletop (H) upside down on your workbench, followed by the base assembly.

2 Adjust the position of the base so the top overhangs the rear legs by $\frac{1}{2}$ " and the end and front legs by 1". Insert the metal tabletop clips (shown in the Exploded View and Section View drawings) into the grooves in the side rails (B) and fasten them to the tabletop. Two clips per end is plenty, one near each leg. Install pocket screws. (See the Section View.)

3 Insert the drawer about halfway into the base, and mark the tabletop's dado locations on the drawer back as shown in *Photo 9*.

4 Cut the drawer stops (N), and fasten them (temporarily) to the drawer back, with $\frac{5}{16}$ " of the length protruding above the drawer as shown in Drawer drawing.

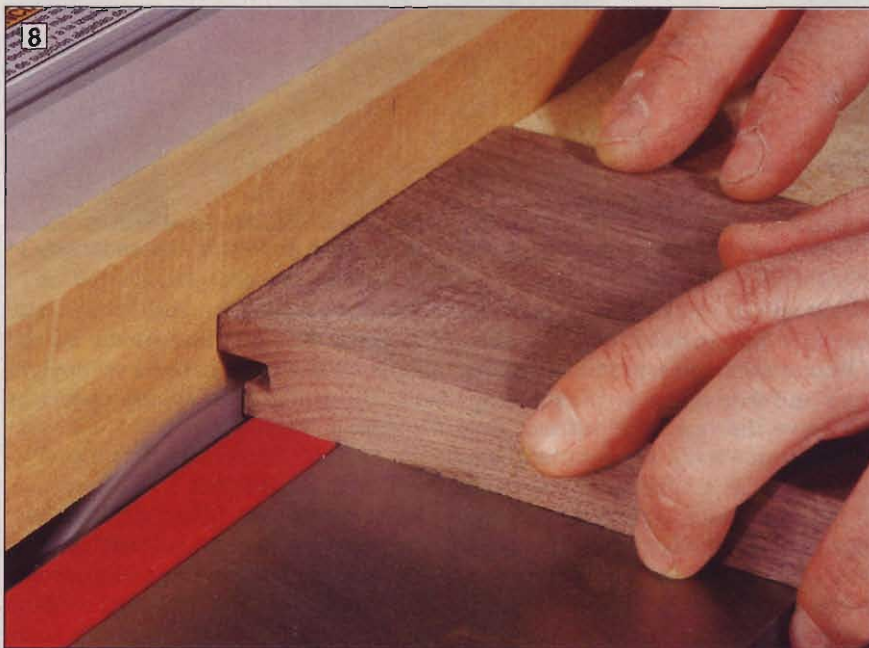

8 After cutting a centered groove in the end of the drawer front, trim half of the rear tongue to make a locking joint.



9 During assembly, turn the tabletop and base upside down and mark the stop locations on the back of the drawer.

Add the finishing touch to complete the table

1 Unscrew the metal fasteners and pocket screws holding the base assembly to the tabletop.

2 Finish-sand any surfaces that will be exposed when the table is assembled, including the inside of the drawer.

3 Dilute a small container of gloss polyurethane varnish with about 25% mineral spirits, and brush a coat on all surfaces, including the underside of the tabletop and the inside of the drawer. (The diluted finish will penetrate further and dry more easily than a full-strength coat.)

4 After the varnish dries, sand all surfaces with 220-grit sandpaper.

5 For a topcoat, brush on a full-strength coat of satin polyurethane varnish. When it's dry, lightly sand the finish again to remove fine nibs or dust; then add the final coat.

6 Reattach the tabletop to the base; then insert the drawer partially into its opening, and use a "stubby" screwdriver to reattach the drawer stops.

7 Drill the $\frac{3}{32}$ " holes for the knob screws. Thread the brass knobs onto the machine screw end of the hanger bolts, and screw the wood-thread ends into the drawer front. That's it for the table, and the mirror frame is even simpler to build!

Next, construct the matching hall mirror

1 Refer to the Hall Mirror Exploded View drawing to get acquainted with the parts for this project; then rip $\frac{6}{4}$ walnut stock (surfaced to $1\frac{1}{4}$ ") for the stiles (A), and cut them to length.

2 Rip walnut stock surfaced to $1\frac{1}{16}$ " for the rails (B) and the upper and lower caps (C).

3 Use the $\frac{1}{4}$ " beading bit in a table-mounted router and rout the bead on the stiles. (See Stile Detail drawing.)

4 Use your tablesaw and a $\frac{1}{2}$ " dado blade (or multiple passes with a standard blade) to cut the rabbets on the rear inside edges of the stiles and rails.

5 Cut mating $\frac{1}{2}$ " \times $\frac{1}{2}$ " rabbets on the front face of each rail, at the ends, as shown in the Parts View drawing on page 58. Try a test cut first in scrap stock the same thickness as the rails, and fit the test piece to the stiles.

6 The upper and lower caps get the same edge treatment as the tabletop. If you haven't cut and routed those pieces already, do that now.

Pocket-hole joints tie the frame together

1 On the back of each rail, lay out the locations for two pocket-hole screws at each end. Use a pocket-hole jig to drill the counterbores and pilot holes.

2 Apply a moderate amount of glue to the rail ends (too much will create squeeze-out onto the stiles) and clamp the mirror rails and stiles together.

3 Check the frame for square; then drive $1\frac{1}{2}$ "-long pocket-hole screws to secure the joints. Remove the clamps.

4 Glue and clamp the upper and lower caps (C) to their rails.

A few more details, then the finish goes on

1 Cut the back panel (D) to size from $\frac{1}{8}$ "-thick hardboard or plywood.

2 On the front surface of the rails, mark the locations for the knobs (see the Parts View drawing). Then drill $\frac{3}{32}$ " pilot holes for the knob screws.

3 On the back of the frame, position a pair of brass wall hanger brackets so the eye on each bracket lands about 5" below the top end of the stile. Mark and drill pilot holes for the screws, but don't install them yet.

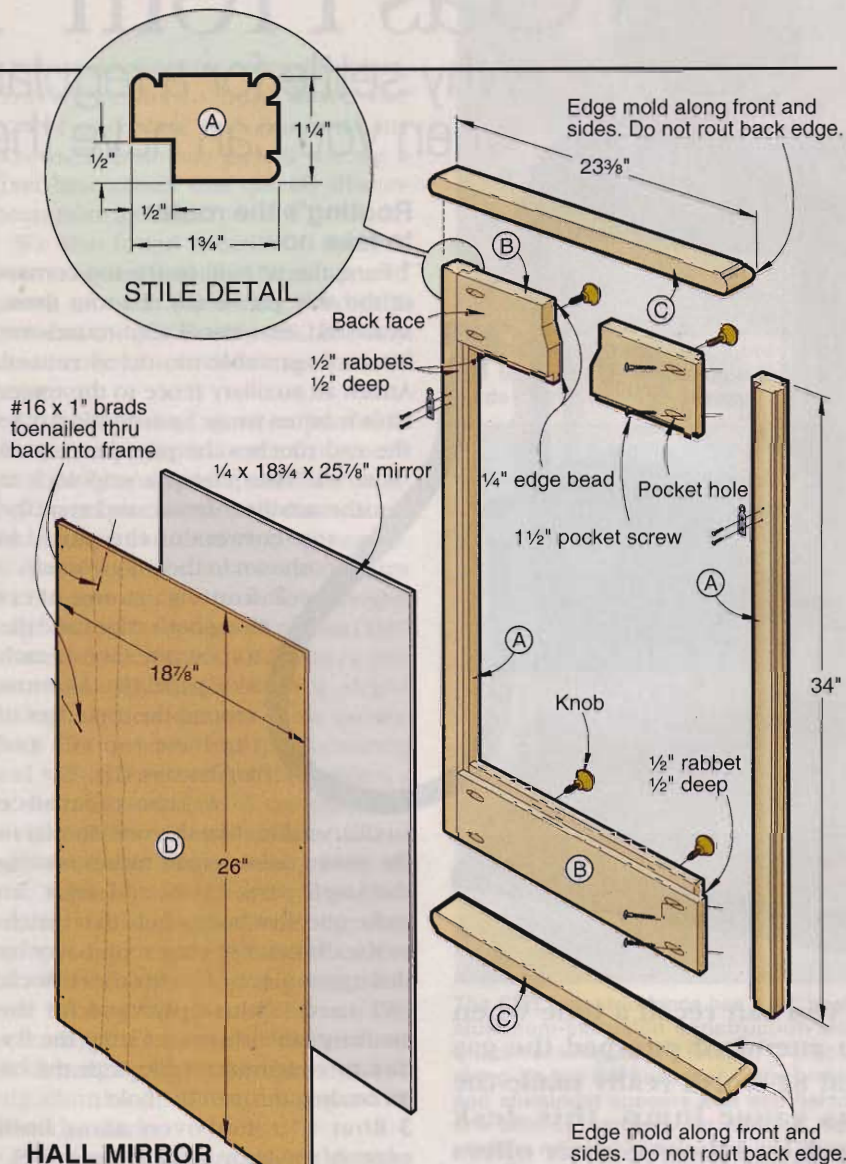

HALL MIRROR EXPLODED VIEW
(shown from back)

4 Apply the finish using the same products and techniques described in the section for the hall table.

5 Have a glass shop cut a piece of $\frac{1}{4}$ " beveled-edge mirror to the size shown. Lay it into the frame and fit the backing panel in behind it. Drive 1"-long brads into the frame to secure the mirror and panel.

6 The hardware wraps things up. Attach the wall hanger and wire to the brass hanger brackets. Then thread the brass knobs onto the hanger bolts and screw them to the front of the rails. 🍄

Bill of Materials

Part	Finished Size			Mtrl.	Qty.
	T	W	L		
A stiles	$1\frac{1}{4}$ "	$1\frac{3}{4}$ "	34"	W	2
B rails	$1\frac{1}{16}$ "	$4\frac{1}{2}$ "	$18\frac{7}{8}$ "	W	2
C upper, lower caps	$1\frac{1}{16}$ "	$2\frac{1}{4}$ "	$23\frac{3}{8}$ "	W	2
D back panel	$\frac{1}{8}$ "	$18\frac{7}{8}$ "	26"	H	1

Materials Key: W—walnut, H—hardboard.

Supplies: 1" brads, #6 \times $1\frac{1}{2}$ " panhead pocket hole screws, $\frac{1}{4}$ " \times $18\frac{3}{4}$ " \times $25\frac{7}{8}$ " mirror, brass hanger, brackets, finish, wire mirror cord. (See also supplies list for table project.)

Buying Guide: In addition to the lumber and supplies shown above, the following items (or appropriate substitutes) are required for this project. All are available from Woodcraft, P.O. Box 1686, Parkersburg, WV 26102, 800/225-1153. Brass knobs (4), no. 02U24, and brass wall hangers (1 pkg.) no. 27K03.

Gas From The Past

Why settle for a regular clock when you can have the high-test version?



If you can recall a time when an attendant pumped the gas and \$2 worth really made the gas gauge jump, this desk clock and thermometer offers high-octane nostalgia. If you can't—well, build it for your mom or dad. They will probably remember.

1 Cut all parts to the sizes shown in the Bill of Materials. You can laminate $\frac{3}{4}$ "-thick stock for the body. Some parts of the gas pump are dyed, so soft maple or basswood, light-colored woods that dye well, are good choices for stock. (We used soft maple.)

2 Referring to the Front View and Side View drawings, lay out the hole locations for the clock and thermometer on the body and the crank and hose swivel on the side panels. It's easier to do this now than later, after the edges of the parts have been rounded over.

Routing's the route to take now

1 Form the $\frac{1}{4}$ " radii on the top corners of the side panels (B). To rout them, as we did, first install a $\frac{1}{4}$ " round-over bit in your table-mounted router. Attach an auxiliary fence to the router table's miter gauge, positioning it so the end touches the pilot bearing on the bit. Then clamp a stopblock to the auxiliary fence, and rout the top corners of the parts, as shown in the photo below.

2 Rout $\frac{1}{8}$ " round-overs along both edges and the top on one face of each side panel (B). Also rout around the top edges of the base top (C) and base bottom (D).

A zero-clearance auxiliary table, like the one shown in the photo below right, makes routing the small parts easier and safer. To make one, just bore a hole that matches the diameter of your round-over bit through a piece of scrap sheet stock. (We used $\frac{1}{4}$ "-thick plywood for the auxiliary table shown.) Clamp the fixture to your router table with the bit protruding through the hole.

3 Rout $\frac{1}{8}$ " round-overs along both edges of the body on both faces.

4 Change to a $\frac{3}{8}$ " round-over bit (enlarge the hole in your auxiliary table, as needed), and rout the round-overs around the top of the body. We gripped the workpiece with a hand-screw clamp to do this.

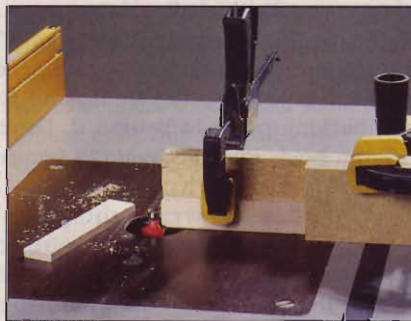

An auxiliary fence on the miter gauge supports the side panels to prevent tear-out when routing radii on the corners.

5 Form a $\frac{3}{16}$ " groove where shown on one side panel (B). You can rout the groove with a $\frac{3}{16}$ " round-nose bit set to cut $\frac{3}{32}$ " deep. Adjust the router table's fence position to center the bit on the side panel (B), and clamp stopblocks to the fence at the positions shown in the Router Setup drawing on page 126. To safely handle the small piece, adhere a scrapwood handle block to its back with double-faced tape, as in the photo on the opposite page. Then, start the router and, with the bottom of the part against the right-side stopblock, lower the side onto the bit and rout the slot.

6 Drill the holes for the clock, thermometer, crank, and hose swivel where marked.

Some assembly is required

1 Finish-sand all parts. After sanding, wet the body (A) and base bottom (D)—the parts that will be dyed—the parts that will be dyed—to raise the grain. Let them dry, and resand lightly, just enough to remove the fuzziness. Doing this now will prevent the grain from raising when you apply the water-base dye.

2 Mix the dye, and dye the body and base bottom. (We mixed $\frac{1}{2}$ teaspoon of water-soluble dye into 4 ounces of hot water and applied it with a foam brush.) Allow the dye to dry.

3 Mask the sides of the body where the panels (B) will glue on, the area of the base top (C) where the body will glue on, and the center of the base bottom (D) where part C will glue on.



A secured zero-clearance table overlay and pad-style pushblock facilitate routing round-overs on the side panels.

Bill of Materials

Part	Finished Size			Mati.	Qty.
	T	W	L		
A body	1½"	2¾"	5¼"	M	1
B side panel	¼"	1"	4¾"	M	2
C base top	¼"	1⅞"	3⅞"	M	1
D base bottom	¼"	2½"	3¾"	M	1

Material Key: M—soft maple

Supplies: aniline dye, aerosol lacquer.

BUYING GUIDE

Clock, thermometer, small parts. Square quartz clock insert with gas-pump face, stand-up thermometer, small parts, aluminum wire, and hose, kit no. GP-1, \$27.95, including shipping in U.S. Schlabaugh and Sons Woodworking, 720 14th St., Kalona, IA 52247. Call 800/346-9663 for credit-card orders.

- 4 Spray clear lacquer onto all parts. Do not apply finish to the bottom of the body (A), the backs of the side panels (B), or the bottom surface of the base top (C). After the finish dries, sand it lightly, taking care not to sand through the color on the dyed parts. Apply another coat of lacquer.
- 5 Remove the masking tape. Glue the side panels to the body where shown. Glue base top C to base bottom D, centering it on top. Apply the glue sparingly. Be sure to wipe away any squeeze-out with a wet rag immediately. Clamp both assemblies until the glue dries.
- 6 Glue the body to the base, and clamp. After the glue dries, apply a third coat of lacquer.

Dress it up for a realistic look

- 1 Bend the crank and nozzle from .098" aluminum wire, referring to the Full-Size patterns on page 126. (Wire for these parts and other small hardware is included in the parts kit listed in the Buying Guide.)
- 2 Slip the O-ring and washer onto the crank. Slide the grommet and one end of the hose onto the nozzle.



Attach a scrapwood handle to the side panel with double-faced tape when routing the slot.

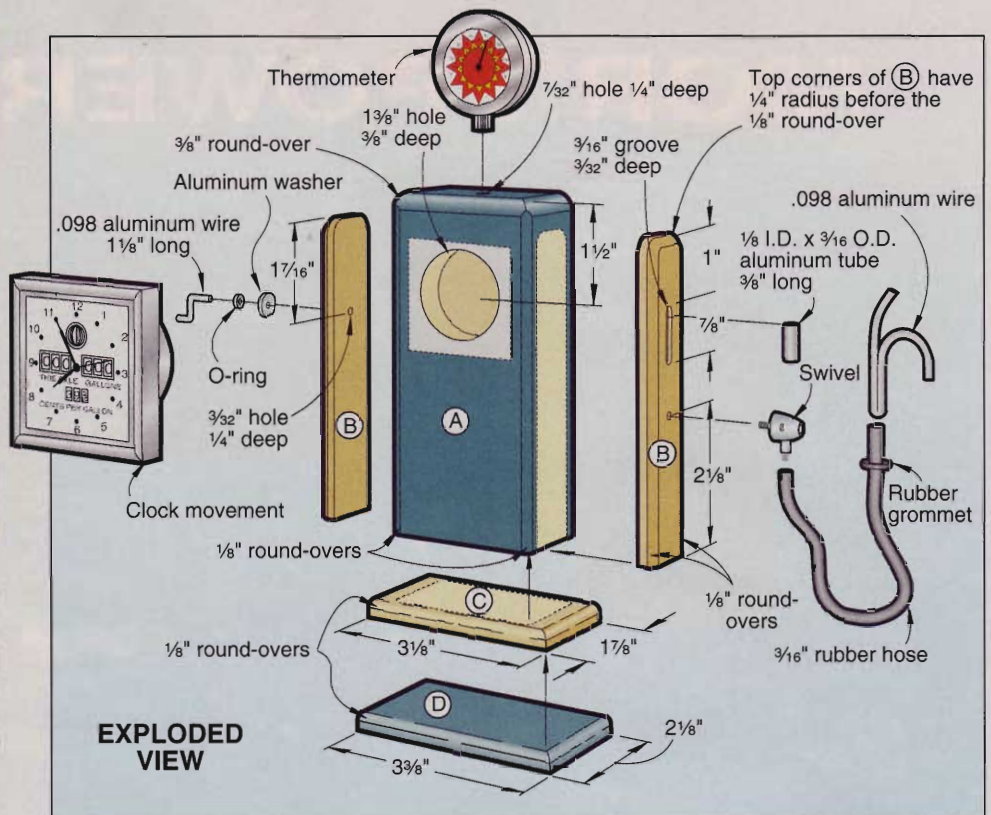

- 3 Shorten the swivel's threaded stud, so only ¼" protrudes from the swivel.
- 4 Epoxy-gue a ⅜" length of ⅜"-O.D. aluminum tubing into the groove in the side panel. Also epoxy-gue the thermometer into the hole on top of the body and the crank assembly and the swivel into their respective holes, with the swivel shaft pointing down.

- 5 Push the end of the hose onto the swivel shaft. (You can first put a spot of epoxy or cyanoacrylate adhesive on the shaft, if you wish.) Then, set the clock, and press the insert into the hole in the body.

Project Design: Schlabaugh and Sons; Jan Hale Svec
Illustrations: Roxanne LeMoine; Lorna Johnson
Photographs: Hetherington Photography

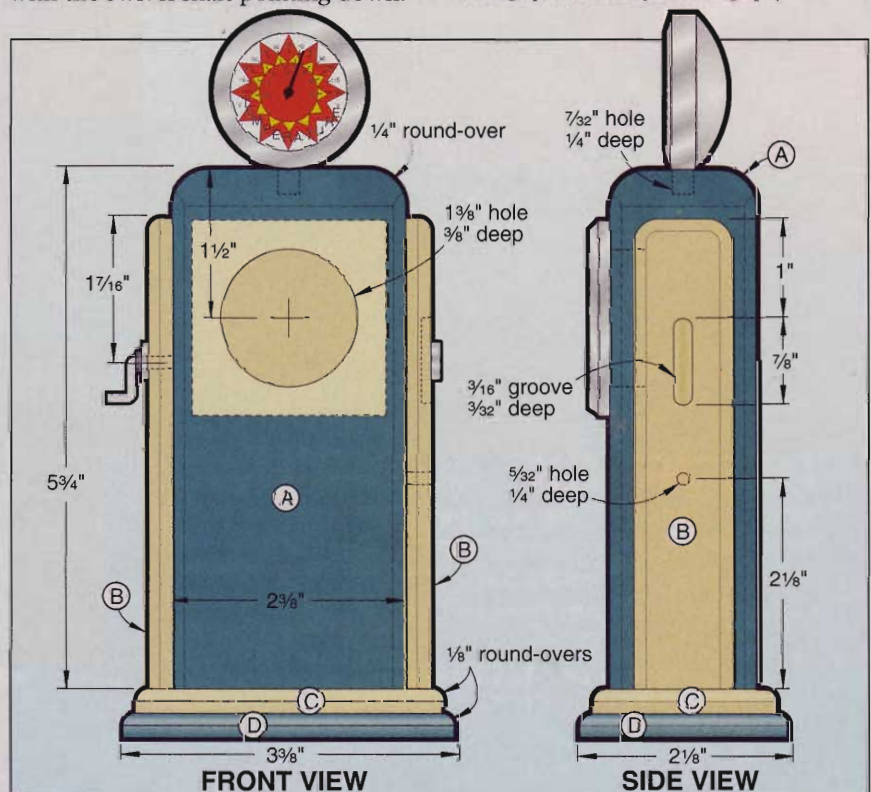

Router Table Roundup

Just the ticket for safe, controlled cuts

A bird in the hand may be worth two in the bush, but a router in the hand isn't worth nearly as much as one in a table. That's because a router table gives you greater command of the workpiece and cutting action, and enables you to work comfortably with a good view of the routing action. To find out which router tables do this best, we tested 16 models priced from \$130 to \$783. Chances are excellent that one of them fits your needs nicely.

Fast Facts

- A good router table gives you accurate cuts in a minimum of time and with as little hassle as possible. Most models fitting that description cost more than \$300, although we found one bargain well under that price.
- Most router tables are floor-standing, but some benchtop models stow away easily to save space.
- Even if you elect to build your own router table, check out the models shown here. You may want to invest in the router-mounting plates or other accessories that are available separately from many of the manufacturers included in this test.

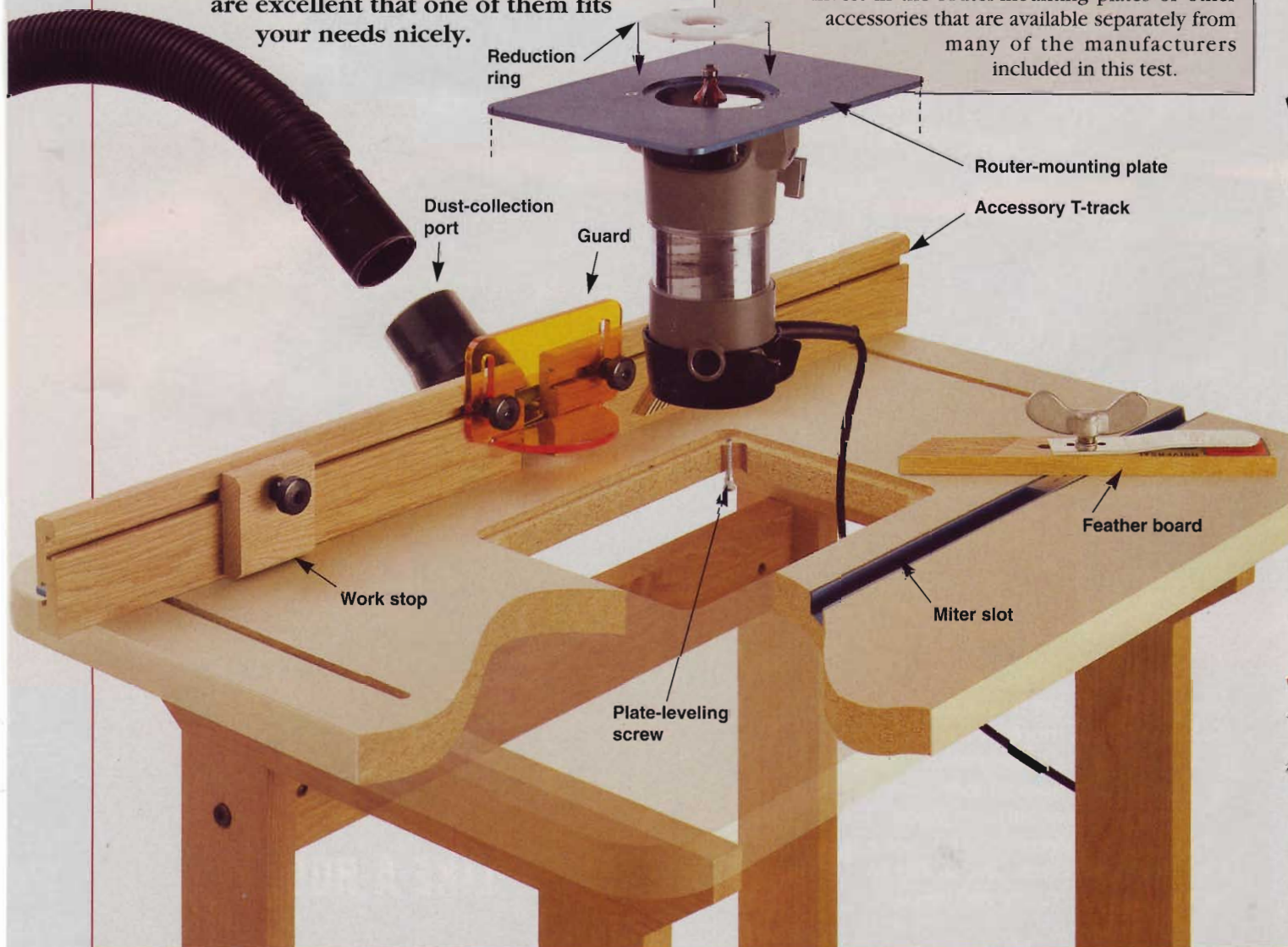

Here's how we chose these router tables

In today's market you can choose from literally hundreds of router tables. Why so many? Several manufacturers make various tops, offer them with a choice of different fences, and support the table with a variety of optional leg sets. For example, Woodhaven offers 54 tabletops; 30 or so leg sets, cabinets, and table-saw brackets; and multiple router plates and fences. You can put together hundreds of various router tables from this one supplier alone!

To keep things manageable, we quickly decided to order just one representative table from each of 16 makers. We typically went with one of the supplier's most popular router-table packages.

In our discussions of each router table, we point out its standard equipment (see the chart at the *end of this article* for more specifics) and some of the variations available. But for any particular model that grabs your attention, we encourage you to contact the supplier and request product information. The table that's just right for your needs might be a variation of the one we tested.

What we looked for in the tested router tables

Before we get into a model-by-model review, here's a quick rundown of the features we find essential to a good router table. Although none of the tables was perfect, the top models scored consistently high marks in most of the following areas:

• **Accessible adjustments.** Router table components, such as fences and fence attachments, have lots of knobs, clamps, screws, and other adjustments for locking things securely into place. The best models have large, accommodating adjustments like the ones at *top right* that are comfortable to grip and easy to reach and operate.

• **Easy router removal.** With plunge routers it's usually easiest to change bits by first removing the router/mounting plate assembly and setting it on top of the table. That said, we found it time-consuming to remove this assembly from tables that

have screws holding down the plate. Gravity seems to hold down the router and plate just fine without screws. This isn't an issue if you use a fixed-base router that quickly disconnects from its base.

We also found it easier to remove routers, and adjust them up and down, on open stands. Enclosed cabinets can complicate this task, but they do a better job of containing dust and noise, too.

• **Flat table and router plate.** If these components aren't flat, you'll have problems making precise cuts in rigid workpieces, such as door panels and frames and drawer components. We tested all of the tables and plates for flatness using a precision straight-edge and feeler gauges. We found that some of the tables and plates are intentionally made with a slight crown at their centers. This crown does not detract from performance and will help counteract the tendency of the table and plate to sag under the weight of the router over time.

• **Reduceable bit opening.** Most of the router plates have rings that enable you to change the bit opening to approximate the diameter of the bit. We think that's an important feature because using a tiny bit in a big opening increases the chances of stock hanging up on the opening or of big chunks of wood tearing away from the stock.

• **Precise and adjustable fence.** Like the fence on a table saw, a good router-table fence will lend convenience and accuracy to your woodworking. We checked the tested fences for straightness and 90° alignment of their faces to the table. Models that adjusted quickly and locked into place securely earned high marks, as did those that accommodated useful accessories, such as featherboards or featured jointing capability (see *right, bottom photo*).

• **Large table size.** If you work with big workpieces you'll find that a large table makes handling stock much easier. You'll find table size listed in the chart. We also make note of the distance from the center of the bit to the front edge of the table—we prefer tables that give at least 11" in this

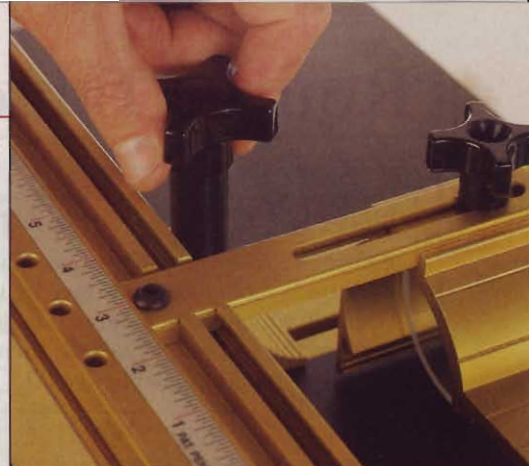

A paragon of comfort and accessibility, the large knobs on the JessEm Rout-R-Slide extend above the fence.

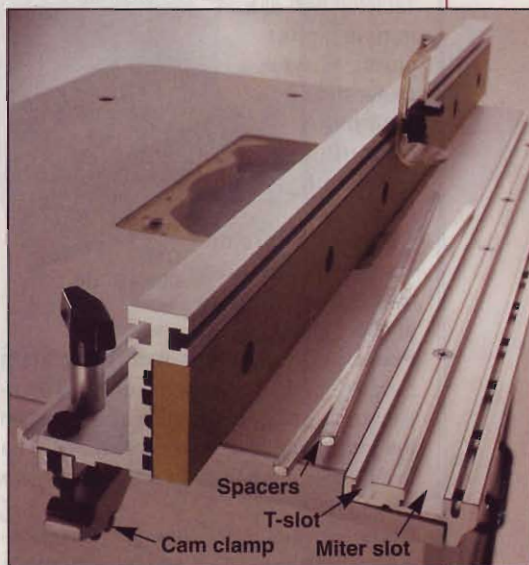

The CMT Industrio fence has it all: beefy aluminum-extrusion construction with quick-locking cam clamps, T-tracks along its top for accessory attachment, and aluminum spacers that slip behind one side of the fence for jointing. Note also the adjustable miter slot and accessory T-track at the front of the table.

dimension. If you're squeezed for space, or simply work with small pieces, look for a high-quality bench-top model.

• **Adaptability to various routers.** A router table won't do you much good if you can't mount your router to it. We had little trouble mounting a variety of 1½-3 hp routers to the tested tables, but with some the task was a bit more complicated than with others. Before you buy any table, check with the supplier that your router can mount to it. Ask if mounting instructions are included, or if optional adapter plates are necessary. Some suppliers sell plates pre-drilled to fit your router.

Continued

Router Table Review

Now let's go shopping for the best router table

Before we tell you which router table to buy, take a few minutes to look over each model and consider its good and not-so-good points. Judge for yourself which model suits your needs, and consider the rankings in the chart at the *end of this article*, then see how your selection compares with our recommendations on *page 70*.

CMT Industrio model 999.401.00

Price as tested: \$400

Components:

Tabletop with aluminum miter slots, acrylic router-mounting plate, aluminum fence with MDF faces. Benchtop version with fewer features also available (priced at about \$200).

Pros: The fence was tops in our test because of its quality construction, versatility, and easy adjustability. T-tracks on the fence and table hold accessories. The miter slot is adjustable for a tight fit to your miter gauge.

Cons: No reduction rings for the router-mounting plate. The heavy cabinet is made of melamine-coated particleboard that damages easily along its unprotected edges that meet the floor.



CMT
999.401.00

Craftsman model 25484

Price as tested: \$170

Components: Steel stand, power switch, aluminum top with miter slot, steel extension wings, reduction rings, plastic fence with dust port. Benchtop version available. Non-Craftsman routers require an adapter plate (\$13).

Pros: Sears routers mount easily to it. Its fence has a built-in jointing feature that works reasonably well.

Cons: Requires considerable assembly. Reduction rings do not sit flush with the tabletop. Plastic fence proved relatively hard to adjust.



Craftsman
25484

Eagle America model 415-0024

Price as tested: \$370

Components:

Tabletop with aluminum miter slot and plate hole centered (as shown) or offset (for use with Inkra Jig), aluminum fence with hardwood face and dust port, wood or steel leg assembly, router plate with reduction rings. Cabinet and benchtop versions and many accessories also available.

Pros: Smallest reduction ring is machined for Porter-Cable guide bushings. Versatile fence adjusts easily.

Cons: Reduction rings require you to use a Phillips driver for removal. Table could use additional bracing to counteract sagging.



Eagle
America
415-0024

Freud model BF/3

Price as tested: \$300

Components: Steel leg stand, tabletop with aluminum miter slots, aluminum fence with dust port and hardwood faces, guards, router plate with reduction rings, miter gauge. Photo *below* shows optional power switch and feather boards.

Pros: Router-mounting plate comes with a pair of lift handles for easy removal of the plate and router. Tubular steel framework provides solid support under table.

Cons: Router-mounting plate and reduction rings have screws that slow their removal. Small knobs make some adjustments relatively difficult.

Bolts that fasten the tabletop to the legs leave holes in the top that could catch chips or workpieces.



Freud BF/3

Hartville Tool model 45266

Price as tested: \$350

Components:

Tabletop with steel cabinet and roll-out tray that holds 40 bits, router plate with reduction rings, power switch with cord, aluminum fence with guard and dust port. Steel legs, extension wings, and other options available.

Pros: Plate leveling system was among the best in performance and durability in our test. The fence was perfectly straight and equipped with a T-slot for holding Inkra accessories, such as a work stop and right-angle fixture.

Cons: The single reduction ring was not dead level with the mounting plate. Fence has no provisions for jointing or for mounting to wood surfaces.



Hartville
Tool 45266

Jesada model RTS-200

Price as tested: \$315

Components: Tabletop with aluminum miter slot, router plate with reduction rings, steel leg set, aluminum Inkra Intelli-fence with dust port. Other versions available.

Pros: Comes with an Inkra Intellifence that provides the ultimate in jointing, edge molding, and working with tall panels on edge. Has a Rousseau router-mounting plate that has a bit opening up to 4" in diameter and comes with snap-in reduction rings.

Cons: Legs were wobbly but could be easily stiffened with addition of diagonal braces or panels. The Rousseau rings are nearly impossible to remove without some sort of prying device, such as a screwdriver. We sanded the ridges on their edges to ease removal.



Jesada
RTS-200

JessEm Rout-R-Slide

Price as tested: \$450

Components:

Tabletop with router plate that slides forward and back with a 14" stroke, reduction rings, wooden legs, pivoting aluminum fence with hardwood face,



JessEm micro-adjustable Rout-R-Slide stop, and dust port.

Pros: This new concept in router tables enables you to not only pass the workpiece through the bit, but to also pass the bit through the workpiece when making box joints and through-dovetail joints without extra jigs. All table components are extremely high in quality.

Cons: Learning to use this router table effectively and to its fullest capability takes time and practice.

Nucraft NU-100 table, NU-200 legs, NU-165 fence, and NU-700 sub-table

Price as tested: \$310 for table and plate, \$151 for legs, \$259 for fence, and \$63 for fence-mounting sub-table.

Components: Cast-iron tabletop with acrylic plate, cast-iron leg set, Incra Jig fence. Accessories include cast-iron extensions, leveling feet, and steel plate with steel reduction rings.

Pros: The top is heavy, stable, flat, and will never distort. It has edges ground flat and exactly 90° to the top, with holes for mounting to a tablesaw. With the Incra Jig you can cut dovetail joints and box joints. An optional steel router-mounting plate has steel rings with leveling adjustability. That accessory costs \$200.

Cons: Price. Too heavy to be considered portable. The Incra Fence doesn't work with large bits, such as panel raisers, and it has no dust-collection capability.

Nucraft NU-100 table, NU-200 leg set, NU-700 sub-table for fence, and NU-165 Incra Jig Fence



Porta-Nails 121 table, 20300 overarm, 20301 miter slide, 20303 fence, and 20305 horizontal-router joint maker

Price as tested: \$545

Components:

Tabletop with miter slot, router plate with leveling screws, miter gauge, steel benchtop legs, pin-routing overarm, aluminum fence, vertically adjustable attachment for holding router horizontally.



Pros: Proves extremely versatile when purchased with all of its attachments. With overarm you can do pin-routing work using templates. The attachment that holds a router horizontally comes in handy for many tasks, such as making mortise-and-tenon joints or raising panels with a vertical panel raiser positioned horizontally. High-quality construction throughout.

Cons: The table's small size proves inconvenient with large workpieces. Its round, narrow router opening restricts you from using many plunge routers. No reduction rings. No dust collection.

Porter-Cable model 698

Price as tested: \$150

Components: Tabletop with miter slot, reduction rings, and steel benchtop legs (floor-standing steel legs optional); steel fence with hardwood faces, guard, and dust port; miter gauge and power switch.

Pros: Inexpensive. Predrilled to fit Porter-Cable routers. Highly portable.

Cons: Table is not flat, and rings do not sit flush with the table. Fence adjustments are time-consuming. Does not accept routers other than Porter-Cable.

Porter-Cable 698



Rockler model 23286

Price as tested: \$150

Components: Tabletop with aluminum miter slot, router plate with leveling screws, reduction rings, aluminum fence with plastic-coated MDF faces. Shown with optional oak legs (\$110). Other accessories available.



Pros: Inexpensive. **Rockler 23286**

The aluminum mounting plate is rigid and won't mar workpieces. All of the aluminum components are anodized. Fence has slots for attaching hold-downs and stop. Plate pre-drilled for some Bosch, DeWalt, and Porter-Cable routers.

Cons: The optional dust port (\$13) should be standard.

Rousseau model 3350R

Price as tested: \$290

Components: Tabletop, aluminum fence with hardwood faces, guard, and dust port. Router plate with reduction rings. Folding steel legs. Other versions and accessories available.

Pros: The largest table in our test makes working with big workpieces a breeze. Stout steel legs fold up for storage and transportation, and sturdy framework under table keeps it flat.

Cons: As mentioned under the Jesada model, the reduction rings on the Rousseau plate are quite difficult to remove without modification. This model doesn't have a miter slot, but you can buy a version of the same table with one.



Rousseau 3350R

Continued

Router Table Review

Veritas model 05J20.23

Price as tested: \$315

Components:

Tabletop with quick-change clamps for holding router, reduction rings, plywood base, aluminum fence with hardwood faces and micro-adjustment for pivoting one end of fence forward and back. Aluminum right-angle sled.

Pros: Smooth steel top has unique cam-action, quick-change rings. Mounting the router requires no drilling because of clamps that hold router securely to table. The clamps also make quick and easy work of removing the router. The fence is a smartly designed, high-quality, three-piece extrusion, and the micro-adjustment mechanism works well. The right-angle sled enables you to make box joints.

Cons: You need to make a simple wrench from wood and two steel pins in order to remove the rings. Top requires waxing to prevent rust.



Veritas
05J20.23

Vermont American model 23463

Price as tested: \$130

Components: Tabletop with miter slot and steel extension wings, power switch and miter gauge, plastic fence with guard and dust chute.

Pros: Inexpensive. You can mount nearly any router to it.

Cons: Extension wings are flimsy, table is not flat, and rings don't sit flush with tabletop.



Vermont
American 23463

Woodhaven TM120 tabletop, 301 leg set, and 202DF fence

Price as tested: \$365

Components:

Tabletop with aluminum miter slot and plate levelers, plate reduction rings, aluminum fence with plywood faces, guard, and dust chute. Wooden leg set. Many versions and accessories available.

Pros: Plate-leveling system works effectively, holds up well, and provides full support for plate. The rings sit flush and snap out easily by hand. The miter slot is adjustable, and the fence has T-tracks for accessories. The tallish table is easy on your back.

Cons: We couldn't find any worth mentioning.



Woodhaven
TM120 table, 301
leg set, and
202DF fence

Woodstock International Rebel model W2000

Price as tested: \$180

Components: Tabletop with miter slot, reduction rings, guard, and miter gauge. Aluminum legs, split aluminum fences with wooden faces. Accessories available.

Pros: Cast-aluminum table and legs are light in weight and won't rust. Snap-in rings install and remove easily.

Cons: The independently adjustable fences are time-consuming to set up. Rings did not sit flush with the top. The somewhat-rough top surface creates drag on the workpiece.



Woodstock
International
W2000 Rebel

Our recommendations for buying the right router table

The Woodhaven table seemed to offer the best overall combination of features and quality construction at a reasonable price. The mind-boggling number of table variations and accessories available for it are a bonus.

If you're looking for something a little smaller, the Veritas benchtop model (\$315 as tested, \$270 without the right-angle sled) has a lot going for it. We especially like its fence micro-adjust and slick router-mounting system.

Fortunately, you don't have to spend \$300 or more to get a serviceable router table. The Rockler model offers a lot of value for \$150. With it you will need to build your own leg stand or buy Rockler's (\$110 for oak, \$70 for pine). None of the other tables priced under \$200 seem worth the investment, in our opinion.

With that said, we also found plenty to like in the CMT, Eagle America, Hartville Tool, Jesada, and Nucraft tables. All of these work fine. The JessEm table makes a lot of sense if you want to make through-dovetail joints or cross-dado long workpieces. The Rousseau's large table and folding legs make it great for job-site work. ♣

MANUFACTURER	MODEL	SIZE (DEPTH X WIDTH) (INCHES)	BIT CENTER TO FRONT EDGE DISTANCE (INCHES)
CMT	999.401.00	24 x 32	9
CRAFTSMAN	25484	14 x 24	9
EAGLE AMERICA	415-0024	24 x 32	12
FREUD	BF/3	19 ³ / ₄ x 26 ³ / ₄	11 ¹ / ₂
HARTVILLE TOOL	45266	24 x 32	12
JESADA	RTS-200	24 x 31 ¹ / ₂	12
JESSEM	Rout-R-Slide	27 ¹ / ₂ x 30	14
NUCRAFT	NU-100, NU-200, NU-700, NU-165	18 x 27	11 ¹ / ₂
PORTA-NAILS	121, 20300, 20301, 20303, 20305	16 x 20	6
PORTER-CABLE	698	16 ¹ / ₄ x 19 ¹ / ₄	11
ROCKLER	23286	24 x 32	12
ROUSSEAU	3350R	24 x 44	16
VERITAS	05J20.23	16 x 24	9 ³ / ₈
VERMONT AMERICAN	23463	14 x 24	8 ³ / ₄
WOODHAVEN	TM120, 301, 202DF	24 x 32	12
WOODSTOCK INTERNATIONAL	W2000	18 x 24	11 ¹ / ₂

NOTES:

- (CA) Cast aluminum
(CI) Cast iron
(MDF/PL) Medium-density fiberboard with plastic laminate
(PB) Particleboard
(PP) Phenolic plastic
(SP) Steel plate
- (N) No
(Y) Yes
(Y-T) Yes, T-style
(Y-2) Yes, 2 slots

Written by Bill Krier
Product testing: Dave Henderson
Photographs: Wm. Hopkins

THE RUNDOWN ON ROUTER TABLES

TABLE					ROUTER-MOUNTING PLATE										FENCES								
HEIGHT (INCHES)	MATERIAL (1)	MITER SLOT (2)	THICKNESS (INCHES)	FLATNESS (3)	SIZE (DEPTH X WIDTH) (INCHES)	MATERIAL (4)	LEVELING DEVICE (YES, NO) (5)	SCREWED TO TABLE (YES, NO)	REDUCTION RING MATERIAL AND NUMBER (6)	MAXIMUM BIT OPENING (INCHES) (7)	THICKNESS (INCHES)	FLATNESS (3)	EASE OF REDUCTION RING REMOVAL (3)	REDUCTION RINGS FLUSH WITH PLATE OR TABLE (3)	EASE OF MOUNTING ROUTER TO PLATE OR TABLE (3)	HEIGHT (INCHES)	STRAIGHTNESS ALONG LENGTH (3)	MOUNTS 90° TO TABLE (3)	EASE OF ADJUSTMENT (3)	JOINTING CAPABILITY (3)	COUNTRY OF MANUFACTURE (8)	WEIGHT (POUNDS, WITHOUT ROUTER)	SELLING PRICE (9)
35	MDF/PL	Y-T	1	E	8 1/4 x 11 3/4	AP	Y	Y	None	2*	3/8	E	N/A	N/A	G	3 5/8	E	E	E	E	U	104	400
38 3/4	CA	Y	3/16	E*	Integral	N/A	N/A	N/A	PL-3	2 13/16	N/A	N/A	E	P	E	4	G	G	G	G	U	43	170
34 3/4	MDF/PL	Y-T	1 1/8	G	8 x 11 3/4	AP or PP	Y	N	PL-3	3 1/2	3/8	E	G	G	G	3 1/4	E	G	E	G	U	50	370
33 1/2	MDF/PL	Y-2	1	E*	6 5/8 x 9 1/4		N	Y	PL-3	3	3/8	E*	G	E	G	2 5/8	E	E	G	F	I	51 1/2	300
34 3/4	MDF/PL	Y	1 1/8	G	8 x 11	PP	Y	Y	PL-1	3 1/16	3/8	E	G	F	G	3	E	E	E	N/A	U	101	350
33 1/2	MDF/PL	Y	1 1/4	E*	9 x 12	PP	*	N	PL-2	3 7/8	3/8	E*	F	E	E	3 1/4	E	E	G	E	U	72	315
33 1/4	PB, PP, MDF/PL	N	1 1/4	G	8 x 8 3/4	AL	N/A	Y	PP-3	3 3/16	3/16	N/A	E	E	E	3 1/4	E	E	G	G	C	68	450
13 1/2	CI	Y-T	3/8	E	9 x 11	AP	Y	Y	None	2*	3/8	E	N/A	N/A	G	3 1/8	E†	E†	E†	N/A	U	138	783
16 5/8	CA	Y	1/4	G	8 Round	AP	Y	Y	None	2*	3/8	E	N/A	N/A	G	2	E	E	E	N/A	U	61	545
13 3/4	CA	Y	1/4	E	Integral	N/A	N/A	N/A	ST-2	3 5/8	N/A	N/A	E	P	E	2 5/8	N/A††	F	F	F	T	35	150
36	MDF/PL	Y	1 1/8	G	8 x 11	AL	Y	N	PL-2	3 1/8	1/4	E	G	G	E	3	G	E	E	G	U	23	150
37	MDF/PL	N	1 1/4	E*	9 x 12	PP	*	Y	PL-2	3 7/8	3/8	N/A	F	E	E	3 1/4	G	E	G	G	U	69	290
15	SP	N	3/16	G	Integral	N/A	N/A	N/A	PL-3	3 5/8	3/16	N/A	G	E	E	1 5/8	E	E	E	G	C	50	315
13 3/4	CA	Y	3/16	E*	Integral	N/A	N/A	N/A	PL-3	2 3/4	N/A	N/A	E	P	G	3	G	G	G	G	U	26	130
37 1/2	MDF/PL	Y	1 1/8	G	9 1/4 x 11 3/4	PP	Y	N	PP-3	3 3/4	3/8	E	E	E	G	2 3/4	E	E	E	G	U	55	365
17	CA	Y	1/4	E	11 x 11	AL	Y	Y	PL-2	4 1/8	1/4	G	E	G	G	3	N/A††	E	F	F	T	35	180

3. **E** Excellent

G Good

F Fair

P Poor

(*) Crowned up at center. Hole can be enlarged by running larger bit up through it.

(†) With optional Inkra Fence

(††) Two-piece fence

4. (AL) Cast aluminum
(AP) Acrylic plastic
(N/A) Not applicable
(PP) Phenolic plastic

5. (*) Plate has threaded holes in corners, but setscrews not included.

6. (PL) Plastic
(PP) Phenolic plastic
(ST) Steel

7. (*) Acrylic plate comes with a 2" opening that can be enlarged by routing up through it.

8. (C) Canada
(T) Taiwan
(U) United States
(I) Italy

9. Prices current at time of article's production and do not include shipping charges.

FOR MORE INFORMATION CALL:

CMT
888/268-2487

Hartville Tool
800/345-2396

Porter-Cable
800/487-8665

Veritas
800/871-8158

Craftsman
Available at Sears

Jesada
800/531-5559

Porta-Nails
800/634-9281

Vermont American
800/442-3405

Eagle America
888/872-7637

JessEm
800/436-6799

Rockler
800/279-4441

Woodhaven
800/344-6657

Freud
800/472-7307

Nucraft
800/971-5050

Rousseau
800/635-3416

WoodStock International
800/840-8420

One Huge Hauler

A tough dump truck for the sandbox set



Modeled after the earthmoving monsters that roam large building sites, this sturdy truck makes moving lots of sand child's play for young construction hands.

Note: We built our dump truck from 1/2"-thick pine, laminating material for the thicker parts. You can resaw and plane pine boards from the lumberyard or home center for the needed stock. A 1x8 and a 1x6, each 6' long, will provide more than enough material for one dump truck.

First up, the cab and chassis

1 Cut three pieces of stock 1/2x2 3/4x13", and glue them face-to-face to make a blank for the chassis (A). Glue the lamination with a water-resistant glue for a toy to be used outdoors. Plane or sand one edge and one end of the blank smooth.

2 Draw a line across the smooth edge 3/4" from the smooth end. Extend the line onto each face. Lay out the rounded front end on the chassis by drawing a semicircle with 3/4" radius centered on the edge line. (See the Exploded View drawing.) Bandsaw the end, and sand it smooth.

3 Cut parts B slightly oversize, then glue one to each face of the lamination. Align the front of each one on

the index line you drew earlier, and place the top edges flush with the top of the chassis lamination.

4 After unclamping, sand the top edges flush if necessary. Trim the lamination to finished length, as dimensioned in the Parts View drawing. Lay out the radii, cutting lines, and hole centers shown in the drawing. Set the part aside for the time being.

5 Cut stock oversize for the cab parts C, D, and E. Build the laminations for parts C and E, keeping the edges flush. After the glue dries, trim one end of the C lamination square and bevel-cut one end of the E lamination to 30°. The cut end will be the back of each part. Draw an index line 1 3/4" from the back end of part C. Draw an

This project was a 1st finalist in the 2000 Wood Magazine Toy Contest. Check the contest on our Web site.

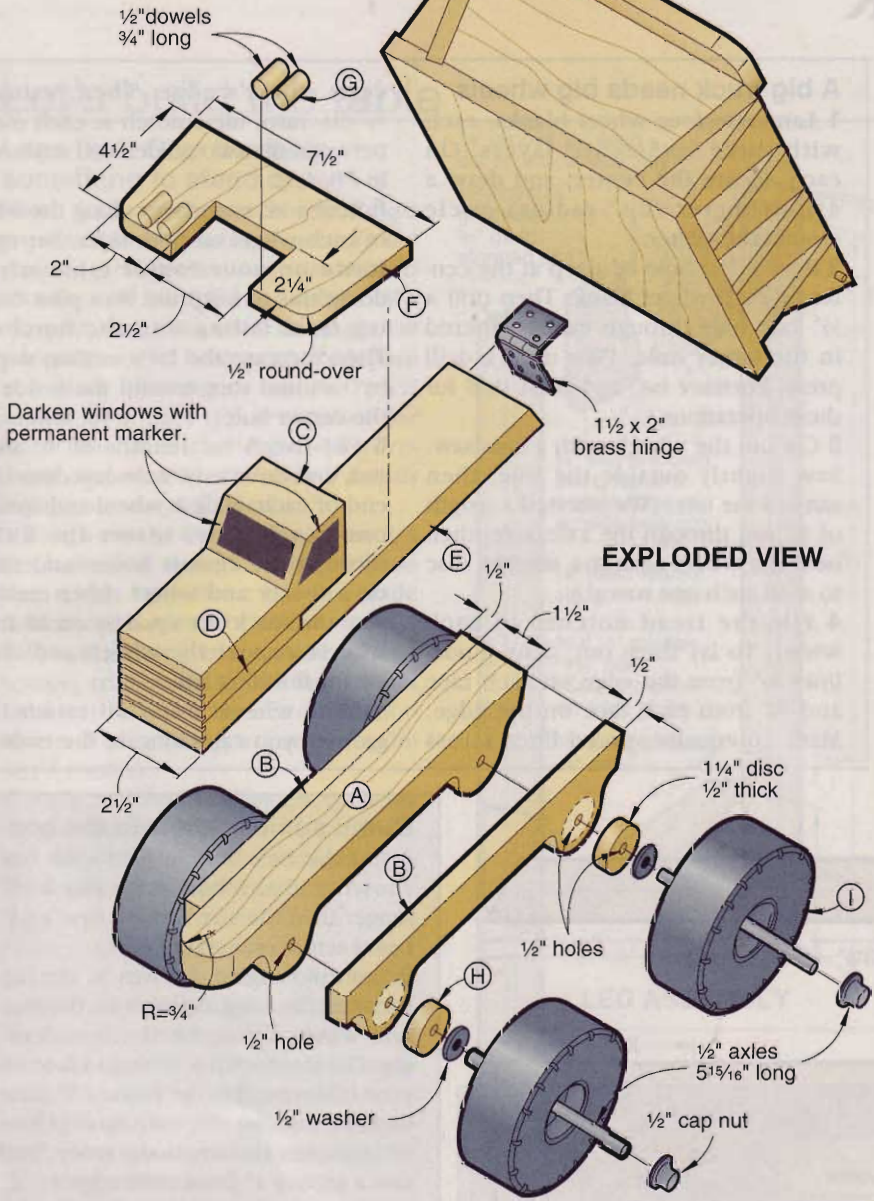

EXPLODED VIEW

Part	Finished Size			Mati.	Qty.
	T	W	L		
A* chassis	1 1/2"†	2 1/2"	12 1/2"	P	1
B* chassis side	1/2"	2 1/2"	11 1/2"	P	2
C* upper cab	2 1/2"†	2 1/2"	5 5/8"	P	1
D* cab spacer	1/2"	2 1/2"	3 7/8"	P	1
E* lower cab	1"†	2 1/2"	13 1/2"	P	1
F fender	1/2"	7 1/2"	4 1/2"	P	1
G headlight	1/2" dia.		3/4"	P	4
H spacer	1/2"	1 1/4" dia.		P	4
I wheel	1 1/2"†	4 1/2" dia.		P	4
J box bottom	1/2"	7 1/2"	8"	P	1
K* box side	1/2"	3 5/8"	10"	P	2
L box front	1/2"	3 1/4"	6 1/4"	P	1
M* box back	1/2"	4 1/8"	6 1/4"	P	1
N brace	1/2"	7/8"	3 1/16"	P	8
O cab shield	1/2"	2"	6 1/4"	P	1

* Cut part oversize initially; then cut to finished size in accordance with how-to instructions.
 † Laminate 1/2"-thick stock for thickness.

Material Key: P-pine
Supplies: 1/2" steel rod, 1/2" axle caps (4), 1 1/2x2" brass hinge, #6x1/2" flathead wood screws.

index line on the edge of part E 9 5/8" form the beveled end.

6 Glue parts C, D, and E together. To do this, first glue part D to the bottom of part C, aligning the back of part D with the index line on part C. Keep the edges flush. Drive in two nails to keep the pieces from creeping. Then spread glue on the bottom of D, and position part E on it, aligning the index line with the back of part D, as shown in *Photo 1*. Nail and clamp the C/D/E assembly.

7 After unclamping, plane or sand the cab lamination (C/D/E) to 2 1/2" wide, the same width as the thickness of the chassis lamination (A/B). Trim the cab lamination to finished length, shown on the Parts View drawing. Cut the

waste off the front. Lay out the cutting line for the hood and windshield.

8 Saw kerfs in the front of the cab lamination to represent the grille. To make the cuts, set your tablesaw blade to 1/8" cutting depth. Position the fence 3/8" from the blade, and cut across the end of the piece, as shown in *Photo 2*. Move the fence 3/8" farther from the blade, and make another cut. Saw six kerfs this way.

9 Now, glue the chassis (A/B) and cab (C/D/E) laminations together. Align the point of the chassis bevel with the bevel on the cab, and keep the edges flush. After the glue dries, bandsaw the cab and chassis to shape and drill the axle holes with a drill press. Sand the bandsawn edges, as necessary.

Continued

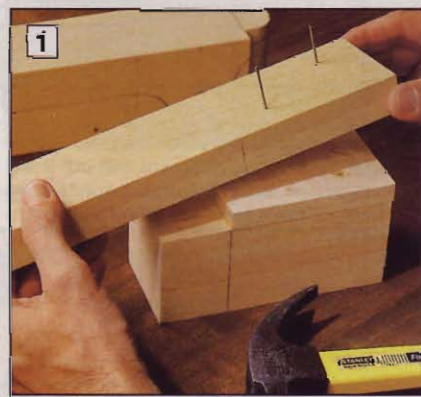

TIP: Drive nails (we used 4d finish nails) into what will be waste areas to prevent laminations from creeping when you clamp them.

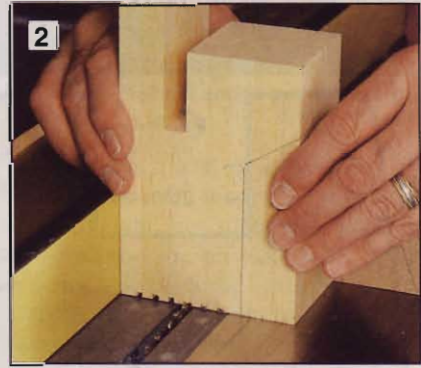

The fence gauges the position of the kerfs and the miter gauge holds the blank square when cutting the grille.

Dump Truck

Add some realistic details

1 Lay out the cab side windows and windshield. Outline them by driving a chisel straight in along the lines, $\frac{1}{16}$ " deep. Keep the straight side of the chisel toward the inside.

2 Cut the fender (F) to shape, referring to the Parts View drawing. Glue the fender into the cab slot.

3 Cut four headlights from $\frac{1}{2}$ " dowel stock. Sand a flat spot on each one, and glue them to the fender, where shown on the Parts View drawing.

4 Draw four $1\frac{1}{4}$ "-diameter ($\frac{5}{8}$ " radius) circles on $\frac{1}{2}$ " stock. Drill a $\frac{1}{2}$ " hole at the center of each one; then scrollsaw or bandsaw the four circles to make the wheel spacers (H).

A big truck needs big wheels

1 Laminate four wheel blanks, each with three $\frac{1}{2} \times 5\frac{1}{2} \times 5\frac{1}{2}$ " layers. On each, locate the center, and draw a $4\frac{1}{2}$ "-diameter ($2\frac{1}{4}$ " radius) circle around the center.

2 Bore a $1\frac{1}{2}$ " hole $\frac{5}{8}$ " deep at the center of each wheel blank. Then drill a $\frac{1}{2}$ " axle hole through each, centered in the larger hole. (We used a drill press, Forstner bit, and twist drill for these operations.)

3 Cut out the wheels with a bandsaw. Saw slightly outside the line; then sand to the line. (We inserted a length of $\frac{1}{2}$ " rod through the axle hole, then held the wheel against a sanding disc to sand each one round.)

4 File the tread notches in each wheel. To lay them out, draw guidelines $\frac{1}{4}$ " from the edge on each face and $\frac{1}{4}$ " from each face on the edge. Mark 16 equally spaced lines across

each wheel's edge. Then, using a $\frac{3}{8}$ "-dia. rasp, file a notch at each mark between the two guidelines, as shown in *Photo 3*.

5 Rout a $\frac{1}{8}$ " roundover along the edge of each wheel on both sides. Set up a fence on your router table when doing this to keep the bit's pilot bearing from falling into the notches. Then increase the bit's cutting depth by $\frac{1}{16}$ ", and rout around the inside of the center hole.

6 Cut two $5\frac{1}{16}$ " lengths of $\frac{1}{2}$ " steel rod, and drive a $\frac{1}{2}$ " axle cap onto one end of each. Slide a wheel and spacer onto each axle, insert the axles through the chassis holes, and slide on a spacer and wheel. After making sure the truck sits squarely on all four wheels, remove the wheels and spacers for finishing later.

If the wheels don't all touch the ground, you can elongate the ends of

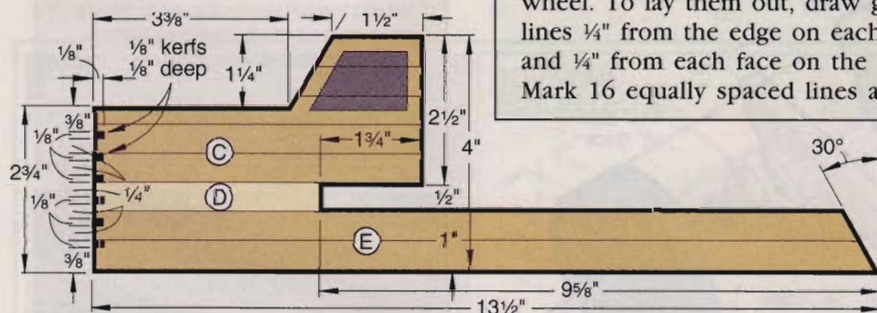

CHASSIS

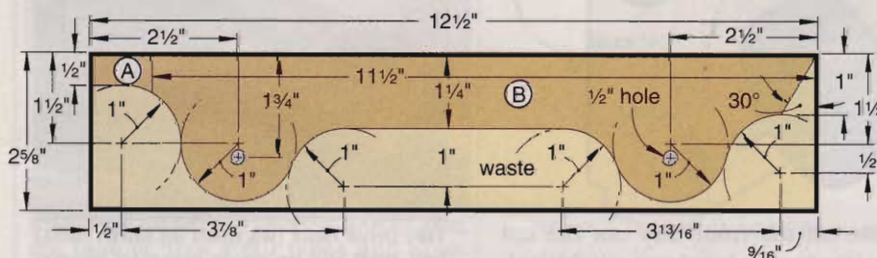

PARTS VIEW

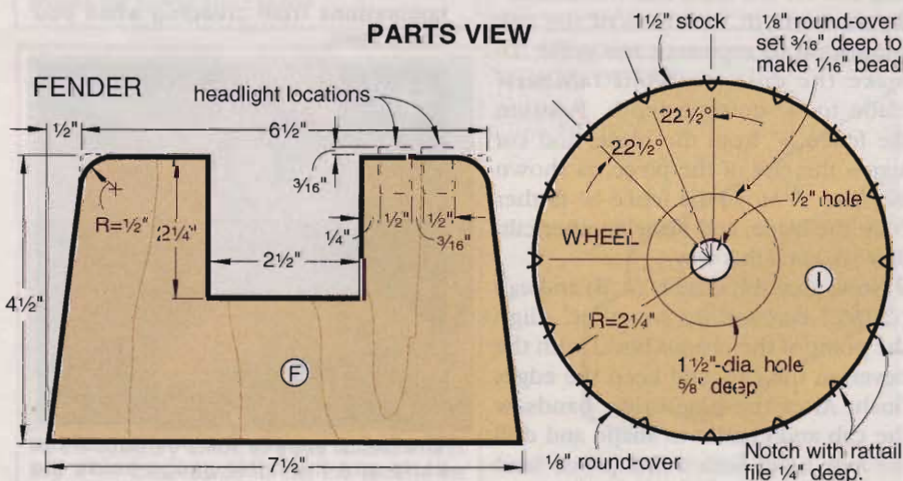

Dump some effort into the box

1 Cut the box bottom (J) to the size shown and the box sides (K) to 1" longer than the size shown. Saw a 31° bevel across one end of part J.

2 Saw two angled grooves in the top surface (the long surface) of the bottom where shown on the Box drawing. Cut them with a $\frac{1}{2}$ " dado blade on your tablesaw. Tilt the blade 15° from vertical, and set the cutting depth to $\frac{1}{4}$ ". Position the saw's rip fence, and saw a groove 1" from each edge.

3 Without changing the blade tilt, remove the dado set and install your standard tablesaw blade. Then bevel the top edge of the sides (K) to 15° .

4 Place the sides in the grooves in the box bottom, beveled edge up. Bring the front ends flush with the front (square) end of the box bottom, and mark the length on the sides at the rear end. Then, using a bevel gauge, transfer the bevel angle from the back edge of part J to the sides (K). Set the blade at 90° to the table, and miter-cut the sides to length.

5 Cut the box front (L) to size. Miter-cut the ends to 15° . (We attached an extended fence to the miter gauge to cut the ends of the part.) Place the box sides (K) in their slots in the bottom (J), and temporarily clamp the



3 Guidelines show how deep to file with the round rasp when notching the tires.

the hole through the front of the chassis. To do this, chuck the $\frac{1}{2}$ " twist drill in a portable drill, and rock it up and down as you drill into the hole from each end.

box front between the box sides, about midway along them.

6 The box back (M) not only fits between slanted sides, it also sits on a slant itself. This calls for compound-angle cuts—cuts made with both a miter angle and a bevel angle. To make the box back, start with a piece of stock 1" wider and 1" longer than the dimensions shown. Rip a 30° bevel on the bottom edge.

Next, trim the ends to length. For these cuts, tilt the saw blade 7° from vertical, and set the miter gauge to 12° . Sketch rough cutting lines on the part to show its finished shape; then saw one end, keeping the long side of the bottom bevel up. Then, instead of resetting the miter gauge for the next cut, just move it to the slot on the other side of the blade. Flip the piece end-for-end, and make the second cut.

7 Test-fit the back (M) between the sides (K). If it's too short—that is, if it doesn't reach all the way from one side to the other—sand or plane the bottom bevel. With the back fitted in place, mark the width, as shown in *Photo 4*. Adjust the blade tilt, and rip the part to width.

8 Glue the sides (K) into the grooves in the box bottom (J), and glue the front (L) in place. Glue in the back

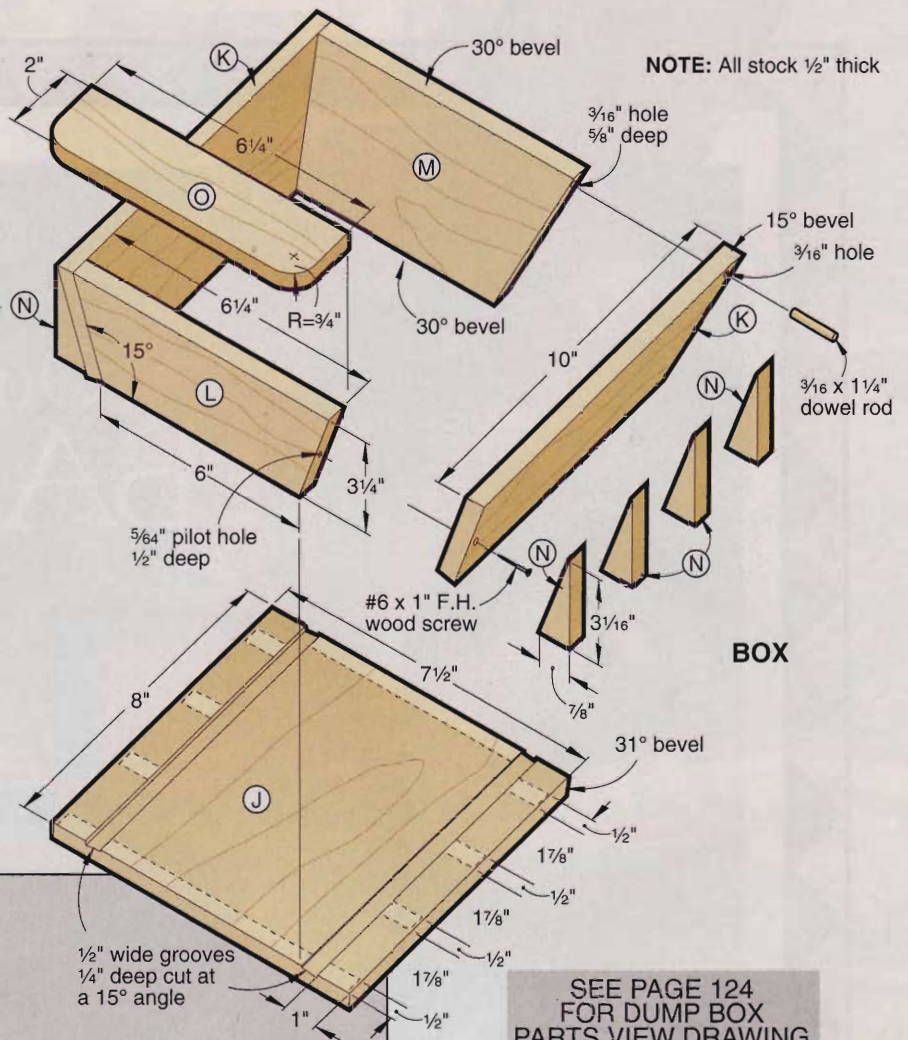

SEE PAGE 124
FOR DUMP BOX
PARTS VIEW DRAWING

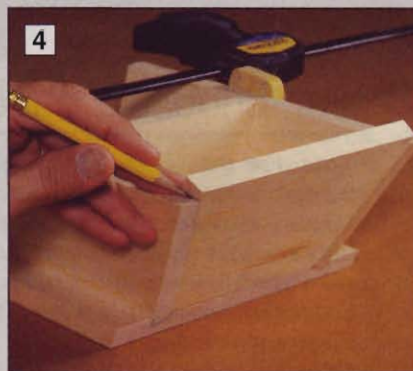

4 The front panel (L), temporarily placed in the center of the box, helps hold the box sides in position while you fit the back panel and mark its width (height).

(M), and clamp the assembly with heavy rubber bands.

Drill and countersink a shank and pilot hole through each side into the front (L) where shown. Drive in the screws. Drill a $\frac{3}{16}$ " hole through each side into the back (M). Glue a $1\frac{1}{4}$ " length of $\frac{3}{16}$ " dowel into each hole.

9 Cut out the braces (N) and cab shield (O), and glue them in place.

Get ready for heavy hauling

1 Finish-sand all parts.

2 Brush on yellow water-soluble dye for a durable color coat. Dye the wheels black. Darken the windshield and windows with a black felt-tip permanent marker.

3 Allow the dye to dry for 24 hours. Then apply exterior polyurethane for a sandbox-safe finish.

4 Slip a wheel, $\frac{1}{2}$ " washer, and spacer onto each axle, and slide them into place. Put the spacer, washer, and wheel on the other side, and drive on the axle caps. Cut a block of scrap-wood to support the opposite end of the axle as you drive the cap on.

5 Screw the box hinge to the back of the chassis where shown. Invert the box on your workbench, and position the cab and chassis on its bottom. Attach the other leaf of the hinge to the bottom of the box. 🛠️

Project Design: David Ashe
Illustrations: Jamie Downing; Lorna Johnson
Photographs: Hetherington Photography



Design and build
your own
**Outstanding
BANDING**

Perhaps you've marveled at intricate patterns of banding on antique furniture, and maybe even bought and inlaid fragile strips of the stuff from a catalog. But have you ever thought about making it yourself? We did,



so we called on Tony Hayden (*left*), who makes banding for much of the custom furniture he builds in his shop in Monterey, California. And we found that it's easier

than you might think. Start with the basic patterns shown here, then design your own, building on what you've learned.

First, choose a pattern to suit your project

(Note: For the Snack Tray project on page 82, we made and inlaid a simple three-stripe banding. However, if you want something more striking—and a bit more challenging—substitute a banding of your own design.)

Inlay banding can be merely decorative, or it can be functional, serving as a transition between veneered plywood and solid-stock edging, say in a tabletop. Using highly contrasting woods, banding calls attention to itself like the silver lining on a dark cloud. Or it can be as subtle as a fragrance, made from the same species as the project but in a contrasting grain orientation. Such subtlety provides visual interest to a piece without overpowering it. The route you choose is largely a matter of personal preference.

If you're not sure where to begin with your design, catalogs, such as Dover Inlay (301/223-8620) or Constantine's (800/223-8087), can give you an idea of what thickness, pattern, and colors might work best with your project. A couple of simple patterns, as well as some corner options, are shown in the Cutting Corners drawing on the *opposite page*. Variations of those and other patterns appear later in this article.

Besides the different species of segments that make up the pattern, for most bandings you'll also need outer banding—the bread around the segment sandwich—to sturdy up the log. (In square and triangle patterns, the segments are glued end-grain to end-grain, making fragile joints. The outer banding helps hold these joints together until the banding

3 steps to understanding banding

To demystify the process of making inlay banding, take a look at the drawing below. Familiarizing yourself with the terms of the trade will help as you learn the full technique.

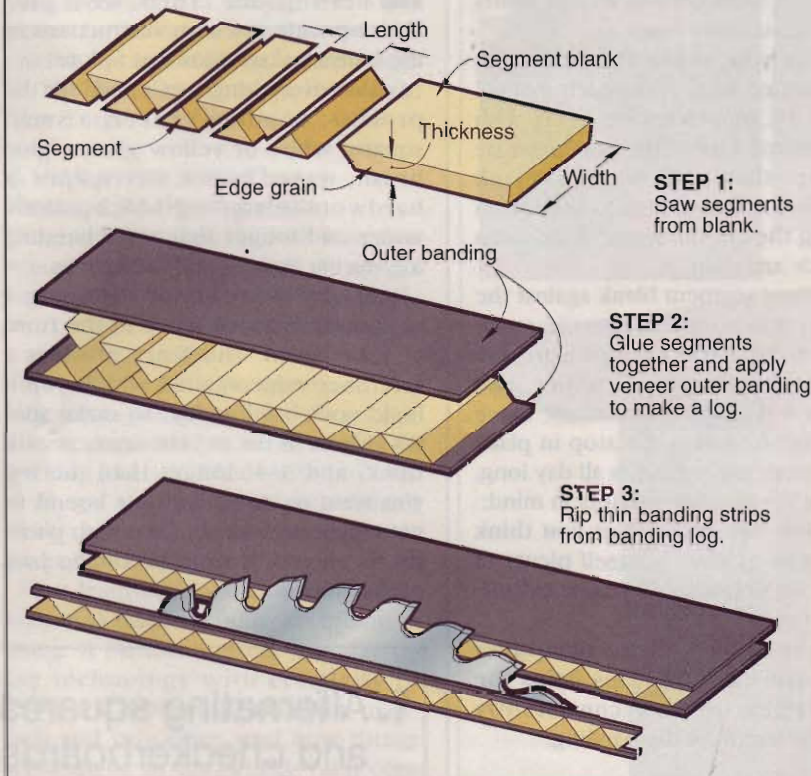

CUTTING CORNERS

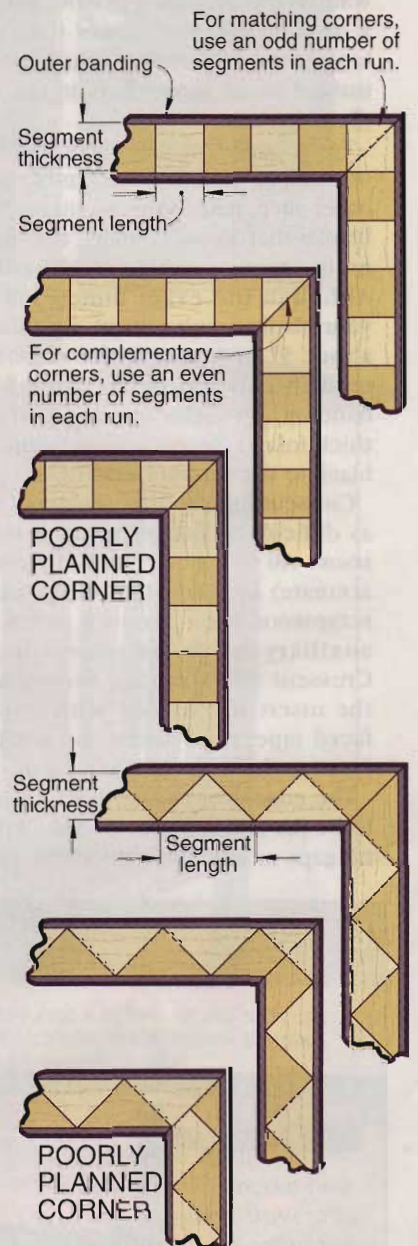

strip can be inlaid into the project: a strong edge-grain to face-grain joint.) You can use whatever species you want for these bands, but a $\frac{1}{16}$ " or $\frac{1}{28}$ " black-dyed veneer (available from Constantine's) nicely sets off the inlay while helping hide glue joints on your project.

Once you decide on the banding's pattern and materials, use the segment thickness to figure each segment's length. For example, if your inlay has square segments, the length equals the thickness; for 45° triangles, the segment length equals twice the thickness.

Next, lay out the inlay location on your project, and measure between the outside corners of the layout lines. Divide the length of a banding run by the segment length and you'll wind up with a whole number and a

remainder. The whole number is the number of segments you'll need for that run.

What about the remainder? If the length of the run isn't critical, round up or down, depending on the corner pattern you desire (see the Cutting Corners drawing), and adjust your run length and layout accordingly. Otherwise, you can divide the remainder by the number of segments and add that fraction to each segment. Repeat the process for the other layout dimensions, adjusting the run or segment length as needed.

Don't worry if your final segment lengths aren't exactly the same for all of the banding runs. You will need to make banding logs specific to each run, but differences of $\frac{1}{32}$ " or so won't be apparent unless the bandings are placed side-by-side.

Continued

Outstanding Banding

Next step: Cutting the segments

To simplify the inlay process, you'll want to cut enough segments to make a banding log 3-4" longer than your longest run. Otherwise, you'll have to make a splice somewhere in the middle of the run.

To be confident that every thin slice of banding will closely resemble every other slice, make your segments from blanks that show straight, consistent grain from one edge to the other. Although the exact dimensions of your blanks aren't critical, rip them to about 5" or less. (Wider segments tend to cup and twist, and a 5"×2' banding log yields about 40' of $\frac{1}{16}$ "-thick inlay.) Resaw and/or plane the blank to the segment thickness.

Crosscutting the tiny segments isn't as difficult or dangerous as it might seem. All you need is a simple (but accurate) crosscut sled set up with a scrapwood zero-clearance insert and auxiliary fence, as shown in the Crosscut Sled drawing *below*. Affix the insert to the sled with double-faced tape, then attach the auxiliary fence to the insert in like fashion.

The edges you cut at this step need to be flat and smooth so there will be no gaps or glue lines anywhere in the

banding log. Therefore, choose a clean, high-bevel-angle, 80-tooth blade for the task. Mount the blade on your tablesaw, set the bevel angle to match your segments, then cut into the sled and insert until the blade just penetrates the auxiliary fence.

Measure your segment length from this indexing kerf, and attach a small stop to the zero-clearance insert with double-faced tape. The stop must be narrower than your segment blank (see *Photo A, below left*) to keep from trapping the cut off segment between the blade and stop.

Place your segment blank against the auxiliary fence on the zero-clearance insert, make a test cut, measure the segment length with a caliper, and reposition the stop if necessary. Once you're satisfied, tack the stop in place and you can cut segments all day long, keeping the following points in mind:

- Cut more segments than you think you'll need to allow yourself plenty of margin for unusable pieces or calculation errors.
- Keep the segments in the same order as you cut them off. This helps the grain appear to flow consistently along the length of the banding.

Assembling a trio of basic bandings

Let's start with the assembly process that's common to all three of our basic banding patterns: squares, triangles, and herringbone. Then, we'll give more specific assembly instructions in the individual sections that follow.

Gather everything you'll need for the process: banding veneer, a small square, white or yellow glue, a glue brush, waxed paper, newspaper, a hardwood clamping block a little wider and longer than your banding log, spring clamps, and bar clamps.

Begin by screwing or clamping a temporary wooden fence to the front of your bench. This fence provides a reference edge against which you'll build your banding log, so make sure it's at least as tall as your segments are thick, and 3-4" longer than the log you want to make. And it's bound to get messy, so wax the face with paraffin to prevent it from becoming part of the glue-up.

1. Alternating squares and checkerboards

Before cutting your square segments, draw two or three pencil lines on one face of each segment blank. Then cut the segments and line them up in the same order as they were cut on a scrap plywood tray. The tray makes it easy to move the segments to your assembly area, and the lines give you a reference to keep the grain running the same direction along the log. Now, build the banding log by following the steps shown in the drawings and photo at *right*.

For simple square banding, clean the unbanded face of the log, then glue and clamp another piece of outer banding to the just-cleaned face. To make the checkerboard pattern, rip the log in half, and glue the cleaned, unbanded faces together, offsetting the the pattern by one segment length.

Continued

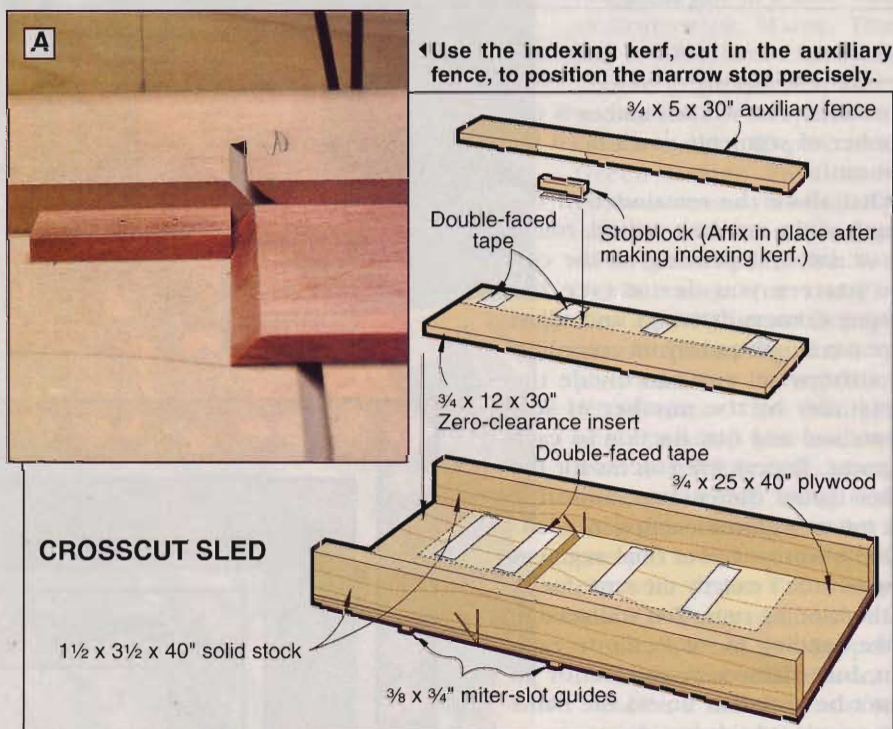

Roll out a strip of high-quality masking tape along the fence, sticky side up. Tack one end to the bench with a short piece of tape, then stretch the strip while you stick down the other end with another piece. Stretching the tape provides a clamping effect during the glueup. Repeat the process, slightly overlapping each strip of tape, until your masking-tape bed is at least as wide as your segments.

The first segment on the tape sets the alignment for the entire log of banding, so make sure it's square with the temporary fence. Stick a square to the masking-tape bed, as shown in *Photo B*, top right, and press the first segment to the tape along the square.

From here on, the technique varies, based on the pattern and shape of the segments, but there are a few more general points to be made about the assembly:

- Before gluing the dyed veneer for the outside banding, clean both sides with lacquer thinner on a cloth to promote better adhesion.

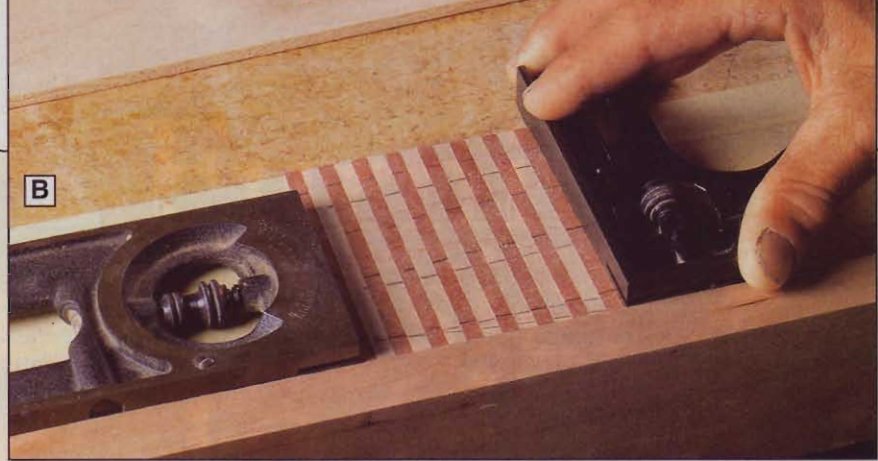

B Use a square (left) to be certain that your first segment goes onto the masking tape straight, then dry-fit the segments together. Recheck with a try-square periodically.

- Be generous with the glue to give yourself plenty of working time—you'll need it. When you think you've got enough, add a little more.

- After the glue sets for 20-30 minutes, unclamp the log of banding and remove the masking tape, because once the glue sets fully, removing the tape is a real bear. Then reclamp the assembly for another 24 hours.

- To get the smoothest gluing surface for the banding veneer, clean up the unbanded face (or faces) using a hand plane, cabinet scraper (*Photo C*), or hard block and 80- or 100-grit paper.



C After unclamping the log of banding, remove masking tape residue and glue squeeze-out with a hand plane, sanding block, or cabinet scraper (shown).

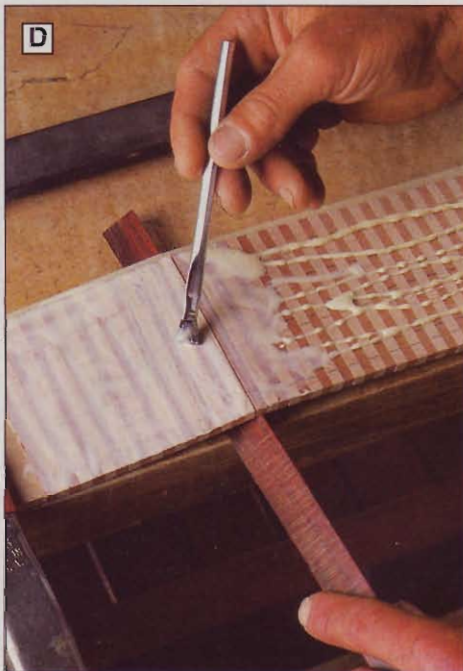

D Lifting the dry-fit segments slightly with a thin stick opens the gap between them, making it easy to brush glue into the joints.

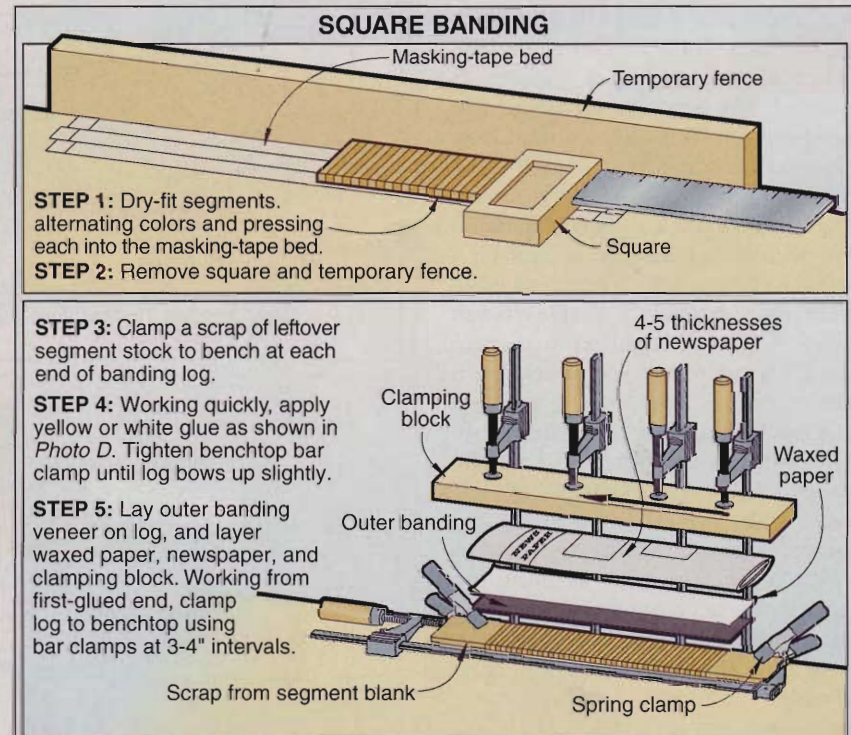

Outstanding Banding

2. Triangles, diamonds, and zigzags

Like squares and checkerboards, these three patterns are simply variations on a theme, this time triangular. Once again, we'll start with the basic pattern and show you how to build on that for a fancier effect.

First, a couple of notes about cutting the triangular segments: To avoid tearing out the fragile edges, leave about $\frac{1}{64}$ " of flat at the top of each triangle

by setting your stopblock a little wide of the mark. And, because some segments will still tear out, cut about 50% more segments than you actually need. Check the pieces carefully before using them and set aside any with lots of tearout or other defects.

With all of your segments cut, assemble the log as shown in the drawings below. Keep in mind that

the exposed end-grain of the segments will drink the glue in like crazy. You may want to enlist a helper to follow behind you, dropping in the top segments as you spread a heavy dose of glue on the hills and valleys.

The banding log's end-grain to end-grain joints are fairly fragile, so leave the log clamped for 24 hours. Then clean up both faces of the log, being

TRIANGLE BANDING

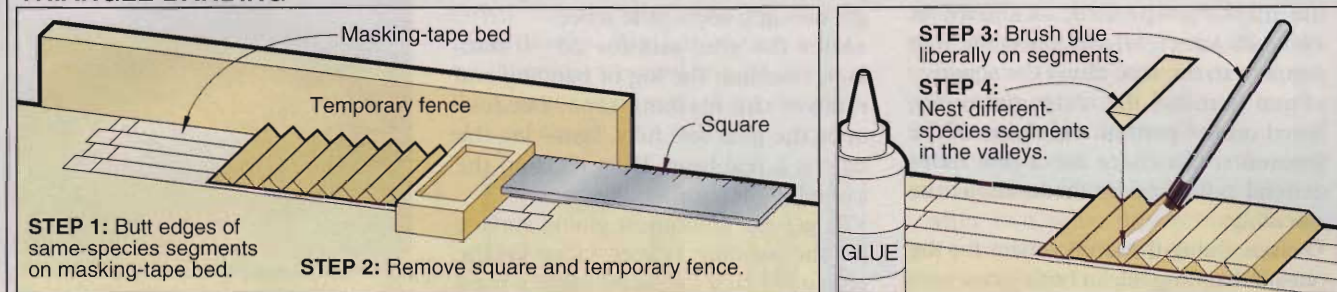

3. Classic herringbone banding

Unlike square and triangular bandings, the joints within a herringbone log are face-grain to face-grain and plenty strong, so outer banding is optional. The herringbone design also differs in the way the segments are cut from the blank.

The banding's face comes from the edge grain of your segment blank so pay particular attention to getting a blank with straight, consistent edge grain. And, because a 2"-thick blank yields a 2"-long segment, a thicker blank means fewer segments you'll have to cut.

To cut herringbone segments, move your stop to the other side of the blade to reduce the likelihood of kick-back. Make a test cut to check for correct segment width. And, just as with square segments, keeping the slices in the same order they come off the blank provides more consistent grain flow throughout the log. Now assemble the banding log as shown in the drawings at right.

HERRINGBONE

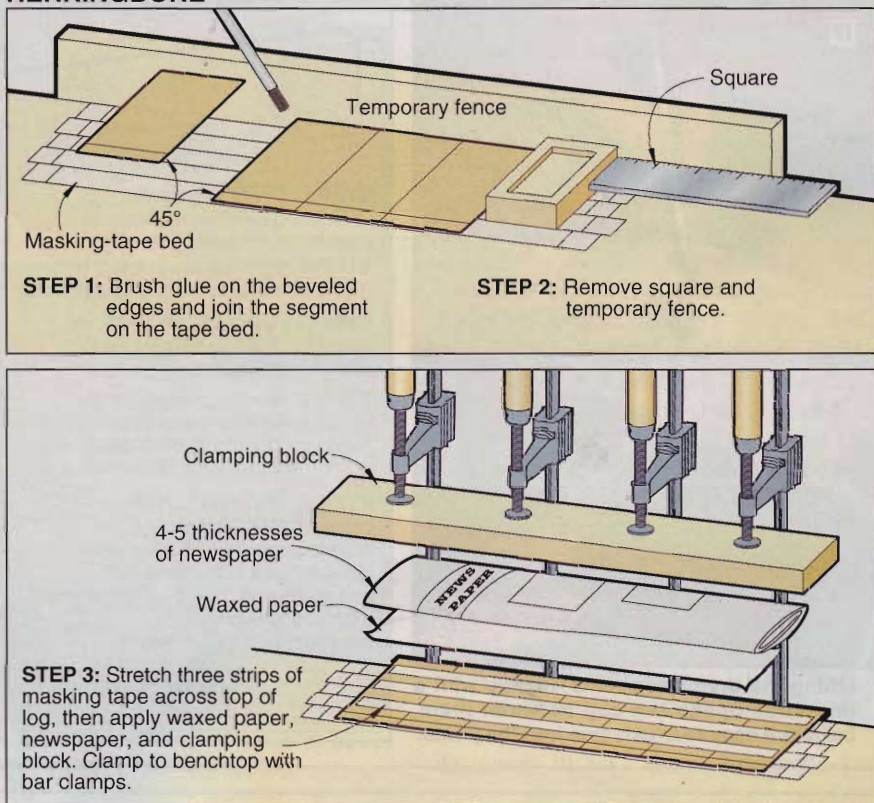

Finally, rip the banding strips

careful not to remove too much material and expose the points. If your design ends here, glue and clamp banding veneer to both faces.

For zigzags, rip the log in half and flip one half back on the other, offsetting the pieces by one-half segment length. Glue the halves together, add the banding veneer on both sides, then clamp.

A diamond pattern can be done just like zigzags, except for offsetting the segments. But a better option is to cut your triangle segments from one species and mating square segments from another species. Put triangles down first, glue and nest the squares, glue and nest the top triangles, and clamp the whole thing at once. Then clean and band the log as usual.

STEP 5: Layer waxed paper, newspaper, and clamping block. Starting from the middle of the log, clamp the assembly to the benchtop using bar clamps spaced at 3-4" intervals.

4-5 thicknesses of newspaper

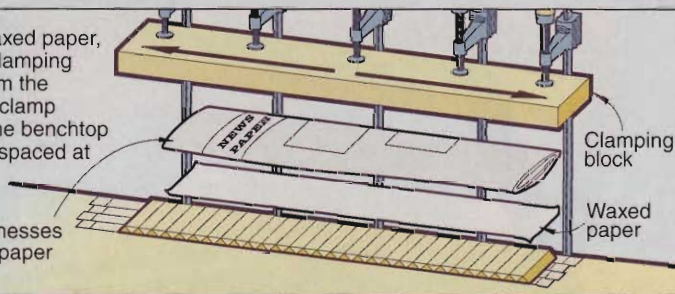

STEP 4: After glue sets, unclamp log and clean both faces. Rip the log in half, or make another log to match.

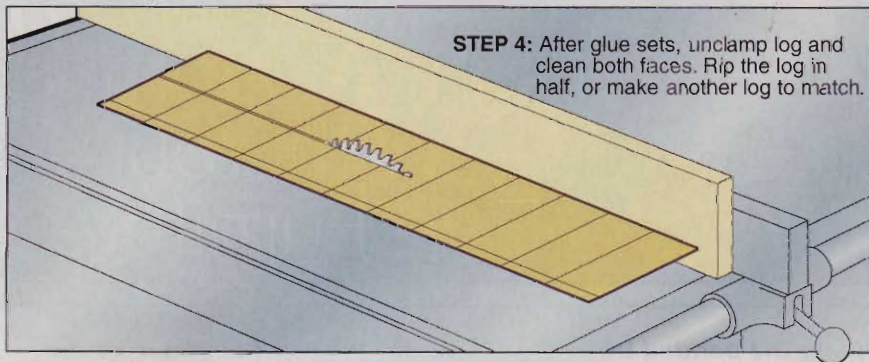

STEP 5: Glue two logs together as shown, taking note to match any color or grain irregularities. Clamp assembly to benchtop.

Clamping block

4-5 thicknesses of newspaper

Waxed paper

Outer banding (optional)

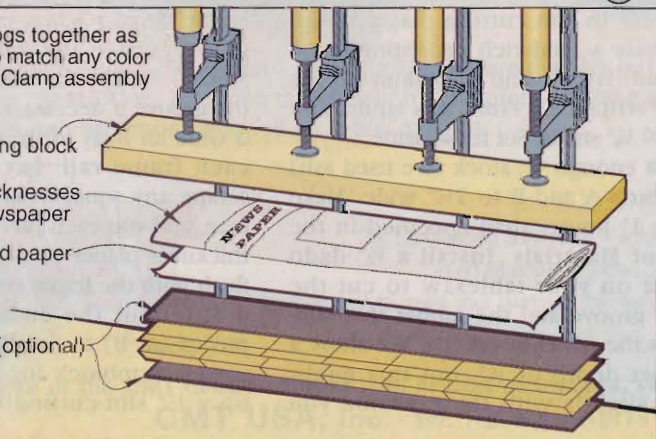

Remove the blade from your tablesaw and replace it with a 7/8" thin-kerf hollow-ground planer blade. The smaller-diameter blade provides a better entry angle for the teeth, resulting in a smoother finish, and the thin kerf gives you an extra 1/16" strip of banding about every third cut. To reduce chipping, use a zero-clearance insert in your tablesaw.

Clamp an auxiliary wooden fence to your tablesaw fence, with the end of the auxiliary fence stopping just short of the center of the blade, as shown in *Photo E, below*. The strip you cut off will want to twist away from the blade; you've just provided it room to do that without binding.



Because the auxiliary fence ends mid-blade, you can rip off strip after strip of banding without fear of binding. Use a push shoe to safely finish the cut.

Set the fence to cut off 1/16" strips of banding. Use a sacrificial push shoe, such as the one shown on the saw table in the photo, to keep the log flat while you complete the cut. Don't get discouraged by the first few strips that come off the log. You'll need to cut 1/4-1/2" from the log before you get through the uneven segment ends and glue squeeze-out.

To install your banding, see our technique in *WOOD*® magazine issue 26, pages 42-47. If you don't have that issue, you can order a back issue for \$6.95 by calling 800/346-9663, or get a reprint of the article for \$5 by writing to *WOOD*® Magazine Reprints—Inlay #26, 1716 Locust Street, GA-310, Des Moines, IA, 50309-3023. ♣

Written by: Dave Campbell
 Technical consultant: Tony Hayden
 Photographs: Kurt Reynolds
 Illustrations: Roxanne LeMoine; Lorna Johnson

Folding Tray Tables



Right At Home
With Your
Fine Furniture

Need flexible dining accommodations for your home? Try the stylish set of folding tray tables we're presenting here. Handsome enough to leave out even when you're not using them, they're very easy to build, and feature a simple inlay banding that adds a touch of class.

Strike up the banded tray

1 Refer to the cutting diagram and laminate a sandwich consisting of $\frac{1}{8}$ " walnut, $\frac{1}{4}$ " ash, and $\frac{1}{8}$ " walnut for the inlay strips (D). From this lamination rip 20 $\frac{1}{8}$ " strips. Set these aside.

2 Cut enough $\frac{3}{4}$ " stock (we used ash) for parts A and B to $2\frac{1}{2}$ " wide. Make each 1" longer than specified in the Bill of Materials. Install a $\frac{1}{2}$ " dado blade on your tablesaw to cut the inlay groove and the rabbet that supports the panel insert (C). We show a rabbet depth of $\frac{1}{4}$ ", but this might vary slightly with the plywood you

use for the panel inserts. (See the Frame detail.) When cutting the inlay groove, test-fit the inlay strips cut in Step 1. Shim your dado set to widen the groove if necessary.

3 Glue an inlay strip into a groove in each frame rail. Let the glue dry, scrape any squeeze-out from the surface, and run each piece through your thickness planer to shave the banding flush with the frame surface.

4 Miter-cut the ends of the frame pieces (A, B) to finished length. (We used a stopblock for this.) Then set up a $\frac{1}{4}$ " slot-cutting bit in a router

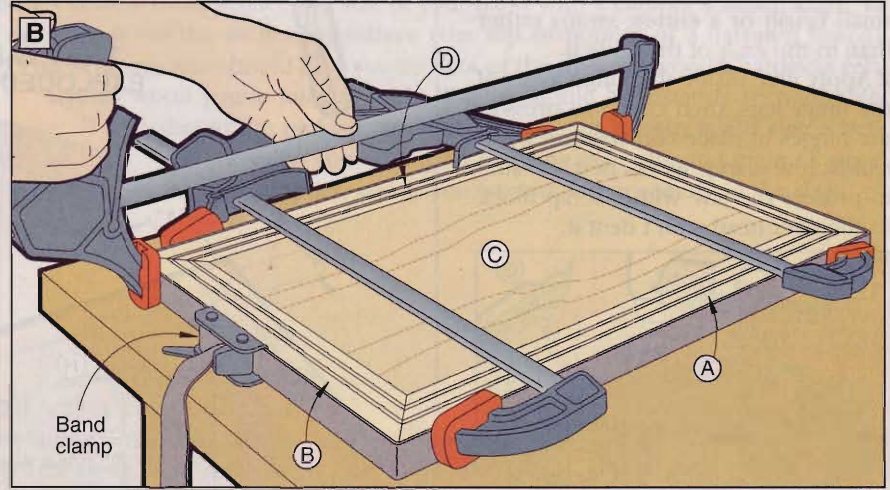
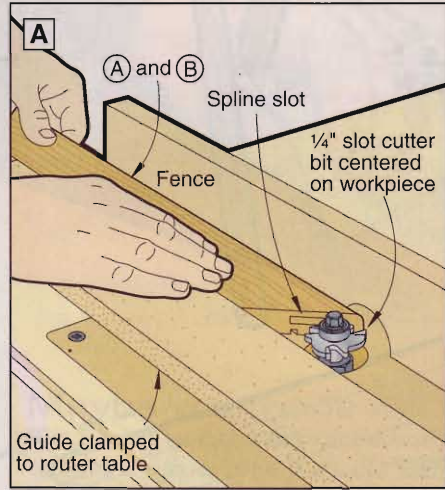
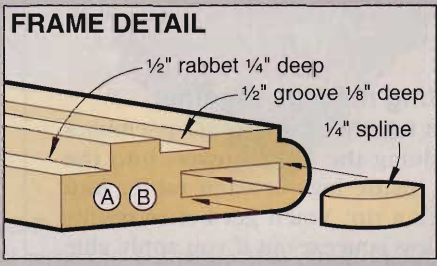
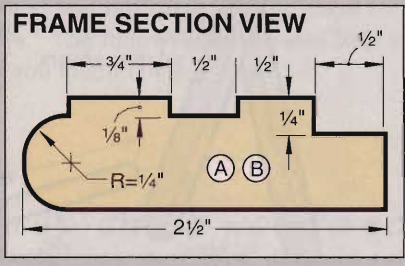
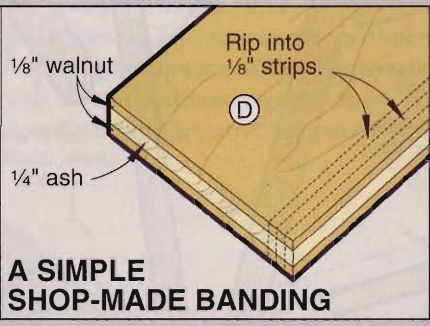
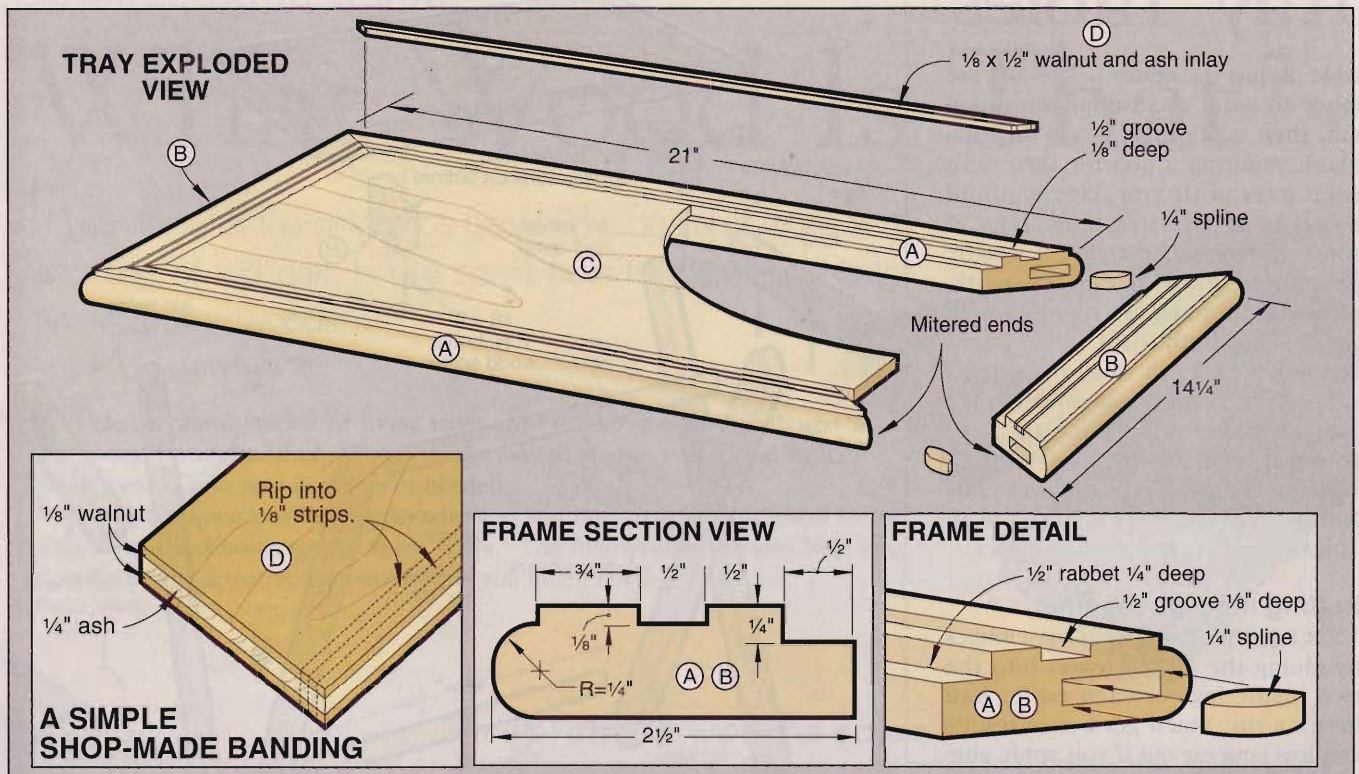

table to cut the pocket for gluing in the corner spline (*Illustration A*). Cut the splines from 1/4" hardboard.

5 Dry-test the pieces to check the frame alignment; then cut and fit the panel inserts (C). Glue the corners (and splines) together, drop the panels in as a temporary "form," and wrap a band clamp around each assembly to cinch it (*Illustration B*).

6 After the corner joints have a chance to set up, glue and clamp the panel inserts into the frames.

7 Using a 1/4" round-over bit in a table-mounted router, rout the outside

edges of each tray as shown in the Frame Section View drawing.

The leg assemblies—three simple parts, clever hardware

1 Cut the 16 legs (E) to size, mark layout lines for the rounded ends, and use a bandsaw to rough-out the cuts. Sand the ends to the line with a disc or belt sander. Rout 1/4" round-overs on all leg edges using a table-mounted router and piloting bit. Rout 1/4" round-overs where shown on the cleats.

2 Cut the tray cleats (F) to size, and shape the lower corner of each end to

a 3/4"-radius, as shown in the Tray Bottom View drawing.

3 Use the drill press to drill the 3/4"-diameter holes 1/16" deep in each leg, for both the pivot hinges and the cross dowels. (*The eight inner legs get the extra hole near their lower end. We marked our inside legs 'E/in' to avoid confusion.*) Also, drill the 3/4" holes in the tray cleats at this time. Next, drill the shank holes in the cleats and countersink.

4 Cut eight 3/4 x 3/4 x 20" strips for the cross dowels (G). Next, install a 3/8"-radius round-over bit in your router

Continued

Tray Tables

table. Adjust the cutter height and the fence to get a precise quarter-round cut, then make four passes on each blank, rotating a quarter turn with each pass until you have a round dowel $\frac{3}{4}$ " in diameter. Stop about 2" short of each end, leaving it square. This allows you to keep the workpiece from turning as you rout. Then cut the dowels to length.

5 Apply your finish to all these parts while they're still unassembled. (We used two coats of polyurethane.) Put cotton balls in all $\frac{3}{4}$ " holes, and use tape to mask the cross dowel ends and the top edge of each tray cleat. This will protect the gluing surfaces.

Putting the legs together

1 Put together four E/G subassemblies by gluing the cross dowels into the two inside legs of each table. And here's a tip: You'll get better results and less squeeze-out if you apply glue to the side walls of the holes (with a small brush or a cotton swab) rather than to the ends of the dowels.

2 Apply glue inside the hinge holes of the inner legs, then clamp to press-fit the hinges in place (*Illustration C*). A handscrew clamp works best. Be sure to protect the jaw with a scrap block so the rivet head won't dent it.

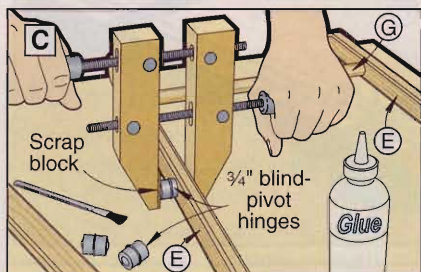

3 Use the same method to make up the E/F subassembly. Then, affix these subassemblies to the inner leg subassemblies by gluing them to the hinges at the center pivot holes. Assemble all the leg frames.

Yes, there is a catch

1 Make eight photocopies of the Catch Pattern; then cut eight blanks to size. These catches help keep the tray tables locked upright when in use. Before you glue the patterns on for contour cutting, drill the $\frac{3}{4}$ " holes in the face of each block. Use a fence

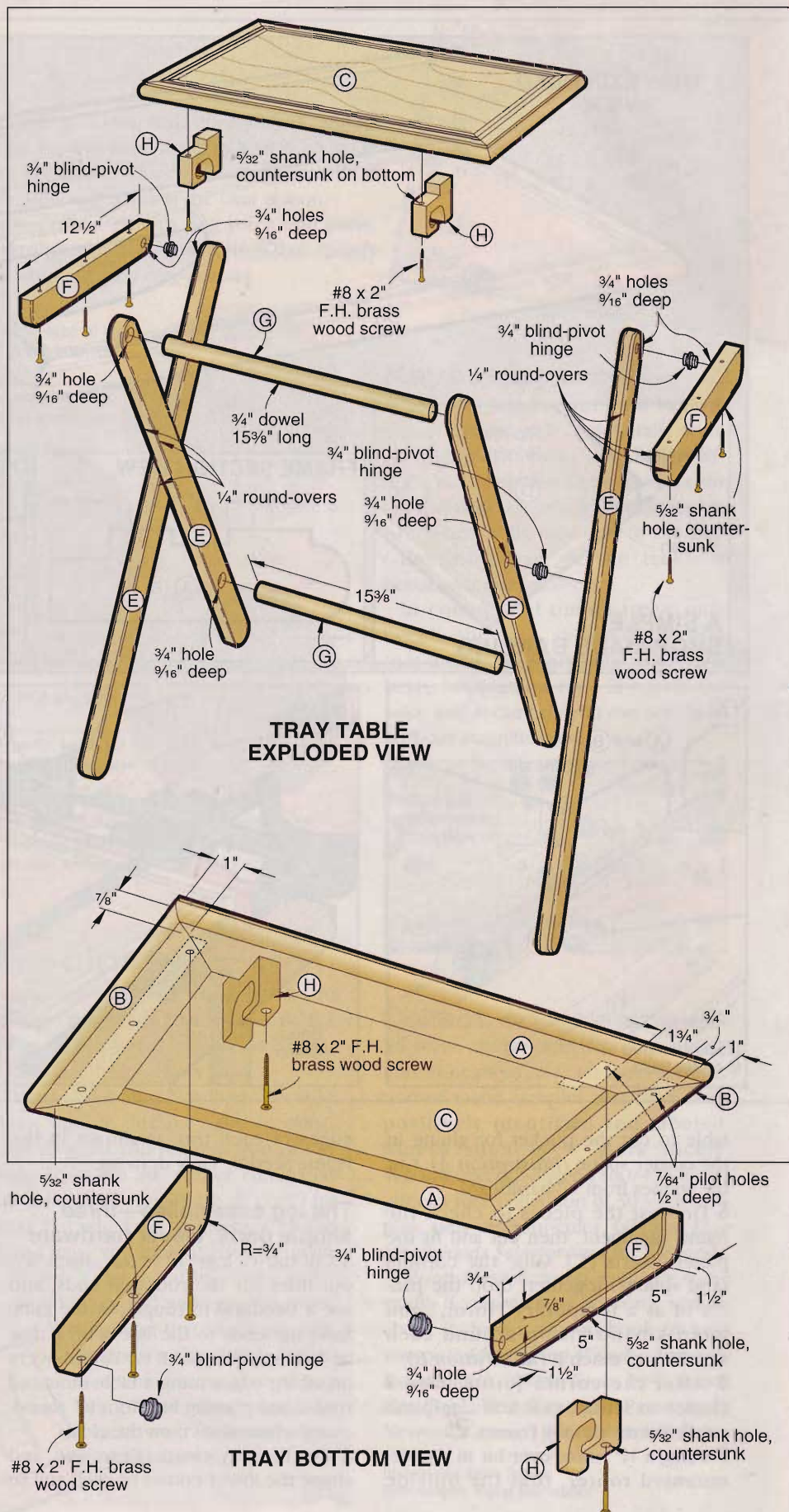

CUTTING DIAGRAM

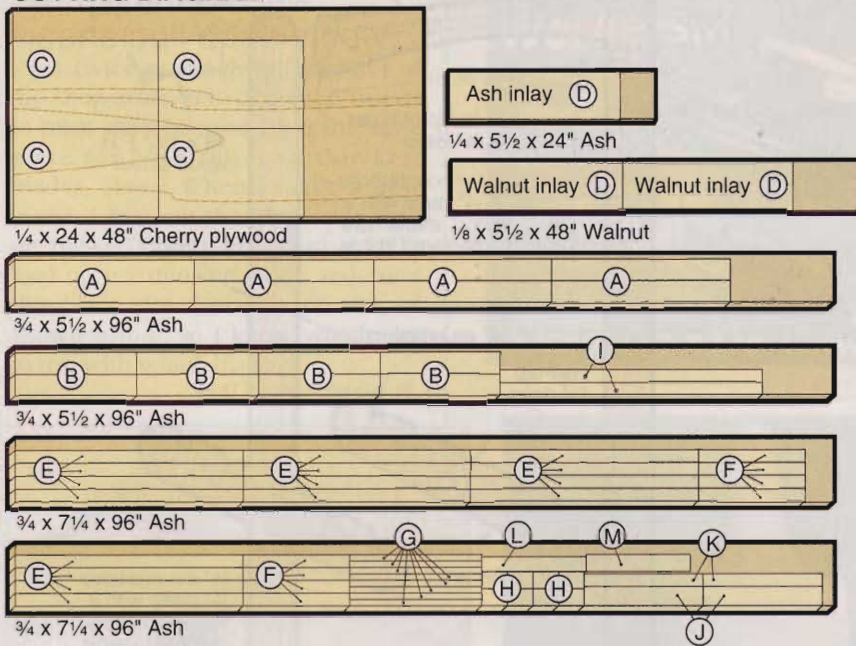

Bill of Materials

Part	Finished Size			Mati.	Qty.	Part	Finished Size			Mati.	Qty.
	T	W	L				T	W	L		
TRAY						STAND					
A frame rails	$\frac{3}{4}$ "	$2\frac{1}{2}$ "	21"	A	8	I uprights	$\frac{3}{4}$ "	$1\frac{1}{2}$ "	$30\frac{3}{4}$ "	A	2
B frame ends	$\frac{3}{4}$ "	$2\frac{1}{2}$ "	$14\frac{1}{4}$ "	A	8	J feet	$\frac{3}{4}$ "	$2\frac{1}{4}$ "	14"	A	2
C panel inserts	$\frac{1}{4}$ "	$10\frac{1}{4}$ "	17"	CP	4	K arms	$\frac{3}{4}$ "	$1\frac{1}{2}$ "	14"	A	2
D inlay bands	$\frac{1}{8}$ "	$\frac{1}{2}$ "	20"	A/W	20	L handle	$\frac{3}{4}$ "	$1\frac{3}{4}$ "	$12\frac{1}{4}$ "	A	1
LEGS						M stretcher	$\frac{3}{4}$ "	2"	$12\frac{1}{4}$ "	A	1
E legs	$\frac{3}{4}$ "	$1\frac{1}{2}$ "	$26\frac{3}{4}$ "	A	16	Inlay Material: $\frac{1}{4} \times 5\frac{1}{2} \times 22$ " ash laminated between two layers of $\frac{1}{8} \times 5\frac{1}{2} \times 22$ " walnut; rip this lamination into strips slightly thicker than $\frac{1}{8}$ ". (See <i>A Simple Shop-Made Banding</i> .) After they're glued in, you'll sand them flush with the frame. Supplies: #8 $\times 1\frac{1}{4}$ " flat-head wood screws (8), #8 $\times 2$ " flat-head brass wood screws (32), $\frac{3}{4}$ "-diam. blind pivot hinges (16). (Roto-Hinge blind pivot hinges are made by Abra Inc., P.O. Box 1086, Bloomington, IN 47402, 812/339-5237. Abra will sell direct or refer you to a catalog retailer.)					
F tray cleats	$\frac{3}{4}$ "	$1\frac{1}{2}$ "	$12\frac{1}{2}$ "	A	8						
G cross dowels	$\frac{3}{4}$ "	$\frac{3}{4}$ "	$15\frac{3}{8}$ "	A	8						
H catches	$\frac{3}{4}$ "	2"	3"	A	8						

Materials key: A—ash, CP—cherry plywood, A/W—ash and walnut inlay banding (see note on inlay material at right).

and stop to keep the hole placement consistent. The cross dowel must nest equally in both catches of each table.

2 For the offset notch at the top of each catch, use the pattern as a rough guide only. Your plywood thickness will determine exactly how much of the frame rail is exposed. For accuracy, mark one block directly against the frame to find the actual offset (*Illustration D*). Then set up a fence and a stop on your bandsaw to cut the notches on all the catch blocks.

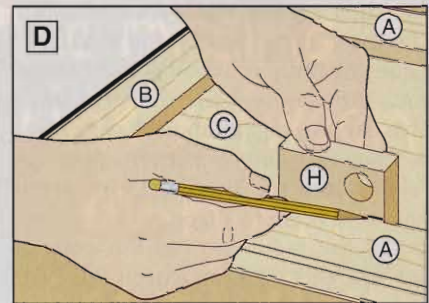

3 Now glue the catch patterns onto the blanks, and bandsaw near the inside contour line. Use a spindle sander to sand to the line so the dowel fits snugly (*Illustration E*).

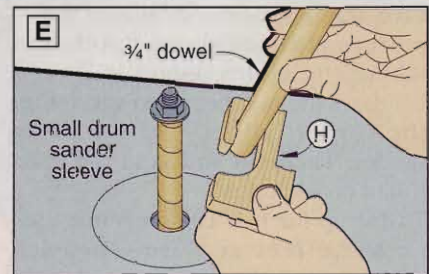

4 Drill the countersunk holes through the catch block supporting the notched ends. Remove the patterns, and glue and fasten a pair of catches to the underside of each tray table. (See the Tray Bottom View drawing.)

5 With each tray table upside down, mark layout lines for the cleat positions. Then set the leg assembly in place and align the cleats with the layout marks. With $\frac{1}{16}$ "-thick shims in place to keep the legs and cleats aligned, tap screws into the cleats' mounting holes to make indentations in the tray frame (*Illustration F*). Then shift the leg assembly aside to drill pilot holes for the screws. Glue the leg assembly's cleats into position, and drive the screws to secure them.

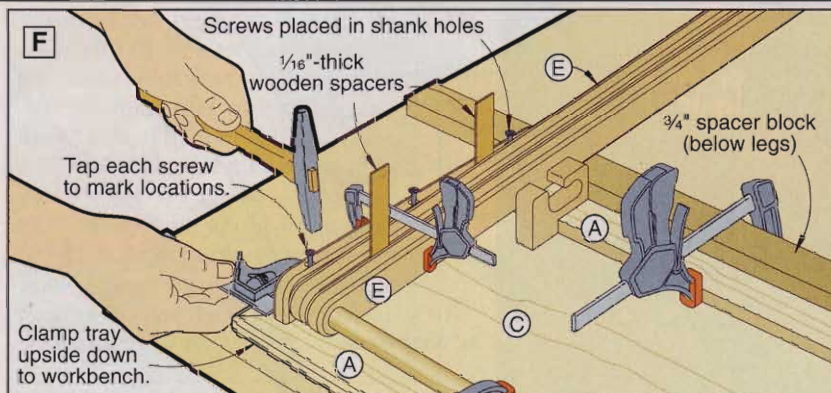

Continued

Tray Tables

The final touch— a matching stand for storage

1 Start by cutting the uprights (I), feet (J), arms (K), handle (L), and stretcher (M) to size. (See the Tray Stand Exploded View.)

2 Install a $\frac{3}{4}$ " dado blade in your tablesaw, and cut half-lap notches in the feet, arms, and uprights (Illustration G).

3 Reset or restack the dado blade to $\frac{1}{2}$ "; then cut the shallow grooves for the inlay in the handle and stretcher. Glue the four remaining inlay strips into the grooves; then let the adhesive dry and mill them flush as before.

4 Trace the contour patterns onto the feet (J) and the handle (L); then cut and sand them to shape.

5 Cut the radius on the top ends of the uprights (I) as shown in the Parts View, and drill the counterbored screw holes for attaching the handle and stretcher. Cut $\frac{3}{8}$ "-diameter plugs for the counterbores (from the waste left from cutting part D).

6 Drill four $\frac{7}{8}$ "-diameter holes in each arm (K), where shown on the pattern, to locate the notches where the tables' edges will rest. Bandsaw the notches open and round the corners slightly with a drum sander. Then cut and sand the ends round on each arm.

7 Glue up the half-lap joints that connect the feet and arms to each upright. Sand the joints smooth, and rout a $\frac{1}{4}$ " round-over along the edges. Also round-over parts L and M.

8 Connect these two upright assemblies by gluing and screwing them to the ends of the handle and stretcher. Glue plugs in the counterbores and sand them flush; then finish-sand the entire assembly.

The finishing touch

Again, for this project we recommend a durable finish such as polyurethane. On the tray tables apply an extra coat for best protection. 🌲

Written by Bill LaHay
Project Design: James R. Downing
Illustrations: Kim Downing; Lorna Johnson
Photograph: Hetherington Photography

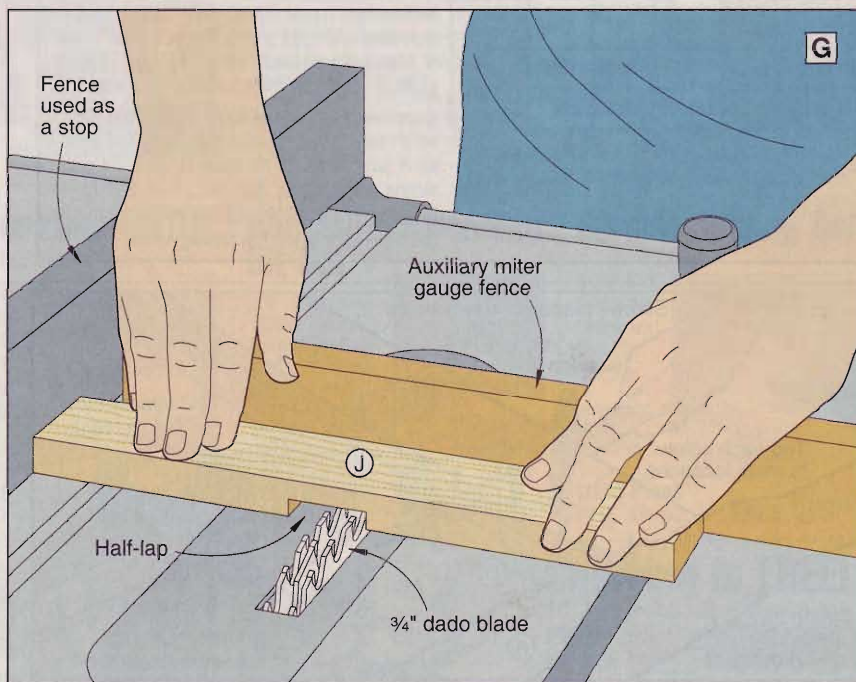
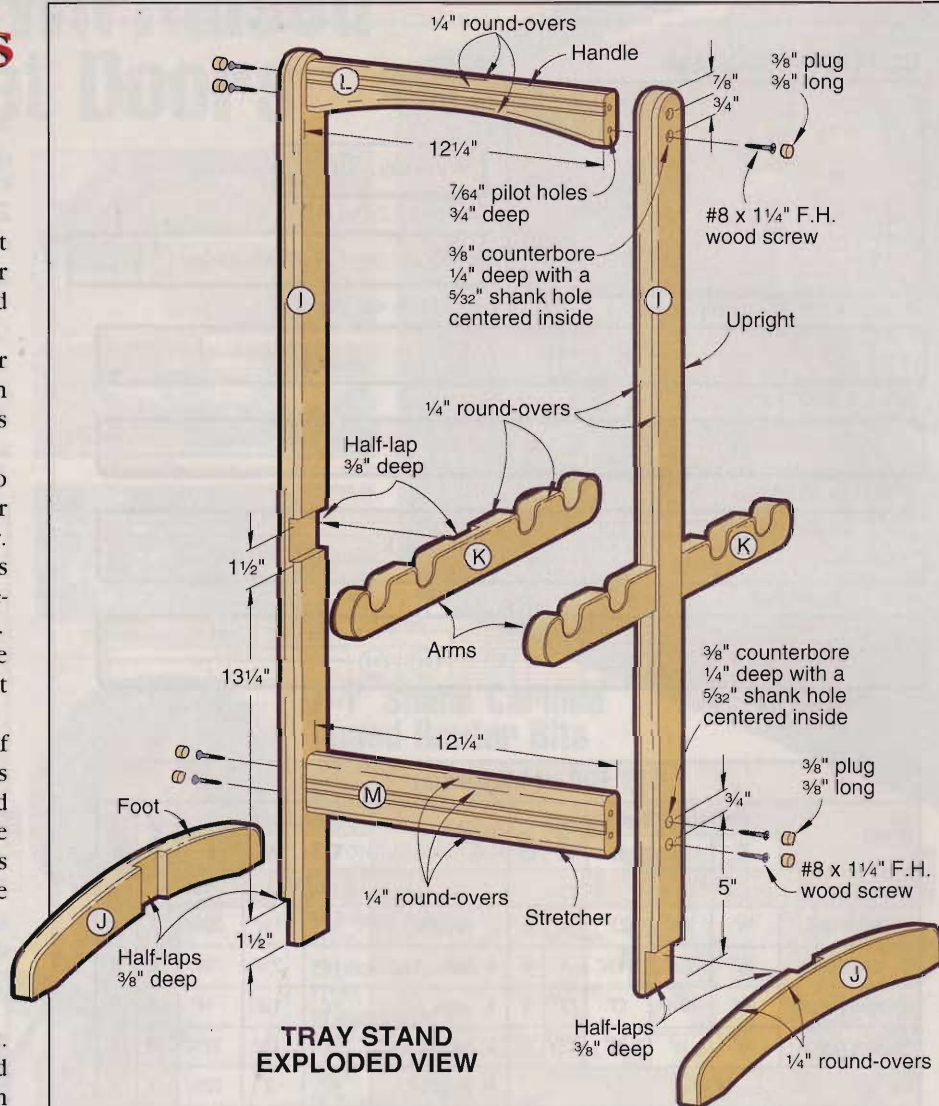

PARTS VIEW

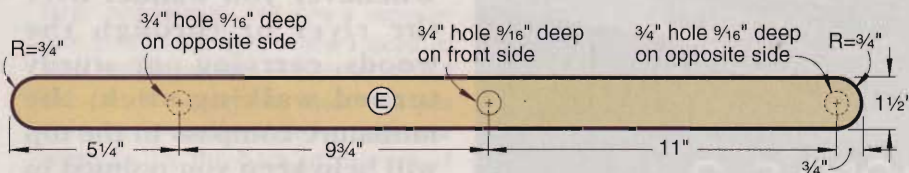

BACK LEG

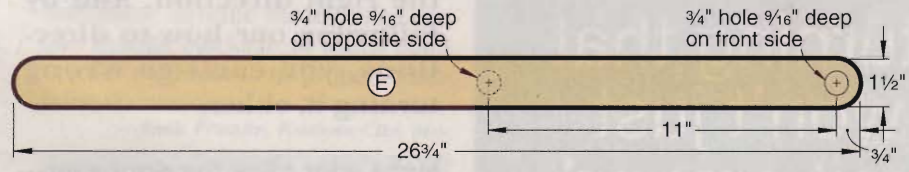

FRONT LEG

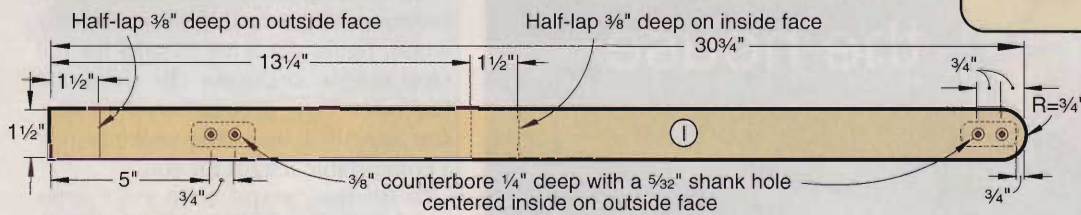

STAND UPRIGHT

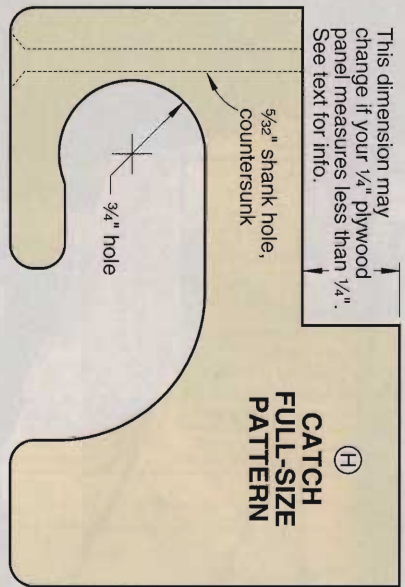

CATCH FULL-SIZE PATTERN

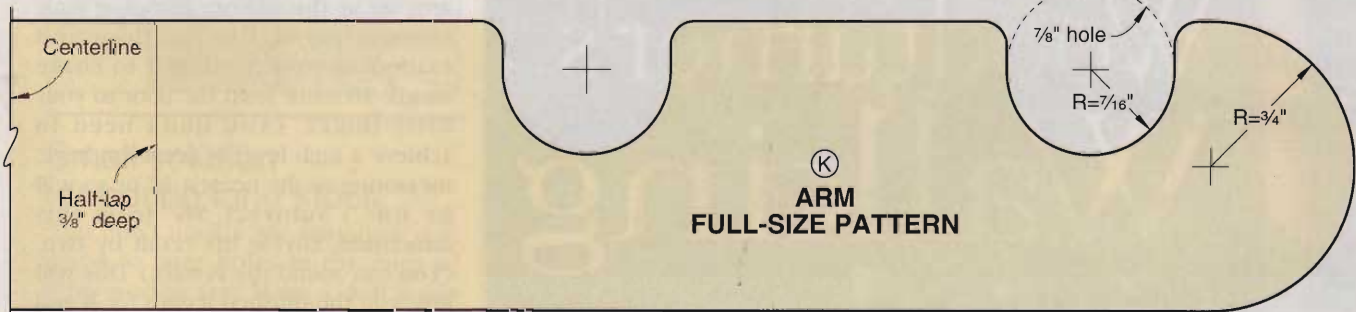

ARM FULL-SIZE PATTERN

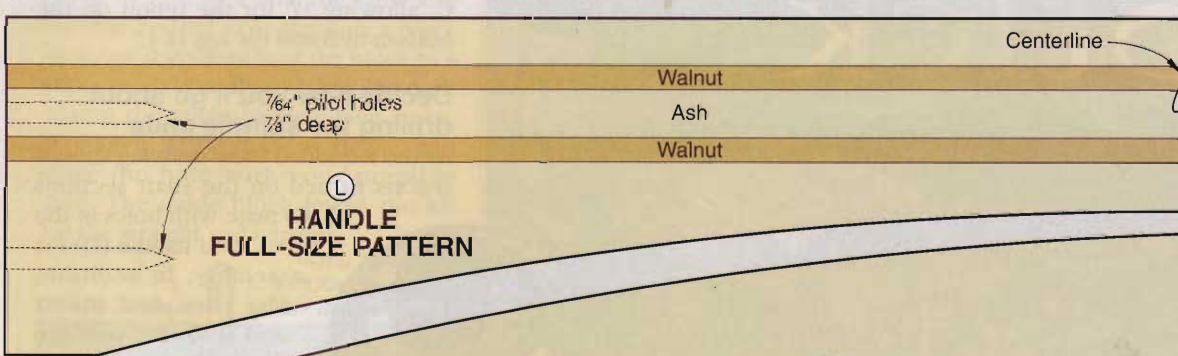

HANDLE FULL-SIZE PATTERN



FOOT FULL-SIZE PATTERN

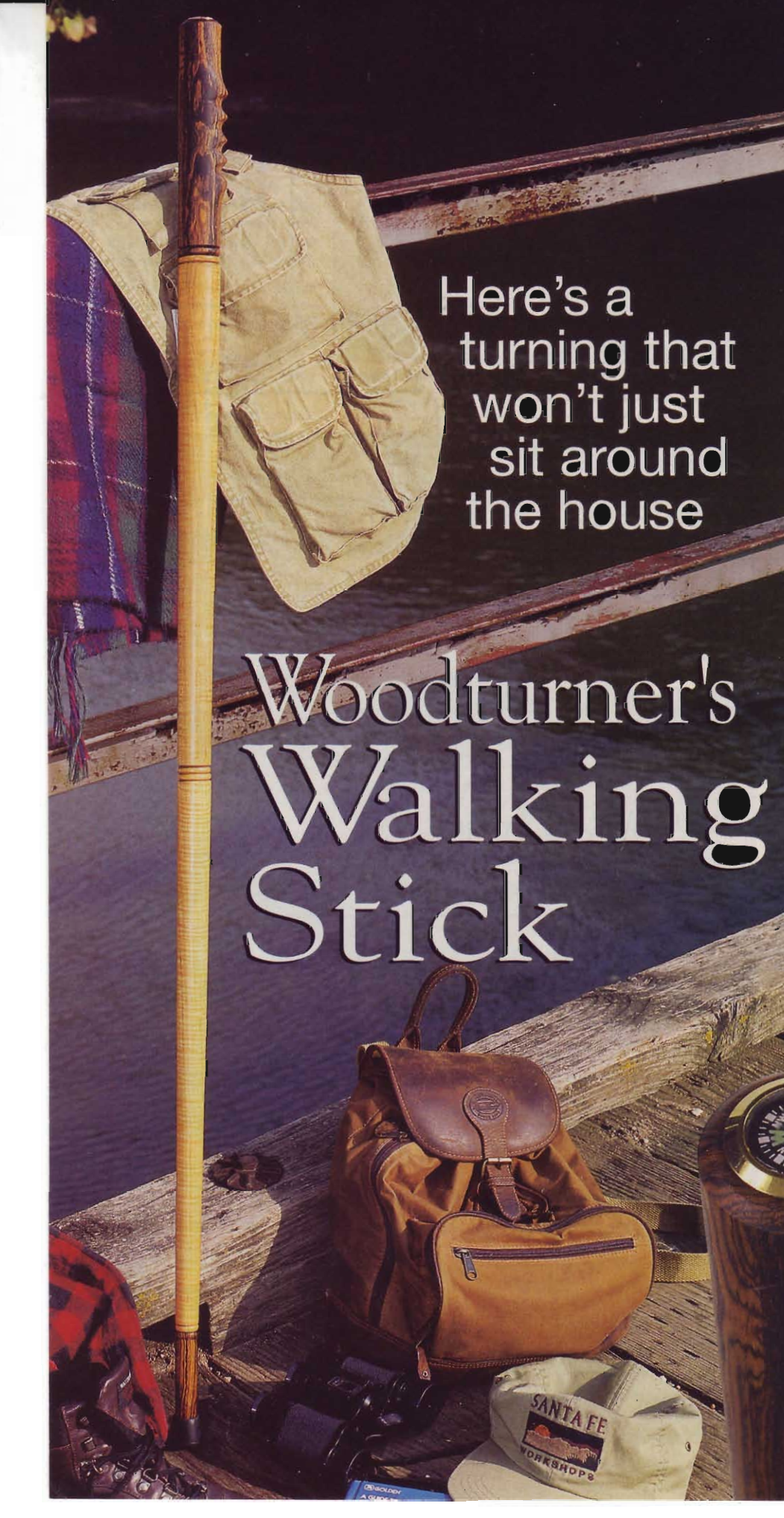

Here's a
turning that
won't just
sit around
the house

Woodturner's Walking Stick

Whenever you wander over the river or through the woods, carrying our sturdy turned walking stick, the miniature compass in the top will help keep you pointed in the right direction. And by following our how-to directions, you can't go wrong turning it, either.

Make your stick the right size

With walking sticks, size matters. So, before you start cutting or turning any wood, figure out what lengths for the two maple sections (B, C in the Exploded View drawing on the *opposite page*) will make the walking stick a comfortable length for you.

To do this, stand with your arms hanging down and bend your right arm up at the elbow, bringing your forearm parallel to the floor and extending your hand as if to shake hands. Measure from the floor to your little finger. (You don't need to achieve a high level of precision here; measuring to the nearest $\frac{1}{2}$ " or so will be fine.) Subtract $5\frac{3}{4}$ " from this dimension. Divide the result by two. (You can round the results.) This will give you the finished length for B and C, allowing $\frac{1}{2}$ " for the tenon on the bottom of B and the top of C.

Decide how you'll go about drilling the spindle ends

As the Exploded View drawing shows, tenons turned on the shaft sections (B, C) mate with holes in the tip (A) and handle (D) for assembly. In addition, the threaded insert and stud that join the shaft sections (B, C) install into holes.

You can drill these four holes on the lathe, in conjunction with turning the parts. To do the drilling on the lathe, you'll need a Jacobs-type drill chuck mounted on

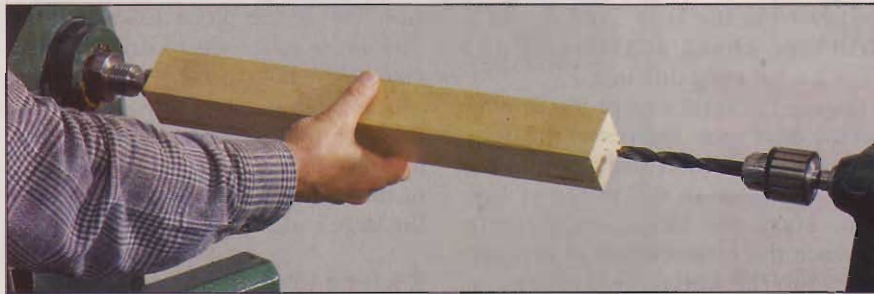

The shaft sections may prove too long to drill on some lathes. Set up the lathe to check before starting.

a Morse-taper arbor (shown at the *bottom of the page*) to fit your lathe's tailstock. (Chucks with arbors in Morse taper 1, 2, or 3 are available from tool dealers, including Craft Supplies USA, 800/551-8876.)

Also, your lathe bed must be long enough. To check this, install the arbor, drill chuck, and twist drill in the tailstock. Then make sure you can put a shaft blank (B or C) between the drive center and the tip of the drill. (See the photo *above*.)

If you can't drill the parts on the lathe, drill them with a drill press either before or after turning. Because it's easier to grip a square piece and align it for drilling, we lean toward drilling before turning. This also ensures an accurately centered hole because the lathe center fits into the drilled hole, centering the turning around it.

To mount a drilled blank between centers, engage the hole over a live cone center in the tailstock. In the case of parts A and B, this means you won't be able to orient the blank initially as described in instructions. The only difference this will make, however, will be to place the larger diameter of the taper at the tailstock rather than the headstock to start.



An ordinary 1/2" drill chuck mounted on an inexpensive arbor allows you to drill holes in turnings on the lathe.

Get your wood ready to turn

The walking stick requires four blanks. They are:

- Tip (A), Bocote, 1×1×4".
- Lower shaft (B) and upper shaft (C), Maple, 2×2", length determined in *Make your stick the right size*.
- Handle (D), Bocote, 1½×1¾×8".

For best appearance, the grain and color of sections B and C should appear continuous when the parts are assembled, so choose these blanks carefully. You can substitute other woods for a different appearance.

If you've decided to drill the blanks before turning, drill the holes in the blanks for parts A, B, and C now. (We'll deal with the holes in part D later.) Refer to the Exploded View drawing for hole sizes and placement.

Here's a tip on where to start

Begin turning with the tip (part A). To get started, install a spur-type drive center in your lathe's headstock and a live center in the tailstock. A small-diameter drive spur will come in handy when turning the tip, which is smaller than 1" diameter at both ends.

Mark centers on both ends of the short Bocote blank, and mount it on the lathe. Place the end that will be the bottom toward the tailstock, unless you drilled the blank first.

Round the blank to about 1" diameter, using a roughing gouge or large spindle gouge. Taper the piece from 7/8" diameter to 3/4" diameter over its whole length. A 3/4" or 1" skew does a good job on this cut. Check the side with a straightedge to ensure a straight taper. Block-sand the part with 120- and 150-grit sandpaper. Finish-sand to 220-grit.

Continued

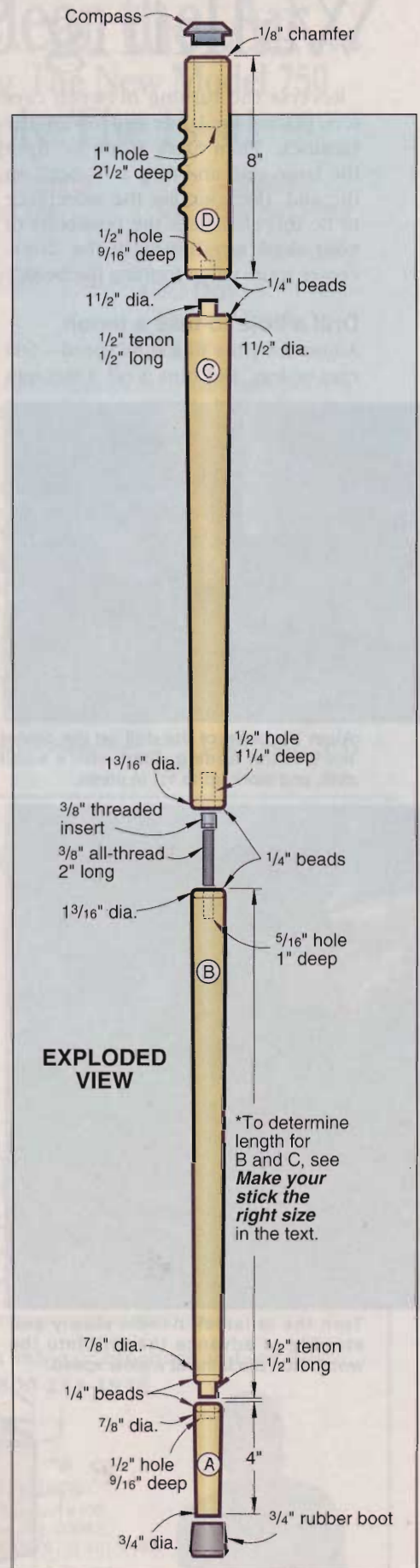

Walking Stick

Reverse the turning between centers, placing the larger end toward the tailstock. Then mark a line $\frac{1}{4}$ " from the large end, and turn a $\frac{1}{4}$ " bead on the end. (Remounting the workpiece to do this eliminates the possibility of your skew tangling with the drive-center spurs when forming the bead.)

Drill a hole to take a tenon

Adjust the lathe to a slow speed—500 rpm or less, and turn it off. Dismount



Align the point of the drill on the center mark in the turning. Start with a small drill, and work up to $\frac{1}{2}$ " in steps.



Turn the tailstock handle slowly and steadily to advance the drill into the wood. Run the lathe at a slow speed.

the workpiece. Remove the tailstock center from the lathe, and install a drill-type chuck at the tailstock. Chuck a $\frac{3}{16}$ " twist drill in it.

Engage the small end of the turning on the drive spur, and center the twist drill over the center mark on the big end, as shown in the photo at *left, top*. Start the lathe, and slowly advance the tailstock ram to drill $\frac{3}{16}$ " deep into the workpiece, as shown in the photo at *left, bottom*. Retract the drill, and shut off the lathe. Chuck in a larger twist drill, and following the same procedure, enlarge the hole. Enlarge it to $\frac{1}{2}$ " in steps.

Head right for the middle

Turn the two shaft sections (B, C) next. Mount the blank for section B between centers, placing the end that will make the middle joint at the headstock (unless you're mounting a pre-drilled blank).

Round down the blank to $1\frac{1}{4}$ " diameter. Draw a line around the cylinder $\frac{1}{2}$ " from the end that will have the tenon. (See the Exploded View drawing.) With the parting tool, cut straight in to 1" diameter just below the line. Then turn a taper from the top down to the parting cut. Check the long taper for straightness.

Form a $\frac{1}{2}$ "-long tenon a little larger than $\frac{1}{2}$ " in diameter at the small end of the turning. Gauge the diameter at the top of the tip (A) with an outside caliper. Then, with a skew, finish-turn the workpiece from $1\frac{3}{16}$ " diameter at the top to the caliper diameter at the end above the tenon.

Form a $\frac{1}{4}$ " bead at each end of the shaft. Finish-sand the turning.

Drill a $\frac{3}{16}$ " pilot hole 1" deep in the large end of the piece, following the procedure you used to drill the tip. Enlarge the hole to $\frac{5}{16}$ ".

Referring to the Exploded View drawing, follow the same procedures to turn section C. Size the small end of this part to match the diameter of the large end of part B.

It's time to get a handle on this

Mark the offset turning centers on the handle blank (D), where shown on the Handle Blank Layout drawing. Draw the seven lines around it.

Bore a 1" hole $2\frac{1}{2}$ " deep at the end that will be the top of the handle and a $\frac{1}{2}$ " hole $\frac{5}{16}$ " deep at the other. (The compass plugs the large hole, in which you can store matches and the like.) Drill at the turning centers. (We did the job on a drill press, using a Forstner bit for the 1" hole.)

To mount the drilled workpiece on the lathe, turn an insert for the large hole, shown in the Handle Center Insert drawing. Turning the insert between centers from a $1\frac{1}{2}$ " dowel provides an accurate center point for mounting the handle blank.

Mount the handle blank between centers, with the insert at the headstock end. Turn the ends of the blank—the portions outside the lines—to $1\frac{1}{2}$ " diameter. Taper the cut to about the midpoint of the space between the first two lines from each end, as shown in the photo at *top, left* on the *opposite page*.

Round down the central portion of the handle to the offset face. (The diameter will be about 2".) Redraw the five middle guidelines.

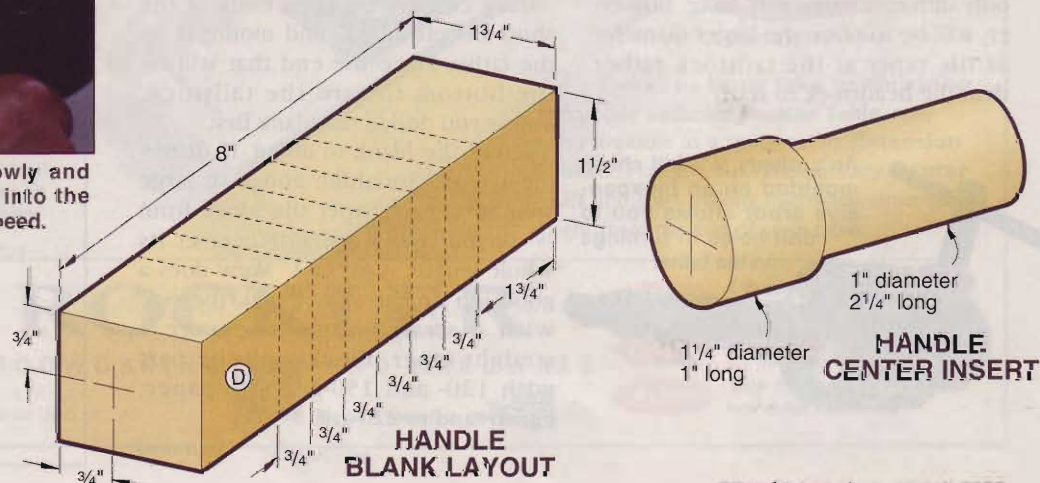



The centers are offset on the handle blank, so the piece will be slightly off-balance as you turn the ends round.

You've finally reached the gripping part of this project

Form four grooves for the handle grip. Shape the grooves with a $\frac{1}{2}$ " gouge, starting midway between each pair of lines. Make the grooves about $\frac{5}{8}$ " wide at the top and $\frac{1}{4}$ " deep or less. (Refer to the Handle Full-Size Pattern for the general form.) Don't cut the grooves into the sides or back of the workpiece.

By the time you reach this point, the handle should look approximately like the one in the photo *above right*. (We turned the mahogany piece shown to practice the procedures.)

Now, shape the back and sides of the center portion to match the handle's ends, using a rasp or block plane. At the same time, shape the finger grips to the profile shown in the Handle Cross Section View A-A drawing. Blend the contours and round the edges of the grips to make the handle smooth and comfortable to hold on to.

With the handle shaped, turn a chamfer around the top, bringing it to within $\frac{1}{16}$ " of the handle center insert. Sand the handle with 100- or 120-grit sandpaper to smooth all the contours. Then, finish-sand it. Finally, form a $\frac{1}{4}$ " bead around the bottom.

Now you can stick it all together

Epoxy-gluе a 2" length of $\frac{3}{8}$ " threaded brass rod (or a cut-off brass machine screw) into the hole in the lower shaft section (B). Press a $\frac{3}{8}$ " threaded insert into the hole in the upper shaft section (C). Coat the insert with epoxy glue as you install it. Take care



After turning the handle to roughly this shape, complete it by hand. A rasp, plane, and sanders will come in handy.

to get the threaded parts in straight so the shaft sections will join properly. Epoxy-gluе the tip and handle to the tenons on the shaft sections.

Apply a clear finish. (The walking stick shown is finished with Danish oil and a coat of paste wax.) Slide a rubber crutch tip onto the end, and insert the compass into the handle. ♣

Walking stick designed and turned by Ray Wilber
Photographs: Hetherington Photography
Illustrations: Roxanne LeMoine; Lorna Johnson

Buying Guide

Compass. Miniature compass, about $\frac{1}{4}$ " diameter, fits in 1" hole. Item no. 200CP, \$10.90 including shipping in U.S. Schlabaugh and Sons Woodworking, 720 14th St., Kalona, IA 52247. Call 800/346-9663 to order.

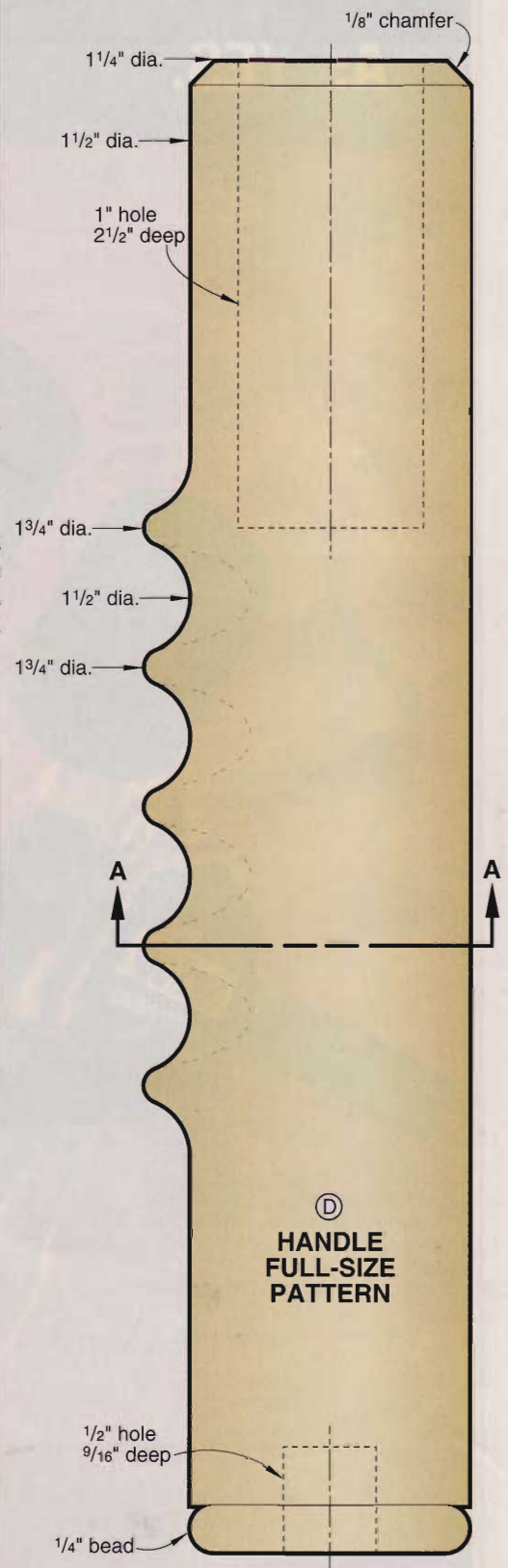
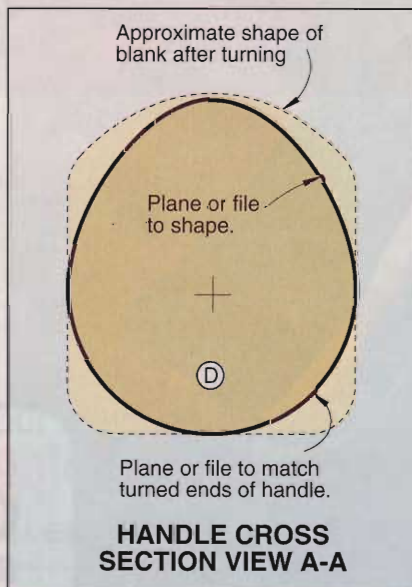

Panel Pro puts panel-saw safety within wallet's reach

Manhandling a sheet of 3/4" plywood or medium-density fiberboard is gut-busting work, especially when trying to position it on a tablesaw for ripping or crosscutting. And, unless you have adequate side and outfeed tables, the job can be downright dangerous. The Panel Pro panel saw makes breaking down sheet goods both safe and affordable.

Like big panel-cutting rigs that cost twice as much, the Panel Pro guides a built-in 7 1/4" circular saw on a pair of parallel rails for crosscutting large sheets, as shown at right. Align the cutline with the blade and pull the saw through the sheet. A recoil cable

attached to the saw helps return it to the top after the cut, but I found the spring to be a tad stiff, requiring a bit of effort to pull through the cut.

For ripping, the saw rotates 90° in its carriage (a spring-loaded pin snaps it precisely into place), and a knob locks the carriage at ripping height. Then you push the sheet through the saw.

Unfortunately, the Panel Pro's bottom support track extends only about 30" on either side of the blade, so a 4x8' sheet requires additional support during the first and last 2' of the cut. The short track also limits the crosscut length to about 5' without extra support. That said, this compact unit takes up less than 12 square feet of floor space when folded against the wall—a big plus for the small shop.

Mechanically, this saw is top notch, accurate to within 1/32" crosscutting and 1/8" ripping. I experienced a fair amount of tearout crosscutting oak-veneer plywood, even after replacing the stan-



ard-equipment ripping blade with a high-quality finishing blade. I countered that by cutting slightly oversized pieces and making a clean finishing cut on my tablesaw.

—Tested by Bob McFarlin

Continued from page 112

PRODUCT SCORECARD

Panel Pro

Performance ★ ★ ★ ☆ ☆

Price \$699, \$39 for optional wheels

Value ★ ★ ★ ☆ ☆

Call 800/599-1655, or, on the Internet, visit www.panelpro.org.

Buy Our Best Seller

10" x 40T only \$107
or \$95 on 2nd blade

EXTRA BONUS! 9 AT \$5 EACH!

Buy a blade or dado and get \$45 worth of sharpening discount coupons from Forrest, good on any make blade or dado set you own. The first 100 customers will receive a FREE Picnic Table Plan and Router poster!

THE ONE BLADE THAT LEAVES A SMOOTH-AS-SANDED SURFACE



Outperformed 36 other premium blades, both foreign and domestic, WOOD magazine test, Sept. 1998, pg. 45.

DURALINE HI A/T

7 1/4" to 16" diameter available
Cuts melamine PERFECTLY. 220 mm & 300 mm available. Our best PLYWOOD blade. 8", 7 1/4" & others available.

	Sale Price		10% Off 1st Blade		20% Off 2nd Blade	
	1st	2nd	1st	2nd	1st	2nd
10" x 80 T (7/8" or 3/32" K)	\$185	\$143	\$163	\$127		
12" x 80 T (7/8" or 1" hole, 7/8" K)	161	127	143	109		
14" x 80 T (1" hole)	187	143	163	127		
14" x 100 T (1" hole)	326	243	292	210		
16" x 100 T (1" hole)	443	327	399	292		

BUY ONE & SAVE - BUY MORE & SAVE MORE

Buy any sawblade or dado in this ad and save 10% off the sale prices. Buy additional sawblade(s) or dado(s) and save even more—15% to 20%! Sale good through June 30, 2000.

WOODWORKER II

5 1/2" to 14" diameter available

All-purpose—tablesaws and portable circular saws.

Special 10% Discount! Take 20% off second blade of your choice.

EDITOR'S CHOICE AND TOP RATING OVER 18 COMPETING SAW BLADES.

The 10" x 40T earned the Editor's Choice Award for the best performance regardless of the price. See American Woodworker magazine, April 1998, pp. 68-69.

	Sale Price	10% Off 1st Blade	20% Off 2nd Blade
14" x 40 T x 1"	\$148	\$134	\$119
14" x 30 T x 1"	128	125	111
12" x 40 T x 1"	128	116	103
12" x 30 T x 1"	118	107	95
10" x 40 T x 7/8" or 1/2"	118	107	95
10" x 30 T x 7/8" or 1/2"	98	89	79
9" x 40 T	108	98	87
9" x 30 T	98	89	79
8 1/4" x 40 T x 7/32"	98	89	79
8" x 40 T x 7/32"	98	89	79
8" x 30 T x 7/32"	88	80	71
7 1/4" x 30 T x 7/32"	68	62	55
**6" x 40 T x 7/32"	88	80	71
***5 1/2" x 40 T x 10mm	88	80	71

NEW for *Sears & Makita Table Saws **Saw Boss ***Dewalt Cordless

BLADE STIFFENER

Make all your blades cut better and quieter with a blade stiffener!

- 4" ...\$21
- 5" ...\$24
- 6" ...\$25

CHOPMASTER BLADE

6 1/2" to 15" diameter available

Specially designed for sliding compound miter, miter-chop, and radial saws.

Sale 10% Off 20% Off Price 1st Blade 2nd Blade

6 1/2" x 40 T	98	89	79
Delta, Sidekick, & Others	108	98	87
8 1/4" x 60 T	118	107	95
Sears, Delta, Ryobi	118	107	95
8 1/2" x 60 T	128	116	103
Hitachi, Dewalt, Ryobi, FreudTR125	128	116	103
9" x 80 T	128	116	103
Delta & Others	128	116	103
10" x 80 T	138	125	111
Delta, Bosch, Mitachi, Makita, Ryobi, AEG, & All	138	125	111
12" x 80 T	148	134	119
Dewalt, Hitachi, Makita, B+D, Sears, & All	148	134	119
14" x 100 T	188	170	151
Makita, Ryobi	188	170	151
15" x 100 T	198	179	159
Hitachi, Ryobi	198	179	159

WOODWORKER I

7 1/4" to 14" diameter available

Designed for radial arm or tablesaws—fine crosscut.

Sale 10% Off 15% Off Price 1st Blade 2nd Blade

8", 8 1/4", 7 1/4" x 60 T	108	98	87
10" x 60 T (7/8" hole)	128	116	103
12" x 60 T (7/8" or 1")	168	125	111

CANADA SALES: CMR RON COLLIER
3644 SCHUMANN RD., BAY CITY, MI 48706
Phone 800-229-4814, FAX 517-684-0402

FREE SHIPPING

on orders over \$275 from 3-01-00 to 6-30-00

All Major Credit Cards Accepted
FL, NJ, NY Residents - Please add Sales Tax
YOUR SATISFACTION GUARANTEED!

EXCLUSIVE OFFER

Peels Plus 16 oz. can may be purchased separately \$7.95 ea + \$6.50 SH



Choose one of these items FREE when placing an order for any saw blade or dado purchase from this ad in Wood magazine. Choose from the eight book titles shown, imprinted cap, or 16 oz. can of spray blade cleaner. Hurry! This special offer is limited while supplies last on orders placed by June 30, 2000.

FORREST DADO-KING

Unmatched Precision on Every Dado Cut! The Forrest Dado-King gives you flat-bottomed grooves and no splintering—even when crosscutting oak plys and melamine. This award-winning set comes with six 4-tooth chippers (including 3/32" chipper), two 24-tooth outside blades plus shims. Cuts 1/8" to 29/32" grooves.

	Sale Price	10% Off 1st Blade	15% Off 2nd Blade
6" Set	\$268	\$242	\$228
8" Set	289	260	245
10" Set	349	314	297
12" Set	449	404	382

FREE CARRYING CASE

10" Blade Runner Case \$18. 8" Set 10" Dado Set \$15. 6" Set 10" Dado Set \$15.

"EASY-FEED" STANDARD DADO

For solid hard and soft woods only! (Not plastic or melamine) 8" D. with positive back 24 tooth blades & 2 tooth chippers and chips. Case 1/2" to 7/8" wide.
LIST SALE 10% 15%
\$249 \$218 \$196 \$185

2-4 DAYS SHARPENING

ON ALL MAKES OF CARBIDE BLADES, ROUTERS, CUTTERS, PLANERS, & JOINTER KNIVES



FORREST MANUFACTURING COMPANY, INC. DEALER INQUIRIES WELCOME

ORDER BY MAIL: 457 River Road, Clifton, NJ 07014 • BY PHONE: 800/733-7111 (IN NJ: 973/473-5236) • BY FAX: 973/471-3331
SEE OUR INTERNET STORE AT woodmall.com OR stores.yahoo.com/forrestman

NO MORE DUST

Introducing Microplane® Rotary Shaper Power Tool Attachments for low-speed shaping. The razor-sharp teeth create tiny shavings that fall to the surface instead of clouding your air.

Call 501-968-5455 or

1-800-555-2767

* dealer inquiries encouraged

www.microplane.com

email: info@microplane.com

Microplane
A Product of Grace Manufacturing®

Circle No. 2145

ZAR® Wood Stain is made using only the finest ingredients. ZAR's unique formula puts extra pigment into a rich base so ZAR wipes on easily and covers evenly. And with ZAR's controlled



penetration you can work at your own pace without fear of those disappointing streaks or lap marks. ZAR. The best thing that ever happened to wood.

If you want the richest finish, start with the best ingredients.

For a free brochure and the name of your nearest dealer, call 1-800-272-3235, or visit us at www.ugl.com

UGL

Circle No. 290

PRODUCTS THAT PERFORM

Continued from page 111

Ratcheting spring clamps rrrrrrip and grip

It wasn't exactly love at first sight. My first thought when I saw Craftsman's Ratchet Clamp was more like, "Ugh, another plastic clamp." To my surprise, these well-engineered accessories tackled every single job I threw at them.

Normal spring clamps can require a fair amount of hand strength—and reach—to use. And, once in place, they're still pretty easy to knock out of kilter. The Ratchet Clamps, on the other hand, are normally open. Squeezing the handles together makes a rrrrip! sound thanks to a metal ratchet rack and multiple-tooth pawl in the handle.

Because the Ratchet Clamp locks wherever you stop squeezing, you can increase the clamping pressure one click at a time to make it just right for the job at hand. To remove the clamp, pull the trigger, and the jaws spring open to their full 2¼" capacity.

The generous no-mar clamping pads provide plenty of surface area for clamping. I used the Ratchet Clamps all around the shop: affixing a stop block to my miter-gauge fence, clamping a drill-press jig to the table, and holding a cabinet-drilling template in place. I even used them to pinch off a hose in my pickup when changing out the heater core, and they held firmly in every case. ♣

—Tested by Dave Henderson



PRODUCT SCORECARD

Craftsman Ratchet Clamps #31591

Performance	★ ★ ★ ★ ★
Price	\$19.99 for two clamps
Value	★ ★ ★ ★ ☆

Available at Sears.

One Huge Hauler See related article on page 72

BOX PARTS VIEW



INTRODUCING... KATANA™

The Cutting Edge Of Routing Technology

Safety, performance, and durability. NEW Katana™ router bits are manufactured using the highest quality materials on precision multi-axis CNC grinders. They feature: premium micro-grain carbide cutters, high hook and shear angles for clean cutting, anti-kick-back rounded shoulders, an anti-stick coating, a diamond honed 600 grit mirror finish, SAE 4140 solid steel bodies, plus our Safety Gauge Shank™ for easy set up. Katana™ brand bits come with a **lifetime guarantee**, backed by the MLCS reputation for customer service and product support.



FREE CATALOG!
1-800-533-9298



KATANA™ An MLCS Company
2381 Philmont Ave., Huntingdon Valley, PA 19006

3 PC. ROUND OVER
BEADING BIT SET

\$65 Order Set #12305

WOOD BOX INCLUDED

Circle No. 1350

Econ-Abrasives

WE MAKE ABRASIVE BELTS ANY SIZE, ANY GRIT!

Standard Abrasive Sheets

CABINET PAPER

	50/pk	100/pk
60D	\$16.70	\$30.00C
80D	15.60	27.80C
100 thru 150C	14.50	25.60C

FINISHING PAPER

	\$ 11.15	\$18.90C
80A		
100 thru 280A	10.00	16.70C

NO LOAD PAPER(white)

100 thru 400A	\$12.25	\$21.25C
---------------	---------	----------

"C" = 100 SHEETS

Velcro® Vacuum Discs

8 Hole pattern for Bosch sanders

Dia.	Grit	Price
5"	60	\$.48 ea
5"	80	.46
5"	100 thru 320	.45

* Available in 5 hole pattern *

- *Wide Belts*Rolls*Flap Wheels
- *Pump Sleeves*PSA Discs
- *Router & Wood Bits*Wood Glue

- *MasterCard, VISA, C.O.D. or Check
- *SATISFACTION GUARANTEED!!!
- *CALL FOR FREE CATALOG
- TX & NV add appropriate sales tax
- Continental U. S. shipping add \$5.50

ABRASIVE BELTS

Belts are resin bond cloth with a bi-directional splice, specify grits.

1X30	\$.81 ea	3X24	\$.93 ea
1X42	.81 ea	3X27	.96 ea
1X44	.81 ea	4X21 3/4	1.06 ea
2 1/2X16	.85 ea	4X24	1.10 ea
3X18	.86 ea	4X36	1.35 ea
3X21	.90 ea	6X48	3.50 ea
3X23 3/4	.93 ea	6x89	6.24 ea

OTHER SIZES ON REQUEST

HEAVY DUTY SPRING CLAMPS

Clamps come w/PVC tips and grips.

Size	Price
4"	\$1.75 ea
6"	2.25
8"	3.50

JUMBO ROUTER PAD(24" x 36")

It will not allow small blocks of wood to slip out under router or sanding applications.

ROUTER PAD
ONLY \$8.95ea.

JUMBO BELT CLEANING STICK
ONLY \$8.80

Econ-Abrasives

P. O. Box W1628
Frisco, TX 75034
(972)377-9779

TOLL-FREE ORDERING LINE (800)367-4101

Circle No. 1229

**Quality Pen Kits
and Other Turning Kits**



- Designers & Manufacturers
- Wholesale & Retail

THE BereaHardWoods CO. Inc.

Manufacturer of quality writing instruments, components and kits.

CALL FOR FREE CATALOG

6367 Eastland Rd. • Brookpark, Ohio 44142 U.S.A.
Ph: 440-234-7949 • Fax: 440-234-7958 • bereahard@aol.com

Circle No. 510

Buy Factory Direct and Save Thousands!

**Woodworkers
Dreamshop**

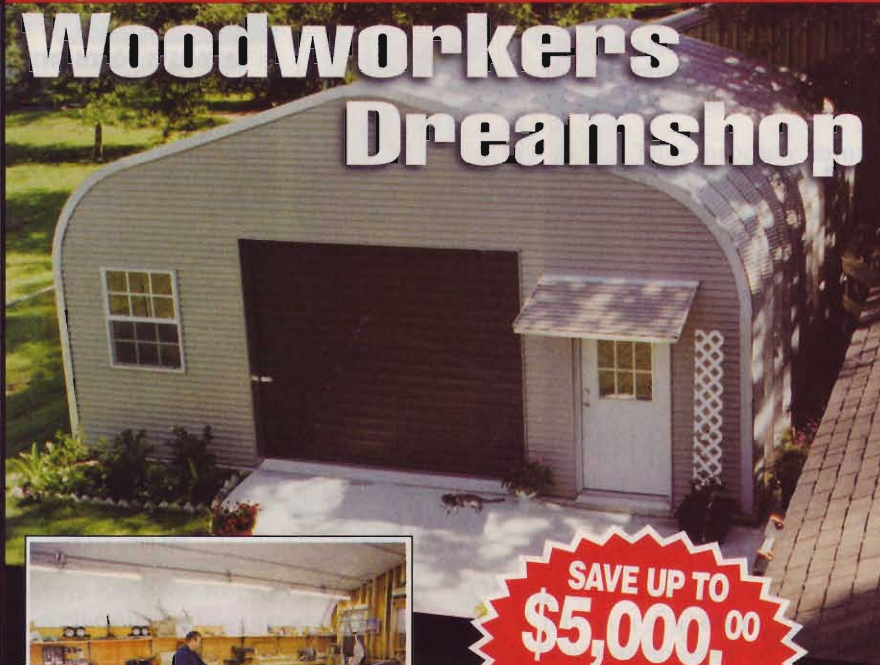

**SAVE UP TO
\$5,000.00
ON STEEL
BUILDINGS**

**SAVE THOUSANDS
ON SELECT SIZES**

25x34 • 30x46 • 40x56 • 50x116

Additional sizes available.
Proudly made in the USA.



- 20 Year Guarantee
- Build it yourself
- Maintenance Free
- 100% Useable Space

**CALL TODAY
1-800-463-6062**

**FREE PRODUCT CATALOG
AND FACTORY PRICE LIST**

www.us-buildings.com

Circle No. 2030

**Gas From
The Past**

Continued from page 69



ROUTER SETUP

Start routing with bottom of part (B) against this block.

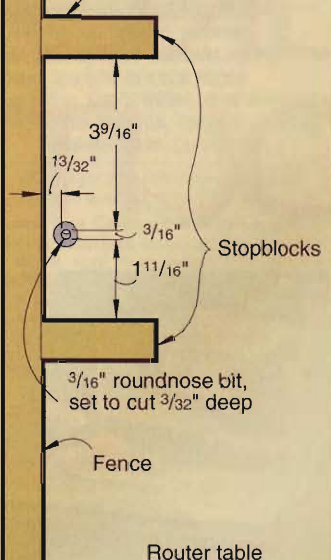

FULL-SIZE PATTERNS

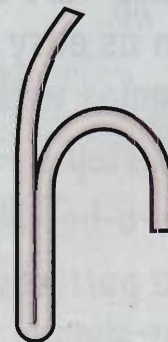

NOZZLE



CRANK

An intarsia project just for kids

When Randy Reynolds of Barnhart, Missouri, began his intarsia project in November, 1996, he thought it was an ambitious undertaking. One and one half years and 337 hours later, he knew it for sure.

Randy's 59¼x27" intarsia scene—now displayed in St. Louis Children's Hospital—has 1,005 pieces of wood in 19 different species for 34 Disney characters. The hardwood dowel pieces of varying lengths used for the background number about 1,000. "I used some stain to obtain certain col-

ors, but otherwise I tried to stick with natural wood tones," he notes. Each piece was sealed and finished with tung oil before it was glued in place.

Although Randy has never taken a woodworking class, he admits that his simple beginning work with wood lath pictures took an incredible turn when he discovered the designs of noted intarsia artist Judy Gale Roberts. (See "She paints with wood," issue #24 of *WOOD*® magazine.) "My worked changed and my shop grew after seeing her work," he says.



Missouri craftsman Randy Reynolds donated this intricately detailed intarsia piece to the St. Louis Children's Hospital. It measures 59¼x27".

Cutting on a cushion of air

Californians Chuck Pyle and Michael Leeds had a real problem: How to cut curves in massive, reclaimed western red cedar and Douglas fir beams for use in a custom home. Buying two heavy duty bandsaws—an LT24 and LT18 from Laguna Tools—was part of the answer. The other was to guide the saws through the timbers instead of the timbers through the saws.

The ingenious pair managed this by employing four small yet powerful reverse vacuums capable of lifting 1,800 pounds. Attached to a perforated metal plate slid under a platform built to support a single bandsaw, the reverse vacuums pushed air through at a rate that floated either machine on a ¼" air cushion. This enabled the operator to move the 725-pound LT24 or the

LT18 bandsaw through the huge beams with the nudge of a finger. Guided in this manner, the levitated bandsaw easily cut the necessary curves in the timbers, which averaged 10x28" and 16' long!



Chuck Pyle displays the four reverse vacuums used to levitate the Laguna Tools' LT24 bandsaw for cutting through timbers.



A real weeping birch

Leaves make food for a tree from the water absorbed by its roots. Only a small amount of water goes for food, though. The rest returns to the atmosphere through a process called transpiration. According to the National Arbor Day Foundation, a mature white birch tree with approximately 200,000 leaves may give off as much as 900 gallons of water throughout a summer day!



Floating on a cushion of air, the bandsaw easily maneuvers through a huge timber that will become a corbel in a custom California home.

customized **WOOD** flooring

create that
**SPECIAL
LOOK**
for your home

17 great ways to stage a 4-star floor show

HI 2 wood flooring 101

HI 10 add drama with medallions and inlays

HI 6 punch up a floor with pattern

HI 12 color a floor with paint

HI 8 take it to the edge with borders

HI 14 install a wood floor by the numbers

wood flooring 101

First, get a fix on the floor that's right for you

Nothing warms a room visually like the mellow tones and rich grain of a wood floor. Wood isn't just beautiful, either. It's durable, readily available, pleasant to touch as well as to see, and a good insulating material.

Best of all, the variety of wood floors available today means you're sure to find one that will work well with any home style and most budgets.

Strips, planks, parquet, and more

Several different types of wood flooring predominate; here's a rundown of those most frequently used.

■ **Strip flooring is the most common.** Random-length tongue-and-groove strips create a floor made up of matching boards, usually 2¼ inches wide. Strip floors are stunning in their simplicity and lend themselves to many special effects.

■ **Plank flooring is wider—up to 8 inches or more**—and offers country-style charm. For an even more rustic look, you can lay several different widths at random across a floor. Wider planks often are screwed to the subfloor; plugs cover the screw heads, simulating an old-fashioned pegged floor.

■ **Parquet flooring is made of small pieces of wood arranged in geometric patterns.** Do-it-yourself parquet tiles, typically 12-inch squares, can be installed for about the cost of medium-grade wall-to-wall carpet.

■ **Short strips—sometimes called “herringbone”** because that's one pattern you can create with them—consist of standard lengths that interlock to create a mosaic look. Lengths range from 9 to 36 inches.

What are your species options?

Oak, maple, and, in the case of planks, pine, are the most popular choices. Top-of-the-line flooring also comes in more exotic wood species, such as hickory, cherry, teak, basswood, and even bamboo, though you may need to special-order these. For design interest, you can alternate two or more different species.

To sand or not to sand?

If you want to trade sweat for money, buy unfinished flooring, install it, then sand and finish the raw wood with rental equipment available at most flooring outlets. Be warned, though, that sanding a floor creates a fearful mess, and if you don't do the job just right, you risk gouging your new floor.

As a halfway measure, you can install the

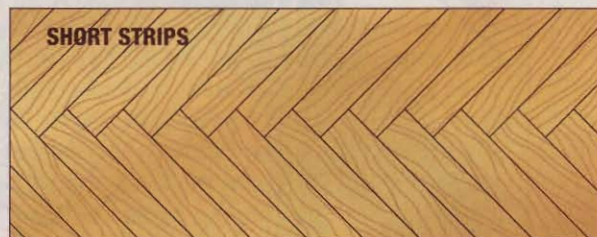
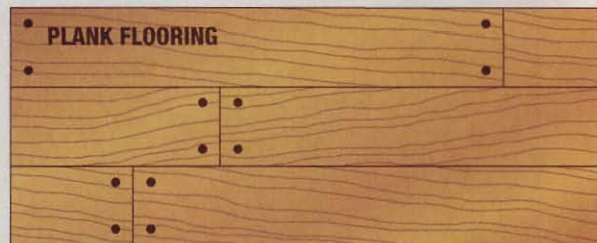

wood yourself, then hire a pro to do the sanding and finishing. This typically costs \$2.00 to \$2.50 a square foot, compared to \$7.50 to \$8.00 a square foot for materials, laying, sanding, and finishing a new floor.

With prefinished flooring materials, and there are lots of them out there (see page HI 4), you simply install the floor and move the furniture back in. You'll pay more up front for prefinished materials, but more than earn it back with savings in labor costs, especially if you do the work yourself.

continued

wood flooring 101

How much flooring will you need?





To draw up a materials list, compute the square footage of the room or rooms you plan to floor. (Don't forget to include closets and other out-of-the-way spots.) Add 5 percent for waste if you'll be laying materials directly across a room (10 percent for a diagonal installation), then round up to the next carton or bundle.

Also, calculate the linear footage of any moldings you'll need. Manufacturers offer

base, shoe, threshold, stair nosing, and other moldings that match their prefinished flooring. It's a good idea to take delivery of everything at once; colors can vary slightly from one dye lot to another.

When you get the materials home, unpack and loosely stack them in the room where they'll be used: Allow four or five days before you lay the floor. This gives the wood an opportunity to acclimate to the room's moisture level.

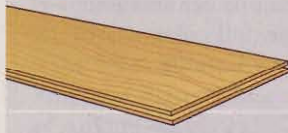
the low-down on flooring materials

MATERIAL	DESCRIPTION	ACCEPTABLE SUBFLOORS	INSTALLATION TIPS	COST
 <p>Unfinished solid wood</p>	100% solid hardwood	Plywood, wood, or particle-board. Not over concrete, below-grade, or in wet locations such as baths and entries.	Nails or staples. Not a difficult do-it-yourself project, but sanding and finishing are messy and tricky.	Materials: \$2.50–4.00/sq. ft. Installation: \$5.50–6.00/sq. ft.
 <p>Prefinished solid wood</p>	100% solid hardwood saturated with urethane or acrylic finish.	Plywood, wood or OSB. Not over concrete, below-grade, or in wet locations.	Nails or staples. Not a difficult DIY project. You don't have to sand or apply finish.	Materials: \$3.50–8.00/sq. ft. Installation: \$5.50–6.00/sq. ft.
 <p>Engineered wood</p>	Three to five layers of hardwood or laminate in cross-grain construction.	Most subfloors, including concrete, above- or below-grade, but not in wet locations.	Glue down, nail, or staple. An easy DIY project.	Materials: \$4.50–9.00/sq. ft. Installation: \$5.50–6.00/sq. ft.
 <p>Floating wood</p>	Multiple layers of hardwood installed over foam.	Most subfloors, including concrete, above- or below-grade, but not in wet locations.	Edge-glue (see <i>page 16</i>) or glue-down. Very easy DIY project.	Materials: \$4.50–9.00/sq. ft. Installation: \$5.50–6.00/sq. ft.
 <p>Laminate</p>	High-pressure laminate bonded to a high density fiberboard core.	Almost anywhere, including wet locations such as baths.	Glue-down or edge-glue. As easy as laying vinyl tile.	Materials: \$3.50–5.00/sq. ft. Installation: \$5.50–6.00/sq. ft.

punch up a floor with pattern

STEP 2

To ensure you'll end up with even margins, dry lay squares along two perpendicular chalk lines. If borders measure less than half the width of a square, shift the lines by half a square's width.



STEP 4

Next, we broke medium-tone squares in half and laid them around the center square.

STEP 5

Finally, we broke dark-tone squares into quarters and continued alternating light, medium, and dark tones to the room's walls.

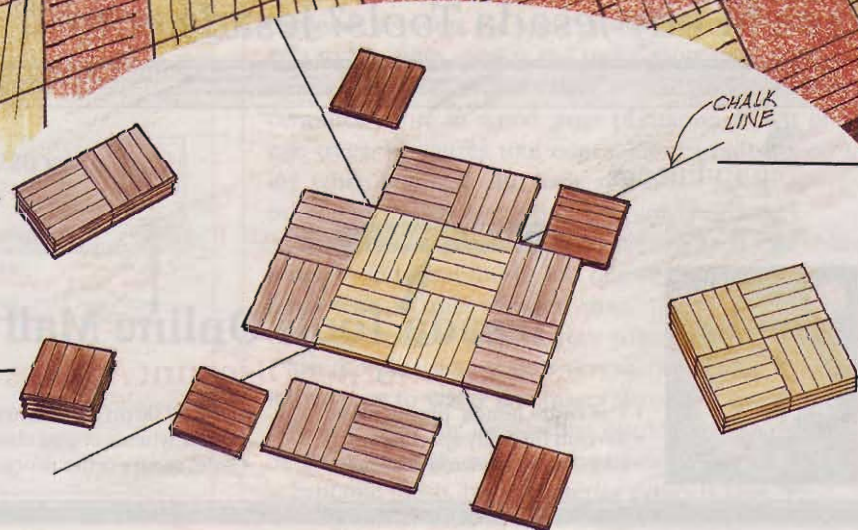



Modular squares of parquet automatically bring pattern to a wood floor—but here we've put a different spin on standard, monochromatic parquet by laying the squares at a 45-degree angle to the walls and alternating three different wood tones in three different groupings. The result is a

custom-crafted look that's surprisingly easy to achieve.

What's the trick? Parquet flooring typically comes in 1-foot squares, each consisting of four 6-inch squares. To divide the larger squares into smaller ones, just snap them apart and slice through the backing, if any, with a utility knife.

three more ways to pattern a floor



Alternating different lengths of short strips at right angles to each other creates a dynamic look. Shown here is Pattern-Plus® from Hartco®.



Not all parquet consists of gridded squares. This Marseille pattern from Historic Floors of Oshkosh seems to weave over and under, both square with the room and on the diagonal across it.



Yet another way to bring pattern to a wood floor is to mingle several different species of strip flooring. One of Bruce's International Coastal Woodlands™ Collection, this floating floor combines several exotic hardwoods.

STEP 1

Lay parquet from the center of the room outward. To find the center, locate the midpoints of opposite walls and snap chalk lines across the room. They should intersect at a 90-degree angle.

STEP 3

At the center, we started with a full, 12-inch light-toned square.

take it to the edge

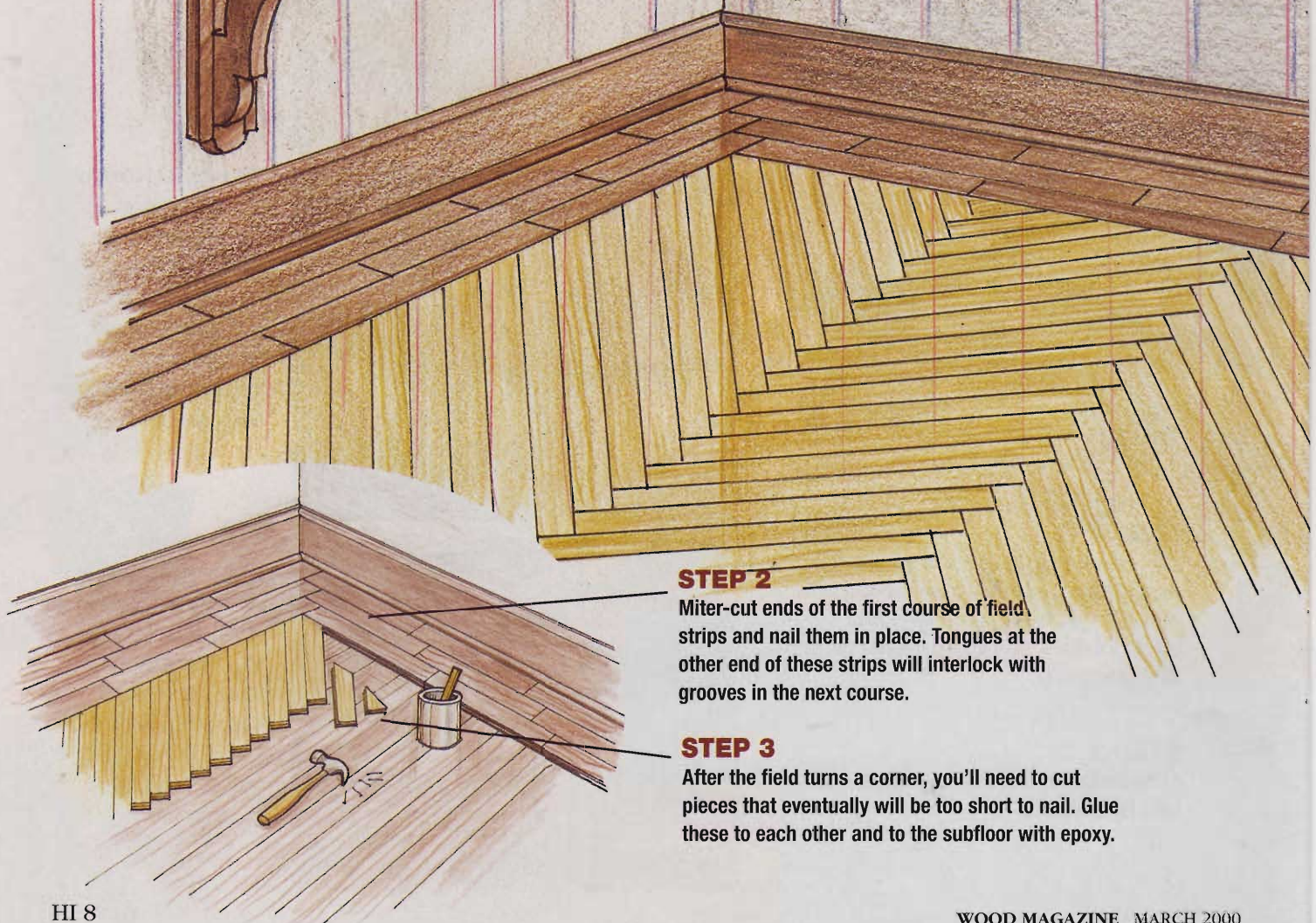
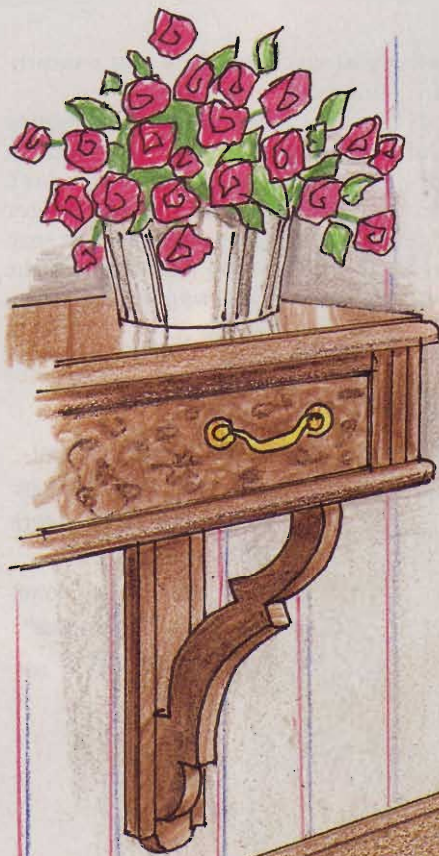

STEP 2

Miter-cut ends of the first course of field strips and nail them in place. Tongues at the other end of these strips will interlock with grooves in the next course.

STEP 3

After the field turns a corner, you'll need to cut pieces that eventually will be too short to nail. Glue these to each other and to the subfloor with epoxy.

with borders

If your decorating scheme calls for an area rug in the center of a room, an imaginative floor treatment can create excitement around its perimeter. The design at *left* uses two colors of prefinished short strips. Darker strips, laid parallel to the walls and butted at corners, match other woodwork in the room. Lighter wood, installed in diagonals and also butted, gives the floor's field a herringbone effect.

Of course, you can mix and match any combination of strips, planks, short strips, and parquet—so long as

they're the same thickness and, ideally, from the same manufacturer.

In planning a border treatment, scale it to the size of the room. A 12-inch-wide border, for example, works well in larger spaces, but it would overwhelm a 4-foot-wide hallway. If you're not certain how your border scheme will look, dry-lay it along two walls first.

Borders call for more cutting and fitting than a straight-from-the-box installation, but handsome wood floors will outlast your home's mortgage and add value when you sell.

four more ways to border a floor



Feature strips, single boards of lighter or darker wood, can break up a large expanse of flooring. From Bruce.



Laminate floors, like this one from Nafco®, also lend themselves to attractive border designs.



Historic Floors of Oshkosh offers precision-cut borders like this combo of purple heart, maple, and wenge.



This geometric design from Bruce proves that borders don't need to hug the walls, either.

STEP 1

First, lay the border. We butted boards at the corners, called a log cabin corner. Rip the tongues off the innermost strips so the field strips can butt against them.

add drama with medallions

STEP 4

Glue the shim and medallion in place. Pack any gap between the medallion and flooring with matching latex filler, which some manufacturers provide. Sand and finish with two coats of quality polyurethane varnish.

STEP 3

Test-fit the medallion in the cutout. You may need to shim with plywood to bring the medallion flush with the flooring around it.



and inlays

STEP 1

Figure out where you want to locate the medallion, and mark its outline on the subfloor. Lay flooring, taking care not to nail or glue in the area where you will install the medallion.



STEP 2

Rout a cutout for the medallion. Some manufacturers provide templates you can rout to, or improvise a guide like the tram-mel point system shown here.

An inlaid medallion like this one from Historic Floors of Oshkosh brings a welcoming note to an entry. Or center a medallion in a living or dining room floor under a glass-top table, on a stair landing, or in a hallway. Medallions and other inlays come premanufactured, or, with a router

and ingenuity, you can create your own one-of-a-kind floor.

Centuries ago, highly skilled artisans painstakingly crafted inlaid ornamental floors in castles and palaces. Nowadays, power tools and laser-cut materials can make easy-to-install medallions out of any design that can be drawn.

three more ways to lay inlays



Two wood tones team up with 3-inch ebony keystone tiles to give this living room floor a basket-weave pattern. Laminate floors, like this one from Nafco, are easy to inlay because you can cut the material with a utility knife.



Bruce also offers keystone inlays with their Custom Crafted Wood Tile Collection, shown here in a parquet-floored entryway.



This multi-star medallion—also from Historic Floors of Oshkosh—features inlays of walnut, American cherry, red oak, and mahogany.

color a floor with paint



STEP 1

Mark lines for the edging. Place tape along the lines, then smooth it down with the back of a spoon. Paint up to and over the tape edges. As soon as the paint sets up, but before it dries, carefully pull up the painter's tape.

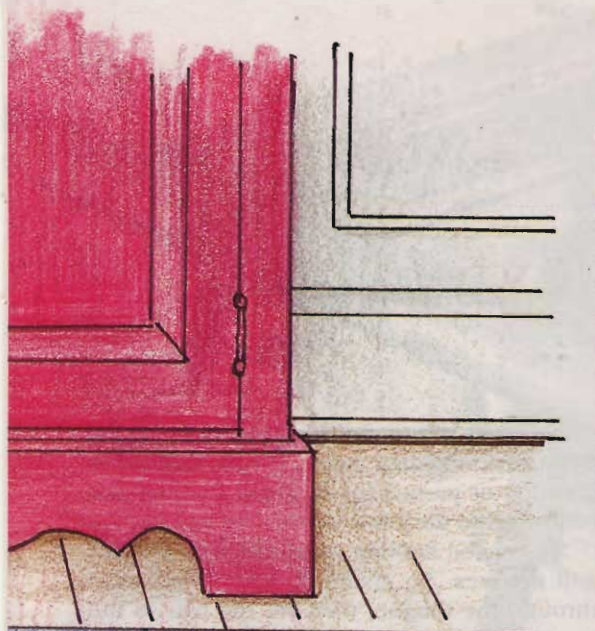

STEP 3

Let the design dry for 72 hours, then seal it with two coats of water-base polyurethane.

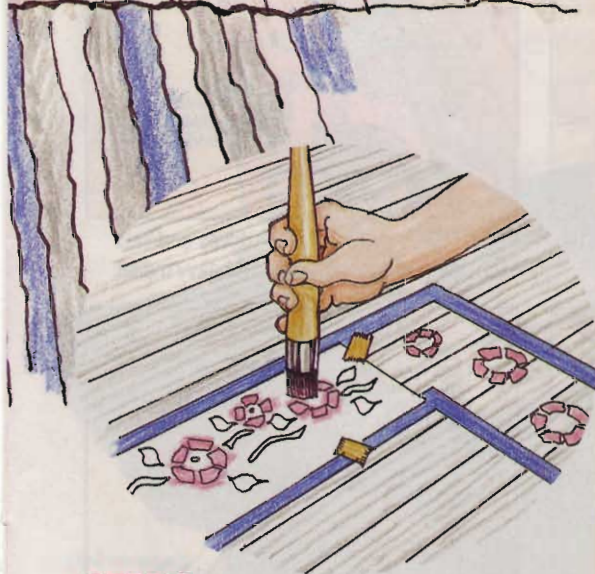

STEP 2

Buy precut stencils from a crafts store, or cut your own design from stencil sheets. Use a nearly dry stenciling brush to dab on enamel.

Colonists who couldn't afford the costly rugs of their era often brought color into their homes by painting their wood floors. You can do the same with floor-and-deck enamel, tape, stencils, polyurethane varnish, and plenty of patience.

Painting makes special sense for older wood floors that have seen better days, but you could also install new unfinished flooring, sand it smooth, and seal it before apply-

ing your paint artistry. Here we sanded an existing plank floor, and "bleached" it with transparent white oil-base stain before stenciling the multicolor border.

Tape tip: Don't use the gummy stuff most of us know as masking tape. It tends to leave gunk behind when you pull it off, creating more problems than you started with. Instead, look for "low-tack" or "quick-release" painter's tape.

three more pleasing paint possibilities

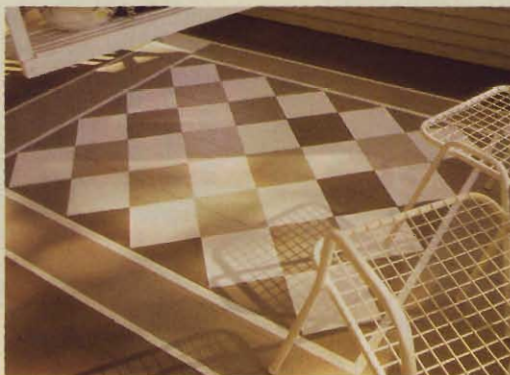

Perk up a porch with a geometric "rug." First paint the area white, then tape off and paint gray squares.



A former sleeping porch becomes a game room with game boards for Parcheesi, hopscotch, and checkers.



Stenciled diamonds and stripes deck out this stairway "runner." Seal with low-luster, slip-resistant varnish.

installing a wood floor

Two Ways to Go

Solid wood and engineered floorings go down differently. Here's the drill for each.

Unfinished solid wood flooring grades vary depending on the species of wood. Clear typically is the best; followed by select; No. 1 common; No. 2 common; and 1½-foot shorts, which are remnants from the other grades. The manufacturers of prefinished flooring typically grade products in such categories as "good," "better," and "best."

You can lay strip and plank flooring across existing floorboards. Sweep the floor well, set popped nails, and remove baseboard moldings.

Smooth out minor floor problems by laying down rosin building paper. If your subfloor is plywood or particleboard, install flooring perpendicular to the joists.

Most wood flooring interlocks with tongues and grooves. To fasten it, you "blind nail" through the tongue, then set the nail so the groove of the next board will fit over the tongue of the one you've just nailed. A power nailer—available from flooring or rental dealers—speeds the job and saves your back.

continued

laying solid wood flooring

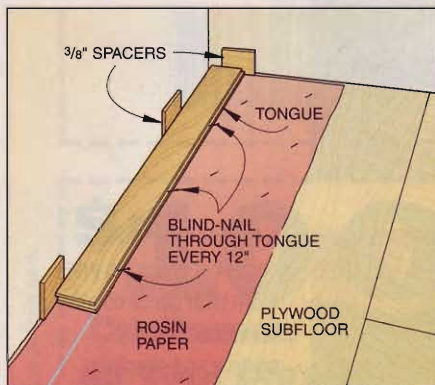

FIGURE 1 Leave a 3/8-inch gap between the flooring and walls. Molding will cover the gap.

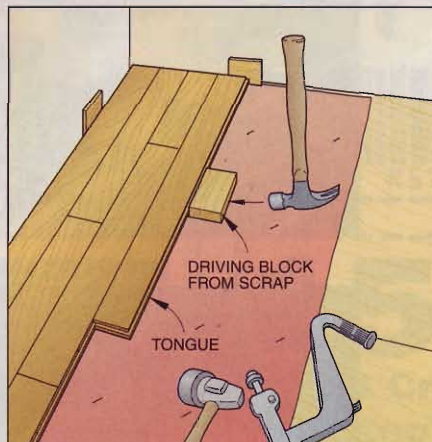

FIGURE 2 To keep the courses parallel, tap boards together before nailing.

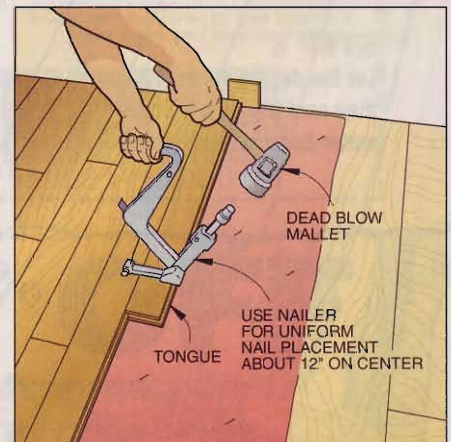

FIGURE 3 A power nailer drives and sets each nail with two blows from a heavy mallet.

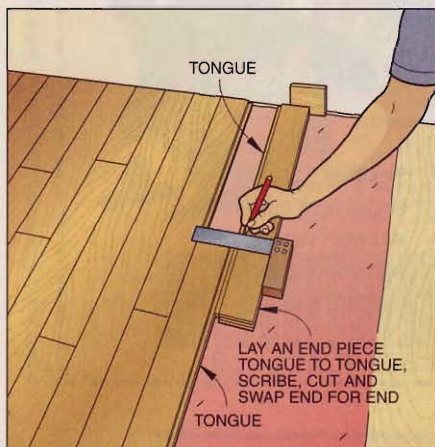

FIGURE 4 You'll need to cut the last board in each course. Here's an easy way to measure.

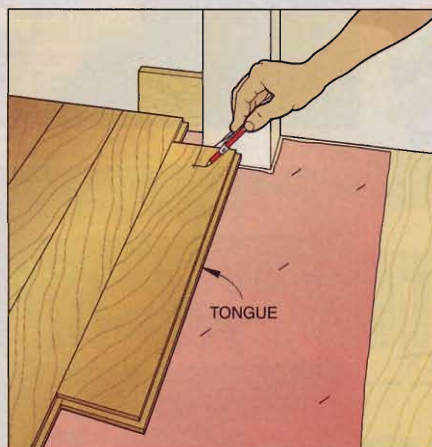

FIGURE 5 Use a compass to scribe cutouts for casings and other irregularities.



FIGURE 6 Push the last course tight with a pry bar, face-nail it, and cover the nails with putty.

installing a wood floor

If you've decided on engineered wood or laminated flooring, you have several installation options, all easier than a solid wood floor-laying project. You can nail, staple, or glue an engineered wood floor to the subfloor, glue down laminated flooring, or "float" either type.

Glued to adjoining strips rather than to the subfloor and laid over 1/8-inch-thick foam, a floating floor can be installed over just about any subfloor except carpet. The foam provides resilience and deadens sound. And everything interlocks with a tight, friction fit.

Floating floors have been around in Europe for more than 40 years, and U.S. manufacturers now offer systems in a variety of prefinished, laminated shapes: strips, planks, and parquets.

The hardwood floor we launch here started out as three-strip-wide planks that you can lay in a matter of hours.

Of course, you still need to do some preliminary work. Pry off any shoe moldings, and make sure the subfloor is dry, sound, and level.

Next, as with any flooring material, divide the room's width by a plank's width to determine the number of planks needed. In most cases, this number won't come out even, so divide this figure by two to determine a starting point along one side of the room.

Written by Jim Hufnagel

Design: David Ashe; Illustrations: David Ashe, Carson Ode

Graphic Design: Mary Bendgen

special thanks to...

Mark Bjork, Phillips Floors,
Indianola, IA

Bruce® Hardwood Floors
800/722-4647

Hartco® Quality Wood Flooring
800/769-8528

NAFCO® Luxury Vinyl Flooring
800/248-5574

National Oak Flooring
Manufacturers Association
(NOFMA)

National Wood Flooring
Association (NWFPA)

Historic Floors of Oshkosh, Inc.
920/582-9977

floating a floor

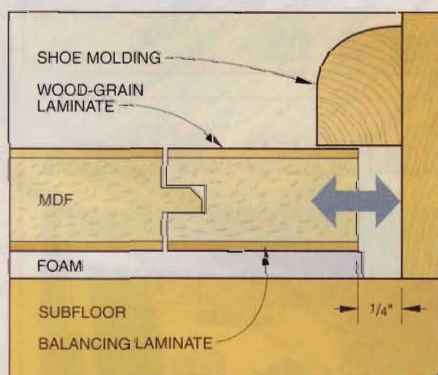

FIGURE 1 Laminate, which is more stable than wood, requires 1/4-inch spacing around the edges.

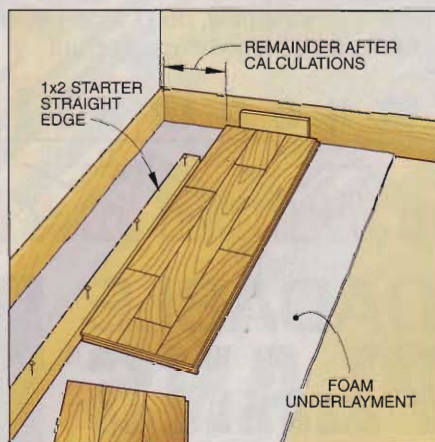

FIGURE 2 After you've figured out a starting line, nail a straightedge to secure the first plank.

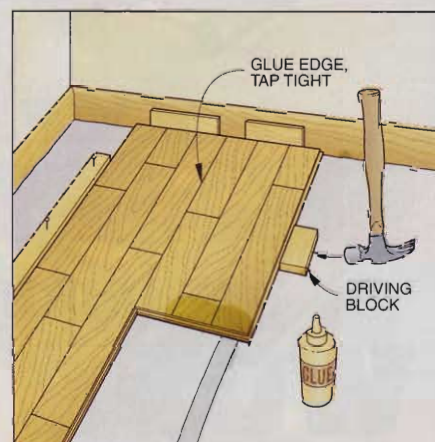

FIGURE 3 Apply a thin bead of glue along the groove in the second plank, and tap it in place.

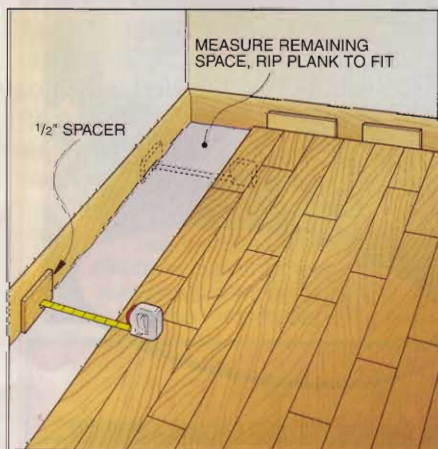

FIGURE 4 Measure for the first and last planks at several points, and rip them to fit.



FIGURE 5 Apply glue and use a pry bar to snug up the first and last planks, as shown.



FIGURE 6 Finally, nail on matching shoe moldings to cover the gaps around the edges.