

Better Homes and Gardens®

# WOOD

ISSUE 126 September 2000

[www.woodmagazine.com](http://www.woodmagazine.com)

## Heavy-Duty routers

We shop-tested  
8 feature-filled  
models

Page 68

## Angler's showcase

A great place to  
store your gear

See page 58

Keep  
your  
router  
bits  
sharp  
and  
save!

Page 56

Plus

**4** more home and  
shop projects

Display until September 5

U.S.A. \$5.95



0 72440 14072 1 09 >



## two more inductees join the **woodworking hall of fame**

Established in 1997 as a way to honor woodworking's best and brightest, *WOOD*® magazine's Woodworking Hall of Fame is proud to announce the year 2000's honorees:



**Bob Flexner**, master wood finisher/refinisher, author, educator, and editor of *Professional Refinishing* magazine.



**R. Bruce Hoadley**, doctor in wood technology, author, teacher, and consultant.

*Congratulations gentlemen on this, your latest achievement. And keep up your great contributions to the world of woodworking. To learn more about Bob and Bruce, and to review a listing of previous inductees, see Pete Stephano's article on page 37. Or visit [www.woodmagazine.com](http://www.woodmagazine.com).*

## introducing the *WOOD* magazine **reader project gallery**

Some of you may remember that a while back I urged you to save your woodworking memories by making photographs of your projects. Well, I'm happy to report that a lot of you must have taken me up on that advice.

We've been getting more reader photos than ever before, and we love it. In fact, you've got us so excited that we've decided to create the *WOOD* magazine Reader Project Gallery.

Margaret Clossner, our Production/Office Manager, and Barb Helps, our Art Business Secretary, thought of the idea. So now when the *WOOD* staff and visitors to our shop have a moment, they'll be able to take a look at your handiwork. We plan to rotate the photos every month.

By the way, if possible, include yourself in the photo alongside the project so we can put your face with your name. Okay everybody, get out your cameras. Send your photos to:

Reader Project Gallery  
*WOOD* magazine  
1716 Locust Street, GA310  
Des Moines, Iowa 50309-3023

**Customer Service Information:** For service on your subscription, including change of address, contact [www.woodmagazine.com/service](http://www.woodmagazine.com/service) or call 800/374-9663. **Subscription mailing address:** *Better Homes and Gardens WOOD* magazine, P.O. Box 37439, Boone, IA 50037-0439. Please enclose your address label from a recent issue. **Editorial mailing address:** The Editor, *WOOD* magazine, 1716 Locust Street, GA310, Des Moines, IA 50309-3023. For questions for our editorial staff, questions about how to reach an advertiser, or to place an advertisement in our magazine call 800/374-9663. To order back issues call 800/346-9663. For article reprints, write to editorial address and enclose \$5 per article.

Better Homes and Gardens®

# WOOD®

SEPTEMBER 2000 • Vol. 17, No. 6 • Issue No. 126

Editor **LARRY CLAYTON**  
Managing Editor **JIM HARROLD**  
Assistant Managing Editor/Features **PETER J. STEPHANO**  
Senior Design Editor **JAMES R. DOWNING**  
Projects Editor **BILL KRIER**  
Projects Editor **JAN HALE SVEC**  
Products Editor **DAVE CAMPBELL**  
Techniques Editor **JIM POLLOCK**  
Shop Manager/Project Designer **CHARLES I. HEDLUND**  
Assistant Design Editor/Project Builder **KEVIN BOYLE**  
Assistant Art Director **CHERYL A. CIBULA**  
Production/Office Manager **MARGARET CLOSSNER**  
Administrative Assistant **SHERYL MUNYON**  
Art Business Office Secretary **BARBARA HELPS**  
Reader-Contact Specialist **BEN VONRUDEN**  
Contributing Editors **KIM DOWNING, DAVE HENDERSON, LORNA JOHNSON, ROXANNE LEMOINE, BOB McFARLIN, CARSON ODE**  
Contributing Craftsman **JIM HEAVEY**

Publisher **MARK HAGEN**  
Advertising Director **WILL MURPHY**  
Ancillary Sales and Internet Manager **MARLEN KEMMETT**

Advertising Office: 333 N. Michigan Ave., Suite 1500,  
Chicago, IL 60601 Phone: 312/853-2890 FAX: 312/580-7906  
Direct Response Advertising **CAROLYN DAKIS**  
Account Executive **YUWEI LEE**  
Account Executive **RON GOLMINAS**  
Marketing Manager **GERALLIE LEGASPI**  
Sales Assistant **MARGARET TRAVIS**

Publishing Director **WILLIAM R. REED**

Advertising Services Manager **PAT HENDERSHOTT**  
Consumer Marketing Director **LIZ BREDESON**  
Associate Consumer Marketing Director **KATHI PRIEN**  
Assistant Consumer Marketing Manager **DAVE HONOLD**  
Business Manager **CRAIG FEAR**  
Senior Product Manager **RICK GROW**

**MEREDITH PUBLISHING GROUP**

President **CHRISTOPHER M. LITTLE**  
Vice President Publishing Director **JERRY WARD**  
Creative Services **ELLEN DELATHOUER**  
Manufacturing **BRUCE HESTON**  
Consumer Marketing **KARLA JEFFRIES**  
Group Sales **JERRY KAPLAN**  
Operations **DEAN PIETERS**  
Finance and Administration **MAX RUNCIMAN**

**Meredith**  
CORPORATION

**WILLIAM T. KERR**, President and Chief Executive Officer

**E. T. MEREDITH III**, Chairman of the Executive Committee

©Copyright Meredith Corporation 2000  
All rights reserved. Printed in the U.S.A.

*Better Homes and Gardens*® *WOOD*® magazine (ISSN-0743-894X) is published nine times a year in February, March, April, May/June, July/August, September, October, November, and December by Meredith Corporation, 1716 Locust St., Des Moines, IA 50309-3023. Periodicals postage paid at Des Moines, Iowa, and additional mailing offices. *Better Homes and Gardens* trademark registered in Canada and Australia. Marca Registrada en México. **ONE-YEAR SUBSCRIPTION PRICES:** U.S. and its possessions, \$27; Canada, \$39; other countries, \$47. Canada Post Publications Mail Sales Product Agreement No. 1369350. Canadian BN 12348 2887RT. **CANADIAN RETURN ADDRESS:** *Better Homes and Gardens WOOD* magazine, 2744 Edna Street, Windsor, Ontario, N8Y 1V2. **POSTMASTER:** Send address changes to *Better Homes and Gardens WOOD* magazine, P.O. Box 37439, Boone, IA 50037-0439.

# this issue's highlights

WOOD® magazine

September 2000 Issue 126

www.woodmagazine.com



page 78

## woodworking projects

### 14 workshop dust boom

Catch woodworking debris at its source with our adjustable, ceiling-hung collection arm.

### 49 captivating cupola

Add charm to the roofline of your home or garage (and improve ventilation) with this easy-to-build ornament.

### 58 showcase for anglers

Hunters have display cabinets for their favorite firearms. Now, thanks to our lighted cabinet design, fishermen have a handsome place to store their rods, reels, lures, and accessories.

### 74 three-tiered pastry stand

Serve fresh pies or display colorful houseplants on this elegant server. To make the tiers, we fashioned three plates using a router and templates.

### 78 flight of fancy

This bandsawn box has legs and a beak, too. See how easy it is to make our exotic shelf-top bird using the full-size patterns inside.

### 84 great ideas: quick-adjust dado jig

Cut dados to the desired width with the help of this handy shop aid.

## tools & materials

### 68 routers with clout

In the market for a heavy-duty router? Check out the eight models tested in this survey, and see which ones came out on top.

### 98 products that perform

Give these new items a try: stop collars for drill bits, a precision miter gauge, a 12" compact disc sander, and a load support for vehicles.



page 58



page 49



page 74

This issue's cover wood grain: basswood

Cover photograph: Baldwin Photography

## tips & **techniques**

- 16** sizing up staves and segments  
Learn how to figure the angles when tackling projects having more than four joining sides or parts.
- 20** in search of the perfect finish  
See how professional woodworker Victor DiNovi applies his own unique finishing approach to enhance his projects.
- 26** talking shop  
Discover the secrets behind making the plates in our pastry stand on *page 74*.
- 28** tips from your shop (and ours)
- 41** rustic furniture basics  
Watch a craftsman turn tree limbs into fun, functional furniture.
- 56** tlc for router bits  
Extend the life of your bits' cutting edges with the honing process discussed here.
- 64** improving your carving skills  
A pro reveals his tricks for cutting and sharpening.
- 86** ask *WOOD*

## **features**

- 2** the editor's angle
- 8** talking back
- 24** *WOOD ONLINE*®
- 35** wood anecdote  
Discover the role yellow birch played in colonial America.
- 37** woodworking hall of fame  
Find out who this year's inductees are and why we selected them.
- 46** wood collecting  
Go with the grain and become one of the thousands of people who collect wood species from around the world.
- 80** chainsaw safety  
Brush up on the dos and don'ts of chainsaw use, including the right way to fell a tree.
- 104** finishing touches

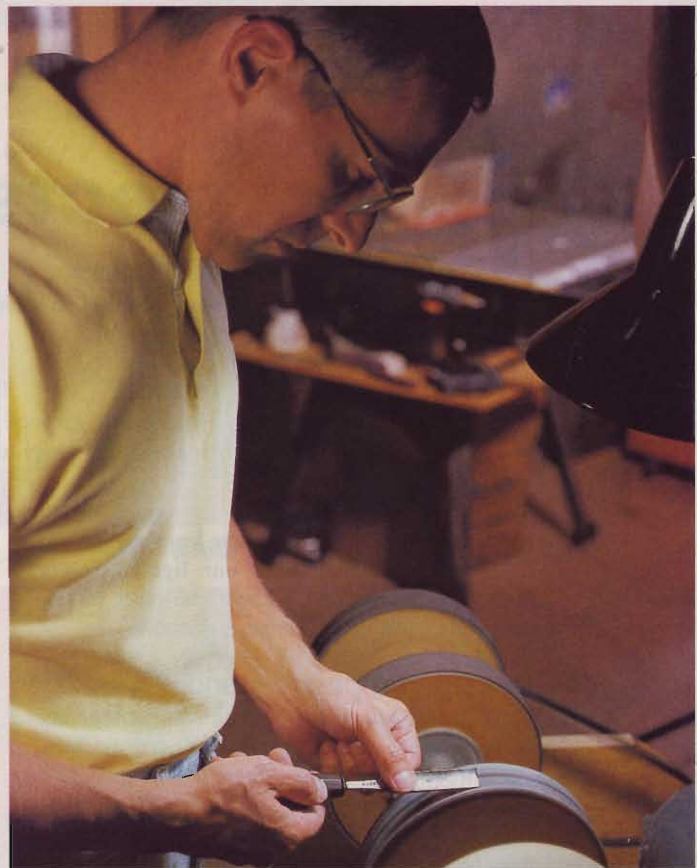

page 64



page 56

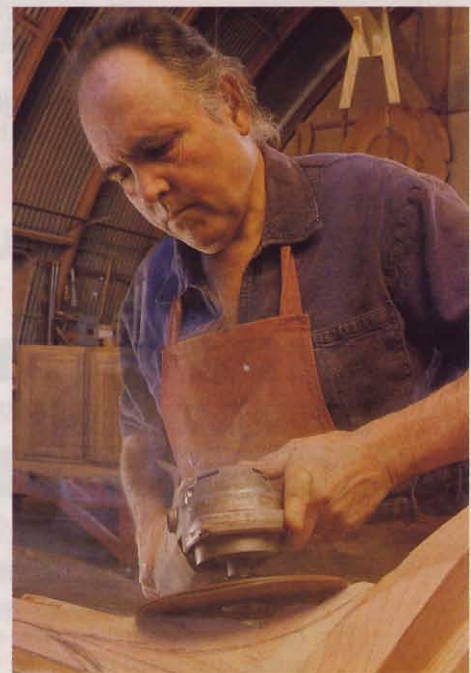

page 20

## Letters Comments & Updates

We welcome your comments, criticisms, suggestions, and yes, even compliments. We select and publish only letters of the greatest benefit to our readers. Write to:

**Talking Back**  
**WOOD® Magazine**  
1716 Locust St., GA310  
Des Moines, IA 50309-3023

### Static about electricity

It seems every time we address the subject of electricity, we get zapped. A discussion of 110-volt vs. 220-volt circuits in Ask WOOD®, Issue 122, stirred up some dust. To clear the air, we asked Allan Powers, of P & E Engineering in Carlisle, Iowa, to comment. Here's what he had to say:

*First, a comment on nominal voltages. The correct designations for system voltages are 120 and 240 volts. The motor nameplate rating is generally 115 volts for use on a 120-volt system and 230 volts for use on a 240-volt system. The old designations of 110 and 220 volts, while still widely used, are obsolete.*

*Power drawn by a motor depends on the mechanical load driven, and will be exactly the same whether operated at 120 or 240 volts. Since the power in any electrical circuit equals voltage multiplied by current, a motor that draws 20 amps when operating at 120 volts will draw only 10 amps when operated at 240 volts. Consider the following:*

- *Wire size and the circuit breaker or fuse protecting the circuit limits the maximum current supplied. Normally, a 120 volt, 15-amp circuit can serve a 1-hp motor; a 20-amp circuit can serve a 1½-hp motor. By connecting the circuit and motor to operate at 240 volts, a 20-amp circuit can supply a 3-hp motor.*
- *Voltage drop occurs in every circuit, making voltage at the motor less than voltage at the service panel. Voltage drop is proportional to current flow and length of the circuit. Too much voltage drop and the motor runs hot with less power. A motor operating at 240 volts has only one-quarter the voltage drop it would have under the same conditions,*

*but operating at 120 volts. This means the distance from the service panel to motor for a 240-volt circuit can be four times that for a 120-volt circuit before running into voltage-drop problems.*

- *Inrush current occurs every time a motor starts, or if it stalls while operating. This "locked rotor current," typically six times the full-load current, sometimes listed on the motor nameplate as LRA (locked rotor amps), often limits the size of the motor operated on a given circuit. A fuse or circuit breaker sized to handle the running current of a motor blows or trips when the motor starts or stalls. For the same motor, the locked rotor current at 120 volts equals twice that at 240 volts.*
- *Inrush current also causes lights to dim when a motor starts. The inrush current of a motor operating at 240 volts equals half that of one operating on 120*

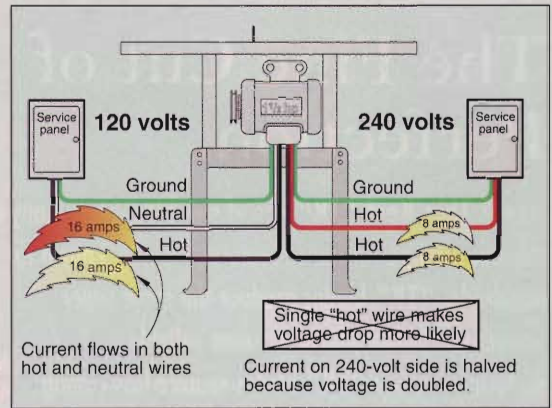

*volts, so the voltage drop that causes dimming lights would also be cut in half.*

- *Note the corrected drawing above. On the 120-volt side, 16 amps flow in the hot and neutral wires. On the 240-volt side, 8 amps flow in both hot wires. Current always balances—out on one wire, back on the other. Current on the 240-volt side is halved because voltage is doubled.*

— Allan Powers, Carlisle, Iowa

### Norwood upgrades its portable sawmill

Just after we went to print with our review of portable sawmills in Issue 125, we learned that Norwood Industries has replaced the Mark IV model we tested with a new model, the Super Lumbermate 2000. According to Dale Spry at Norwood, "The 2000 is bigger, stronger, and beefier than the Mark IV, but at the same price."



Indeed, the larger-throated Super Lumbermate 2000 can handle 31" diameter logs and cut 25" wide slabs (compared to the Mark IV's respective 27" and 19¾" capacities). In addition to the options available on the Mark IV, new options include sawhead rotators that allow two-way cutting, a 15-hp Kohler electric-start engine, and a power log lifter. The Super Lumbermate 2000 sells for just under \$4,000, and you can find out more by calling Norwood at 800/567-0404, or by visiting [www.norwoodindustries.com](http://www.norwoodindustries.com).

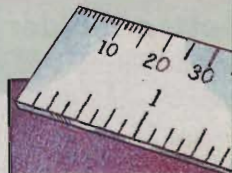

## Metric note causes discord

It's not often I feel the need to reply to a statement in *WOOD*® magazine, but your answer to Melvin Brzostek in Talking Back, Issue 122, on the use of the metric system needs comment. The entire world, with the exception of the United States, uses the metric system of weights and measures.

Industry and the federal government recognize this, evidenced by their use of both systems. Schools teach the metric system, and scientists use it exclusively.

Changing over to the metric system is not easy. I grew up thinking in feet and inches and, to a large extent, still do. But, slowly I'm becoming familiar with metric units. It's not impossible to make the transition.

If, as you claim, *WOOD* is, "the world's leading woodworking magazine," you should be providing leadership in the changeover to a universal system of measurement. Instead, your comment evidences isolationist thinking that does not show you in good light.

—Robert Amesbury, Seattle

*WOOD* magazine has many readers outside the USA who routinely use metric units of measurement. Completely ignoring the fact that another system exists does not give credit to your otherwise top-notch magazine. No shortage of metric measuring devices exists. Stanley, Starrett, Lufkin, and US Tape sell dual-unit tape measures. Metric scales by Staedtler-Mars, Alvin, and Charvoz are available from graphics arts supply stores. Sharp, Texas Instruments, and Radio Shack make metric conversion calculators.

—Kurt Heinze, Scarborough, Ont.  
Continued on page 10

# Dust free woodworking

Oneida Air 1.5 hp



Clean Air

Filter Inside

FOR ONLY

**\$659<sup>00</sup>**

FOB  
Syracuse  
New York

Flex Hose & 35 gal. Barrel **\$29<sup>00</sup>**

Optional wall mount brackets **\$28<sup>00</sup>**

fi 1400 cfm fan/blower  
fi 700 cfm @ 8" W/C system

Filter Efficiency

1-2 microns 99%

2-5 microns 100%

over 5 microns 100%

U.S.A.  
made



Call 1-800-732-4065

[www.oneida-air.com](http://www.oneida-air.com)

1001 W. Fayette St. Syracuse, NY 13204 Phone (315) 476-5151 Fax (315) 476-5044

## LOSE THE HASSLES

RBI GIVES YOU WOODWORKING MACHINERY THAT IS...

- Designed to be easy to use
- Over 70 years of building quality tools
- Backed with excellent customer service
- Covered by a great warranty
- All American Made

RBI gives you the best value for your woodworking dollar!

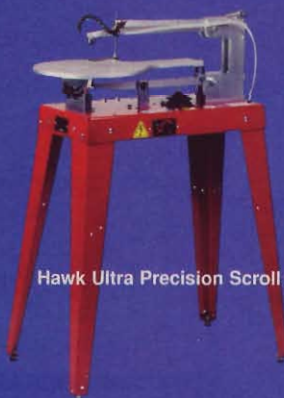

Hawk Ultra Precision Scroll Saws



RBI 4-in-1 Universal Planers



26" & 38"  
Drum Sanders



Panel Master II

**rbindustries, inc.**

1801 Vine Street • Harrisonville, MO 64701

[www.rbiwoodtools.com](http://www.rbiwoodtools.com)

Call 1-800-487-2623 for your FREE fact kit!

K112

**Use a safer solvent**

I was dismayed to see the suggestion in Hot Off the Internet, Issue 122, to use MEK (methyl ethyl ketone) for softening dried-out wood putty. As a retired supervisor in the paint-repair department at General Motors, it was a constant chore getting workers to wear appropriate protective gear when working with MEK. This solvent is a serious health hazard and should be used with great care.

— John Jacobs, Morristown, Tenn.



*We checked the Material Safety Data Sheet (MSDS) on MEK, John, and compared it to acetone. While the health hazards of both solvents are similar, the key danger of MEK is its ability to dissolve fatty tissue in the skin and enter into the circulatory system. While acetone also can do this, its higher vapor pressure, 2 1/3 times that of MEK, means that acetone evaporates more rapidly and has less chance to penetrate the*

*skin. The molecular structure of MEK also makes it harder than acetone for the body to metabolize; a MEK "hangover" will last much longer than an acetone one. It may seem a moot point because our survey of local hardware and paint stores turned up plenty of acetone, but no MEK. However, anyone bringing it home from work or getting it from somebody who does should leave it there.*

**Attention Settee builders**

Before you start building the settee for two in Issue 125, please note that there are errors and omissions in the full size patterns for the rear legs (A) and center supports (B). The pattern insert in this issue shows the proper shape of the notch in parts (A) and (B) as well as the bolt hole locations in these same parts. Also, part (A) is 5 1/2", not 5 5/8" wide. Included is a Part View drawing of the center support (B) showing the locations of the rear crossmember (F) and the hole for the bolt that connects (B) to (F).

**Revisiting our portable planer review**

Thanks for the excellent portable planer review in Issue 120. I own a Delta 22-560 as well as a 22-540 and agree with the 22-560 as the top pick. However, a couple of errors mar the article. First, the center handle referred to on page 59 is in fact a stock roller. The handles, located at the bottom of the machine, are clearly shown in the picture on page 56. Second, on page 60, you indicate there is no dust collection port available for the Delta 22-540. I have one, Delta part no. 50-259, on my planer.

—Ron Short, Delta, B.C.



**Customize the panel-cutting sled to cut short, too**

For a long time I have wanted to build a panel-cutting sled, but never found a good plan until the one in Issue 114. But in order to increase its versatility, I attached a self-adhesive rule to the sled next to the fence. I also made another stop block 1/2" longer with two holes in it to replace the one shown. I then inserted another rod into the second hole, and fitted a stop-block on its other end to ride the sled [as shown at right]. Now I can quickly set up to cut lengths under 27" as well as over.

—Arnold Siemens, Taber, Ala.

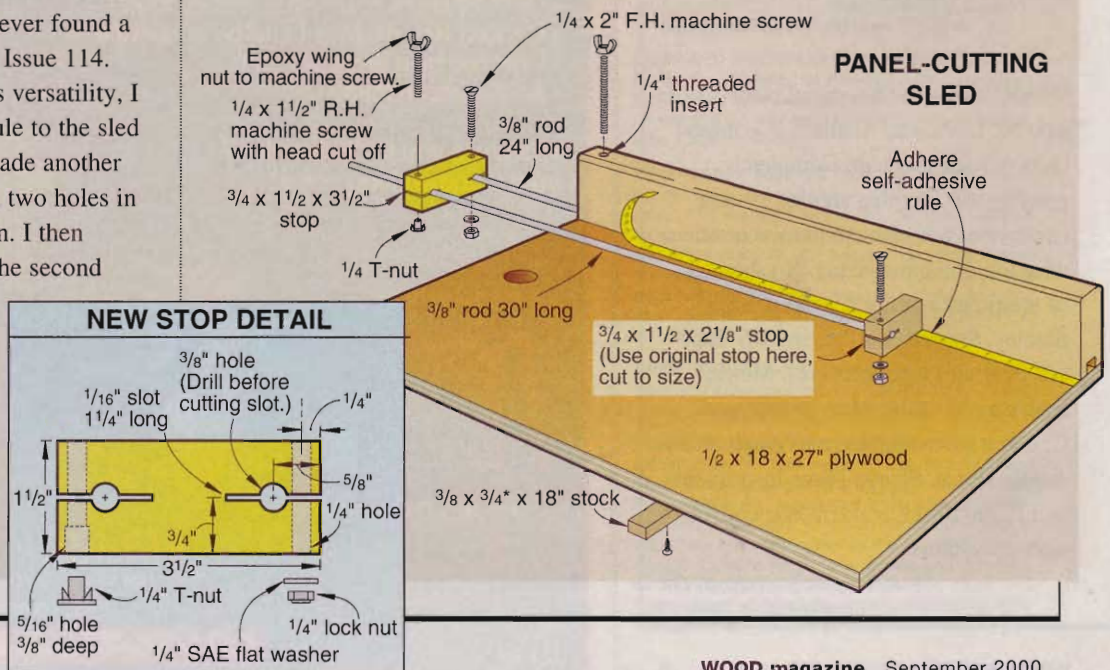



# workshop dust boom

the long arm of debris collection

Hard-to-snag dust doesn't stand a chance with this handy boom. It extends dust collection to the source of the debris, and retracts out of the way when you no longer need it.

## Let's make the components

**1** Cut 10 pieces of  $\frac{3}{4} \times 3\frac{5}{8} \times 3\frac{5}{8}$ " pine, and glue them into two cubes (A) of five pieces each. For stability, alternate grain direction with each piece.

**2** True up each square to  $3\frac{1}{2} \times 3\frac{1}{2}$ " using a stationary sander. Drill a  $\frac{5}{16}$ " centered hole through each cube. Drill a  $\frac{1}{4}$ " hole  $1\frac{1}{2}$ " deep centered on a side adjacent to the side with the  $\frac{5}{16}$ " hole. (See the Exploded View drawing.)

**3** Rout  $\frac{1}{2}$ " round-overs on three of the top edges, but not on the edge of the side with the  $\frac{1}{4}$ " hole. Rout a continuation of the round-overs on two edges of the side opposite the  $\frac{1}{4}$ " hole.

**4** Screw a  $\frac{5}{16}$ " hanger bolt into the  $\frac{1}{4}$ " hole of each cube, leaving  $1\frac{1}{2}$ " protruding from the cube.

**5** From  $\frac{3}{4}$ " plywood, saw three  $3\frac{1}{2} \times 24$ " arms (B). Mark a  $1\frac{3}{4}$ " radius on both ends of each arm. Cut and sand to shape.

**6** Drill the holes in each arm, as shown in the Parts View drawing in the *WOOD PATTERNS*® insert. Note that Arm 2 is identical to Arm 1 except that Arm 2 has a counterbored  $\frac{3}{8}$ " hole in place of the  $\frac{5}{16}$ " hole in Arm 1.

**7** To make the arm slots, drill  $\frac{5}{16}$ " holes at the far ends of the slot locations. Rout between the two holes with a  $\frac{5}{16}$ " straight bit. (This is best done on a router table with fence.) Round over all of the sawn, drilled, and routed edges with a  $\frac{1}{16}$ " round-over bit or by sanding.

**8** Cut and drill the dust-collection box parts (C, D, E, F, and G) according to the dimensions shown in the Exploded View drawing and the Box Top and Box Bottom drawings in the *WOOD PATTERNS* insert.

**9** Cut a  $1\frac{1}{2}$ "-long piece of 4" PVC pipe to make the duct collar. Pre-drill the collar for  $\frac{3}{8}$ " wire nails, and attach the collar to the top of the box (C) with the brads and epoxy.

**10** Assemble the box with woodworker's glue and 1" brads. Sand the edges and corners flush.



**11** From  $\frac{3}{4}$ " plywood cut the ceiling plate (H) to  $5 \times 30$ ". Drill a countersunk  $\frac{5}{16}$ " hole centered on the plate. Also drill countersunk  $\frac{7}{32}$ " holes spaced to match the on-center distance between your ceiling joists.

**12** Make the two friction discs by cutting four round pieces of 60-grit sandpaper to  $3\frac{1}{2}$ " diameter. Glue each pair together back-to-back and drill a  $\frac{5}{16}$ " hole centered in each.

## It's time to put it all together

**1** Insert a  $\frac{5}{16} \times 5$ " carriage bolt through the hole in the ceiling plate and attach a cube, where shown in the Exploded View drawing.

**2** Attach Arm 1 to the cube using a friction disc, fender washer, and plastic T-knob. The friction disc helps lock the arm securely in position when you tighten the knob.

**3** Insert a T-nut into the  $\frac{7}{8}$ " hole in Arm 2. Lock a  $2\frac{3}{8}$ "-long piece of  $\frac{5}{16}$ " all-thread rod into a T-knob with a  $\frac{5}{16}$ " nut. Attach Arm 2 to Arm 1 as shown in the Exploded View drawing.

**4** Attach Arm 3 to Arm 2 in the same fashion, but without a friction disc. (Wood-to-wood friction suffices at this point in the arm.) Attach the other cube to Arm 3 with a fender washer and knob.

**5** To attach the dust-collection box to the cube, you will need to re-drill the  $\frac{5}{16}$ " hole at an angle, as shown below. Drill it at just enough of an angle so you can fit the  $\frac{5}{16} \times 5$ " carriage bolt inside of the box and through the cube.

**6** Attach the 4" dust-collection elbow to the ceiling plate with metal strapping, leaving enough room for the cube and arm to rotate. Install the 6' dryer-vent hose between the elbow and the dust box using 4" hose clamps.

**7** Mount the entire assembly to ceiling joists using screws at least  $2\frac{1}{2}$ " long. 🐿



Angle the  $\frac{5}{16}$ " hole in the box top so you can pass the carriage bolt through it.

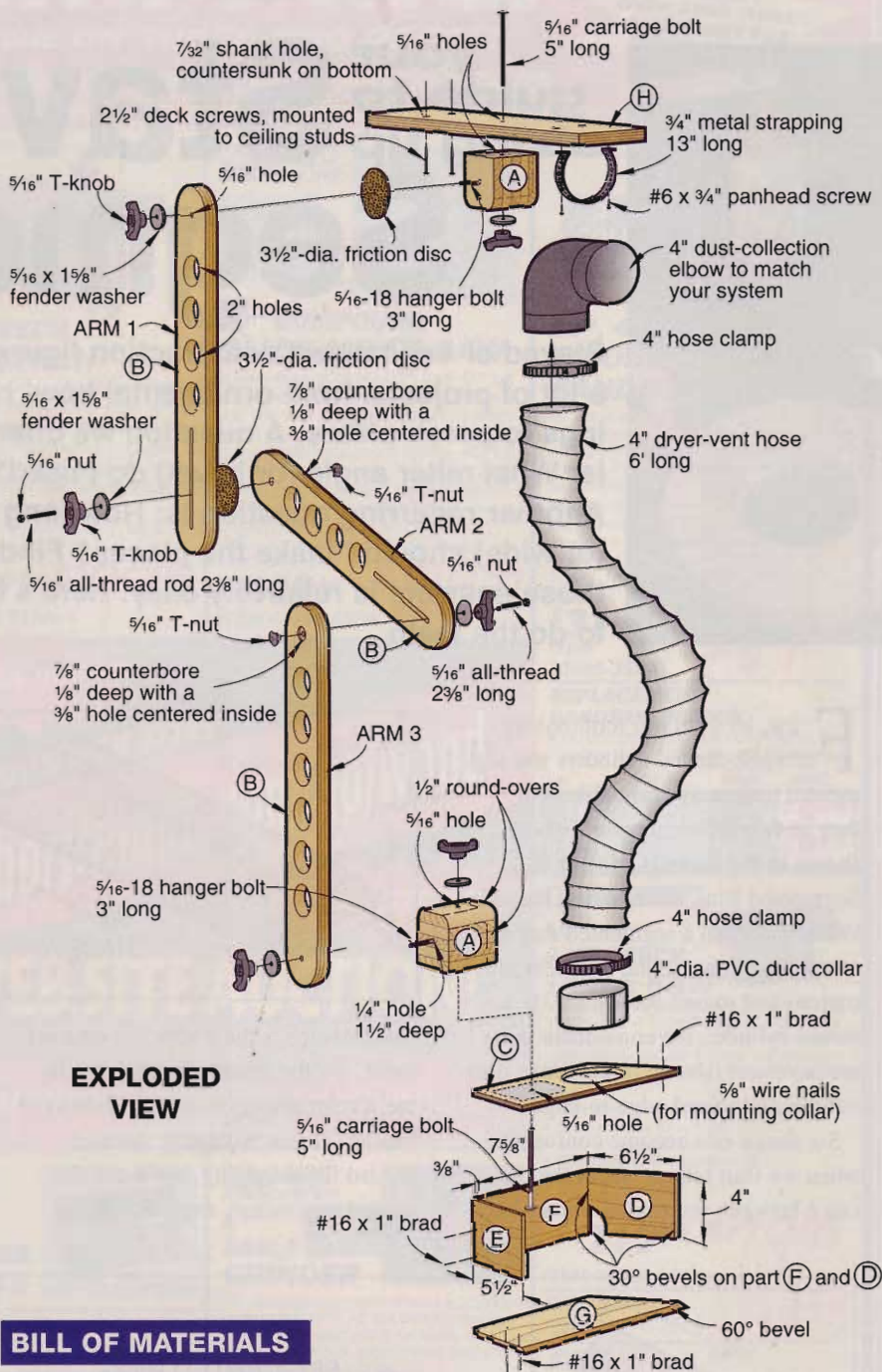

## EXPLODED VIEW

## BILL OF MATERIALS

Part	Finished Size			Matl.	Qty.
	T	W	L		
A* Cubes	$3\frac{1}{2}$ "	$3\frac{1}{2}$ "	$3\frac{1}{2}$ "	LP	2
B Arms	$\frac{3}{4}$ "	$3\frac{1}{2}$ "	24"	P	3
C Box top	$\frac{3}{8}$ "	$5\frac{1}{2}$ "	$11\frac{9}{16}$ "	P	1
D Box right side	$\frac{3}{8}$ "	4"	$6\frac{1}{2}$ "	P	1
E Box left side	$\frac{3}{8}$ "	4"	$5\frac{1}{2}$ "	P	1
F Box back	$\frac{3}{8}$ "	4"	$7\frac{5}{8}$ "	P	1
G Box bottom	$\frac{3}{8}$ "	6"	$11\frac{5}{8}$ "	P	1
H Ceiling plate	$\frac{3}{4}$ "	5"	30"	P	1

\*Cut parts marked with \* oversized. Trim to finished size according to instructions.

Materials Key: LP—laminated pine, P—plywood

**Supplies:**  $\frac{5}{16} \times 2\frac{3}{8}$ " lengths of all-thread rod (2),  $\frac{5}{16}$ " T-nuts (2),  $\frac{5}{16} \times 5$ " carriage bolts (2),  $\frac{3}{16} \times 3$ " hanger bolts (2),  $\frac{5}{16}$ " T-knobs (6),  $\frac{5}{16}$ " nuts (2),  $\frac{5}{16} \times 1\frac{5}{8}$ " fender washers (6), 13" length of metal strapping, 6' length of 4" dryer-vent hose, 4" hose clamps (2), #6x $\frac{3}{4}$ " panhead screws (2),  $\frac{5}{8}$ " wire nails,  $2\frac{1}{2}$ " deck screws (4), #16x1" brads, 4" dust-collection elbow,  $1\frac{1}{2}$ " length of 4" PVC pipe, 60-grit sandpaper.

## Buying Guide

Hardware kit including 2 lengths of all-thread rod, 2 carriage bolts, 2 hanger bolts, 6 T-knobs, 6 fender washers, and 2 T-nuts. Item DB, \$16.95 ppd. Schlaubaugh and Sons, 720 14th St., Kalona, IA 52247, or call 800/346-9663.

Written by Bill Krier with Erv Roberts  
Illustration: Roxanne LeMoine  
Photographs: Hetherington Photography

# your guide to **Staves and Segments**



Staved or segmented construction figures in a lot of projects, from ornamental bowl turnings to porch pillars. A question we often hear is: What miter angle (or bevel) do I need? Another recurring question is: How long (or wide) should I make the pieces? Finding those answers is relatively easy. Here's how to do the math.

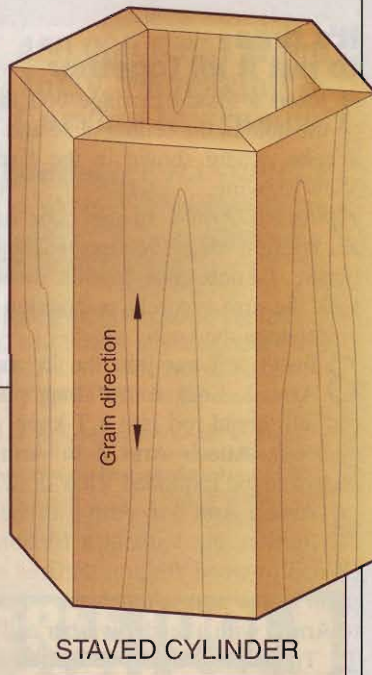

First, let's get our terminology straight. Staved cylinders and segmented rings may seem alike, but they're two different breeds of cats. As shown in the Staved Cylinder and Segmented Ring illustrations, the individual pieces in a segmented ring are miter-cut (shown in the Segment illustration) and joined at the ends. In a staved cylinder, the component parts are bevel-cut (shown in the Stave illustration) and joined edge-to-edge.

So, things can become confusing when we start talking about the distance between the angles. On a stave

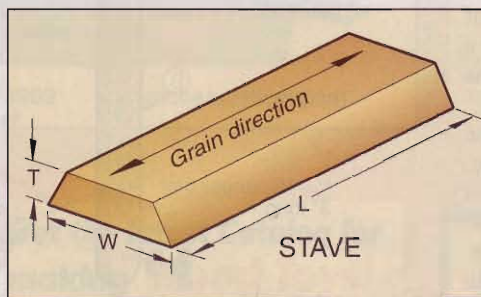

that distance is the width, but on a segment, it's the length. For this article, we'll refer always to length. Substitute "width" if you're cutting staves.

Also for simplicity, we'll call the angled cuts miters, even though we

know they may be either miters or bevels. Note, too, that this article only covers straight-sided cylinders or flat rings. Tapered cylinders or rings with sloped sides call for compound cuts.

## What's your angle?

A full circle contains 360°. So, to make a closed construction out of straight pieces, the corner angles must add up to 360°. In the simple figure with six equal-length sides shown in the Corner and Miter Angle illustration on page 18, the six 60° corners add up to 360°.

But, as shown, 60° is not the angle you need to cut on the ends of each piece. Because two sides come together to make the angle, each side must be miter-cut to exactly half the total corner angle, or 30°.

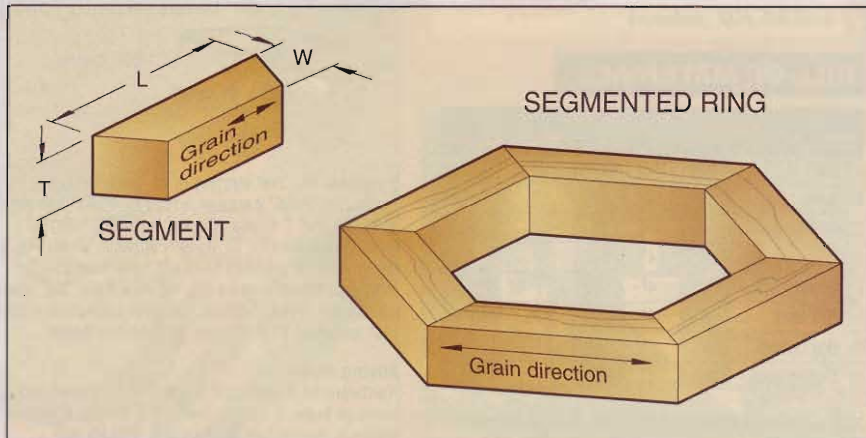

Continued on page 18

## Staves and Segments

Here's the rule for finding the angle: To determine the corner angle for a figure with any number of equal-length sides, divide  $360^\circ$  by the number of sides. To find the miter angle, divide the corner angle by two.

### Corner and miter angles for various numbers of sides

no. of sides	corner	miter
6	$60^\circ$	$30^\circ$
8	$45^\circ$	$22\frac{1}{2}^\circ$
10	$36^\circ$	$18^\circ$
12	$30^\circ$	$15^\circ$
16	$22\frac{1}{2}^\circ$	$11\frac{1}{4}^\circ$

### How big will it be?

To figure out the measurement across the assembled construction, shown as D1 in the Assembled Size illustration, multiply the side length (L) times the inside-diameter factor for the appropriate number of sides from the chart below. This dimension, which is the diameter of the largest circle that can be drawn inside the outline of the glue-up, also represents the diameter of the largest round piece that could be sawn or turned from the assembled ring.

You can calculate the width across the points, shown as D2, by multiplying the side length times the outside-diameter factor.

### Factor to find diameter

no. of sides	diameter	
	inside (D1)	outside (D2)
6	1.73205	2
8	2.41421	2.61313
10	3.07768	3.23607
12	3.73205	3.86370
16	5.02734	5.12583

And if you need to know the diameter of the opening in a ring, shown as D3, just multiply the length of the short edge of the segment (IL) by the appropriate inside-diameter factor

You can work backwards, too, to find the stave length required to produce a

given diameter. In this case, divide the desired diameter by the factor from the chart. To find, for instance, the side length for a hexagon that measures 24" across (D1), divide 24" by the inside-diameter factor (1.73205). Doing this gives us 13.85641", or  $13\frac{55}{64}"$ .

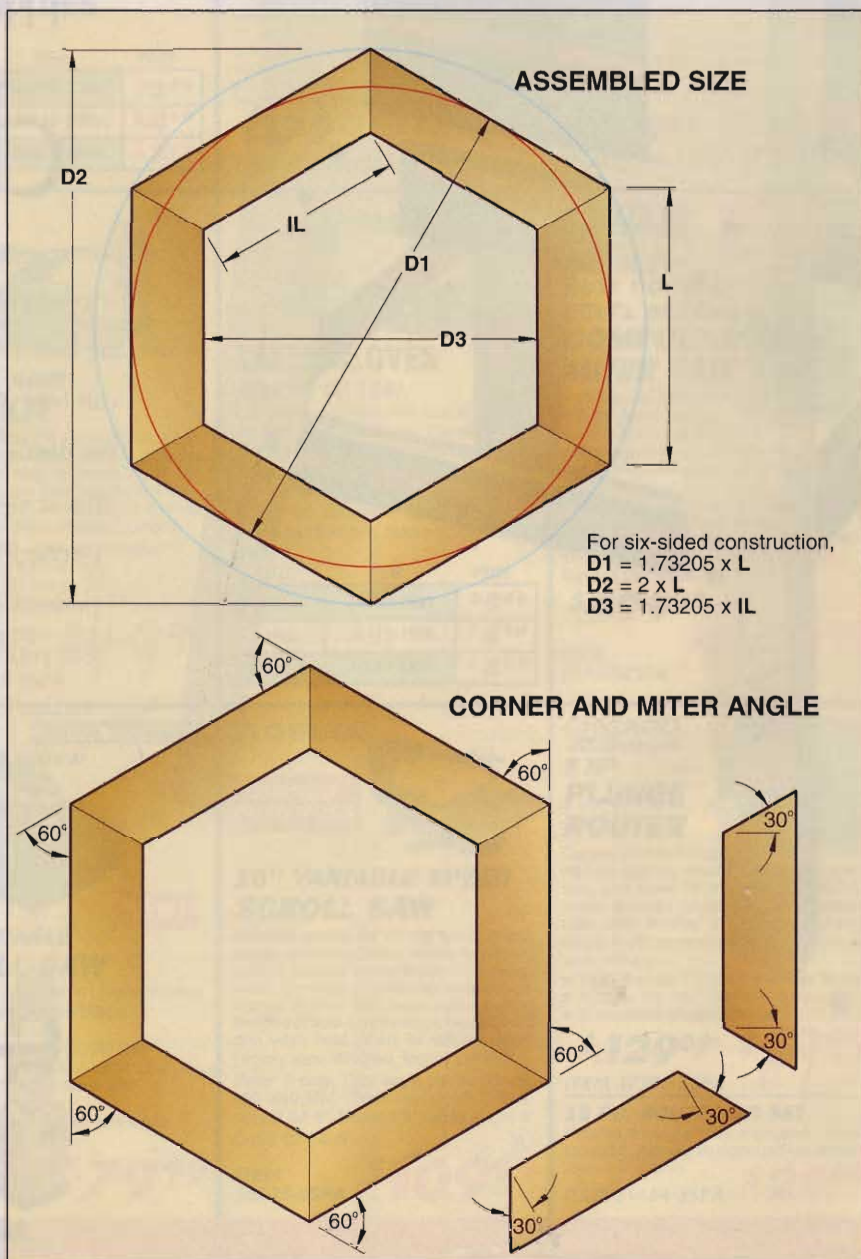

Illustrations: Roxanne LeMoine; Lorna Johnson

# this craftsman lets the wood sell itself

Professional woodworker Victor DiNovi captures wood's true beauty and protects it with a finish he calls a "compromise."

In his Santa Barbara, California, shop, Victor DiNovi makes the wood he works look as stunning as the one-of-a-kind furniture designs he's created for the last 30 years or so. That's not such an easy task, considering all the different wood species he employs.

"I use lots of American hard maple and black walnut, Honduras mahogany, imbuaya and iroko from Africa, Hawaiian koa, East Indian rosewood, and teak," says Victor. "Because the majority of what I make is for certain people—and people normally have a preference for either light or dark woods—I use the wood that works best for the commission."

## Wood requires preparation—and perseverance

Preparing any wood for a finish always takes time, but it's especially true for penetrating (oil) finishes, according to Victor. "The key to success with a penetrating finish is preparation. In other words, it requires a lot of work.

"Take sanding," he continues. "You can build a beautiful piece of furniture that's very smooth to the touch. But when you apply the finish, little sanding scratches appear that detract from it. That's because when you sand, the abrasives not only cut, but abrade the wood. The finish then travels into the abrasions to make them visible, especially on light woods. So very often you have to sand on faith. That is, you know you've sanded enough but you sand some more anyway, realizing that some abrasions may show up."

*Continued on page 22*

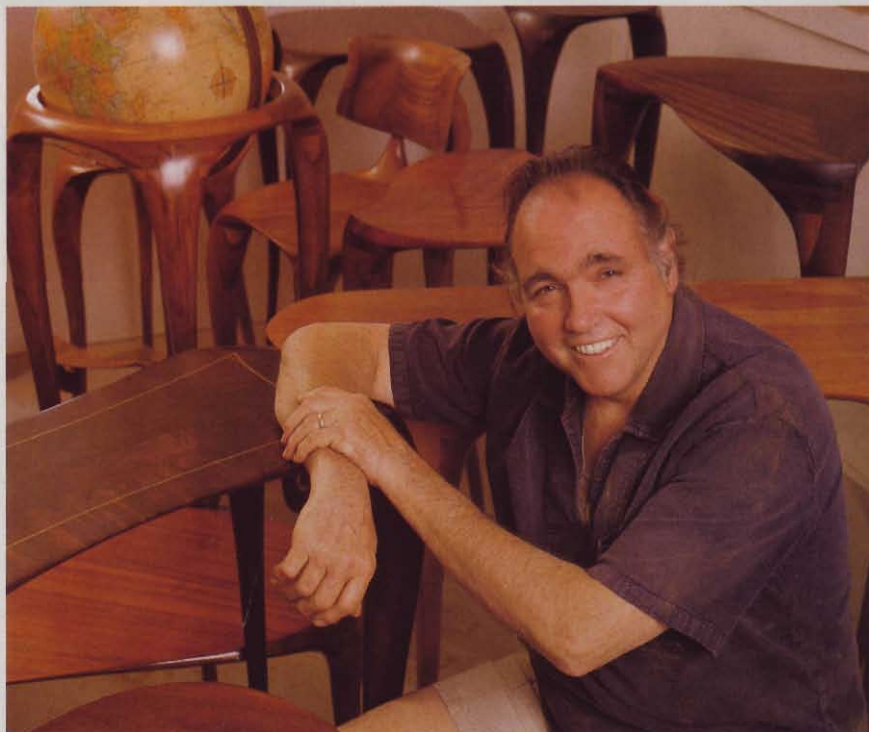

California's Victor DiNovi designs and builds sculptured furniture for clients from coast to coast.

Because of his furniture's many contours, this craftsman does all the rough sanding with an auto-body grinder.

## this craftsman lets the wood sell itself

To a professional woodworker, though, lots of sanding prior to finishing becomes a matter of economics. He says, "It takes too much time, especially because my furniture has few straight planes. So I use an auto-body grinder, power planes, and power chisels to get the wood to rough-sanded shape. Then I go over my pieces with a random-orbit sander down to 220-grit. I rarely sand any finer than that before my finish goes on." But as you'll find out, there's plenty of sanding to come.

### The first stage: wet-dry with oil

"Basically, there are two types of finishes for furniture: penetrating oils, such as Danish oil, and film finishes, such as lacquer and varnish," Victor notes. "Oils give wood a rich glow. But they don't protect it. Film finishes protect, but do little for the wood's natural beauty."

Victor, though, discovered a two-stage finish a few years ago made by General Finishes (General Finishes Corp., P.O. Box 51567, New Berlin, WI 53151, 414/786-6050) that has some of the advantages of both types. "I call the finish a compromise because the first coat has the good look of oil, and the top coat—although not film—has body. So the finish not only has a deep luster, but it's relatively tough," he comments.

Called Sealacell, the first coat is a clear penetrating sealer of tung oil, the woodworker explains. "Like a Danish oil, it cures so slowly that essentially it doesn't cure. I apply this first coat, thinned about 25 percent with paint thinner, with 220-grit wet-dry paper and actually sand the piece with the grain, with the oil as a lubricant. Then I wipe it off clean and give it another



Going beyond label instructions, Victor applies a penetrating, tung-oil sealer with 220-grit wet-dry paper. The top coats of an oil-urethane mix he'll wipe on, then buff with steel wool.

sanding with the finish. After wiping that off, I let the oil dry, then go directly to the top coats."

### Top it off with stage two

For Victor's second stage, the top coat, he wipes on Arm-R-Seal, also made by General Finishes. "It's an oil-and-urethane mixture that gives the wood a satin finish," he says.

Between top-coat applications, put on with a cloth, Victor rubs down the surface with 0000 steel wool. "There's no easy way to get around this aspect if you want a beautiful finish," he notes. "I put on six, seven, even eight finish coats, all rubbed after application. This finish is almost like applying a hand cream. You strengthen the wood fiber from the inside out as opposed to putting a film over the top." Once he's applied the finish, he lets it dry for eight hours.

The California woodworker admits not following to the letter the manufacturer's label instructions on application.

"Many people don't even bother to read the directions on the label. When I find a new finish, I do because they're a place to start," says Victor. "For instance, if the directions say 'apply two coats' assume that you'll need more. Those are just the words of some copywriter wanting to make it seem easy. And two coats will give you some success. But as you can see, I've developed an intensive application process—for a reason."

Victor's reasoning tells him that the burnishing he does with steel wool on the top coats makes the wood ultra smooth because it has a quite different cutting action. "Sandpaper cuts and digs, opening up the wood fibers. Steel wool rubs them closed. I'm literally compressing the surface. And the number of coats I put on depends on the porosity of the wood species I'm using. Some woods fill up with finish faster." ♣

Written by Peter J. Stephano  
Photographs: Bill Boyd

## Membership does have its privileges

When you register as a WOOD ONLINE member (at no cost to you), many benefits await you. In addition to page after page of helpful tips, plans, and discussions with other woodworkers, every month you can enter a new tool sweepstakes, download a woodworking plan, and receive a helpful newsletter via e-mail, all absolutely free! [www.woodmagazine.com/members/index.html](http://www.woodmagazine.com/members/index.html)

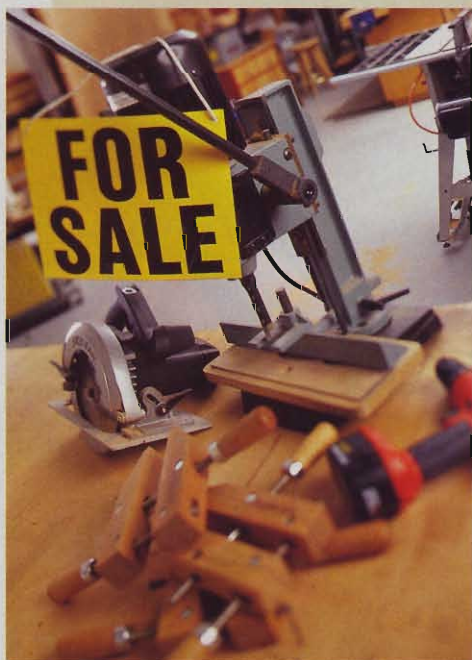

### Where else can you run a classified ad for free?

Forget about garage sales and newspaper classifieds; here's an easier, no-cost way to unload tools you no longer need. Just surf over to the classified section of WOOD ONLINE at the web address highlighted *here*. Once there, you can view

ads from others, and advertise your own items wanted or for sale.

The zero-cost ads last for 60 days, and reach thousands of viewers!

[www.woodmagazine.com/class\\_ads](http://www.woodmagazine.com/class_ads)

*"My thanks to WOOD ONLINE for its free ads.*

*I sold my contractor's saw and dust collector within a week after placing them in the classifieds section. I also had three others in line to buy them.*

*These classifieds work!"* —Jim Becker, New Hope, Pa.



## You'll find more than 20 step-by-step plans online

If you like the projects you see here in WOOD® Magazine, check out the vast selection of paper and downloadable plans available in the WOOD STORE®. You'll find everything from outdoor decorations, such as the newly designed reindeer, sleigh, and Santa *above*, to heirloom furniture, shop jigs, great gift ideas, and more. [www.store.yahoo.com/woodstore/](http://www.store.yahoo.com/woodstore/)

We asked 150 internet surfers: "In terms of your woodworking hobby, what do you consider to be the main benefit of the internet?" Here's what they told us.

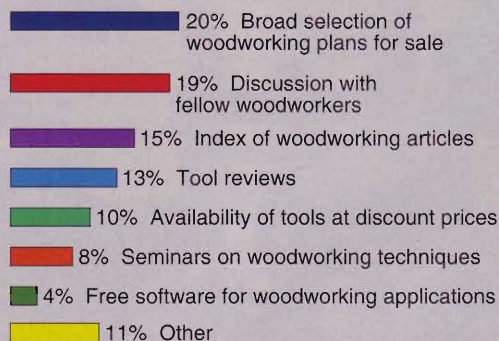

### Weekly help for your shop

Simple shop projects, such as these knockdown sawhorses, save you time, money, space, and possibly even a backache or two. To get a new shop-project plan every week, at no cost to you, go to the project section of Woodworking Basics.

[www.woodmagazine.com/woodbasics/projects/projectindex.htm](http://www.woodmagazine.com/woodbasics/projects/projectindex.htm)



# lessons learned

## from building the pastry stand

No matter how long you work with wood, there are always new things to learn. Just ask Chuck Hedlund, *WOOD*® Magazine's shop manager. Chuck has earned woodworking paychecks for nearly 40 years, yet most every project he builds provides new woodworking insights, or reinforces lessons learned long ago.

And that, in a nutshell, is the inspiration for this new series of articles. You'll learn alongside *WOOD* Magazine's project builders or designers as they tackle projects and solve problems around the shop. For this installment, Chuck shares with you three routing observations that he uncovered in building the pastry stand on *page 74*.

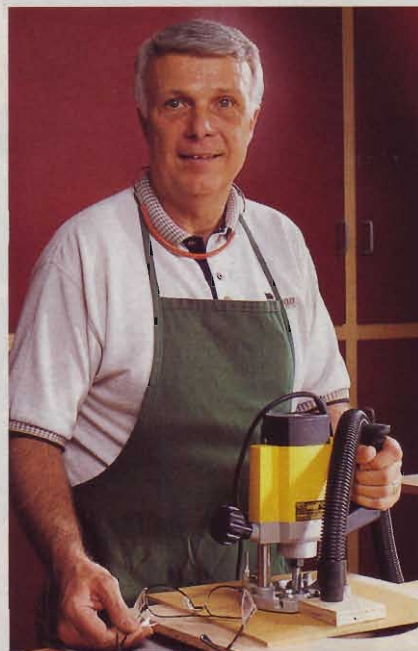

Chuck Hedlund takes a break from routing a pastry-stand tray using an auxiliary router subbase with built-in dust collection.

### Use a raised-letter bit for shallow depressions

Each of the trays in the pastry stand resembles a plate with a center that's lower than the rim of the plate. To cut the center depression, I originally tried a straight bit like the one at *right* in the photo. But, I quickly ran into snags.

First, the straight bit tended to tear out grain near the edges of the circular depression. Also, it left a surface that required lots of sanding cleanup. So, I tried a raised-letter bit, sometimes referred to as a bowl or tray bit, to cut the depression. It worked great.

Like the bit at *left* in the photo, these cutters have radiused carbide edges that prevent tearout. And, because they have cutting surfaces on their bottoms as well as their sides, they cut depressions that require little cleanup.

### There's no substitute for a plunge router

On more than one occasion I've had to make a plunge-routing cut without a



A raised-letter bit, shown at left, differs from a straight bit, at right, because it has radiused edges that cut along its entire bottom.

plunge router. To get by I would tip the spinning bit of a fixed-base router into the cut. That doesn't work for the pastry stand.

When I tipped the router into the tray depression, I wound up with a tiny indentation at the tip-in spot. A plunge router gets you around this problem because it lowers the bit straight down, making indentations a thing of the past.

Also, to rout each tray, I had to hold the router's bushing against the edge of the depression as I tipped in the router and started the cut. Any hesitation in the movement of the router resulted in burning. With a fixed-base router I felt like I needed three arms and the eye-hand coordination of Michael Jordan.

Again, a plunge router gave me control over this situation. In one easy motion I held the bushing against the edge, plunged down the router, and started the cut without hesitation or burning.

### Accurate template work requires careful cutting and sanding

To rout a perfect circle, you need a template that's perfectly circular. Any unevenness in the edge of the template will transfer to the workpiece.

To get a good template, I first mark the pattern with a sharp pencil (a mechanical model works great). You just can't work to exacting tolerances with a dull pencil that makes fat lines. Then, I cut just up to, but not into, the marked line. Doing that leaves me some extra material so I can sneak up to the line precisely with a sanding drum on the concave surfaces of the pastry-stand templates. On convex surfaces, use a disc or belt sander. 🪚

Photographs: Hetherington Photography





**Top Shop Tip winner Scott Zerr demonstrates his woodworking philosophy with daughters Maggie and Rena.**



**For sending this issue's Top Shop Tip, Scott Zerr will receive a Ryobi BT3000SX benchtop table-saw. Thanks a lot, Scott!**

When he's at work in the U.S. Navy's Fleet Technical Support Center, Scott Zerr is all business. But when our Top Shop Tip winner gets home, he operates on what he calls the "family philosophy" of woodworking: "I build things we need for the house and for the kids," he says.

Scott figures he can build a piece of furniture that would cost \$1,000 for about \$200 in materials, and still have enough money left to buy a new tool or two. He also says that his wife, Mimi, doesn't complain. "I tell her it could be worse—I could take up golf," he jokes.

Just as another golfer can give you tips to improve your skills on the course, you can help your fellow woodworkers sharpen their skills in the shop. Send your best tips and tricks to us, and we'll send back \$75 for each one we print. And, if we think your tip is the best of the issue, you'll also win a tool prize worth at least \$250. Be sure you include your daytime telephone number and a photo or drawing of your tip when you mail it to us at:

**Tips From Your Shop (and Ours)**

**WOOD® Magazine**  
1716 Locust St., GA-310  
Des Moines, IA 50309-3023

Or, post your idea on our **WOODMALL®** Top Shop Tip discussion group at [www.woodmall.com](http://www.woodmall.com). Sorry, but we can't return your mailed submissions. And, because we try to print only original tips, please send your ideas only to **WOOD** magazine. Thanks!

*Dave Campbell*  
WOODWORKING PRODUCTS EDITOR



**Hooked on efficient dust bags**

The aftermarket fine filter bag I put on my dust collector doesn't have a built-in cinch strap, so keeping it in place while reinstalling the band clamp is a four-handed job (and not one of my wife's favorites). So I attached short strips of pressure-sensitive hook-and-loop fastener around the outside of the collector's rim and the inside of the bag. The fasteners hold the bag in place until I can tighten the band clamp.

—Scott Zerr, Virginia Beach, Va.

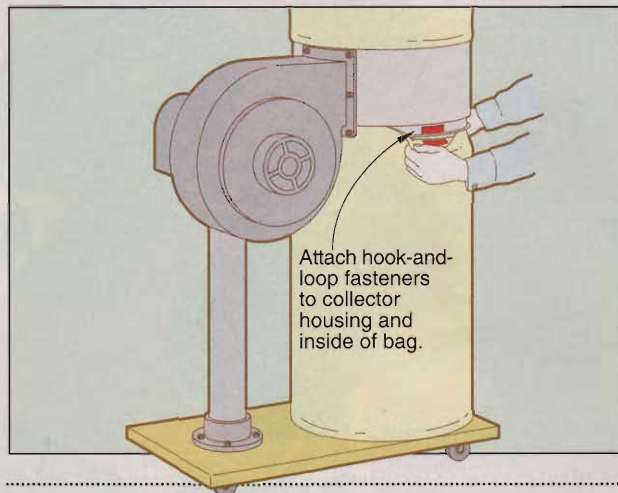

Attach hook-and-loop fasteners to collector housing and inside of bag.

**Fragile frame solution: Another fine mesh**

I recently made a poster frame from inexpensive pine molding, but worried that glue alone wouldn't make a strong miter joint. And, nails just split the molding. While pondering the problem at work one day, I found a scrap of fine wire mesh, cut and folded it as shown *below*, and embedded it in yellow woodworking glue over the joint. It worked quite well, but might work even better in a bed of epoxy or polyurethane glue.

—Dave Gugino, Wyoming, Mich.

*Editor's note: McMaster-Carr (630/833-0300, or [www.mcmaster.com](http://www.mcmaster.com)) sells 12"-square sheets of stainless steel woven-wire cloth for about \$14 per sheet. Ask for part #9230T549.*

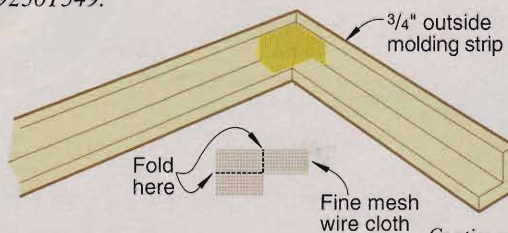

*Continued on page 30*

Continued from page 28

**CRAFTSMAN**

**PROFESSIONAL**

## 2-STAGE TECHNOLOGY BLASTS THROUGH THE BOUNDARIES

Craftsman Professional 175-max PSI 2-stage compressor produces higher pressure ranges more efficiently than single stage models. Air is compressed in a large bored cylinder and cooled. It's then compressed a second time in a smaller cylinder to achieve the maximum amount of pressure.

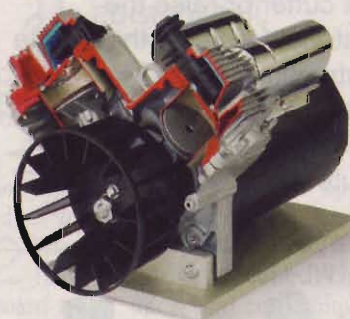

### Check out the Craftsman two-stage advantage

	20-gal. two-stage compressor	60-gal. oil-free compressor	60-gal. oilless compressor
PSI range	145-175	90-135	90-135
Power source	120-V 15amp	240-V 15amp	240-V 15amp
Requires special wiring?	No	Yes	Yes
Portable?	Yes	No	No
Runs 30% quieter than standard compressors	Yes	No	No
Pump design	2-stage	1-stage	1-stage
Maintenance	Very little	Very little	Very frequent
Continuous operation of air tools	Yes	Yes	Yes
Item #	#16777	#16650	#18416

**SEARS**

THE GOOD LIFE  
AT A GREAT PRICE  
GUARANTEED<sup>SM</sup>

## Stop, drop, and roller stands

In my shop, I frequently have to readjust the height of my roller stands to level them with various tools. To set them quickly, I made "stops" to suit each tool height. After setting the height for, say, my tablesaw, I drilled a hole in the adjustable post just above where it enters the sleeve, and labeled that hole "TS" (for tablesaw).

Likewise, I drilled and labeled holes for my router table and miter saw. Now when I need to set the roller stand to height for a tool, I simply slip a pin in the correct hole, lower the post until the pin rests on the sleeve, and tighten the post in place.

—Phil Peterson (from the WOOD ONLINE® Top Shop Tip discussion group)

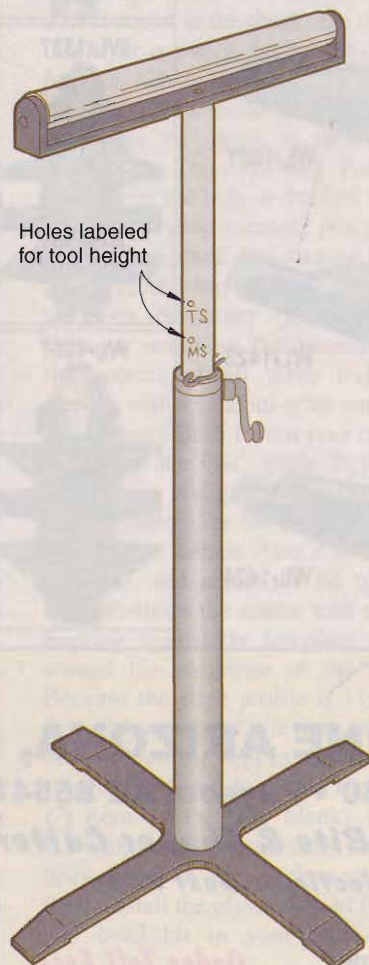

## No more false (smoke) alarms

We all know smoke detectors are important items for protecting your home (and life). But how can you install one in a workshop without getting a lot of false alarms? Here's a solution.

Obtain a standard 120-volt AC relay from your local electrical supply house. You'll need one that has one normally closed (NC) contact. I prefer small cube relays with plug-in bases.

Wire the relay as shown in the schematic below. Turning on the lights energizes the relay coil (CR). Since the contacts are normally closed, they will open, leaving the smoke detector without power. When you turn the lights out, you power up the detector so it'll let you know if sawdust or some other flammable material catches fire.

I also like detectors that can be wired to one another so that one in your house will go off when the one in the shop does. You may need an electrician's help with this project, but I believe it's worth the effort.

—Robert Swab, Harrisonburg, Va.

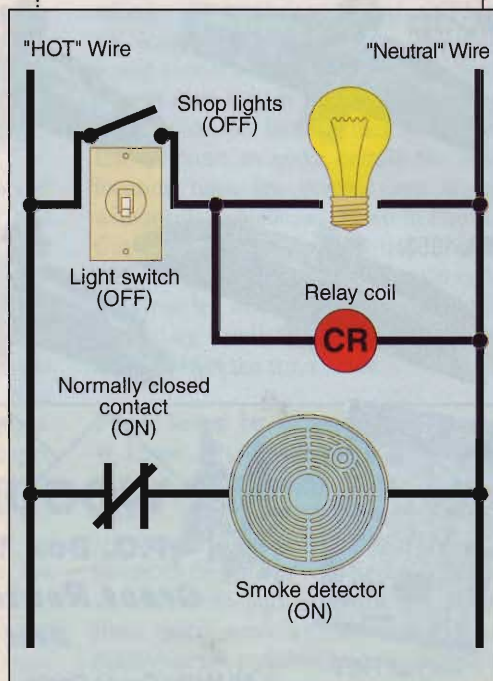

Continued on page 32

Continued from page 30

## Tenons, anyone?

Recently, I had to put round tenons on the ends of several square chair stretchers. To complicate the operation, the stretchers had to fit into legs that splayed 10°. Here's the solution I came up with.

Build the jig, at *right*, out of 1/2" plywood, making sure the sides are perpendicular with each other and the top. Don't bore the template hole yet. Attach a clamping block with a carriage bolt and wing nut to the jig where shown. (For angled tenons, I also affixed a wedge that matches the splay angle of the chair leg, as shown in the inset drawing.)

On the first stretcher, lay out the tenon, then clamp it into the jig, transferring the tenon centerlines to the bottom of the jig. Remove the stretcher and bore a small hole through the jig's top at that center mark.

To calculate the diameter of the template hole, add the diameters of the tenon, your router's guide-bushing, and router bit. Cut the hole in the top of the jig, clamp a stretcher into the jig with the clamping block, then rout the tenon to length, making progressively deeper cuts.

—Tom DelVecchio, Jamestown, N.C.

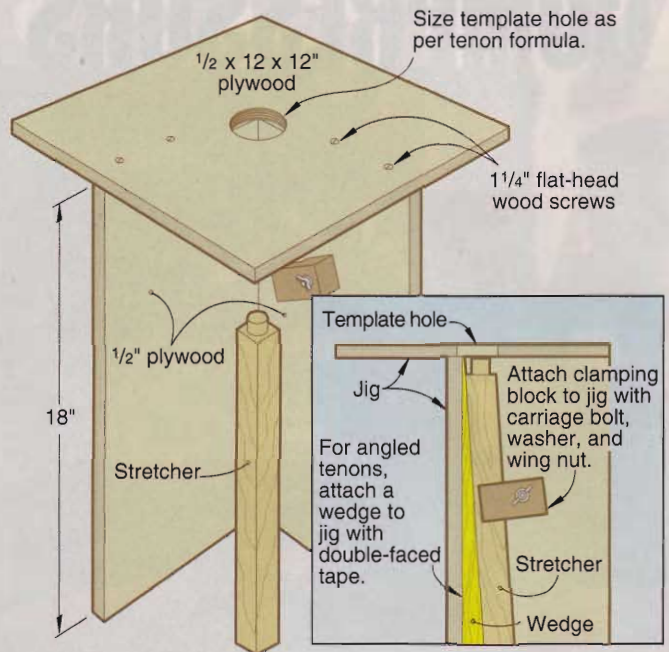

Continued on page 34

[www.internationaltool.com](http://www.internationaltool.com)

### Online Catalog

- Guru's Latest & Greatest
- Request FREE Catalog
- Guru Tip of the Month
- Ask the Tool Guru
- F.A.Q.'s
- Map & Directions
- Related Links

### Contact Information

(954) 792-4403 or  
**1-800-338-3384**  
toll free in the  
United States  
fax (954) 792-3560  
2590 Davie Road,  
Davie, FL USA 33317

General Information:  
[info@internationaltool.com](mailto:info@internationaltool.com)  
Contact Webmaster

## INTERNATIONAL



## CORPORATION

International Tool has been  
serving both the contractor,  
woodworker and homeowner  
for over 30 years.

**\$WEEKLY\$**  
**Specials**  
CLICK HERE

Check out the  
Weekly **BLOWOUTS!**

**Click for 100's  
of online deals!**

**FREE FREIGHT**  
on most orders over \$50.00  
within the contiguous 48 states!

**Guaranteed Lowest  
Prices!**

On the finest quality industrial  
power tools & machinery

### Find specials such as:

#### DA250

15 ga. 2 1/2" Angle  
Finish Nailer Kit

**\$179.00**



#### Pro Finish Kit

15 ga. 2 1/2" Finish  
nailer, 18 ga. 2" Brad  
Nailer, 9 boxes nails, and  
case

**\$199.95**



#### EYC003

12V Saw & 15.6V Drill  
with 3 batteries,  
charger & case

**\$269.00**



### PORTER-CABLE



### Panasonic

Fax (954) 792-3560

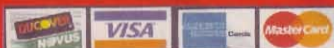

**1-800-338-3384**

2590 Davie Road, Davie, Florida 33317

Circle No. 49

ALL CHECKS WILL BE HELD 10 BUSINESS DAYS

Continued from page 32

## Rookie cabinetmaker teaches a nifty biscuit joiner trick

In my first attempt at cabinetmaking, I wanted to use biscuits to secure the corner blocks in the bathroom vanity I made for my wife. But the blocks were too small to clamp to the bench while I plunged with my biscuit joiner. After a

bit of head-scratching, I finally decided that if I couldn't clamp the workpiece to the bench, I'd clamp it to the tool.

After attaching the block to the jointer's fence, as shown in the drawing below, I used clamps to temporarily

mount the jointer to my benchtop. Then I just pulled the trigger and plunged. Since that experiment, I have tried the process with pieces both smaller and thinner with unqualified success.

—Jim Culler, Bellville, Ohio

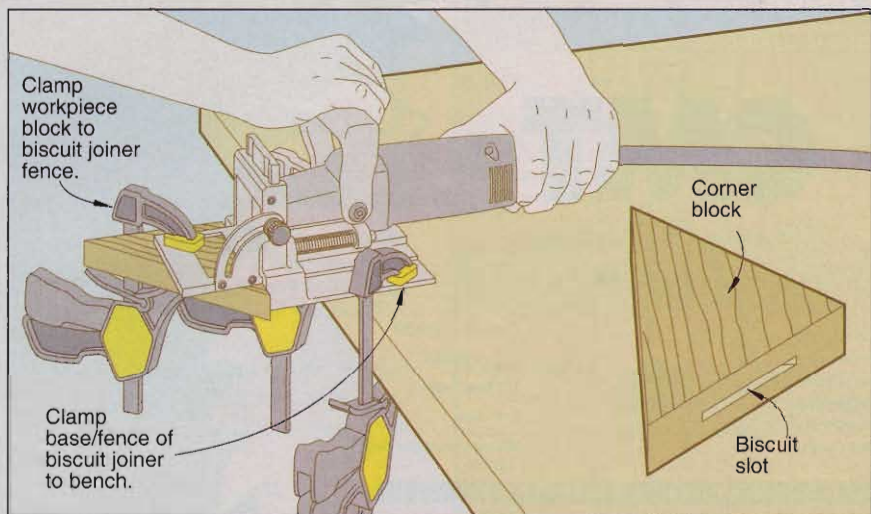

## A few more tips from our woodworking pros

• If you're looking for a material that adds durability and visual interest to your outdoor projects, try using copper. Learn more about cutting and bending this beautiful soft metal in the Cupola project on page 49.

• Tired of cutting a 1/4" dado for plywood that's not really 1/4" thick? Our dado jig for routers, on page 84, eliminates the guesswork for perfect-width dados every time. 🌲

# Laguna Tools Band Saw Now Only \$995\*

No more excuses, you will never have a better time to purchase a Laguna Tools LT16 band saw. Due to the high volume of band saws that we sell, we can now give you the best band-saw value in the market. Manufactured in Italy exclusively for Laguna Tools, this powerful, swift piece of Italian ingenuity has high-quality, performance and your name written all over it.

Don't wait. Call today to get your free demonstration video.

- 12" resaw capability
- Easy blade change with 1/16 to 1" blade capacity
- 1.5 HP motor
- All-welded steel frame construction
- Cast-iron flywheels with snap on rubber tires
- Electrostatically balanced
- Large 16" x 19" cast iron table
- Cast-iron rip fence
- 3/8" x 3/4" miter gage slot
- Two dust ports for excellent dust collection
- Blade tension indicator
- Table tilt from -10 to 45 degrees. Steel trunions
- Bearing Euro guides, both upper and lower
- Mobility kit, power feeder and 110-volt motor available

\*Excludes sales tax and freight

**LAGUNA TOOLS**

You Build With Wood, We Build With Trust.

Circle No. 615

800-234-1976

E Mail: lagunatools@earthlink.net Web: www.lagunatools.com

2265 Laguna Canyon Rd., Laguna Beach, CA 92651 (949) 494-7006 • FX (949) 497-1346  
100 Central Ave., South Kearny, New Jersey 07032 (973) 491-0102 • FX (973) 491-0591



# Yellow Birch

## the busiest tree in the family

Although not as showy as its gleaming white cousin, the paper birch, yellow birch is the hardest-working member of the *betula* family of trees. From the earliest days of the American colonies, northern shipbuilders sought its strong wood for parts intended for submersion. In the 19th-century logging camps of the Maine woods, yellow birch was used for ox yokes. Even wheelwrights preferred it for hubs because the tough stock wouldn't crack. When school desks were primarily wooden, it was yellow birch that went into them. Then as now, the wood also became furniture, cabinets, interior trim, and even finely figured veneer for exquisite architectural paneling. Today, the vast majority of yellow birch

becomes flooring, a duty shared with maple in northern states. Yellow birch grows to its greatest size in a range from eastern Canada and New England west through the Great Lakes States to northern Minnesota. In ideal conditions, it attains 100' heights and diameters of 3'. Where yellow birch follows the Allegheny and Appalachian mountain ranges, it's a smaller tree. Remarkably, the seeds of yellow birch have the tendency to sprout in the tiniest speck of loam. That's why it's not uncommon to find a lofty yellow birch growing atop a rock, its roots straddling it on their way into the ground. Sometimes under the still-stiff bark, decay has killed the wood. But dried, the punky wood makes great tinder. ♣



Seeds of yellow birch can sprout in a rock crevice, and the tree eventually will grow around the rock.

## Econ-Abrasives

WE MAKE ABRASIVE BELTS ANY SIZE, ANY GRIT!

<p><b>Standard Abrasive Sheets</b></p> <p style="text-align: center; border-bottom: 1px solid black; font-weight: bold; font-size: small;">CABINET PAPER</p> <table border="0" style="width: 100%; font-size: x-small;"> <tr> <td></td> <td style="text-align: center;">50/pk</td> <td style="text-align: center;">100/pk</td> </tr> <tr> <td>60D</td> <td style="text-align: right;">\$17.58</td> <td style="text-align: right;">\$31.58C</td> </tr> <tr> <td>80D</td> <td style="text-align: right;">\$16.42</td> <td style="text-align: right;">\$29.26C</td> </tr> <tr> <td>100 thru 150C</td> <td style="text-align: right;">\$15.26</td> <td style="text-align: right;">\$26.95C</td> </tr> </table> <p style="text-align: center; border-bottom: 1px solid black; font-weight: bold; font-size: small;">FINISHING PAPER</p> <table border="0" style="width: 100%; font-size: x-small;"> <tr> <td>80A</td> <td style="text-align: right;">\$11.74</td> <td style="text-align: right;">\$19.89C</td> </tr> <tr> <td>100 thru 280A</td> <td style="text-align: right;">\$10.50</td> <td style="text-align: right;">\$17.58C</td> </tr> </table> <p style="text-align: center; border-bottom: 1px solid black; font-weight: bold; font-size: small;">NO LOAD PAPER(white)</p> <table border="0" style="width: 100%; font-size: x-small;"> <tr> <td>100 thru 400A</td> <td style="text-align: right;">\$12.90</td> <td style="text-align: right;">\$22.40C</td> </tr> </table> <p style="text-align: center; font-size: x-small;">"C" = 100 SHEETS</p> <p style="text-align: center; font-size: x-small; border-bottom: 1px solid black;">Velcro® Vacuum Discs</p> <p style="text-align: center; font-size: x-small; border-bottom: 1px solid black;">8 Hole pattern for Bosch sanders</p> <table border="0" style="width: 100%; font-size: x-small;"> <tr> <th style="text-align: left;">Dia.</th> <th style="text-align: left;">Grit</th> <th style="text-align: left;">Price</th> </tr> <tr> <td>5"</td> <td>60</td> <td style="text-align: right;">\$.48 ea</td> </tr> <tr> <td>5"</td> <td>80</td> <td style="text-align: right;">.46</td> </tr> <tr> <td>5"</td> <td>100 thru 320</td> <td style="text-align: right;">.45</td> </tr> </table> <p style="text-align: center; font-weight: bold; font-size: x-small;">* Available in 5 hole pattern *</p> <p style="font-size: x-small;">*Wide Belts*Rolls*Flap Wheels *Pump Sleeves*PSA Discs *Router &amp; Wood Bits*Wood Glue</p>		50/pk	100/pk	60D	\$17.58	\$31.58C	80D	\$16.42	\$29.26C	100 thru 150C	\$15.26	\$26.95C	80A	\$11.74	\$19.89C	100 thru 280A	\$10.50	\$17.58C	100 thru 400A	\$12.90	\$22.40C	Dia.	Grit	Price	5"	60	\$.48 ea	5"	80	.46	5"	100 thru 320	.45	<p style="text-align: center; border-bottom: 1px solid black; font-weight: bold; font-size: small;">ABRASIVE BELTS</p> <p style="font-size: x-small;">Belts are resin bond cloth with a bi-directional splice, specify grits.</p> <table border="0" style="width: 100%; font-size: x-small;"> <tr> <td>1X30</td> <td style="text-align: right;">\$.81 ea</td> <td>3X24</td> <td style="text-align: right;">\$.93 ea</td> </tr> <tr> <td>1X42</td> <td style="text-align: right;">.81 ea</td> <td>3X27</td> <td style="text-align: right;">.96 ea</td> </tr> <tr> <td>1X44</td> <td style="text-align: right;">.81 ea</td> <td>4X21 3/4</td> <td style="text-align: right;">1.06 ea</td> </tr> <tr> <td>2 1/2X16</td> <td style="text-align: right;">.85 ea</td> <td>4X24</td> <td style="text-align: right;">1.10 ea</td> </tr> <tr> <td>3X18</td> <td style="text-align: right;">.86 ea</td> <td>4X36</td> <td style="text-align: right;">1.35 ea</td> </tr> <tr> <td>3X21</td> <td style="text-align: right;">.90 ea</td> <td>6X48</td> <td style="text-align: right;">3.50 ea</td> </tr> <tr> <td>3X23 3/4</td> <td style="text-align: right;">.93 ea</td> <td>6x89</td> <td style="text-align: right;">6.24 ea</td> </tr> </table> <p style="text-align: center; border-bottom: 1px solid black; font-weight: bold; font-size: x-small;">OTHER SIZES ON REQUEST</p> <p style="text-align: center; border-bottom: 1px solid black; font-weight: bold; font-size: x-small;">HEAVY DUTY SPRING CLAMPS</p> <p style="font-size: x-small;">Clamps come w/PVC tips and grips.</p> <table border="0" style="width: 100%; font-size: x-small;"> <tr> <td style="text-align: center;"></td> <th style="text-align: left;">Size</th> <th style="text-align: left;">Price</th> </tr> <tr> <td></td> <td>4"</td> <td style="text-align: right;">\$1.75 ea</td> </tr> <tr> <td></td> <td>6"</td> <td style="text-align: right;">2.25</td> </tr> <tr> <td></td> <td>8"</td> <td style="text-align: right;">3.50</td> </tr> </table> <p style="text-align: center; border-bottom: 1px solid black; font-weight: bold; font-size: x-small;">JUMBO ROUTER PAD(24" x 36")</p> <p style="font-size: x-small;">It will not allow small blocks of wood to slip out under router or sanding applications. ROUTER PAD ONLY \$8.95ea.</p> <p style="text-align: center; border-bottom: 1px solid black; font-weight: bold; font-size: x-small;">JUMBO BELT CLEANING STICK</p> <p style="text-align: center; font-weight: bold; font-size: x-small;">ONLY \$8.80</p>	1X30	\$.81 ea	3X24	\$.93 ea	1X42	.81 ea	3X27	.96 ea	1X44	.81 ea	4X21 3/4	1.06 ea	2 1/2X16	.85 ea	4X24	1.10 ea	3X18	.86 ea	4X36	1.35 ea	3X21	.90 ea	6X48	3.50 ea	3X23 3/4	.93 ea	6x89	6.24 ea		Size	Price		4"	\$1.75 ea		6"	2.25		8"	3.50
	50/pk	100/pk																																																																								
60D	\$17.58	\$31.58C																																																																								
80D	\$16.42	\$29.26C																																																																								
100 thru 150C	\$15.26	\$26.95C																																																																								
80A	\$11.74	\$19.89C																																																																								
100 thru 280A	\$10.50	\$17.58C																																																																								
100 thru 400A	\$12.90	\$22.40C																																																																								
Dia.	Grit	Price																																																																								
5"	60	\$.48 ea																																																																								
5"	80	.46																																																																								
5"	100 thru 320	.45																																																																								
1X30	\$.81 ea	3X24	\$.93 ea																																																																							
1X42	.81 ea	3X27	.96 ea																																																																							
1X44	.81 ea	4X21 3/4	1.06 ea																																																																							
2 1/2X16	.85 ea	4X24	1.10 ea																																																																							
3X18	.86 ea	4X36	1.35 ea																																																																							
3X21	.90 ea	6X48	3.50 ea																																																																							
3X23 3/4	.93 ea	6x89	6.24 ea																																																																							
	Size	Price																																																																								
	4"	\$1.75 ea																																																																								
	6"	2.25																																																																								
	8"	3.50																																																																								

Econ-Abrasives

P. O. Box W1628  
Frisco, TX 75034  
(972)377-9779

\*MasterCard, VISA, Discover, Am. Express  
\*SATISFACTION GUARANTEED!!!  
\*CALL FOR FREE CATALOG  
-TX add appropriate sales tax  
-Call for shipping charges

TOLL-FREE ORDERING LINE (800)367-4101

## No Matter How You Cut It, These Tenryu Blades Are Winning Combos

Tenryu Gold Medal 10" x 40t and Rapid-Cut 10" x 50t blades give you splinter-free cuts in all woods—even chip-free cuts in melamine. Both feature extra hard carbide teeth that stay sharp longer, even when cutting abrasive materials.

*Gold Medal: "A top performer offering a very smooth cut edge and glass-smooth feeding"..."the quietest-cutting blade in our test"*

*Rapid-Cut: "The smoothest cutting of all the ATB/R blades tested" —WOOD Magazine, February 2000*

For exceptionally clean and accurate cross, rip and miter cuts in all woods, ask for Tenryu Gold Medal or Tenryu Rapid-Cut blades at your favorite dealer.

Making quality saw blades since 1910

## TENRYU

4301 Woodland Park Dr., Ste. 104 West Melbourne, FL 32904  
1-800-951-SAWS • 407-951-2400 • Fax: 407-951-2250 • www.tenryu.com

TENRYU  
RAPID-CUT

# woodworking hall of fame

presenting the inductees for the year 2000

The nine inaugural members in the Woodworking Hall of Fame were introduced in the November 1997 issue of *WOOD* magazine. Two more well-deserving individuals received the honor in 1998, and still another two in 1999. Now read about the honorees of the new millennium.



## Bob Flexner

(1940-) For education in wood finishing



Author and master wood finisher Bob Flexner has spent more than 25 years taking finishes off furniture as well as putting them on. As a young man, he worked for some time in a cabinet shop in Denmark. When he returned to the United States in 1976, Flexner set up his own furniture restoration shop, which he still operates today.

In the mid-1980s Flexner, although quite expert at the finishing techniques he had learned from experience, became more and more curious about finishes' chemical nature. This curiosity first led him to university libraries. Without education in chemistry or engineering, he found the information that he gathered difficult to fully comprehend. But he pressed on.

To further understand the materials and reactions of finishes and their compounds, he joined the Federation of Societies for Coatings Technology. He learned from the members, most of whom are paint and finish chemists, at meetings and seminars. What he learned he applied in his shop and gradually began understanding the chemistry of finishing.

Flexner also started wondering why no one before had set out to span the gap between the finishing chemists and the finishers. That thought was the beginning of his informative 1994 book *Understanding Wood Finishing*, which took six years to research and write. The easy to read and understand book now rates among woodworkers as the definitive work on the subject. And despite that impressive accomplishment, Flexner still strives to help woodworkers lift the shroud of mystery that most attach to finishing.

In addition to his finishing book, Flexner has produced a video on furniture repair. He also is editor of *Professional Refinishing* magazine and a regular contributor and consultant to woodworking periodicals. As today's top finishing expert, he frequently appears at seminars and workshops. Flexner and his wife, Birthe, make their home in Norman, Oklahoma.



Bob Flexner takes apart a chair for regluing and refinishing in his Oklahoma furniture restoration shop that he's operated for nearly 25 years.

## Past Inductees

### Furniture design and craftsmanship:

Wharton Esherick (1997)  
Gustav Stickley (1997)  
Samuel S. Maloof (1998)  
George Nakashima (1999)

### Forestry:

Gifford Pinchot (1997)

### Carving:

Lemuel and Stephen Ward (1997)

### Turning:

Frank Knox (1997)  
Rude Osolnik (1997)

### Marquetry:

Silas Kopf (1997)

### Intarsia:

Judy Gale Roberts (1997)

### Tool design and development:

Alonzo G. Decker, Jr. (1997)

### Woodworking promotion:

Norm Abram (1998)

### Education in woodworking:

R.J. DeCristoforo (1999)

For more about the hall of fame members, visit  
[www.woodmagazine.com/hallfame/](http://www.woodmagazine.com/hallfame/)

Continued

## R. Bruce Hoadley

(1933-) For education in wood technology

### how we choose our candidates

To be considered for induction into *WOOD*® Magazine's Woodworking Hall of Fame, candidates must meet the following set of criteria:

- Have made (need not be living) or is making a significant impact in the North American woodworking field through one (or more) of the following areas—design, craftsmanship, education, research, product development, or public service on a regional or national level.
- Have made or is making their contribution(s) in the most recent or current century.

A selection committee made up of *WOOD* magazine staffs annually gathers the nominees from our staff and readers and votes in the year's inductees. Names are announced in the September issue. To submit a candidate for nomination, send a short biography of the person, along with a statement indicating his or her accomplishments to:

*WOOD* magazine's  
Woodworking Hall of Fame,  
1716 Locust St., GA310,  
Des Moines, IA 50309-3023.

Photographs: Flexner, Birthe  
Flexner, Bob Hawks;  
Hoadley, Randy O'Rourke

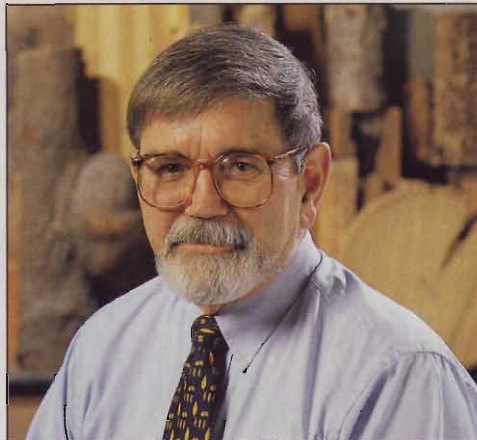

A professor of wood technology at the University of Massachusetts at Amherst since 1962, R. Bruce Hoadley, who holds a doctorate in the subject, teaches students about wood anatomy, its properties, and wood-processing. His ongoing academic research continues to involve wood identification as well as wood moisture relationships as they relate to dimensional change. But to woodworkers everywhere, R. Bruce Hoadley is best known for authoring the landmark book *Understanding Wood, a craftsman's guide to wood technology*, first published in 1980 by The Taunton Press and with several subsequent printings.

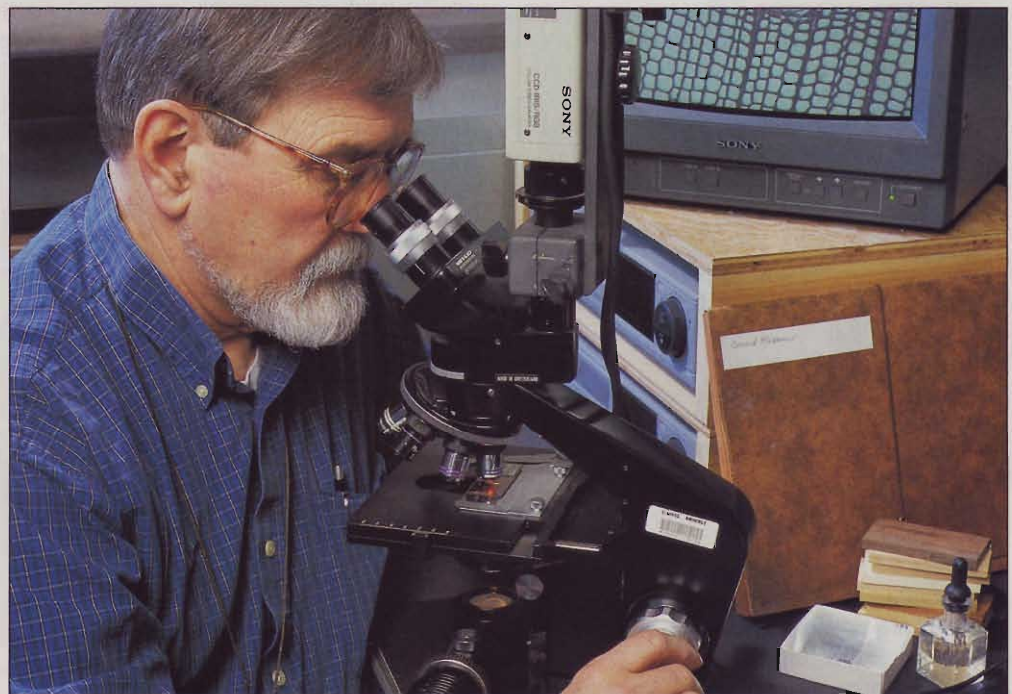

In the University of Massachusetts' wood technology lab, Bruce Hoadley studies wood samples.

The 265-page volume presents the often technical information about everything from how trees grow to how wood is modified in terms the woodworker can understand and translate to his or her work. His stated purpose was to answer all the many questions posed to him through the years by students in craft workshops, courses, and seminars. In short, he wanted to interpret the wealth of scientific knowledge about trees and wood. In doing so, he also debunked many of the misconceptions about wood.

With a continuing fascination for wood that goes back to childhood and early woodworking experiments, Hoadley produced another book in 1990. In *Identifying Wood, accurate results with simple tools* (The Taunton Press), he provides an in-depth, systematic method for identifying wood species and an overview of the complete identification process.

An accomplished educator, researcher, and author in the wood-technology field, R. Bruce Hoadley often plays a detective's role. As a consultant, he has identified the woods in the U.S. Department of State's furniture collection and served as a forensic expert in civil and criminal cases. Hoadley also contributes to woodworking publications and conducts an annual wood identification workshop. He lives near Amherst with his wife Barbara. ♣

# rustic-furniture basics



**R**ustic furniture has had its niche in woodworking since man first sat down on a fallen tree. Today, you'll find samples gracing log homes as well as metropolitan apartments—anywhere country reigns. And unlike carefully machined furniture, crafting the rustic variety requires working with the shapes that Mother Nature provides—and they're free.

Part of the fun of building rustic furniture is trying to imagine what the finished piece will look like. In the photo at *left*, Arkansas craftsman Greg Mitchell arranges and rearranges peeled dogwood and bark-on maple branches that will become legs for a small side table.

*Continued*



## rustic furniture



Greg Mitchell takes a break on the porch of his Fayetteville, Arkansas, shop. His hand rests on the back of one of his more formal country creations. Note drying wood behind.

### Meet Greg Mitchell

With its many hills and tree-studded neighborhoods, Fayetteville, Arkansas, suits furnituremaker Greg Mitchell just fine. “I could probably find all the wood I need within a three-block area from our house,” he says. “Nobody wants branches lying around. And they always are pruning for power lines, plus storms that blow over trees and knock down branches. There’s an endless supply. And if I have to cut fresh ones, there’s a vacant wooded lot right down the street.”

At 50, Greg’s a tree person through and through. He has always been one, even while growing up in the San Francisco Bay area. Couple that with his love of tools and tinkering, and you get a very special brand of woodworker. “All through my early twenties, when I lived in Vermont, I had a shop and was accumulating tools,” he recalls.

Back then, Greg built small pieces of furniture just for fun. It wasn’t until after he had been in business for awhile

as a cartographer that he finally could focus on crafting the rustic. “I’d been working for about eight years in Fayetteville with two partners creating software atlases. Then we were bought out,” he explains. “I didn’t want to move to Massachusetts with the new company. And at that point—in 1995—I had money in the bank. So I thought I might as well start building rustic furniture—then or never!”

Without any formal woodworking training, Greg jumped in cold turkey. “I had to start from square one: insulate my shop, run sufficient power to it, and buy a bandsaw, planer, jointer, and routers to go with my tablesaw and hand tools. Then I needed to build drying sheds for the wood.”

Greg now crafts about 100 pieces of furniture a year, and sells them through his website ([www.legendaryfurniture.com](http://www.legendaryfurniture.com)), at regional crafts fairs, and through several galleries. And he’s having a wonderful time doing it, too.

Rustic furniture—tied to the American Arts and Crafts movement and widely popular as furnishings in the great Adirondack lodges of the 1920s and 1930s—undergoes a revival today in the country look. From the mountains of Idaho to the wilds of Maine, and from the Texas plains to the ridge tops of North Carolina, you’ll find rustic furniture of all varieties. There are sturdy straight-lined chairs of bark-on saplings, sofas and loveseats of bent willow, tables of twigs, desks of driftwood, and accessories decorated with birch bark.

The style’s newfound presence may be due to the public’s growing appreciation of nature. No other furniture style draws so much from it and in turn reflects it. Too, there’s a simpleness to rustic furniture shared with the pieces of Gustav Stickley that came to be acclaimed as mission. But with rustic, natural forms become functional objects for the home.

No matter the reasons, the number of people who make (and buy) rustic work continues to grow. And depending on what type you want to create, you’ll discover that rustic furniture is relatively easy to build. Best of all, you may already have a yardful of stock!

### Nature’s variety of raw material

Woodworkers doing rustic furniture draw upon their local natural resources. If you live near large bodies of water, for instance, you might look to driftwood. City dwellers could recycle pallets. But because the Ozark Mountains of north-



Down the street from his home, Greg ponders the possibilities for a twisted sapling.



The halves of an Osage orange branch arch over a maple base in this \$500 mirror.

western Arkansas are abundantly forested with a great variety of hardwood species, Greg has lots of choices: tree branches, saplings, firewood, sawmill slabs, and “rounds” that come from crosscutting logs.

“My love of trees shows in my furniture,” says Greg. “But I’ve had to study wood identification because I try to identify all that I use. One time at a crafts fair, I counted 12 different species of wood in what I had on display.”

The craftsman does have his favorites, though. “I like dogwood. It’s a really hard wood, and it often has great ‘bug trails’ under the bark. A dogwood tree has a formal shape with symmetrical branching. Every type of tree has its own character, and to me, dogwood has elegance,” he comments.

“On the other hand, I like the twisty gnarliness of oak—it’s down-home rustic,” Greg continues. “Sycamore I’d call leggy, somewhere between dogwood and oak. Then there’s linden [basswood], the elms, maple, and cherry—with bark on and off. I’ve used some woods from other places, like mountain laurel from North Carolina that a man brought to me. And redbud grows everywhere here, but it proves marginal because it’s not very strong. Yet in the right place—such as a mirror frame—it’ll work. Bois d’arc [Osage orange] has heft, hardness, and a rich color that

I like. I don’t use many softwoods, though, except cedar. I’ve used pine for tops, but never pine-tree branches.”

### To get wood, branch out

Greg prefers collecting his wood in the winter because, with the leaves down, he can better see the shapes of the branches. And natural shape is an important aspect of making rustic furniture because you work with what you get. What shape best suits a chair arm, table base, or a stool leg? It takes some imagination.

Too, winter is the best time to cut branches on which you want to leave the bark. With little or no sap between the bark and the wood, the bark tends to cling. “If I want to take off the bark from a piece that was cut in winter, it would easily require half a day,” Greg says. “And the wood will be full of nicks from the knife or scraper. So if the bark is on a piece—and it wants to remain on—I don’t attempt to take it off.”

On the other hand, bark slips or peels with little effort from branches harvested in the spring and summer, especially maple, hickory, and basswood. The presence of any sap prevents the bark from bonding to the wood.

Although Greg sees in his mind’s eye the potential use for a particular branch or piece of wood, he doesn’t cut or select it for a specific piece of furniture because it first has to dry. “I dry all my wood under covered sheds,” he notes. “Small branches up to about ½” in diameter may only take a few months, while a stick 2” in diameter takes a year, unless it’s a very dense wood like bois d’arc. I also use a small dry-kiln, but it’s primarily for thick pieces and to kill bugs.

“You can tell when wood is dry by rapping pieces together. If they make a sharp snapping sound, they’re probably dry,” he continues. “But I check my wood with a moisture meter, too.”

Why does Greg care how dry the wood is when his furniture is rustic anyway? Basically, because green wood made into a tenon will shrink and loosen in the mortise, even if glued, and come loose. But the piece that’s mortised can be a bit green because it will shrink tighter around the tenon as it dries.

*Continued*

## Greg lines up his tools to build a rustic table

Greg Mitchell used these essential tools for the rustic table project you’ll see him build in this article (alternatives given in parentheses):

- Pruning saw (pruning shears)
- Flush-trimming saw
- ¾” electric drill
- ⅝” Forstner bit (spade bit

would do)

- ⅝” Veritas tenon cutter; about \$50, from Lee Valley Tools, 800/871-8158. (Tenons also can be made with plug cutters, but they’ll leave square-shouldered tenons and you’ll have to saw off the “collar” left by the cutter.)

• Trim router and ¼” double-flute straight cutting bit. (A rotary rasp chucked into an electric drill will also work.)

- Bench vise
- Oscillating portable finish sander
- Tablesaw (to rip boards for top)
- Jointer (to edge boards for top and flatten base)
- Bar clamps
- Bandsaw (to saw top to round)



To show you the basics of rustic furniture building, Greg Mitchell designed a simple, but dramatic, end table. Turn to the photos on the following pages to see how it goes together.

# Greg builds a rustic table



## 1 Start with material selection

From one of the several drying sheds surrounding his shop, Greg chooses some branches that he'll insert in the base to support the solid maple top. The craftsman likes to employ branches with several forks. He believes they add more visual interest.

For a top, Greg edge-joined four pieces of  $\frac{3}{4} \times 5 \times 22$ " sugar maple, sawed it to round on the bandsaw, profiled the edge with a router, then sanded it smooth. The base is a hefty (it needs weight) split half of spalted white oak firewood with its bottom side flattened on the jointer.

Next, Greg arranges and rearranges the branches on his workbench for the right visual balance on the base. He also takes into consideration how these structural members must equally share the weight of the top, then marks their positions with a pencil.



## 2 Shape the tenons

With a  $\frac{5}{8}$ " Veritas tenon cutter chucked into his electric drill, Greg shapes a 1"-long tenon on the first branch, which he has clamped securely in the bench vise. The tenon cutter gives him a radiused shoulder, but he must be sure that the branch and the cutter are level so the tenon won't be angled. Manufactured especially for the rustic-furniture builder, the tenon cutters come in sizes from  $\frac{5}{8}$ " to 1" for most furniture applications and in larger sizes for big structural connections.



## 3 Drill the base mortises

The branches now tenoned, Greg chucks a  $\frac{5}{8}$ " Forstner bit into his electric drill, and at the workbench, first bores shallow holes at the mortise marks. "I don't want to go too deep without dry-fitting the branches to recheck their placement," he explains. "If my holes are off just a bit, no problem. I can fill the voids with epoxy."

Satisfied with the original arrangement, Greg completes the drilling. He angles each mortise as necessary to match the bend of the branches, and drills it 1" deep.



## 4 Time for some pruning

After Greg has epoxied the tenoned branches into their respective mortises on the base and allowed the adhesive to cure, he can prune them to table height. With a 17"-long wood scrap to check height, Greg goes from branch to branch with saw in hand, measuring and trimming. (He keeps several such scraps on hand, each cut to a specific length and labeled.)



## 5 Turn the table topsy-turvy

To mark the locations for the pruned branches on the underside of the top, Greg flips over the maple top and sets it on his worktable. After finding and marking its center, he turns the base upside down so that its branches rest on the top. He now can center the base.

Then, with a pencil, Greg traces around the tip of each branch where it rests on the top. If a branch has an irregular shape, the tracing reflects it.



## 6 Rout the branch sockets

Using a small trim router with a  $\frac{1}{4}$ " double-flute, straight-cutting bit, Greg carefully routs away the wood within the branch-tip outlines to a  $\frac{1}{2}$ " depth. He routs straight into the wood, even if the branch will meet the socket at an angle. "Don't try to match the angle by angling the router. It's too dangerous," he advises. When finished with the routing, each socket roughly reflects the shape and size of the branch tip that it will house. "Unlike the base mortises, which tightly fit the tenons, the sockets can fit loosely because the pool of epoxy will fill any gap," Greg notes.



## 7 Attach the top with epoxy

Donning latex gloves, Greg prepares to adhere the base to the top. At his worktable, he once again turns the base topsy-turvy onto the top's bottom side and fits each branch tip into its routed socket. Then he moves to the epoxy dispenser, and squirts equal amounts of the two-part mix into a paper cup and carefully stirs it.

"I use slow-set epoxy because of its permanence and gap-filling quality," he says as he works around the base, filling each socket with the gooey substance. "On the frame of a chair, which might have to come apart some day for part replacement, I'll use yellow woodworkers' glue. Otherwise, it's epoxy for everything I build because even though it's rustic, I'm making furniture that I hope will be around for a long, long time." 🌲

Written by **Peter J. Stephano**  
Photographs: **Don House/House Photoworks;**  
**mirror, Richard Berquist**

## A note on finishing rustic

For his furniture finish, Greg sprays on water-based exterior polyurethane. "But I usually first put on a sealer coat of dewaxed shellac, unless I think it may darken certain types of bark too much," the craftsman explains. "Sometimes I'll apply a base coat of Danish oil to give a little more color to bright, peeled wood."

# wood collecting

It's fascinating,  
informative,  
and really  
enriches your  
woodworking

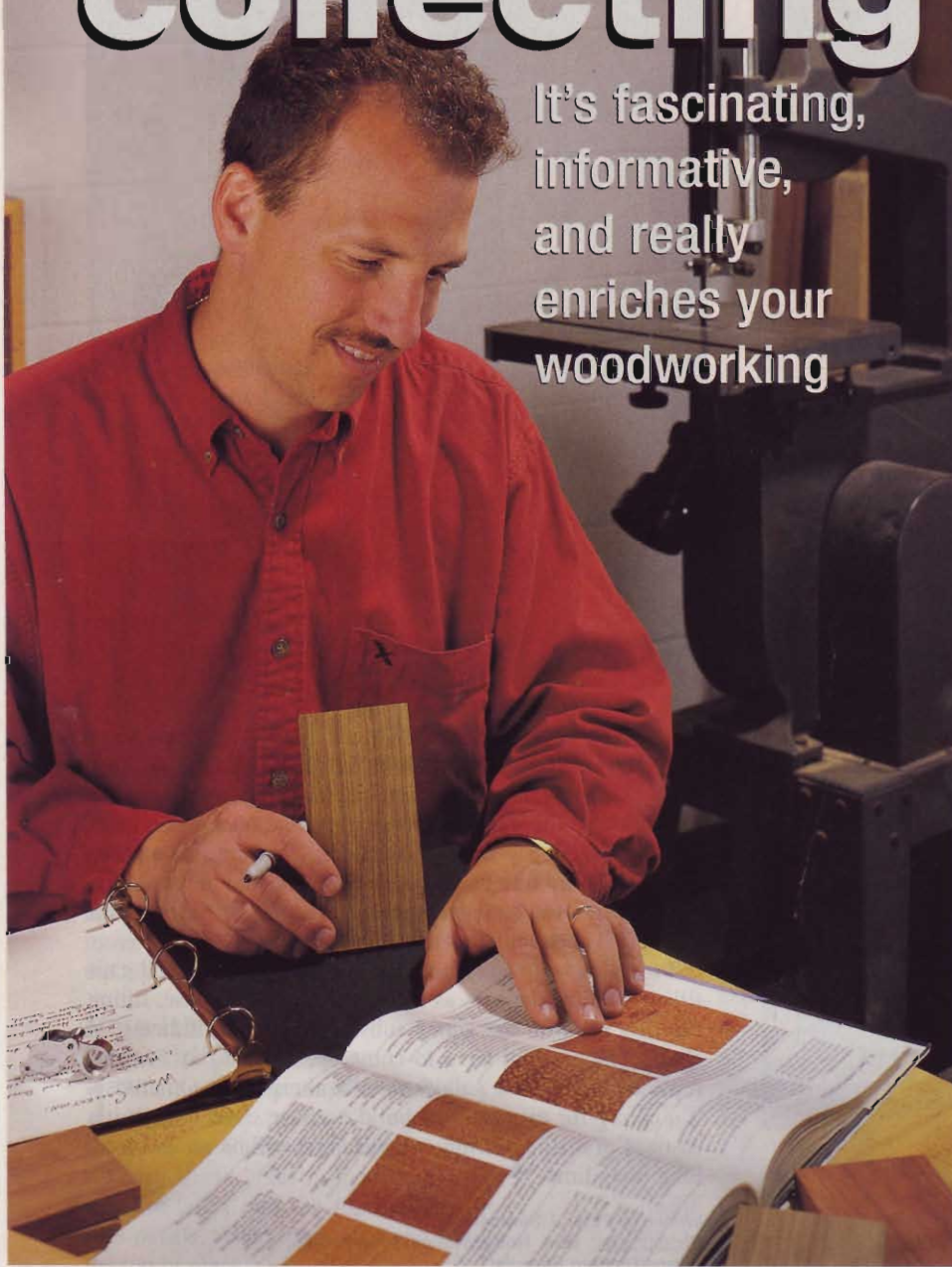

**W**ith more than 100,000 species of trees in the world, you won't tire of collecting samples of their wood. And even though you'll never get all of them, it's a lot of fun trying!

In Venezuela there's a tree that produces perhaps the world's strongest stock. One cubic foot of the oak-like wood from the poui tree may weigh up to 80 pounds! In country after country, locale after locale, you'll discover trees with odd characteristics, unique wood, and historical or mystical relevance. It's for those interesting aspects and others that thousands of people throughout the world collect

wood seriously. And most of them aren't botanists, dendrologists, or other professionals with academic or scientific motives. They do it as a hobby, strictly for enjoyment.

## Reduce wood to sample size

As a woodworker, you already have a large wood collection. However, it's probably represented by boards of numerous sizes. Wood collectors, though, generally standardize the size of their wood samples.

The International Wood Collectors Society (IWCS) advocates a standard sample size of  $\frac{1}{2} \times 3 \times 6$ ", but collections will have some samples smaller and larger than that. (Many collectors prefer to craft their wood into carvings, turnings, and other objects. See *page 48*.) When you consider that some private collections approach 4,000 wood samples from a lifetime of collecting, and many institutional collections have more than 10 times that number, you can understand why samples usually are kept small. A smaller size also facilitates shipping and handling; no small matter when wood collectors begin swapping from different corners of the earth—a common practice.

It's easy enough to reduce some of the woods you already have to sample size, then sand them smooth. (Finishing isn't usually done.) On the other hand, identifying strange trees, then collecting green wood straight from them and drying it, is a process normally reserved for the most avid or scientific collector. For instance, Alan Curtis of Eugene, Oregon, a now retired government forester/botanist and IWCS's past president, carries two pruning saws when wood hunting. Over the years, he's "field collected" more than 700 species of wood from 16 foreign countries and most of the United States. His total collection numbers well over 3,000 samples.

With the tools and lots of elbow grease, he saws out a 7"- to 28"-long section from a downed specimen that has developed heartwood. (Alan normally gathers all his wood from trees felled by construction, disease, or storms.) On his bandsaw, he cuts the wood into 2"-thick boards that he air dries. When the wood

has dried to 12% moisture content, he resaws and crosscuts it to the standard sample size.

"But I never collect wood unless I'm positive of its identification," he emphasizes. He relies on bark, leaves, flowers, fruit, and the wood, as well as reference books, to identify tree species. By and large, though, the greatest number of wood collectors satisfy themselves with already identified samples (called "known" samples) of dry, processed wood that they obtain from a great number of sources.

### Where to get collectible wood

If you had the free time and a matching bankroll, you could travel the world collecting wood. After all, there isn't a spot on the globe that doesn't support at least one type of tree.

Very few people, however, can afford to spend their entire lives traveling in search of wood. They add to their collection by buying samples and trading for them. For starters, Woodworkers Source (800/423-2450) offers a 30-piece selection of 1/2x3x6" labeled wood samples plus the four-color, 60-page *Hardwoods Selectorama* for about \$60



International Wood Collectors Society members examine piles of wood from the world over that will be sold at their annual auction.

postage paid. You also can buy a 30-sample set from Heritage Building Specialties (800/524-4184) for \$39.95. However, the pieces measure 1/4x3x6".

In addition, the IWCS makes sets of wood samples available, but only to its members. The sets contain 1/2x3x6" samples of 36 species that are chosen from a list of 72 and costs \$42 (postage paid in the U.S., for shipping elsewhere, contact the IWCS secretary/treasurer regarding cost). Read more about IWCS on the *next page*. Mail-order companies that sell exotic wood also sometimes put together "grab bags" of small pieces at reasonable prices, although the wood

may not conform to your established sample size.

As you travel, you can collect samples of local wood from retailers or sawmills, too. If you are able to locate area woodworkers, they'll probably share small pieces of their stock with you. Look for all these sources under the Yellow Pages. Yet, the best ongoing sources of interesting and exotic wood are the members of the IWCS.

### People who are real serious about wood

Founded in 1947 as a non-profit organization for the purpose of advancing

*Continued*

## How to organize your wood samples

As you begin collecting and samples start to accumulate, you'll discover that you need some way to organize them. Doing this requires a reference book on

tree species, such as *Checklist of United States' Trees*, by E.L. Little, or for the world's trees, *Nomenclature of Commercial Timbers*, by the British Standards Institution. Then, as recommended by R. Bruce Hoadley in his book *Identifying Wood*, you can group samples by genus and species within. For example:

1. *Juglans* (walnut genus)
  - 1.1 *Juglans nigra* (black walnut)
  - 1.2 *Juglans cinerea* (butternut)
  - 1.3 *Juglans major* (Arizona walnut), and so on. Either code samples right on the wood with a number that correlates to a logbook entry, or print a label with the wood's name and affix it to the back of the sample, as shown *above right*.

Because, even indoors, wood (finished or unfinished) darkens from exposure to

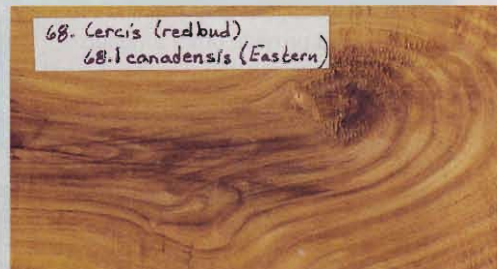

Clearly label your wood samples with their genus and species.

sunlight, wood collections normally are stored out of the light in cabinets. Easily-built wooden storage boxes, similar to 3x5" card files, or plastic trays, could house your samples. Or, as do many IWCS members, you could work your collected wood into small carvings, turned goblets, intarsia pieces, and other displayable items.



A tray of wood samples in the collection of the University of Massachusetts.

# WOOD collecting

information on wood and wood collecting, the IWCS now has more than 1,500 members in some 30 countries. And although IWCS was started with a sharp focus on academic wood collecting, it's membership now includes people from all walks of life who simply share a love for wood.

At its annual meeting, the society stages an always highly anticipated event: the wood auction. Members sell their excess foreign and domestic wood—and objects they've made from wood—to the highest bidder. You'll see such items as rare pink ivory from Africa, highly burlled examples of native woods, and crafted things like wooden belt buckles or thimbles on the auction block. Members also may exhibit their wood collections at the meeting. Of course, even if its not officially on the agenda, there's always lots of wood swapping. (On a smaller scale, the same activities occur at regional meetings.)

Swapping and buying wood with and from other members at meetings and through the mail rates as a big benefit to IWCS membership. Wood samples for sale (usually under \$6) and trade are listed regularly in IWCS's monthly journal *World of Wood*. Each spring, as a fund raiser, the society also holds a mail auction. On a personal basis, members not only assist other members in obtaining desired wood, but help you learn to identify it, and provide other guidance.

Annual membership costs \$30 (US) worldwide. For more information, visit IWCS's website at [www.woodcollec-](http://www.woodcollec-)



Wood from all corners of the globe becomes tiny shoes in one member's collection and carved fish in another's.

Earl Deemer of Bolivar, Pennsylvania, carves his wood samples into "thumb tacks," of which he has nearly 1,200.



tors.org/collect.htm, or write directly to Bill & Myrtle Cockrell, IWCS Secretary/Treasurer, 2300 West Rangeline Rd., Greencastle, IN 46135-7875. E-mail: [cockrell@indy.tds.net](mailto:cockrell@indy.tds.net).

## Craft your wood collection

Earl Deemer of Bolivar, Pennsylvania, the president of IWCS, has nearly 1,200 pieces of wood in his collection, all carved in the shape of human thumbs! Earl calls them "thumb tacks," and according to him, he still has plenty more that he wants to carve.

In Brevard, North Carolina, IWCS member Bill Sunier carves his wood collection into the shapes of dolphins. Each measures 1½×1¼×3½". He has carved nearly 2,000 of them.

Then there's Jim Baynes of Worthington, Indiana. He displays his

collection in the form of state maps, with the counties represented by different wood species. He's now working on his eighth state (Indiana alone has counties represented by 92 different species).

And to make sure that little collectible wood goes to waste, some IWCS members share their finds. For instance, in Australia, Helen Stirling has turned about 1,000 different species of wood into eggs. But when Helen's done with an egg for her collection, she sends the leftover wood to the earlier mentioned Earl Deemer, who makes it into a thumb tack to add to his. Earl's scrapwood then passes on to Ernie Ives in England to be thinly sliced for conversion into microscopic study slides! ♣

Written by Peter J. Stephano  
Photographs: Randy O' Rouke;  
Baldwin Photography; courtesy of IWCS



Australian Helen Stirling turns her collected wood into eggs similar to those above. She has them in 1,000 species.



Goblets and other intricately turned items show up in the collections of Frank Nechal of Owosso, Michigan.

# captivating cupola

When we moved to a new home not long ago, one of the things that struck me was how hot and stuffy the garage was during the summer. To do something about it, I designed and built this cupola to provide ventilation as well as add some charm to the otherwise ordinary-looking structure.

Working with copper for the roof was a new experience for me, but I found it was an easy material to shape. I screened the inside of the project to keep the bugs out, and added a weather vane (see the Buying Guide for my source) to further its good looks.

*J. R. Corning*

Design Editor



## Start with the dadoed corner posts

**1** From cedar, redwood, or cypress stock measuring  $2\frac{1}{2}$ " square (we cut ours out of 4x4 stock), cut the four corner posts (A) to size. Carefully layout and mark the angled dado locations on one of the corner posts, where shown on the Corner Posts drawing.

**2** Mount a dado blade, set for a  $\frac{1}{2}$ "-wide cut, to your tablesaw arbor. Raise the blade  $\frac{1}{2}$ " above the surface.

**3** Attach a miter-gauge extension to your miter gauge. Verify that the miter gauge is set  $90^\circ$  to the dado blade. Cut the  $\frac{1}{2}$ "-wide dados  $\frac{1}{2}$ " deep in adjacent faces of each post, where shown on the Corner Posts drawing.

**4** Angle the miter gauge  $45^\circ$  from the dado blade. Align one of the marked angled dados with the blade, and clamp a stop to the miter-gauge extension. Using the stop for consistency, cut the first angled dado in *one* face of all four

*Continued*

## CORNER POSTS

$\frac{1}{2}$ " dados  $\frac{1}{2}$ " deep,  
cut at a  $45^\circ$  angle

**Note:** The extra notches left on inside edges of the posts are a result of the dados cut. These will not be seen after assembly.

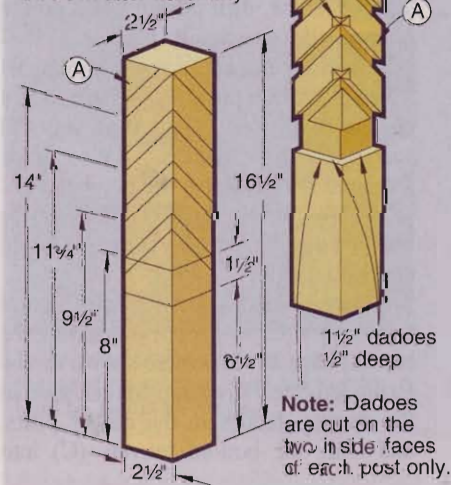



# captivating cupola



**A** Align the marked dados with your dado blade. Use a clamp as a stop on the miter-gauge extension for consistently placed cuts.

posts. Reset the stop, and cut the second set of dados in each post, as shown in *Photo A*. Continue until all four dados are cut in *one side* of each corner post.

**5** Readjust the miter gauge to cut at 45° from the *opposite side* of the blade, and use the process in Step 4 to cut four dados in the *adjacent side* of each corner post. Notice that the intersecting dados form an odd notch on the inside corner. Don't worry, as this won't show when your cupola is assembled.

## Cut the sills, louvers, and top plates next

**1** Cut the sills (B) to size plus 2" in length. Then, bevel-rip a 20° bevel along the top surface of each strip, where shown on the Sill End View drawing. Miter-cut all four sills to 24" in length.

**2** Using the Sill Top View drawing for reference, mark and cut a notch on each mitered end of each sill (B).

**3** Using a pocket-hole jig set to drill 1½" stock, drill pocket holes on the *bottom side* of each sill (B).

**4** Glue, clamp, and screw the sills (B) to the corner posts (A), where shown on the Exploded View drawing and accompanying details. (We used Titebond II.) Note that the notched ends of the sills fit into the 90° dados in the corner posts. Wipe off excess glue, and check for square.

**5** From ½" stock, cut the four bottom louvers (C) to size, bevel-ripping the bottom edge at 45°, where shown on the Exploded View drawing. Spread glue in the mating dados in the corner posts, and slide the bottom louvers (C) into

## SILL TOP VIEW

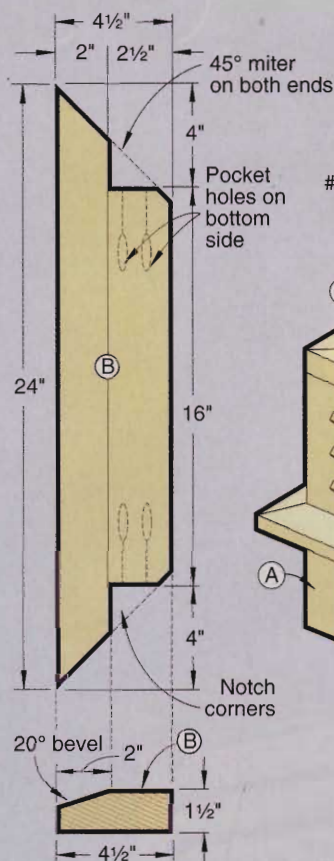

## SILL END VIEW

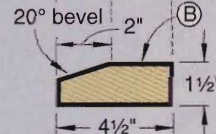

## INSTALLING THE SCREEN

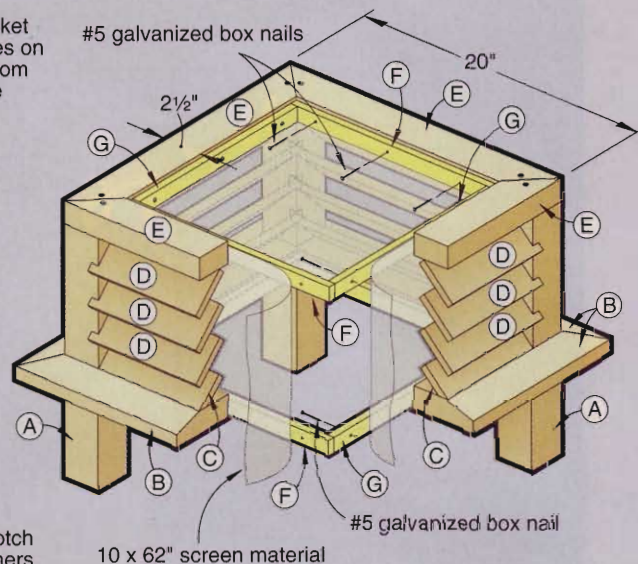

place. Toe-nail the louvers in place, where shown on the Louver detail accompanying the Exploded View and Section View drawings.

**6** Cut the remaining louvers (D) and top plates (E) to size. Glue and nail the louvers in place. Drill mounting holes, and screw the top plates in place.

**7** Cut the screen cleats (F, G) to size. Cut the screen to size. As shown on the Installing the Screen drawing *above*, nail the screen cleats in place to secure the screen. Overlap the ends of the screen to avoid a possible void.

## Next, the cupola rafters and roof sheathing

**1** From 1½"-thick stock, cut the rafters (H) to the size and shape shown on the Rafters drawing, reversing the notches so the pieces will fit together as shown on the Exploded View drawing.

## BILL OF MATERIALS

Part	finished size			Matl.	Qty.
	T	W	L		
A corner posts	2½"	2½"	16½"	C	4
B* sills	1½"	4½"	24"	C	4
C bottom louvers	½"	2½"	16"	C	4
D louvers	½"	3"	16"	C	12
E top plates	1½"	2½"	20"	C	4
F screen cleats	½"	1"	15"	C	4
G screen cleats	½"	1"	14"	C	4
H rafters	1½"	5¼"	28¼"	C	2
I lower sheathing	¾"	7¼"	24"	C	4
J upper sheathing	¾"	6½"	11¼"	C	4
K sides	¾"	6½"	21½"	C	2
L ends	¾"	6½"	21½"	C	2

Cut parts marked with an \* oversized. Trim to finished size according to the how-to instructions.

**Material Key:** C—choice (cedar, redwood, or cypress)

**Supplies:** 1½", 2½", 3" deck screws; #5, #7 galvanized box nails; #16x1¼" copper-plated nails, screen, roofing felt, caulk, epoxy, 18x72" 16-ounce copper sheet, primer, and paint.

### Buying Guide

**Weather vane.** For several styles of weather vanes, contact GBC Millwork, 7034 Easton Road, Pipersville, PA 18947, or call 215-766-4960. We purchased the Polished Copper Yawl for \$170 and the extension rod for \$15. Visit them on the web at [www.gbcmillwork.com](http://www.gbcmillwork.com)

Continued



# captivating cupola

**2** Cut a 20° bevel along the top edges of each rafter. (We tilted the fence on our jointer 20° from vertical and set the table for about a 1/16"-deep cut. It took about three passes to reach the center of the 1 1/2" stock to form the adjacent bevels shown on the Bevel detail accompanying the Rafters drawing at right.

**3** Fit the two notched rafters together. If you plan on adding a weather vane, use your drill press, and drill a 1/2" or 3/4" hole in the top center of the rafters where shown on the Exploded View. See the Buying Guide for our source of weather vane hardware. The size of the hole will depend on your particular weather vane.

**4** Center the rafter assembly on the cupola frame, drill countersunk mounting holes, and screw the ends of the rafters (H) to the top plates (E).

**5** Using the Roof Sheathing drawing for reference, layout and cut the roof sheathing (I, J) to shape, cutting a 20° bevel along the mating edges. (To do this, we tilted the table on our bandsaw 20° from horizontal, and made the cuts.)

**6** Use duct tape to temporarily hold the ends of the lower sheathing pieces (I) together. Place the taped-together assembly onto the rafters (H). Trim if necessary. Once satisfied with the fit, glue and nail the sheathing in place. Repeat the process to fit and attach the upper sheathing pieces (J). Drill a hole through the center of the upper sheathing pieces directly over the hole in the rafters if you plan on adding a weather vane.

**7** Epoxy the weather vane extension into the hole. Take your time to plumb the extension, you don't want a slanted weather vane later.

**8** Prime the inside and outside surfaces of the cupola.

## Add beauty and durability with a copper roof

*Note: You can form your own copper roof, or take the assembled cupola and the Copper Roof drawing and Cutting Diagram to an exterior sheet metal contractor, and have them create one for you.*

**1** Using the Copper Roof Cutting Diagram for reference, cut the four triangular copper roof panels to shape. (We cut the copper with a tin snips. To protect our hands and prevent getting

any oil from our hands onto the copper, we wore clean gloves whenever handling the copper.)

**2** Clamp one of the copper roof panels so 3/4" of one ridge edge extends over the edge of your workbench. Clamp a 3' length of 1 1/2"x1 1/2" angle iron on top of the copper panel. Using a mallet and a block of wood, bend the ridge

edge up. See the Copper Roof Cutting Diagram for reference. Repeat with the adjacent ridge edge. Then, repeat with the bottom edge, bending 1" in the opposite direction of the ridge edges.

**3** Temporarily clamp all four roof panels to the cupola roof to check the fit. Trim and rebend if necessary. Notice that the 90° bends along the

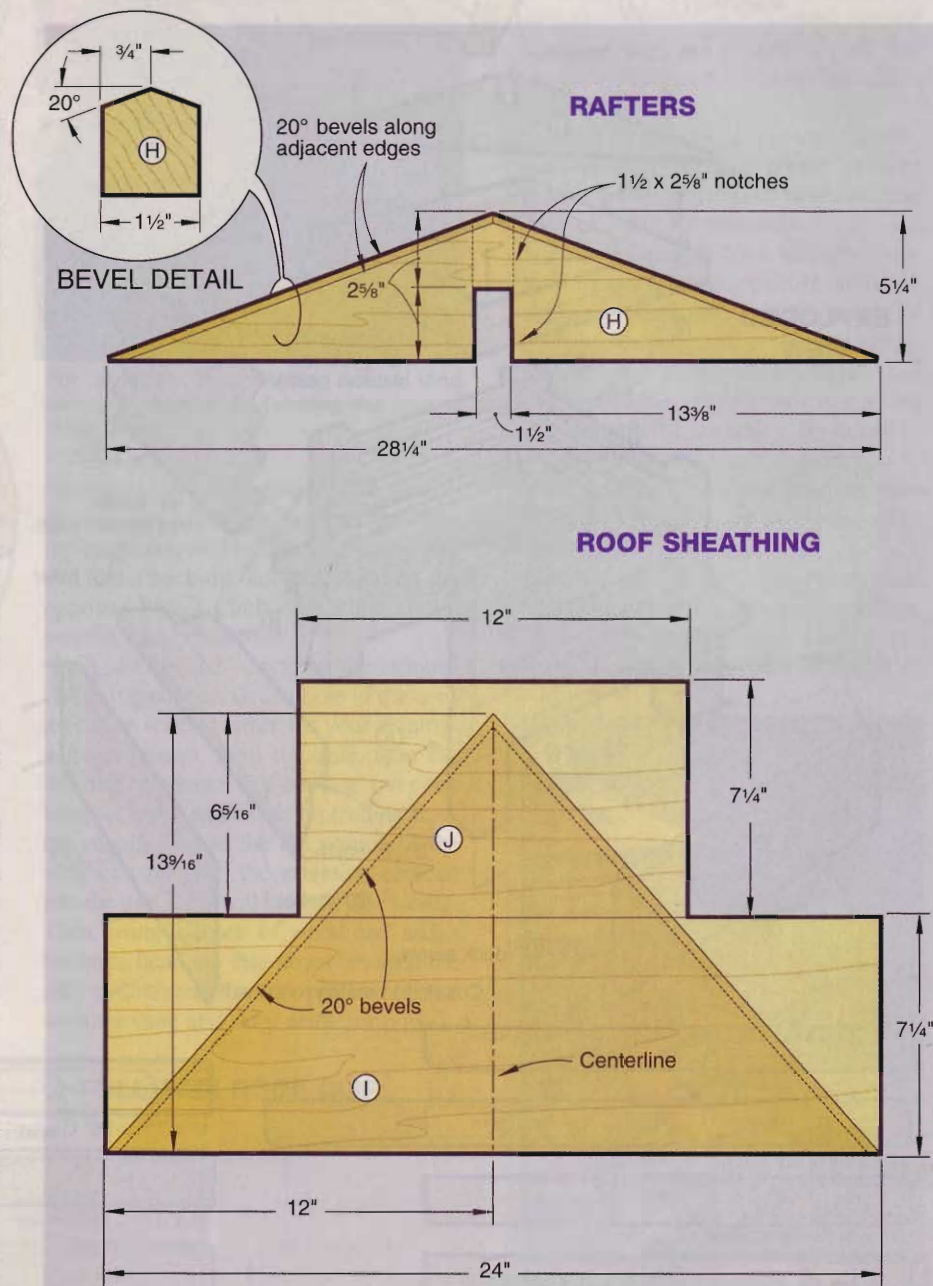

ridges are bent too far. We will fix that in the next step. Trim the copper to fit around the weather vane extension.

**4** Rebend the ridge angles so the mating edges fit closely together.

**5** Staple and/or nail roofing felt to the top surface of the sheathing (I, J). Don't attach the felt any earlier, as the joint lines between the sheathing are useful when fitting (and trimming if necessary) the copper roof panels.

**6** Cut the 12 roof hold-down clips to shape using the full-size pattern on the *next page* as a guide. Drill the  $\frac{1}{16}$ " holes, and make the cuts to create the tabs. Bend the bottom tabs to hold the copper panels together and to the sheathing (I, J), where shown on the Copper Roof drawing and accompanying detail.

**7** Lightly clamp all four copper roof panels in place. Remove panel 1, and slide 3 clips along each exposed edge of panels 2 and 3, where shown on the Copper Roof drawing. Nail the bottom exposed tabs of the six clips in place and

*Continued*

## COPPER ROOF

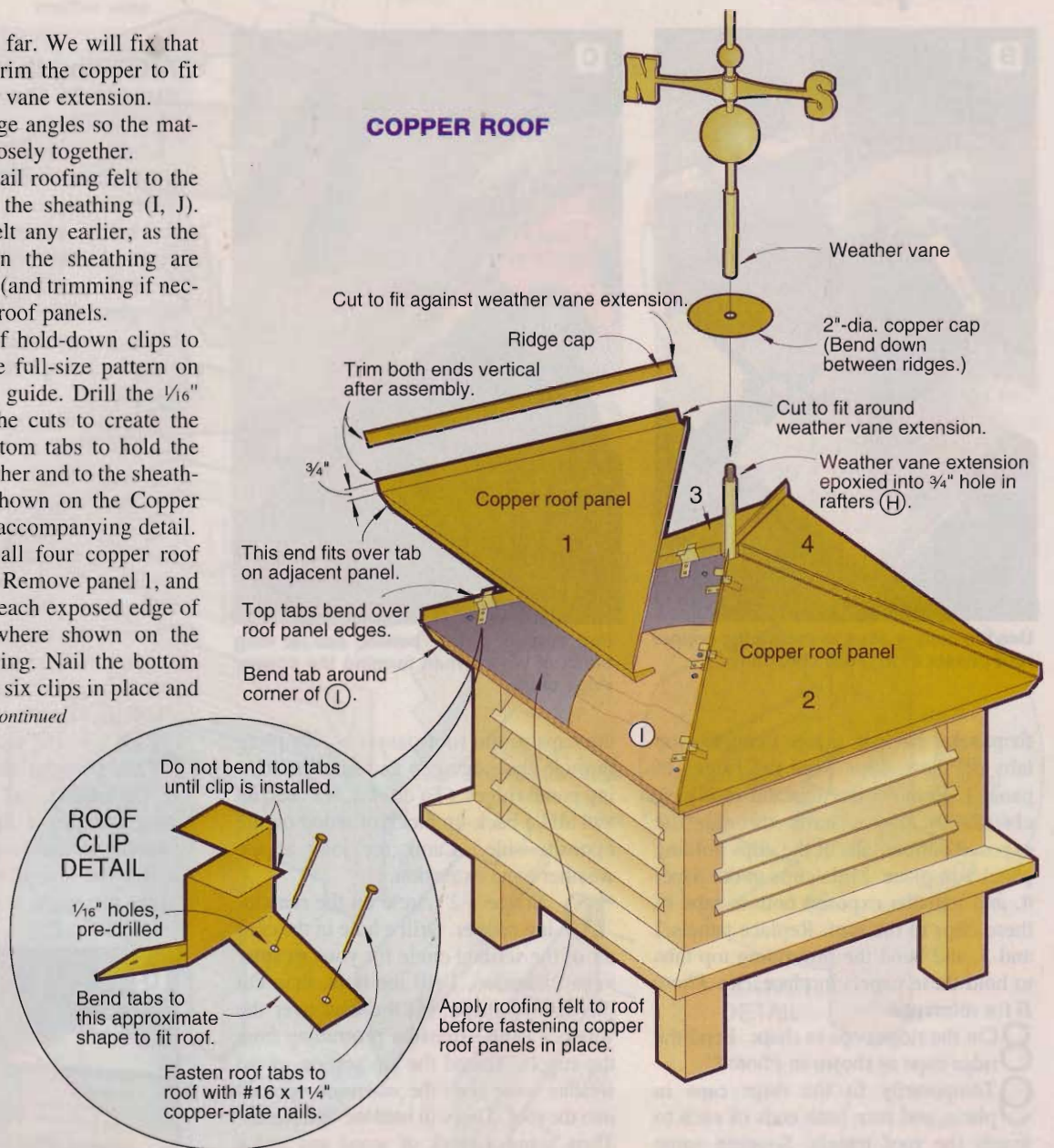

## COPPER ROOF CUTTING DIAGRAM

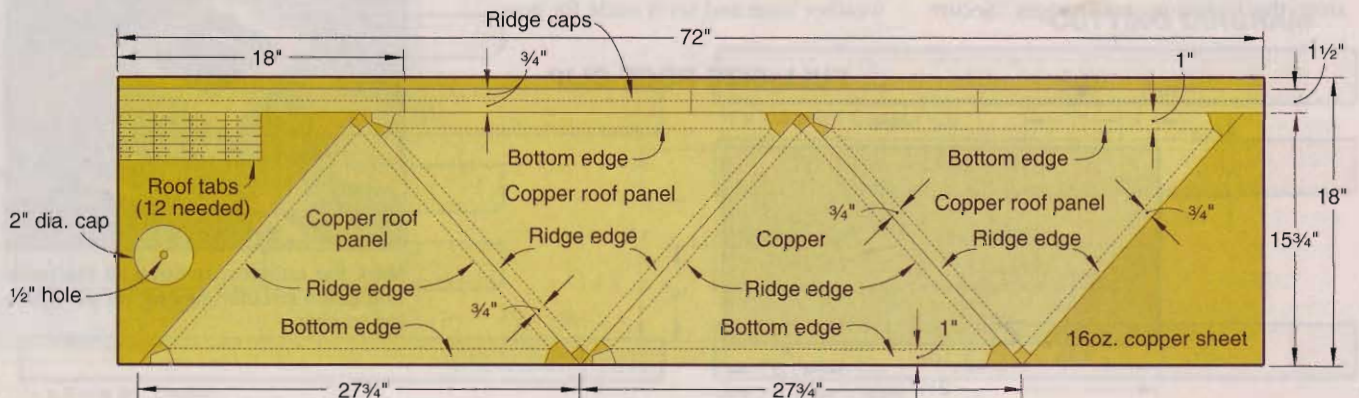

# captivating cupola



Use the copper clips to secure the copper roof panels to the roof sheathing.



For straight, even bends, use a long block of wood when forming the copper ridge caps.

fit panel 1 back in place. Bend the top tabs on these clips over the ridges of panel 1. Remove the adjacent roof panels (2, 3). Drive nails through the exposed bottom tabs of the clips holding panel 1 in place. Slide clips under panel 4, and nail the exposed bottom tabs of these clips to the roof. Replace panels 2 and 3, and bend the protruding top tabs to hold these panels in place. See *Photo B* for reference.

8 Cut the ridge caps to shape. Bend the ridge caps as shown in *Photo C*.

9 Temporarily fit the ridge caps in place, and trim both ends of each to match the roof panels. Squeeze some bath-and-tile caulk into the crease in each ridge cap, and slide the cap in place over the turned-up roof ridges. Secure

the caps to the roof panels by dimpling through the ridge cap and into the mating panel ridges. (To do this, we used an awl and a back-up block of wood on the opposite side.) Caulk the joint at the weather vane extension.

10 Scribe a 2" circle on the remaining copper. Drill a hole in the center of the scribed circle for your weather vane extension. Drill the hole, then cut the disc to shape. Fit the disc over the weather vane extension protruding from the cupola. Thread the top portion of the weather vane onto the extension epoxied into the roof. This will hold the disc steady. Then, using a block of wood and a hammer, bend the disc down between the ridges. Unthread the top portion of the weather vane and set it aside for now.

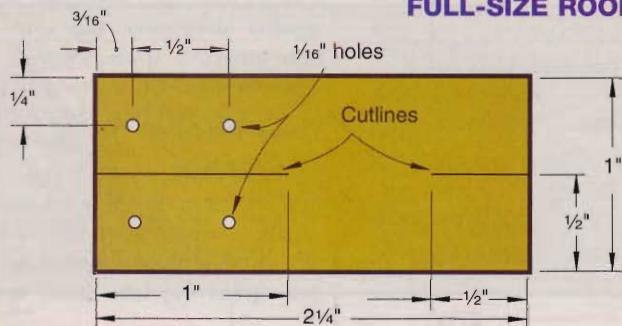

## Attaching the completed cupola to the roof

1 Position the cupola on the roof, being careful to center it over the ridge of the roof. Mark or scribe the location (we used a black marker) of the outside corners of the four corner posts (A) onto the roof shingles. Add 1" in all directions, and cut through the shingles. (We used a hooked roofing blade in our utility knife to cut the shingles.) Remove the shingles with a flat pry bar.

2 Mark and then angle-cut the bottom end of each corner post to match the slope of your roof. See the Section View for reference.

3 Set the cupola back in place, centering it over the opening cut in the shingles. Mark the inside corner of each corner post on the roof sheathing. Connect the inside corner marks, and use a portable circular saw set to cut just through the sheathing, as shown in *Photo D*, to cut the roof opening.

4 Fit a 8x26" piece of flashing over the shingles along the lower edge of the cupola and under the overlapping shingles at the ends. Now, slide individual pre-bent flashing sections under the shingles along both edges up to the ridge, as shown in *Photo E*.



Mark the cutlines, remove all the nails, and use a circular saw to cut the opening to size.

(We used a flat pry bar to remove shingle nails. For nails we couldn't reach, we trimmed the flashing to fit around the nails. The top center flashing pieces need to be cut so portions fitting under the shingles overlap at the centerline of the roof ridge.)

**5** Place the cupola between the flashing and centered over the opening in the roof. Check that the cupola is level and plumb, especially if using a weather vane. Working from inside the building, drill pilot holes and screw the cupola to the roof, as shown in *Photo F*. (We used a helper on the roof to insure the cupola didn't move when the other person drilled the pilot holes and screwed the cupola in place.)

**6** Cut the four skirt boards (K, L) to shape, using cardboard templates as guides. Cut the bottom edge of the end skirts (L) at a bevel to match the roof pitch where shown on the Section View drawing. Fit the V-cut side pieces (K) in place first, then the end skirts (L), as shown in *Photo G*. Caulk the beveled corners, and apply roofing cement along the bottom edges of all four pieces. Screw the four skirt pieces in place.

**7** Install the weather vane. Apply the final coats of paint to the cupola. 🌲

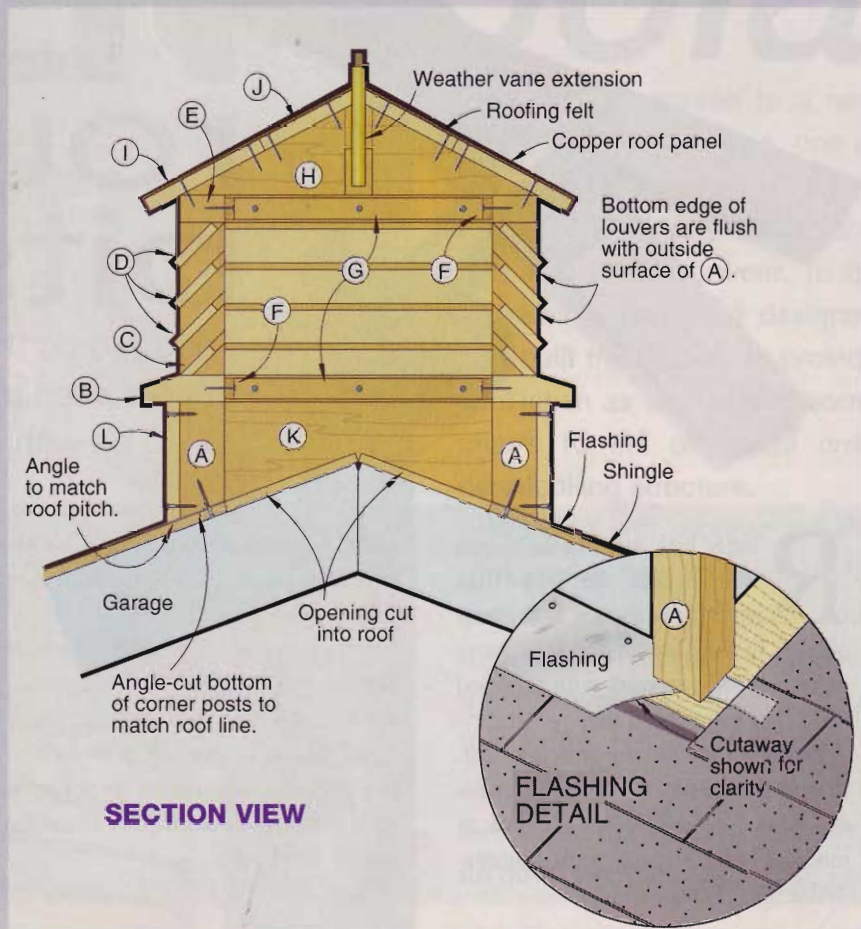

**E** Bend pieces of flashing, and slide them under the shingles along both edges of the opening.



**F** Using a helper on the roof to hold the cupola in place, drive screws through the roof sheathing into the cupola corner posts.

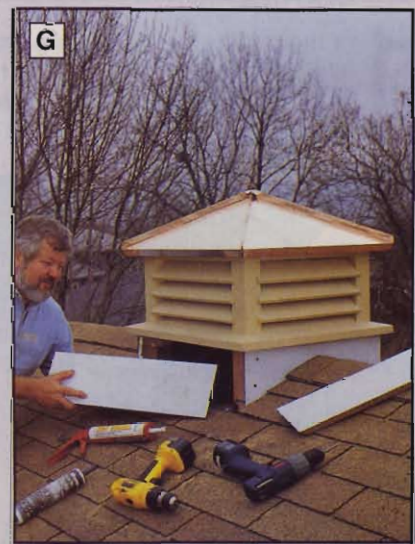

**G** To prevent moisture from penetrating, the skirting pieces must be cut for a tight fit. Caulk all joints.

Written by Marlen Kemmet Project Design: James R. Downing Photographs: Hetherington & Associates Illustrations: Kim Downing; Lorna Johnson



# TLC for router bits

Let a pro do the resharpener, but between trips keep them tuned up with a few file strokes.

**R**outer bits, even those tipped with carbide, dull faster than you might expect. It happens quickly in solid wood, and even more quickly when you work with plywood and other resin-filled sheet goods.

When a dull bit needs regrinding, it's time for a trip to a good sharpening service, which can set you back as much as \$10. Only a qualified profes-

sional has the machinery and know-how that are necessary to maintain a bit's precise geometry.

However, you can prolong the time between regrindings by lightly honing the bit's flat side with a file every so often. Note that we said lightly, and only on flat surfaces. Don't mess with the bit's hook angles. Even the pros don't do that.

All you need to hone high-speed steel and carbide bits is a pair of diamond honing files. We've found them priced at \$6 to \$7 apiece in catalogs and at woodworking supply stores.

Start with a fine (600-grit) file and finish off with a super-fine (1200-grit) version. Work carefully and don't overdo it. Here's how to keep your router bits on the cutting edge.

**1** If the bit has a pilot bearing, start by removing it, shown *below*. If the pilot isn't removable, make sure to keep the files away from it. A slight flat spot ruins a pilot.

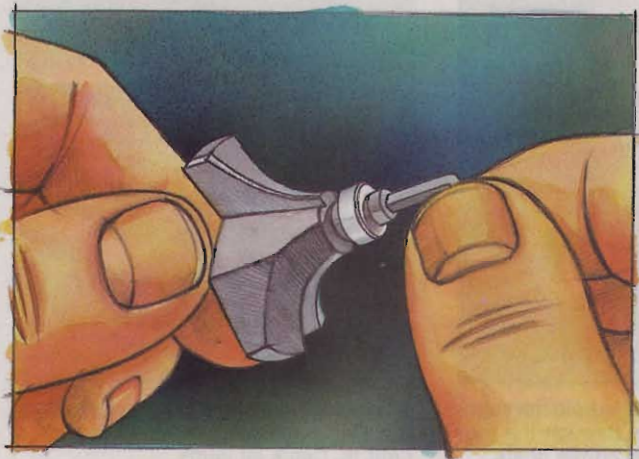

**2** Next, remove pitch and tar, which can build up in a hurry if you frequently rout softwoods. Apply lacquer thinner or oven cleaner and scrub the bit with an old toothbrush, as seen *below*.

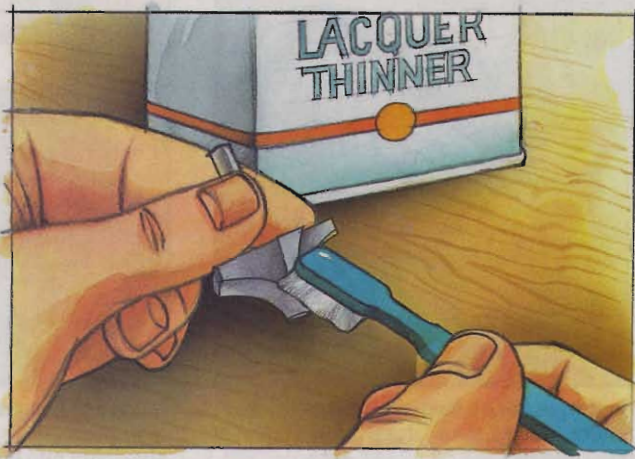

**3** Begin honing with the fine file, as shown *below*. Count the sharpening strokes or alternate the cutting edges every few strokes to assure that they're honed equally. It's better to do too little honing than too much. You might be surprised by how quickly a diamond file cuts even carbide.



**4** Finish off with the super-fine file. Again, apply an equal number of strokes to each of the bit's flat faces and use only moderate pressure. Lubricate the pilot bearing with light oil, as shown *below*, and replace it. Also wipe the bit with oil to guard against rust that can pit polished surfaces.

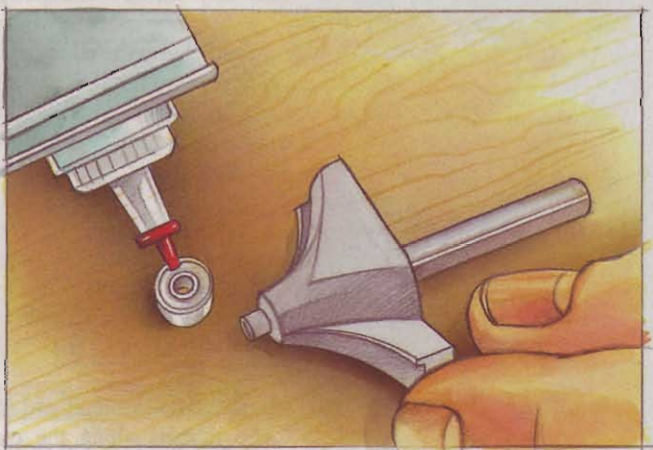

## Is it time to seek professional help?

You can hone a router bit five or six times, but eventually it needs professional grinding. The following tests will tell you if that time has come.

- Inspect the bit in good light. Look for nicks or blunt spots on the cutting edge.
- Hold a fingernail against the cutting edge and gently rotate the bit. It should shave the nail with very little effort.
- Run the bit through softwood, watch how it cuts, and examine the surface it leaves.
- Check the chips. If they look more like sawdust than thin shavings, the bit needs professional help.

We visited Puckett Tools' new shop in Waukee, Iowa, to see router bits sharpened on professional equipment. Chris Miller, 22, shown at *right*, uses a Foley-Belsaw machine equipped with a diamond wheel to get the kind of results you see *below*.

Notice that Chris wears latex-coated gloves to protect his fingers and keep a firm grip on his work. He puts the bit in a chuck, turns a couple of cranks to line it up with the wheel, then works it back and forth with a lever. A couple of minutes, and he's done. The shop charges \$5.75 for two-flute bits and \$24 for three-wing, raised-panel bits.

Chris says you can have straight bits sharpened many times. Profile bits, however, might need replacement after about four trips to a professional. ♣



Before and after sharpening

These bits from the **WOOD®** magazine workshop were showing a lot of wear. Chris used a wire wheel to clean off all the residue before taking them over to the diamond-wheel sharpener.

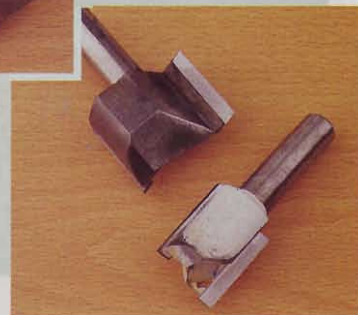

Written by Jim Hufnagel and Jim Pollock  
Illustrations: Brian Jensen  
Photographs: Baldwin Photography



# showcase *for* anglers

**W**oodworker Rick Estabo, of Marinette, Wisconsin, a long-time professional wall-eye fisherman, provided a rod-holding system for our angler's display cabinet, *left*. Rick's contribution is the design for the neat angled pockets at the base that tip the fishing rods perfectly into the notched waist-trim sides at the cabinet's midsection. Other features in the cabinet include lighted glass display shelves and enclosed storage in the cabinet's lower half.

## First, fillet the case's basic components

**1** From  $\frac{3}{4}$ " oak plywood, cut the side panels (A), fixed shelves (C), top (D), and adjustable shelf (E) to the sizes shown in the Bill of Materials.

**2** From  $\frac{3}{4}$ " solid oak, rip  $\frac{1}{4} \times \frac{3}{4}$ " strips to make the side panel edge banding (B) and adjustable shelf edge banding (F).

**3** Now, glue and clamp the edge banding to the plywood edges, where shown in the Carcase and Side Section View drawings, *right* and on *page 60*. Sand the joined surfaces smooth with each other.

**4** Mount a  $\frac{3}{4}$ " dado blade in your tablesaw and cut the  $\frac{1}{4}$ "-deep dados in the side panels (A), as dimensioned in the Parts View drawing. These dados will support the fixed shelves (C).

**5** Next, adjust the dado blade and cut  $\frac{1}{4} \times \frac{1}{2}$ "-deep rabbets along the rear edges of the side panels. These will accommodate the back panel (H).

*Continued*

**PARTS VIEW**

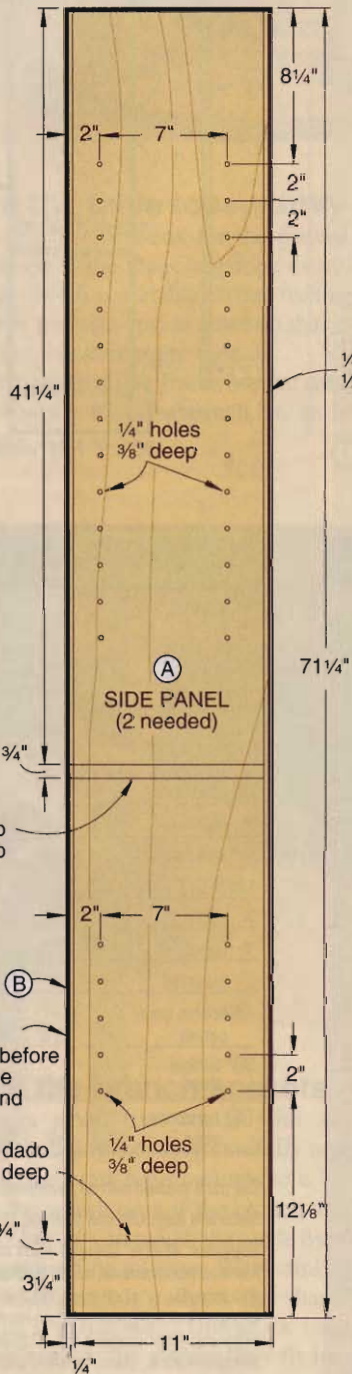
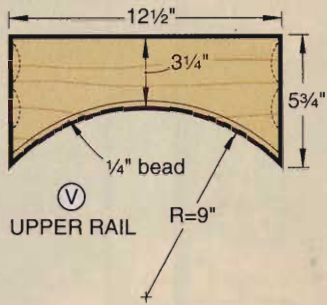

**CARCASE**

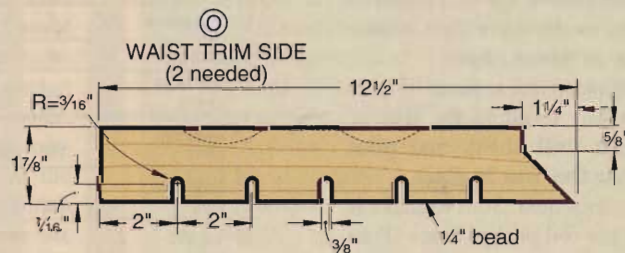
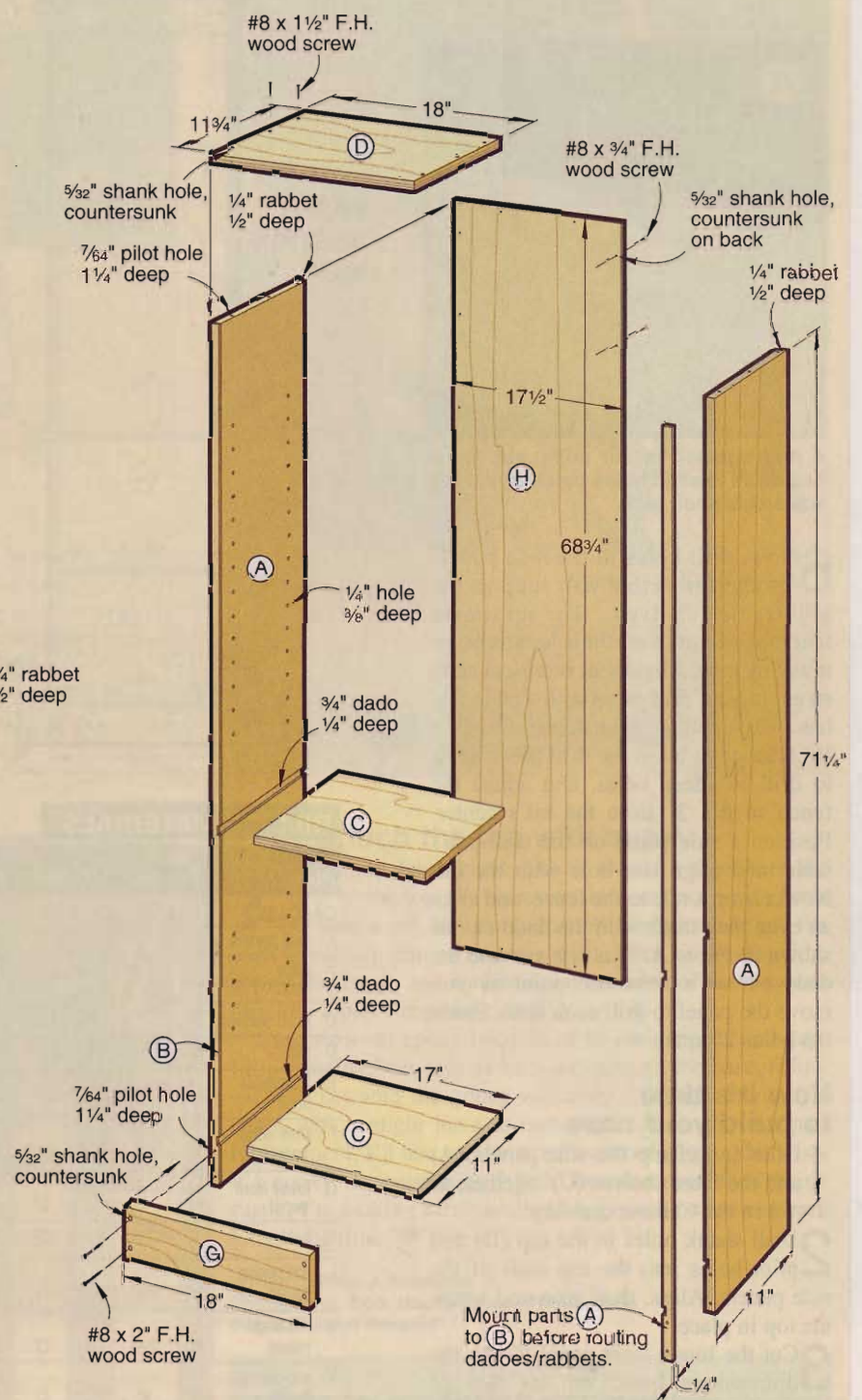

# showcase for anglers

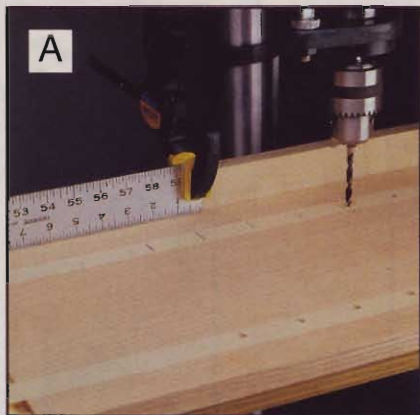

**A** rule clamped to our drill-press fence helped us to align holes precisely for the adjustable shelf pins.

6 Now, drill holes in the side panels for shelf pins that will support the adjustable shelves. To minimize tear-out, we marked their locations on masking tape. Alignment is critical here, so equip your drill press with a table that has end supports and a fence. Chuck a 1/4" brad point bit in the drill press, set it to drill 3/8" deep holes, and adjust the fence so it's 2" from the bit's center. Position a side panel on the drill-press table, and align one hole with the bit. Now, clamp a rule to the fence, and align an even inch mark with the dado cut, as shown in *Photo A*. This lets you use the dado cut as a reference point as you move the panel to drill each hole. Space the holes 2" apart.

## Now it's time to build your case

1 Glue and clamp the side panels (A) and the fixed shelves (C) together, as shown in the Carcase drawing.

2 Drill shank holes in the top (D) and pilot holes into the top ends of the side panels. Align, then glue and screw the top in place.

3 Cut the lower front panel (G) to the dimensions listed on the Bill of Materials. Glue and screw this panel to the side panels, as shown in the Carcase drawing on the *previous page*.

4 Cut the plywood back panel (H) to the dimensions listed in the Bill of Materials. Then drill shank and pilot holes, and screw the back in place.

5 The base comes next. Start to make it by cutting the rod pocket bases (I) to

*Continued*

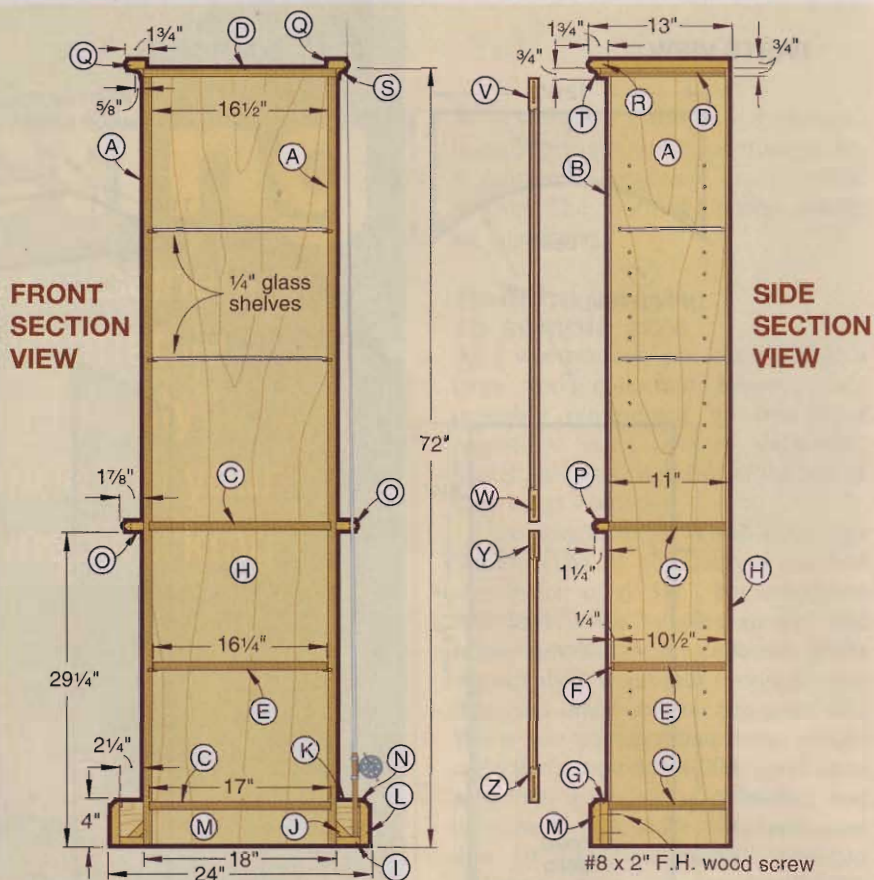

## BILL OF MATERIALS

Part	finished size			Matl. Qty.
	T	W	L	
<b>CARCASE</b>				
A side panels	3/4"	11"	71 1/4"	OP 2
B edge banding	1/4"	3/4"	71 1/4"	O 2
C fixed shelves	3/4"	11"	17"	OP 2
D top	3/4"	11 3/4"	18"	OP 1
E adjustable shelf	3/4"	10 1/2"	16 1/4"	OP 1
F shelf edge banding	1/4"	3/4"	16 1/4"	O 1
G lower front panel	3/4"	4"	18"	O 1
H back	1/4"	17 1/2"	68 3/4"	OP 1
I rod pocket bases	3/4"	2 1/4"	11 1/4"	O 2
J rod angle bases	3/4"	2 1/8"	11 1/4"	O 2
K rod pocket backs	3/4"	4"	2 1/4"	O 2
L* side bases	3/4"	4"	12 3/4"	O 2
M* front base	3/4"	4"	24"	O 1
N side base cleats	1/4"	1/2"	11 1/4"	O 2
O* waist trim sides	3/4"	1 7/8"	12 1/2"	O 2
P* waist trim front	3/4"	1 1/4"	21 3/4"	O 1
Q* top trim sides	3/4"	1 3/4"	13"	O 2

Part	finished size			Matl. Qty.
	T	W	L	
R* top trim front	3/4"	1 1/2"	20"	O 1
S* top cove sides	3/4"	5/8"	12 5/8"	O 2
T* top cove front	3/4"	5/8"	19 1/4"	O 1
<b>UPPER DOOR</b>				
U upper stiles	3/4"	2 3/4"	41 1/8"	O 2
V upper rail	3/4"	5 3/4"	12 1/2"	O 1
W lower rail	3/4"	3 3/4"	12 1/2"	O 1
<b>LOWER DOOR</b>				
X stiles	3/4"	2 3/4"	25 1/8"	O 2
Y upper rail	3/4"	2 3/4"	12 1/2"	O 1
Z lower rail	3/4"	3 3/4"	12 1/2"	O 1
AA bottom door panels	1/8"	2 1/8"	19 1/8"	O 5
BB* vertical stops	3/16"	1/4"	19 5/8"	O 2
CC* horizontal stops	3/16"	1/4"	12 1/2"	O 2

Cut parts marked with an \*oversized.

Materials Key: OP—oak plywood, O—oak.

Supplies: #8x1 1/4" flathead wood screws, #8x3/4" flathead wood screws, #8x2" flathead wood screws, #10 biscuits, 1/4" shelf pins (12), 1/4x10x16 1/2" glass (2), 1/8x13x35 1/4" glass, 1 5/8" no-mortise hinges (4), magnetic door catches (2), 1" brass knobs (2), silicone caulk, stain, sealer, and a 25 watt curio cabinet light (found at lighting retailers).

**EXPLODED VIEW**

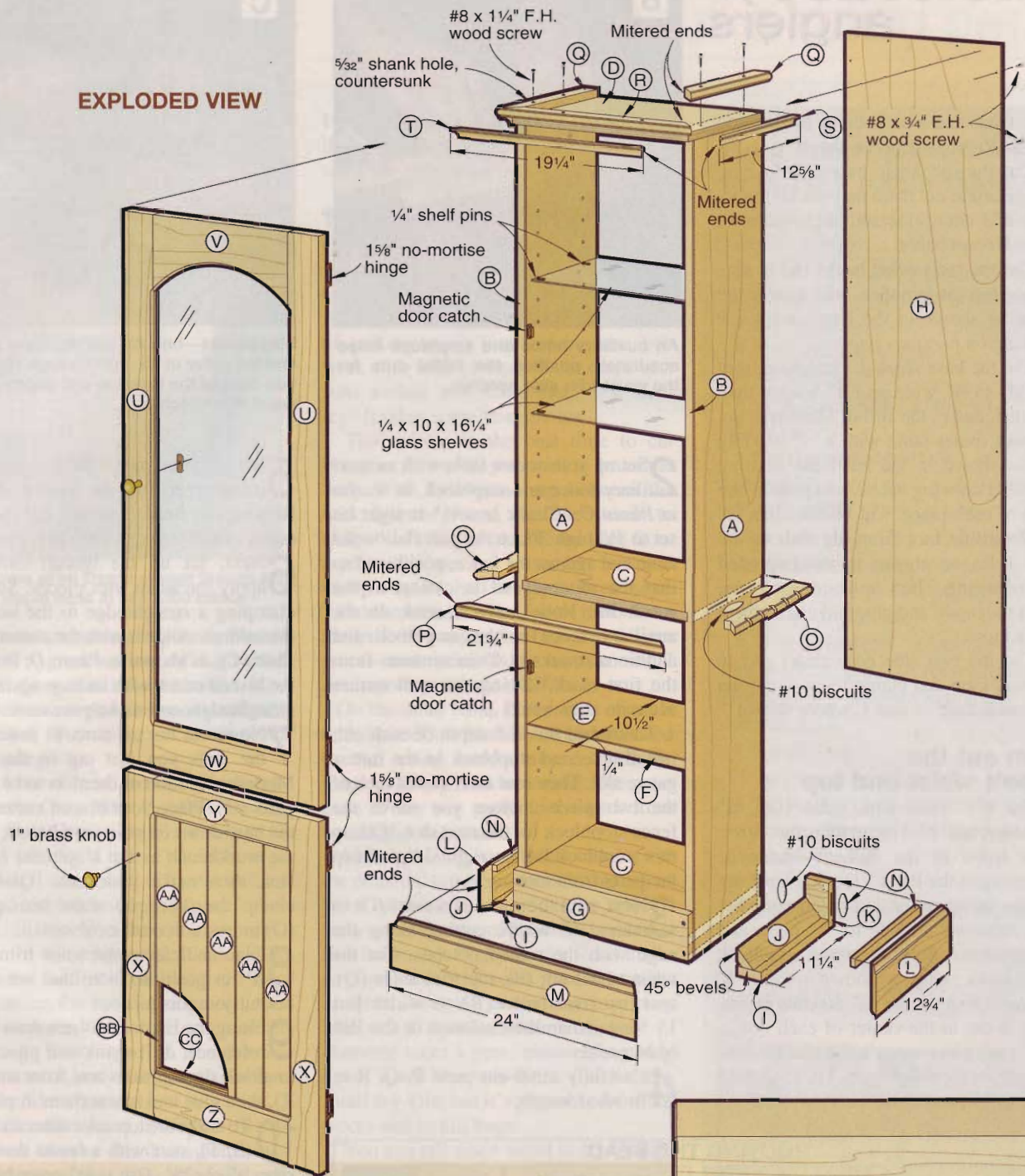

**CUTTING DIAGRAM**

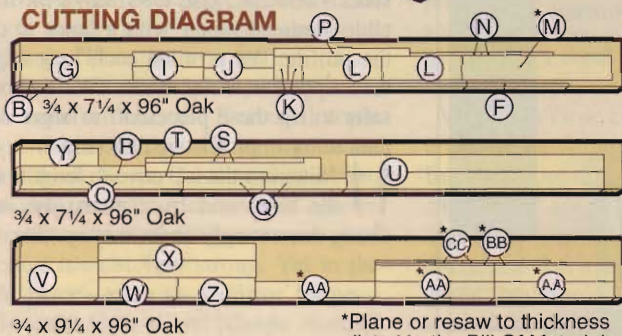

\*Plane or resaw to thickness listed in the Bill Of Materials.

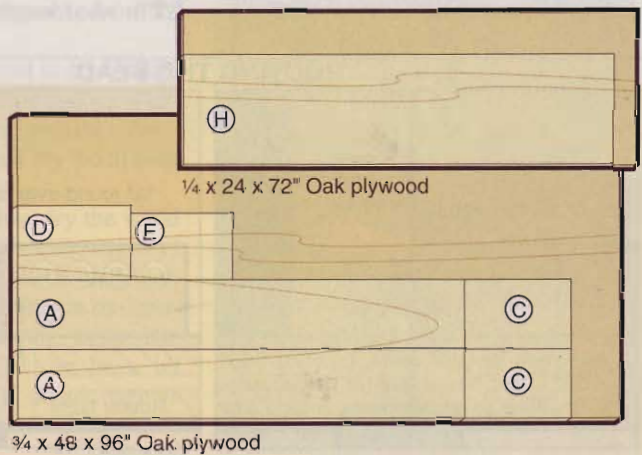

# showcase for anglers

size. Glue and clamp them to the side panels. Remove squeeze-out.

**6** Cut the rod angle bases (J) to size, and angle-cut them on your tablesaw. Glue and clamp the rod angle bases to the sides and bases.

**7** Cut the rod pocket backs (K) to size and biscuit-join them with glue to the sides, as shown in the Exploded View drawing on *previous page*.

**8** Cut the base sides (L) and base front (M) to 4" wide and 1" longer than dimensioned in the Bill of Materials. Set up your router table with a  $\frac{3}{8}$ " beading bit, as shown in the left-hand Routing the Bead drawing *below*, and profile one edge of each piece. Cut biscuit slots  $\frac{3}{8}$ " on the inside face from the ends of the base sides, as shown in the Exploded view drawing. Then miter cut each base piece to length, and glue and clamp them in position.

**9** Cut the two side base cleats (N) to size, glue and clamp them along the top inside face of part L where shown.

## Trim out the case's waist and top

**1** Cut the waist trim sides (O),  $\frac{1}{8}$ " wider and 1" longer than the finish sizes listed in the Bill of Materials. Referring to the Parts View drawing, lay out the offset miter and notch cuts. Set your tablesaw's blade to  $\frac{5}{8}$ " high, and clamp an auxiliary fence and stopblock to the miter gauge, as shown in *Photo B*. To make routing the  $\frac{3}{8}$ " notches easier, make a cut in the center of each notch. Turn each piece over, and make the vertical cut for the offset miter. Finally, tilt the blade to 45°, and finish the miter cuts.

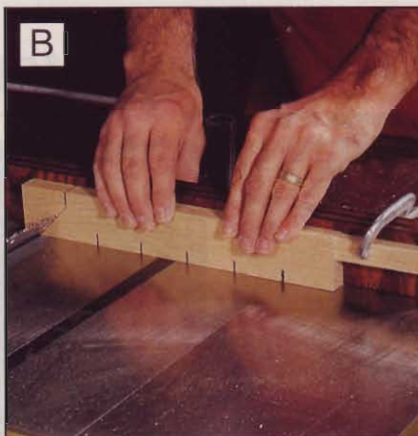

**An auxiliary fence and stopblock helps accurately position the initial cuts for the waist trim side notches.**



**Stopblocks—one on the auxiliary fence and the other in the miter-gauge slot—let you control the location and depth of the waist trim notches.**

**2** Set up your router table with an auxiliary fence and stopblock, as shown in *Photo C*. Chuck in a  $\frac{3}{8}$ " straight bit set to  $\frac{7}{8}$ " high. Place the part flat on the table and against the fence, positioned so that the mitered end is closest to the router bit. Now, make a mark on the auxiliary fence at the stopblock and additional marks at 2" increments from the first mark. (Doing this will ensure accurate alignment.)

To control the  $\frac{1}{16}$ " depth of each cut, install a second stopblock in the miter-gauge slot. Then rout each slot in each of the two pieces before you move the fence stopblock for the next slot. (Clamp this stopblock on the right side to keep the parts from moving.)

**3** Next, trim the waist trim sides (O) to their  $1\frac{1}{8}$ " width, cutting along the edge with the routed notches. Cut the waist trim front (P), top trim sides (Q), and top trim front (R) to width but 1" longer than dimensioned in the Bill of Materials.

**4** Carefully miter-cut parts P, Q, R to finished length.

**5** Set up your router table with a  $\frac{1}{4}$ " round-over bit, as shown in the Routing the Bead drawing, and rout the edges of the waist and top trim pieces.

**6** Next, set up the biscuit cutter to apply the waist trim pieces. Start by clamping a straightedge to the sides of the cabinet. Align it with the center fixed shelf (C), as shown in *Photo D*. Position the biscuit cutter with its base against the straightedge, and make your cuts.

**7** Now, cut biscuit slots to mate with the slots you just cut in the case. Mark the location of the slots to be cut in parts (O). Place your biscuit cutter with the base down on your workbench, using the workbench as the alignment for the slot, then make your cuts. Glue and clamp the (keepers) waist trim pieces (O) in position on the cabinet.

**8** Glue and clamp the waist trim front (P) in position. Note that we didn't biscuit-join this piece.

**9** Using the Exploded View drawing as reference, drill shank and pilot holes to attach the top sides and front trim (Q, R), then glue and screw them in place.

**10** To make the top cove sides and front (S, T), start with a board that measures  $\frac{3}{4}$ ×3×28". Use a  $\frac{1}{2}$ " cove bit in a table-mounted router with a fence to cut the profile. We profiled each long edge, then ripped it to  $\frac{5}{8}$ " wide. (We feel it's safer to rip these pieces off a larger one than to try to profile smaller strips.)

**11** Miter cut the top cove to lengths for the sides and front, then glue and clamp them snugly under the top trim.

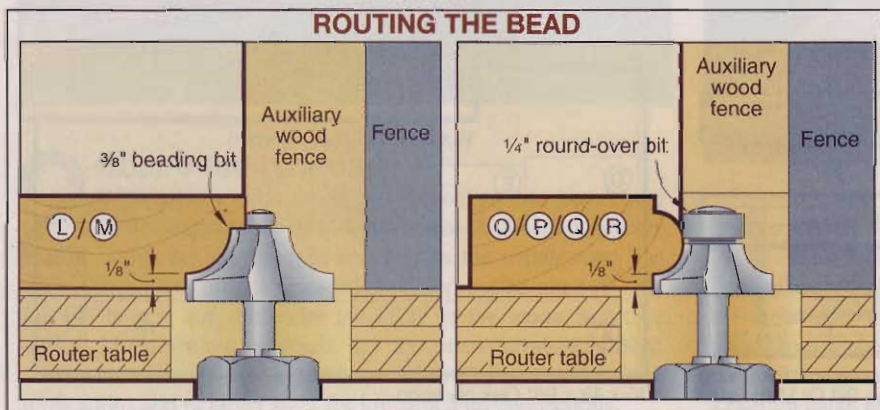



A straightedge clamped to the cabinet's sides accurately aligns slots for the biscuits that will attach the waist trim.

### Install the doors and shelves

**1** The flatter and straighter the stock you use for the door rails and stiles, the better your doors will fit. To ensure that joints align with a minimum of sanding, make sure that all parts are exactly the same thickness. Begin by cutting the stiles (U, X) and rails (V, W, Y, and Z) to the sizes listed in the Bill of Materials.

**2** Lay out the upper door's upper rail (V) as in the Parts View

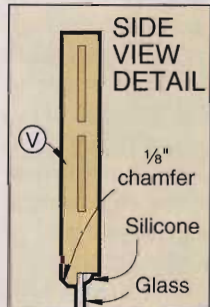

### TOP DOOR

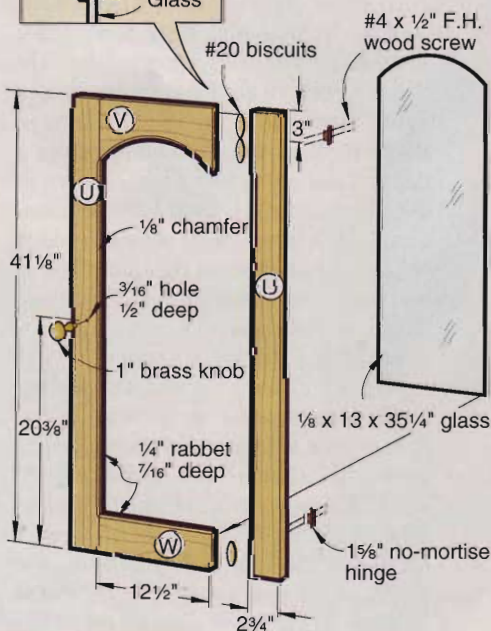

drawing, then bandsaw and sand to shape.

**3** Cut slots for biscuit joints, where shown on the Top and Bottom Door drawings, below. Glue and clamp the door parts together on a flat surface, and check for square. When the glue has set, remove the clamps and sand the joints smooth.

**4** Chuck a rabbeting bit in your table-mounted router and cut 1/4" rabbets 7/16" deep around the inside edge of each door frame. To minimize chip-out, we made these rabbets in three passes.

**5** Now, use a chamfering bit to cut a 1/8" chamfer around the outside edge of each frame.

**6** Cut 1/8" hardboard to make a pattern for the upper door's glass panel, allowing for 1/16" clearance all around. Have a glass shop cut 1/8" plate glass to this pattern. Also have them cut two 1/4x10x16 1/4" glass shelves.

**7** Make the bottom door's panels (AA) by cutting 1/8" stock to the dimensions listed in the Bill of Materials and the Bottom Door drawing.

**8** Set up a fence on your router table, fit the router with a chamfering bit, and make 1/16" chamfers along the edges of each of the panel's slats.

**9** Edge-glue the slats (AA) together, and remove any glue squeeze-out with a damp cloth. After the glue sets, sand the panel smooth, and place it in the bottom door frame.

**10** Cut the bottom door vertical stops (BB) and lower door horizontal stops (CC) to fit around the panel on the back side of the door. Pre-drill for brads, fasten the stops in place, and sand them smooth.

**11** Mount hinges and magnetic catches, where shown on the Top and Bottom Door drawings and Exploded View drawing. Drill pilot holes for all screws, and drill holes for the brass knobs, where shown on the Door drawings below.

**12** Finish-sand, remove the hardware and all dust, and apply the finish. (We used Minwax Provincial #211, then sealed with three coats of Minwax polyurethane.)

**13** Place the top door face down and install the glass, holding it in place with a bead of silicone caulk. After the silicone firms up, re-install the hinges, knobs, catches, and add a cabinet light, if desired.

**14** Position the shelf pins in the locations you prefer, and set the glass and wooden shelves in place.

Written by **Jim Hufnagel**  
Project Design: **Rick Estabo** and **James R. Downing**  
Photographs: **Hetherington and Associates**  
Illustrations: **Roxanne LeMoine; Lorna Johnson**

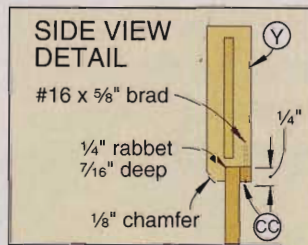

### BOTTOM DOOR

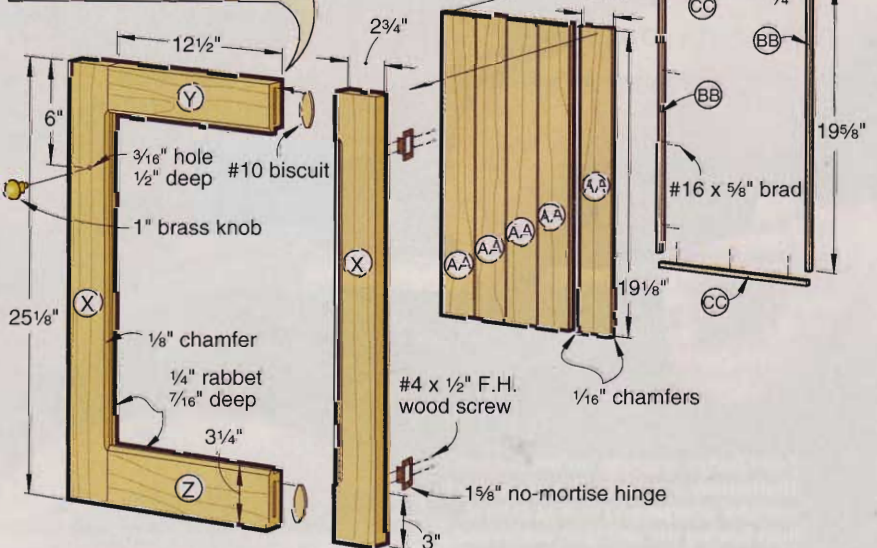



# improving your carving skills

How does a beginning or intermediate woodcarver advance to higher levels? By buying more and better tools? Taking more classes? Watching more videos?

We posed these questions to carver and instructor Keith Randich of Greece, New York. Like other accomplished carvers we've asked, his answers went right back to the basics: Make clean cuts with sharp tools and plan ahead. When he offered to show us an easy way to judge tool sharpness and some more tips, we headed out to see him. And while we were in Keith's shop, he showed us a few other handy tips as well.

Keith hones a gouge on his homemade sharpening machine. The equipment used for sharpening is less critical than having the ability to determine when an edge is truly sharp.

## Job one: sharpen your tools

"A good carving calls for good design and execution," sums up Greece, New York, woodcarver Keith Randich. "And you can't expect good execution with dull tools." Rough, fuzzy cuts, like the one marked A in *Photo A*, will condemn any carving to mediocrity. And while you could sand away the roughness, your work just wouldn't have the crisp look delivered by sharp cuts, like the one shown at C in the photo.

"Many carvers look at sharpening as something to be tolerated," Keith points out. "But poor sharpening is often all that's keeping a carver from reaching the next plateau."

## Here's how to judge an edge

How do you know when a tool needs to be sharpened? "Some people give an edge the thumbnail test, some slice paper, some shave hair on their arms," Keith notes. "But the surest way to check an edge for sharpness is to make a cross-grain cut." If you see fuzzy, torn wood in the cut, it's time to sharpen.

There are no secrets to putting a keen edge on a tool; all it takes is careful application of simple techniques. But to sharpen tools well consistently, you must first be able to determine when an edge is sharp. "The surest way to judge your progress toward a sharp edge is by looking closely at the edge," Keith says.

To check for sharpness, Keith stands with the light coming from behind him and points the tool edge toward the light as he inspects it. Dullness shows up as a light reflection off the edge (shown in *Photo B*). The reflection comes from a flat surface—the blunt edge—shown in the Sharp Edge vs. Dull Edge illustration. (Incandescent light shows the edge better than fluorescent light; daylight is best of all.) Eliminating that flat surface makes the tool sharp.

When it comes to equipment and techniques to do the actual sharpening, Keith allows a lot of leeway. "You should stick with any sharpening equipment and technique you're comfortable with," he says. To Keith, methods and equipment are less crucial to proper sharpening than the ability to assess the blade's edge with a sharp eye. "I've had an opportunity to try most of the offer-

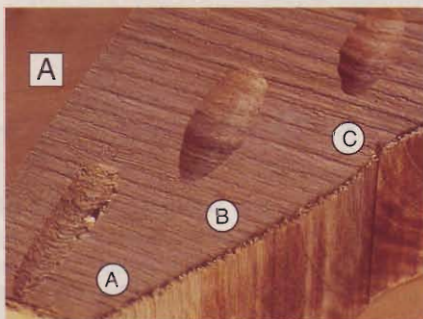

**A** dull tool tears through the surface (A) rather than cutting (B, C). The cut marked B shows some scratches in the bottom, avoidable by polishing the tool bevel.

ings on the market at one time or another. They will all perform as advertised," Keith says of sharpening equipment. By being able to differentiate a dull edge from a sharp one, you'll be able to get good results from whatever equipment and methods you use.

In his own shop, Keith relies on a homemade sharpening machine, shown in the opening photo on the opposite page. A shaft, running in two bearing blocks, carries two 8"-diameter abrasive wheels, a leather wheel, and a cloth buffing wheel. Each abrasive wheel is a wooden disc with an inner-tube rubber band around the rim, with cloth-backed abrasive glued to that. One wheel carries 80-grit abrasive; the other, 100. A drive belt turns the shaft at about a quarter of the electric motor's 1,725 rpm.

### Five steps to sharp tools

Sharpening and honing comprise two distinct operations, in Keith's view. Sharpening, done against a coarser abrasive—a grinding wheel, a stone, or sandpaper—shapes the blade end and forms the bevel so you can bring the blade to a sharp edge. Honing, often done with a strop or a leather wheel charged with a finer abrasive compound, polishes the bevel and creates the sharp edge.

To make a tool sharp, Keith follows these five steps.

**1** Shape the tool's cutting end, and remove nicks. This may not be necessary for every tool every time. When it is, Keith uses the 80- and 100-grit abrasive wheels.

**2** Set the bevel. A 25° bevel is good for most common carving woods. Keith grinds the bevel with the 80- and 100-grit abrasive wheels, taking care to move the blade to keep the bevel surface

### A Gouge: from dull to sharp

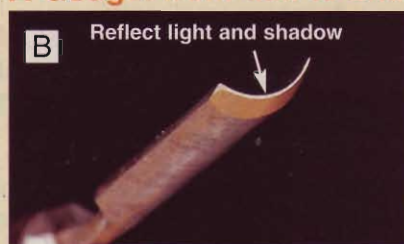

With the bevel smooth and flat, not faceted, and the line of light reflected off the dull edge uniformly wide, this gouge is ready for sharpening.



Grind the edge until the reflection is about the width of a pencil line before beginning to hone the edge.



Honing the edge brings it to final sharpness. The line of reflected light is now too narrow to see with the unaided eye, and the tool is sharp.



Polishing smooths the bevel for easier cutting and to leave a burnished surface, free of scratches, in the cut.

flat, not hollowed or rounded. After shaping the edge and setting the bevel, the business end of the blade looks like the one on the gouge in Photo B.

**3** Sharpen the blade to reduce the edge reflection to about the width of a pencil line, as shown in Photo C. Keith sharpens the blade on the 100-grit wheel, checking it frequently and keeping the bevel flat.

**4** Set an inner or top bevel on gouges and chisels. This bevel, shown in the illustration at bottom right, is really a slight (say 1/32"), shallow (maybe 5°) chamfer that breaks the top corner of the edge. It strengthens the edge and helps curl the chip away. Keith sets this bevel with a standard slipstone. U-veiners, V-tools, and bent tools don't get an inside bevel.

**5** Hone the bevel. This is where Keith develops the sharp edge. Using a strop or leather wheel charged with a honing or stropping compound, a fine ceramic stone, a waterstone, or other fine abrasive, he hones the bevel until the edge becomes so thin you can no longer see light reflecting from it, as shown in Photo D. Inspect the edge frequently as you hone.

When the tool is sharp, Keith polishes the bevel and heel. This reduces scratching in the cuts, shown at B in Photo A, and gives you a perfectly smooth cut, like cut C. Keith does this

final step against the leather wheel for the result shown in Photo E. "Cloth wheels round the bevel over too quickly," Keith says.

As a test, Keith stabs the tool edge into a scrap of carving wood, then inspects it for reflected light again. If the edge is weak at any point, it will deform when stabbed into the wood, creating a flat, reflective surface.

### Keep a sharp edge on your work

Once you've established a sharp edge on a tool, maintaining it is relatively

*Continued*

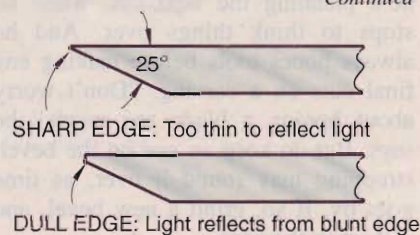

### SHARP EDGE VS. DULL EDGE

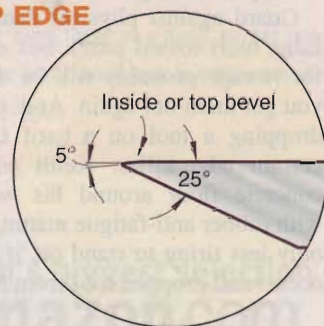



# carving skills

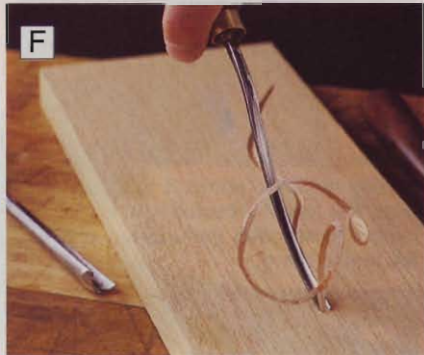

**F** A sharp tool will leave the sides of the cut and chip smooth. Cuts across the grain give the best indication of a tool's sharpness.

easy. Generally, you won't need to take a tool through all five steps very often. Honing and polishing the bevel will keep the edge sharp through lots of use.

How do you know when a tool needs honing? "Keep a critical eye on the cuts you make," Keith advises. "Scratches and tearing across the grain are signals that it's time to hone the tool." (Your best indicators will come from cuts across the grain, he notes; going with the grain, even a less-than-perfectly sharp tool can cut an impressively long chip, like the one in *Photo F*.) "When you start to notice you have to push the tool a little harder to make a cut, you're probably past the point where you needed to hone," he adds.

Keith's approach is to hone tools frequently—after roughing cuts, while he's planning the next cut, when he stops to think things over. And he always hones tools before making any final cuts on a carving. "Don't worry about honing a blade too much," he says. But do keep an eye on the bevel; stropping may round it over, as time goes by. If so, grind a new bevel, and resharpen the edge.

Guard against physical damage, too. Edge tools tossed into a box or drawer for storage probably will be dull when you get them out again. And, of course, dropping a tool on a hard floor is a certain edge-killer. Keith covers the concrete floor around his workbench with rubber anti-fatigue matting; it's not only less tiring to stand on, it saves the occasional dropped tool from harm.

## good advice

from our woodcarving pro

### Work at the right height

Most woodworking benches stand about hip-high. But you'll have better control of your carving chisels and gouges if you keep your workpiece at about elbow height. (You can sit down, however, and work in your lap for power-carving,



**G** Scrapwood risers bring the working surface of an ordinary woodworking bench up to elbow height, a better level for carving.

chip-carving, and whittling.) Instead of building taller benches to raise work to the right height, Keith knocked together some scrapwood risers like the one shown in *Photo G* and the illustration at the bottom of the page. You can modify the dimensions shown in the drawing to suit your shop situation. Clamp the riser to the workbench.

Traditional bench holdfasts fit into the holes in the riser top to secure work, as in *Photo G*. The floral ornament in the photo has been glued temporarily to a piece of plywood to make it easier to hold. (To make an easily breakable glue joint for this task, glue a piece of paper to the back of the carving, then glue the paper-backed carving to a suitable piece of scrapwood. You can use either white or yellow glue.)

### Keep your work on firm footing

It's tough to make a clean, sharp cut if the workpiece moves every time you press a gouge against it. And one of the most difficult workholding situations arises when you have to support a workpiece against a carved side that has no flat surfaces. In those instances, Keith relies on a sandbag made from one leg

### SCRAPWOOD RISERS

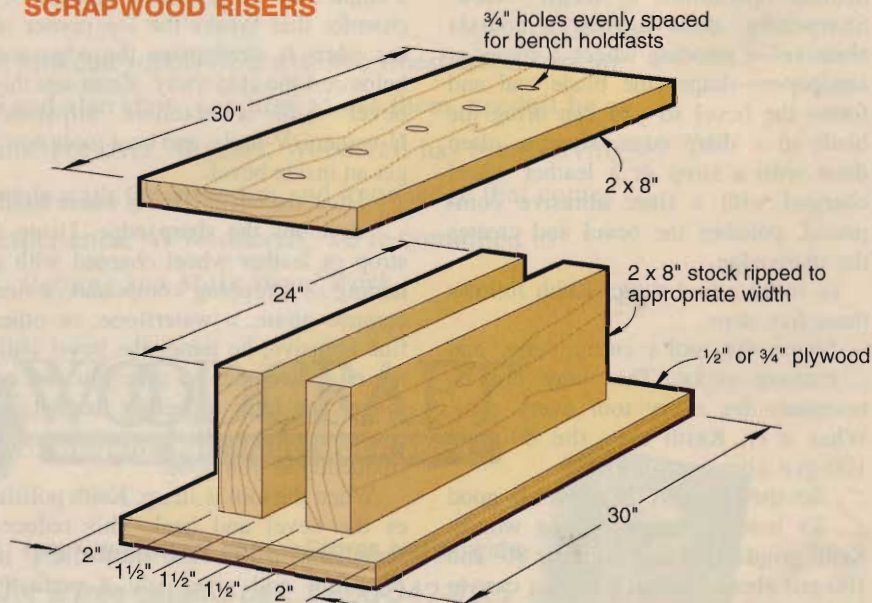



Keith used a life-casting of a hand holding a baseball (center) to mock up a table leg (right) prior to carving a prototype leg (left).



To support a workpiece on an uneven carved face, press it into a sandbag. This one is made from one leg of an old pair of jeans.

of an old pair of blue jeans, shown in *Photo I*. To make the bag, just sew one end of the pants leg shut, fill it about three-fourths full with sand, and sew the other end shut. You can then nestle a carving, such as the floral ornament shown, down into the bag for solid support. Secure the carving with a clamp.

### There are no rules against using old tools

Keith mostly carves with old tools, rescued from garage sales, second-hand shops, and antique stores. He enjoys rehabbing old tools and putting them back to work. When he shops for old gouges, chisels, V-tools, and so forth, he only considers the blade, disregarding cosmetics and handle condition. If necessary, he'll replace a ferrule (copper pipe can usually be made to fit) or make a new handle. A little cleaning, sharpening, and honing are often all it takes to put a new old tool to work.

### Lighten up your work area

Standard fluorescent shop lights do a great job of illuminating the workbench, but they aren't the best when it comes to carving. "The light is too soft and flat," Keith explains. For carving, he prefers bright light color-balanced more toward the daylight spectrum. Daylight is, of course, ideal, but not always available. (Keith likes Solux lamps, which render colors nearly as accurately as daylight and give sharp shadows to show details.

For information on Solux lamps, call 800/254-4487, or [www.solux.net](http://www.solux.net).)

### Great carvings start with a plan

Time and again, carvers have told us, "At the very least, sketch or draw your carving idea before you start." For realistic carvings, such as birds or wildlife, gather as much research material as possible—don't try to work from memory. In short, to convert the image in your mind's eye into three-dimensions, you need a plan.

Sometimes coming up with a plan is as simple as studying the pattern before you start. That's what Keith did when he carved the floral ornament in the photo at *right*. Before making his first cut, he marked the pattern (shown under the carving) to indicate levels, contours, and cut directions.

Planning became a bit more involved for the legs of a table he designed to display baseball memorabilia. For the feet, Keith envisioned a variation on the ball-and-claw theme—a hand holding a baseball. Early on, he decided he would need a model to work from. Keith made castings of his wife's hand (hers is the right size) holding a baseball, using a Body Parts casting kit, available from art-supply stores.

He attached the cast hand, shown in the center of *Photo H*, to a roughly bandsawn model of a cabriole leg so he could work out the way the leg and hand

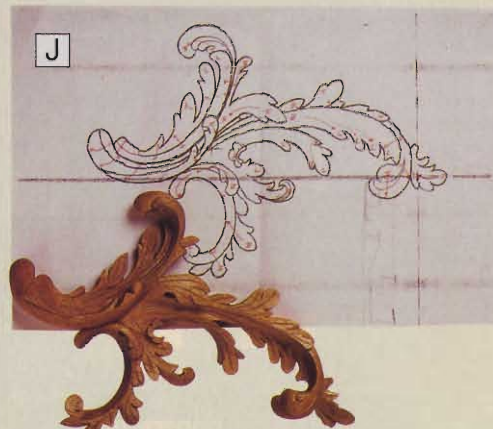

Marks on the pattern for this floral ornament indicate relative heights of the elements and cutting directions.

would meet, shown at right in the photo. Then he carved a prototype, shown at left in the photo, which served as a model for the final versions.

Written by **Larry Johnston**  
Photographs: **David Brennan**  
Illustrations: **Roxanne LeMoine; Lorna Johnson**

### BUYING guide

**Books.** For more carving information, see *Carving the Little Guys and Old Time Whittling*, both by Keith Randich. Available from Woodcraft, 800/225-1153, or [www.amazon.com](http://www.amazon.com).

# routers with **clout**

Looking for the biggest, toughest routers you can buy? You've come to the right place. The eight power-brokers in our test—each wielding at least 3 hp—deliver enough torque to plow massive bits through the hardest woods without breaking a sweat. But beyond brute strength, what do these routers bring to the table? Read on to find out.

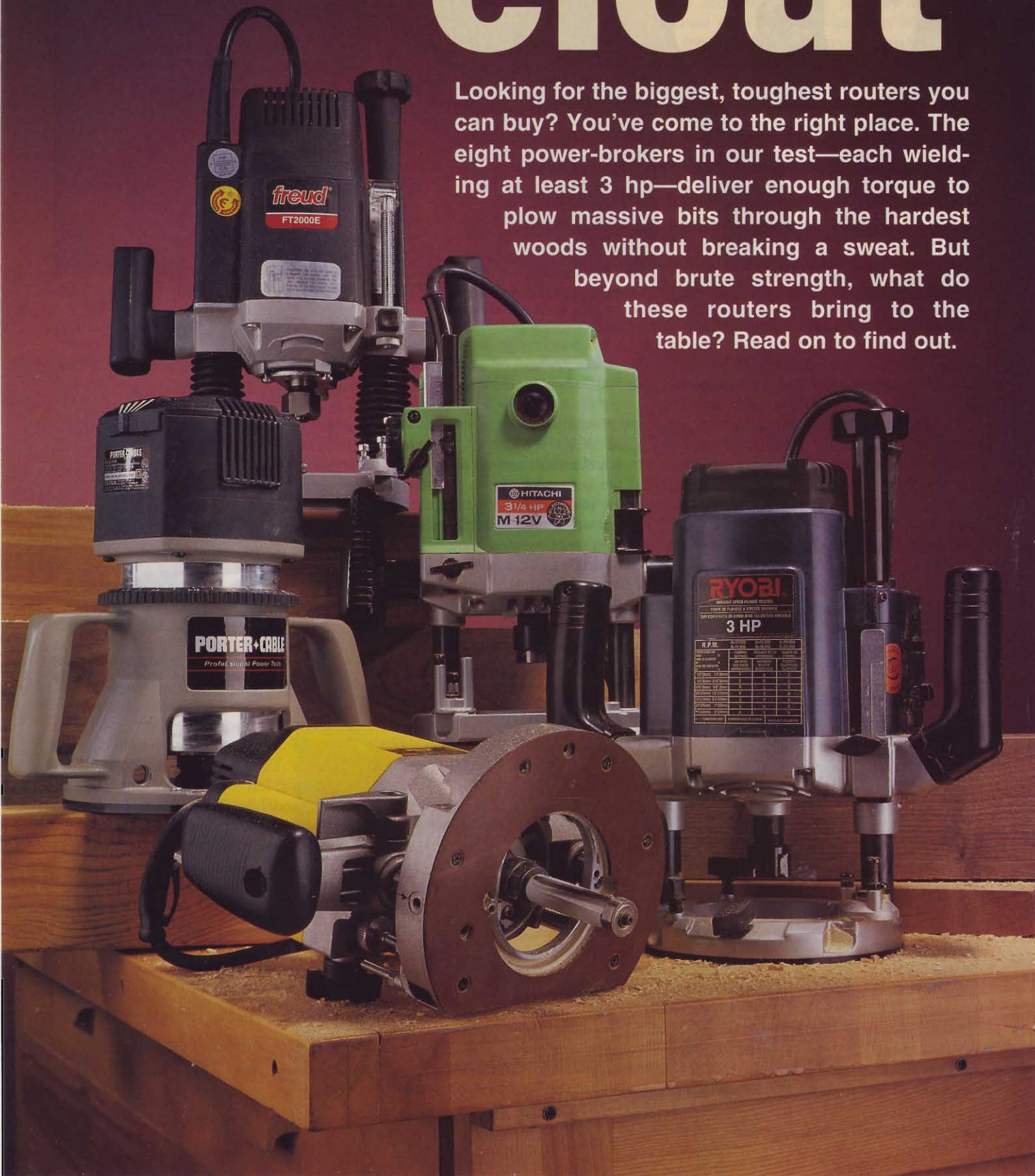

## fast facts

- If you can afford only one router for your shop, opt for a variable-speed, 3-hp plunge router. You'll have the power and versatility to make virtually any cut your projects can dish out, whether in or out of a router table.

- On the other hand, these big bruisers can be a hefty handful. So if you can afford two routers, you may also want a less-weighty 1-1/2 hp router for simple edge treatments and other lighter cuts.

- All but one of the routers in our test are of the plunge persuasion. However, the lone fixed-base router in our test provided the fastest depth-of-cut adjustments when mounted in a router table.

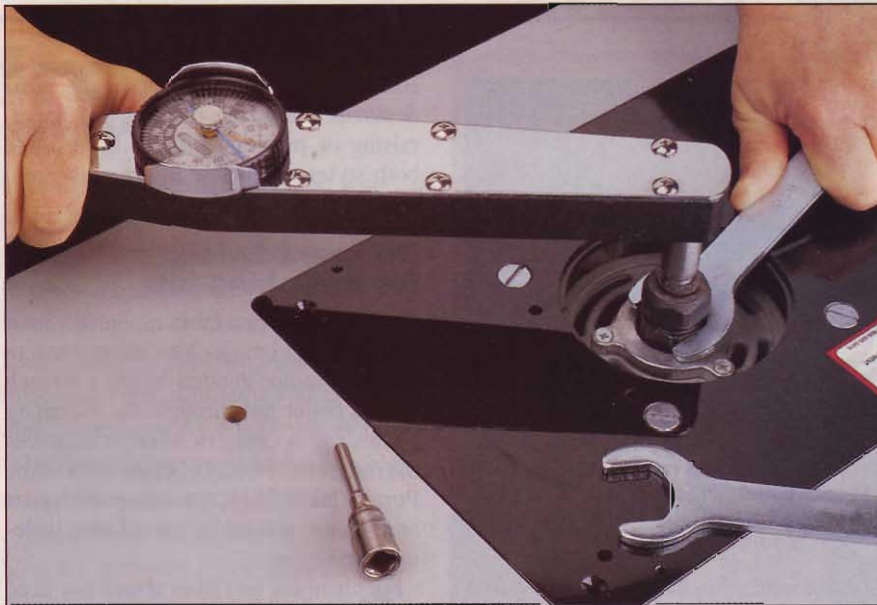

We modified a precision-ground 1/2" shaft to accept a torque wrench, mounted it in each router, and torqued the collet nut to 250 inch-pounds (a figure we determined to be normal, and that manufacturers called safe). After locking the collet, we tried to turn the shaft with a torque wrench, noting the torque reading when the shaft slipped in the collet (the *slip torque*). We then repeated the test with a 1/4" shaft in each router.

### First, a few words about the mighty models in our test

Each of the routers we reviewed for this article draws 15 amps and is rated at 3 hp or more by the manufacturer. For safety's sake, the large-diameter bits these tools are capable of driving require slower speeds than smaller bits, so we eliminated any routers that didn't offer variable speed. Speaking of speed, all of the routers we tested provide some type of feedback circuitry to keep the bit turning at a consistent rate even when bogged down in a cut.

### Consider the collet: It puts the bite on your bits

When it comes right down to it, a router's most important attribute is likely its collet. If the collet doesn't grip the bit adequately, or makes the bit wobble on its axis, you won't be satisfied with the results.

The 1/2" collets on these routers fall into one of two designs: thin-walled spring steel or thick-walled steel. Both styles grip bits well enough for the most demanding tasks. But, as you can see from the Comparing the Collets chart, at *right*, the thick-walled collets of the Hitachi M12V, Porter-Cable 7539, and Porter-Cable 7518 allowed our test shaft to slip at lower torques than the other

models, all of which use spring steel. Even so, none of the collets allowed any slippage in our tough, real-world testing with a bevy of big bits.

Thick-walled collets do have an advantage that we'll tell you about shortly when we discuss bit-changing. In the meantime, we suggest a little extra collet-tightening when using the Hitachi or Porter-Cable routers with massive bits.

Besides grip strength, we also tested each collet for runout (the wobble caused by a misalignment of the collet and the router's arbor shaft). Based on the longest 1/2" and 1/4" bits we could find, we measured runout at 2 1/4" and 1 1/2" respectively, from the top of the collet. At those distances, runout will be as bad as it gets (because runout figures improve the closer you get to the collet), and we consider any deviation of less than .003" for 1/2"-shank bits or .004" for 1/4"-shank bits acceptable.

Runout ratings for both sizes of bit shanks are shown in the Comparing the Collets chart. Only the collet on the Craftsman 27511, with its .0100" runout, caused any vibration, and then only when using bits larger than 1 1/2" in length or diameter.

The routers in our test employ two methods to switch from 1/2" to 1/4"-shank bits. Most come with a reducing sleeve

*Continued*

### COMPARING THE COLLETS

MANUFACTURER	MODEL	1/2" COLLET		1/4" COLLET REDUCER	
		RUNOUT (INCHES) (1)	SLIP TORQUE (INCH-POUNDS) (3)	RUNOUT (INCHES) (2)	SLIP TORQUE (INCH-POUNDS) (3)
CRAFTSMAN	27511	.0100	320	.0015	100
DeWALT	DW625	.0025	450	.0030	240
FREUD	FT2000E	.0025	300	.0040	95
HITACHI	M12V	.0015	150	.0040	60
MAKITA	3612C	.0025	340	.0035	125
PORTER-CABLE	7539	.0025	180	.0025	60
	7518	.0030	190	.0025	60
RYOBI	RE600	.0030	450	.0002	135

NOTES:  
 1. Measured 2 1/4" from top of collet.  
 2. Measured 1 1/2" from top of collet.  
 3. Amount of torque required to turn bit in collet tightened to 250 inch-pounds.

But ¼"-shank bits don't have the same demands placed on them as big panel-raising or profiling bits, and we found both styles acceptable in our real-world testing.

### Different twists for switching bits

Changing bits in a table-mounted router can be a real hassle. You either have to raise the motor enough to get a wrench on the collet nut through the mounting plate's top opening or lower it to access the nut from below. Or, in the case of the Porter-Cable 7518, you drop the collet and motor assembly out of the table-mounted base.

For changing bits from above, we liked machines with a large base opening to give us plenty of room to swing the wrench. On many of the routers in our test, though, an apparently large base opening is restricted by a pair of tabs (for mounting guide bushings) that jut into that opening (see photo, *below left*).

And here's where the thick-walled collets of the Hitachi and Porter-Cable models come in handy. Their stiffness means they release the bit with only about a half-turn or so of the collet nut; spring-steel collets require two to three complete revolutions of the nut before the bit can be freed. Mounted in a table, Porter-Cable's 7518 is hands-down the best for changing bits, thanks to its cavernous 4½" base opening, quick-releasing collet, and easy height adjustment.

For hand-held operations, changing bits isn't much of an issue because all of the models in our test offer easy access to spindle locks and collet nuts. We were surprised, though, to find that the openings in the plastic subbases of both Porter-Cable routers are too small to allow the collet nut or a ½" round-over bit to pass through. So, with this common bit (or larger) in the collet, we could neither raise nor lower the collet nut enough to easily get a wrench on it. (Porter-Cable sells an accessory subbase with a larger opening.)

On the other hand, we liked the Craftsman 27511's nifty Posi-Lock spindle lock, shown *below*. Unlike the spring-loaded locks on the other routers, Craftsman's locking mechanism snaps into its locked position, leaving you with a free hand to steady the router while changing bits.

### The ups and downs of height adjustments

When we talk about setting the cutting depth on a plunge router, there are really two separate systems to consider: the depth stop and the height-adjustment rod. In handheld mode, you can preset your cutting depth with the stop, then plunge to that depth for making field cuts, such as stopped grooves or dados.

To set the cutting depth with the stop system, you load your bit, release the plunge lock, and push the motor and bit down until the bit just contacts the sur-

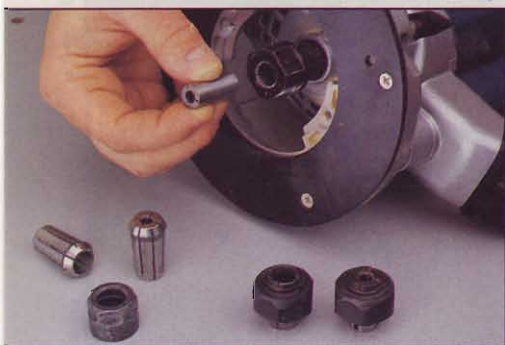

To go from ½" to ¼" bits, some manufacturers provide a reducer that fits into the ½" collet. Others, such as DeWalt (left) and Porter-Cable (right) use separate ¼" and ½" collets.

(shown in hand in the photo *above*) that inserts into the router's ½" collet and makes changing bit sizes speedy.

The Craftsman 27511, DeWalt DW625, and Porter-Cable 7539 and 7518 use separate ½" and ¼" collets, but they differ slightly in the way they attach to the machine. Craftsman's collets mount to the arbor with a Phillips-head screw in the bottom; DeWalt's snap in and out of a single collet nut. Porter-Cable doesn't include any provision for ¼" bits with the 7539 and 7518, but sells a separate ¼" collet and nut assembly as an accessory.

So, do ¼" sleeves perform as well as dedicated ¼" collets? As you can see from the chart on the *previous page*, we couldn't draw any clear conclusions from our slip-torque and runout tests.



The guide-bushing mounting tabs on the Hitachi M12V effectively narrowed the base opening enough that we couldn't fit the widest part of a multiple-profile bit through.



On the Craftsman 27511, snapping the red actuator to the left locks the spindle. The indicator light shows that the spindle is locked, and an internal switch cuts power to the motor until you disengage the lock.

## depth stops: good, better, and best

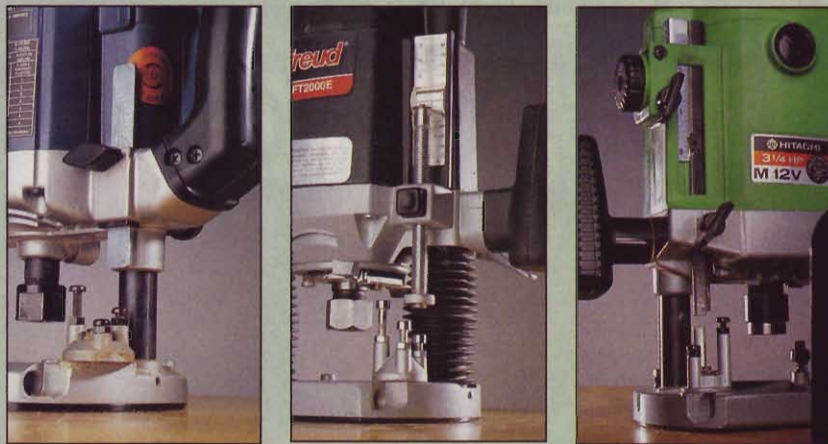

A thumbscrew locks the Ryobi RE600's stop bar (left). The Freud FT2000E's system (center) consists of a half-nut on a threaded stop. Make large adjustments with the half-nut, then tweak the depth by twisting the threaded stop. Hitachi's M12V (right) allows you to zero the bit and bottom the stop bar, then move the scale until the cursor is at 0. Now, you can adjust the bar to set the depth of cut.

face of your workbench. Engage the plunge lock, and you've just found ground zero for the bit.

Now, let's say you want to make a 1/4"-deep cut. Move the stop rod down so it bottoms on the tallest of the turret stops and note the reading on the depth scale. Using the scale, raise the stop rod 1/4" and lock it in place. When you plunge into your workpiece, the rod and turret stops will halt the plunge at 1/4". If you want to make progressively deeper cuts, say for hogging out a mortise, rotate the turret one position to plunge deeper on the next pass.

Although all of the plunge routers in our test share this basic function, some make it easier to micro-adjust cutting depth than others. For example, the Ryobi RE600's thumbscrew lock (at left in the box above) doesn't provide a mechanism for fine-tuning, aside from a steady hand. Better are the Freud FT2000E (center photo in box) and Makita 3612C with threaded rods for tweaking depth, but no way to match your bit's zero point to the scale.

The best depth-stop systems are on the Craftsman 27511, DeWalt DW625, and Hitachi M12V (at right in the box). All three use elaborate rack-and-pinion stop bars that allow you to zero the scale to match the bit and to make minute adjustments easily. Of these, we found the DeWalt the most intuitive to use, and the Hitachi scale easiest to read.

That's all well and good, but the springs that work for you in hand-held applications work against you when inverted, rendering the plunge mechanism ineffective. So, plunge routers have a second depth-of-cut adjustment in the form of a threaded rod that raises and lowers the motor and bit relative to the router's base.

Turning the finely threaded rod is an arm-numbing, knuckle-banging task, especially when making large-scale height changes. But Craftsman, Freud, Makita, and Ryobi equip their rods with easy-to-grip knurled knobs that make the task less grueling. Neither the Porter-Cable 7539 nor the Hitachi M12V come with an easy way to adjust the height. They both use ordinary nuts on the threaded rod, so you need a wrench to affect the height. (For those that don't come so equipped, you can buy aftermarket cranks or knobs to speed the adjustment, but figure on spending another \$20-\$30 for that accessory.)

On the Porter-Cable 7518, you set the cutting depth by simply rotating the motor housing within the base, spiraling from full-out to full-depth with only three turns of the housing. And, a fraction of a turn results in only a slight change in bit-height, giving you exceptional control. This height mechanism—our favorite—performed equally well regardless of whether handheld or table-mounted.

## SPEED MAINTENANCE

MANUFACTURER	MODEL	NO-LOAD SPEED	SPEED AT ENTRY TO CUT	RECOVERED SPEED
CRAFTSMAN	27511	9,685	9,589	9,602
DeWALT	DW625	7,899	7,739	7,760
FREUD	FT2000E	10,030	9,553	9,569
HITACHI	M12V	7,277	6,946	6,948
MAKITA	3612C	9,981	9,781	9,792
PORTER-CABLE	7539	14,420	5,430	9,720
	7518	14,420	6,522	9,871
RYOBI	RE600	9,861	9,554	9,760

### NOTES:

Tested with 3/4" panel-raising bit making full-depth cuts in pine at a 12" per-minute feed rate. Spindle speeds recorded under no load, as the workpiece entered the cut, and in the middle of the workpiece, using a phototachometer.

## A few more things to mull over before you buy

•**Variable-speed consistency.** Thanks to electronic speed-control (the power-tool version of cruise control), most of the machines held their speed under load within about 100 rpm of their no-load speed (see chart, above). However, at their lowest speed settings, both of the Porter-Cable routers struggled to settle into a consistent rate, and even stalled on occasion. At speeds above 12,000 rpm, though, both routers maintained their speed well.

On a speed-related note, the Makita 3612C is the only router we tested with an electric brake that stops bit rotation almost instantly on shutoff. It's a great safety feature, but doesn't function when power is controlled by a remote switch.

•**Handle comfort.** We can't pretend to know how any tool is going to feel to you, so before you plunk down your money on a specific model, try to get your hands on one. Consider weight and balance (plunge routers, by their design, will feel top-heavy), and see if the han-

*Continued*



Lock the Craftsman 27511's plunge depth by pulling the handle-mounted trigger. To release the mechanism, simply push the button on top of the handle.

dles feel comfortable at your normal working height. You can rotate the handles on the Hitachi M12V to suit your way of working.

•**Plunge locks.** While you have your hands on the machine, work the plunge lock. On some machines, you pull a lever to engage it; on others, you push. We found the locking levers easy to locate and use on all of the routers in our test. Our favorite plunge lock, though, is on the Craftsman 27511, shown *above*, which allowed us to maintain full contact with the handles whether locking or releasing the plunge height.

•**Switch location.** For handheld use, most of the power switches and speed controls were right at our fingertips, but the handle-mounted triggers of the Craftsman 27511 and Porter-Cable 7539 gave us instant, intuitive control of on/off functions. We had reservations about the top-mounted switch on the Porter-Cable 7518: To turn the power on or off, we had to let go of one handle.

However, the same top-mounted switch was the best of the bunch in a router table where a trigger switch is awkward to use. In any event, if you're buying a router primarily for use in a table, for safety we recommend hooking it up to a remote switch.

•**Dealing with dust.** Not that we don't appreciate manufacturer's efforts, but we've found on-machine dust collection effective only in plunge cuts. Debris from edge-cuts invariably ends up on the

MANUFACTURER	MODEL	MOTOR		COLLET		BASE		PLUNGE			HAND-HELD USE					
		RATED HORSEPOWER	NO-LOAD SPEED RANGE (RPM, IN THOUSANDS)	SWITCH (1)	TYPE (2)	DEPTH (INCHES)	LOCK STYLE (3)	DIAMETER (INCHES)	SHAPE (4)	OPENING SIZE (INCHES) (5)	DEPTH CONTROL KNOB (Yes, No, Optional)	MAXIMUM PLUNGE DEPTH (INCHES)	DEPTH-LOCK STYLE (6)	PLUNGE SMOOTHNESS	PLUNGE LOCK, EASE OF USE	SWITCH LOCATION AND EASE OF USE
CRAFTSMAN	27511	3 1/2	10-22	HT	I	1 1/2	P	6 1/2	R	2 3/8*	Y	2 1/2	T	E	E	E
DeWALT	DW625	3	8-22	BS	I	2 3/8	P	6 3/4	F	2 1/2	0	2 7/16	L	E	G	G
FREUD	FT2000E	3 1/4	10-22	BS	S*	1 3/8	S	6 3/4	F	2 15/32*	Y	2 15/16	L	G	G	G
HITACHI	M12V	3 1/4	8-20	BS	S	1 3/32	S	7 1/8	F	2*	0	2 3/4	L	G	G	G
MAKITA	3612C	3 1/4	9-23	BT	S	2 5/16	P	6 1/4	R	2 3/8	Y	2 23/64	L	E	G	G
PORTER-CABLE	7539	3 1/4	10-21	HT	I*	2 5/32	W	7	R	3 1/2**	N	3	L	E	E	E
	7518	3 1/4	10-21	TR	I*	2 5/32	W	7	R	4 1/2**	--	1 3/4	W	--	--	F
RYOBI	RE600	3	10-22	BT	S	1 1/4	P	6 1/2	R	2 1/2*	Y	2 3/8	L	E	G	G

**NOTES:**

- (BS) Body-mounted slide  
(BT) Body-mounted toggle  
(HT) Handle-mounted trigger  
(TR) Top-mounted rocker
- (I) Interchangeable 1/2" and 1/4" collets  
(S) Single 1/2" collet with 1/4" reducer  
(\*) 1/4" collet available as an accessory
- (P) Push button  
(S) Sliding plate  
(W) Two wrenches
- (F) Round with flat side  
(R) Round
- Maximum bit-diameter that will pass through base opening.  
(\*) Opening restricted by template-guide mounting tabs.  
(\*\*) With subbase in place, opening narrows to 1 1/4".
- (L) Lever  
(T) Trigger in handle  
(W) Wingbolt

floor, while router-table chips end up on the tabletop. We just thought you should know that DeWalt and Freud include a dust shroud as standard equipment with the DW625 and FT2000E.

**So, which one should you buy?**

Well, that depends on how you'll use the tool. For primarily handheld use, we'd take the DeWalt DW625, which earned high marks in all of the key performance areas. But, if the DW625's price tag leaves you a little cold, opt for the Hitachi M12V and save \$70.

Without question, our favorite router for table mounting is the Porter-Cable 7518. Its gaping base opening and threaded-base height adjustment make it a bit-changing dream.

If you need a machine to do double duty, take a close look at the Freud

FT2000E or the Ryobi RE600. Both machines include height-adjustment knobs and have decent-sized base openings to accommodate wrenches for bit changing. 🛠️

**Now it's your turn**

You've heard what we have to say about these routers. Now, you can log onto the **WOODMALL®** website at [www.woodmall.com](http://www.woodmall.com) to respond to our review. Are we right on the money or way off the mark? Click on the "Interactive Tool Reviews" button, and join the dialogue with the manufacturers and other **WOOD®** magazine readers.

Written by **Dave Campbell** with **Bob McFarlin**  
Photographs: **Baldwin Photography**  
Charts: **Jodi Downing**

# POWER PLAY: RATING THE 15-AMP ROUTERS

## PERFORMANCE RATINGS (7)

ROUTER-TABLE USE										NOISE LEVEL (dB) (8)	CORD LENGTH (FEET)	WARRANTY (YEARS)	COUNTRY OF ASSEMBLY (9)	WEIGHT (POUNDS)	SELLING PRICE (10)	COMMENTS
BIT-CHANGING EASE	DEPTH-STOP ADJUSTMENT	BALANCE	VIBRATION	HEIGHT-ADJUSTMENT	EASE OF CHANGING BITS UNDER 1 1/2" DIAMETER	EASE OF CHANGING BITS OVER 1 1/2" DIAMETER	SWITCH LOCATION AND EASE OF USE	VARIABLE-SPEED CONTROL ACCESS	HEIGHT-ADJUSTMENT							
E	G	F	F	E	E	E	F	G	F	107	10	1	US	12	\$240	A feature-packed router with innovative plunge-lock and spindle-lock mechanisms. 1/2" collet runout high for long or large-diameter bits.
E	E	E	E	G	E	G	G	E	P	104	9	1	IT	13	290	Our favorite model for handheld use. Easy to use and control, and includes a dust-collection shroud. Optional height knob recommended for router-table use.
E	G	G	G	E	E	G	G	G	G	104	7 1/2	1	SP	12	210	Well-suited to both handheld and in-table operations. Price includes a dust shroud and height-adjustment knob.
G	E	E	E	F	G	G	G	G	P	99	8	1	US	12	220	Excellent speed control on this easy-to-use machine, but the base opening is the smallest in our test.
E	F	E	G	E	G	F	G	F	G	98	8 1/2	1	SI	13	270	A nice handheld router. Electric brake stops spinning bits quickly. However, the small base opening makes bit changing difficult when table-mounted.
G	G	G	E	F	G	G	G	G	P	106	10	1	US	17	290	No-frills workhorse suitable for production work. Deepest plunge-depth in the test, but speed control is erratic under 12,000 rpm.
E	G	G	E	E	G	G	E	G	E	106	10	1	US	15	290	The only fixed-base router in our test, but our favorite for table-mounted applications because of its simple height adjustment and base opening. Speed control erratic under 12,000 rpm.
E	F	G	E	E	E	G	G	G	G	101	6 1/2	2	US	14	250	Well-suited to both handheld and in-table applications. The large base opening allows for easy above-table bit changes.

7. **E** Excellent  
**G** Good  
**F** Fair  
**P** Poor

9. (IT) Italy  
(SI) Singapore  
(SP) Spain  
(US) United States

10. Prices current at time of article's production.

8. Measured 18" from router.

### For more information, contact:

**Craftsman**  
800/377-7414  
[www.sears.com/craftsman](http://www.sears.com/craftsman)

**Hitachi**  
800/546-1666  
[www.hitachi.com](http://www.hitachi.com)

**Ryobi**  
800/525-2579  
[www.ryobi.com](http://www.ryobi.com)

**DeWalt**  
800/433-9258  
[www.dewalt.com](http://www.dewalt.com)

**Makita**  
800/462-5482  
[www.makitatools.com](http://www.makitatools.com)

**Freud**  
800/334-4107  
[www.freudinc.com](http://www.freudinc.com)

**Porter-Cable**  
800/487-8665  
[www.porter-cable.com](http://www.porter-cable.com)

## Too new for our review

If you're wondering why we didn't include the Bosch 1615EVS in our test, we've got good news and bad news. The bad news is that Bosch is discontinuing that popular workhorse; the good news is that, by late this fall, the new 1619EVS should be on the market. Chris Carlson from S-B Power Tools brought a prototype of the new router to the *WOOD* magazine shop to show it off, and we found several impressive improvements.

First, Bosch engineers designed a mechanism that allows the user to instantly defeat the plunge springs for table use, then just as quickly restore them for handheld operations. They've also opened up the base for



Chris Carlson (far right) from S-B Power Tool Company shows off the new Bosch 1619EVS router to *WOOD* magazine staff members.

better bit (and wrench) clearance by using a removable base insert for guide bushings. The Bosch 1619EVS

should sell for about \$280, and we promise to test the machine and report our findings in an upcoming issue.



# three-tiered pastry stand

## GREAT AMERICAN HEIRLOOMS

**D**elaware County, located in the southeastern corner of Pennsylvania outside of Philadelphia, was a hotbed of activity during the formation of the nation. Many homes, estates, and farmhouses found here once echoed with the voices of William Penn's followers and the leaders of the American Revolution. Thomas Leiper, a Philadelphia tobacco merchant and politician, built a summer home here in the village of Avondale, near Wallingford, in 1785. The site encompassed the first commercial railway in America, built by Leiper to carry stone from his nearby quarry. This pastry stand, sometimes called a dumb waiter, is modeled after one found in the Thomas Leiper House.



### Let's get the ball rolling

**1** Build the jig for drilling the holes and sanding the flats on the ball (A), as shown in the Drilling and Sanding Jig drawing. See the Buying Guide for a source for the ball.

**2** Place the jig on your drill press, chuck in a  $\frac{1}{2}$ " brad-point bit, lower it into the  $\frac{1}{2}$ " hole, and clamp the jig to the

drill-press table. Nest the ball in the 2" hole and, holding the ball with a handscrew clamp, drill a  $\frac{1}{2}$ " hole all the way through.

**3** Cut off the end of the jig as shown in Step 5 of the Drilling and Sanding

Jig drawing. Insert a  $\frac{1}{4}$ "-long piece of  $\frac{1}{2}$ " dowel in the  $\frac{1}{2}$ " hole in the jig and place the just-drilled ball on the dowel so it rests centered in the 2" hole. This keeps the ball in a vertical position when sanding the three flats where the legs are attached later.

**4** Make three marks on the ball where the two lines on the jig intersect the 2" hole. These marks index the position of the ball in the jig so each flat will be 90° from the adjacent one. Now, holding

the ball firmly in the jig, push it into a disc sander until the end of the jig just kisses the surface of the disc. A miter gauge keeps the jig perpendicular to the disc. Rotate the ball until the index marks align with the jig lines, sand, rotate, and sand once more. There will be three flat areas  $1\frac{1}{16}$ " in diameter.

**5** Place the jig on your drill-press table with the hole end toward the fence. Once again, lower the  $\frac{1}{2}$ " bit into the  $\frac{1}{2}$ " hole in the jig. Move the fence up flush to the end of the jig, secure the fence, and clamp the jig to the table. Replace the  $\frac{1}{2}$ " bit with a  $\frac{1}{4}$ " bit. Now, nest the ball in the 2" hole with one of the flats against the fence and another facing up. Make certain the top flat is horizontal, and drill the  $\frac{1}{4}$ " hole,  $\frac{3}{8}$ " deep. Rotate the ball, always keeping one flat against

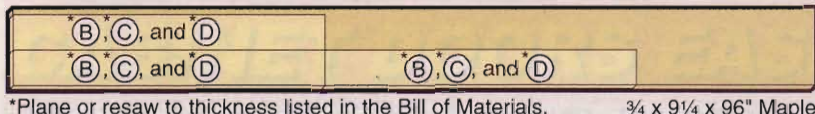

\*Plane or resaw to thickness listed in the Bill of Materials. 3/4 x 9 1/4 x 96" Maple

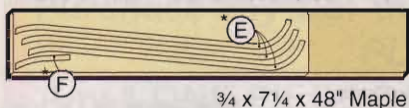

## CUTTING DIAGRAM

## BILL OF MATERIALS

Part	Finished Size			Matl.	Qty.
	T	W	L		
A ball	2 1/4" diameter			HB	1
B top tray*	5/8"	10 1/8" dia.		M	1
C center tray*	5/8"	11 1/8" dia.		M	1
D bottom tray*	5/8"	12 1/8" dia.		M	1
E legs**	5/8"	5/8"	36"	M	3
F front leg***	5/8"	5/8"	7"	M	1

\* Parts initially cut oversize.

\*\* All three legs cut from one blank; see pattern.

\*\*\* Part cut from same blank as (E).

**Materials Key:** HB—hardwood ball, M—maple.

**Supplies:** 1 1/8"-long x 3/32"-I.D. screw eyes (9), 1 1/2 x 1 1/2 x 5/8" corner brace (1), #6 x 1/2" F.H. wood screws (4), #8 x 1/2" F.H. wood screws (9).

### Buying Guide

The following special wood parts are available from Cherry Tree, 800/848-4363: 2 1/4" hardwood ball, no. 49 (1), \$1.10, 1/2" roundhead plugs, no. 103 (12), \$.47, 1/4 x 24" grooved dowel, no. 44-110 (1), \$.40.

The three router bits are available from Woodworker's Supply, call 800/645-9292: Woodtek dish cutter bit, no. 819-306 (1/2" shank), \$28.30, or no. 819-299 (1/4" shank), \$27.25, Woodtek classic plunge cutting bit, no. 819-487 (1/4" shank), \$17.80, Freud #38-522 classical bold fillet cove and bead bit, cat. no. 835-637 (1/4" shank), \$28.65 with no. 802-040 bearing (1/2"-O.D. x 3/16"-I.D.), \$5.95. For the router guide bushings see your local Porter-Cable dealer, call 800/487-8665, or go to [www.porter-cable.com](http://www.porter-cable.com)

the fence, and drill the 1/4" holes in the other two flats.

**6** Glue button plugs into both ends of the 1/2" hole. Cut three pieces of 1/4" dowel 3/4" long and glue them into the 1/4" holes. Wipe off any excess glue. Set the ball aside.

## Three templates equal three trays

**1** Cut three 16" squares from 1/2" plywood for the routing templates for the trays (B, C, D). Mark the diagonals to find the centers. These diagonal lines also are used later to center the tray blanks. Draw the circles for the template holes with a compass, as listed on the Routing the Trays drawing; mark one hole size on each piece of plywood.

*Continued*

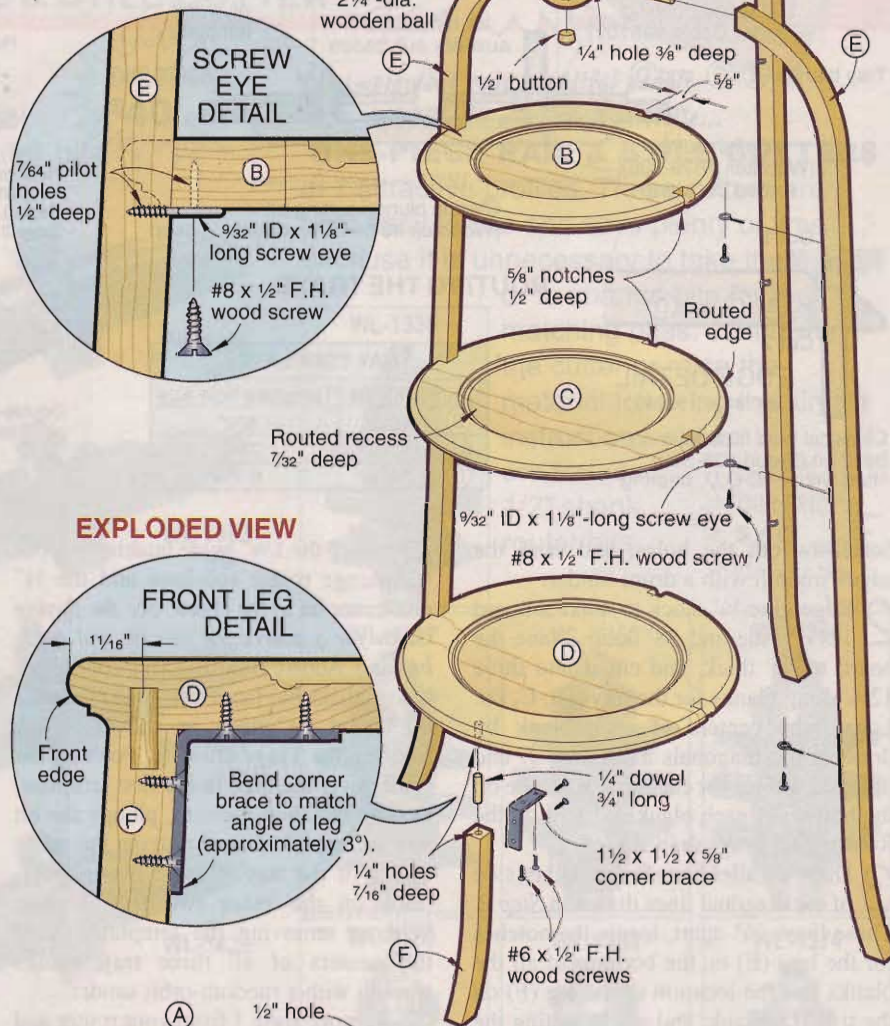

## EXPLODED VIEW

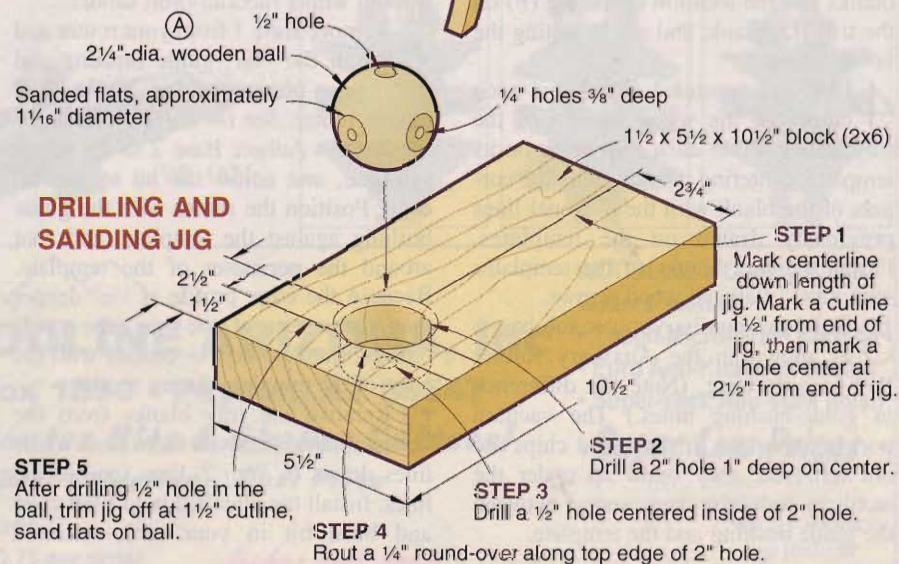
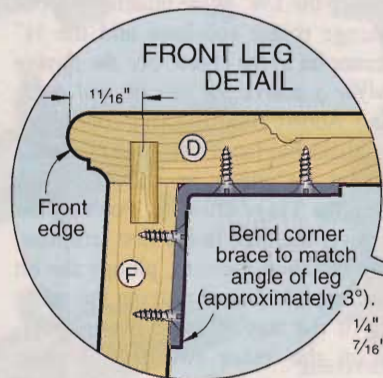

# pastry stand

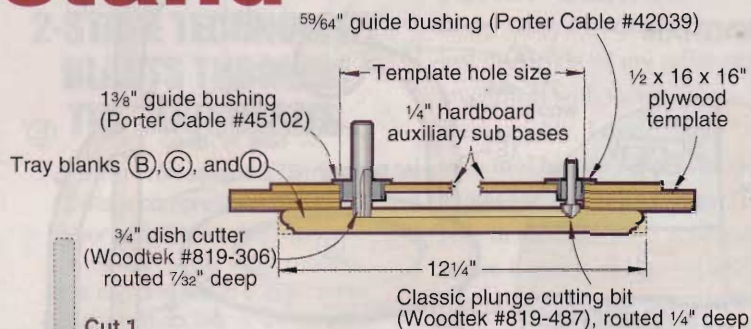

## ROUTING THE TRAYS

TRAY TEMPLATES		
Part	Tray dia.	Template hole size
(B)	10 1/8"	6 7/8"
(C)	11 1/16"	7 13/16"
(D)	12 1/16"	8 13/16"

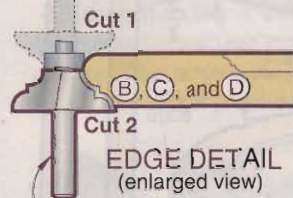

Classical bold fillet cove and bead bit (Freud #38-522), fitted with a 1/2" O.D. bearing

Scrollsaw out the holes, and sand the edges smooth with a drum sander.

**2** Edge-glue 3/4" stock to make a board 12 1/4" wide and 38" long. Plane the board to 5/8" thick, and cut it into three 12 1/4"-long blanks for the trays (B, C, D). Locate the centers of each blank by drawing the diagonals as in *Step 1*, and draw the circles for each tray size, one on the bottom of each blank as listed on the Routing the Trays drawing.

**3** Draw parallel lines 5/16" to either side of the diagonal lines drawn in *Step 2*. These lines, 5/8" apart, locate the notches for the legs (E) on the bottoms of all the blanks and the location of the leg (F) on the tray (D) blank, and aid in cutting the notches later.

**4** Drill countersunk 5/32" holes in each corner of the waste portion of the tray blanks. Place each tray blank on its template, centering it by aligning the corners of the blank with the diagonal lines previously drawn on the templates. Fasten the tray blanks to the templates with #8x1" flathead wood screws.

**5** Build two auxiliary router sub-bases, as shown in the Auxiliary Router Sub-base drawing. (Note the difference in guide-bushing holes.) The vacuum port is important. If the wood chips are not removed, they build up under the auxiliary sub-base and wedge between the guide bushing and the template.

**6** Install the 1 3/8" guide bushing in your plunge router sub-base and the 3/4" dish-cutter bit in the chuck. See the *Buying Guide for a source for this bit and guide bushing*. Adhere Base 1 to your router sub-base with double-faced tape, and adjust the bit to cut 7/32" deep, as shown on the Routing the Trays drawing. Position the router over the hole in the first template, turn on the shop vacuum, plunge the bit into the tray blank, and rout out the entire center of the tray. Repeat these operations on the other two tray blanks. Without removing the templates, sand the centers of all three tray blanks smooth with a random-orbit sander.

**7** Remove Base 1 from your router and install the 59/64" guide bushing and the classic plunge cutting bit in your plunge router. See the *Buying Guide for our source*. Adhere Base 2 to the router sub-base, and adjust the bit to cut 1/4" deep. Position the router with the guide bushing against the template, and rout around the perimeter of the template. Because the edge profile is 1/32" deeper than the center of the tray, the guide bushing must be kept in contact with the edge of the template during routing.

**8** Remove the tray blanks from the templates, bandsaw them close to the lines drawn in *Step 2*, then sand to the lines. Install the classical bold fillet cove and bead bit in your table-mounted

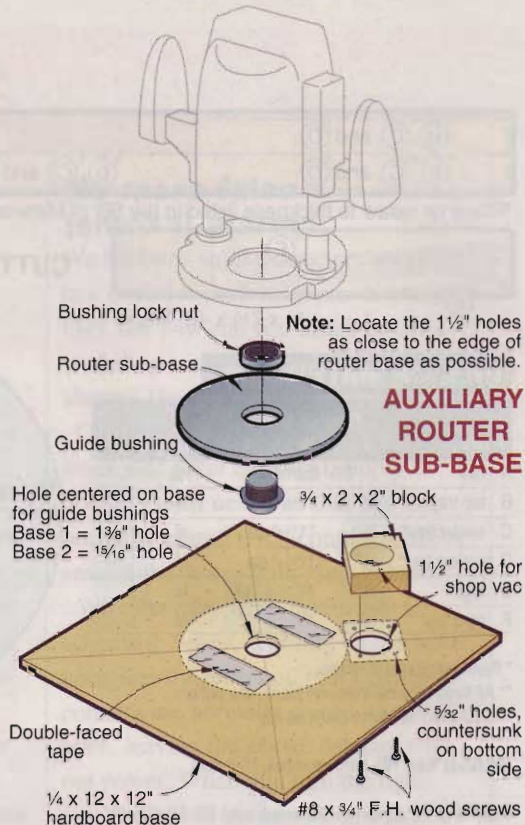

## AUXILIARY ROUTER SUB-BASE

router, and rout the bottom, then the top, profiles on the outside edges of the trays, as shown on the Edge Detail drawing.

**Note:** The 3/8" bearing that comes on this bit must be replaced with a 1/2" bearing. See the *Buying Guide for a source for this bit and bearing*.

**9** Now cut the notches where the legs fit into the edges of the trays. Install a 5/8" dado blade in your tablesaw, and adjust it to cut 1/2" deep. Attach a 4"-high, 18"-long auxiliary fence to the miter gauge so it is centered on the dado blade. Clamp each tray in turn to the auxiliary fence with the bottom facing forward. Use a square to make certain the notch location lines are vertical and aligned with the dado blade, as shown in *Photo A*. Cut three notches in each tray. Finally, drill the 1/4" hole in the bottom tray for the front leg dowel, where shown in the Front Leg detail on the Exploded View drawing. Set the trays aside.

## Four legs to stand on

**1** Plane a 7/4"-wide piece of stock 36" long to fit snugly in the 5/8"-wide dadoes in the trays. Adhere the full-size leg pattern from the *WOOD PATTERNS*® insert to this blank with spray adhesive. Bandsaw the legs close to the pattern lines, then sand to the lines. Before removing the patterns, transfer the screw eye locations on the patterns to the inside

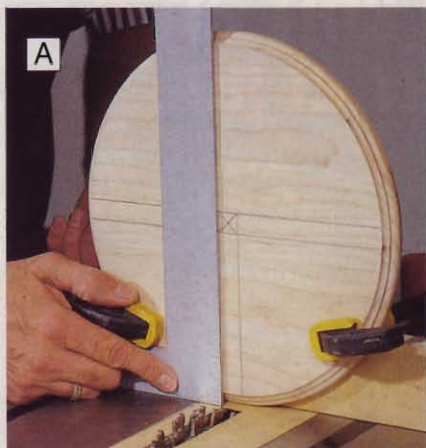

**A** Use a square to position the layout lines vertically and align them with the dado blade.

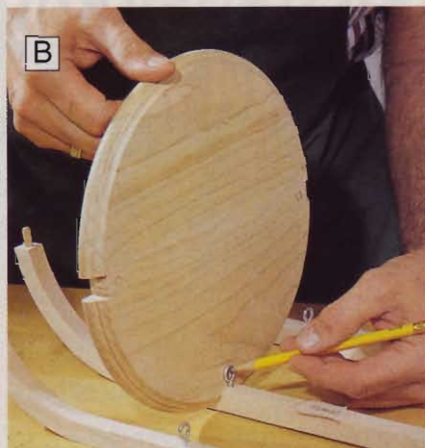

**B** Dry fit the legs in the notches, and mark the locations of the screw pilot holes.



**C** After gluing the leg to the ball, seat it in the notches in the trays.

faces of each leg, and drill pilot holes centered on the width. Remove the patterns.

**2** Mark the center of the top end of one leg (E) and the front leg (F). Chuck a  $\frac{1}{4}$ " brad-point bit in your drill press. Using a wedge to hold the leg at the proper angle, adjust a stop-block and the drill-press fence to center the drill bit on the end of the leg, as shown in the Drilling the Legs drawing. Clamp the fence to the drill-press table and the stop-block and leg to the fence, and drill the hole. Leave the fence, wedge, and the stopblock in place, and use the same setup to drill the dowel holes in the ends of the other two legs (E).

**3** With the drill-press fence in the same position, stand the front leg (F) up so the bottom of the leg is flat on the drill-press table and the top is centered under the drill bit. Clamp the leg to the fence, and drill the dowel hole.

**4** Cut a piece of  $\frac{1}{4}$ " dowel, and glue it into the  $\frac{1}{4}$ " hole in the top of the leg (F). Wipe off any excess glue.

### Three tiers for the final assembly

**1** Finish-sand all the pieces through 320-grit sandpaper. Be sure to remove all pencil marks. If you plan to dye the stand as we did, wet the pieces to raise the grain, let them dry, and sand again with 320-grit sandpaper.

**2** Drive the screw eyes into the pilot holes previously drilled. Mark (on a piece of masking tape) the legs (E) left, center, and right. Now, position the left notch of the top tray (B) over the left leg with the bottom of the tray against the top screw eye, and mark the screw pilot

hole location on the bottom of the tray. Proceed to the center and right notches and legs, and mark the pilot holes, as shown in Photo B. Mark the pilot hole locations in the center and bottom trays (C, D) in the same manner. Drill the holes.

**3** Dry-fit the front leg (F) in the bottom tray (D). Bend the corner brace slightly to match the angle of the leg, as shown on the Front Leg detail on the Exploded View drawing. Mark the locations of the screw pilot holes, remove the leg, and drill the holes in the leg and the bottom of the tray. Set the leg aside.

**4** Clamp the left leg (E) to the workbench with the inside edge up. Attach the three trays by driving screws through the screw eyes in the leg into the pilot holes in the bottoms of the trays. Coat the sides of the hole in the top of the leg with white glue (for longer working time) and attach the ball (A). Apply glue, in turn, to the holes in the tops of the center and right legs, slide each leg onto the dowels in the ball, seat the legs in the tray notches as shown in Photo C, and drive in the screws. Glue and screw the front leg (F) and brace in place.

**5** Place the stand upright and, before the glue sets, use hand pressure to

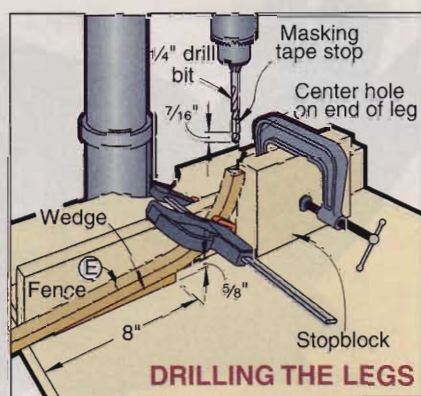

make sure the legs are seated tight to the ball and that the ball is aligned properly.

**6** Apply black water-soluble aniline dye with a foam brush. Experiment on scrap with the concentration of the dye. The goal is to get a dark color but not to completely obscure the wood grain. Finish with three coats of satin polyurethane aerosol spray. Do not sand after the first coat. Sand lightly with 220-grit sandpaper after the second coat.

Written by Jan Hale Svec with Chuck Hedlund  
Photographs: Hetherington Photography;  
Hetherington & Associates  
Illustrations: Kim Downing; Lorna Johnson



### VISITOR information

Thomas Leiper House  
521 Avondale Rd.  
Wallingford, PA 19086  
610/566-6365

April-December, Sat., Sun: 1:00 p.m.-  
4:00 p.m.; weekdays by appointment.  
Admission: \$1.00 adults; \$.50 children

# flight of fancy

It's a bird! It's a bandsawn box! It's a woodworker's whimsy! Whatever you want to call Russell Greenslade's fanciful creation, you'll find that it's a lot of fun to build—and to have around the house.



## Bandsaw the bird's body first

**1** Photocopy the top and side views of the Body Full-Size pattern found in the *WOOD PATTERNS*® insert. Using rubber cement or spray adhesive, adhere the top-view pattern to the top edge of a 1¾×4¼×12¾" blank. (We cut our bird's body from cocobolo.)

**2** Bandsaw the outline of the pattern. Reattach the cut-off sides to the blank with double-faced tape, as shown in *Photo A* on the *opposite page*. Slide the cut-off pieces back to make a flat surface, as shown.

**3** Adhere the side-view pattern to the blank. Align the end of the tail on the side pattern with the tail end of the blank. The pattern will overhang the sides of the blank at the tip of the beak, as shown in *Photo B*.

**4** Transfer the centers for the leg holes from the top-view pattern to the bottom of the blank. Drill the eye, hinge, and leg holes in the body.

**5** Bandsaw the outside pattern outline, as shown in *Photo C*. (We installed a ⅛" bandsaw blade for both the inside and outside cuts.) Saw slightly outside the pattern line, then sand to the line. (We sanded to the pattern line with a 1" benchtop strip sander.)

**6** Following the arrows on the pattern, bandsaw the inside of the box, as shown in *Photo D*. Free the lid with a final cut in from the back of the body, as shown in *Photo E*.

**7** Sand the inside of the box and the lid. A spindle sander will do most of the job, but you'll need to hand-sand the corners with a sandpaper-wrapped dowel. Peel off all patterns.

## The wings make the box sides

**1** Laminate two ¼×3⅛×6½" wing blanks together with double-faced tape. (We cut the wings from bocote.) Put the best faces to the inside.

**2** Adhere a photocopy of the Wing Full-Size pattern to one face of the stacked blanks. Transfer the hole center to the other face of the stack. Drill the ⅛" hole ⅛" deep in each blank.

**3** Bandsaw or scrollsaw the wings to shape. Sand the edge as needed, and remove the pattern.

**4** Scrollsaw or bandsaw the handle from ¾" stock. Lay a piece of 100-grit sandpaper abrasive side up on the lid. Then, position the handle on the lid where shown, and slide the handle from side to side, sanding its bottom contour to match the lid's curvature. Glue the handle to the lid.

**5** Glue and clamp a wing to one side of the body, locating it where indicated on the body pattern. The hole in the wing should face toward the inside of the box.

**6** Cut a 2" length of ⅛"-diameter brass rod for the hinge. Slide the rod through the hole in the lid, and insert one end into the hole in the installed wing. Without gluing, clamp the other wing in place, trapping the brass rod's other end

in its hole. Open and close the lid. If it binds against the wings, sand its edges to allow free movement.

**7** With the lid in place, glue and clamp the other wing to the body.

### Add the feet, and finish the box

**1** Cut two 8" lengths of 1/4" dowel for the legs. (You could stand your bird on shorter legs, if you like.) Since we built our box from exotic woods, we decided to make our own bocote dowels for the legs. If you want to make your own leg dowels, here's how.

Start with a 1/4x1/4x12" blank for each dowel. Chuck a 1/8" round-over bit in your table-mounted router, and set a fence. Clamp stopblocks to the fence 4 1/2" from each side of the bit. (This stops the cuts short of each end, leaving the ends of the workpiece square for easier control on the router table.)

Using a pushstick and holding the stock against the fence and router table with featherboards for safety, round over the four corners of the blank. Hand-sand as necessary. Cut off the ends, and trim the dowels to length.

**2** Photocopy the top and side views of the Feet Full-Size patterns. Adhere the top-view pattern to a 7/8x2 3/8x4 1/4" blank. (We cut the blank out of scrap-wood left over from the body.)

**3** Drill two 1/4" holes 1/2" deep for the legs, where shown.

**4** Bandsaw the pattern outline. Tape the cut-off pieces to the sides of the blank, as you did for the body.

**5** Apply the side-view pattern. Cut the feet to shape. Remove the patterns, and sand away the saw marks.

**6** Glue the legs into the body holes and the feet onto the legs.

**7** Drill a centered 1/16" hole 1/4" deep into the large end on each of two 7/32" toy axle pegs. Glue the pegs into the eye holes, where shown on the Exploded View drawing.

**8** Finish-sand the completed box with 120-, 180- and 220-grit sandpaper. Apply a clear finish overall. (We put two coats of antique oil finish on our box.)

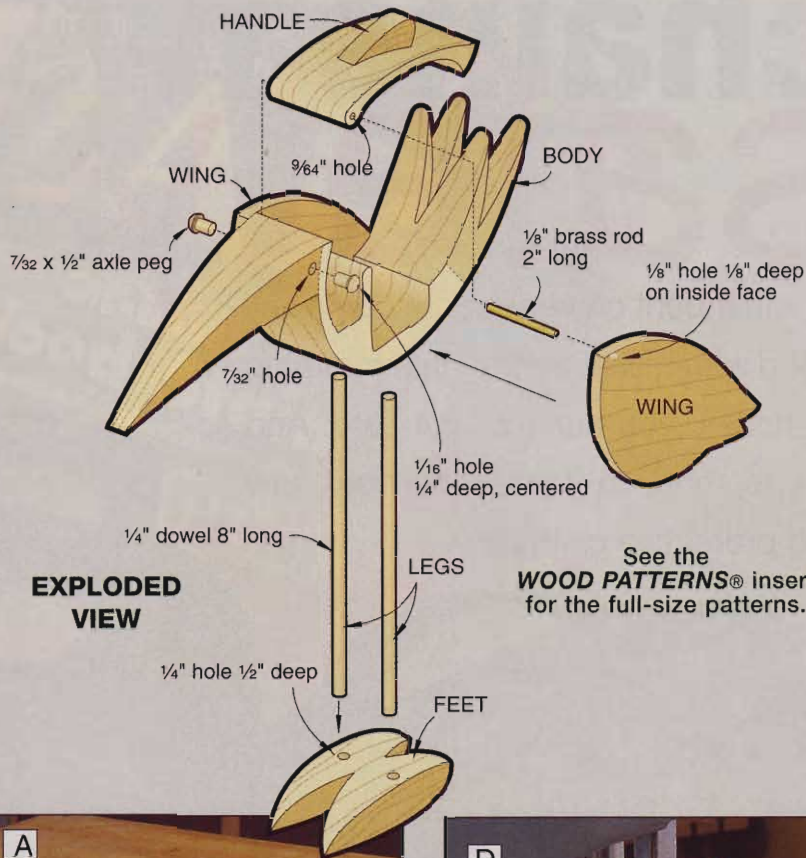

**EXPLODED VIEW**

See the **WOOD PATTERNS®** insert for the full-size patterns.



**A** Tape the sawn-off sides back onto the blank to provide flat surfaces for pattern attachment and sawing.

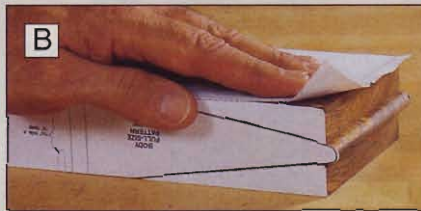

**B** The side-view pattern will extend past the taped-on side. Cut smooth curves out to the tip of the beak.



**C** To saw a sharp corner, cut into it from both directions. Carefully stop each cut at the pattern line.

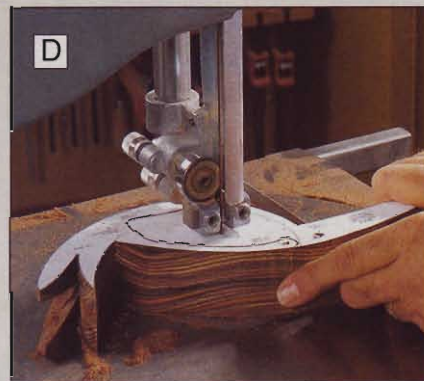

**D** A 1/8" bandsaw blade will help you saw the sharp inside corners in the box.



**E** Make the final cut to free the lid as a smooth continuation of the curve that comes down the top of the tail.

Project Design: © Russell Greenslade  
Illustrations: Roxanne LeMoine; Lorna Johnson  
Photographs: Hetherington Photography

# chainsaw safety

Whether bent on harvesting your own wood with a chainsaw or just trimming branches, you must play it safe. And there's more to it than the right saw and protective clothing.

## how to fell a tree

Although the specific technique that professionals use to fell a tree can vary from region to region and even species to species, it generally has three components—**THE SCARF**, **THE BACKCUT**, and **THE HINGE**, as shown in the drawing at *far right*.

Before making any part of the felling cut, plan ahead for where you want the tree to fall—never into other trees or fallen timber.

Also look for obstacles that might block its fall or change its direction, and



remove them. "It's a good idea to fell a tree in the direction of its lean, too, if it has any," says Mike Bounds, Director of Product Safety for Poulan chainsaws at the company's Engineering Innovation Center in Texarkana, Arkansas. "But you need to use something to verify how the tree is standing. A tree could look like its leaning because it's on uneven ground, yet be growing straight. To check for lean, take an ax and set it on the ground head down and see how it lines up with the tree."

Next, check your escape route. It should be 45° to the rear of the expected direction of fall. Clear the path of undergrowth, fallen branches, and any-

thing else that could trip you. Then, and only then, determine where the scarf should go, cut it, and remove the resulting triangle-shaped piece of wood.

Finally, do the back cut, making sure you leave a hinge. "The angled cut of the scarf should leave the hinge intact as the tree falls all the way to the ground, providing the most control," notes Bounds. "Cutting less of a scarf to conserve wood in the butt of the tree lessons control and the tree can twist and change direction as it falls. After you've made the back cut, shut off the saw, place it on the ground, and move quickly—but don't run—down your escape route."

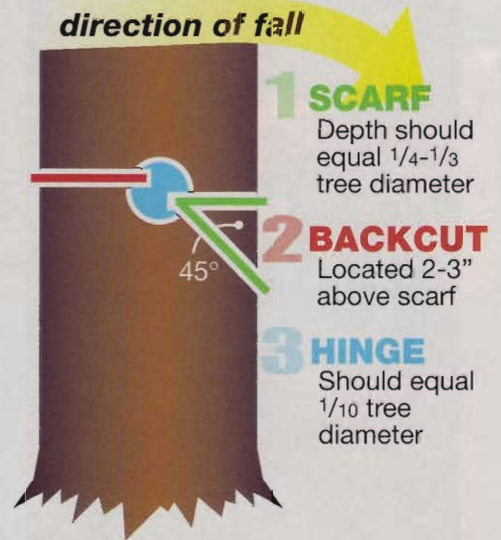

## the kickback zone

According to safety experts at Oregon Cutting Systems, a leading manufacturer of saw chains and guidebars, bar-nose kickback ranks as one of the major causes of serious chainsaw injury, and Mike Bounds agrees. "Kickback is the instantaneous reverse reaction that kicks the guide bar up and backward toward the operator when the moving chain at the top tip of the guide bar touches an object, or when the wood closes in and pinches the chain at that spot," he explains.

"A chain brake won't prevent kickback," Bounds continues. "It only stops the chain from moving." Those experienced with chainsaw operation call the area of the guidebar highlighted in the photo at left the "kickback zone," and avoid making cuts with that portion.

This woodworker turned timber faller holds the wood cut from the scarf of a white oak tree he's about to drop. His protective hard hat includes a mesh visor and sound-reducing ear muffs.

## safety gear suggestions

A chainsaw that reduces fatigue—the factor behind many accidents—has the lightest weight for the amount of engine size needed for the job. It also should feature a system to reduce the amount of vibration delivered to the handles, as well as a reliable chain brake, reduced-kickback guidebar, and low-kickback saw chain.

### Protective clothing

To guard against injury, the Occupational Safety and Health Administration requires that chainsaw operators employed by logging companies wear:

- Pants or chaps made from chainsaw-resistant material
- Safety glasses or goggles
- Hearing protection (NRR of 23-25 dB)
- Hard hat

For only occasional chainsawing, though, you might not want to go to the expense of chainsaw-resistant chaps, but do plan on wearing the other items. And to those add steel-toed boots or shoes, and non-slip gloves. (Cut-resistant ones are available, and can be combined with forearm-protecting sleeves.) Then, keep on your toes to avoid injury.

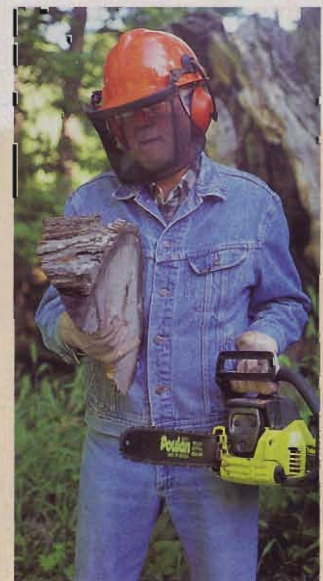

Continued





## a dozen chainsaw safety tips

- 1 Never run a chainsaw when tired, after drinking alcohol, or when taking medication.
- 2 Be sure to read the manufacturer's operating and safety instructions.
- 3 Just as when ripping wood on a tablesaw, stand slightly to the side of the chainsaw when limbing and bucking in case it kicks back. Grip the handles firmly, with the right hand on the throttle handle and the left on the front handle, even if left-handed.
- 4 Always run a chainsaw full throttle when cutting.
- 5 Never cut above shoulder height or over-reach to make a cut with a chainsaw.
- 6 Beware when cutting slender shoots and branches. The chain may catch and whip them toward you.
- 7 Unless trained, don't operate a chainsaw in a tree or from a ladder.
- 8 Never hand-hold wood to saw or have someone else hold the wood. It's possible for a chainsaw to "skate" across the wood and into a hand.
- 9 Maintain proper chain tension. A loose chain can come off and strike you.
- 10 Never try to cut with a dull saw chain. When a chain produces dust rather than chips, it's dull.
- 11 Carry a chainsaw with the engine off and the guidebar to the rear.
- 12 Don't work in the woods alone. And keep your helper two tree lengths away when felling a tree.

## limbing and bucking safely

### anatomy of a normal limbing cut

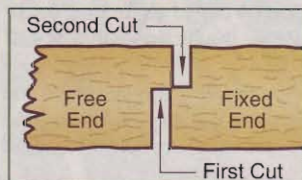

In second cut, the chain bar comes to rest on the holding wood as the limb falls free.

### limbing and bucking stress factors

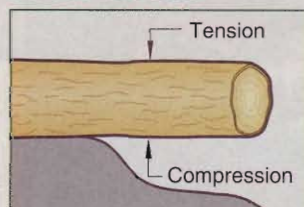

Wood held on one end.

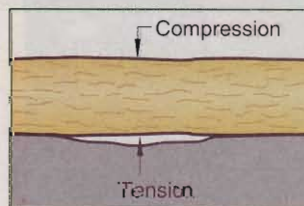

Wood supported on both ends. (Always make the first cut on the compression side.)

After the tree hits the ground, look for any probable hazards that it may have created. Dead or broken-off limbs overhead in a nearby tree might fall due to the activity. Small saplings bent to the ground by the fallen tree can spring back when you relieve the pressure through further sawing for limbing and bucking (crosscutting the trunk into manageable log lengths, as shown above).

As shown in the drawings at left, a fallen tree has stresses created by its fall. You must be aware of these when limbing and make your chainsaw cuts accordingly. For instance, on a limb sticking straight out from the trunk, you'd make your first cut on the side facing the ground. This relieves compression stress. Your second cut, on top of the limb and slightly offset from the first, relieves tension as it frees the limb. Remember, that the first cut is always on the compression side.

Following limbing comes bucking the trunk. For large-diameter trunks intended for further milling into boards, you must determine the length of the logs you can or want to handle based on any visible defects. That is, a big knot or rotten bowl shouldn't end up in the middle of what will eventually become a board. And because the trunk rests directly on the ground, you have to saw through from the top, beginning at the butt (lower end).

"Keep in mind that the most common injury in logging comes from getting hit by a branch or part of the bucked log as it rolls," says Poulan's safety director. "So just as in felling the tree, you must calculate what each piece of wood will do when it is free of the tree. And during the limbing and bucking process, never let the saw chain contact the ground. It travels faster than 50 mph and will immediately dull."

Photographs: BakJwin Photography; P. Stephano; Wm. Hopkins  
Illustrations: Brian Jensen; Lorna Johnson

# exact-width dado jig

Here's a jig for routing bookcase or cabinet-side dados that exactly match the thickness of your shelf stock. Better yet, no special bits are needed. Just use an ordinary straight bit and a guide bushing. (We used a 1" guide bushing and a 1/2" straight bit.) To start, cut a 3/8" rabbet 3/8" deep along the inside edge of both guide rails (A). Then complete the jig as shown in the drawing, below, right. To customize the rails for a different bushing and bit, install them in your router and trim the protruding lip of the rabbet in the guide rails, as shown in the Dadoing Detail. The remaining lip will now match your bushing/bit combo.

To adjust the jig for the exact width of your shelf stock, slip the jig over the shelf stock as shown in the Adjusting the Jig drawing. Pull the guide rails (A) tightly against the stock, and tighten the wing nuts. Slip the jig off the stock, and clamp the jig onto the piece being dadoed, centering the opening between the rails (A) over the marked dado on the side panel. Adjust the depth of cut with your router sitting on top of the rails. Start the router and make one pass with the guide bushing riding against one of the rabbeted rails. Make a second pass riding the bushing against the opposite rabbeted rail. ♣

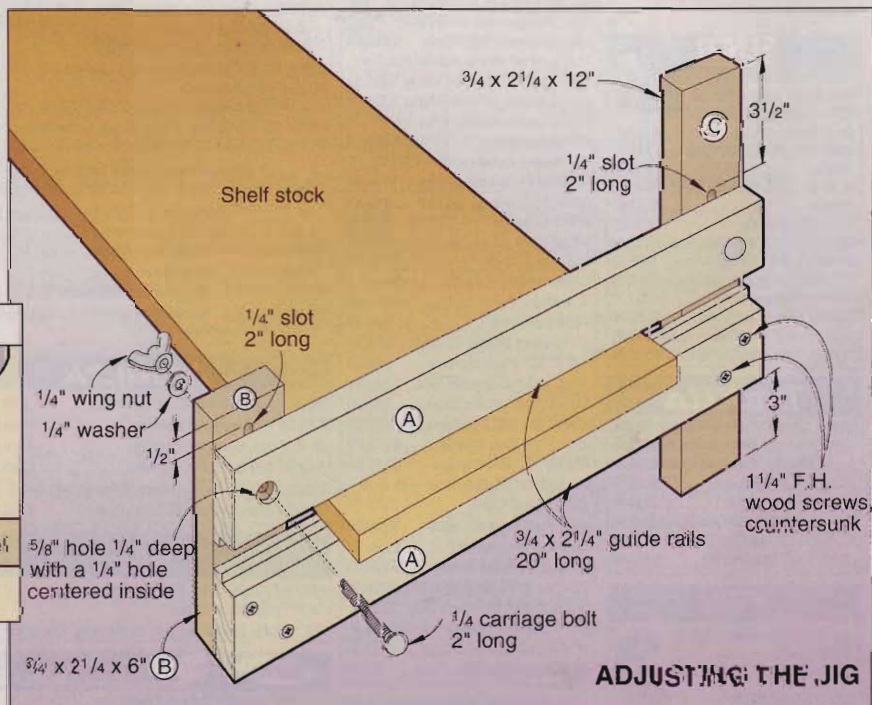
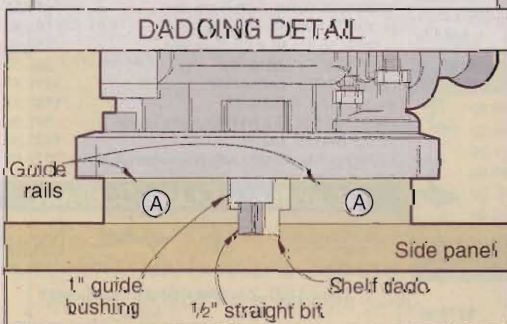

Project Design: Wayne Kovi, Wallingford, Conn.  
Illustrations: Roxanne LeMoine  
Photographs: Metherington & Associates

## Have a question?

If you're searching for an answer to a question that you think would interest lots of other readers, write a letter to:

Ask **WOOD**®, 1716 Locust St., GA310, Des Moines, IA 50309-3023.

For an immediate answer to your question, get help from fellow woodworkers by posting it on one of our internet discussion groups at: [www.woodmagazine.com](http://www.woodmagazine.com)

### With exotic woods, eliminate the oil, then finish

**Q** I'm working on a couple of projects using rosewood and cocobolo. One problem: I can't get the polyurethane finish to dry. Where did I go wrong?

—Gordon Sawyer, Pine Haven, Wyo.

**A** You have two choices, Gordon: Be patient or start over. The natural oils in those woods have mixed with your finish, which makes it tough for the polyurethane molecules to link up and form a hard layer.

The finish will dry eventually, and more quickly in a warm room than a cool one. Or, choice two, strip your projects with an ATM (acetone, toluene,

methanol) stripper, and try again. The key to finishing rosewood, cocobolo, teak, and other oily exotics is to first remove the oil from the surface. Wipe the wood with naphtha or lacquer thinner, wait five minutes to let the solvent evaporate, then brush on the varnish. It will dry before more oil can work its way to the surface.

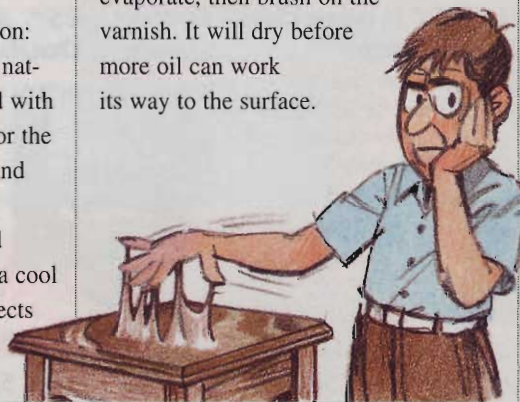

### TLC for cordless-tool batteries

**Q** Some of my cordless tools sit for as long as six months without being used. Does this damage the batteries? What's the best method for storing these batteries, and what's their life expectancy?

—D.W. Walton, Delta Junction, Alaska

**A** D.W., we took your questions to Lou Vassos in the engineering department at Bosch, and he

says you're okay leaving those batteries sit. Nickel-cadmium batteries, the standard of the cordless world, lose a little charge every day and will just about run out of juice in six months. But all you have to do is recharge them, because they won't have suffered any damage. If you leave them idle for a year or two, they won't attain their full capacity with a single recharge—but they'll recover after two recharges.

The best way to store cordless tool batteries is at or below room temperature. All kinds of factors go into determining the lifespan of a battery, but the typical home woodworker can expect to get 5-10 years out of each one.

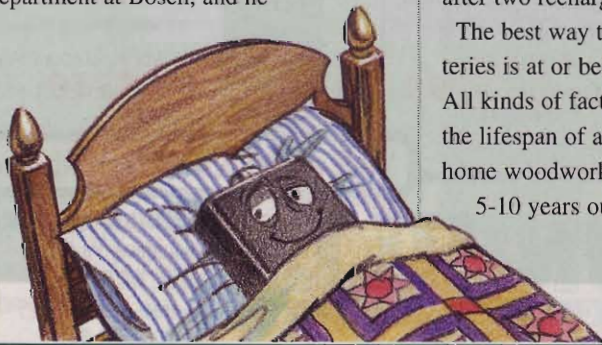

### Chasing foul odors from wood

**Q** We bought an old poplar chest that a previous owner had loaded with mothballs. We've tried a number of ways to get the smell out, but without success. Is there a way to deodorize the wood?

—James Knap, Lynchburg, Va.

**A** Jim, you'll get the best results by taking the chest to a fire restoration company that has an ozone machine. This machine uses electric charges to turn standard oxygen molecules into ozone molecules. Ozone does a great job of absorbing all kinds of odors, including smoke, perfume, and food. Check under "Fire and Water Damage Restoration" in the Yellow Pages to find a fire restoration company nearby.

Your second-best option is to place charcoal or baking soda in a bowl, and set it inside the chest for several days. This method probably won't remove every last trace of the smell, so follow up with one or two coats of shellac to seal the rest of it inside the wood.

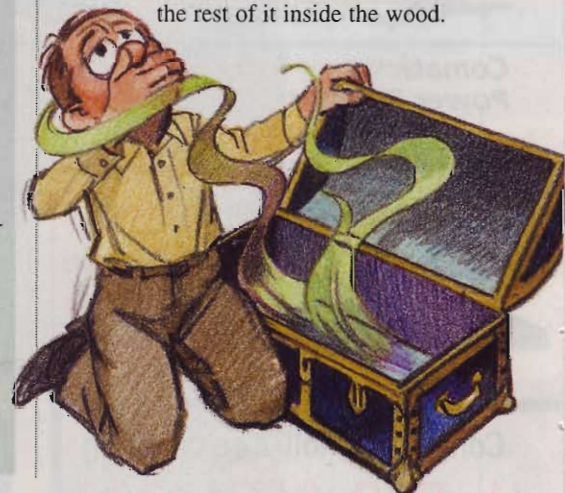

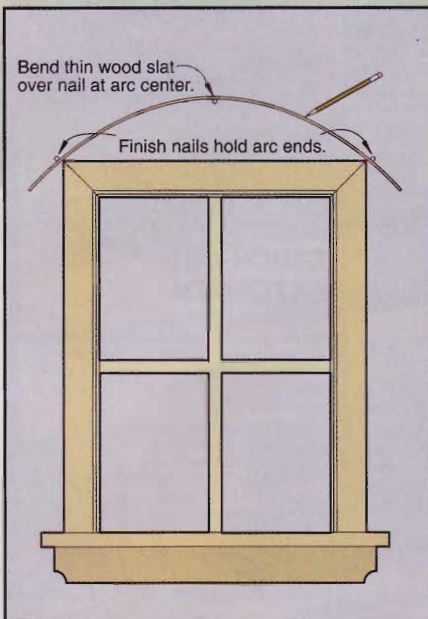

### A reader needs help with arc layout

**Q** Is there any way to measure and lay out an arc or "half-moon" over a window or doorway? I don't want a full circle, just an arc, and rigging up an oversize trammel or compass isn't practical. I can manage by trial-and-error, but I'd like to find an easier way to get decent results.

—Garry Liberty, Aylmer, Que., Canada

**A** Having the arc height and width is half the battle, Garry. With the dimensions you provided in your sketch, it's possible to modify a simple technique we've used on plywood and other large panels—bending a thin strip of wood between two finish nails. For this trick to work over a door or window, you need to place a nail at the center of the arch, at the height you want. Next, bend a 1/8" or thinner wood slat over the nail so the end portions of the slat touch the top corners of the window; then pin the ends in place.

If you don't know how tall you want the arc, bend the slat to the corners and adjust the height until you get the look you want. Then pin the ends and follow the slat curve with a pencil to trace the arc. 🌲

## STEVE WALL LUMBER CO.

Quality Hardwoods and Woodworking machinery For The Craftsman and Educational Institutions

Ash.....	4/4	Select	2.25	.....	\$ 77.00
Basswood.....	4/4	Select	1.95	.....	\$ 63.00
Birch.....	4/4	Select	2.50	.....	\$ 81.00
Butternut.....	4/4	1C	2.20	.....	\$ 69.00
Cherry.....	4/4	Select	4.20	.....	\$ 98.00
Hickory - Pecan.....	4/4	Select	2.30	.....	\$ 72.00
Mahogany (Genuine).....	4/4	Select	3.70	.....	\$ 98.00
Maple (Hard).....	4/4	Select	3.15	.....	\$ 85.00
Maple (Soft).....	4/4	Select	2.20	.....	\$ 72.00
Poplar.....	4/4	Select	1.75	.....	\$ 64.00
Red Oak.....	4/4	Select	2.40	.....	\$ 80.00
Walnut.....	4/4	Select	3.45	.....	\$ 95.00
White Oak.....	4/4	Select	2.40	.....	\$ 80.00
Cedar (Aromatic Red).....	4/4	1C+Btr.	1.65	.....	\$ 66.00
Cypress.....	4/4	Select	2.25	.....	\$ 74.00
White Pine.....	4/4	F.G.	1.15	.....	\$ 55.00
Yellow Pine.....	4/4	Clear	1.80	.....	\$ 65.00

Above prices are for 100' quantities of kilndried rough lumber sold by the Bd. Ft. FOB Mayodan, NC. Call for quantity discounts. Other sizes and grades available.

Above prices are 20 bd. ft. bundles of clear kilndried lumber 3"-10" wide • 3'-7' long (Random widths & lengths) Surfaced 2 sides or rough. Delivered UPS prepaid in the Continental U.S.

**UPS  
Specials**

**SEE OUR  
CATALOG ON  
THE WEB!**

**\*NOW AVAILABLE\***

**Custom Made  
Raised Panel  
Doors**

4/4 Log Run  
Walnut  
100 bd. ft. \$155

Also Available  
Exotic Lumber

**STEVE H. WALL  
LUMBER CO.**

BOX 287  
MAYODAN, N.C. 27027  
336-427-0637  
1-800-633-4062  
FAX 336-427-7588

Email: wood@walllumber.com  
Website: www.walllumber.com

Send \$1.00 For Lumber Catalog  
Prices Subject to Change Without Notice

Circle No. 592

**Buy Factory Direct and Save Thousands!**

# Woodworkers Dreamshop



**SAVE UP TO  
\$5,000.00  
ON STEEL  
BUILDINGS**

**SAVE THOUSANDS  
ON SELECT SIZES**

25x34 • 30x46 • 40x56 • 50x116

Additional sizes available.  
Proudly made in the USA.

- 20 Year Guarantee
- Build it yourself
- Maintenance Free
- 100% Useable Space

**CALL TODAY  
1-800-463-6062**

**U.S. Buildings®**

**FREE PRODUCT CATALOG  
AND FACTORY PRICE LIST**

**www.us-buildings.com**



## These stops are cool under the collar

I've never much liked monkeying around with the depth stop on my drill press. That's why, when I want a precise boring depth, I like to attach a stop collar to the bit. But metallic collars tend to burnish or burn my workpiece when



they make contact, like the foreground holes shown in the photo *below left*.

However, the metal never touches the wood with SlipStop collars. Instead, a polymer cap does the duty, and it's separated from the stainless-steel collar by a low-friction washer. No matter how fast the bit spins, the cap stops turning when it contacts the workpiece, resulting in accurate, burn-free boring, as shown in the background holes in the photo.

Regardless of the material I used, how fast I bored, how hard I pushed, or how long I left the stop touching the work, I couldn't get the SlipStop collars to burn.

Although, just as with all-metal collars, an errant wood chip occasionally got trapped between the collar and the wood, burnishing my workpiece slightly. I tested a set of six collars for use with bits ranging from 1/8"-1/2"; you also can buy them individually.

—Tested by Bob McFarlin

### PRODUCT SCORECARD

#### SlipStop collars

Performance	★★★★★
Price	\$23, set of six; about \$4 each
Value	★★★★☆

Call Woodworker's Supply at 800/645-9292.

## Incra-eased miter accuracy

If a woodworker had written the old saying, it might have read: Build a better miter gauge and the world will beat a path to your door. The well-thought-out Miter Gauge by Incra may be such a path maker.

For starters, the Miter Gauge's reversible, laser-cut, 60° protractor has a toothed edge and a single-tooth pawl that engages the teeth to locate a miter angle. The valleys between the teeth are spaced at precise 1° increments (except for 22.5°, which has its own), allowing you to lock in any whole-number miter angle.

Need something in between? No problem. Release the pawl and eyeball the miter. Or switch the Miter Gauge's push-handle to its slotted position and make precise 1/2° swings either way (or gently tweak to anywhere in between). Just remember to switch the handle back to its fixed position before you set up for your next cut—that fractional adjustment doesn't show up on the

protractor gauge and could mess you up.

The 27" extruded-aluminum fence is typical Incra. You square it to your blade by adjusting three hex head screws, and can reposition it on the head anywhere along its length. Racks on the back of the fence mate with racks on the work stop to provide 1/32" steps, which you can further hone using a screw on the stop. The Miter Gauge's stop has one other feature I've not seen anywhere else: You can attach an auxiliary face up to 3/4" thick to the fence, and still use the stop.

In order to tune the Miter Gauge to your individual saw, you'll need to spend a fair amount of time in the initial setup stage. For example, the six nylon adjusting rings along the length of its 20" bar allow you to remove play between the bar and your saw's miter slot. But I had a hard time finding just the right balance between "stuck" and

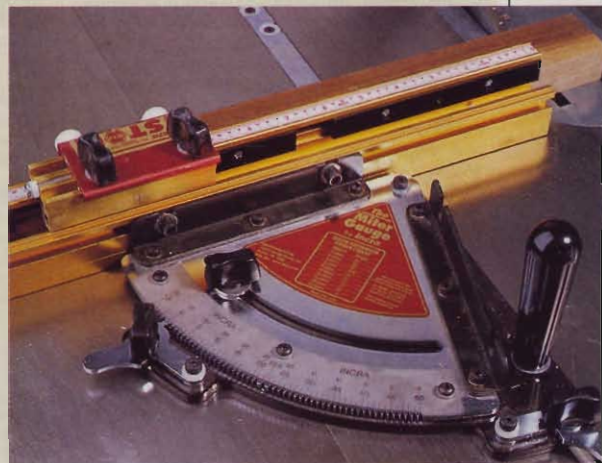

"sloppy." The well-written instruction manual helped greatly, though.

—Tested by Dave Henderson

### PRODUCT SCORECARD

#### The Miter Gauge by Incra

Performance	★★★★★
Price	\$180, includes miter gauge, 27" fence, and stop; \$50, 52" fence
Value	★★★★★

For more information, call Taylor Design Group at 972/418-4811, or visit [www.incra.com](http://www.incra.com).

Continued on page 101



Continued from page 98

### Take the pressure off your truck-owning buddy

Last fall, a man pulled up to the *WOOD*® magazine doors with a trailer-load of some of the prettiest curly maple I'd ever seen. Previously, I might have had to pass up that kind of offer (or borrow a pickup) because I had no way to get 140 board feet of maple into my sport-utility vehicle. But this time, I had an Extend-A-Truck load support tucked under the back seat. After a quick assembly, I inserted it into my SUV's receiver hitch, and started piling on the maple.

The T-shaped support on the Extend-A-Truck levels to your vehicle's cargo bed. And at 48" wide, it'll handle sheet-goods if the opening in your vehicle is wide enough. Need to haul your extension ladder to a buddy's house? Strap it to the Extend-A-Truck, and you're on the road in seconds without having to figure out how to secure it to the roof rack.

But it's not for use just with SUVs: You can put it to work on any vehicle with a Class III-type hitch. As long as you keep the support level with the bed of your truck, and the weight is evenly distributed, this thing will safely hold nearly three times the bar's 350-pound weight rating.

—Tested by Chuck Hedlund



#### PRODUCT SCORECARD

##### Extend-A-Truck

Performance	★★★★★
Price	\$119
Value	★★★★★

For a dealer near you, call Darby Industries at 800/344-2472.

Continued on page 102

**MAKE YOUR BED.**

**PACE EDWARDS**

Pace Edwards offers the most innovative and stylish truck accessories on the market, like our Roll-Top-Cover™ and our new BedLocker™ electric retractable cover.

Pace Edwards ... products for today's trucks!

1-800-413-8378 [www.pace-edwards.com](http://www.pace-edwards.com)

Circle No. 1985

## For Over Fifty Years, We've Been Building a Reputation As The Leader in Adhesives



It's a reputation built with reliable high quality products that people everywhere know and trust. For all these years, you've trusted Elmer's to produce the best products for a variety of projects. We're proud of that reputation, but we're constantly improving based on what you tell us you want or need. Now we're even better because we've made selecting and using the right product easier than ever. Tried and true, Elmer's delivers a consistent, dependable and easy solution for all your woodworking and home repair needs.



**PROBOND™**

Elmer's Products, Inc.  
180 East Broad Street, Columbus, Ohio 43215  
[www.elmers.com](http://www.elmers.com)



© Elmer's Products, Inc., 2000

Continued from page 101

## Now, a compact disc sander

Need a large abrasive area for cleaning up miter joints and the like, but don't have the money (or space) for a stationary belt/disc sander? Delta's 12" disc sander fills the bill quite nicely.

Besides the capacity to abrade stock up to about 6" wide, this heavy bench-top unit brings other worthy features to the table, too. For example, the fly-wheel-aided platen might take hours to spin to a stop if weren't for the hand brake—a small lever that, when pressed, halts the platen in seconds. And the fan-assisted dust-collection shroud on this unit, when attached to a shop vacuum with the included 42" hose, was the most effective I've yet seen.

The 6¼×17¼" table can tilt 45° up or down, with an adjustable stop at 0°.

Ratcheting levers on either side of the table lock the angle—I found the lever next to the dust port a little hard to operate with the hose in place. With the table tilted up, it seems like you run the risk of trapping your workpiece, but a Delta spokesman told me some woodworkers actually prefer this kind of captured position for accuracy.

Speaking of accuracy, you can parallel the table's miter slot to the platen fairly easily, thanks to four hexhead screws in the tabletop. But the table-to-platen spacing varied depending on the table angle, so I had to use those screws more than I would've liked to maintain the proper spacing.

Table issues aside, the Delta 31-120 disc sander felt very well balanced, and

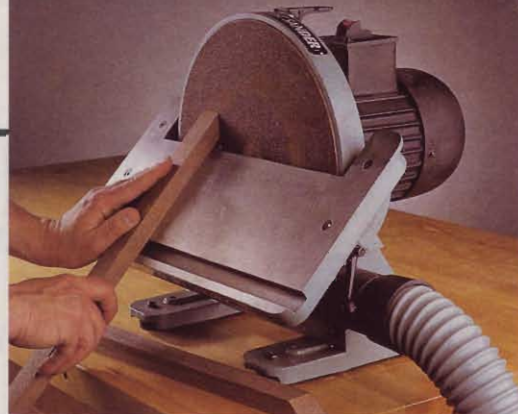

I didn't feel a lick of vibration in use. The weight of this machine and its rubber feet make it virtually "wander-proof," but holes are provided to bolt it down for more permanence. 🛠️

—Tested by *Erv Roberts*

### PRODUCT SCORECARD

#### Delta 31-120 Disc Sander

Performance	★ ★ ★ ★ ★
Price	\$170
Value	★ ★ ★ ★ ★

For more information, call 800/438-2486, or visit Delta's website at [www.deltamachinery.com](http://www.deltamachinery.com).

# No Shortcuts

**NEW DESIGN!** Specifications in new Katana bits equal or exceed any now on the market.

**INCLUDES A LIFETIME GUARANTEE!**

- 1 Unique new **Safety Gauge Shank™**.
- 2 Premium **micro-grain carbide** yields a longer cutting life.
- 3 **Diamond honed** to a 600 grit mirror finish on CNC grinders.
- 4 **Non-stick coating** baked on to prevent residue build up.
- 5 **Precision ground** to a tolerance of +/- .005".
- 6 **High hook and shear angles** produce a clean cut.
- 7 **Anti-kickback design** forces smoother entry into stock.
- 8 **Balanced in excess of 25,000 RPM** for smooth routing.



FREE SHIPPING

**FREE CATALOG!**  
**1-800-533-9298**

**KATANA™**

3 PIECE RAISED PANEL  
DOOR SET • 1/2" SHANK  
**\$129.95**  
ORDER ITEM #14502  
WOOD BOX INCLUDED

[KATANABITS.COM](http://KATANABITS.COM) • AN MLCS COMPANY P.O. BOX 4053, RYDAL, PA 19046

Circle No. 1350, 2250

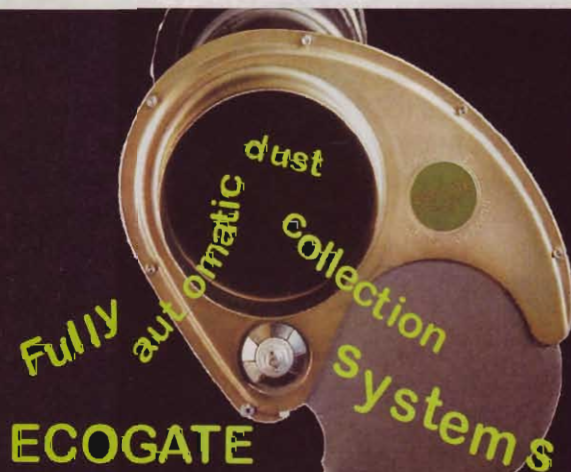

**ECOGATE**

The ECOGATE System is a revolutionary idea in dust collection. When a machine is turned on, a sensor signals the controller to open the appropriate gate and turns on the dust collector. When the machine stops, the gate closes. Our larger model monitors the usage of all machines in your shop and continually optimizes the amount of power supplied to your dust collector. And that generates dramatic savings. We are going to demonstrate the ECOGATE System at WFF 2000 in Atlanta (on August 24th through the 27th). Our booth number is 26421.

Call 1-888-ECOGATE for a free brochure. [www.ecogate.com](http://www.ecogate.com)

**ECOGATE®**

Circle No. 1230

# NEW YORK woodworker works ancient stock



Sometime during the 6th century, a mudslide felled some trees along western New York's Genesee River.

Today, Perry, New York, woodworker Thomas Pedlow works wood from those trees into boxes and other items.

As Tom tells it, a few years back Don Eckler, left, a Perry-area landowner, discovered some tree trunks peeking from the mud of the receding river. With equipment, he had a few of them

Samples of 1,500-year-old birch wood from the mud of New York's Genesee River. That's quarter-sawn at top and flatsawn below.



hailed out onto his adjoining land, washed them off, then had them sawn into boards.

Curious as to how old the well-preserved wood might be, Eckler had a local college send samples of it to a Florida carbon-dating firm. The answer was 1,500 years. The wood dated to about 500 A.D. Some of it—presumed to be a type of birch—had acquired a dark patina from minerals in the mud. The softwood appeared to be hemlock, but little was usable because it displayed ring shake.

## In Chicago, the rooftops grow green

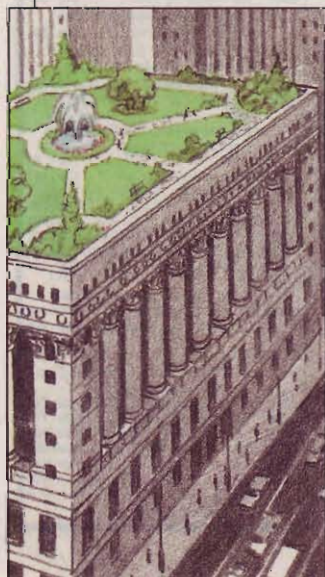

City beautification through cleanup and tree planting along municipal streets has always been a big part of Chicago Mayor Richard M. Daley's platform. Now he's taking it to the rooftops.

Last fall, the mayor had tons of rich soil hauled 11 stories to the top of City Hall. Next came some 20,000 plants, including a bur oak and a swamp white oak. Mayor Daley hopes that the project will demonstrate how growing plants cool the air and reduce smog. City Hall's new little rooftop park should also help cool the building in summer's heat and warm it in winter's harshness.

German, Japanese,  
Spanish  
roller coasters use

**U.S. wood**



Near Dortmund, Germany, stands a \$13 million roller coaster, shown above. It reaches 100' high and stretches the length of 12 football fields over the grounds of Warner Brothers Movie World. Building it required nearly 100,000 board feet of treated Southern pine imported from the United States, according to the Southern Pine Council (504/443-4464).

Topping that, though, is the largest wooden roller coaster in the world. It's 50 miles north of Tokyo, Japan, towers 150', and has a length of nearly a half mile. It's also built of Southern pine—almost 2 million board feet of it. And the gigantic ride marks the fifth built in that country of the U.S. grown and treated material.

Benidorm, Spain, looked to treated Southern pine, too, for its new roller coaster, the largest in Europe. That monster on the Mediterranean coast used 1.5 million board feet.

Illustration: **Jim Stevenson**.  
Photographs: Wood samples, **Baldwin**  
Photography; log, **Thomas Pedlow**,  
roller coaster, **Southern Pine Council**