

THE BEST ALL-AROUND TABLESAW BLADES: WE NAME NAMES!

ISSUE 181 DEC./JAN. 2007/2008

Better Homes and Gardens<sup>®</sup>

# WOOD

FREE  
FULL-SIZE PATTERNS INSIDE

**65**  
Time-and  
Money-Saving  
Tips!

**Wood Joint  
Torture Test** p.64

**15 Smokin' New  
Tools for 2008** p.50

*Plus*

More awesome projects!

- ◆ Harvest Table
- ◆ Wall Sconces
- ◆ Box-Joint Jig

Easy mix-and-match  
**Modular  
Bookcase**  
*You CAN Build This!*

p.32



# in this issue



58



32

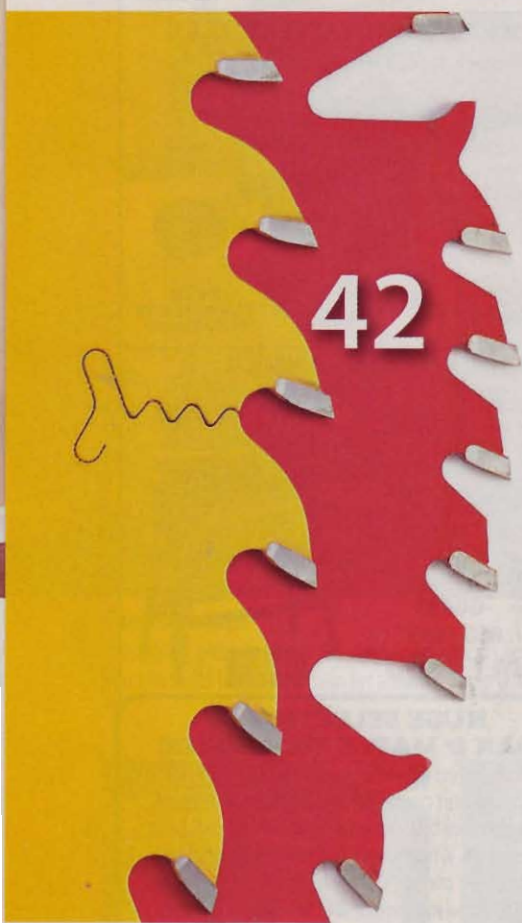

42

## PROJECTS

- 32 Cover project: Modular shelving**  
Four simple components that can be arranged in infinite combinations for ultimate flexibility.
- 46 Dollar coin holder**  
Show your patriotic pride—and your presidential coin collection—with this handsome display.
- 58 Drop-leaf harvest table**
- 70 Candle wall sconces**
- 78 Three-box ensemble**

## TOOLS & MATERIALS

- 22 Setting up and using rule-joint router bits**  
Two common router bits combine to form a foldable edge for drop-leaf tables.
- 42 Shop-tested: Tablesaw blades**  
Can one general-purpose blade really crosscut as well as it rips? Turns out several do, as our tests reveal.
- 50 Hot new tools for 2008**  
Our editors pick the tools and accessories that will be making news (and sawdust) in the next 12 months.
- 64 Wood-joint torture test**  
We sacrifice dozens of door and drawer joints in the name of science—and better woodworking.

## TECHNIQUES

- 18 Create a super-smooth filled finish**
- 28 Four ways to secure a tabletop**
- 74 Interchangeable box joints**  
This strong, timeless joint gets a makeover thanks to a no-dough tablesaw jig.
- 84 How to install table-leg connectors**

## DEPARTMENTS

- 8 Sounding Board**
- 10 Shop Tips**
- 88 Ask WOOD**
- 108 What's Ahead**



This seal is your assurance that we build every project, verify every fact, and test every reviewed tool in our workshop to guarantee your success and complete satisfaction.



22



78

# on the web

woodmagazine.com



18



50



46



64

## NOW THAT'S COOL!

Browse the photo gallery at [woodmagazine.com/projectgallery](http://woodmagazine.com/projectgallery) and you'll find inspired works like these whimsical light-switch covers made by Larry Greengard of Merced, Calif.



## PEEK THROUGH THE KEYHOLE...

...as Matt Seiler builds this beautiful walnut credenza. Matt builds custom furniture in suburban Chicago. Follow his progress in this photo-laden blog at [woodmagazine.com/msblog](http://woodmagazine.com/msblog).

## A HELPING HAND

Free online slide shows detail how WOOD® magazine projects come together. This month, get extra in-progress photos of the Harvest Table (right, p. 58) and Modular Cabinets (p. 32) at [woodmagazine.com/slideshows](http://woodmagazine.com/slideshows).



## MIGHTY DUCKS IN YOUR SHOP

Exclusively at WOOD Online! Learn how to lay out irregular curves using spline ducks (left). It's a woodworking technique you'll find only at [woodmagazine.com/irrcurves](http://woodmagazine.com/irrcurves).

# On Your Newsstand NOW!

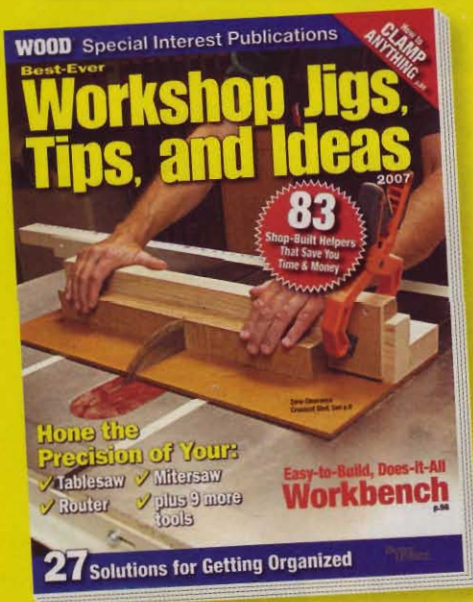

## Tips and Tricks for Your Shop

- ✓ Tablesaw timesavers
- ✓ Routing problem solvers
- ✓ Quicker, easier clamping
- ✓ Upgrade your workbench
- ✓ Dead-on drilling
- ✓ Stretch your storage space
- ✓ Maximize your miter saw

### Order online

[woodmagazine.com/publications](http://woodmagazine.com/publications)

or call toll-free 888-636-4478

\$6.99 U.S., \$8.99 Canada

WD0108

Better Homes and Gardens®  
**WOOD**®

woodmagazine.com

December/January 2007/2008

Vol. 24, No. 7

Issue No. 181

### We asked our staff:

What is your best finishing tip?



To avoid the mess and clean-up from steel wool, I buff between top coats with an ultrafine (gray) synthetic abrasive pad.



Make sample boards in species you use regularly. For stains, make a sample board with one and two coats to preview the results.

EDITOR-IN-CHIEF  
**BILL KRIER**

Managing Editor  
**MARLEN KEMMET**

Art Director  
**KARL EHLERS**

Techniques Editor  
**BOB WILSON**

Projects Editor  
**OWEN DUVAL**

Design Editor  
**JEFF MERTZ**

Multimedia Editor  
**LUCAS PETERS**

Production/Office Manager  
**MARGARET CLOSNER**

Deputy Editor  
**DAVE CAMPBELL**

Senior Design Editor  
**KEVIN BOYLE**

Tool & Techniques Editor  
**BOB HUNTER**

Projects Editor  
**JAN SVEC**

Master Craftsman  
**CHUCK HEDLUND**

Associate Art Director  
**GREG SELLERS**

Administrative Assistant  
**SHERYL MUNYON**

Assistant Art Director  
**CHERYL A. CIBULA**

Photographers

**MARTY BALDWIN, JASON DONNELLY, DEAN SCHOEPPNER, JAY WILDE**

Illustrators **TIM CAHILL, LORNA JOHNSON, ROXANNE LeMOINE**

Technical Consultants **JEFF HALL, PAT LOWRY**

Contributing Craftsman **JIM HEAVEY**

Proofreaders **BABS KLEIN, IRA LACHER, JIM SANDERS**

#### SUBSCRIBER SERVICE

Go to [woodmagazine.com/help](http://woodmagazine.com/help) or write to  
WOOD magazine, P.O. Box 37439, Boone, IA 50037-0439

Publisher **MARK L. HAGEN**

#### ADVERTISING AND MARKETING

**CHICAGO:** 333 N. Michigan Ave., Suite 1500, Chicago, IL 60601

Marketing Manager **AMANDA SALHOOT**

Advertising Managers **JACK CHRISTIANSEN, CAROLYN DAKIS**

Direct Response Advertising Representative **RYAN INTERLAND**

Assistants **GAYLE CHEJN, JACI LESKO**

**ATLANTA:** Navigate Media

**DETROIT:** RPM Associates

Product Marketing Manager **DIANA WILLITS**

Business Manager **JEFF STILES**

Associate Consumer Marketing Director **DAN HOLLAND**

Associate Director of Marketing-Newsstand **TOM DEERING**

Senior Production Manager **MELANIE STOLTENBERG**

Advertising Operations Manager **JIM NELSON**

E-Commerce Manager **MATT SNYDER**

Group Publisher **TOM DAVIS**

#### MEREDITH PUBLISHING GROUP

President **JACK GRIFFIN**

Executive Vice President **DOUG OLSON**

Editorial Director **MIKE LAFAVORE**

Finance & Administration **MIKE RIGGS**

Manufacturing **BRUCE HESTON**

Consumer Marketing **DAVID BALL**

Corporate Sales **JACK BAMBERGER**

Interactive Media **LAUREN WIENER**

Corporate Marketing **NANCY WEBER**

Research **BRITTA WARE**

**Meredith**  
CORPORATION

President and Chief Executive Officer **STEPHEN M. LACY**

Chairman of the Board **WILLIAM T. KERR**

In Memoriam — **E.T. Meredith III (1933–2003)**

Our subscribers list is occasionally made available to carefully selected firms whose products may be of interest to you. If you prefer not to receive information from these companies by mail or by phone, please let us know. Send your request along with your mailing label to Magazine Customer Service, P.O. Box 10263, Des Moines, IA 50336-0263.

© Copyright Meredith Corporation 2007. All rights reserved. Printed in the U.S.A.

Retail Sales

Retailers can order copies of WOOD for resale by e-mailing  
[heather.proctor@meredith.com](mailto:heather.proctor@meredith.com) or by calling toll free 866-326-4805.



When using an oil/varnish mix on porous woods, such as oak, check frequently for finish bleeding back in puddles as it cures.



Inspect and remove dust before applying a stain or clear finish. Build up light coats and sand between each coat.



# Sounding Board

Our bulletin board for letters, comments, and timely updates

## Reader puts a new spin on end-grain cutting board

After making several end-grain cutting boards from your plans in issue 172 (October 2006), I got the idea to make a lazy-Susan server, shown at *right*, using the same end-grain pattern. I bought the 6" rotating hardware (Shepherd Hardware part #9548) for \$5 at The Home Depot.

Here's how I built it. First, I glued up the strips according to your plan—but made them 4' long so I could get matching discs—then cut 12" and 16" circles from that blank. Next, I routed the edges, sanded both discs smooth, and applied my finish.

To center the hardware on each disc I cut a ¼" plywood circle that fits into the lazy-Susan hardware. Then I used a

¼" drill bit (same size as the pivot pin I used to cut the circles) to align the hardware, as shown at *right*.

Because I couldn't drive screws into both the base and top—the hardware doesn't come apart—I marked and drilled shank holes for the screws and counterbores for the nuts in the base. Then I attached the screws to the lower bracket with hot-melt glue. I next centered the hardware on the top and secured it with four #8×½" self-tapping wood screws. Finally, I attached the base with four #8-32×½" machine screws and nuts. After assembling the two discs to the hardware, I attached rubber bumper feet to the base.

—Ted Lane, Sarasota, Fla.



## Settee glider provides armrest, table for two

I always wanted a glider rocker, but never found one I liked. Then my father showed me the Adirondack glider, shown *below*, in *WOOD*® magazine issue 155 (May 2004). After looking at other issues in his collection, I decided to combine the Adirondack settee, *below center*, in issue 125 (August

2000) with the glider. My settee glider is *below right*. I had to modify the base slightly to receive the gliding hardware (Rockler part #58330, \$20, 800-279-4441 or rockler.com). Now it's on my porch—the perfect place to enjoy evenings.

—Brian Tillar, Cincinnati, Ohio

## Boston show canceled

The Consumer Woodworking Expo has canceled its show scheduled for Nov. 30–Dec. 2 in Boston.

## Article update

### Issue 178 (September 2007)

■ In Tip #2 of "Clamp down on glue-up mistakes" (page 98), you should wipe off glue squeeze-out while it's wet.



+



=



## HOW TO REACH US

### ■ For woodworking advice:

Post your woodworking questions (joinery, finishing, tools, turning, general woodworking, etc.) on one of 14 online forums at [woodmagazine.com/forums](http://woodmagazine.com/forums).

### ■ To contact our editors:

Send your comments via E-mail to [woodmail@woodmagazine.com](mailto:woodmail@woodmagazine.com); or write to *WOOD* magazine, 1716 Locust St., LS-221, Des Moines, IA 50309.

### ■ Subscription assistance:

To notify us of an address change, or to get help with your subscription, visit [woodmagazine.com/service](http://woodmagazine.com/service). Or write to *WOOD* magazine, PO Box 37439, Boone, IA 50037-0439. Please enclose your address label from a recent magazine issue.

### ■ To find past articles:

See our index at [woodmagazine.com/index](http://woodmagazine.com/index).

### ■ To order past issues and articles:

Order past issues of *WOOD* magazine, our special issues, or downloadable articles from issue 100 to present: Visit our online store at [woodmagazine.com/store](http://woodmagazine.com/store). Some issues are sold out.

### ■ Updates to previously published projects:

For an up-to-date listing of changes in dimensions and buying-guide sources from issue 1 through today, go to [woodmagazine.com/editorial](http://woodmagazine.com/editorial).

# Shop Tips

Helping you work faster, smarter, and safer

## Downsize PVC to fit blast gates

When I installed a central ductwork system for my dust collector, I used 4" PVC pipe instead of steel and saved 75 percent on the cost. But the inside diameter of the 4" PVC is  $\frac{1}{8}$ " too large for blast gates designed for steel ducts. My dad and I solved that problem by shrinking the PVC pipe slightly with a propane torch.

To soften the PVC for the joints, we slipped a hose clamp over the pipe and carefully heated the pipe until it softened. With the pipe end soft, he slipped the fitting into the pipe, slid the hose clamp up near the end, and tightened it to snug-up the softened PVC end. Once the pipe cooled and hardened, we removed the hose clamp to use for the next joint.

Finally, I secured the blast gate to the pipe with a sheet metal screw. With no tape, glue, or steel, and only a single hose clamp, it's a clean, simple way to build an inexpensive but effective collection system.

—Scott Perry, Tinley Park, Ill.

### Top Shop Tip

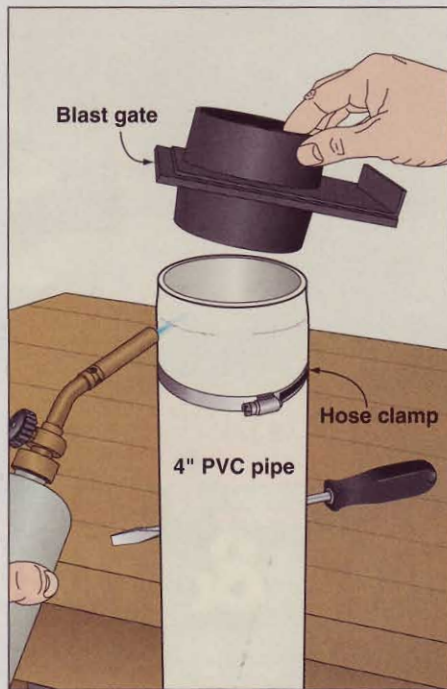

## Quick and easy board straightener

I don't spend extra money to have a straight edge milled on the stock I buy because a long time ago I figured out a way to straighten virtually any board on my table saw as long as it's fairly flat. All you need is a straight scrap of material you can screw to the workpiece, as shown. The straight scrap rides against the fence allowing a straight cut on the opposite edge. With one straight edge in place, you only need to remove the straight scrap, turn the board around, and straighten the other edge. The attached trowels help me hoist large workpieces up to tabletop height.

—Niki Avrahami, Garwolin, Poland

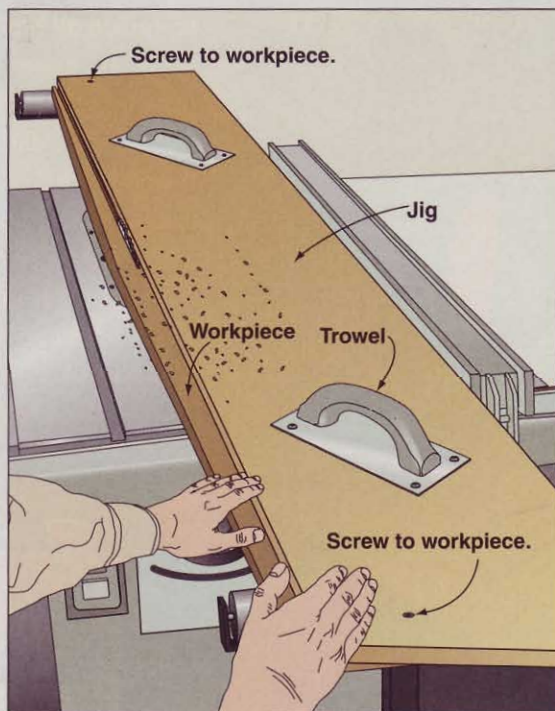

continued on page 14

## The Top Tipster



Photo: Mike Saulters

You think your neighbors are close? Only one wall separates Top Shop Tip winner Scott Perry's townhouse-basement shop from the folks next door. "I buy most of my wood rough-sawn, so I try to machine it when the neighbors aren't around," he says. To ensure the projects he builds down there (such as the Mission-style bed he's sitting on) come back out, he uses CAD software to design and build them in smaller subassemblies he can easily complete outdoors.



Scott will test the "can't have too many clamps" theory with \$300 worth of them from Adjustable Clamp Company for sending this issue's Top Shop Tip.

## Top tips earn tools!

Tell us how you've solved a workshop stumper, and you'll get \$100 if we print it. And, if your idea garners Top Shop Tip honors, we'll also reward you with a tool prize worth at least \$250.

Send your best ideas, along with photos or drawings and your daytime phone number, to: **Shop Tips, WOOD Magazine, 1716 Locust St., LS-221, Des Moines, IA 50309-3023.** Or, by e-mail: [shoptips@woodmagazine.com](mailto:shoptips@woodmagazine.com). Include your contact info in the e-mail as well.

Because we try to publish original tips, please send your tips only to WOOD magazine. Sorry, submitted materials can't be returned.

### All-weather runners for a tablesaw sled

I live in a climate where the humidity varies a lot, causing wood to expand and contract considerably. As a result, my tablesaw's crosscut sled, made from MDF, would often hang up in the miter slots as I tried to push it through. To solve the problem, I created the adjustable runners shown here so I can have a snug, but smooth-running, operation regardless of the weather.

To add these expandable miter runners to one of your sleds, begin by cutting runners that are  $\frac{1}{16}$ " shallower and narrower than your miter slots. Next, attach some cloth-backed double-faced tape to the top of the runners and center them in the miter slots. Lay some pennies in the bottom of the slot so the runners will be proud of the surface, and shim the sides to keep them centered. Expose the tape and lay your jig squarely on the runners to temporarily position them.

Remove the jig (with runners attached), and drill and countersink pilot holes through each runner and

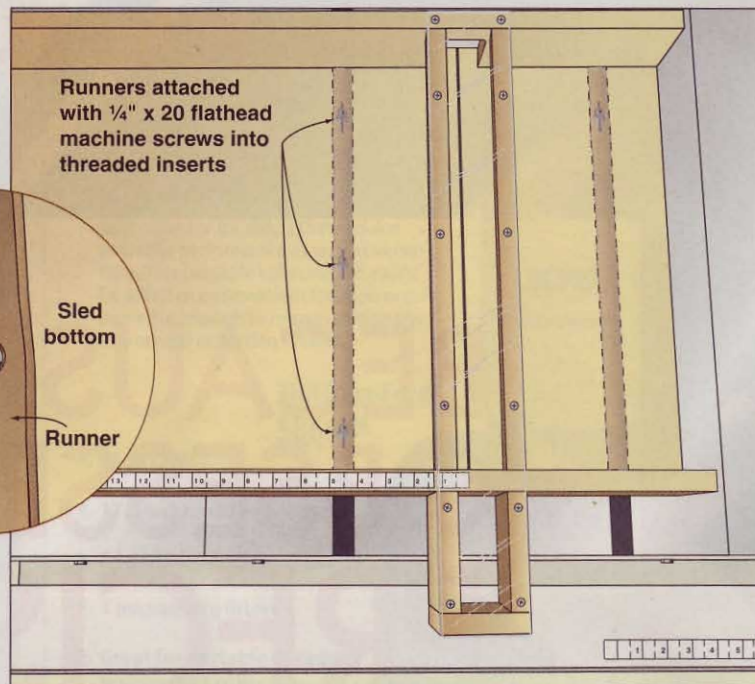
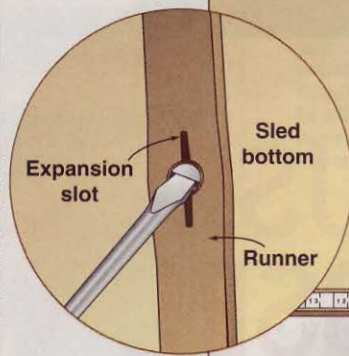

into the jig. Mark the runners so you can attach them exactly as you drilled them, and then remove the runners and tape. Use a jigsaw to cut the 1" expansion slots shown in the drawing. Now, install  $\frac{1}{4}$ -20 $\times$  $\frac{1}{2}$ " threaded inserts into the jig bottom at each pilot-hole location, and attach the runners to the sled with the flathead machine screws.

Tightening the screws causes the runner to spread slightly until it fits perfectly in your tool's miter slot.

I check the fit each time I use my crosscut sled and adjust the width of the runners as needed. To further reduce friction, I occasionally wax the runners and the bottom of the sled.

—Larry Plagens, Conroe, Texas

### Instant insert for zero-clearance cuts

Cutting dados or rabbets into small pieces on a tablesaw used to be a hazardous undertaking for me. The workpiece would sometimes catch on the edges of the dado insert that came with my saw. Rather than making a bunch of zero-clearance inserts to fit into the throat-plate opening, I now fashion a new temporary zero-clearance "tabletop" for each setup using scraps of medium-density fiberboard (MDF).

To make your own sacrificial tabletop, install your dado set, and lock your fence in the desired position for cutting the rabbet or dado. Lower the dado set below the saw's tabletop and clamp a piece of scrap to the tablesaw, as shown at right. Next, start the saw and raise the dado set slowly so that it cuts through the scrap. Raise it about  $\frac{1}{16}$ " higher than the required depth and then lower it to the true cutting depth. (This extra space helps clear the sawdust as you cut.) You can use this same technique for larger workpieces, but you'll need a wider piece of scrap.

—Benny Floyd, Cabot, Ark.

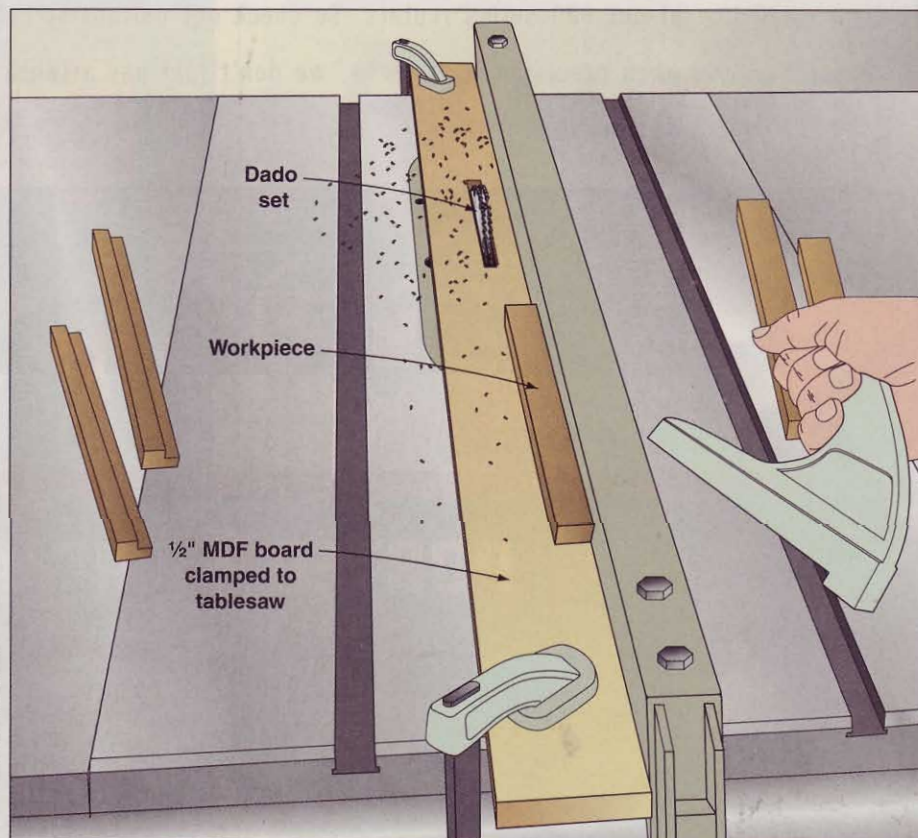

continued on page 16

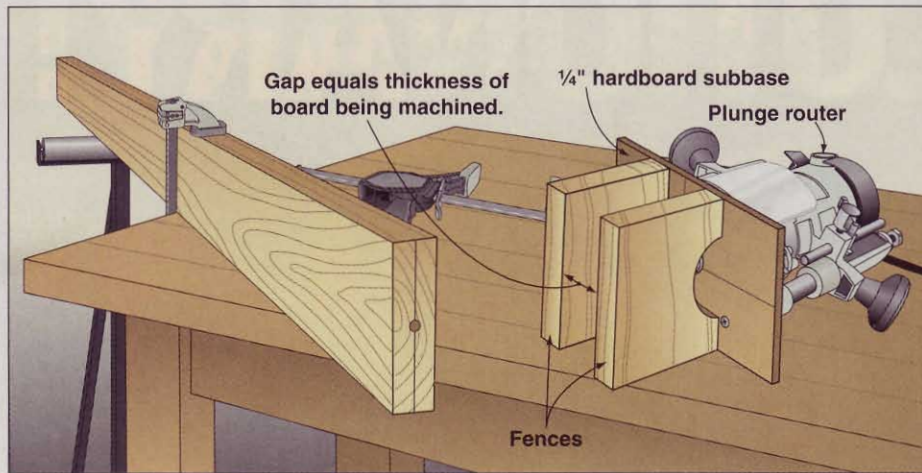

## Plunge router transforms into mini drill press

I recently needed to drill  $\frac{3}{4}$ "-diameter holes into the end grain of some 82"-long bed rails: too long for my drill press, too big for my doweling jig, and I didn't trust a hand drill to give me the perfectly perpendicular holes I needed. Instead, I drilled the holes with my plunge router and the shop-made self-centering jig you see here.

Start by making the jig from  $\frac{1}{4}$ " hardboard and two scrapwood fences spaced to match the thickness of the workpiece you want to drill. Install the jig in place of your router's factory-supplied subbase, with the bit centered between the two fences.

Now install a  $\frac{3}{4}$ " plunging straight bit (such as Woodline WL-1038,  $\frac{1}{2}$ " shank, \$9, 800-472-6950 or woodline.com), clamp the workpiece between the fences, and plunge slowly, withdrawing occasionally to clear chips.

With this jig, I've found I can plunge about  $1\frac{1}{2}$ " deep with my existing bits. If I need to go deeper, this plunged hole provides an effective guide for a Forstner bit in my handheld drill.

—Andy Newhouse, Syracuse, N.Y.

# JOIN THE SANDING REVOLUTION!

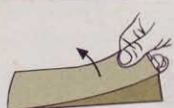

PEEL



STICK



SAND

- Quick & Simple – Peel and stick the sanding sheet and you're ready to sand; no clips, nuts or bolts to mess with
- Innovative & Unique – Patented adhesive system ensures sanding sheet won't slip, rip or move, even when sanding in difficult corners
- Durable & Effective – Each sanding sheet can be used several times; it clogs less and works better than other sandpaper

**PEEL  
STICK &  
SAND**



1-800-423-3845 • www.sandfast.com

## A surefire way to clean aerosol nozzles

In my shop I frequently use spray cans of paint and finish and I don't like wasting the can's contents or pressure to clear the nozzle. Instead, I use a can of WD-40, as shown, to easily and completely clean the nozzle.

—David Buskirk, Ray, Ohio





## Fill Pores For an Even Sheen

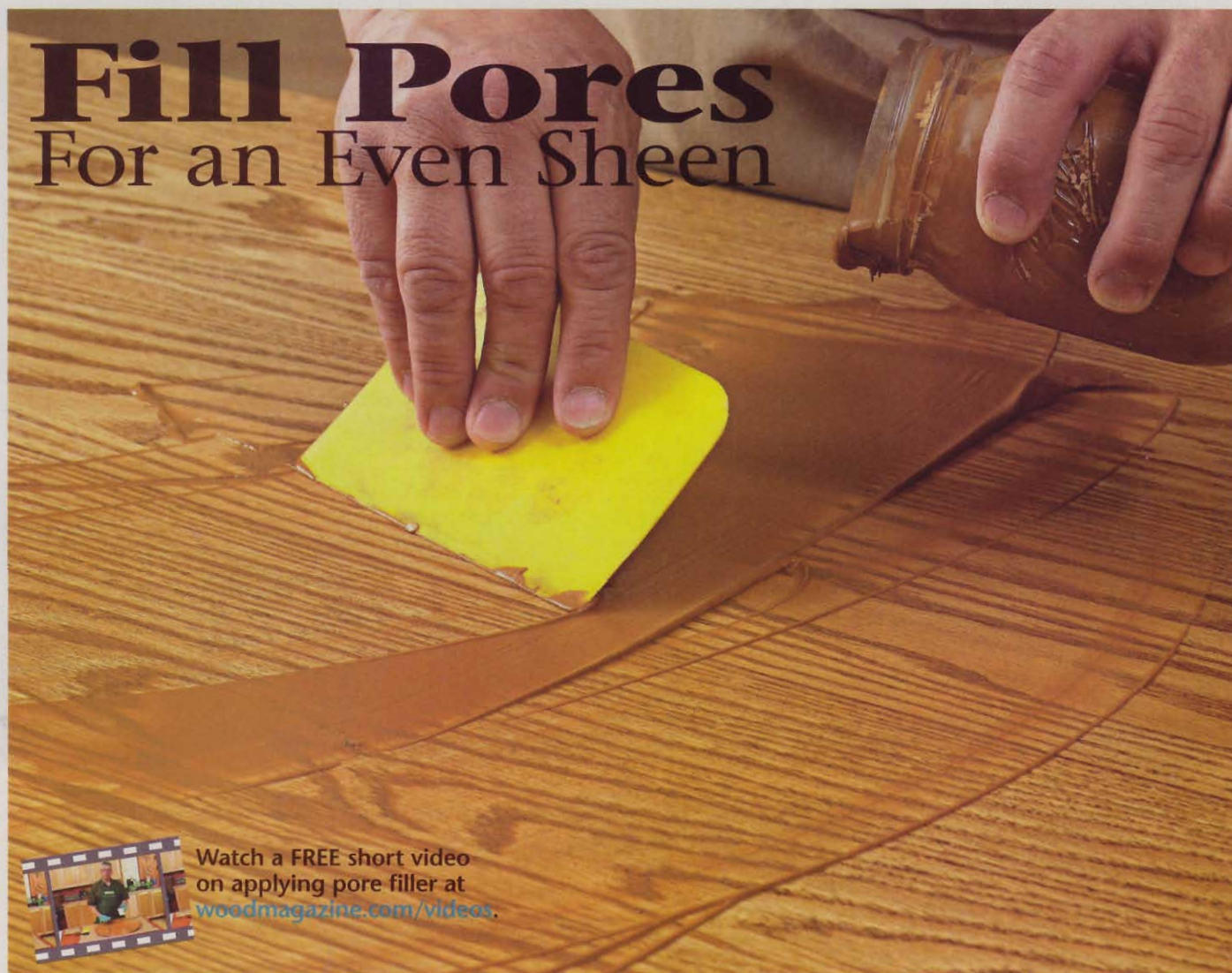

Watch a FREE short video  
on applying pore filler at  
[woodmagazine.com/videos](http://woodmagazine.com/videos).

Even open-grained oak can be smooth as glass when you plug those pesky pores.

If you've buried the tip of a ballpoint pen into the grain of a red-oak desktop as you write, you've learned one benefit of a filled-pore finish. Or maybe you've seen a high-gloss finish marred by pockmarks that grain filler would have eliminated.

Don't confuse pore fillers with wood putty. Fillers mix finely ground solids, usually silica, with a binder and a colorant. Water-based fillers emit less odor than solvent-based products, but they also dry faster. So stick with solvent-based fillers for large projects, such as the harvest table on *page 58*, or until you gain more experience filling smaller projects.

You can buy pore filler in a handful of colors, or mix pigments with off-white (called "natural") filler for a

custom look. (See **Sources**.) You'll also need mineral spirits, naphtha, or a pore-filler reducer; a plastic scraper or squeegee; at least 1 sq yd of burlap cloth; and a 320-grit sanding sponge.

For most projects, you need to fill only the topmost horizontal surface because that's where the most light is reflected off the finish. If you're filling more than one surface though, do each one separately with that side up.

Prepare your project by machine-sanding up to 180 grit, then hand-sanding at 180 grit with a flat pad to level the surface. Pore filler highlights surface flaws, so check for scratches by wiping the wood with mineral spirits. If you plan to stain the wood, do it now.

Filler alters stained or bare wood's color, so seal the area to be filled with a

washcoat of the film finish you'll use for the topcoats. (For a polyurethane washcoat, thin one part oil-based poly with two parts mineral spirits. For lacquer, mix equal parts finish and lacquer thinner.)

The washcoat also seals the pores to help your filler fill better and makes excess filler easier to wipe off. Do not sand the washcoat before applying pore filler because it will also lodge in any sanding scratches in the washcoat.

### Prepare the pore filler

Filler typically comes in a thick paste that should be thinned to a pourable consistency for spreading. Some filler manufacturers sell a reducer, but mineral spirits or naphtha accomplish

*continued on page 20*

the same thing for less money. Choose mineral spirits to slow the filler's drying time and let you work longer on large surfaces. Use naphtha to speed up the drying time for smaller projects.

Test the filler color on scrap that's been sanded and sealed the same as your project. If you're dissatisfied with the color, change it by adding pigments. (See "Choose fillers for a custom color" *right*.) We added Mixol to a natural-color filler, but you also can add universal pigments or japan colors.

### Now fill those pores

Pour thinned filler directly onto the workpiece surface and spread it across the grain using a plastic scraper or squeegee, as shown on *page 18*. Press the filler into the pores as you work, but not hard enough to scratch the washcoat. Also fill the end grain and edges of routed profiles visible from the top **[Photo A]**. Continue to wipe across the grain to remove any filler globs or large streaks.

As filler solvents evaporate, they leave a dull, hazy surface **[Photo B]**. That's your signal to wipe away surface filler using a burlap cloth. Wipe across the grain to avoid pulling filler out of the

## Choose fillers for a custom color



Depending on your choice of filler color or added pigments, you can make pores match or contrast with the surrounding wood. All three red-oak samples *above* started with Varathane golden-oak stain and a washcoat of spray lacquer.

Using thinned natural filler on the *left* sample turned the pores off-white, mimicking an antique pickled finish that's been stripped away. For strong grain contrast, use medium or dark

fillers like the Pore-O-Pac medium-brown walnut shown at *center*. Despite the washcoat, the dark filler also darkened the surrounding wood.

To match pore colors to the stain color, mix colorant with natural-color filler. The sample at *right* uses 1 teaspoon of Mixol 21 terra-brown pigment in 1 cup of natural filler. Mix more than you need to avoid running out and to match related projects you might build later.

pores **[Photo C]**, and refold the cloth as it becomes packed with filler. Stop when no more hazy areas or cross-grain streaks show in the reflection of an angled light **[Photo D]**.

Filler drying times vary widely, but allow three days before finishing a filled surface because solvents in the finish could resoften the filler. Then, lightly sand with a 320-grit sanding sponge, but avoid cutting through the thin washcoat. Apply a second washcoat to seal the surface, and use an angled light and your fingertips to find unfilled spots. Woods with large pores, such as oak, may require a second filler application and washcoat.

After you're satisfied with the surface smoothness, apply two coats of film finish, and level the final coat by sanding it to 320 grit using a flat, rigid sanding pad. (A piece of felt glued to a roughly 3×4½" block works well.) Then, apply a third coat, and rub out the finish to the desired sheen. For a glossier finish, top off the film finish by buffing on a coat of wax. 🌲

### Sources

**Pore filler.** Natural-shade Pore-O-Pac paste-wood filler no. B7440416, \$19, Klingspor's Woodworking Shop, 800-228-0000; woodworkingshop.com. Other colors are available. Pore-O-Pac filler reducer no. B7442006, \$15. Bartley's Paste Wood Filler no. 02237028 (light), \$9.89/pint Van Dyke's Restorers, 800-558-1234, vandykes.com.

**Pore-filler colorants.** Mixol terra brown (21) no. 832406, \$5 for 20 ml, Woodcraft, 800-225-1153; woodcraft.com. Other colors are available.

**Burlap.** Check with local fabric stores, or order no. BL70000, \$2 for 1 sq yd, Klingspor's.

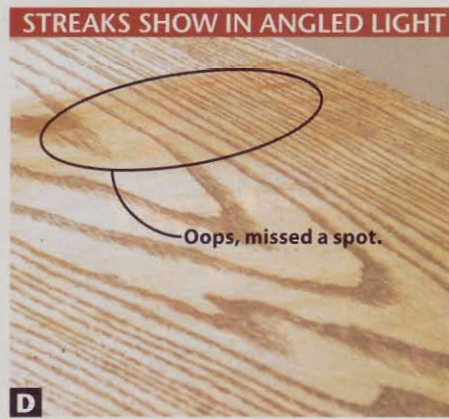

## Blades and Bits

# Rule-Joint Router Bits

Setup blocks speed your way to dead-on joints time after time.



Watch a FREE video on how to rout rule joints at [woodmagazine.com/rulejoint](http://woodmagazine.com/rulejoint).



**R**ule-joint bits add both form and function to a drop-leaf table, such as the one *above* and on page 58. They round over table edges for a traditional look and let you lift up table leaves to seat more guests.

Most rule-joint router-bit sets (see **Sources**) come with a 1/2" round-over bit and a mating 1/2" cove bit, like those in **Photo A**, for cutting joints in 3/4"-thick material. The 1/2" size works with either mortised or surface-mounted hinges. To leave the correct-size shoulders in material 7/8" to 1" thick, step up to a set with 5/8" round-over and cove bits.

Buying the bits in sets saves money. For example, the set shown *below* costs about \$9 less than buying the same bits separately. And because both bits have common profiles, you can replace a damaged bit without buying a new set.

### First, rout the tabletop

For the 3/4"-thick parts shown, begin by mounting a 1/2"-radius round-over bit into either a table-mounted or handheld router. Use a router table for tabletops small enough to maneuver safely. Set the cutting depth to leave a 3/16" shoulder [**Photo B**], and move the fence flush with the bit's bearing. Test the fence setting and the bit height in scrap before routing both ends and edges of the tabletop.

If the top is too large to manage on a router table, place a table leaf beneath and flush with the top to guide the bit's bearing [**Photo C**] as you rout.

### ANATOMY OF A RULE JOINT

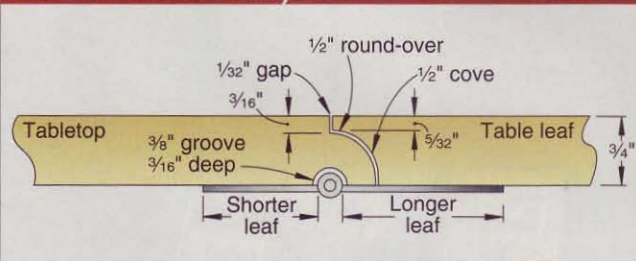

Regardless of the method you use, record your perfect profile by routing one edge of a setup block the same thickness as your tabletop. For future reference, mark it with the thickness of the material and the specific bit used.

### Rout a cove on the leaves

Table leaves are often narrow enough to handle on a router table. Using the

*continued on page 24*

### MATCH BITS FOR A TIGHT JOINT



### ROUT MIDSIZE PARTS ON A TABLE



### ROUT UNWIELDY PARTS BY HAND



# CORBELS



## Acanthus Leaves



**8085**  
12 1/2 x 5 1/2 x 8



**8025**  
12 x 3 1/2 x 8



**8030**  
9 3/4 x 4 1/2 x 5 1/2



**8055**  
10 1/2 x 4 1/2 x 3



**1426**  
36 x 7 x 7 1/2



**8015**  
9 x 3 x 3 1/2



**8002**  
6 x 3 x 2 3/4



**8080**  
12 1/2 x 5 1/2 x 8



**8020**  
12 x 3 1/2 x 8



**8010**  
9 3/4 x 4 1/2 x 5 1/2



**8050**  
10 1/2 x 4 1/2 x 3



**1425**  
36 x 7 x 7 1/2



**8005**  
9 x 3 x 3 1/2



**8000**  
6 x 3 x 2 3/4

## Blades and Bits

### ROUT TABLE LEAF PROFILES



**D**

tabletop's round-over profile or the setup block as a guide, adjust the 1/2" cove bit's height to leave no more than a 1/32" gap between the setup block profile and the edge of the cove bit. Using a straightedge, adjust the router-table fence flush with the bit's bearing. Test your settings on scrap before routing both leaves [Photo D]. Then rout that profile on the opposite edge of the setup block, and save it along with the bit set for future projects [Photo E].

### BLOCK SPEEDS BIT HEIGHT SETUP

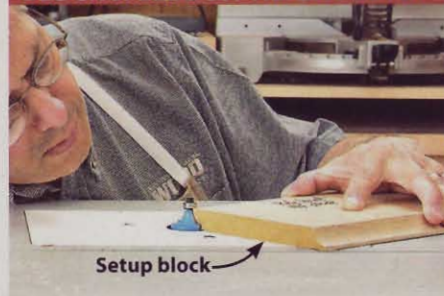

**E**

## Sources

**Rule-joint bit sets.** Set no. 26318 (shown) with a 1/2"-radius, 3/4"-high round-over bit and a 1/2"-radius, 5/8"-high cove bit; \$50, Rockler Woodworking and Hardware, 800-279-4441; rockler.com. Set no. 100-5465 for 3/4" tabletops, \$42.49, Eagle America, 800-872-2511; eagleamerica.com. Set no. 33-116 for 3/4" tabletops, \$51, Freud, 800-334-4107; freudtools.com. Set no. 00-124 for 3/4" tabletops, \$53, Infinity Cutting Tools, 877-872-2487; infinitytools.com. Set no. 8401 (5/8" set for surface-mounted hinges), \$42, MLCS, 800-533-9298; mlcswoodworking.com. Set no. WL-2033, \$39, Woodline USA, 800-472-6950; woodline.com.

8116 GA Highway 123 • Toccoa, GA 30577 • 1.800.746.3233 CATALOG LINE



ORDER ONLINE  
[www.osbornewood.com](http://www.osbornewood.com)

ORDER LINE  
**1.800.849.8876**

# 4 Ways to Fasten Tabletops

These mounting methods will keep your tables from popping their tops.

**T**he trick to mounting a tabletop is securing it firmly to the table apron while still allowing the wood to expand and contract across its width. Here are four methods, utilizing scrapwood or special (but inexpensive) hardware, that achieve both goals.

## Z-SHAPE CLIPS ATTACH QUICKLY



### 1 Z-shape clips

One end screws firmly onto the tabletop, while the other fits a saw kerf along the table apron, as shown above.

**Advantages:** Low cost—less than a dime apiece—and easy installation.

**Disadvantages:** Metal hardware doesn't complement some traditional table styles for purists who prefer solid-wood mounting systems.

**How to use them:** Press the screw end of the clip firmly against a flat surface and measure the rise at the other end (usually about  $\frac{3}{8}$ "). At that measurement, cut a groove on the top inside face of each apron piece using a router, tablesaw, or biscuit joiner. Mark the locations of mounting screw pilot holes about 8–12" apart, and drill with a depth stop to avoid boring through the tabletop. Then attach the clips to the apron sides and ends, as shown.

## THE TRADITIONAL CHOICE: SHOP-MADE TOP FASTENERS



### 2 Shop-made blocks

The all-wood version of Z-shape clips, the tongue of an L-shape block rides in a mating groove along a table apron, as shown above.

**Advantages:** Blocks use up scrapwood and provide an authentic touch for some period furniture.

**Disadvantages:** Making the blocks adds another step (though not difficult) and more time to your project.

**How to use them:** With the harvest table on page 58 as an example, saw or rout  $\frac{1}{4}$ " grooves  $\frac{1}{4}$ " deep  $\frac{3}{8}$ " from the top inside faces of the apron pieces. Then, on a  $\frac{5}{8}$ " $\times$ 2" blank at least 15" long, cut  $\frac{1}{4}$ " dados spaced  $1\frac{3}{8}$ " apart as illustrated at right. Drill  $\frac{1}{4}$ " shank

holes to fit #8 $\times$  $\frac{1}{4}$ " panhead screws, and cut the individual fasteners from the blank, as shown. To attach the blocks, space them about 12" apart at each end of the table, with the tongues in the apron grooves. Drill pilot holes into the tabletop, and attach the fasteners with washers. For long tabletops, use these with the stretchers shown on page 30.

#### BLOCK BLANK

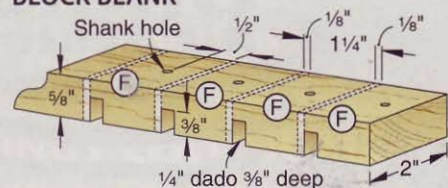

continued on page 30

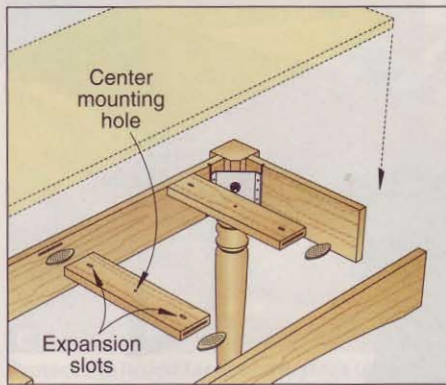

**STRETCHERS ALSO SUPPORT TOPS**

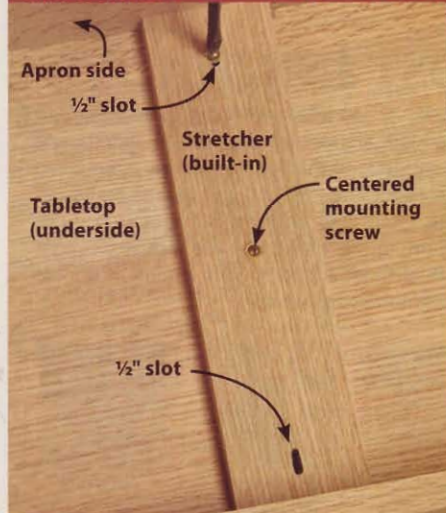

**3 Slotted stretchers**

Use two or three of these as part of the table framework, or combine them with other fasteners.

**Advantages:** Stretchers help prevent tabletop warping and keep long apron side parts from bowing.

**Disadvantages:** Added parts mean more machining.

**How to use them:** Size the 3/4"-thick stretcher to fit between the long apron pieces. Then drill a mounting screw pilot hole at the center of the stretcher. To make 1/2"-long expansion slots on both sides of the pilot hole, use a brad-point bit slightly larger than the mounting-screw diameter to drill overlapping holes running parallel to the grain. Smooth the scalloped edges with a chisel to create the slots.

Mount the stretchers to the long apron pieces using biscuits. Then center the completed apron upside down on the underside of the tabletop. Drive a screw at the center of the stretcher. Then drive screws into the middle of each expansion slot.

**FIGURE-EIGHT CONNECTORS ROTATE AS THE WOOD MOVES**

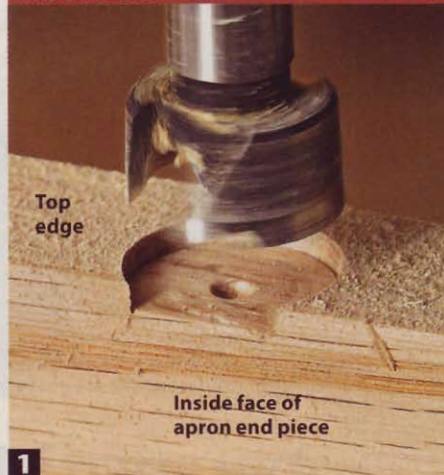

1

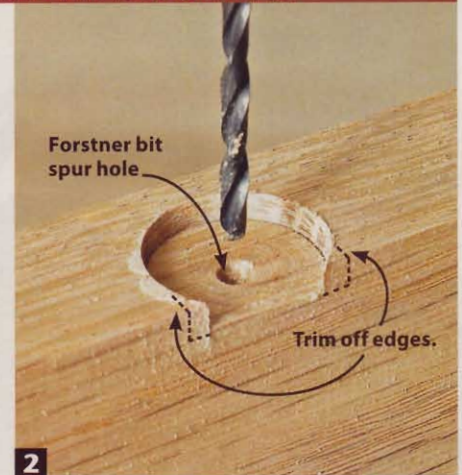

2

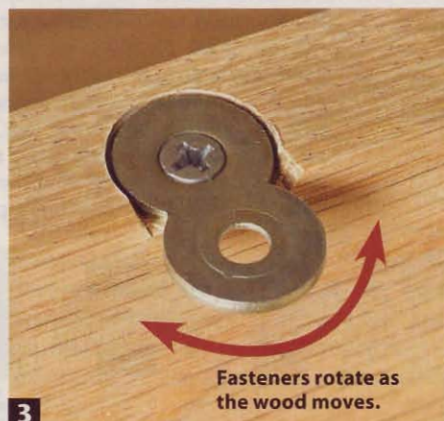

3



4

**4 Figure-eight connectors**

As a tabletop expands and contracts, this connector rotates within a round mortise in the edges of the apron end parts to keep the top from buckling. Figure-eight connectors vary in size and shape, with some having equal-size loops and some with the apron-side loop larger than the tabletop loop.

**Advantages:** Figure-eight connectors require no apron grooves and are slightly less conspicuous than the Z-shape clips.

**Disadvantages:** Connectors must be mortised into the apron edges to work, limiting how thin you can make the apron parts.

**How to use them:** Chuck into your drill press a Forstner bit just slightly larger than the figure-eight connector. Every 12"-18", on the edges of the apron end pieces, drill mortises a hair deeper than the connector thickness [Photo 1]. Using the spur hole from the Forstner bit as a guide, drill a mounting screw pilot hole. Then trim off the mortise edges with a chisel, as shown

[Photo 2], to allow the connector to rotate back and forth about one-eighth of a turn.

Screw the figure-eight connector to the apron just loosely enough to allow it to rotate [Photo 3]. Check that the connector sits flush with or a little lower than the apron edge. Repeat these steps to mount the remaining connectors. Do not mount them on the side pieces of the apron.

With the tabletop upside down on your workbench, center the apron/leg assembly on the underside of the tabletop, and mark the mounting screw locations. Drill pilot holes into the tabletop using a depth stop and insert the mounting screws [Photo 4].

**Sources**

**Z-shape clips.** Tabletop fasteners no. 27N10, \$2 for 10, Woodcraft, 800-225-1153; woodcraft.com. Mounting clip no. 13K01.01, \$5.50 for 50, Lee Valley Tools, 800-871-8158; leevalley.com.

**Figure-eight connectors.** Connector no. 13K01.50 with loops of equal size, \$2.40 for 20, Lee Valley Tools. Connector no. 21650 with loops of unequal size, \$2.39 for eight, Rockler Woodworking and Hardware, 800-279-4441; rockler.com.



See a Slide Show of this project coming together at: [woodmagazine.com/slides](http://woodmagazine.com/slides)

# Shuffle 'n' Stack Modular Cabinets

This super-flexible system transforms to meet your needs, big or small. Add, subtract, or reconfigure as your needs change. Shown here are just four of the endless possibilities.

**DESIGN YOUR SYSTEM FROM THESE 8 COMPONENTS**



**SHOWN LEFT**

- 2 Double cabinets
- 4 Triangular cabinets (2 visible)
- 1 Rectangular base
- 2 Triangular bases (1 visible)
- 2 Doors



**VERTICAL CABINET**  
18"W x 33"H x 15"D

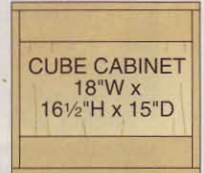

**CUBE CABINET**  
18"W x 16½"H x 15"D

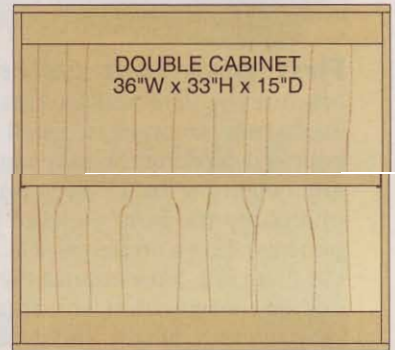

**DOUBLE CABINET**  
36"W x 33"H x 15"D



**SHOWN ABOVE**

- 1 Double cabinet
- 2 Vertical cabinets
- 2 Triangular cabinets
- 2 Rectangular bases
- 2 Triangular bases
- 2 Doors

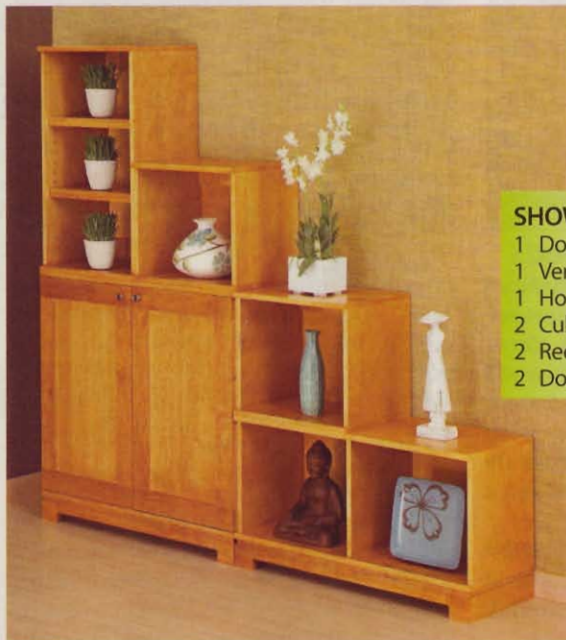

**SHOWN LEFT**

- 1 Double cabinet
- 1 Vertical cabinet
- 1 Horizontal cabinet
- 2 Cube cabinets
- 2 Rectangular bases
- 2 Doors

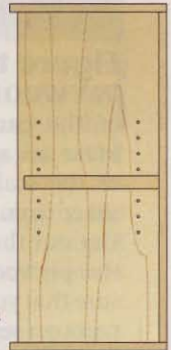

**TRIANGULAR CABINET**  
15"W x 15"D x 33"H  
(Left cabinet shown. Flip end for end for a right cabinet.)

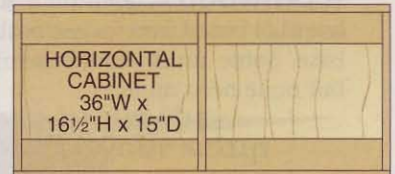

**HORIZONTAL CABINET**  
36"W x 16½"H x 15"D

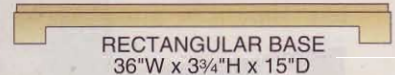

**RECTANGULAR BASE**  
36"W x 3¾"H x 15"D



**SHOWN LEFT**

- 1 Horizontal cabinet
- 1 Double cabinet
- 2 Vertical cabinets (1 visible)
- 2 Cube cabinets (1 visible)
- 2 Triangular cabinets (1 visible)
- 2 Rectangular bases (1 visible)
- 2 Triangular bases (1 visible)
- 2 Doors (1 visible)

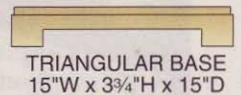

**TRIANGULAR BASE**  
15"W x 3¾"H x 15"D



**DOOR**  
17⅞"W x 31⅞"H



## PROJECT HIGHLIGHTS

- The components are sized to maximize use of 4x8' plywood sheets.
- The components are a snap to construct, thanks to the simple design, biscuit joinery, and common parts.
- We built the cabinets using maple and maple plywood, covering the exposed plywood edges with iron-on maple veneer edging. (White birch edging, available at your local home center, also matches well.) But you can use a different hardwood and plywood with a matching edging, if you wish. The cabinets will still look great.
- As an option, install 1/4" glass instead of the plywood panel in the door.
- To easily round up the hardware, edging, and edge and end trimmers for the project, see **Supplies and Source**, page 40.

### First, plan your system

Measure the floor and wall space in the area where you want to install the cabinets to determine the maximum width and height for the 15"-deep units. Then photocopy the front views of the components, shown on the *previous page*, and cut them out. Now arrange them in the desired configuration, ensuring that the overall width, height, and depth will fit the chosen space.

### Figure the material needs

**PLYWOOD** — List the total quantities of the parts needed for your system. Make an appropriate number of copies of the scaled parts and 4x8' plywood sheet from the *WOOD Patterns*® insert. Cut out the parts, and lay them out on the plywood sheets [**Photo A**], making sure that you place 3/4"-thick and 1/4"-thick parts on separate sheets.

**HARDWOOD** — Plan on a 3/4x5 1/2x96" board (4 board feet) for each cabinet and base. Some units require less material, but none need more.

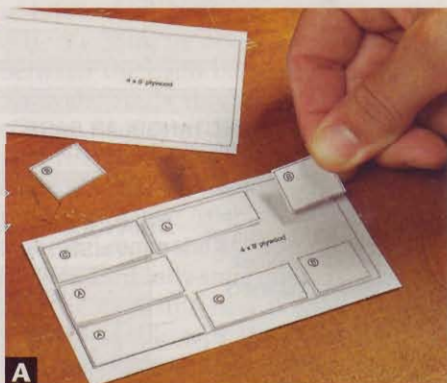

#### **A** PATTERNS MAKE PLANNING EASY

Lay out the scaled parts on the plywood to find the number of sheets you need. Be sure to align the grain and allow for saw kerfs.

## 9 Tips to Get Started Right

To ensure safety and avoid errors, follow these pointers:

**Tip 1** For safety, use a helper when moving 4x8' sheets of plywood. Use support stands when cutting a large panel on your tablesaw. As an alternative, cut pieces to rough size using a portable circular saw, a straightedge guide, and reliable supports. Learn more at [woodmagazine.com/videos](http://woodmagazine.com/videos). Click on "Shop-Tested Techniques" followed by "Handling Sheet Goods."

**Tip 2** Cut the 7/8"-wide iron-on veneer edging for the 3/4"-thick plywood parts approximately 1" longer than the finished lengths. Center the edging on the parts with an equal overhang on the faces and ends. Apply the edging using a household iron set at the "cotton" setting. Move the iron slowly enough to melt the adhesive but not burn the veneer. (You'll feel a slight "give" when the adhesive melts.) Before the adhesive sets, press the edging firmly into place using a 1"-long wood roller. (A wall-paper seam roller works great.) Trim the edging flush with the ends and faces using a sharp utility knife or end and edge trimmers, as shown *above right*. To avoid edging tear-out, trim one side at a time, moving in the direction of the edging grain.

**Tip 3** Because plywood thicknesses vary, the overall dimensions of a case may vary slightly. To ensure that such parts as the back supports, plywood backs, and shelves fit the cases correctly, always measure the cases for the exact sizes of the parts, as noted in the instructions.

**Tip 4** To prevent errors in laying out biscuit slots, make a story stick from 3/4"-thick scrap, as shown at *right*.

**Tip 5** Cut parts that have mitered ends 1" longer than the listed lengths. Then miter-cut them to the exact lengths, using a stopblock on a miter-gauge extension to ensure identical lengths.

**Tip 6** When drilling holes for the shelf supports, use a fence with a stopblock on your drill press to ensure alignment and consistent spacing of the holes. Also use a brad-point bit wrapped with a piece of masking tape for a visual depth stop.

**Tip 7** For the #8 flathead wood screws, drill 3/32" countersunk shank holes and 3/64" pilot holes.

**Tip 8** For ease of finishing, sand all parts to 220 grit before assembly. Also,

do not install the backs until you complete the finishing.

**Tip 9** When plunging slots into the faces of parts, use a guide for your biscuit joiner, as shown at *bottom*.

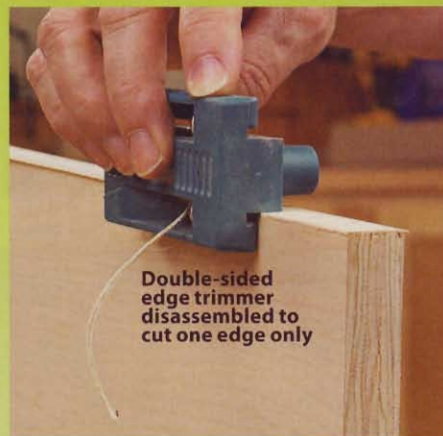

When flush-trimming veneer edging, cut along one face at a time, moving in the edging grain direction to avoid tear-out.

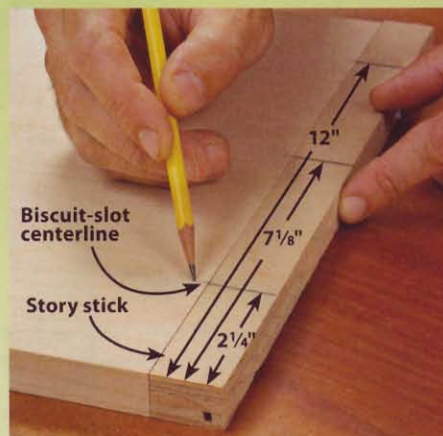

Use a story stick to accurately and consistently mark the centerlines for #20 biscuit slots on the 3/4" plywood parts.

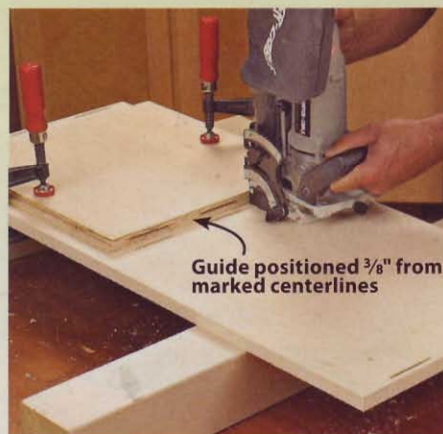

To plunge biscuit slots into the face of a part, clamp another workpiece to it as a guide, positioned 3/8" from the marked centerlines.

## Make the "square" cases

**1** For the selected double, vertical, horizontal, and cube cabinets [Drawings 1 through 4], cut the tops/bottoms (A, B), sides (C, D), and divider (E) to the sizes listed [Materials Lists, pages 35–36]. For the divider, lay out the 3" notches 1/2" deep along the back edge [Drawing 3]. Bandsaw or jigsaw the notches to shape.

**2** Apply 7/8"-wide iron-on veneer edging to the appropriate edges of the parts, where shown. Then, flush-trim the edging. For help with this, go to [woodmagazine.com/videos](http://woodmagazine.com/videos), and click on "Shop-Tested Techniques" followed by "Applying Iron-on Edging."

**3** Cut or rout a 3/8" rabbet 1/4" deep along the back inside edges of the sides (C, D).

**4** Mark centerpoints for shelf-support holes on the inside faces of the sides (C), where dimensioned [Drawings 1 and 2]. Drill the 1/4" holes 3/8" deep.

**5** Using your story stick (see "9 Tips to Get Started Right," opposite page), mark centerlines for the #20 biscuit slots on all of the parts, where shown. Align the stick flush with the front edges of the sides (C, D) and divider (E), and 3/4" from the front edges of the tops/bottoms (A, B). Plunge the slots into the parts using your biscuit joiner.

**6** Dry-assemble the cabinets with #20 biscuits and clamp together. Verify that all of the parts fit correctly. Then measure between the rabbeted sides (C, D) to find the exact lengths for the back supports (F, G). Cut the supports to the

listed sizes and measured lengths. Now crosscut or rout a 3/8" rabbet 1/2" deep across the ends of the supports on the front faces and a 3/8" rabbet 1/4" deep along the inside edges on the back faces [Drawing 5].

**7** Disassemble the cabinets. Then glue, biscuit, and clamp the sides, tops/bottoms, and divider (as appropriate) together [Photo B, next page]. After the glue dries, glue the back supports in place [Photo C].

**8** Measure the rabbeted openings on the cabinets for the exact widths and lengths of the 1/4" plywood backs (H, I, J, K). Cut them to size, and set aside.

**9** Measure the insides of the cases for the lengths of the shelves (L, M) [Drawings 1 and 2]. Then cut the shelves

## Materials List for Double Cabinet

Part	FINISHED SIZE			Matl.	Qty.
	T	W	L		
A top/bottom	3/4"	15"	36"	MP	2
C sides	3/4"	14 1/4"	31 1/2"	MP	2
F back supports	3/4"	3"	35 1/4"	M	2
H back	1/4"	35 1/4"	26 1/4"	MP	1
L shelves	3/4"	12 1/2"	34 3/8"	MP	2
N shelf trim	3/4"	1 1/4"	34 3/8"	M	2
P doorstop	3/4"	3/4"	3"	M	1

Materials key: MP—maple plywood, M—maple.

### 1 DOUBLE CABINET EXPLODED VIEW

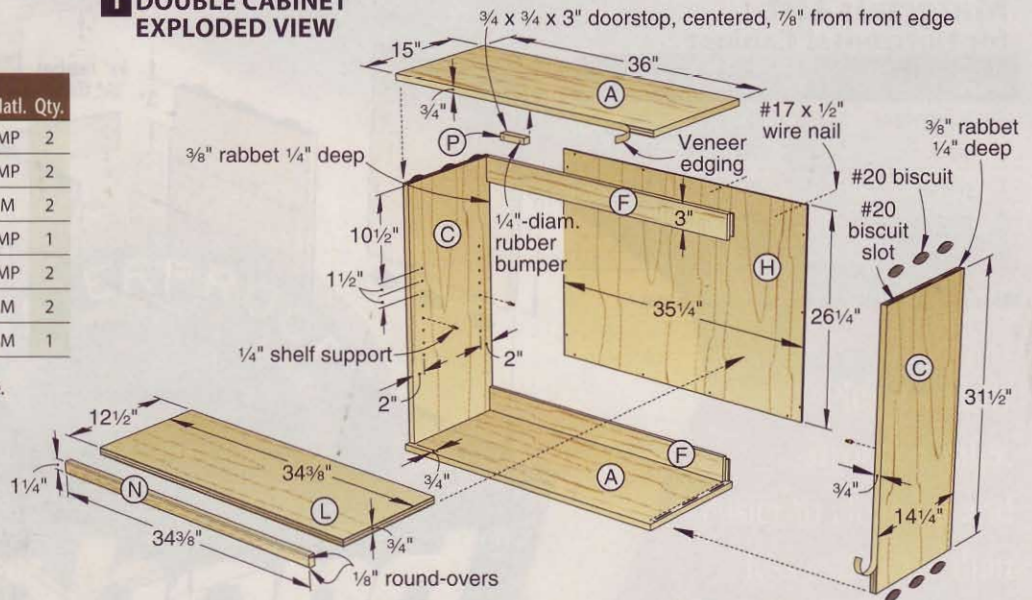

### 2 VERTICAL CABINET EXPLODED VIEW

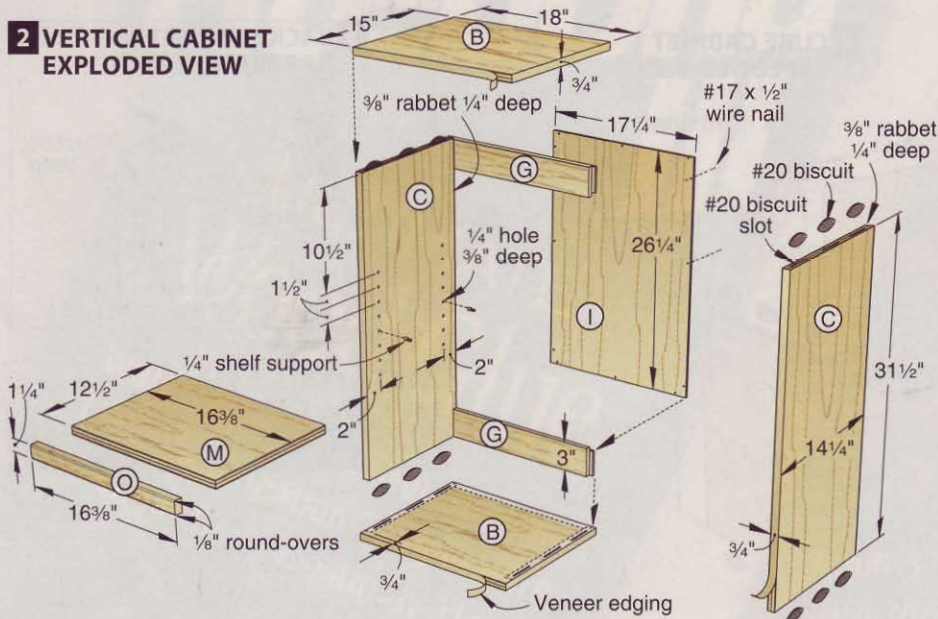

## Materials List for Vertical Cabinet

Part	FINISHED SIZE			Matl.	Qty.
	T	W	L		
B top/bottom	3/4"	15"	18"	MP	2
C sides	3/4"	14 1/4"	31 1/2"	MP	2
G back supports	3/4"	3"	17 1/4"	M	2
I back	1/4"	17 1/4"	26 1/4"	MP	1
M shelves	3/4"	12 1/2"	16 3/8"	MP	2
O shelf trim	3/4"	1 1/4"	16 3/8"	M	2

Materials key: MP—maple plywood, M—maple.

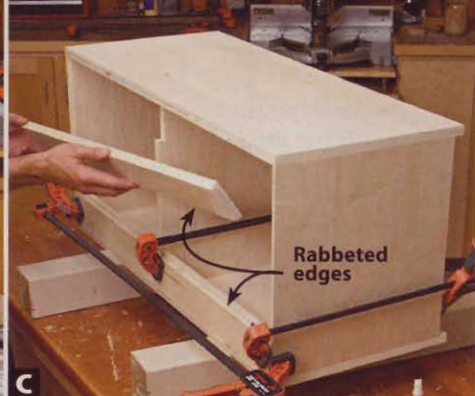
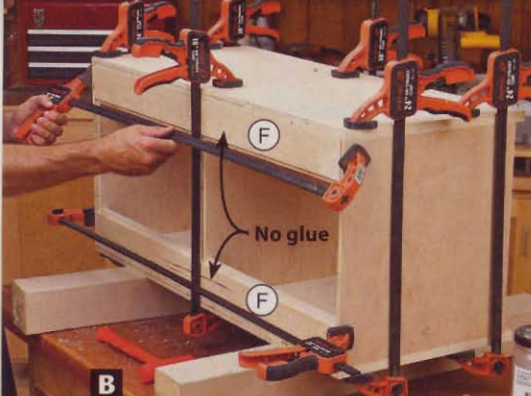

**B** **GLUE THE CABINETS AND BACK SUPPORTS TOGETHER IN TWO STAGES**

Glue, biscuit, and clamp the case (horizontal case shown) together. Add the back supports (F) (without glue) to keep the assembly square. Then glue and clamp the back supports in place, ensuring they're tight against the case top/bottom and the rabbeted sides.

and shelf trim (N, O) to the sizes listed, and your measured lengths minus 1/8" for clearance. Rout 1/8" round-overs along the front edges of the trim. Now glue and clamp the trim to the front edges of the shelves, flush with the top faces.

**10** If you plan to mount doors onto the double cabinet, cut the doorstop (P) to the size listed. Glue the doorstop to the bottom of the top (A), centered and 7/8" from the front edge [Drawing 1]. (The 7/8" setback accounts for the 3/4"-thick door and 1/8"-thick rubber bumpers.)

**3 HORIZONTAL CABINET EXPLODED VIEW**

**Materials List for Horizontal Cabinet**

Part	FINISHED SIZE			Matl.	Qty.
	T	W	L		
A top/bottom	3/4"	15"	36"	MP	2
D sides	3/4"	14 1/4"	15"	MP	2
E divider	3/4"	14"	15"	MP	1
F back supports	3/4"	3"	35 1/4"	M	2
J back	1/4"	35 1/4"	9 3/4"	MP	1

Materials key: MP—maple plywood, M—maple.

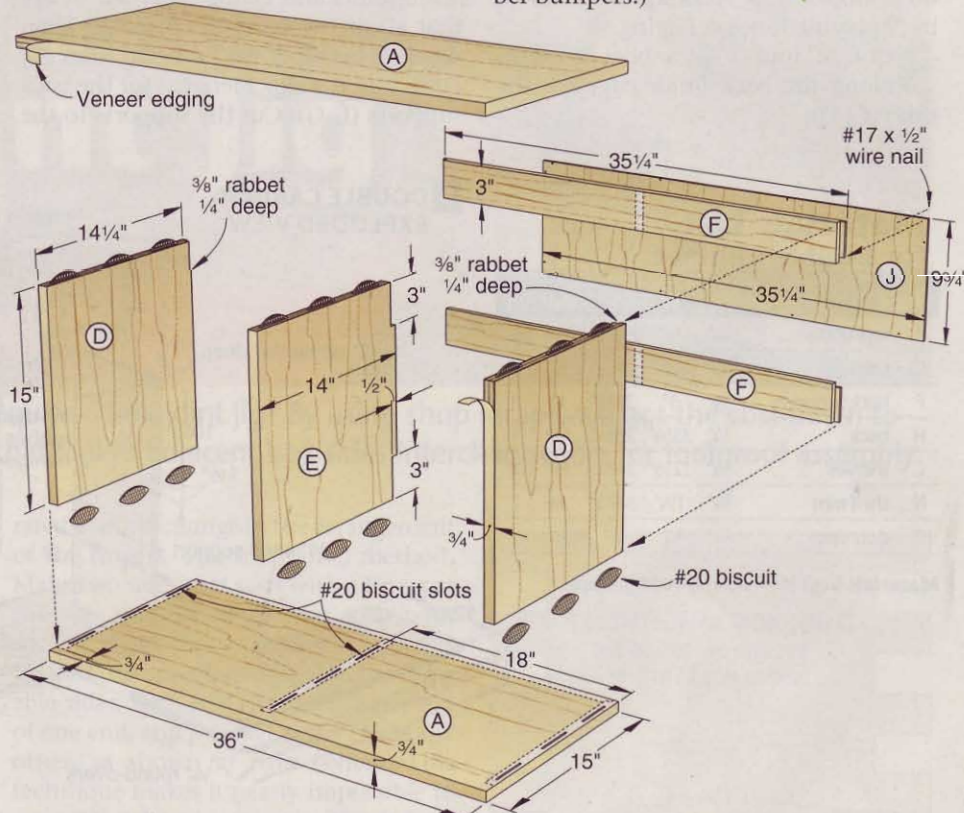

**4 CUBE CABINET EXPLODED VIEW**

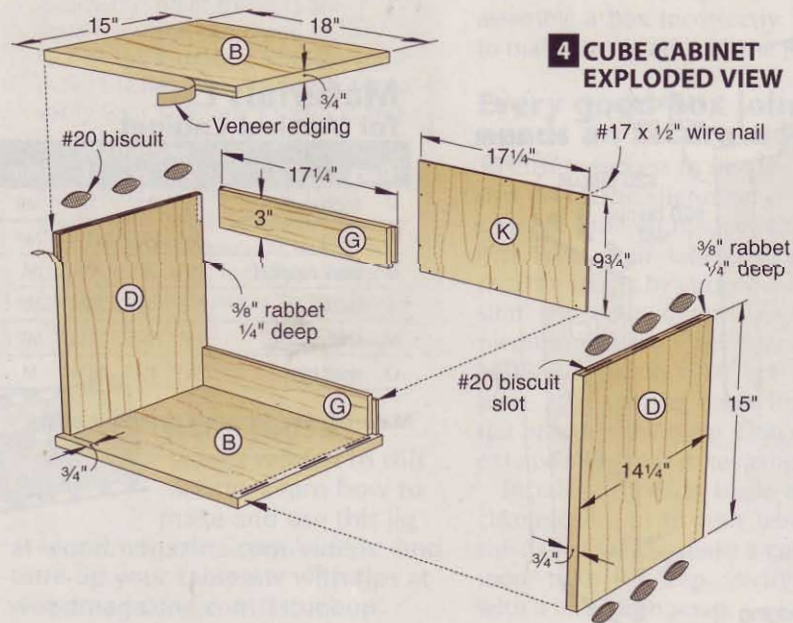

**5 BACK SUPPORT RABBET DETAIL**

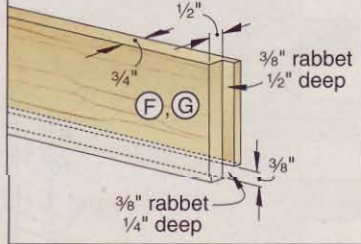

**Materials List for Cube Cabinet**

Part	FINISHED SIZE			Matl.	Qty.
	T	W	L		
B top/bottom	3/4"	15"	18"	MP	2
D sides	3/4"	14 1/4"	15"	MP	2
G back supports	3/4"	3"	17 1/4"	M	2
K back	1/4"	17 1/4"	9 3/4"	MP	1

Materials key: MP—maple plywood, M—maple.

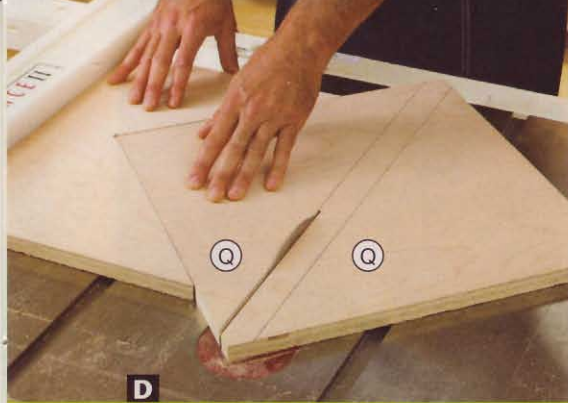

**D**  
**CUT THE TOP/BOTTOM**

Use the triangle-cutting jig to safely hold and crosscut the triangular top/bottom (Q) from the 16x16" blank along the marked lines.

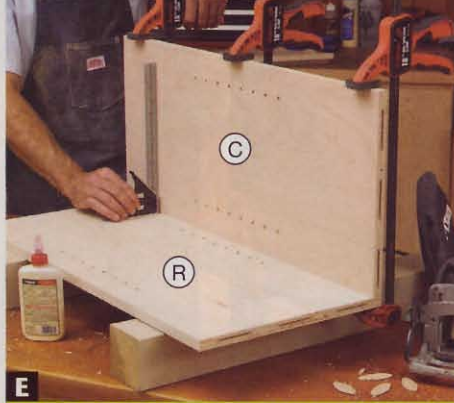

**E**  
**ASSEMBLE THE TRIANGULAR CABINET SIDES, AND ADD THE TOP/BOTTOM**

Assemble the sides (C, R) for the triangular case together with glue, biscuits, and clamps. Check the assembly for square. Then, with the side assembly (C/R) on a side, glue, biscuit, and clamp the top/bottom (Q) to the assembly, flush with the backs of the sides.

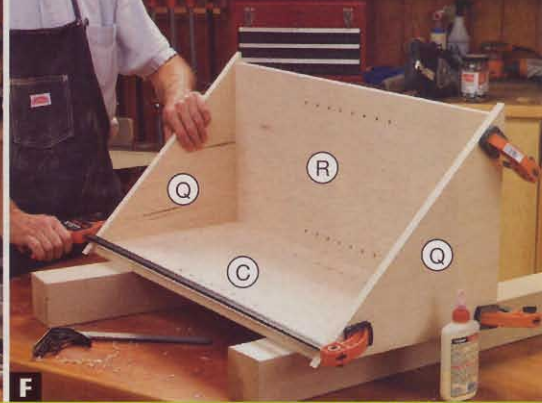

**F**

## Build the triangular case

**1** To form the top/bottom (Q) [Drawing 6], lay out two right triangles with 15"-long sides at opposing corners on a 16x16" piece of 3/4" plywood. Make the simple triangle-cutting jig [Drawing 7] from 3/4" plywood, using a bandsaw or jigsaw to cut out the 90° opening and the 1/4x1/4" corner relief notch. With the workpiece cradled in the jig, crosscut the top/bottom pieces to size [Photo D]. To ensure that the grain of the top and bottom flows from left to right (not front to back) to match the grain direction of the other cabinets, flip the parts as needed to correctly orient the grain during assembly.

**2** Cut the sides (C, R) to the sizes listed [Materials List, below]. Then apply 7/8"-wide iron-on veneer edging to the top/bottom (Q) and sides, where shown.

**3** Mark centerpoints for shelf-support holes on the *inside* faces of the sides (C, R), where dimensioned. Drill the 1/4" holes 3/8" deep.

**4** Holding your story stick flush with the front edge of each part, mark centerlines for #20 biscuit slots on the sides (C, R), where shown. Using your biscuit joiner, plunge the slots. You'll transfer these marks onto the top/bottom (Q) after assembling the sides.

**5** Glue, biscuit, and clamp the sides (C, R) together [Photo E]. After the glue dries, position the side assembly on the *top* (marked) face of the bottom (Q),

flush with the edges. It does not matter which way you orient the side assembly. Transfer the biscuit-slot centerlines from the sides to the bottom. Repeat for the top (Q), positioning it with the *bottom* (unmarked) face up. Plunge the slots. Then glue, biscuit, and clamp the top and bottom to the sides [Photo F].

**6** Cut the shelves (S) and shelf trim (T) to the sizes listed, miter-cutting the ends of the trim to fit flush at the ends of the shelves. As you did for the top/bottom (Q), lay out the shelves on a 13x13" blank, and cut them to shape using the triangle-cutting jig. Rout 1/8" round-overs along the front edges of the trim. Now glue and clamp the trim to the front edges of the shelves, flush with the top faces.

**6 TRIANGULAR CABINET EXPLODED VIEW**

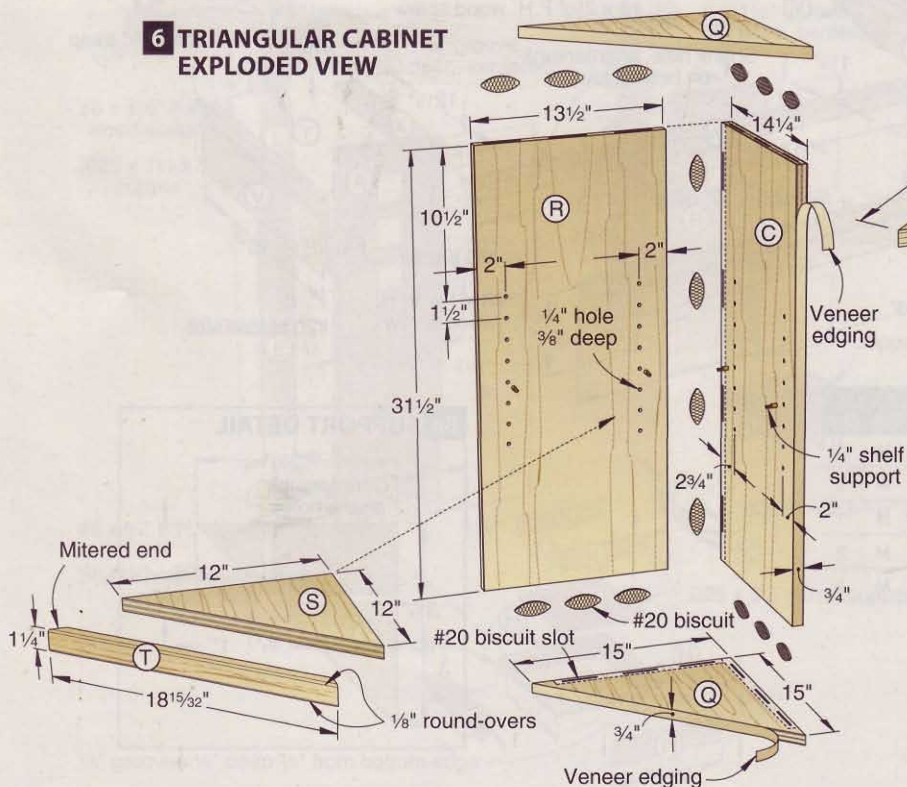

**7 TRIANGLE-CUTTING JIG**

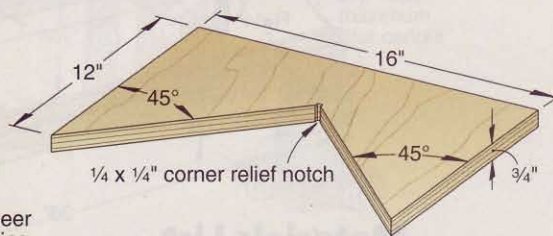

## Materials List for Triangular Cabinet

Part	FINISHED SIZE			Matl.	Qty.
	T	W	L		
C side	3/4"	14 1/4"	31 1/2"	MP	1
Q* top/bottom	3/4"	15"	15"	MP	2
R side	3/4"	13 1/2"	31 1/2"	MP	1
S* shelves	3/4"	12"	12"	MP	2
T shelf trim	3/4"	1 1/4"	18 15/32"	M	2

\*Parts initially cut oversize. See the instructions.

**Materials key:** MP—maple plywood, M—maple.



**G** ASSEMBLE THE RECTANGULAR BASE

Glue and biscuit the rectangular-base front and sides (U, V) together. Use the front cleat (W) as a spacer to keep the assembly square.

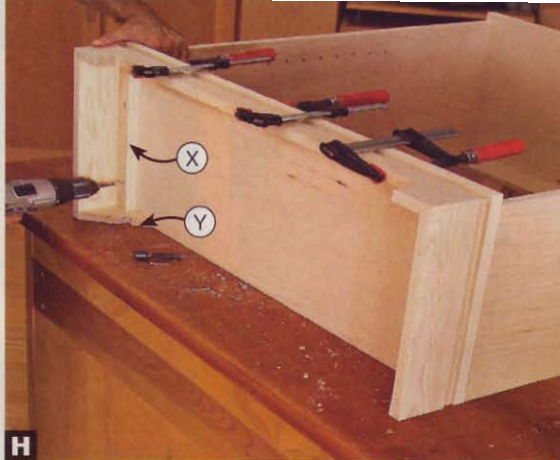

**H** MOUNT THE RECTANGULAR BASE

Center the rectangular base side-to-side on the cabinet(s). Drill pilot holes, and drive screws through the cleats (W, X) and supports (Y).

## Add the rectangular base

**1** Cut the base front and sides (U, V), front and side cleats (W, X), and supports (Y) to the sizes listed [Materials List, below], except cut the front and sides 1" longer.

**2** Lay out and bandsaw or jigsaw the supports (Y) to shape [Drawing 8a]. Then drill countersunk shank holes through the supports and front and side cleats (W, X), where shown [Drawings 8 and 8a].

**3** Miter-cut one end of each side (V) to the finished length of 15". Then

miter-cut both ends of the front (U) to the finished length of 36".

**4** Lay out the cutout on the front (U), where dimensioned. Bandsaw or jigsaw and sand to shape.

**5** Using your biscuit joiner, plunge slots for #20 biscuits into the mitered ends of the front and sides (U, V), where shown [Drawing 8].

**6** Using a dado blade in your tablesaw or a straight bit in your router, machine a  $\frac{3}{4}$ " rabbet  $\frac{1}{4}$ " deep along the top edges of the front and sides (U, V) on the outside faces.

**7** Glue, biscuit, and clamp the front and sides (U, V) together [Photo G]. Then glue and clamp the front and side cleats (W, X) to the front and sides, flush with the top edges. Now glue and screw the supports (Y) to the sides (V), flush at the tops and back ends.

**8** To mount the base to a 36"-wide double or horizontal cabinet or to two 18"-wide vertical or cube cabinets placed side-by-side, lay the cabinet(s) back side down on a flat surface. Center and screw-mount the base to the cabinet bottom(s) [Photo H].

## 8 RECTANGULAR BASE EXPLODED VIEW

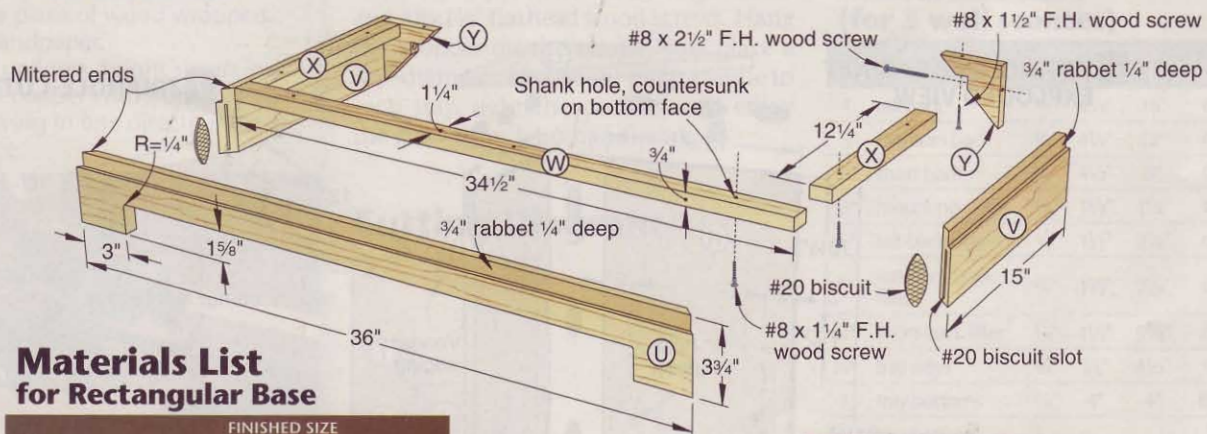

## Materials List for Rectangular Base

Part	FINISHED SIZE			Matl.	Qty.
	T	W	L		
U* front	$\frac{3}{4}$ "	$3\frac{3}{4}$ "	36"	M	1
V* sides	$\frac{3}{4}$ "	$3\frac{3}{4}$ "	15"	M	2
W front cleat	$\frac{3}{4}$ "	$1\frac{1}{4}$ "	$34\frac{1}{2}$ "	M	1
X side cleats	$\frac{3}{4}$ "	$1\frac{1}{4}$ "	$12\frac{1}{4}$ "	M	2
Y supports	$\frac{3}{4}$ "	$3\frac{3}{4}$ "	$3\frac{3}{4}$ "	M	2

\*Parts initially cut oversize. See the instructions.

Material key: M-maple.

## 8a SUPPORT DETAIL

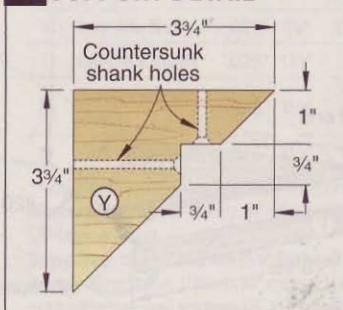

## On to the triangular base

**1** Cut the base front (Z), sides (AA, BB), and cleats (CC) to the sizes listed [Materials List, below], except cut the front and sides 1" longer.

**2** Miter-cut one end of the side (AA) to the finished length of 13<sup>15</sup>/<sub>16</sub>". Then miter-cut one end of the side (BB) to the finished length of 13<sup>3</sup>/<sub>16</sub>". Now miter-cut both ends of the front (Z) to the finished length of 21<sup>3</sup>/<sub>16</sub>".

**3** Lay out the cutout on the front (Z), where dimensioned. Bandsaw or jigsaw and sand to shape.

**4** Using your biscuit joiner, plunge slots for #20 biscuits centered into the mitered ends of the front (Z) and sides (AA, BB).

**5** Cut or rout a 3/4" rabbet 1/4" deep along the top edge of the front (Z) on the outside face [Drawing 9].

**6** Dry-assemble the front and sides with biscuits, and clamp together. Drill the countersunk shank holes through the side (AA) into the side (BB), and drive the screws [Photo I]. Remove the clamp and front (Z). Then glue, biscuit, and assemble the front to the sides, and reclamp.

**7** Drill countersunk shank holes through the cleats (CC), where shown [Drawing 9]. Then glue and clamp the cleats to the front (Z) and sides (AA, BB), centered and flush with the top edges.

**8** To mount the base, lay the triangular case with a side down on a flat surface. Position the base on the case bottom, aligned at the back. Then attach the base to the case [Photo J].

## Swing over to the door

**1** Cut the door rails (DD) and stiles (EE) to the sizes listed [Materials List, next page].

**2** Mark mating centerlines for a pair of #10 biscuit slots at the ends of the rails and stiles, where dimensioned [Drawings 10 and 10a, next page]. Using your biscuit joiner, plunge the slots. Then glue, biscuit, and clamp the rails and stiles together.

**3** Using a rabbeting bit in your router, rout a 3/8" rabbet 1/2" deep around the inside of the frame assembly (DD/EE) on the back. To avoid chip-out, rout the rabbet in four passes, removing approximately 1/16" of stock with each pass. Then square the corners with a chisel.

**4** Cut the 1/4" plywood panel (FF) and the horizontal and vertical panel stops (GG, HH) to the sizes listed to fit

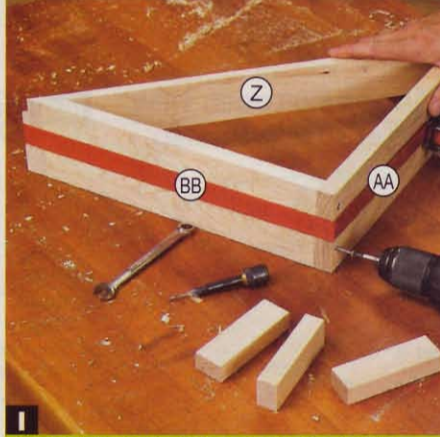

**I SCREW THE TRIANGULAR BASE**

Band-clip the triangular-base front (Z) and sides (AA, BB) together. Drill the mounting holes, and screw side AA to BB.

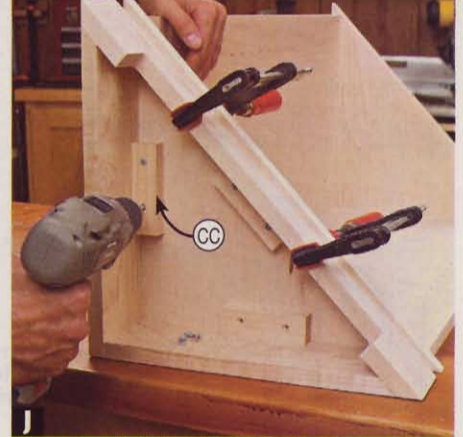

**J ATTACH THE TRIANGULAR BASE**

Align the triangular base flush at the back of the case. Drill pilot holes, and drive screws through the cleats (CC) into the case bottom.

## Materials List for Triangular Base

Part	FINISHED SIZE			Matl.	Qty.
	T	W	L		
Z* front	3/4"	3 3/4"	21 3/16"	M	1
AA* side	3/4"	3 3/4"	13 15/16"	M	1
BB* side	3/4"	3 3/4"	13 3/16"	M	1
CC cleats	3/4"	1 1/4"	4"	M	3

\*Parts initially cut oversize. See the instructions.

Material key: M—maple.

## 9 TRIANGULAR BASE EXPLODED VIEW

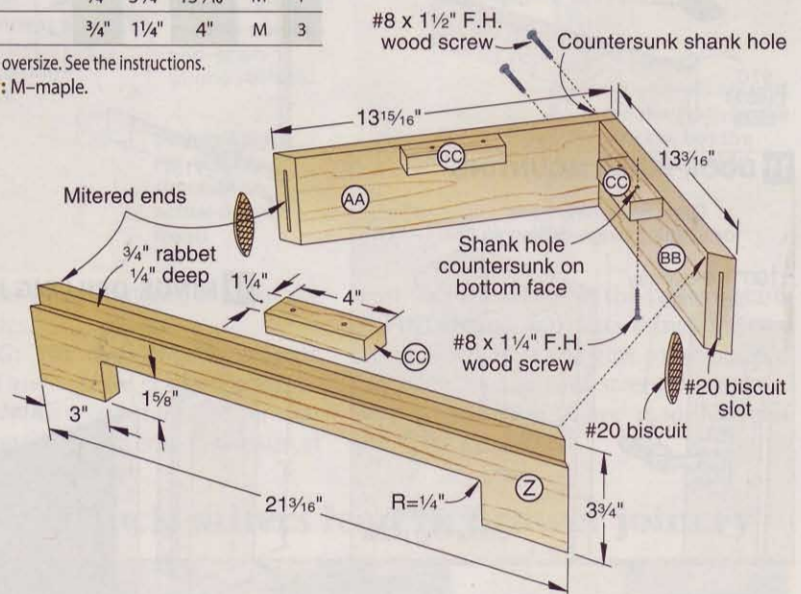

into the rabbeted opening. Position the panel (or glass, as appropriate) and stops into the opening. Drill pilot holes through the stops and into the frame using a #17x1" wire brad with its head snapped off. Then secure the stops by driving #17x3/4" wire brads. Place a piece of cardboard on the panel to prevent damaging the panel with your hammer.

**5** Mark centerpoints on the back face of a door stile (EE) for the 1 3/8" holes for the 100° full-overlay clip hinges, where dimensioned [Drawing 10]. Bore the 7/16"-deep holes using a Forstner bit in your drill press. Install the hinges, and mark the mounting holes. Drill the pilot holes, and drive the screws supplied with the hinges.

**6** To mount the hinge-clip mounting plates to the sides (C) of the double and vertical cabinets, draw centerlines at the top and bottom of the sides along the front edges, where dimensioned [Drawing 11]. Make the hinge-drilling jig [Drawing 12], marking a centerline on the jig, where shown. Using the jig and a self-centering bit to prevent enlarging the jig holes, drill the pilot holes into the sides [Photo K]. Screw-mount the plates using the supplied screws. Now engage the hinge members, and align the doors using the hinge-adjusting screws. Mounting the doors now lets you check the fit and do any trimming needed before finishing. Remove the doors and hinges.

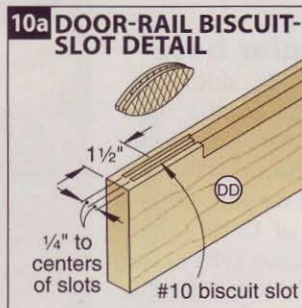
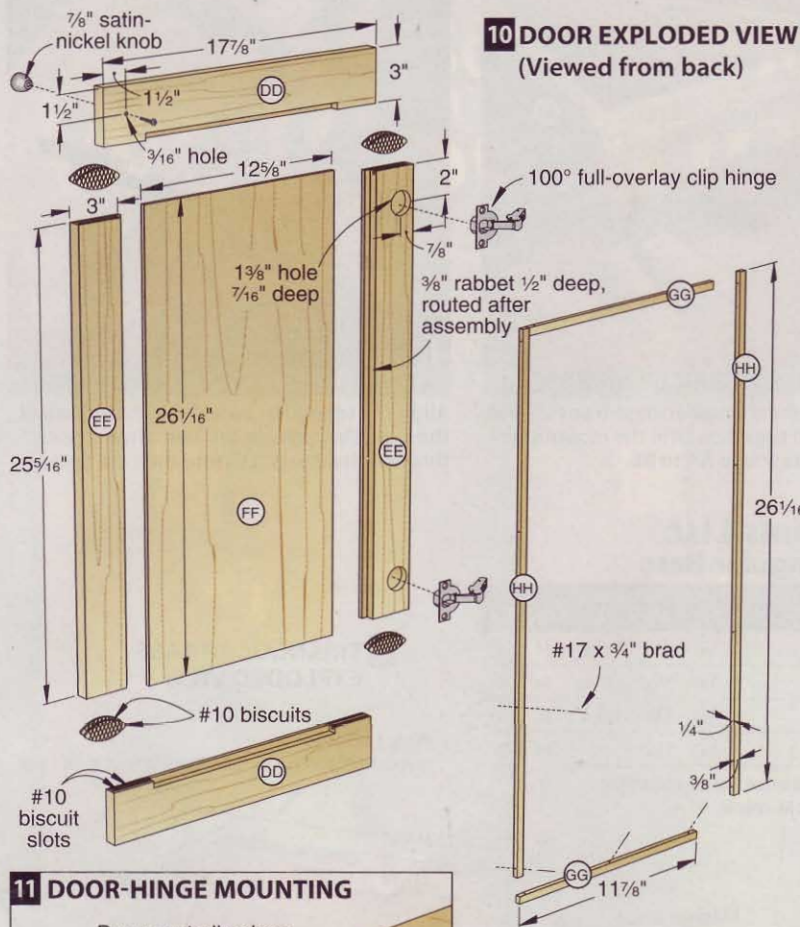

**7** On the top rail (DD), mark a centerpoint for a  $\frac{3}{16}$ " hole to mount a  $\frac{7}{8}$ " satin-nickel knob, where dimensioned [Drawing 10]. Drill the hole. You'll install the knob later.

### Finish up

**1** Sand any areas that need it to 220 grit, and remove the dust. Then stain and finish the backs, cabinets, shelves, bases, and doors. We applied Varathane no. 218 Traditional Pecan Stain, followed by three coats of Minwax Polycrylic Water-Based Clear Satin Protective Finish, sanding to 220 grit between coats.

**2** Install the backs (H, I, J, K) on the cabinets using #17x $\frac{1}{2}$ " wire nails [Drawings 1 through 4].

**3** Mount the door hinges, doors, and  $\frac{7}{8}$ " satin-nickel knobs. Apply the  $\frac{1}{4}$ "-diameter adhesive-backed rubber bumpers to the doorstep (P) [Drawing 1].

**4** Using a helper, move the cabinets to the desired location, and place them in the planned configuration. Level them, if needed, by placing shims under the bases. If you wish to fasten the cabinets together, use panel-connector bolts.

**5** Finally install the shelves using  $\frac{1}{4}$ " spoon shelf supports. Now add your favorite display pieces, books, and other items to the cabinets, and step back to take in your modular masterpiece. 🌳

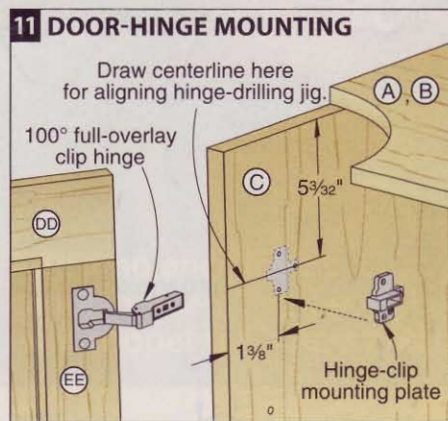

### 12 HINGE-DRILLING JIG

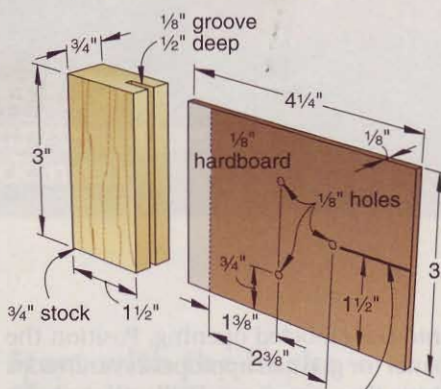

Draw centerline on jig for aligning with marked centerline in cabinet.

Written by **Owen Duvall**  
Project design: **Kevin Boyle**  
Illustrations: **Roxanne LeMoine; Lorna Johnson**

### Supplies and Source

**Supplies:**  $\frac{7}{8}$ "-wide iron-on veneer edging; 1"-long wood roller; #10 and #20 biscuits;  $\frac{1}{4}$ " spoon shelf supports;  $\frac{1}{4}$ "-diameter rubber bumpers; #17x $\frac{1}{2}$ " wire nails; #17x $\frac{3}{4}$ " and #17x1" wire brads; #8x $\frac{1}{4}$ ", #8x $\frac{1}{2}$ ", and #8x2 $\frac{1}{2}$ " flathead wood screws; 100° full-overlay clip hinges (2 per door); hinge-clip mounting plates (2 per door);  $\frac{7}{8}$ " satin-nickel knob (1 per door).

**Blade and bits:** Dado-blade set;  $\frac{3}{8}$ " rabbeting,  $\frac{1}{8}$ " round-over, and  $\frac{3}{4}$ " straight router bits;  $\frac{1}{4}$ " brad-point bit; 1 $\frac{3}{8}$ " Forstner bit.

### Source

**Hardware:**  $\frac{7}{8}$ "-wide iron-on veneer edging, no. ET078PB, \$26.01 per 250' roll;  $\frac{7}{8}$ " satin-nickel knob, no. A27018G10, \$3.46 ea. (1 per door); 100° full-overlay clip hinges, no. B071M255, \$2.05 ea. (2 per door); hinge-clip mounting plates, no. B175H710, \$1.24 ea. (2 per door);  $\frac{1}{4}$ " spoon shelf supports, no. HB28C25, \$2.20 per pkg. of 20 (4 supports needed per shelf). Call or click Woodworker's Hardware, 800-383-0130; wwhardware.com.

**Trimmers:** End trimmer, no. VIRC21E, \$41.69; double-sided edge trimmer, no. VIAU93, \$17.59. Phone and Web address above.

### Materials List for Door

Part	FINISHED SIZE			Matl.	Qty.
	T	W	L		
DD rails	$\frac{3}{4}$ "	3"	17 $\frac{7}{8}$ "	M	2
EE stiles	$\frac{3}{4}$ "	3"	25 $\frac{5}{16}$ "	M	2
FF panel	$\frac{1}{4}$ "	12 $\frac{5}{8}$ "	26 $\frac{1}{16}$ "	MP	1
GG horizontal panel stops	$\frac{1}{4}$ "	$\frac{3}{8}$ "	11 $\frac{7}{8}$ "	M	2
HH vertical panel stops	$\frac{1}{4}$ "	$\frac{3}{8}$ "	26 $\frac{1}{16}$ "	M	2

**Materials key:** MP—maple plywood, M—maple.



### DRILL THE HINGE-CLIP HOLES

Position the hinge-drilling jig cleat tightly against the case side (C) with the centerlines aligned. Drill the holes for the hinge plates.

SHOP-TESTED

# General-Purpose Tablesaw Blades

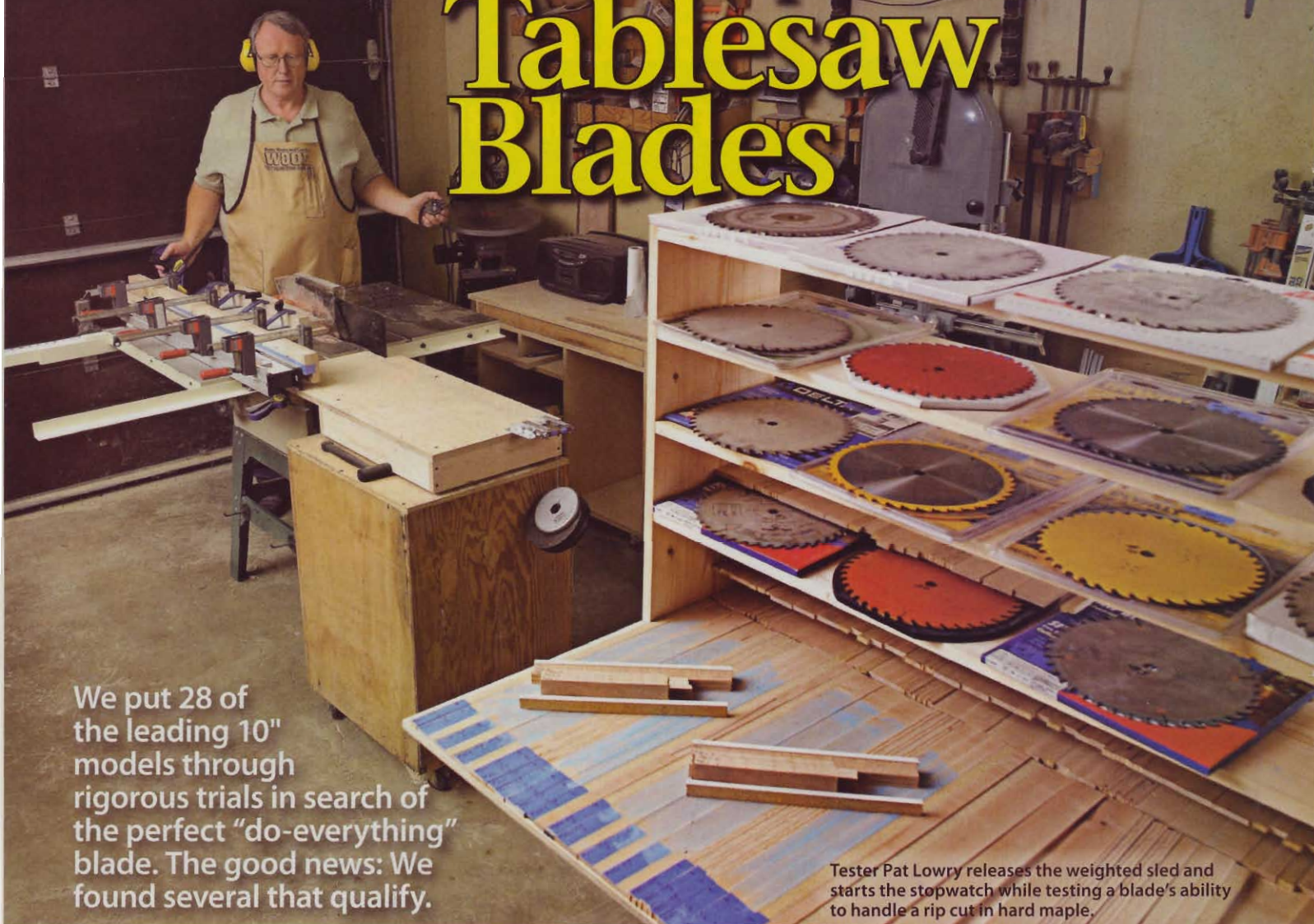

We put 28 of the leading 10" models through rigorous trials in search of the perfect "do-everything" blade. The good news: We found several that qualify.

Tester Pat Lowry releases the weighted sled and starts the stopwatch while testing a blade's ability to handle a rip cut in hard maple.

Changing tablesaw blades ranks right up there with changing speeds on a drill press or lathe: We know certain cuts call for specific blades for peak performance, but still, we don't always take the time to make a switch. Now you don't have to sweat those changes—if you have a proven general-purpose blade on your tablesaw.

In previous tests we found that 40-tooth general-purpose blades typically outperform 50-tooth combination blades [Photo A], with less scoring and quicker feed rates on rip cuts. So we rounded up 28 general-purpose blades (16 thin-kerf, 12 full-kerf) from 19 manufacturers and tested them in crosscuts and rip cuts in hard maple, melamine-coated particleboard, and birch plywood using 10" contractor- and cabinet-style tablesaws.

## Tests eliminated variables to put focus on the blades

To make sure we tested the blades and not the tablesaws used, we tuned up each saw to within 0.001" (arbor run-out, as well as miter slots and rip fence parallel to blade) and sprayed the top with a dry lubricant every time we changed blades.

For crosscuts we clamped stock to an Inkra V27 miter gauge—dialed in to exactly 90°—with an auxiliary backer board, and used insert plates with  $\frac{3}{8}$ "-wide openings around the blades. We crosscut three samples each from 8"-wide hard maple (1" and 2" thick) and 12"-wide,  $\frac{3}{4}$ "-thick birch-veneered plywood and melamine.

We made three rip cuts in 2'-long stock on each saw using a weighted sled as a carrier, ensuring equal feed pressure.

This showed us how quickly each blade cut the different materials on each saw. In most cases thin-kerf blades cut faster than  $\frac{1}{8}$ "-kerf blades. Because the test samples rode on the sled  $\frac{3}{4}$ " above the tabletop, all rip cuts were unsupported

## MORE TEETH = MORE SCORING



General-purpose blades, like this DeWalt (front), have 40 evenly spaced teeth. Combination blades, like this Freud, have 50 teeth in groups of five separated by deep gullets.





To see our testing methods in action, view a free video at: [woodmagazine.com/videos](http://woodmagazine.com/videos)

at the cutline—which gave us a good indication of bottom-face tear-out.

With all cutting complete, we evaluated each sample, looking for scoring marks on the cut edges (revealed with blue chalk [Photos B and C]), and tear-out on the top and bottom faces. For rip-cut samples, we judged the edge cut on the fence side of the blade (typically the “keeper” workpiece). For crosscut samples, we evaluated the edge cut on the miter-gauge side of the blade.

## Here’s what we learned

■ **There’s no substitute for having a properly tuned tablesaw.** Even the best blade will perform below its capability when installed on a saw that’s not properly dialed in. So take the time to check your arbor for runout (and fix it according to the manufacturer’s recommendations), align the tabletop’s miter slots and rip fence parallel to the blade, and then coat the top with a dry lubricant. You should also check your blade for run-out. (None of the 28 tested blades had runout worth noting.)

■ **Birch plywood and hard maple revealed the top performers.** Cross-grain tear-out in birch plywood and hard maple proved to be a problem for about three-fourths of the blades. This reaffirms the importance of using a zero-clearance insert to prevent tear-out. Similarly, ripping 2"-thick hard maple proved a tough task for many of the blades, with slower feed rates and pro-

## THE SCORES NEVER LIE

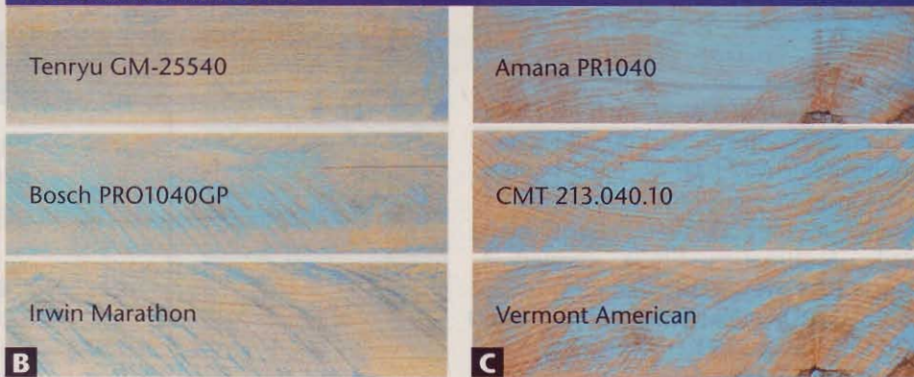

**B** These chalked rip-cut (left) and crosscut samples show an edge with no scoring (top), slight scoring (middle), and substantial scoring (bottom).

## FEW CUT CLEAN IN MELAMINE



**D** Top-side tear-out on these melamine samples helped us to see which blades produce the cleanest cuts.

nounced scoring. (The blades that struggled most with 2"-thick maple also struggled—to a slightly lesser degree—with 1"-thick maple.) So you’re better off for this job to install a true rip blade with 24 to 30 teeth and wider gullets for chip removal.

■ **Melamine challenged all blades.** Every blade manufacturer will tell you these blades are not meant to cut melamine-coated particleboard. We agree. Instead, for best results use a dedicated blade with a high tooth count (we like 80).

That said, we used that material as our acid test to see whether any of the blades

could make tear-out-free cuts [Photo D]. All of the blades struggled with bottom-face tear-out in melamine (again, no zero-clearance insert for support). But seven blades (Amana’s PR1040 and TB10400, both Forrest Woodworker II models, Infinity’s 010-044, Ridge Carbide’s TS21040TK, and Tenryu’s GM-25540) cut so cleanly on the top face that we have to give them extra credit.

■ **Blades with large carbide teeth offer more sharpenings.** For example, Forrest and Ridge Carbide blades have long, thick teeth that not only deliver high-quality cuts with little or no tear-out, but also allow for more sharpenings [Photo E]. Blades with small carbide teeth can be resharpened a time or two, but because the cost is about the same as buying a replacement blade you’re probably better off getting a new one. Other makes that don’t skimp on the carbide: Amana, CMT, Freud, Infinity, Jesada, Systimatic, and Tenryu. But that extra carbide drives up the cost of the blade.

■ **Low-noise blade goes easy on your ears.** The ITP/H.O. Schumacher blade lives up to its billing for quietness, scoring significantly lower sound levels than the next-quietest blade, thanks to its innovative tooth design [Photo F]. You’ll

## LARGER TEETH EXTEND LIFE

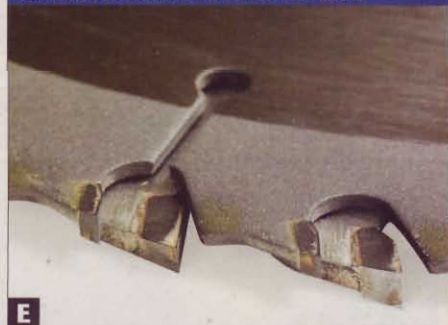

**E** Blades with large carbide teeth, like the Forrest Woodworker II (bottom), can be sharpened more times than those with small teeth, like the Irwin Marathon (top).

## BLADE DESIGN MAKES LESS NOISE



**F** ITP/H.O. Schumacher’s pattern of three different intervals between successive teeth disturbs the air less, resulting in a noticeably quieter cut.

appreciate this blade if you're using a tablesaw without any other machine running simultaneously, such as a dust collector. (Sound levels do not compound; your ears hear only the loudest noise around you.) Still, its cut quality proved average at best. The loudest blade, Systimatic's 51821, created a whine that averaged in our three tests about 22 dB greater than the ITP blade—four times as loud. That's like comparing a drill press (72 dB in our shop, no load) to a router (94 dB, no load).

■ **Burning was not an issue.** None of the blades left burn marks in any of the materials unless we intentionally stalled a workpiece in mid-cut.

■ **Toolmakers fared well.** We were surprised to see good performances out of economy blades from several manufacturers known more for making tools than blades. Bosch, Craftsman, Delta, DeWalt, and Makita's blades all cut respectably with only minor scoring.

■ **Performance results divulged no preferred grind pattern.** All of the blades we tested had an alternate-tooth bevel (ATB) grind, meaning the teeth pointed in a left-right-left-right pattern. Two blades, however, added flat-tipped raker teeth: Both Ridge Carbide blades had one raker tooth following four ATB teeth, and CMT's 251.042.10 had one raker tooth following two ATB teeth. The tooth bevel angles on all blades ranged from 10° to 40°, and hook angles from 5° to 20°. However, we were not able to find any consistent test results that could be traced back to any of these blade specifications.

## Where to put your money

As you can see from the performance grades in the chart at right, the premium-priced blades earn their keep with little to no scoring or tear-out. We think you'll be thrilled with the performance of any of the blades costing \$90 or more, but we give a slight edge—and Top Tool honors—to the following blades:

- The Forrest WW10407100 (thin-kerf);
- The Forrest WW10407125 (full-kerf);
- Ridge Carbide TS21040TK (thin-kerf);
- Tenryu GM-25540 (thin-kerf).

Among the blades priced \$65 or less, two Amana blades, the TB10400 (\$65) and the PR1040 (\$52), stood above the rest. Craftsman's 32808 professional blade (\$40) also performed well. These three share Top Value honors. 🌿

Written by **Bob Hunter** with **Pat Lowry**



Ridge Carbide TS21040TK



Forrest WW10407100



Forrest WW10407125



Tenryu Gold Medal



Amana TB10400



Amana PR1040



Craftsman 32808

MANUFACTURER	MODEL	BLADE SPECIFICATIONS							NOISE LEVEL, DECIBELS (1)
		NUMBER OF TEETH	TEETH BEVEL ANGLE, DEGREES	TEETH HOOK ANGLE, DEGREES	KERF WIDTH, INCHES	PLATE COATED? (YES/NO)	NO LOAD	RIPPING 1" THICK HARD MAPLE	RIPPING BIRCH PLYWOOD

### PREMIUM BLADES: \$90 OR MORE

FORREST	WW10407100	40	20	20	0.100	N	85	89	93
FORREST	WW10407125	40	20	20	0.125	N	87	92	94
FREUD	P410	40	30	18	0.126	Y	86	90	93
INFINITY	010-044	40	30	18	0.125	Y	83	86	89
RIDGE CARBIDE	TS21040	40	15	15	0.125	N	96	98	102
RIDGE CARBIDE	TS21040TK	40	15	15	0.093	N	86	89	92
TENRYU	GM-25540	40	15	20	0.111	N	87	92	94

### ECONOMY BLADES: \$65 OR LESS

AMANA	TB10400	40	10	15	0.090	N	89	95	98
JESADA	110-440	40	20	18	0.126	N	82	87	90
CMT	213.040.10	40	20	18	0.130	Y	97	101	104
SYSTIMATIC	37437	40	20	10	0.093	N	95	99	102
SYSTIMATIC	51821	40	20	15	0.125	N	101	104	106
ITP/H.O. SCHUMACHER	40-HATB-VP	40	40	12	0.125	N	78	83	85
AMANA	610400	40	10	15	0.126	N	94	97	100
AMANA	PR1040	40	20	18	0.134	N	95	99	102
OLDHAM	1007740	40	10	17	0.115	N	92	96	98
BOSCH	PRO1040GP	40	15	15	0.128	Y	96	99	102
DELTA	35-7657	40	15	20	0.118	N	90	94	97
CMT	251.042.10	42	15	15	0.098	N	88	92	96
CRAFTSMAN	32808	40	15	15	0.100	N	87	91	94
MAKITA	A-94459	40	15	20	0.091	N	87	91	94
FREUD	LU86R010	40	10	13	0.094	Y	88	93	96
VERMONT AMERICAN	27831	40	12	13	0.098	Y	88	97	99
DEWALT	DW7140PT	40	10	20	0.098	Y	86	91	95
HITACHI	310878	40	20	5	0.098	N	84	89	92
FREUD	D1040	40	15	15	0.098	Y	86	91	94
DEWALT	DW3114	40	10	10	0.095	N	86	92	95
IRWIN	14070	40	10	20	0.095	N	88	93	97

NOTES:

1. Measured on a contractor tablesaw at operator's ear level.

2. 

A	Excellent
B	Good
C	Fair
D	Poor

# GENERAL-PURPOSE TABLESAW BLADES: PERFORMANCE BY PRICE

PERFORMANCE RATINGS (2)																				CONTACT INFORMATION			
1"-THICK HARD MAPLE					2"-THICK HARD MAPLE					¾"-THICK BIRCH PLYWOOD					¾"-THICK MELAMINE					COUNTRY OF MANUFACTURE (4)	SELLING PRICE (5)	PHONE NUMBER	WEB SITE
ABSENCE OF:					ABSENCE OF:					ABSENCE OF:					ABSENCE OF:								
RIP-CUT SCORING	CROSSCUT SCORING	CROSSCUT TEAR-OUT (TOP)	CROSSCUT TEAR-OUT (BOTTOM)	EASE OF FEED (CONTRACTOR SAW)	EASE OF FEED (CABINET SAW)	RIP-CUT SCORING	CROSSCUT SCORING	CROSSCUT TEAR-OUT (TOP)	CROSSCUT TEAR-OUT (BOTTOM)	EASE OF FEED (CONTRACTOR SAW)	EASE OF FEED (CABINET SAW)	RIP-CUT SCORING	CROSSCUT SCORING	CROSSCUT TEAR-OUT (TOP)	CROSSCUT TEAR-OUT (BOTTOM)	EASE OF FEED (CONTRACTOR SAW)	EASE OF FEED (CABINET SAW)	CUT SCORING	TEAR-OUT (TOP)				

A	A	A	A	A	A	A	A	A	A	A	A	A	A	A	A	A	A	A	B	A	B	A	A	LD/30	U	\$110	800-733-7111	forrestblades.com
A	A	A	A	B	A	A	A	A	A	B	A	A	A	A	A	A	A	A	B	A	B	A	A	LD/30	U	\$110	800-733-7111	forrestblades.com
A	B	A	B	B	A	A	B	B	B	B	A	A	A	B	B	A	A	B	C	C	A	A	LD	IT	\$100	800-334-4107	freudtools.com	
A	A	A	A	B	A	A	B	A	B	B	A	A	B	A	B	A	A	B	A	B	A	A	LD	IT	\$100	877-872-2487	infinitytools.com	
B	B	B	B	B	A	B	B	B	B	B	A	B	B	B	A	A	C	B	B	A	A	LD	U	\$97	800-443-0992	ridgecarbidetool.com		
A	A	A	A	A	A	A	A	A	A	A	A	A	A	A	A	A	B	A	C	A	A	LD	U	\$97	800-443-0992	ridgecarbidetool.com		
A	A	A	A	A	A	A	A	A	A	A	A	A	A	A	A	A	B	A	B	A	A	LD	J	\$90	800-951-7297	tenryu.com		

A	B	A	A	A	A	A	B	A	B	B	A	A	A	A	B	A	A	B	A	C	A	A	LD	IS	\$65	800-445-0077	amanatool.com	
C	B	C	B	B	C	D	C	B	B	C	C	C	C	B	B	B	B	C	C	D	B	B	LD	G	\$62	877-898-6657	razorwoodworks.com	
B	B	B	B	C	B	B	B	B	B	B	B	B	B	B	B	B	B	B	C	C	B	B	LD	G	\$60	888-268-2487	cmtusa.com	
C	B	B	B	B	B	D	C	B	B	C	B	C	C	B	B	B	B	C	C	D	B	B	LD	CZ	\$60	800-343-1616	simondsinternational.com	
B	B	B	B	C	B	B	B	B	B	B	B	B	B	B	B	B	B	C	B	C	B	B	LD	CZ	\$57	800-343-1616	simondsinternational.com	
C	B	C	B	B	B	D	C	B	B	B	B	C	B	B	B	B	B	C	C	D	B	B	LD	G	\$55	866-537-0700	itptooling.com	
B	B	B	B	B	B	B	B	B	B	B	B	B	B	B	B	B	B	B	B	C	A	B	LD	IS	\$55	800-445-0077	amanatool.com	
A	A	A	B	B	A	A	A	A	B	B	A	A	B	A	B	B	A	B	A	C	A	A	LD	IS	\$52	800-445-0077	amanatool.com	
C	B	C	B	C	C	D	D	B	B	C	C	C	C	B	B	B	B	C	C	D	B	B	30	U	\$50	800-433-9258	oldham-usa.com	
B	B	B	B	B	B	B	B	B	B	B	B	B	B	B	B	B	B	B	C	C	B	B	LD	C	\$45	877-267-2499	boschttools.com	
B	B	B	B	B	B	B	C	B	B	B	B	B	C	B	B	B	B	B	C	C	B	B	30	U	\$43	800-223-7278	deltaportercable.com	
B	B	B	B	B	B	B	B	B	B	B	B	B	B	B	B	B	B	B	C	C	B	B	LD	G	\$40	888-268-2487	cmtusa.com	
B	B	B	B	B	A	B	B	A	B	B	A	B	A	A	B	A	A	B	C	C	A	A	None	IT	\$40	800-383-4814	craftsman.com	
B	B	B	B	B	B	B	B	B	B	B	B	B	B	B	B	B	B	B	C	B	C	B	B	1 year	J	\$40	800-462-5482	makitatools.com
B	B	B	B	B	B	B	B	B	B	B	B	B	B	B	B	B	B	B	C	C	B	B	LD	IT	\$35	800-334-4107	freudtools.com	
C	B	C	B	C	C	D	D	B	B	C	C	C	C	B	B	B	C	C	D	B	B	LD	C	\$35	800-626-2834	vermontamerican.com		
B	B	B	B	B	B	B	B	B	B	B	B	B	B	B	B	B	B	B	C	C	B	B	LD	U	\$35	800-433-9258	dewalt.com	
C	B	B	B	C	C	D	C	B	B	C	B	C	B	B	B	B	B	C	C	D	B	B	30	F	\$30	800-829-4752	hitachipowertools.com	
C	B	B	B	B	B	D	C	B	B	B	B	C	B	B	B	B	B	C	C	D	B	B	LD	IT	\$30	800-334-4107	freudtools.com	
B	B	B	B	B	B	C	B	B	B	B	B	B	B	B	B	B	B	B	C	C	B	B	30	C	\$28	800-433-9258	dewalt.com	
C	B	B	B	B	B	D	B	B	B	C	B	C	B	B	B	B	B	C	B	C	B	B	LD	N	\$28	800-464-7946	irwin.com	

3. (30) 30 days  
 (LD) Lifetime replacement for defects in material or workmanship  
 (LD/30) Lifetime replacement for defects in material or workmanship; 30 days full refund if not satisfied

4. (C) China  
 (CZ) Czech Republic  
 (F) France  
 (G) Germany  
 (IS) Israel  
 (IT) Italy  
 (J) Japan  
 (N) New Zealand  
 (U) United States

5. Prices current at time of article production and do not include shipping, where applicable.

# Presidential Coin Flag



You'll have fun with this project when you build it and each time you add the most recently released presidential coin.

## Start with the frame

**1** To form the built-up frame top/bottom and sides (A, B) [Drawings 1 and 2], cut two pieces each sized  $\frac{1}{2} \times 1 \times 38"$  for the inner members,  $\frac{3}{4} \times 2 \times 38"$  for the center members, and  $\frac{1}{2} \times 1\frac{1}{2} \times 38"$  for the outer members to form two blanks. You'll cut a frame top or bottom and a side piece from each blank. To avoid glue squeeze-out when laminating

the members together, cut a pair of  $\frac{1}{8}"$  relief grooves  $\frac{1}{8}"$  deep along both edges of each center member [Drawing 2].

**2** Angle your tablesaw blade  $20^\circ$  from vertical. Then bevel-rip each outer member where dimensioned, using a pushstick and feather board for safety. Sand the beveled edge to 220 grit. You'll cut the  $10^\circ$  bevel along the outer members after laminating the blanks.

## PROJECT HIGHLIGHTS

- Overall dimensions:  $19\frac{1}{4}"$  long  $\times$   $15"$  tall  $\times$   $1\frac{1}{2}"$  deep.
- Materials needed: A  $\frac{3}{4} \times 6 \times 84"$  piece of oak for the frame and mounting cleats; a  $9\frac{1}{2} \times 13\frac{3}{4}"$  piece of  $\frac{1}{4}"$  Baltic birch plywood for the flag backer; a small amount of  $\frac{1}{4}"$  maple to form a  $9\frac{1}{2} \times 13\frac{3}{4}"$  blank for the flag stripes; and twenty  $\frac{3}{4}"$  wood stars, available at crafts supply stores. (We found a bag of 25 for \$2.99 at our local Michaels.)

## Skill Builder

- Learn how to easily make an eye-catching, built-up frame with cove and beveled edges.

**3** Rout a  $\frac{1}{4}"$  cove along an edge of each inner member. Then laminate the inner, center, and outer members together in the configuration shown [Drawing 2, Photo A] to form two blanks.

**4** Angle your tablesaw blade  $10^\circ$  from vertical. Then bevel-rip the outer member of each blank, where dimensioned [Drawings 2 and 2a]. Sand the beveled edge. Now, using a dado blade, cut a  $\frac{1}{4}"$  rabbet  $\frac{5}{8}"$  deep along the inner member of each blank.

**5** Miter-cut a  $19\frac{1}{4}"$ -long piece from each blank for the frame top/bottom (A), and a  $15"$ -long piece from each of the remaining blanks for the frame sides (B) [Photo B].

**6** Using your biscuit joiner, plunge slots for #20 biscuits centered into each mitered end of the center members of the frame top/bottom and sides (A, B) [Drawing 1]. Then glue, biscuit, and assemble the frame [Photo C], verifying tight mitered corners.

**7** Cut the mounting cleats (C) to the size listed [Materials List, page 49]. Then, bevel-rip an edge at  $45^\circ$  on two of the cleats for the top, leaving a  $\frac{1}{16}"$  flat

## About the historic change

The U.S. Treasury is releasing a new series of one-dollar coins honoring our nation's Chief Executives in order of service. Each coin shows a president on one side and the Statue of Liberty on the other, as shown at right.

Unlike traditional coins, the gold-colored presidential coins have the "E Pluribus Unum" and "In God We Trust" inscriptions, as well as the date and mint identification ("P" for Philadelphia, "D" for Denver), cut into the edge instead of the surfaces. The Treasury already has issued four coins and will mint four new ones each year through at least 2016, as shown by the schedule on page 49. For more about the coins, go to [www.usmint.gov/\\$1coin](http://www.usmint.gov/$1coin).



### LAMINATE THE FRAME BLANKS

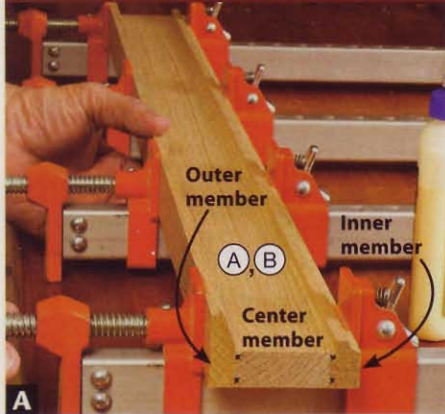

Laminate and clamp together the inner, center, and outer members, flush at the back, to form two blanks for the frame.

[Drawing 2]. Sand the cleats smooth, and set them aside.

### Prepare the flag backer

**1** From  $\frac{1}{4}$ " Baltic birch plywood, cut a  $9\frac{1}{2}$ "-wide by  $13\frac{3}{4}$ "-long piece for the flag backer (D). Sand smooth. Then, cover a 6"-wide  $\times$  7"-long area in the top-left corner where the  $\frac{3}{4}$ " wood stars will go [Drawing 1] with easy-release painter's tape.

**2** Make three copies of the full-size flag pattern from the *WOOD Patterns*<sup>®</sup> insert. From one pattern, cut out the 6 $\times$ 7" star area along the dotted lines. Spray-adhere the pattern to the masked area on the flag backer (D) [Photo D]. Set the remaining patterns aside.

**3** Using an awl and light pressure, make a small indentation into the flag backer (D) at the center of each star on the pattern to mark the locations. Next, using a sharp crafts knife, cut along the two curved lines that border the stars [Photo E]. Now, remove the star portion of the pattern and the underlying tape, leaving the remaining pattern and tape in place.

### MITER-CUT THE FRAME PARTS

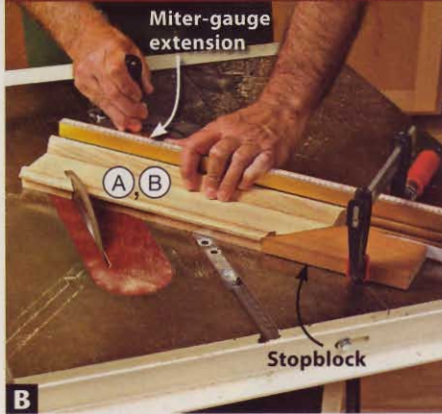

For a square frame, miter-cut the top/bottom (A) and sides (B) to the needed lengths using a stopblock and miter-gauge extension.

**4** Glue and clamp a beveled mounting cleat (C) to the back of the flag backer (D), flush at the top and ends with the bevel in the correct orientation [Drawings 1 and 2]. Then, glue and clamp the cleat *without* a beveled edge flush at the bottom of the backer.

### On to the stripes

**1** From edge-joined maple planed to  $\frac{1}{4}$ " thick, cut a  $9\frac{1}{2}$ " $\times$   $13\frac{3}{4}$ " piece for the flag-stripes blank (E).

**2** Spray-adhere one of the remaining flag patterns to the blank. Then, using a  $1\frac{1}{16}$ " Forstner bit, bore the  $\frac{3}{32}$ "-deep holes at the marked centerpoints on the stripes for the coins [Photo F]. Use a stop on your drill press to ensure consistent hole depths. Periodically check the hole depth to make sure that your stop has not shifted. We found that the coins fit loosely into the holes at this point but fit snugly due to swelling of the wood after the pieces are stained and finished.

### ASSEMBLE THE FRAME

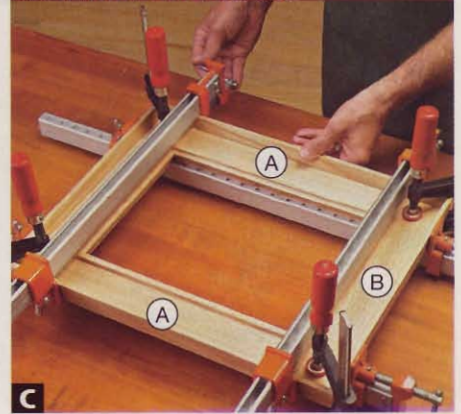

Glue, biscuit, and clamp the frame together, using bar clamps and small clamps at the corners to keep the faces flush. Verify square.

**3** Scrollsaw the stripes to shape [Photo G]. As you cut each stripe, mark the color (noted on the pattern) on the back. Remove the patterns using a cloth dampened with paint thinner to soften the adhesive.

**4** Hand-sand  $\frac{1}{16}$ " round-overs along the edges of all of the stripes on the top face and the inside ends of the top four stripes using 150-grit sandpaper. You don't need to sand the outside ends because the frame hides them.

### Color and finish the parts

**1** Finish-sand to 220 grit any areas that need it, and remove the dust.

**2** To protect the areas where you'll glue the  $\frac{3}{4}$ " wood stars to the flag backer (C/D) from stain, mask the areas with adhesive-backed  $\frac{1}{4}$ " round color-coding labels [Photo H], available at your local office-supply store.

**3** To easily stain and finish the stars and stripes, adhere them to pieces of

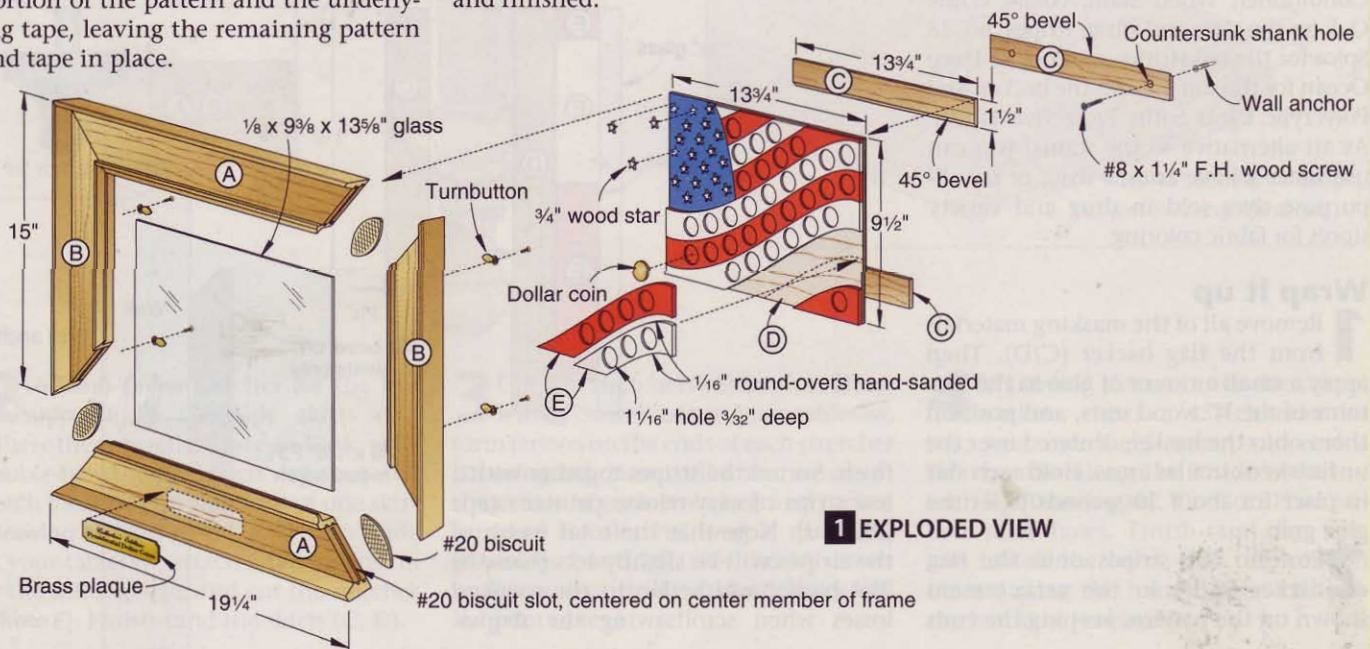

**1** EXPLODED VIEW

## APPLY THE STAR PATTERN



With spray adhesive applied to the 6x7" star portion of the flag pattern, align and press it onto the masked area of the flag backer (D).

## REMOVE THE STAR AREA

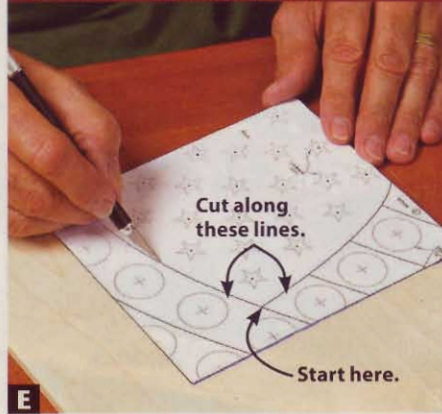

Cut out the star portion of the pattern along the inner curved lines, using a craft knife to slice through the pattern and tape below.

## BORE THE COIN HOLES

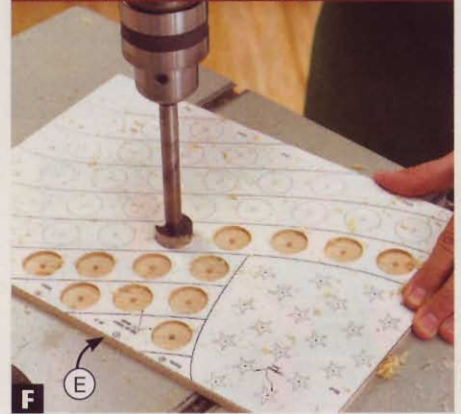

Bore the 1/16" holes 3/32" deep for the coins at the marked centerpoints on the pattern into the flag-stripes blank (E).

1/4" hardboard using double-faced tape. Apply a few strips of tape to one hardboard piece, and press the stars onto the tape. Then, apply a few small pieces of tape to the backs of the stripes, and press them onto the hardboard, placing the white stripes onto one piece and the red stripes onto another.

**4** Using 1" foam brushes, apply a coat of wood conditioner to the top faces and edges of the stars and stripes, including the coin holes, and to the area on the flag backer (C/D) for the stars. The conditioner helps avoid stain blotching and grain raising.

Next, apply the appropriate color stains (noted on the pattern) to the parts [Photo I]. Blend and wipe off any excess using a clean, dry cloth or foam brush. Then, apply two coats of a clear finish to the stars and stripes, the stained area on the backer, and the frame. We used these Minwax water-based products: Pre-Stain Wood Conditioner; Wood Stain, colors White Oak for the stars and white stripes, no. 13 Spice for the red stripes, and no. 43 Deep Ocean for the star area on the backer; and Polycrylic Clear Satin Protective Finish. As an alternative to the stains, you can use water-soluble aniline dyes, or try all-purpose dyes sold in drug and variety stores for fabric coloring.

## Wrap it up

**1** Remove all of the masking materials from the flag backer (C/D). Then apply a small amount of glue to the bottoms of the 3/4" wood stars, and position them onto the backer, centered over the unfinished circular areas. Hold each star in place for about 30 seconds to let the glue grab.

**2** Position the stripes onto the flag backer (C/D) in the arrangement shown on the pattern, keeping the ends

## 2 SIDE SECTION VIEWS

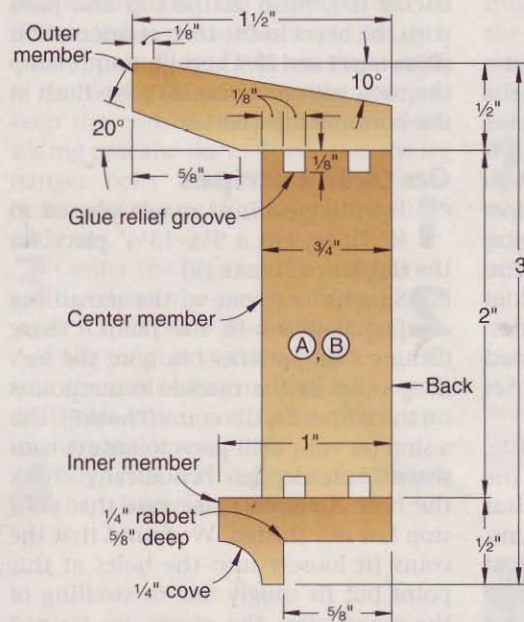

## 2a BEVEL-RIPPING THE FRAME OUTER MEMBER

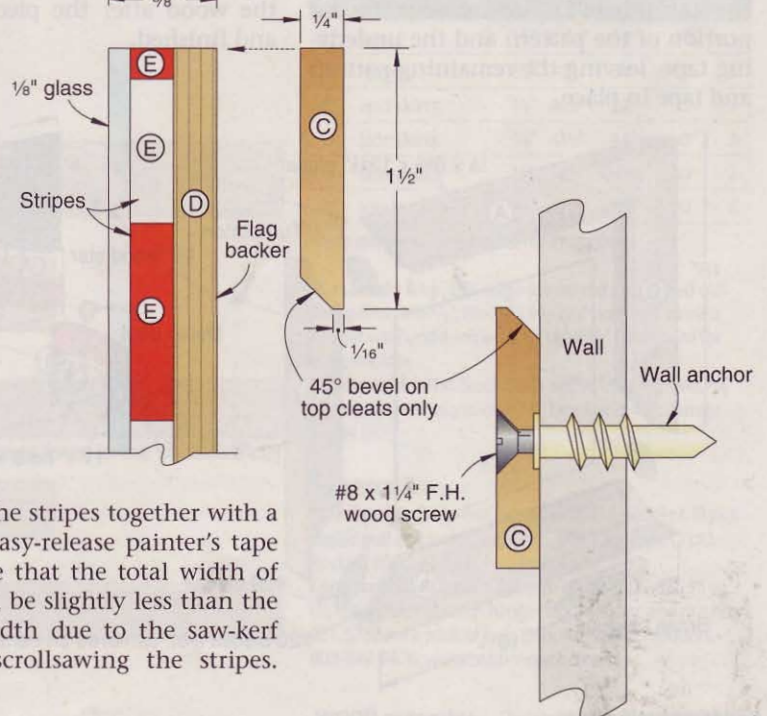
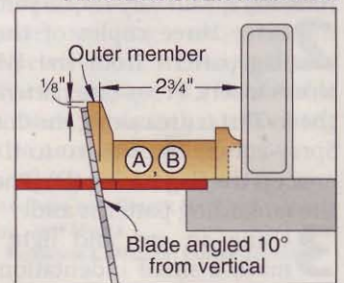

flush. Secure the stripes together with a few strips of easy-release painter's tape [Photo J]. Note that the total width of the stripes will be slightly less than the 9 1/2" backer width due to the saw-kerf losses when scrollsawing the stripes.

### CUT OUT THE STRIPES

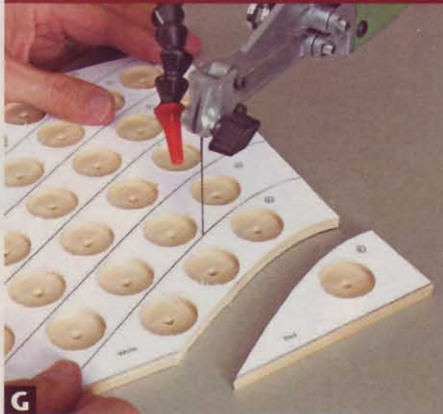

**G** Scroll saw the stripes to shape, cutting along the center of the pattern lines. For smooth cuts, use a #5 reverse-tooth blade.

Simply center the stripes top to bottom. The frame will hide the backer reveals.

**3** Carefully remove the taped stripes from the backer, and position them with the bottom face up. Apply and spread a small amount of glue to the stripes. Then reposition them onto the backer. Place a scrap piece of  $\frac{3}{4}$ " sheet material onto the stripes, and add weight (a gallon of stain or paint works well) on top of the piece to keep the stripes pressed tightly to the backer while the glue dries. Remove the weight and tape.

**4** To mount the "Collector's Edition" brass plaque (see **Source**), remove the protective strip from the adhesive on the back. Then, center and press the plaque into place on the front of the frame bottom (A) [Drawing 1].

**5** Insert your coins into the holes. If any coins have a loose fit, secure them with a small dab of clear silicone caulk applied to the coin.

### MASK FOR THE STARS



**H** Apply adhesive-backed  $\frac{1}{4}$ " round color-coding labels centered over the marked indentations for the stars in the backer (C/D).

**6** Have a piece of  $\frac{1}{8}$ " glass cut to  $9\frac{3}{8} \times 13\frac{5}{8}$ ". Position the frame with the back up. Place the glass and the flag assembly into the frame. Drill pilot holes, and mount four turnbuttons to the frame to secure the glass and flag [Drawing 1].

**7** Finally, level the remaining mounting cleat (C) bevel-side up on your wall. Drill  $\frac{5}{32}$ " countersunk shank holes through the cleat and into the wall. Then, screw-mount the cleat using  $\#8 \times 1\frac{1}{4}$ " flathead wood screws and suitable wall anchors. Position the coin flag on the wall, engaging the cleats. Now salute your fine handiwork, and keep your eyes open for new coins to add to your collection. 🌳

### ADD THE COLORS



**I** Stain the parts, brushing in the direction of the grain. Reapply the stains as needed to get uniform colors.

### TAPE THE STRIPES TOGETHER



**J** With the stripes tightly together and aligned with the edges of the flag backer (C/D), join the stripes together with masking tape.

## Materials List

Part	FINISHED SIZE			Matl.	Qty.
	T	W	L		
A* frame top/ bottom	1½"	3"	19¼"	LO	2
B* frame sides	1½"	3"	15"	LO	2
C mounting cleats	¼"	1½"	13¾"	O	3
D flag backer	¼"	9½"	13¾"	BP	1
E flag-stripes blank	¼"	9½"	13¾"	EM	1

\*Parts initially cut oversize. See the instructions.

**Materials key:** LO—laminated oak, O—oak, BP—Baltic birch plywood, EM—edge-joined maple.

**Supplies:** #20 biscuits (4); spray adhesive; easy-release painter's tape; adhesive-backed  $\frac{1}{4}$ " round color-coding labels; double-faced tape;  $\frac{3}{4}$ " wood stars (20), available at your local crafts supply store; clear silicone caulk;  $\frac{1}{8} \times 9\frac{3}{8} \times 13\frac{5}{8}$ " glass; turnbuttons (4);  $\#8 \times 1\frac{1}{4}$ " flathead wood screws (2); wall anchors (2).

**Blades and Bits:** Dado-blade set,  $\frac{1}{4}$ " cove router bit,  $1\frac{1}{16}$ " Forstner bit, #5 reverse-tooth scrollsaw blade.

### Source

**Plaque:**  $1\frac{1}{2} \times 5$ " brass-finish plaque. Send \$5.00 and a self-addressed, stamped business-size envelope to: WOOD magazine Presidential Coin Flag, 1716 Locust St., LS-221, Des Moines, IA 50309-3023.

## SCHEDULED RELEASE OF PRESIDENTIAL \$1 COINS

### 2007

GEORGE WASHINGTON	1789–1797
JOHN ADAMS	1797–1801
THOMAS JEFFERSON	1801–1809
JAMES MADISON	1809–1817

### 2008

JAMES MONROE	1817–1825
JOHN QUINCY ADAMS	1825–1829
ANDREW JACKSON	1829–1837
MARTIN VAN BUREN	1837–1841

### 2009

WILLIAM HENRY HARRISON	1841
JOHN TYLER	1841–1845
JAMES K. POLK	1845–1849
ZACHARY TAYLOR	1849–1850

### 2010

MILLARD FILLMORE	1850–1853
FRANKLIN PIERCE	1853–1857
JAMES BUCHANAN	1857–1861
ABRAHAM LINCOLN	1861–1865

### 2011

ANDREW JOHNSON	1865–1869
ULYSSES S. GRANT	1869–1877
RUTHERFORD B. HAYES	1877–1881
JAMES A. GARFIELD	1881

### 2012

CHESTER A. ARTHUR	1881–1885
GROVER CLEVELAND	1885–1889
BENJAMIN HARRISON	1889–1893
GROVER CLEVELAND	1893–1897

### 2013

WILLIAM MCKINLEY	1897–1901
THEODORE ROOSEVELT	1901–1909
WILLIAM HOWARD TAFT	1909–1913
WOODROW WILSON	1913–1921

### 2014

WARREN G. HARDING	1921–1923
CALVIN COOLIDGE	1923–1929
HERBERT HOOVER	1929–1933
FRANKLIN D. ROOSEVELT	1933–1945

### 2015

HARRY S. TRUMAN	1945–1953
DWIGHT D. EISENHOWER	1953–1961
JOHN F. KENNEDY	1961–1963
LYNDON B. JOHNSON	1963–1969

### 2016

RICHARD M. NIXON	1969–1974
GERALD R. FORD	1974–1977

Written by **Owen Duvall** with **Chuck Hedlund**

Project design: **Jeff Mertz** Illustrations: **Roxanne LeMoine; Lorna Johnson**

# Hot New Tools for 2008

**WOOD®** magazine editors traveled the globe this past year looking for new tools, accessories, and supplies designed to make the most of your time in the shop. Here's the best of what we found.

## ADD THIS MINI DUST COLLECTOR TO ALMOST ANY TOOL

In Steel City's Mini Dust Collector (model 65115), you get a 300-cfm-rated blower with filter bag that mounts directly onto any 4" dust port. Even if you already have a central system, you can use the Mini to boost the dust-collection proficiency of tools farthest from your main collector.

**Price: \$100**  
Steel City Tool Works  
877-724-8665; [steelcitytoolworks.com](http://steelcitytoolworks.com)

## DUST COLLECTION FOR DOVETAILERS

Routing dovetails is one of the messiest jobs in woodworking: We've never found an effective way to capture the mess. Now, Rockler and Leigh have cleaned up the act with accessories for their dovetail jigs that contain the flying debris. Rockler's brushy dust hood, *below left*, keeps chips in check while allowing the bit to pass through harmlessly; Leigh's VRS (Vacuum and Router Support), *below right*, "follows" your router along the jig while also providing more bearing surface for the router base.

**Price: \$40, Dovetail Dust Collector #22224**  
Rockler  
800-279-4441; [rockler.com](http://rockler.com)

**Price: \$65-\$80, Leigh VRS**  
Leigh Industries  
800-663-8932; [leighjigs.com](http://leighjigs.com)

## SETSCREWS WON'T VEX THIS RATCHETING HEX WRENCH

Ever had to adjust a setscrew in a spot with limited clearance? You know, the kind where you get only about a quarter-turn before you have to pull the wrench out? The Ratcheting Hex Wrench works just like a socket wrench, so once you fit the wrench into the setscrew, you don't have to pull it out until you're done. English wrenches range from 5/64" to 1/4"; metric from 1.5 to 6mm.

**Price: \$17**  
Professional Tool Manufacturing  
800-597-6170; [ratchetinghexwrench.com](http://ratchetinghexwrench.com)





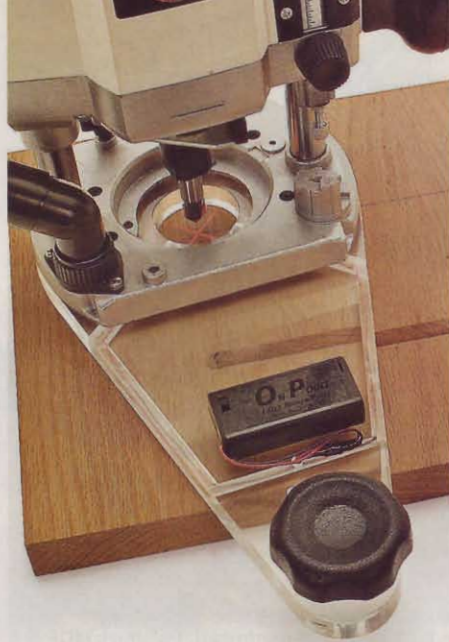

### LASER-RED "X" MARKS THE SPOT WITH THIS ROUTER SUBBASE

MLCS's On Point Laser Guided Router Base shines a laser crosshair to show the exact center of the bit. That's handy when freehand-routing or setting up field cuts, such as fluting. Plus, its oblong shape and outboard handle make it more stable for edge-routing. For cuts not requiring the laser, switch on the bright-white LED worklights; combined with the clear subbase, they provide great bit visibility. On Point comes predrilled to fit many popular midsize and 3-hp routers, but can be drilled to fit any.

**Price: \$60, #9098**

MLCS

800-533-9298; mlcswoodworking.com



### COMPUTER-CONTROLLED ROUTING COMES TO SMALL SHOPS

Large-scale professional woodworking shops often use CNC (computer numerically controlled) equipment for precisely cutting, routing, and drilling pieces—think of it as high-tech template-routing. Now, CNC-toolmaker ShopBot has downsized that technology to fit into a garage or basement shop. Requiring a working footprint smaller than a sheet of plywood, the PRTstandard BenchTop can automatically cut, rout, carve, and drill project parts up to 24x32" in a fraction of the time it would take to do them by hand.

**Price: \$3,995, not including spindle. Add \$365 for 3-hp router package, or \$1,195 for 2-hp 230V spindle package.**

ShopBot Tools

919-680-4800; shopbottools.com



### DIGITAL MITER GAUGE AT AN UNBELIEVABLY LOW PRICE

Last year, the digital-readout ProMiter-100 miter gauge was named one of our Hot New Tools for 2007, despite its \$400 price. Well, here's sticker shock of a different kind: Craftsman's Digital Miter Gauge uses the same brain as the ProMiter to measure miter angles with 0.1° accuracy, and it sells for only \$70. That's especially remarkable when you consider that you could spend three times that for other miter gauges with confusing, nondigital, 0.1° vernier scales.

**Price: \$70, #29939**

Craftsman

800-383-4814; craftsman.com

### IF YOU HAVE TOO MUCH ROOM IN YOUR SHOP, SKIP THESE ITEMS

Wouldn't the world be a better place if you could face-joint material as wide as you can thickness-plane? Space-starved woodworkers in Europe have long used jointer/planer combination machines, and now you can afford one too, thanks to two new 12"-capacity machines from Grizzly and Jet. Both combo machines have jointer beds that tip out of the way, revealing a planer bed that must be raised about 8" to plane 3/4"-thick stock. They take up about as much floor space as a 15" planer, require 220-volt electrical service, and cost hundreds less than similar European-made combination machines.



Jet's 3-hp combination jointer/planer makes the transformation from jointer to planer 5–10 seconds quicker than the Grizzly. You simply tip up the entire jointer bed, secure the dust hood, and raise the planer bed. It features straight knives and weighs 529 lbs—about 150 lbs less than the Griz.

**Price: \$2,000, stock no. 708475**

WMH Tool Group

800-274-6848; jettools.com



Grizzly's G0634 sports a spiral cutterhead with indexed solid-carbide insert cutters that give you four fresh edges for long life. (It's also available with a conventional straight-knife cutterhead, model G0633, for \$500 in savings.) This 5-hp machine needs a 30-amp circuit, and converts to a planer in five steps: Remove the guard, remove the fence, tip up each table, swing the dust-collection hood into place, and raise the planer bed. Total changeover time: about 40 seconds.

**Price: G0633, \$1,795; G0634, \$2,295**

Grizzly Industrial

800-523-4777; grizzly.com

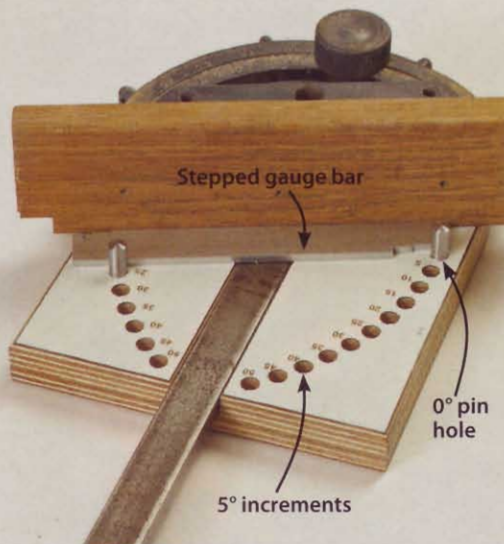

### \$30 ADDS POSITIVE, RELIABLE ½° "STOPS" TO ANY MITER GAUGE

No need to upgrade your miter gauge to make it one of the most accurate tools in your shop. Simply set the one you have using MiterSet. For precise angles in 5° increments, insert the locating pins at "0" and the desired angle, drop your gauge into the slot, and press its face against the pins. To set your gauge to one of those ½° angles in between, place the stepped gauge bar (with ½° steps on each end) between the pins and your miter gauge's face to add or subtract up to 2½°.

**Price: \$30**  
MiterSet  
209-835-1626; miterset.com



### CREATE NO-CLAMP JOINTS WITH YOUR BISCUIT JOINER

In a move that may challenge our love of pocket-screw joinery, Lamello introduces a new method of clamp-free joinery with Fixo biscuits. To use them, you simply hold the joint together face-down, and cut a biscuit slot or two across the joint. Apply glue to the workpieces—not the biscuit slot—and then drive the ribbed half-biscuits into the slots. The curved ribs actually draw the joint together, while small barbs keeps Fixo from falling out.

**Price: \$28.50 for 80 Fixos**  
Colonial Saw  
888-777-2729; csaw.com

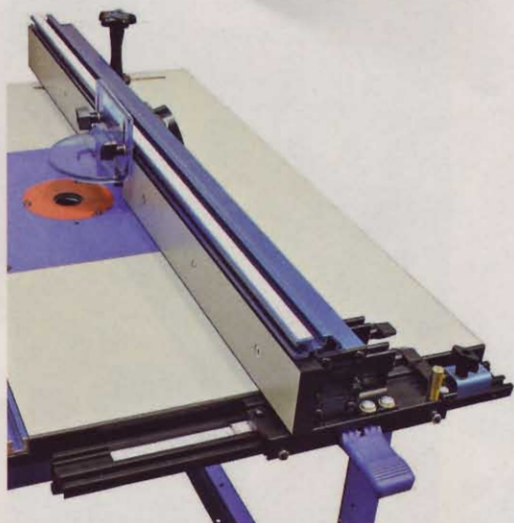

### A RUGGED ROUTER TABLE WITH THE FINESSE OF A SURGEON

Built of heavy-gauge steel with a height-adjustable, steel-reinforced, 1½"-thick MDF top, Kreg's Precision Router Table is one of the beefiest we've seen. But don't confuse beefy with clumsy: Its T-square-style fence (think Biesemeyer) microadjusts for precise positioning. The dual miter slot accepts standard-size miter bars, with an adjacent T-slot for mounting accessories, such as feather boards. Wanna add a router lift? The 9¼×11¾" insert opening readily accepts the most popular lifts.

**Price: \$500, PRS1040**  
Kreg Tool  
800-447-8638; kregtool.com

### PARALLEL-JAW CLAMPS THAT REALLY CRANK UP THE PRESSURE

Most parallel-jaw clamps provide more than enough pressure for wood joinery. But if you suffer from limited hand strength, or need extra clamping pressure to pull together a cold-bent lamination, for example, you'll appreciate the bonus cranking power of Woodline USA's Parallel Clamp System. It tightens by turning an inline handle as with typical parallel clamps, and then the handle pivots 90° (as shown at right) to provide lots of leverage for final torquing.

**Price: \$26-\$45 (15-78" capacity)**  
Woodline USA  
800-472-6950; woodline.com

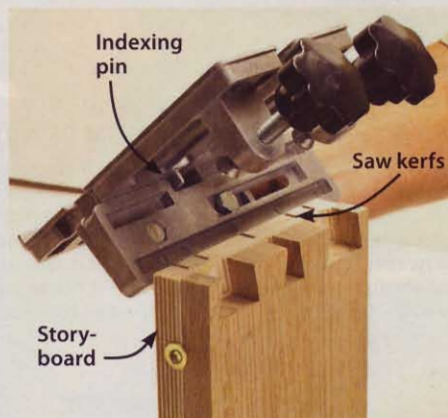
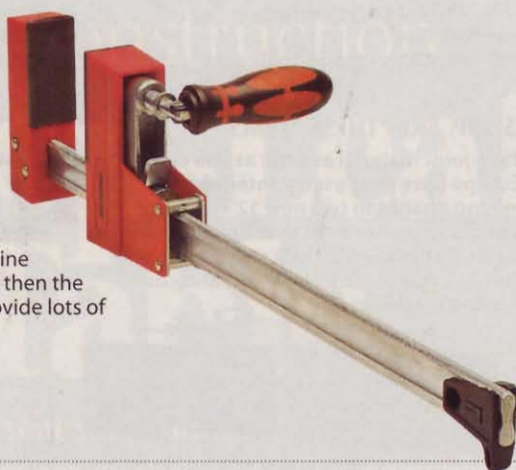

### DOVETAILS OF YOUR DESIGN WITH ABSOLUTE REPEATABILITY

The Chest Mate dovetail jig helps you create dovetails on boards of any width and space them exactly how you want them. That's because you fix the spacing by making a story-board with saw kerfs centered wherever you want a dovetail. Insert Chest Mate's indexing pin into the kerf and clamp both to your workpiece; then rout a tail. (You provide your own router bits and guide bushing.) Now, move the jig to the next kerf, and repeat. With the tails all cut, adjust the jig for the pin cut, clamp the same story-board to the mating workpiece, and rout all your pins. (See a video demo at [woodmagazine.com/videos](http://woodmagazine.com/videos).) It's the ultimate variability at an affordable price.

**Price: \$100**  
Prazi USA  
800-262-0211; praziusa.com

### FINALLY! FUZZ-FREE PROFILES FROM A ROUTER BIT

Until now, you could plan to spend a little extra time hand-sanding away the fuzzy edges left behind by edge-forming bits on cross-grain cuts. But Freud's line of Quadra-Cut bits has four cutters instead of the typical two: The larger pair routs most of the profile with an up-shear angle; the second, smaller pair cuts cleanly with a down-shear to eliminate fuzzing.

**Price: about 10 percent more than comparable two-wing bits**

Freud  
800-334-4107;  
freudtools.com



**Drop-Leaf Table,  
Page 58**

Join pattern  
(Section 2) here.

TABLE LEG  
PATTERN  
(Section 3)

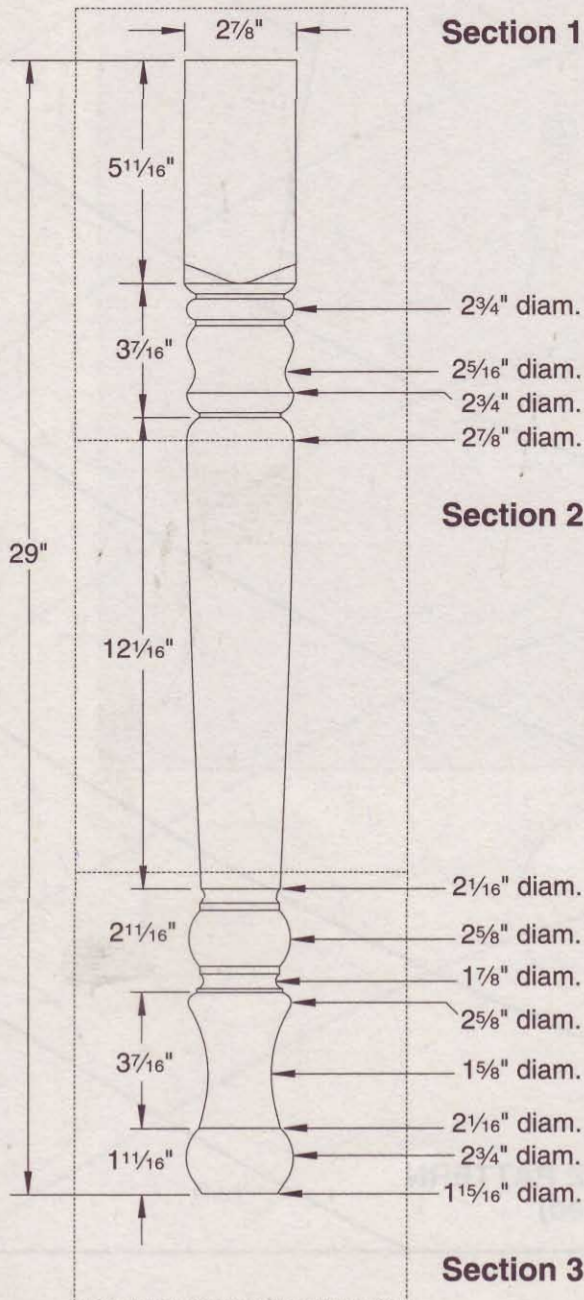

**Section 1**

**Section 2**

**Section 3**

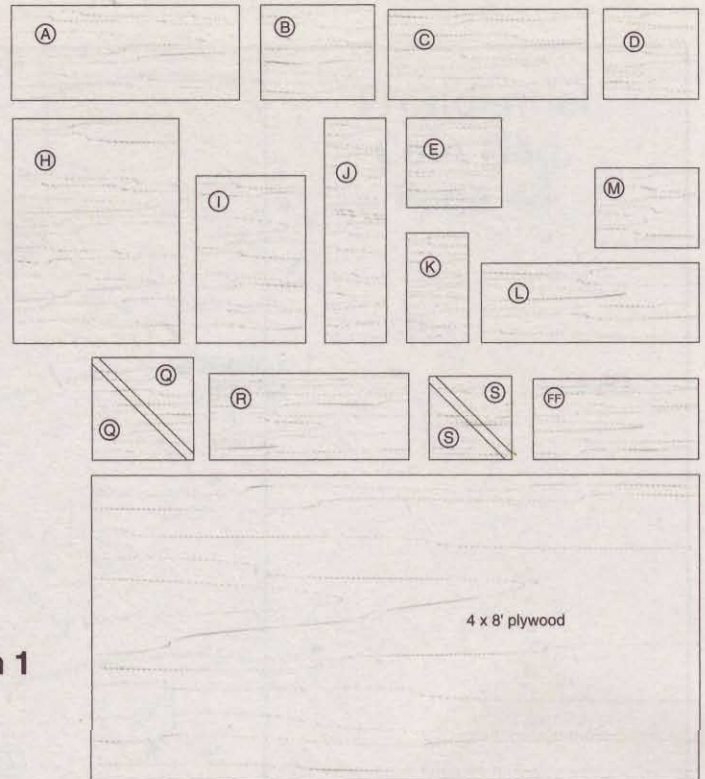

**Modular Cabinets  
Cutting Diagram,  
Page 32**

Better Homes and Gardens®

**WOOD  
PATTERNS®**

December/January 2007/2008

Issue 181

Dear Reader: As a service to you, we've included full-size patterns on this insert for irregular shaped and intricate project parts. You can machine all other project parts using the Materials List and the drawings accompanying the project you're building.

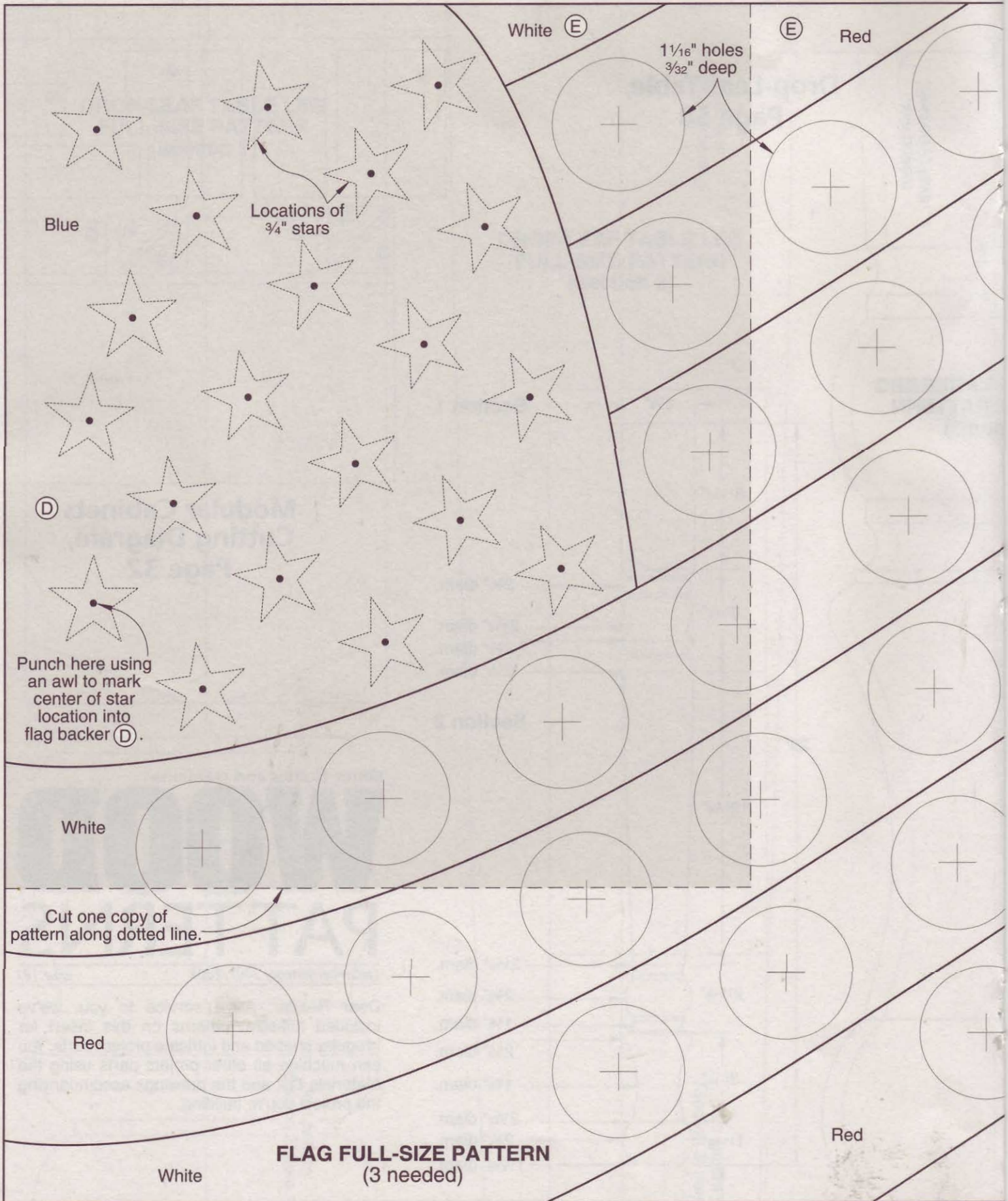

# Presidential Coin Flag, Page 46

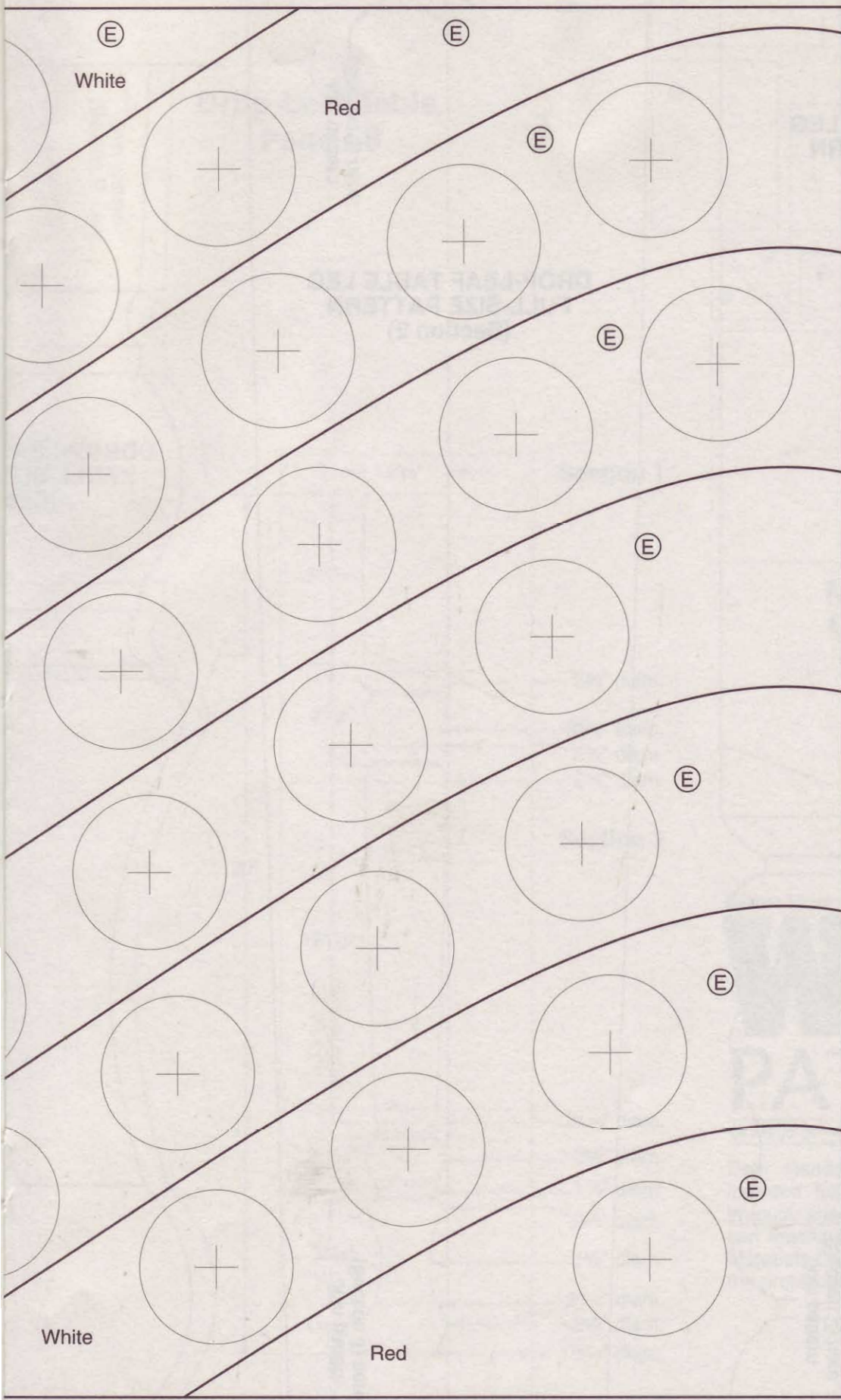

©Copyright Meredith Corporation, 2007/2008. All rights reserved. Printed in the U.S.A. Meredith Corp., the publisher of WOOD Patterns®, allows the purchaser of this pattern insert to photocopy these patterns solely for personal use. Any other reproduction of these patterns is strictly prohibited.

**DROP-LEAF TABLE LEG  
FULL-SIZE PATTERN  
(Section 1)**

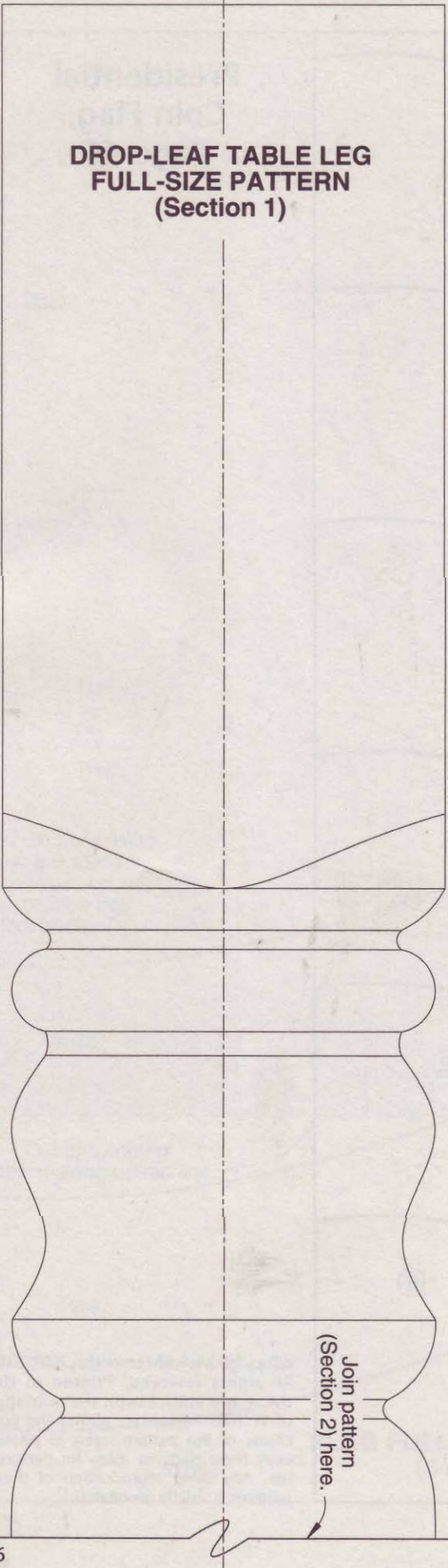

**DROP-LEAF TABLE LEG  
FULL-SIZE PATTERN  
(Section 2)**

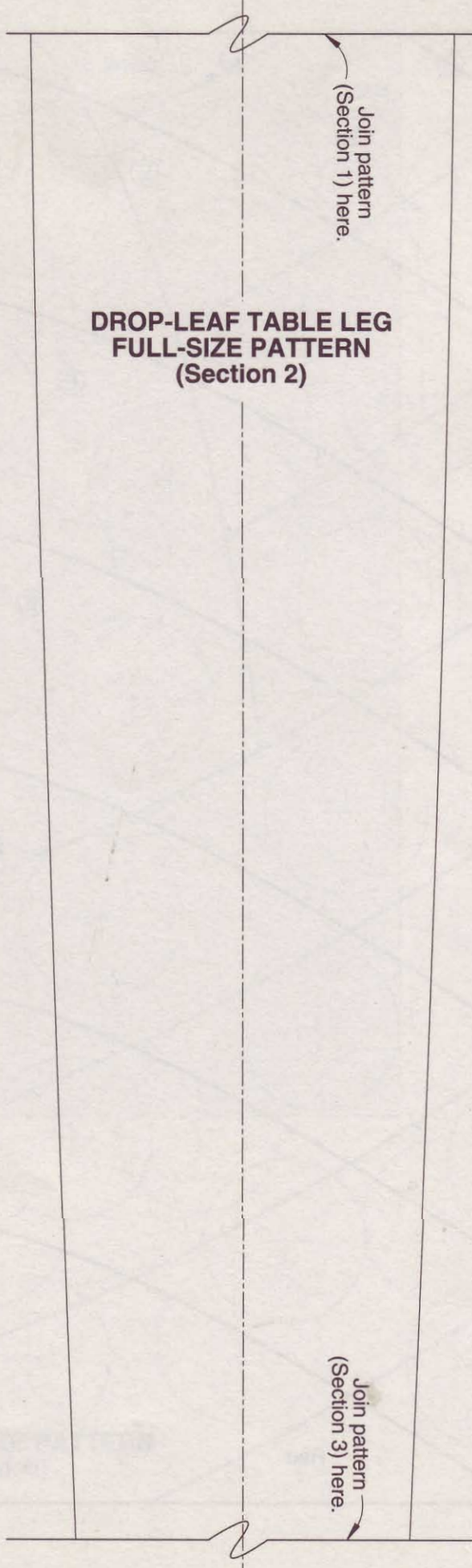

**DROP-LEAF  
FULL-SIZE  
(Sec**

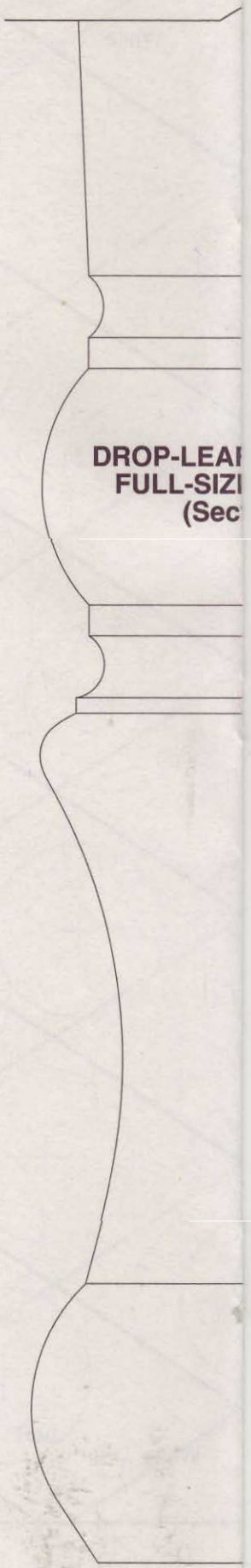

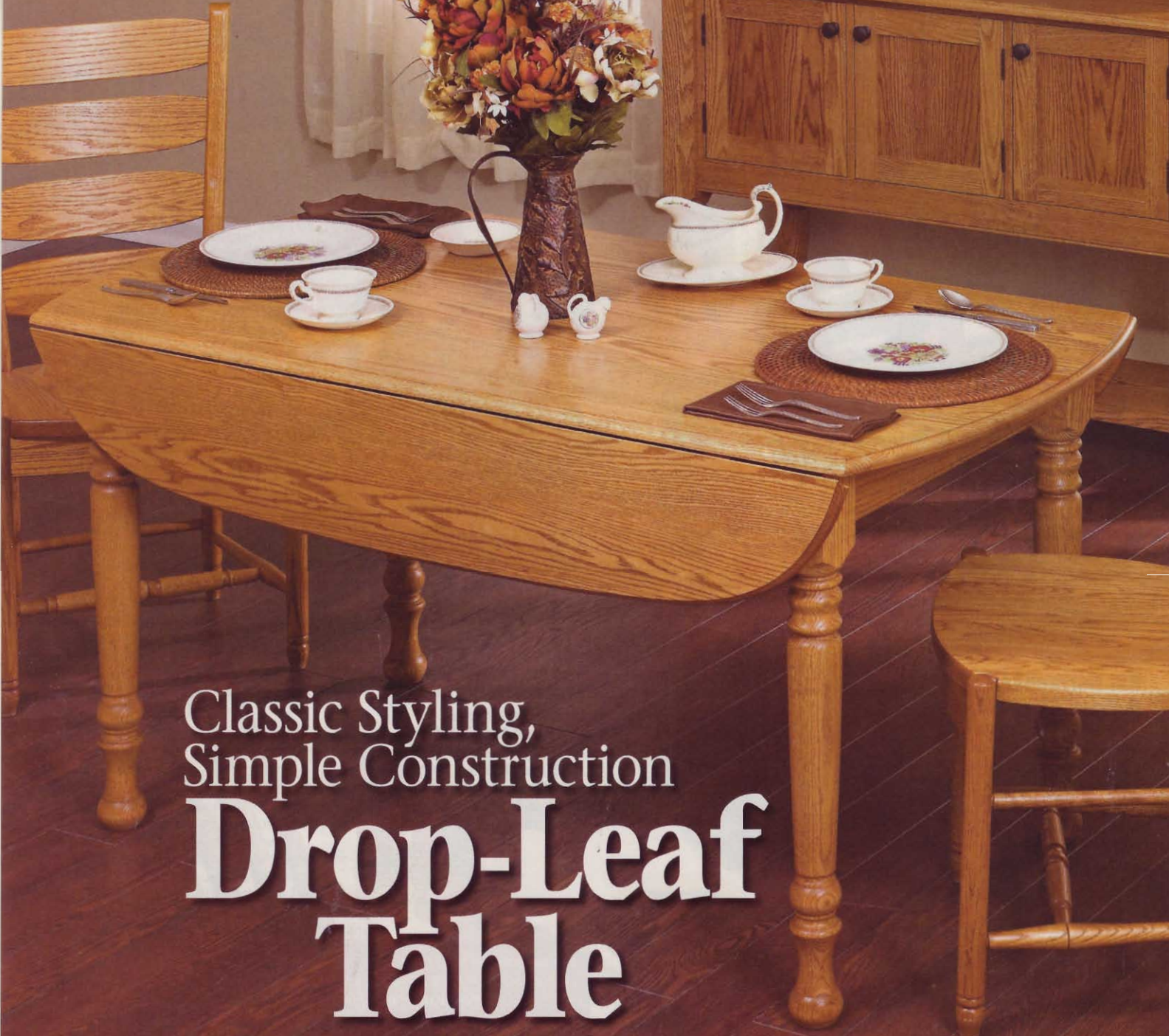

Classic Styling,  
Simple Construction  
**Drop-Leaf  
Table**

Big enough to seat six or small enough for two, this table expands to fill a dining room or shrinks to fit a cozy breakfast nook.



See a Slide Show of this project coming together at [woodmagazine.com/slides](http://woodmagazine.com/slides).



Build the matching **Hutch** for your table, coming up in our **next issue**, March 2008!



## PROJECT HIGHLIGHTS

- Overall dimensions: leaves up, 48" wide × 60" long × 29<sup>7</sup>/<sub>8</sub>" high; leaves down, 31<sup>1</sup>/<sub>4</sub>" wide.
- Purchased legs, corner brackets, and leaf supports make this an easy-to-build project. (See **Sources** for these items.)
- For those who wish to turn the legs, see the full-size pattern on the *WOOD PATTERNS*® insert.

### Skill Builders

- Learn how to rout a rule joint.
- Discover how to lay out the drop-leaf curves at [woodmagazine.com/irrcurves](http://woodmagazine.com/irrcurves).
- See how a filled-pore finish will give you a smoother tabletop.

## Start with the tabletop

**1** Edge-glue oversize blanks for the top (A) and leaves (B) [**Materials List**, page 62]. Finish-sand the blanks. Then chuck a straight bit into your handheld router, and using a straightedge, true the edges of the top to the finished width. Now joint the edges of the leaves that mate with the top. To form a rule joint along the mating edges of the top and leaves, see page 22.

**2** With the rule joints routed, lay the top (A) blank facedown, and mark a centerline across the width. Working from this centerline, lay out the hinge centerlines [**Drawing 1**]. Then mark the centerlines and ends of the hinge-barrel grooves [**Drawing 1a**]. Rout <sup>3</sup>/<sub>16</sub>"-deep round-bottom grooves at each hinge location [**Photo A**]. Now position the leaves alongside the top, and using a self-centering bit to drill pilot holes, mount the hinges [**Photo B**].

## ROUT HINGE-BARREL GROOVES, AND INSTALL THE HINGES

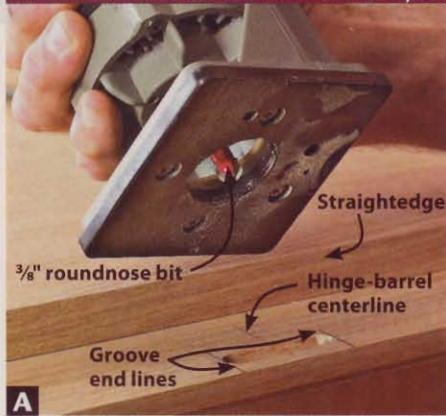

**A** Position a straightedge to center a <sup>3</sup>/<sub>8</sub>" roundnose bit on the hinge-barrel centerline, and rout a <sup>3</sup>/<sub>16</sub>"-deep groove for each hinge.

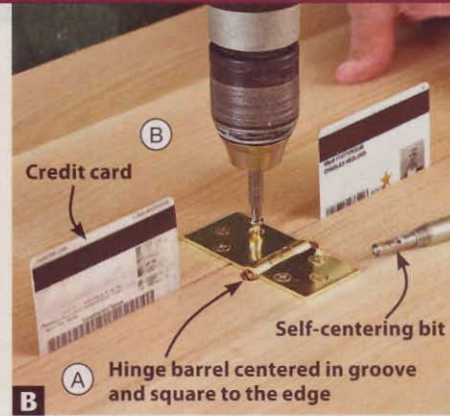

**B** Insert credit cards <sup>1</sup>/<sub>8</sub>" into the rule joint to separate the top (A) and leaf (B), drill pilot holes, and install the hinges.

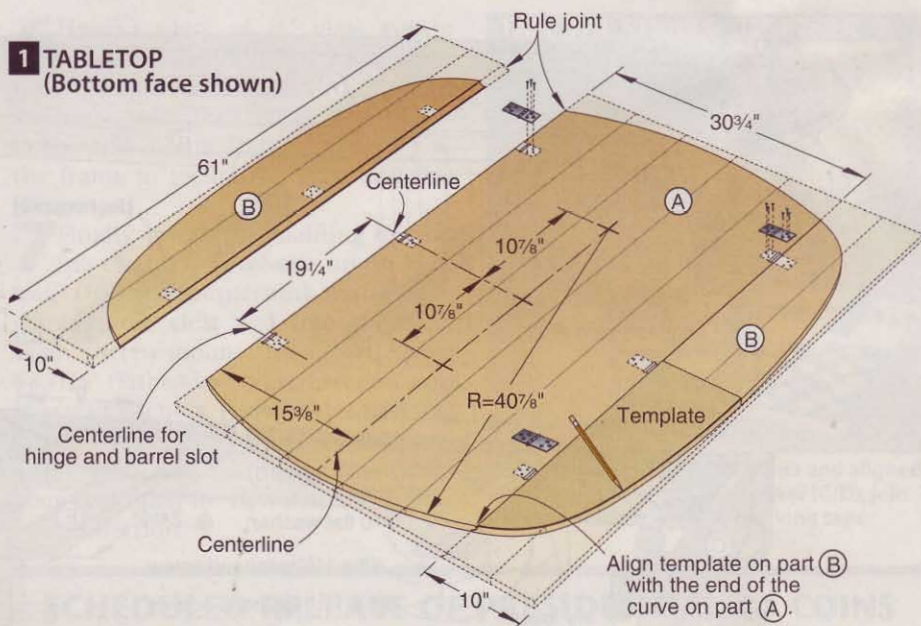

## SHOP TIP

### To prevent chip-out, fill the rule-joint gap

When routing the shouldered round-over along the edge of the tabletop (A/B), the small gaps (about <sup>1</sup>/<sub>2</sub>" ) between the top (A) and leaves (B) present possibilities for chip-out. To avoid this, cut a 1"-wide strip of cardboard about 8" long, and adhere double-faced tape to one face. Then, with the leaves down, adhere short pieces of cardboard to the top (A) part of the rule joints at the four places where the joints intersect the edge, as shown *below left*. Then with the leaves supported in the up position, trim the cardboard flush with the top and end surfaces, as shown *below right*. Now you can rout the edge profile without fear of chip-out.

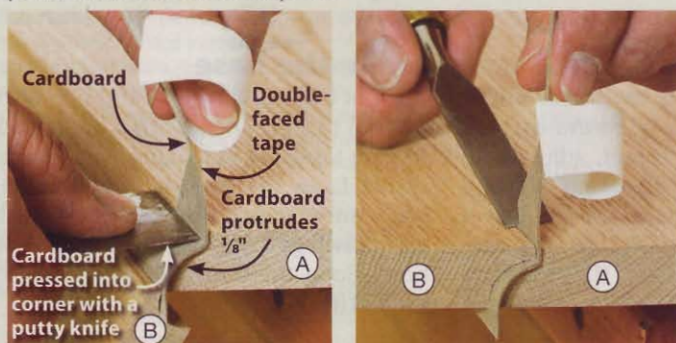

### 1a HINGE-BARREL GROOVE

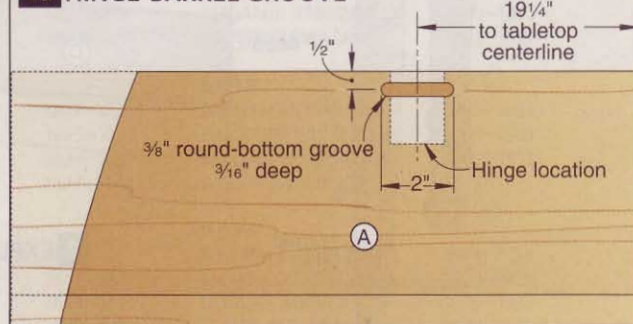

### 1b LEAF HALF-TEMPLATE (Bottom face)

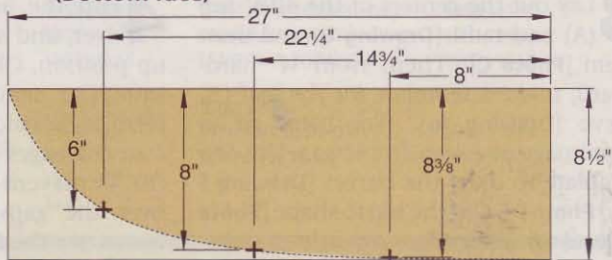



## LAY OUT AND CUT THE TABLETOP CURVES

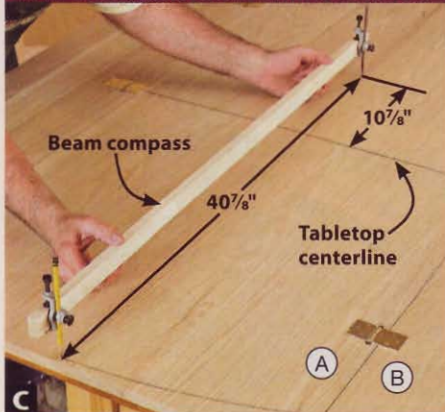

Lay out the centers of the top (A) end radii from the tabletop centerline, and use a beam compass to draw the curves.

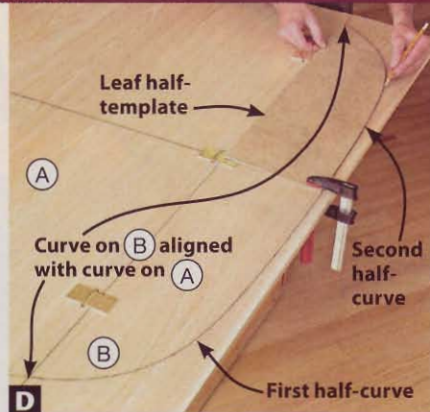

Align the template with the top (A) end curve, and draw half the leaf (B) curve. Flip the template, and complete the curve.

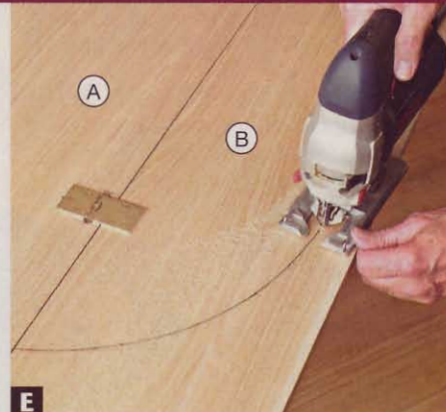

With the top (A) end curves and the leaf (B) side curves drawn, cut the tabletop to shape with a jigsaw.

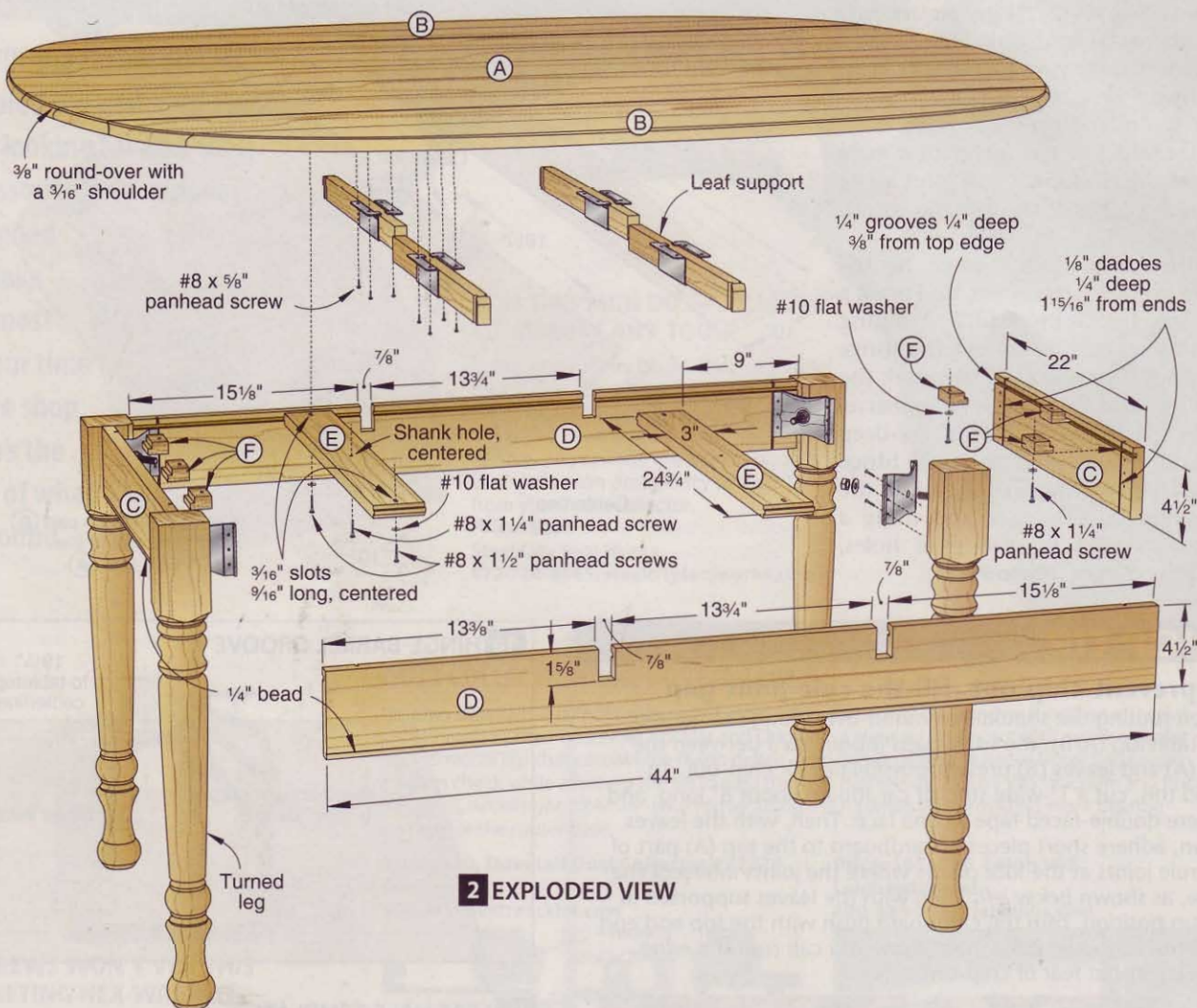

**2** EXPLODED VIEW

**3** Lay out the centers of the 40 7/8" top (A) end radii [Drawing 1], and draw them [Photo C]. Then, from 1/4" hardboard, make a template for the leaf (B) curve [Drawing 1b]. (For help, go to [woodmagazine.com/irrcurves](http://woodmagazine.com/irrcurves).) Use the template to draw the curves [Drawing 1 and Photo D]. Cut the top to shape [Photo E], and sand the edges smooth.

**4** Flip the assembled tabletop (A/B) over, and support the leaves in the up position. Chuck a 3/8" round-over bit into your handheld router, adjust it to form a 3/16" shoulder [Drawing 2a], and rout the edges of the top (A) and leaves (B). To prevent chip-out as the bit passes over the gaps between the top and leaves, see the **Shop Tip** on page 59.

## Make the base

**1** Cut the end skirts (C) and side skirts (D) to size. Then, with a dado blade in your tablesaw, cut 1/4" grooves into the inside faces of the skirts [Drawing 2]. Next cut 1/8" dadoes for the corner brackets [Drawings 2 and 2b]. Now rout a 1/4" bead along the outside bottom edge of each skirt [Drawing 2c].

## INSTALL THE LEAF SUPPORTS

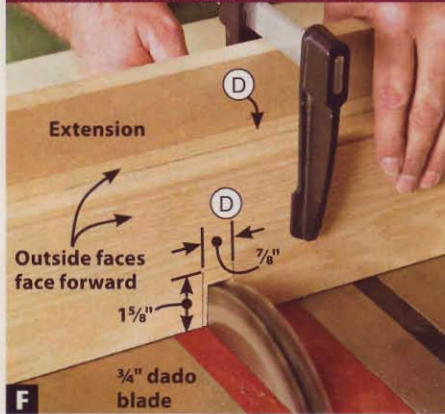

**F** Using a tall miter-gauge extension to support the side skirts (D) and back the cuts, cut the leaf-support notches in two passes.

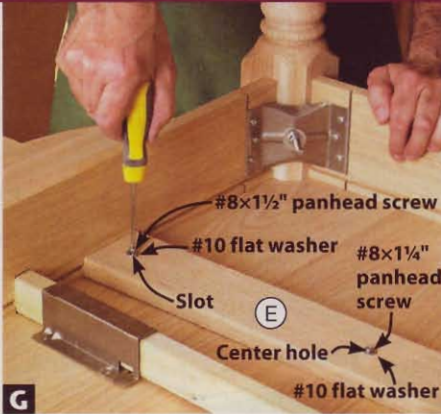

**G** After using the stretcher (E) center hole and slot centers as guides to drill pilot holes, fasten them with washers and screws.

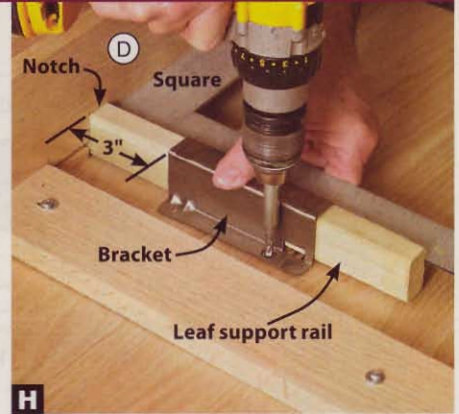

**H** Center the leaf support rail in the side skirt (D) notch, and square the support bracket to the skirt. Drill pilot holes, and drive the screws.

## 2b CORNER BRACKET

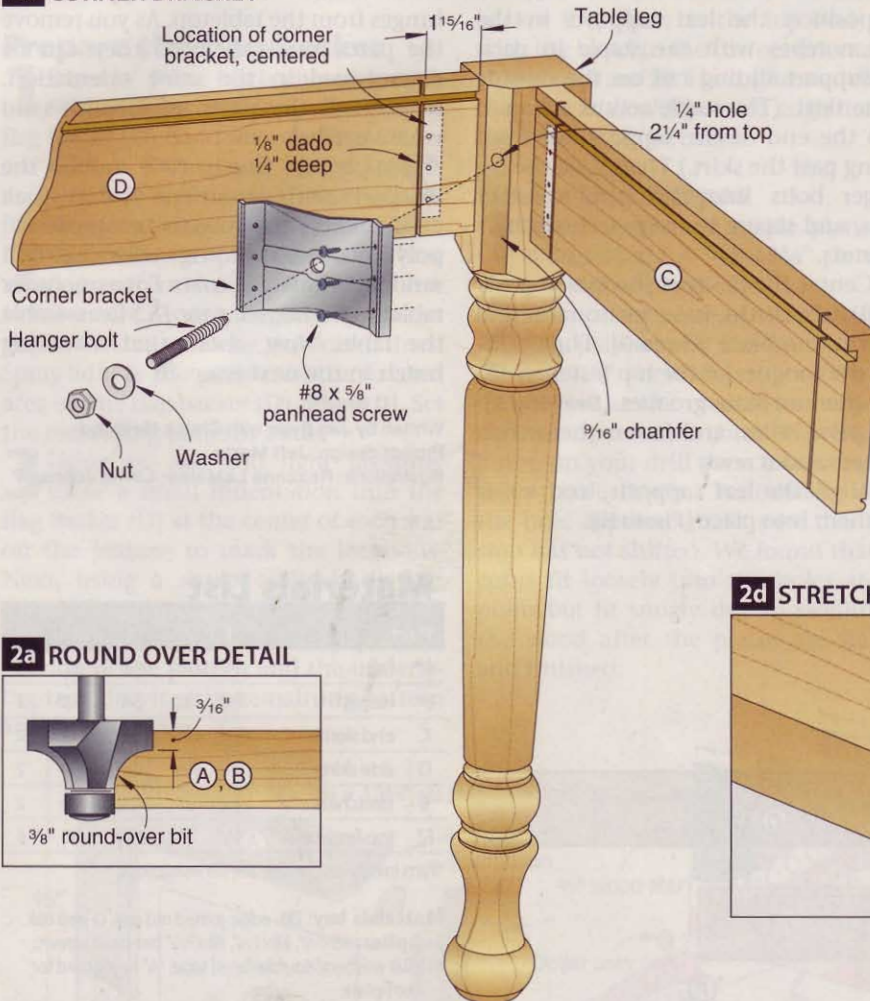

## 2a ROUND OVER DETAIL

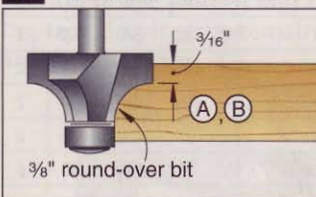

## 2c ROUTING THE BEADS

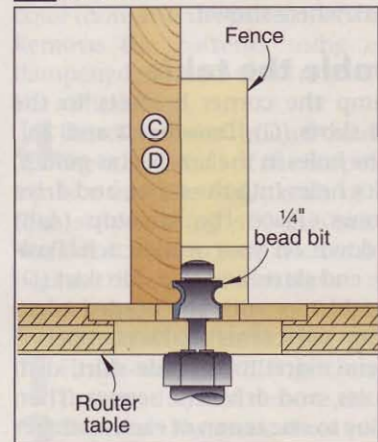

## 2d STRETCHER TENONS

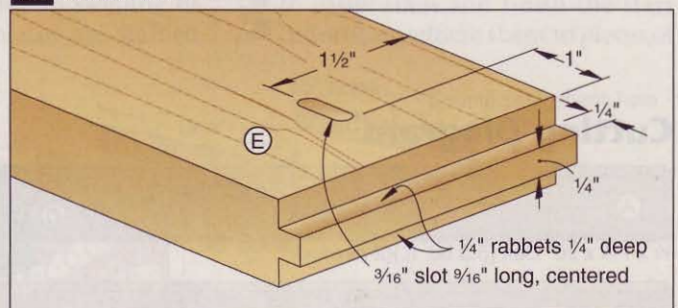

**2** To form offset notches for the leaf supports in the side skirts (D), adhere them together, face-to-back, with double-faced tape. Then lay out the notch locations on the front of one skirt [Drawing 2]. Now install a  $\frac{3}{4}$ " dado blade in your tablesaw, attach a tall extension to the miter gauge, and cut the notches [Photo F]. Finish-sand the skirts (C, D).

**3** Cut the stretchers (E) to size. Then, with a dado blade in your tablesaw, form tenons on the ends of each stretcher [Drawing 2d]. Now drill a shank hole at the center of each stretcher, and form a centered  $\frac{3}{16}$ " slot  $\frac{9}{16}$ " long at each end [Drawings 2 and 2d]. (For the #8 screws in this project, drill  $\frac{5}{32}$ " shank holes and  $\frac{7}{64}$ " pilot holes.)

**4** To provide clearance for the corner brackets, chuck a 45° chamfer bit into your handheld router, and rout a  $\frac{9}{16}$ " chamfer along the inside corner of each leg [Drawing 2b]. Then drill hanger-bolt pilot holes. Finish-sand the legs, and install the bolts. (For information on installing the hanger bolts and corner brackets, see page 84.)

### 3 TABLETOP FASTENERS

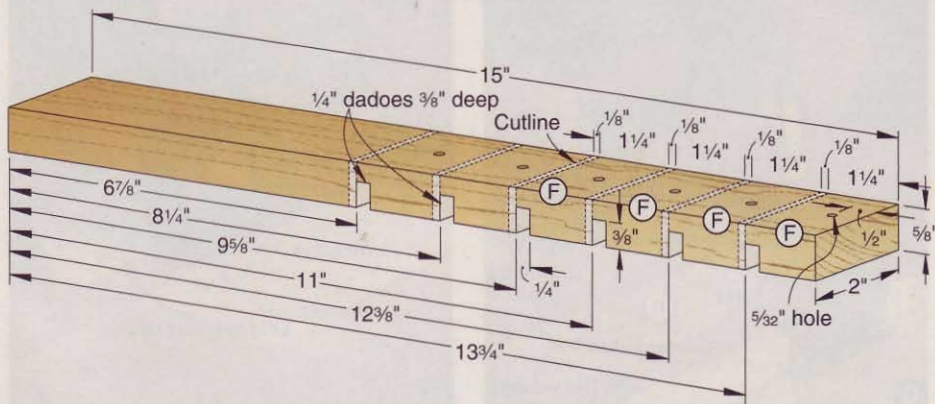

**5** Cut a  $\frac{3}{4} \times 2 \times 15$ " blank for the top fasteners (F), and plane it to  $\frac{5}{8}$ " thick. Cut six dados into the blank with a dado blade [Drawing 3]. Then drill the  $\frac{5}{32}$ " holes. Now cut the fasteners from the blank where shown.

### Assemble the table

**1** Clamp the corner brackets to the end skirts (C) [Drawings 2 and 2b]. Using the holes in the brackets as guides, drill pilot holes into the skirts, and drive the screws. Place the tabletop (A/B) upside down on your workbench. Position the end skirts and one side skirt (D) on the tabletop, with the beaded edges up. Clamp the corner brackets attached to the end skirts to the side skirt, drill pilot holes, and drive the screws. Then apply glue to one tenon of each stretcher (E). Insert these ends into the groove in the side skirt [Drawing 2]. Apply glue to the other stretcher tenons. Now, captur-

ing the tenons with the second side-skirt groove, clamp the skirt to the corner brackets attached to the end skirts. Drill pilot holes, and drive the screws.

**2** Lift the skirt assembly (C/D/E), and position the leaf supports in the skirt notches with the staple in each leaf-support sliding rail on the outside of the skirt. (The staple acts as a stop to keep the end of the support rail from sliding past the skirt.) Then slide the leg hanger bolts into the corner-bracket holes, and secure the legs with washers and nuts.

**3** Center the base on the tabletop (A/B), check the base for square, and screw it into place [Photo G]. Then position the tongues of the top fasteners (F) into the end-skirt grooves [Drawing 2], drill pilot holes, and fasten them with washers and screws.

**4** Align the leaf supports, and screw them into place [Photo H].

Find more furniture plans at [woodmagazine.com/furniture](http://woodmagazine.com/furniture).



### Apply the finish

**1** Remove the legs from the skirt assembly (C/D/E), and then the skirt assembly from the tabletop (A/B). Next remove the leaf supports and hinges from the tabletop. As you remove the parts, mark them so they can be reassembled in the same orientation. Inspect all the parts, and finish-sand where needed.

**2** Apply the finish. (We stained the parts with Varathane Golden Oak #227, and then applied two coats of satin polyurethane, sanding with 220-grit sandpaper between coats. For a smoother tabletop finish, see page 18.) Reassemble the table. Now, about that matching hutch in the next issue. 🌲

Written by Jan Svec with Chuck Hedlund  
Project design: Jeff Mertz  
Illustrations: Roxanne LeMoine; Lorna Johnson

### Cutting Diagram

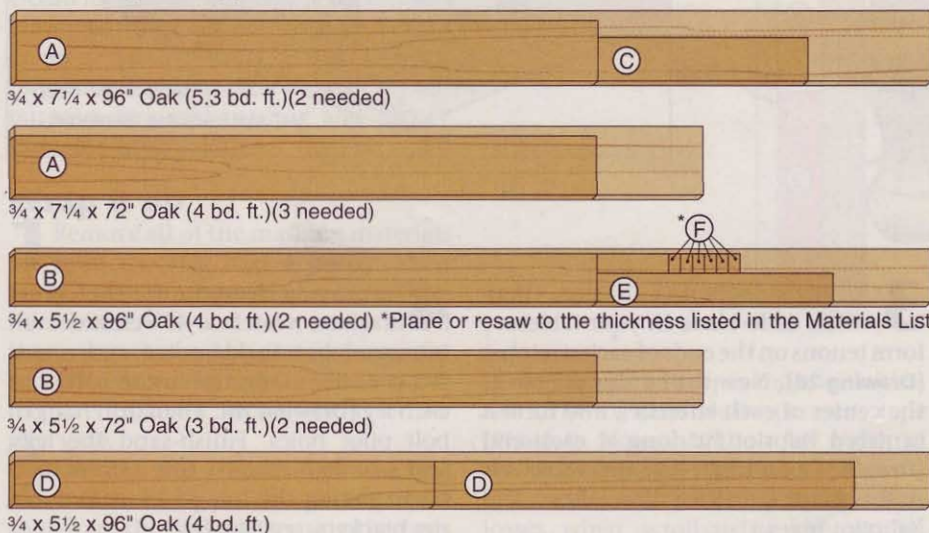

### Materials List

Part	FINISHED SIZE			Matl.	Qty.
	T	W	L		
A* top	$\frac{3}{4}$ "	30 $\frac{3}{4}$ "	60"	EO	1
B* leaves	$\frac{3}{4}$ "	9"	54"	EO	2
C end skirts	$\frac{3}{4}$ "	4 $\frac{1}{2}$ "	22"	O	2
D side skirts	$\frac{3}{4}$ "	4 $\frac{1}{2}$ "	44"	O	2
E stretchers	$\frac{3}{4}$ "	3"	24 $\frac{3}{4}$ "	O	2
F* top fasteners	$\frac{5}{8}$ "	2"	1 $\frac{1}{4}$ "	O	6

\*Parts initially cut oversize. See the instructions.

**Materials key:** EO—edge-joined red oak, O—red oak.

**Supplies:** #8 $\times\frac{5}{8}$ ", #8 $\times\frac{1}{4}$ ", #8 $\times\frac{1}{2}$ " panhead screws; #10 flat washers; double-faced tape;  $\frac{1}{4}$ " hardboard for leaf template.

**Blade and bits:** Stack dado set;  $\frac{1}{2}$ " rule joint set,  $\frac{3}{8}$ " roundnose,  $\frac{3}{8}$ " round-over,  $\frac{1}{4}$ " bead, and 45° chamfer router bits.

### Sources

**Hardware:** Drop-leaf hinge no. 29256, \$6.39 pr. (3 pr.); classic pull-out leaf support no. 29512, \$5.49 pr. (2 pr.). Rockler, 800-279-4441, rockler.com.

**Legs and brackets:** Oak farm leg no. 1020, \$26.95 ea. (4); corner bracket with hanger bolt, washer, and nut no. 901, \$7.65 for a pack of four. Osborne Wood Products, 800-849-8876, www.osbornewood.com.

# Wood Joint

## TORTURE TEST 2

### Doors & Drawers

Need a frame joint that doesn't break when kids mistake your cabinet door for playground equipment? Or a drawer joint that can survive tugs and slams without coming apart? We tested 72 samples to discover the best of both.

**A** year ago, we brutally tested various dado, rabbet, mortise-and-tenon, butt, and miter joints to learn which were strongest. (See *WOOD*® magazine issue 173, November 2006, page 58.) Now, to uncover the toughest common door and drawer joints, we made dozens of test samples and pushed them to their breaking point—literally.

For door joints, we made six samples each of cope-and-stick, stub-tenon-and-groove, half-lap, and haunched-tenon joints. Then we made test samples of lock-rabbet, box, through-dovetail, half-blind dovetail, lock-miter, sliding-dovetail, shouldered-dado, and rabbeted drawer joints. All were built using lumber of similar density and the same yellow glue for consistency. Door-joint samples used  $\frac{3}{4}$ " x 2" red oak and, except where noted, the drawer box samples were built from  $\frac{1}{2}$ " x 4" poplar.

Using testing equipment at Iowa State University, we tore apart each joint one of two ways. The first measured a joint's resistance to being pulled apart, as when yanking open a drawer or pulling a sliding frame-and-panel door sideways. The other, a shear test, measured a joint's ability to withstand being pushed out of square until its glue joint failed. (Picture a child hanging from an open cabinet door, or a wide dresser drawer binding as it's yanked open.)



Watch FREE video of the latest round of joint tests at [woodmagazine.com/jointtest2](http://woodmagazine.com/jointtest2).

When the cracking and tearing were over, we discovered that all of the joints withstood far more of the pull-apart force they'd encounter regularly than shearing force, which is uncommon. For example, the average drawer joint held up to 1,489 lbs of pull-apart force versus only 80 lbs of shearing force. The average door joint withstood 1,214 lbs of pull-apart force but only 511 lbs of shearing force. To see how the joints in each category compared with each other, check the charts on pages 66 and 69.

After analyzing piles of shattered joints, we learned a few things that you can apply in your own shop to make stronger joints.

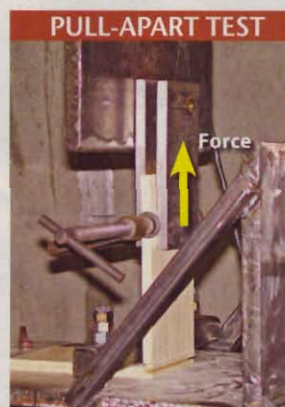

With the drawer front clamped to the testing jig and the drawer side bolted to the testing equipment's upper jaws, we lowered the jig to pull apart the joint.



The stile of a door frame is clamped to the testing jig's side. A steel plate held by the testing machine forces the door rail down as the jig rises until the joint breaks.

# DOOR JOINTS

## #1 Half-lap

■ **FINDING:** In shear-strength tests, half-lap joints withstood more than twice the force of the next strongest joint. **LESSON:** A large face-to-face glue area gives this joint its incredible strength. Choose it for mirror frames or heavy doors likely to endure abuse.

**PULL-APART STRENGTH: 1,918 LBS**



■ **FINDING:** In pull-apart tests, more than half of the glue joint survived even as the stile piece split. **LESSON:** Here's a joint that can support weighty inserts such as stained-glass.

■ **FINDING:** Where the glue bond did break in shear tests, we could see dado-blade score marks. **LESSON:** Sand laps

**SHEAR STRENGTH: 1,073 LBS**



smooth for a stronger glue bond.

■ **FINDING:** Despite being a basic, easy-to-make joint, half-laps outlasted the more elaborate alternatives such as cope-and-stick joints.

**LESSON:** More work won't result in more strength.

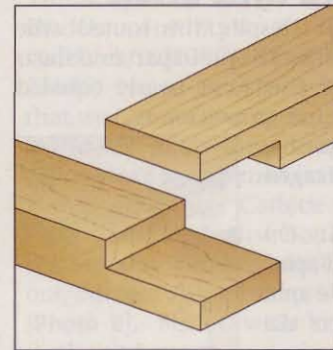

## #2 Mortise-and-haunched-tenon

■ **FINDING:** On each pull-apart test, the mortised stile split along its length before the joint cracked at the tenon shoulders. **LESSON:** The tenon's face-grain-to-face-grain glue bond adds strength, but less than a half-lap.

■ **FINDING:** In pull-apart tests, the stile of each sample split at the base of the mortise. **LESSON:** Longer tenons reduce

the possibility of wood splits and strengthen the joint, reinforcing the same finding from last year's tests.

■ **FINDING:** In all tests, none of the tenons broke or even showed signs of cracking. **LESSON:** The tried-and-true rule of making tenons one-third the thickness of the workpieces still provides plenty of strength along the tenon.

■ **FINDING:** On some shear-test samples, the tenon pried loose the wood between the mortise and the stile end

(see below), but not before splitting the stile along its length. **LESSON:** Use this joint where durability matters. The tenon's glue strength more than offsets this weak spot in the joint.

■ **FINDING:** One weak spot occurs where the end of the tenon doesn't touch the bottom of the mortise.

**LESSON:** Gaps meant to collect excess glue weaken the joint. Aim for wood-to-wood contact, and don't overapply glue.

**PULL-APART STRENGTH: 1,533 LBS**



**SHEAR STRENGTH: 482 LBS**

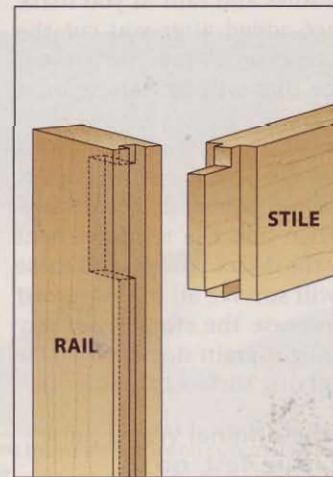

### #3 Stub-tenon-and-groove

■ **FINDING:** Like the mortise-and-haunched-tenon joints, the stile split at the bottom of the groove during the pull-apart tests. In all tests, the 3/8"-long tenons held onto the surrounding wood.

■ **LESSON:** Because these tenons don't extend deeper than the groove, be sure to strengthen the joint by thoroughly gluing the tenon shoulders and ends.

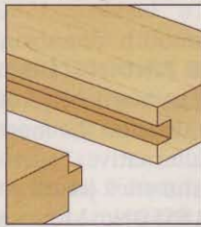

**PULL-APART STRENGTH: 727 LBS**

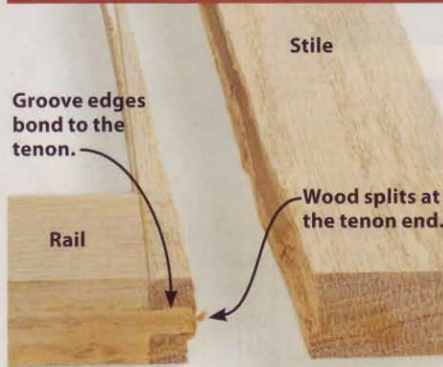

■ **FINDING:** The ends of the tenons pulled fibers loose from the stile pieces.  
 ■ **LESSON:** Glue does a poor job of filling

**SHEAR STRENGTH: 226 LBS**

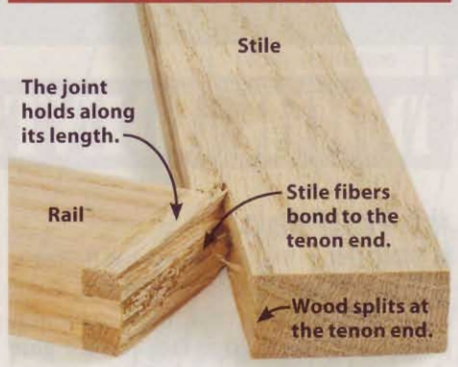

gaps. A tenon fitted to precise length increases joint strength and improves the frame's appearance.

### #4 Cope-and-stick

■ **FINDING:** Despite the routed stile and rail profiles, the pull-apart and shear strengths of this joint nearly equaled stub-tenon-and-groove joints.

■ **LESSON:** A profile will not weaken the joint.

■ **FINDING:** On each pull-apart test, the stile split at the base of the rail tenon.

■ **LESSON:** The joint at *near right* broke in an area of curved grain. For strong frames,

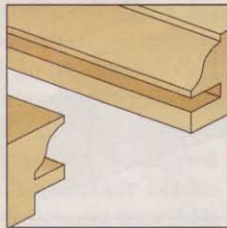

**PULL-APART STRENGTH: 677 LBS**



begin with straight-grain stock.  
 ■ **FINDING:** Even with this amount of end-grain-to-edge-grain gluing surface,

**SHEAR STRENGTH: 262 LBS**



the joint outlasted the wood.  
 ■ **LESSON:** This joint is more than adequate for frame-and-panel construction.

## CONCLUSIONS

It's no coincidence that the two strongest joints are the ones with the most face-grain-to-face-grain glue surface area. Choose half-laps for frames holding thick glass or mirrors, especially if the frame's width exceeds its height. Mortise-and-haunched-tenons handle the same jobs, and have grooves already cut into the stiles and rails as you make the joint, not added after you cut the joint. Use these on doors you'll open frequently or that will face abuse on a daily basis.

But don't give up on stub-tenon-and-groove or cope-and-stick joints. Multiply their strength by four on an actual cabinet door—then add the reinforcement provided by the door's panel—and these two joints will survive all but the worst abuse. To increase the strength of any joint, use straight-grain stock, and make certain the gluing surfaces are smooth.

To read the original Wood Joint Torture Test, go to [woodmagazine.com/jointtest](http://woodmagazine.com/jointtest).

## Half-laps lead in door-joint strength

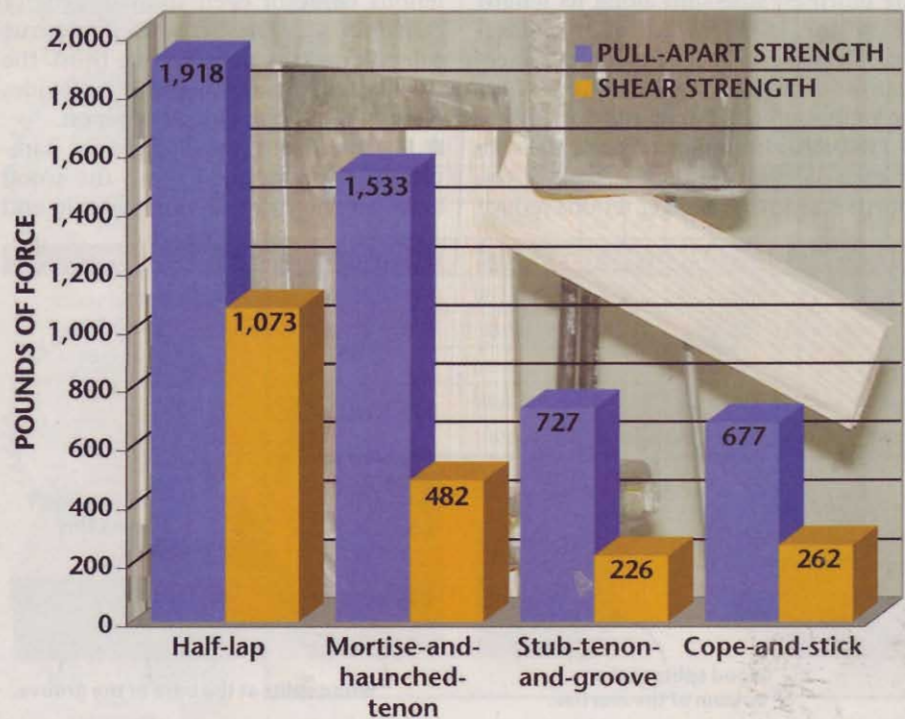

# DRAWER JOINTS

## #1 Box joint

■ **FINDING:** Glue bonds were strong enough to tear off wood fibers and parts of the fingers on both pieces in the pull-apart tests. End-grain-to-face-grain glue bonds also pulled off corners of fingers.

■ **LESSON:** This joint in 1/2" stock creates 3 3/4 square inches of gluing surface, about half of that in edge-grain-to-edge-grain connections.

Use box joints on your projects where pull-apart strength matters most, such as utility drawers made to hold heavy objects.

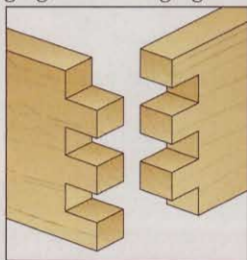

**PULL-APART STRENGTH: 2,019 LBS**

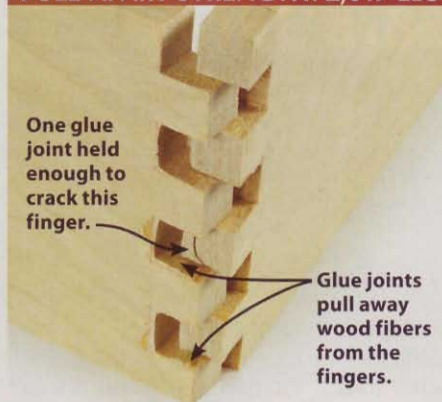

■ **FINDING:** Although strong against pull-apart forces, the joint's shear strength was only 4 percent of its pull-

**SHEAR STRENGTH: 84 LBS**

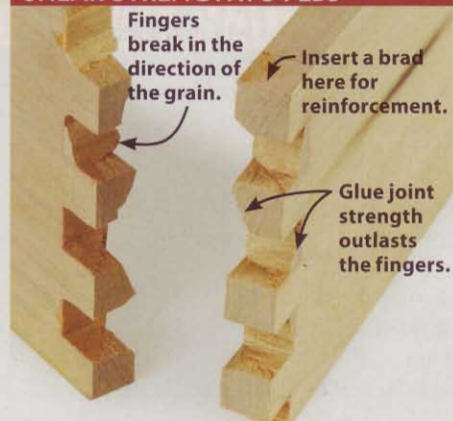

apart strength. ■ **LESSON:** Consider reinforcing this joint with #18x1" brads in the edges of the end fingers.

## #2 Lock miter

■ **FINDING:** On all joint samples, the tapered tenon on one piece remained bonded with its mating dado. This joint's face-grain-to-face-grain glue area contributes to its strength.

■ **LESSON:** This joint combines strength with an attractive mitered outside corner.

■ **FINDING:** The mitered

portions of the outside and inside corners contributed little strength to the joint. ■ **LESSON:** Choose a bit profile that minimizes these portions of the joint.

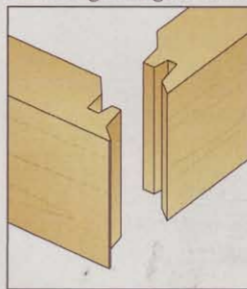

**PULL-APART STRENGTH: 1,899 LBS**

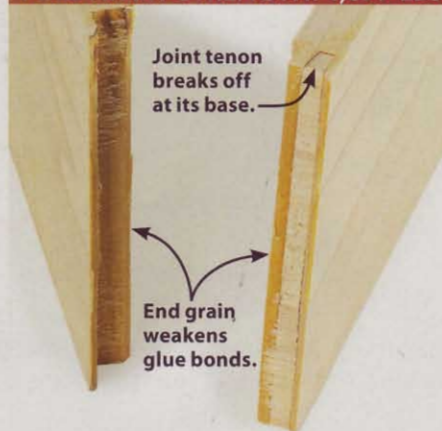

■ **FINDING:** Each joint in both types of tests failed when the tenon broke off at its base. ■ **LESSON:** Because these router

**SHEAR STRENGTH: 141 LBS**

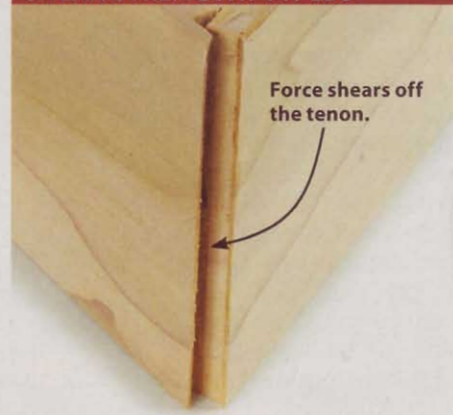

bits cut tenons wider at their bases than at their tips, the joint proves stronger than the lock rabbet.

## #3 Lock rabbet

■ **FINDING:** Despite having all end-grain-to-face-grain glue-joint areas, lock-rabbet glue bonds still outlasted the surrounding wood. Joints failed when the ends of the mortised pieces cracked from edge to edge.

■ **LESSON:** When using a lock-rabbet joint to connect a

drawer back to the sides, increase its strength by positioning mortises away from the drawer side ends.

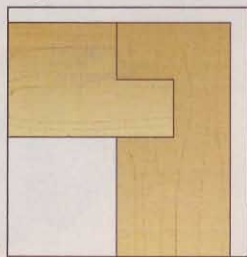

**PULL-APART STRENGTH: 1,505 LBS**

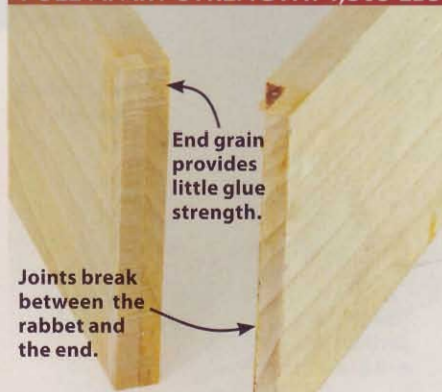

■ **FINDING:** Joint areas burned during milling showed no attached fibers after the joint was broken. ■ **LESSON:** Burned

**SHEAR STRENGTH: 94 LBS**

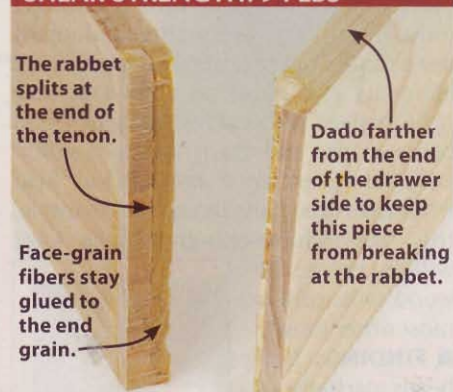

joints won't absorb glue well. Use a slow bit speed to rout this joint, and sand off any burn marks left by a tablesaw.

## #4 Through-dovetail

■ **FINDING:** On the pull-apart tests, end grain on the pin pieces pulled off almost no dovetail face-grain fibers.

■ **LESSON:** Thoroughly glue both the pin and dovetail sides where there's stronger face-grain-to-face-grain contact.

■ **FINDING:** Despite careful gluing, portions of some pins lacked dried glue along their edges.

■ **LESSON:** Apply glue to both pieces to avoid forcing out too much glue during assembly.

■ **FINDING:** Even after the glue bonds cracked at

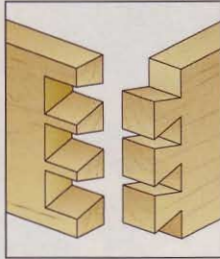

**PULL-APART STRENGTH: 1,457 LBS**

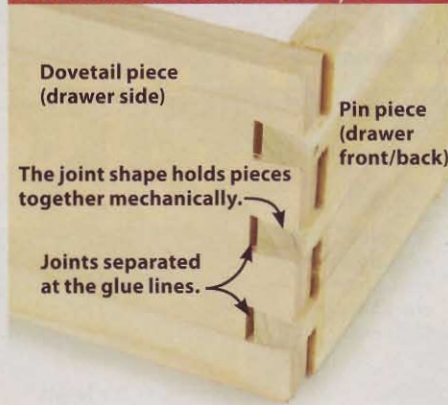

their peak strength, the pieces mechanically locked together. ■ **LESSON:** Unlike other joints, a failed glue bond doesn't

**SHEAR STRENGTH: 37 LBS**

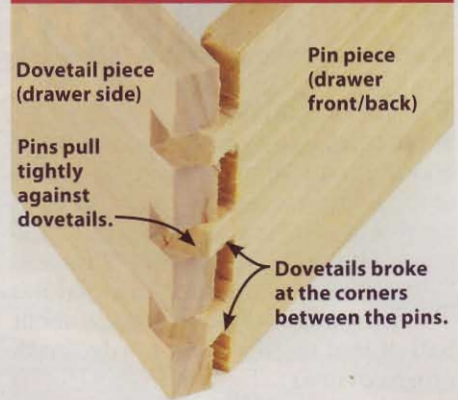

equal total joint failure when you use pin pieces on the drawer front and back with dovetailed sides.

## #5 Sliding dovetail

■ **FINDING:** All samples in both series of tests failed when the 1/8"-long strip of wood between the dovetail groove and the end of that board broke off.

■ **LESSON:** Consider this joint for drawers where the dovetail piece can be mounted farther from the end of the slot piece.

■ **FINDING:** In both the pull-apart and the shear-strength tests, this joint was weaker than the similar lock-rabbit joint that can be cut with just a tablesaw.

■ **LESSON:** Consider

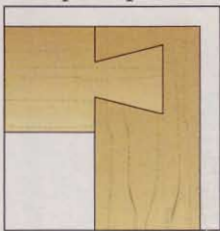

**PULL-APART STRENGTH: 1,410 LBS**

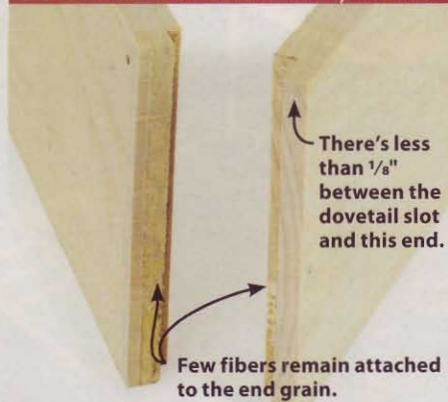

that the pieces have to slide together, making it difficult to insert a floating

**SHEAR STRENGTH: 69 LBS**



drawer bottom, and you may find you're better off with lock-rabbit joints.

## #6 Rabbet with nails

■ **FINDING:** Despite not having any finely machined parts, as on lock miters or sliding dovetails, the thickness of the pieces didn't translate into a stronger joint. In only one of the three pull-apart test samples did the rabbeted piece crack along its end grain, as shown at *near right*, instead of breaking the glue bond between the end grain and face grain.

■ **LESSON:** Even with mechanical help from the three nails in each test sample, this face-grain-to-end-grain glue joint will fail before the wood fails, unlike most other joints.

■ **FINDING:** Nail heads partially or completely pulled through the rabbeted piece in the

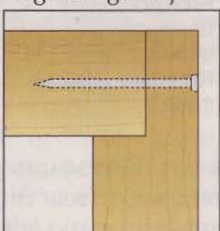

**PULL-APART STRENGTH: 1,329 LBS**

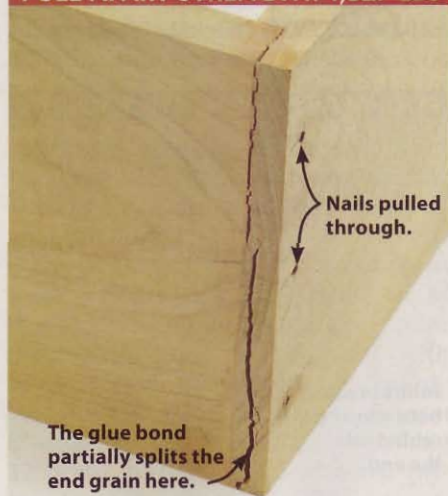

pull-apart tests; only two nails pulled through in the shear-strength test samples. ■ **LESSON:** Nails may help hold a

**SHEAR STRENGTH: 73 LBS**

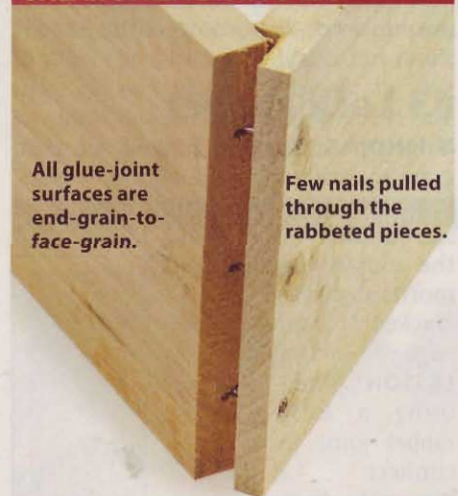

joint together during glue-up, but don't rely on them to compensate for a weak glue joint.



## #7 Shouldered dado

■ **FINDING:** The  $\frac{5}{32}$ "-long strip between the end of the dadoed piece and the dado weakens this joint. **LESSON:** Use it for drawers where the dado can be placed away from the end of the side piece.

■ **FINDING:** Tenons were just  $\frac{5}{32}$ " thick, but none tore apart in either set of tests. **LESSON:** Glue bonds provide even a skinny tenon great strength.

■ **FINDING:** On two pull-

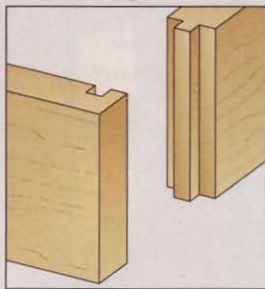

PULL-APART STRENGTH: 1,323 LBS

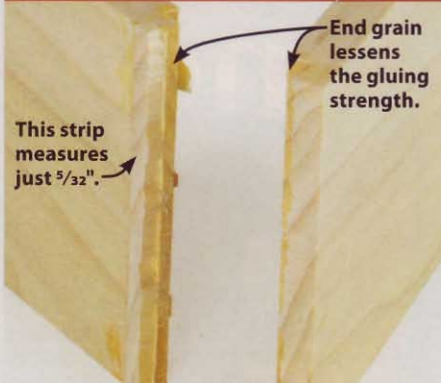

apart tests that were stopped after cracking at peak strength, the joint still held together. **LESSON:** Carefully reglue end

SHEAR STRENGTH: 85 LBS

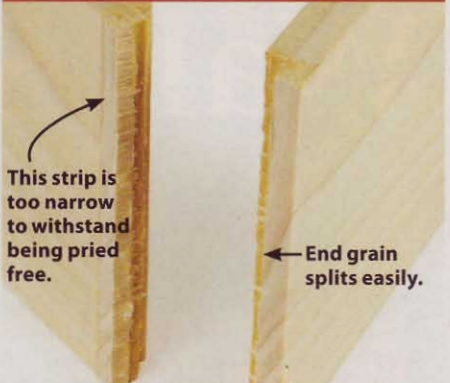

grain of the dadoed piece at the first sign of cracks, and you may still be able to salvage the joint.

## #8 Half-blind dovetail

■ **FINDING:** Pull-apart tests quickly broke the glue joint, but the shape of the pins within the dovetail piece kept the two halves together. **LESSON:** You can disassemble damaged half-blind dovetails, remove the old glue, and successfully reglue the joint.

■ **FINDING:** On pull-apart tests, the curved backs of some pins tore apart from the stress. **LESSON:** Slow your router speed enough to prevent burning either the pin or the dovetail pieces. Then glue all the

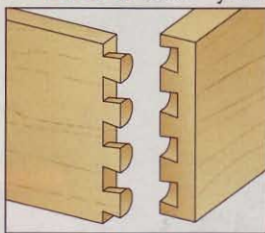

PULL-APART STRENGTH: 972 LBS

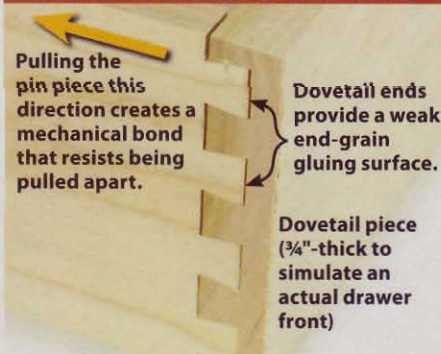

joint surfaces of both pieces, not just the dovetail sides.

■ **FINDING:** No half-dovetails along the edge of any sample cracked or broke off. **LESSON:** Lay out the joint so that partial dovetails at the edges measure at

SHEAR STRENGTH: 59 LBS

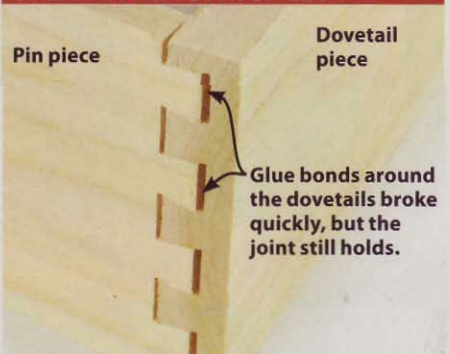

least half the width of the full dovetails.

■ **FINDING:** Joint parts remained connected well after the glue joint cracked. **LESSON:** Mechanical strength explains why woodworkers have made dovetail joints for centuries.

## CONCLUSIONS

Choose box joints for a drawer rugged enough to be pulled out and used as a storage box or organizer. For mitered corners without visible end grain, lock miters have nearly the same strength.

Lock rabbets create an easy-to-make but strong joint for attaching drawer backs you'll inset 1" or more from the ends of the drawer sides. Machine-made through-dovetails lack shear strength, but they're one of the few repairable joints—great for heirloom furniture.

Sliding dovetails offer little strength or practicality. If your drawer bottom rides in grooves on all four sides, you'll need an alternate joint for the front or back. Nail-reinforced rabbets may not be elegant, but they're quick to make and can attach both the fronts and backs—fine for utility drawers. As for shouldered dado joints, you're better off using lock

## Box joints, lock miters lead in drawer joinery

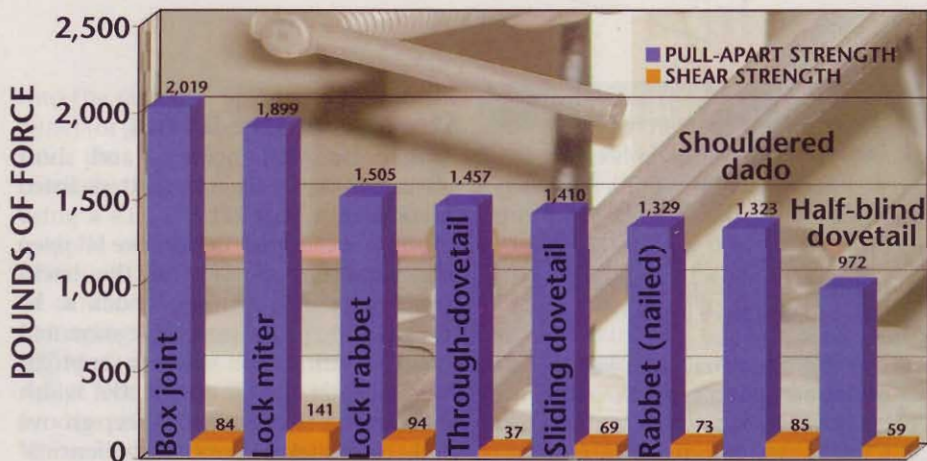

miters if you want a joint you can cut on a tablesaw. Half-blind dovetails lacked the strength of the other joints, but they're attractive, leave a smooth drawer front, and like the through-dovetails,

you can reassemble them should the glue bond break. 🌱

Written by Bob Wilson  
Illustrations by Roxanne LeMoine  
Sample joints prepared by Dean Fiene

# Set-the-Mood Wall Sconces



Add ambiance to any room with these candleholders, made from cherry and accented with copper tray liners and back inserts.

## PROJECT HIGHLIGHTS

- Overall dimensions: 4½" wide x 5" deep x 16" high (tall sconce), 12" high (medium sconce), and 8" high (short sconce).
- Materials needed: A ¾x5½x60" cherry board, a ⅛x12x12" piece of birch plywood, and three pieces of .025x4x10" copper sheet.
- Form the copper trays with ease by cutting and gluing in place separate bottom and side pieces rather than bending a pattern-cut piece to shape.

### Skill Builder

- Learn the simple tricks for cutting and polishing copper sheet. It's easier than you think!

### Start with the backs

**1** Cut the tall, medium, and short backs (A, B, C) to the sizes listed [Materials List, page 72].

**2** Rout a centered 1½" groove ¼" deep into the back face of the backs [Drawing 1]. To do this, chuck a ¾" straight bit into your table-mounted router. Position the fence to approximately center the bit on the 4½" width of the backs. Then rout a ¼"-deep groove along each back. Reposition the fence 3" from the outside cutting edge of the bit. Now make two passes to widen the groove to 1½" [Photo A].

**3** Lay out the 1¼"-square openings on the fronts of the backs (A, B, C),

where dimensioned. Drill a ⅛" blade start hole approximately in the center of each opening. Scrollsaw the openings to shape [Photo B]. Sand off any splinters from the backs of the openings.

**4** To form the mounting cleats (D) and tall-, medium-, and short-back fillers (E, F, G), cut three ¼x1½x13" blanks to fit snugly into the grooves in the backs (A, B, C). Bevel-cut each end of the blanks at 45°. Then crosscut a 1½"-long piece from each end for the mounting cleats. Now cut the remaining blanks to 9⅞", 7⅝", and 5⅜" long for the fillers.

**5** Glue and clamp three of the mounting cleats (D), with the beveled ends in the correct orientation [Drawing 1],

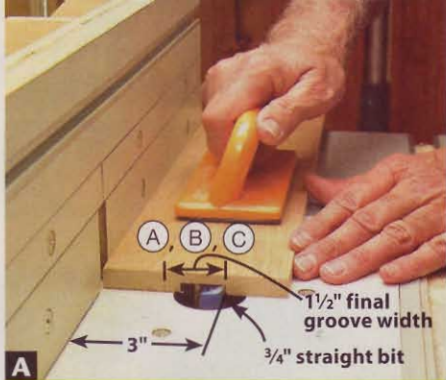

**A ROUT GROOVES INTO THE BACKS**  
Widen the centered 1/4"-deep groove in the backs (A, B, C) by making two passes, rotating the parts 180° between the passes.

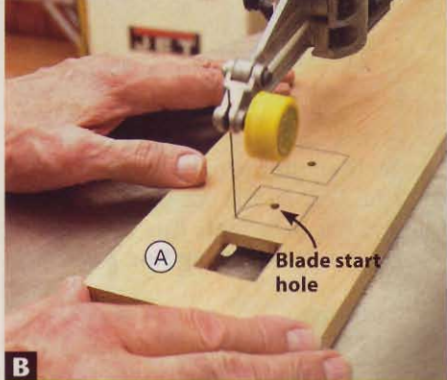

**B SCROLLSAW THE BACK OPENINGS**  
Insert your scrollsaw blade through the blade start hole, and cut out each of the 1 1/4"-square openings in the backs (A, B, C).

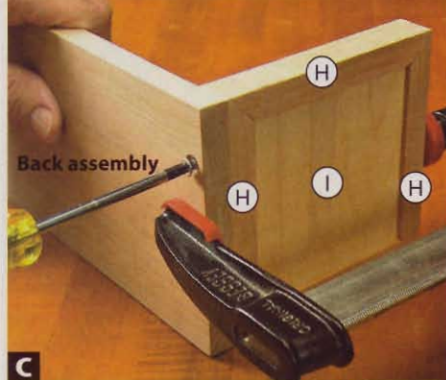

**C SCREW-MOUNT THE TRAYS**  
With the trays (H/I) glued and clamped to the back assemblies, drive the screws through the holes in the backs into the trays.

and the fillers (E, F, G) into the grooves in the backs (A, B, C), with the top and bottom ends of the cleats, fillers, and backs flush.

**6** Drill a countersunk shank hole, centered, through the *front* face of the remaining mounting cleats (D). (For the #8 screws in this project, drill 5/32" shank holes.) Then, using a 120-grit sanding block, lightly sand the *edges* of the cleats so they fit easily into the grooves in the backs to ensure trouble-free wall mounting of the sconces. Now sand 45° bevels on the edges [Drawing 1a]. This provides clearance for the beads of adhesive that you'll apply later to hold the copper

inserts (L, M, N) in the backs. Sand the back assemblies to 220 grit.

### On to the trays and copper

**1** To form the tray sides (H), cut three 3/4x1/2x20" blanks. Cut a 1/8" groove 1/4" deep 1/8" from the bottom into each blank on the inside face to fit the plywood tray bottoms (I) [Drawing 1]. Miter-cut four 4 1/2"-long pieces from each blank for the sides, using an extension on your miter gauge for support, and a stopblock to ensure identical lengths for square glue-ups.

**2** Cut the plywood tray bottoms (I) to the size listed. Then glue the tray

sides (H) together, with the bottoms captured in the grooves. We used masking tape to draw the mitered corners of the sides tightly together. Sand the assemblies smooth.

**3** To mount the trays (H/I) to the back assemblies (A/D/E, B/D/F, C/D/G), drill two countersunk shank holes through the back faces of the backs, where dimensioned [Drawing 1]. Glue and clamp the trays to the backs, flush with the edges and bottoms. Now drive the #8x3/4" flathead wood screws [Photo C]. Due to the short engagement of the 3/4"-long screws, we did not drill pilot holes into the trays.

### 1 EXPLODED VIEW

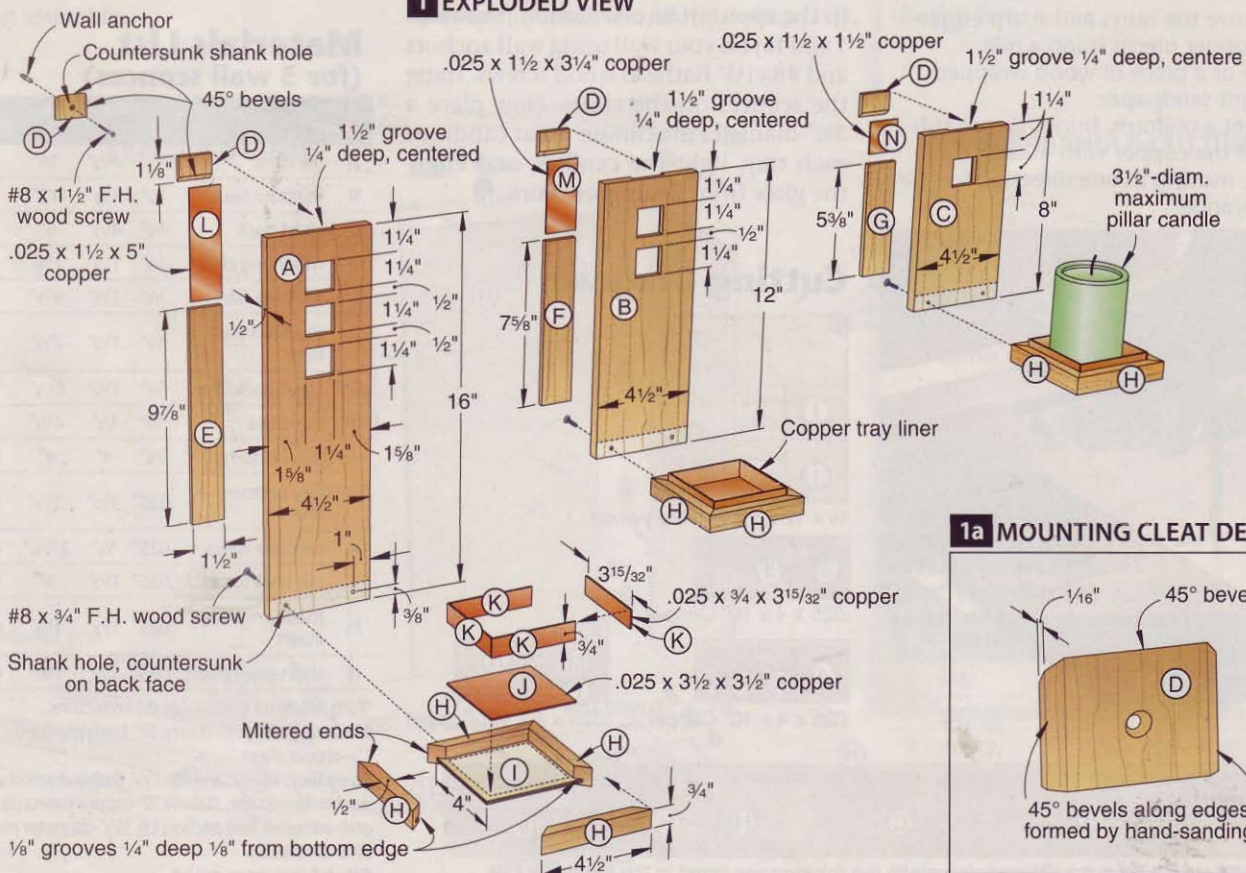

### 1a MOUNTING CLEAT DETAIL

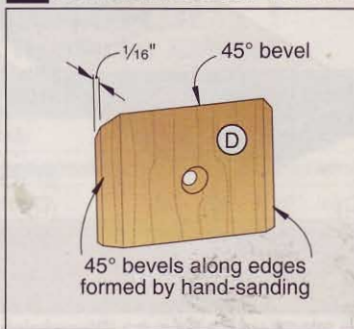

**4** From .025"-thick copper sheets, cut the tray bottom and side liners (J, K), and tall-, medium-, and short-back inserts (L, M, and N) to the sizes listed. You'll find the copper sheets (typically 4x10") at crafts supply and hobby stores. You'll need three sheets. To ensure an exact fit, measure the tray openings before cutting the copper pieces to size.

## SHOP TIPS

### 5 tips to ensure your copperwork shines

**Tip 1** You can cut copper sheet with tin snips or shears, but you'll wind up with curled edges that rarely look smooth after flattening, and you'll find it a challenge to make identical-size parts. Instead, use your bandsaw, fence, and a piece of ¼" hardboard for a zero-clearance backer to get perfect results. After cutting a kerf into the backer, adhere it to the bandsaw table using double-faced tape, as shown below. The backer prevents the copper from curling, and it raises the copper so it can't slip under the fence.

**Tip 2** For a smooth cut, use a blade with at least 14 teeth per inch, and feed the copper slowly.

**Tip 3** Use the eraser end of a pencil to safely guide the copper through the cut, as shown.

**Tip 4** Remove the burrs and sharp edges from the copper pieces using a mill bastard file or a piece of wood wrapped with 150-grit sandpaper.

**Tip 5** To get a uniform, bright sheen, rub the faces of the copper with 400-grit sandpaper, moving in one direction for the best appearance.

Note that the tray side liners are ½" shorter than the openings to allow a butt-joint fit. Deburr the edges, and buff the copper. For help with this and cutting the copper, see the **Shop Tips**, below left.

### Finish up

**1** Finish-sand any wood areas that need it to 220 grit. Remove the dust.

**2** Apply a stain and clear finish. We applied Varathane no. 455 Traditional Cherry Gel Stain, followed by three coats of aerosol lacquer. To prevent tarnishing of the copper parts, we sprayed them with one coat of lacquer.

**3** Apply a small amount of an instant-grab adhesive, such as DAP Strongstik, available at your local home center, to the tray bottom liners (J). Press the liners into place against the tray bottoms (I). Then apply adhesive to the tray side liners (K) and press them into place in each tray [Photo D]. Now position the tall-, medium-, and short-back inserts (L, M, N) into the openings in the backs (A, B, C), tight against the tops of the fillers (E, F, G). Apply a small bead of the instant-grab adhesive along the edges and bottom of the inserts to hold them in place in the backs.

**4** Finally, to hang the sconces, level and fasten the mounting cleats (D) in the appropriate orientation [Drawings 1 and 1a] on your wall using wall anchors and #8x1½" flathead wood screws. Hang the sconces on the cleats. Now place a 3½"-diameter maximum pillar candle in each tray, light the candles, and enjoy the glow from your handiwork. 🌿

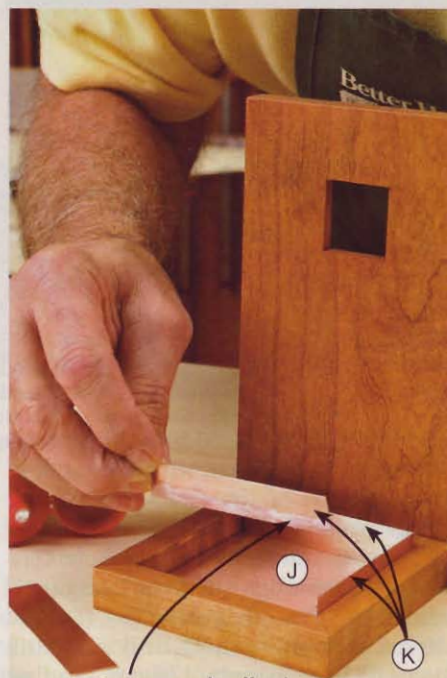

**D** Instant-grab adhesive  
**INSTALL THE COPPER TRAY SIDES**

Apply an approximately ¼"-wide bead of adhesive along an edge of the tray side liners (K), and press them into place in the trays.

Written by **Owen Duvall** with **Chuck Hedlund**  
Project design: **Kevin Boyle**  
Illustrations: **Roxanne LeMoine; Lorna Johnson**

## Materials List (for 3 wall sconces)

Part	FINISHED SIZE			Matl.	Qty.
	T	W	L		
A tall back	½"	4½"	16"	C	1
B medium back	½"	4½"	12"	C	1
C short back	½"	4½"	8"	C	1
D* mounting cleats	¼"	1½"	1⅞"	C	6
E* tall-back filler	¼"	1½"	9⅞"	C	1
F* medium-back filler	¼"	1½"	7⅞"	C	1
G* short-back filler	¼"	1½"	5⅞"	C	1
H* tray sides	¾"	½"	4½"	C	12
I tray bottoms	⅞"	4"	4"	BP	3
J tray bottom liners	.025"	3½"	3½"	CS	3
K tray side liners	.025"	¾"	3⅝"	CS	12
L tall-back insert	.025"	1½"	5"	CS	1
M medium-back insert	.025"	1½"	3¼"	CS	1
N short-back insert	.025"	1½"	1½"	CS	1

\*Parts initially cut oversize. See the instructions.

**Materials key:** C—cherry, BP—birch plywood, CS—copper sheet.

**Supplies:** #8x¾" and #8x1½" flathead wood screws, double-faced tape, .025x4x10" copper sheets (3), instant-grab adhesive, wall anchors (3), 3½"-diameter maximum pillar candles (3).

**Bit:** ¾" straight router bit.

## Cutting Diagram

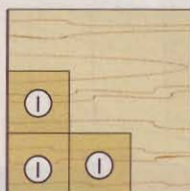

⅛ x 12 x 12" Birch plywood

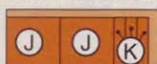

.025 x 4 x 10" Copper

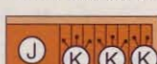

.025 x 4 x 10" Copper

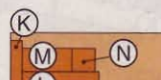

.025 x 4 x 10" Copper

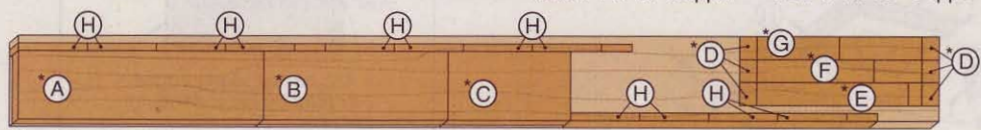

¾ x 5½ x 60" Cherry (2.5 bd. ft.) \*Plane or resaw to the thicknesses listed in the Materials List.



## Make and master the no-cost **Box-Joint Jig**

Waiting until the price is right to acquire a box-joint jig? By using shop scraps, we got the cost down to zero, and came up with a method that makes adjacent box sides interchangeable for foolproof assembly.

**W**hile making the box-jointed trio on page 78, *WOOD*® magazine Master Craftsman Chuck Hedlund came up with an innovative way to make box joints using a simple box-joint jig. He also incorpo-

### QUICK TABLESAW TUNE-UP

The box joint relies on simple geometry: All of the cuts are square to each other and to the face of the lumber. So before you make the jig, take a few minutes to verify your table saw's settings and to make any adjustments.

First, ensure that the blade is absolutely parallel to the miter-gauge slot. Next, set the blade perfectly perpendicular to the tabletop. Finally, lock your miter gauge at a right angle to the blade.



Watch two **FREE** videos related to this article. Learn how to make and use this jig at [woodmagazine.com/videos](http://woodmagazine.com/videos). And tune-up your table saw with tips at [woodmagazine.com/tstuneup](http://woodmagazine.com/tstuneup).

rated a subtle change in the arrangement of the fingers. The traditional method: Make two sides that start with a finger at the top and two ends that start with sockets at the top, as shown at *right top*. Instead, Chuck made four interchangeable sides, each with a finger at the top of one end, and a socket at the top of the other, as shown at *right bottom*. This technique makes it nearly impossible to assemble a box incorrectly. Here's how to make the jig and cut the joints.

### Every good box joint needs an accurate jig

To ensure success in making box joints, first check the alignment of your table saw. For tune-up tips, see the sidebar at *left*. With your table saw ready, begin making the jig by cutting a 4×18" extension for your miter gauge from ¾" medium-density fiberboard (MDF). MDF is typically flat, but check your piece after cutting by laying each side flat on your saw table. Don't attach the extension to your miter gauge yet.

Install a ¼" dado blade and a zero-clearance insert in your table saw. Raise the dado blade to make a cut just a hair more than ¼" deep. Verify the depth with a test cut in scrap.

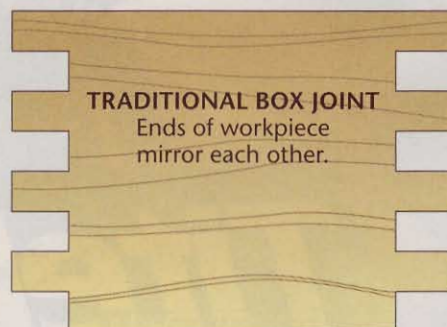

**TRADITIONAL BOX JOINT**  
Ends of workpiece mirror each other.

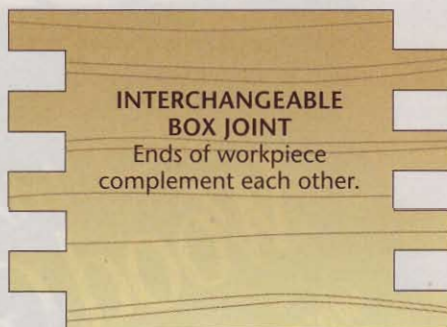

**INTERCHANGEABLE BOX JOINT**  
Ends of workpiece complement each other.

### Notch the extension and install an index pin

Set your rip fence to cut a notch 7" from the end of the MDF miter gauge extension [Photo A]. Holding the extension against your miter gauge, cut the notch.

CUT THE FIRST NOTCH

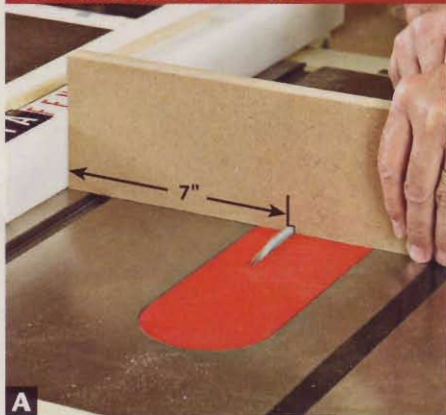

A

FIT THE INDEXING PIN

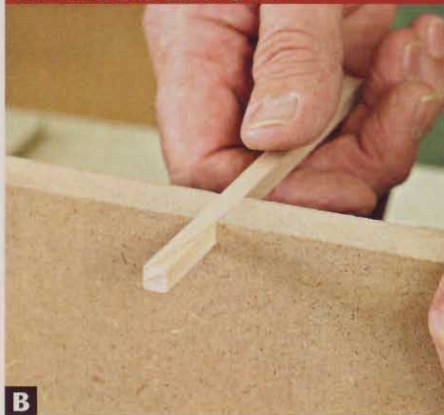

B

CUT THE SECOND NOTCH

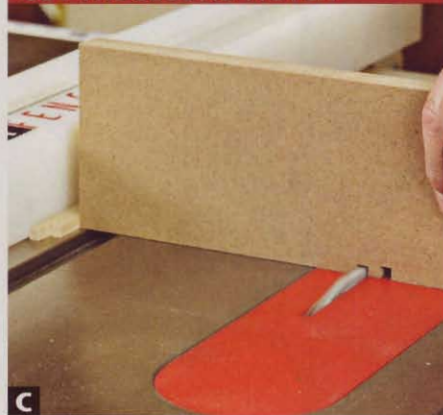

C

SECURE THE INDEXING PIN

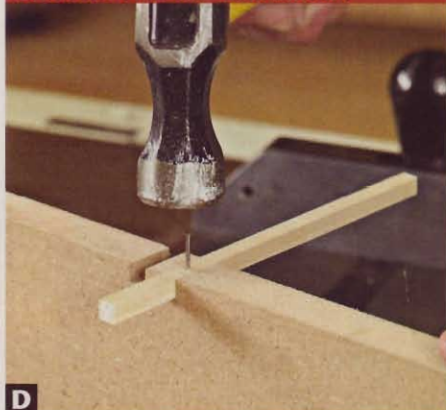

D

CUT THE FIRST SOCKET



E

STEP, THEN CUT SOCKET #2



F

(Don't pull the extension backward through the blade and don't move the rip fence after the cut.)

To make the indexing pin, start by planing a 12" length of hardwood scrap (we used maple) until you have a perfectly square section that fits snugly into the notch in the extension [Photo B]. As you approach the  $\frac{1}{4}$ " thickness on the pin, lower the cutterhead in tiny increments to sneak up on a snug fit and rotate the stock 90° for a second pass at each height setting to keep it square.

When you're satisfied with the fit, crosscut the strip in half. Place the two strips side by side against the fence [Photo C]. Holding the extension against the strips, cut a second notch. Again, cut only on the forward stroke.

Turn the extension upside down and insert one of the hardwood strips into the second notch, leaving about 1" projecting from the front, [Photo D]. Drive a nail to hold this indexing pin in place. (To avoid splitting, drill a pilot hole first.) Set the second hardwood strip aside: You'll need it later.

Finally, apply double-faced tape to the back of the extension. With the end of the extension against the rip fence, slide

the miter gauge squarely into position against the back of the extension, adhering it with the tape. Use screws to secure the extension to the miter gauge. After double-checking the set-up, you can remove the rip fence.

### Building a better box starts with stock prep

When building boxes, spending a few extra minutes properly preparing stock will pay big dividends when the joints slide together sweetly. Here's the sequence that produces that big payoff.

**Step 1** Use your jointer to flatten one face of each board, and then plane the opposite face smooth, parallel, and to the desired thickness.

**Step 2** With one face held flat against the jointer fence, machine one edge of each board straight, smooth, and square. Rip the opposite edge  $\frac{1}{8}$ " wider than your box's finished height, and mark the ripped edge with a continuous pencil line. Why the extra width? Because a tiny error in the width of each cut multiplies with each subsequent cut across the width of the workpiece. Cutting the pieces oversize accommodates that accumulation. If your joint cuts wind up

dead-on, you simply trim away the excess after cutting the joint. If they don't, each joint still sports a full set of identical pins and sockets.

**Step 3** With the jointed edge against the miter gauge, cut the box pieces to length. An extension with a stopblock ensures identical lengths.

While you're preparing your project stock, it's a good idea to give identical treatment to some extra scraps that you can use for test cuts.

### Test cuts prove the accuracy of your setup

Making test cuts in scrap will familiarize you with the cutting technique and confirm the jig setup.

With the pencil-marked edge away from the blade, [Photo E], hold a box side flat against the miter gauge extension, butted against the indexing pin. Cut the first socket, and after the jig clears the dado head, lift the box side clear instead of pulling it backward through the blade. (At this time, pulling the jig itself backward over the blade is fine.) Now fit the first socket over the indexing pin [Photo F], and make the second cut. Continue placing the just-



cut socket onto the indexing pin until the joint is complete.

Consistency counts when you make the multiple passes required to make a box joint. For the best results, try to keep your body mechanics identical on each stroke. For example, your miter-gauge bar has a small amount of clearance to permit it to slide. To prevent that slight allowance from introducing a problem, exert the same amount of sideways pressure on the gauge as you make each cut.

### Cut the opposite end of the workpiece

Begin the opposite-end cuts by placing the hardwood strip between the indexing pin and the box side [Photo G]. Keep the end of the box side flat against the table, and the pencil-marked edge away from the indexing pin. Make the cut, and set aside the strip. Register the end socket against the indexing pin and make the second cut [Photo H]. Continue this sequence to complete the joint.

After cutting two sides, dry-assemble them to check the joint fit. The ideal box joint fits together with only slight resistance.

If the joint is too tight, the space between the dado blade and the pin is too wide. To fix this, make pencil registration marks on both the extension and the miter gauge indicating their current position. Remove the jig from the miter gauge, strip away the carpet tape, and move the extension slightly to the left. Carefully snug down the screws to hold it in this new position. If the joint has visible gaps, the space between the dado blade and pin is too small. Follow the procedure outlined above, but this time shift the extension slightly to the right. Prove the setup with a new series of test cuts.

### SHOP TIP

#### How a mirror saves your neck

Craning your neck to look over the box-joint jig to align the socket on the indexing pin can quickly become uncomfortable. Eliminate this problem by propping and clamping a mirror at the end of your saw table, as shown at right. A 12" mirror tile is an inexpensive solution you can find at nearly any home center. Apply tape to its edges to prevent cuts.



### Trim the sides to width

After you've cut joints in all of the sides, it's time to rip them to final width. Set your tablesaw rip fence to precisely align the blade with the bottom of the last

socket (the one at the pencil-marked edge) [Photo I], and rip all the sides. 🌲

Written by **Robert Settich** with **Chuck Hedlund**



Practice using the jig and refine your box-joint making technique by building this handsome trio of boxes from the step-by-step plans starting on page 78.

# Tempting Trio Box Ensemble



These catchall containers, with beautiful finger joints, are deceptively simple to make.

## PROJECT HIGHLIGHTS

- Overall dimensions: 7¼" wide x 19⅝" long x 5⅝" high.
- The staggered arrangement of the boxes shows off the corner joinery.
- Make it with odds and ends you already have in your shop.

### Skill Builders

- A clever variation in technique makes box joints easier to cut.
- Discover how a special router bit takes the hassle out of installing the bottoms in box-jointed boxes.
- Learn how to make perfect radius corners on your router table.

### Build the boxes

**1** From ¼" stock, cut the box sides (A) to length and ⅛" wider than listed [Materials List, page 80]. Now, to form the finger joints, see page 74.

**2** With the finger joints complete, dry-assemble the boxes, and rout a groove into each one for the bottom (B) [Drawing 1, Photo A]. (See Source for the router bit.) Then make a snug-fitting box-squaring jig [Drawing 2]. (We used ¼" hardboard.)

**3** Cut the bottom (B) to size, and radius the corners [Drawing 1]. For a quick way to form perfect radii, see the **Shop Tip** on the next page.

**4** Dry-fit the bottoms (B) into the boxes. Then separate the sides (A) and bottoms, and finish-sand the inside faces of the sides and the bottoms. [Photo B], and apply a clear finish to the inside faces of the sides and the bottoms. (We applied three coats of aerosol satin

### ROUT THE BOTTOM SLOTS

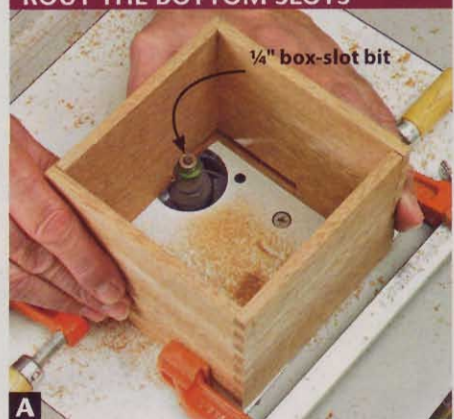

**A** Clamp each box together without glue, and use a ¼" box-slot bit to rout a slot around the inside for the bottom (B).





# 1 EXPLODED VIEW

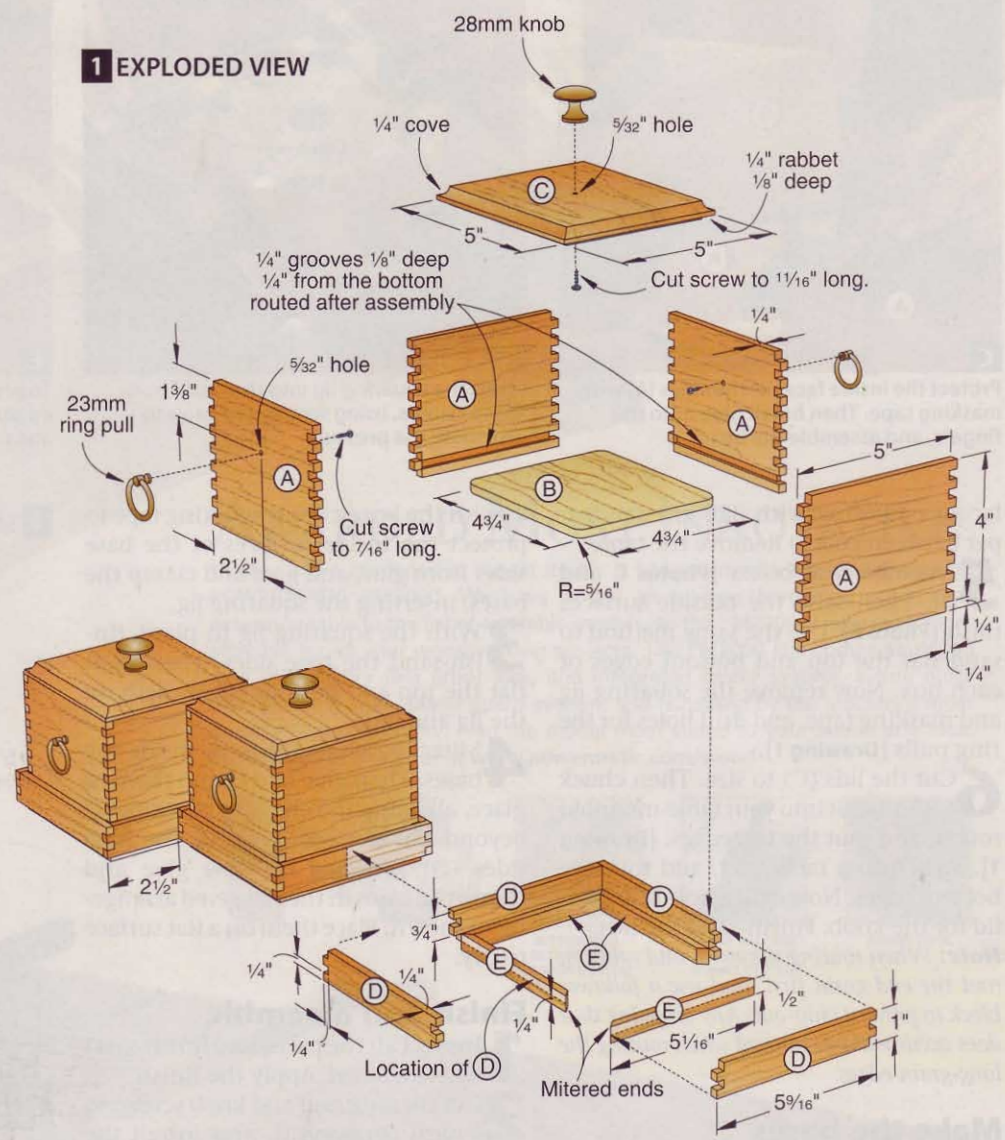

## SHOP TIP

### How to form perfect corner radii

Using a box-slot bit to form grooves in the box sides for the bottom saves you the trouble of filling in gaps at the corners, made by cutting the grooves on the table saw or router table with a straight bit. The trade-off is that you must round the corners of the bottom to match the radius of the slot bit. Here's a simple way to quickly form perfect corner radii:

Chuck a round-over bit that matches the radius of the slot cutter into your table-mounted router ( $\frac{3}{16}$ " for this bit). Position the fence flush with the bit pilot bearing and parallel to the miter-gauge slot. Then attach an extension to the miter gauge with the end just grazing the face of the fence. Now,

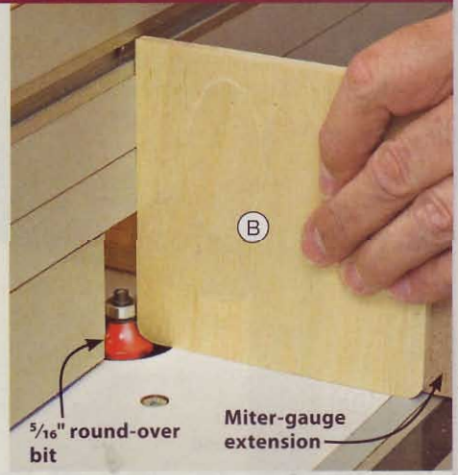

with the bottom (B) against the fence and backed by the extension, rout the corners, as shown above.

### MASK THE GLUE SURFACES

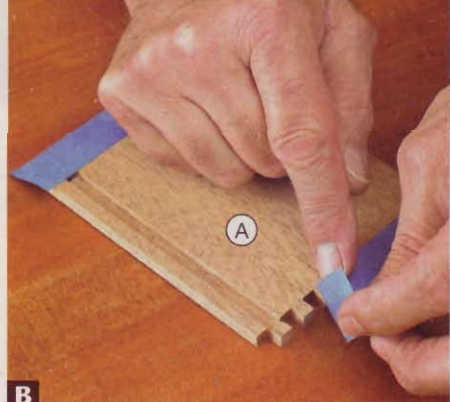

**B** To protect the glue surfaces of the box sides (A) when finishing the inside surfaces, cover the fingers with masking tape.

## ASSEMBLE AND SAND THE BOXES

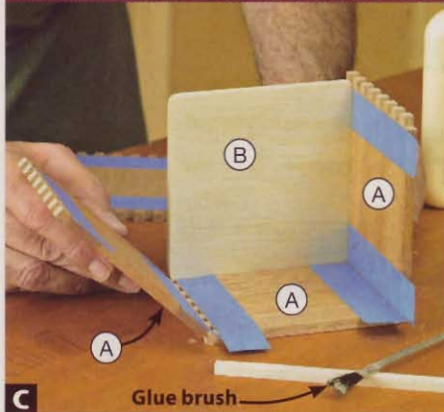

**C** Protect the inside faces of the sides (A) with masking tape. Then brush glue onto the fingers, and assemble the box.

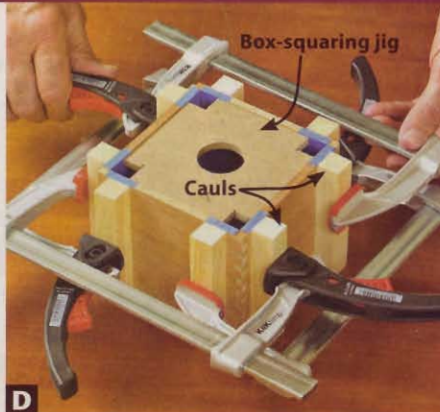

**D** Insert the squaring jig into the box. Then apply clamps, using scrapwood cauls to distribute the pressure.



**E** To prevent rounding of the corners and edges, adhere sandpaper to a flat surface, and finish-sand the outsides of the boxes.

lacquer, sanding with 320-grit sandpaper between coats.) Remove the tape.

**5** Assemble the boxes [Photos C and D]. Then sand the outside surfaces flush [Photo E]. Use the same method to sand flat the top and bottom edges of each box. Now remove the squaring jig and masking tape, and drill holes for the ring pulls [Drawing 1].

**6** Cut the lids (C) to size. Then chuck a  $\frac{1}{4}$ " cove bit into your table-mounted router, and rout the top edges. [Drawing 1]. Switch to a rabbet bit, and rout the bottom edges. Now drill a hole into each lid for the knob. Finish-sand the lids.

**Note:** When routing the coves and rabbets, rout the end grain first, and use a follower block to prevent chip-out. Any chipping that does occur will be removed when routing the long-grain edges.

### Make the bases

**1** Cut the base sides (D) to length and  $\frac{1}{8}$ " wider than listed. Then form the finger joints in the same manner as for the box sides (A).

**2** Dry-assemble one base, and make a base-squaring jig [Drawing 2]. Then,

as with the boxes, apply masking tape to protect the inside surfaces of the base sides from glue, and glue and clamp the bases, inserting the squaring jig.

**3** With the squaring jig in place, finish-sand the base sides. Then sand flat the top and bottom edges. Remove the jig and tape.

**4** Miter the cleats (E) to fit inside the bases. Then glue and clamp them in place, allowing the cleats to protrude  $\frac{1}{4}$ " beyond the bottom edges of the base sides (D) [Drawing 1]. Now glue and clamp the bases in the staggered arrangement shown. Place them on a flat surface to dry.

### Finish and assemble

**1** Inspect all the parts, and finish-sand where needed. Apply the finish.

**2** Cut the ring pull and knob screws to length [Drawing 1], and install the hardware. Place the boxes into the base frames, resting them on the cleats (E). 🌲

Written by **Jan Svec** with **Chuck Hedlund**

Project design: **Kevin Boyle**

Illustrations: **Roxanne LeMoine; Lorna Johnson**

## 2 SQUARING JIGS

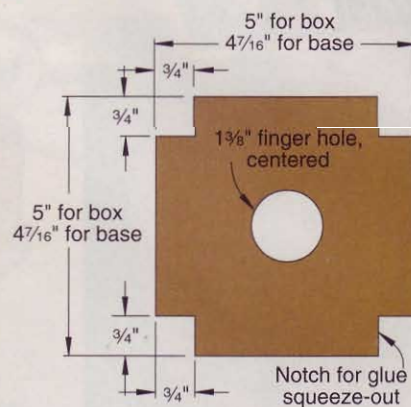

## Materials List

Part	FINISHED SIZE			Matl.	Qty.
	T	W	L		
A* box sides	$\frac{1}{4}$ "	4"	5"	M	12
B bottoms	$\frac{1}{4}$ "	$4\frac{3}{4}$ "	$4\frac{3}{4}$ "	BP	3
C lids	$\frac{1}{2}$ "	5"	5"	M	3
D* base sides	$\frac{1}{4}$ "	1"	$5\frac{9}{16}$ "	M	12
E cleats	$\frac{1}{4}$ "	$\frac{1}{2}$ "	$5\frac{1}{16}$ "	M	12

\*Parts initially cut oversize. See the instructions.

**Materials key:** M—mahogany, BP—birch plywood.

**Supplies:** Masking tape, spray adhesive.

**Blade and bit:** Stack dado set;  $\frac{1}{4}$ " box-slot,  $\frac{5}{16}$ " round-over,  $\frac{1}{4}$ " cove, and rabbet router bits.

### Source

**Router bit:**  $\frac{1}{4}$ " box-slotting bit no. 16J83.04, \$26.60. Lee Valley, 800-871-8158, leevalley.com.

**Hardware:** 23mm ring pulls no. 01A23.21, \$1.35 ea. (6); 28mm knobs no. 01A03.28, \$2.50 ea. (3). Lee Valley, above.

## Cutting Diagram

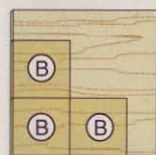

$\frac{1}{4}$  x 12 x 12" Birch plywood

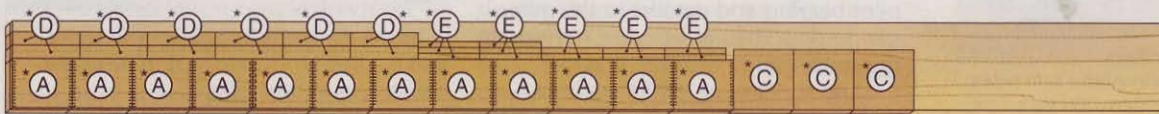

$\frac{3}{4}$  x  $7\frac{1}{4}$  x 96" Mahogany (5.3 bd. ft.) \*Plane or resaw to the thicknesses listed in the Materials List.

Find more gift project plans at  
[woodmagazine.com/gifts](http://woodmagazine.com/gifts).



# Just-Right Joinery

## Install corner connectors for sturdy tables

These easy-to-install brackets speed up making and moving your tables.

**C**orner connectors do more than simplify table joinery. They let you tighten up loose legs as the humidity changes or remove them completely for storage.

Installation details vary with the size of bracket used and the sizes and positions of the table leg and apron parts. We'll use the harvest table on page 58 as a general example.

### Locate the connectors

To determine the connector positions on the apron pieces, first trace around the end of a leg at one corner of a sheet of paper [Photo A]. Then make a style decision about whether you want the apron parts to butt against the leg at its center, at the inside corner, or nearer the outside corners of the leg. Your choice depends on how far you want the legs to stand out from the apron and the width of your corner connectors. Mark the apron locations on the paper, and extend lines at least 8" out at 90° from the faces of the leg [Photo B].

Place a corner connector upright on the paper with the perpendicular flat sections touching the inside lines representing the apron [Photo C]. Make certain the connector flanges overlap the lines at equal distances from the leg. Measure those distances for the locations of the mounting kerfs.

Then check the drawing to make certain the bracket will clear the corner of the table leg. If the bracket comes closer than 1/4" to the leg, mark on the drawing where you'll need to chamfer the inside corner of the leg [Photo D].



### MARK THE LEG DIMENSIONS FIRST



**A**

### DRAW IN THE APRON PARTS

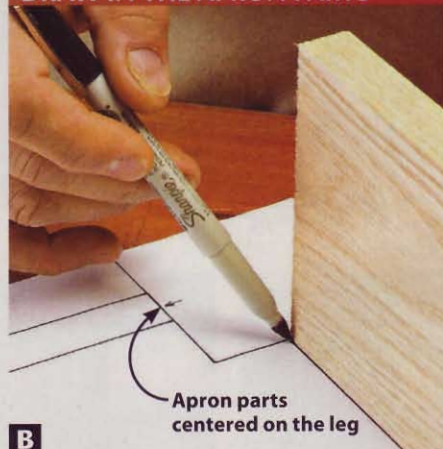

**B**

### POSITION THE CONNECTOR

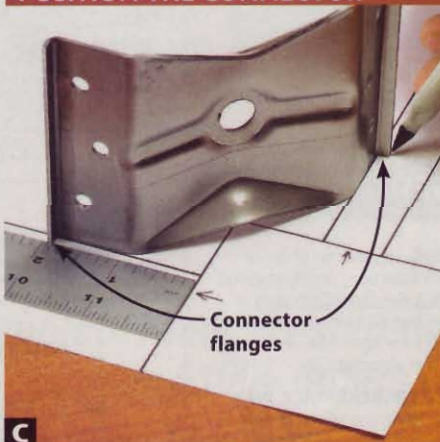

**C**

### CHECK CONNECTOR CLEARANCE



**D**

To cut the kerfs, set the tablesaw fence your measured distance from the blade, and adjust the blade height to

cut deep enough to accept the connector flanges. Then cut kerfs at both ends of all four apron pieces [Photo E].

*continued on page 86*

## Just-Right Joinery

### CUT KERFS FOR FLANGES



### Chamfer the table leg

If you need to rout a chamfer along one corner, refer to your drawing to determine how much of the table leg corner will need to be removed. Then chuck a 45° chamfer bit into a table-mounted router and adjust the bit height to cut a sufficiently wide chamfer [Photo F]. After routing the

### ROUT A CHAMFER ON THE LEG



### MEASURE FOR HANGER BOLTS



corner, check it against your drawing for clearance.

To hold the legs steady for drilling the hanger-bolt pilot holes, make a V-groove jig by tilting your tablesaw blade to 45° and grooving a piece of 2×4 scrap long enough to support the legs. Then find the locations of the pilot holes by centering a connector on two apron pieces, clamping it into position, and measuring up to the hanger-bolt hole [Photo G]. Transfer that measurement to the table-leg chamfers and drill the pilot holes [Photo H].

Tighten two jam nuts together at the end of a hanger bolt and thread the bolt into a pilot hole up to the machine threads [Photo I]. Then remove the jam nuts. Repeat for the other legs.

### Assemble the joint

Center a connector on the width of an apron side, and drill mounting-screw pilot holes with a self-centering bit [Photo J]. Repeat on the other end of this side piece and both ends of the

opposite apron piece. Attach each of the four connectors to an apron side.

Next, stand one apron side on edge atop a flat surface. Clamp an apron end piece to the connector, drill mounting-screw pilot holes, and screw the end piece to the connector [Photo K]. Repeat on the other end of that piece and for the second side piece.

With the apron assembled, place a leg at one corner with the hanger bolt inserted into the connector. Attach the leg using a washer and a nut, as shown on page 84. Tighten the nut enough to bring the leg snug against the apron ends. Then repeat to attach the remaining legs. 🌲

### DRILL HANGER-BOLT PILOT HOLES



### INSERT HANGER BOLTS



### DRILL CONNECTOR PILOT HOLES



### ATTACH THE CONNECTORS

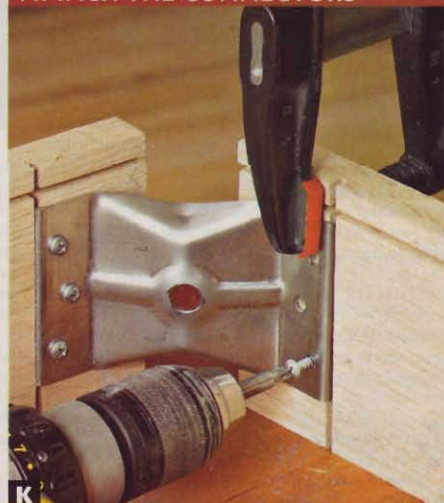

### Sources

**Corner connector and hanger bolt set.** Set no. 901 with four 3×4<sup>5</sup>/<sub>8</sub>" connectors, hanger bolts, screws, and washers, \$7.65, Osborne Wood Products, 800-849-8876; osbornewood.com.

**Corner connectors and hanger bolts.** Kerf-mounted, 3×4<sup>3</sup>/<sub>4</sub>" connector no. 34303, \$4 for four; hanger bolt no. 24430, 5/16-18×3", \$2.29 for 8; Rockler Woodworking and Hardware, 800-279-4441; rockler.com.

## Veneer values vary

**Q:** I'm making a table, and the plans say to subtract the thickness of the veneer when cutting certain parts. Can you tell me the thickness of veneer? Some places say it's 1/42" and others say it's 1/32", or even 1/100".

—Jack Griffin, Brighton, Ont.

**A:** You won't find such a thing as a standard veneer thickness, Jack. Thicknesses vary by species, veneer makers and sometimes even with customer preferences. The David R. Webb Company in Edinburg, Ind., sells veneers

mostly in the range of .5mm to .6mm, a little thicker than 1/64". But it also sells a 2.5mm (about 3/32") veneer used by boat builders as well as veneers thinner than 1/128" for export to Japan, where the need to use valuable veneer logs efficiently dictates a standard thickness much thinner than in the United States.

Your best bet: Order the veneer you want before beginning your project. Then measure its thickness, double that to allow for both the top and the balancing bottom veneers, and use that number when machining your other project parts.

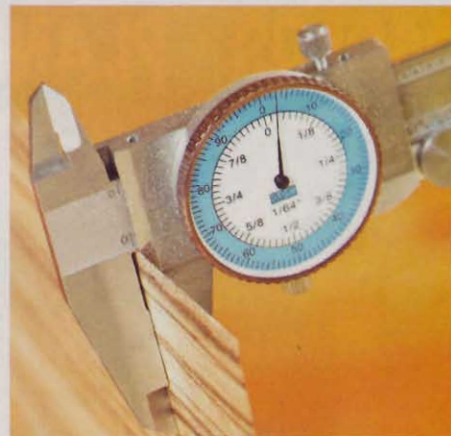

## ARE YOU READY FOR THIS?



**Drill Doctor**  
The Drill Bit Sharpener



### Check all that apply:

- I have a collection of old dull drill bits I just can't throw away.
- I'd rather spend my money on new tools than on buying more drill bits.
- I know I should sharpen my drill bits, but I don't have time to become a sharpening expert.
- I want to drill clean, precise holes every time.
- I'm tired of searching through all of my used bits trying to find one sharp enough to use.

If you checked any of these, you're ready to sharpen your drill bits with Drill Doctor, THE Drill Bit Sharpener. See it in action online at

[www.drilldoctor.com](http://www.drilldoctor.com)

1-888-MYDRILL (693-7455)

Look for the Drill Doctor at Sears, The Home Depot, Lowes, Northern Tool, and wherever you buy your tools.

## Two-way slides

**Q:** I'm building a cabinet for under my workbench, and would like the drawers to be accessible from both sides. Do they make a drawer slide that can go both directions?

—Dennis Almond, Reidsville, N.C.

**A:** They do indeed, Dennis. Lee Valley sells what it calls regular-extension, two-way slides that range from an 18" slide (no. 02K0718, \$12.60) to a 38" slide (no. 02K0738, \$18.60; 800-871-8158, or [leevalley.com](http://leevalley.com)).

We used a simpler, hardware-free solution for the drawers of a workbench in the WOOD® magazine workshop. The full-length drawers, shown below, slide out from either side, riding on two wooden strips at the bottom of each drawer opening. We used 3/4"-thick drawer sides and fronts to support their weight.



continued on page 90

## Ask WOOD

### Resuscitate purpleheart's color

**Q:** I have been reading a lot lately about problems with purpleheart turning brown. Some say put it in the sun and it will turn back. Others say the opposite: The sun caused it to turn brown. Will any finishing technique prevent it from browning?

—David Powers, Whiteland, Ind.

**A:** Purpleheart's namesake color comes and goes with exposure to sunlight, David, so both opinions you've heard could be correct. When freshly cut, purpleheart sometimes

appears a dingy brown. Within days, though, it turns a vivid purple in a process that's speeded up by exposure to light.

Months or years after that, especially when exposed to sunlight, purpleheart turns a deep brown with purple overtones, as you can see on the jewelry rack shown at right. A film finish with UV inhibitors can slow the purple-to-brown color change, but not stop it completely. You can also slow the change by keeping finished projects away from direct sunlight.



## PROUD OF WHAT YOU MAKE?

US, TOO.

Introducing



NEW from the makers of  
Drill Doctor.

### Cutting Edge Technology for Woodworkers

Take a look at our latest project. It's the result of years of work, listening to woodworkers like you, and then building the wood tool sharpener that you wanted. Take a tour of the features and see what you think:

580 rpm wheel speed—  
Powerful 1/5 HP Motor

Sharpening Port  
Lapping Surface—  
"plunge-pull"  
sharpening  
technique and  
Sharpening Port  
abrasive increases  
burr removal and  
speeds sharpening

150mm Tempered Glass Grinding Wheel—provides  
an always flat and true, maintenance-free grinding  
surface on which to adhere PSA Abrasives

Sharpening Port—  
enables precise and  
repeatable angles of 20°,  
25°, 30°, and 35° for  
chisels and plane irons  
up to 2" wide



Dry Cooling System—routed  
airflow and heat sink system  
keeps tools cool without the  
mess of a wet system



Innovative Edge-Vision™  
Slotted Wheel lets you  
see the cutting edge as  
you sharpen!



Learn more about the award-winning Work Sharp at  
[www.worksharptools.com](http://www.worksharptools.com)  
or call 1-800-597-6170

Ask for it at Rockler, Woodcraft, and wherever you buy your tools.

Circle No. 1655

### Viva viraro

**Q:** While wood shopping this weekend, my wife picked up a piece of wood she wanted me to use to make a box. It's marked "viraro," but I can't find any information on it. Can you help?

—Ron Lenz, Cable, Wis.

**A:** Whether you call it viraro, amendoim, ibiraro, pau fava, or by its Latin name, *Pterogyne nitens*, you've discovered a South American hardwood that shares much of mahogany's beauty with the advantages of greater luster and rigidity, plus a density exceeding that of red oak.

Like mahogany, the heartwood turns a reddish brown, as a quick wipe with mineral spirits shows in the samples at right. You also can see some of the slightly darker streaks that distinguish viraro from mahogany.

Although it's used in South America to make furniture, sources in North America can be hard to find outside flooring stores that sell imported hardwoods. We discovered our viraro sample at the Rockler store in Wauwatosa, Wis., (414-774-1882) for \$6.25 per board foot.



continued on page 92

Brought to you by  
**WOODCRAFT®**

**FESTOOL**  
Fantasy Camp  
& Shop Giveaway

Entries must be received by  
12 Midnight EST on December 31, 2007.

Register For A Chance To

**WIN**

- A Shop Full Of FESTOOL Tools – Over \$3,000 Value!
- Round Trip Airfare To Las Vegas, NV
- 4 Days, 3 Nights Stay In Las Vegas, NV
- An Exclusive 2 Day FESTOOL Training Session Usually Reserved For Dealers!

To Register: Go To [woodcraft.com/fantasycamp](http://woodcraft.com/fantasycamp)  
Visit A Store Or Call 800-225-1153

QUALITY WOODWORKING TOOLS • SUPPLIES • ADVICE®

Circle No. 700

## Ask WOOD



### Give boards a feather touch

**Q:** I want to make feather boards from scrapwood. Does grain direction matter? Should I use hardwood or softwood? Is plywood effective? What is a good feather length and board size?

—Russ Gastright, Highland Heights, Ky.

**A:** Most hardwoods will work, with closed-grain woods such as maple, cherry, and walnut being especially good choices, Russ. That's because these woods can be cut into thin sections and remain springy without breaking. But avoid sheet goods. Cross-plies and voids make thin plywood feathers unpredictable, and MDF feathers lack hardwood's rigidity.

The width of the feather board—usually 2" to 4"—and the length of the kerfs can be customized to suit how much pushing pressure you need to control workpieces on your table saw or router table. Start by bandsawing kerfs 2½" long in ¾" stock where the end has been cut at a 30° angle. For kerfs in hardwoods, always cut with the grain. If the feathers are too short to flex as workpieces slide past, lengthen the kerf to around 4". Be careful to not make feather boards or feathers so wide that they push your fence out of alignment. All you need is to duplicate the fingertip pressure your hands would provide.

### HAVE A QUESTION?

For an answer to your woodworking question, write to **ASK WOOD, 1716 Locust St., LS-221, Des Moines, IA 50309-3023** or e-mail us at [askwood@woodmagazine.com](mailto:askwood@woodmagazine.com). For immediate feedback from your fellow woodworkers, post your questions on one of our woodworking forums at [woodmagazine.com/forums](http://woodmagazine.com/forums).

**THIS IS YOUR BODY ON  
RADIANT HEAT  
ANY QUESTIONS?**

VISIT OUR WEBSITE

CALL FOR A  
FREE QUOTE

**RADIANT**  
Floor Company

Compatible with any fuel source:  
GAS PROPANE SOLAR OIL WOOD ELECTRIC GEOTHERMAL

[www.radiantcompany.com](http://www.radiantcompany.com)  
Barton, Vermont  
(toll free) 1.866.WARM-TOES (927.6863)

Circle No. 1301

# What's Ahead

A sneak peek inside the March issue (on sale January 15)

## FEATURED PROJECT



### Country hutch

This classic piece matches the drop-leaf table on *page 58*. You can build just the bottom for a buffet if you wish.



### Bunching tables

Build one or more of this eye-catching project and choose a top to match your decor.



### Basic-Built tool stand

Make this sturdy workstation using just 2x4s, MDF, and perforated hardboard.



### "Impossible" puzzles explained

Puzzle-maker Perry McDaniel shows you how to build two simple but amazing puzzle boxes.



## TOOL TEST

### Dust collectors

We analyze 16 leading two-bag versions so you'll know which to buy.

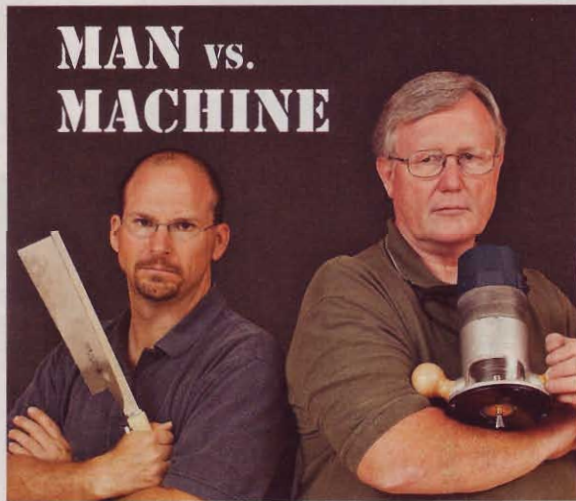

### Dovetail showdown

Two of our experts go head-to-head to settle the question: Which is better: hand-cut or machine-cut dovetail joints?



### Super-simple frame-and-panel doors

Learn to make one in less time than it takes to watch your favorite 30-minute sitcom.

Better Homes and Gardens: WOOD® magazine (ISSN-0743-894X) is published seven times a year in March, May, July, September, October, November, and December/January by Meredith Corporation, 1716 Locust St., Des Moines, IA 50309-3023. Periodicals postage paid at Des Moines, Iowa, and additional mailing offices. Better Homes and Gardens trademark registered in Canada and Australia. Marca Registrada en México. One-year subscription prices: U.S. and its possessions, \$28; Canada, \$41; other countries, \$49. Canada Post Publications Mail Sales Product Agreement No. 40069223. Canadian BN 12348 2887 RT. Return undeliverable Canadian addresses to: Better Homes and Gardens WOOD magazine, P.O. Box 37439, Boone, IA 50037-4439.