

Super-Simple  
Spray-Finishing! p.22

# WOOD

## Build Your Own Cabinets

*The Easy Way!*

### Plus Great Projects

- Shop-in-a-Box p.32
- Corner Curio p.38
- Dry Sink p.54
- Turned Bowl p.49
- Dinosaur Puzzle p.70

### No-Fuss Dowel Joints p.18



**63**  
Shop Tips  
Inside!

### How To Install Drawer Slides Easily p.72

Display until March 15, 2011

0 192567 14072 5

\$6.99 U.S.



# Grizzly Industrial

Purveyors of Fine Machinery®, Since 1983

**New!**



### 10" HYBRID TABLE SAW

**BEAUTIFUL WHITE COLOR!**

- Motor: 2 HP, 110V/220V, single-phase
- Precision ground cast iron table with wings measures: 27" x 40"
- Arbor: 5/8" • Arbor speed: 3850 RPM
- Capacity: 3 1/8" @ 90°, 2 3/16" @ 45°
- Rip capacity: 30" R, 12" L
- Quick change riving knife
- Cast iron trunnions
- Approx. shipping weight: 354 lbs.

INCLUDES BOTH REGULAR & DADO BLADE INSERTS

**G0715P** INTRODUCTORY PRICE **\$765<sup>00</sup>** **\$89** ANYWHERE IN LOWER 48 STATES

**New!**



### 17" HEAVY-DUTY BANDSAW

**BEAUTIFUL WHITE COLOR!**

- Motor: 2 HP, 110V/220V, single-phase, TEFC
- Precision ground cast iron table size: 17" sq.
- Table tilt: 10° L, 45° R
- Cutting capacity/throat: 16 1/4"
- Max. cutting height: 12 1/8"
- Blade size: 13 1/2" L (1/8" - 1" W)
- Blade speeds: 1700 & 3500 FPM
- Quick release blade tension lever
- Approx. shipping weight: 342 lbs.

INCLUDES DELUXE EXTRUDED ALUMINUM FENCE, MITER GAUGE & 1/2" BLADE

**G0513P** INTRODUCTORY PRICE **\$795<sup>00</sup>** **\$89** ANYWHERE IN LOWER 48 STATES

ALSO AVAILABLE  
**G0513** H-D 17" BANDSAW \$850.00 **ONLY \$795<sup>00</sup>**

### 10" LEFT-TILTING CONTRACTOR-STYLE TABLE SAW with Riving Knife

- Motor: 1 1/4 HP, 110V/220V, single-phase
- Precision ground cast iron table w/wings
- Table size: 27" x 44" • Arbor: 5/8"
- Arbor speed: 4200 RPM
- Capacity: 3 1/8" @ 90°, 2 1/4" @ 45°
- Rip capacity: 36" R, 12" L • Approx. shipping weight: 342 lbs.

FREE 10" CARBIDE-TIPPED BLADE



CAST IRON TRUNNIONS & CAST IRON MITER GAUGE

MADE IN ISO 9001 FACTORY!

**G0713** INTRODUCTORY PRICE **\$850<sup>00</sup>** **\$89** ANYWHERE IN LOWER 48 STATES

### 10" LEFT-TILTING TABLE SAWS with Riving Knife & Cast Iron Router Table

- Motor: 3 HP or 5 HP, 220V, single-phase
- Precision ground cast iron table size with wings: 27" x 48"
- Arbor: 5/8"
- Cutting capacity: 25 5/8" R, 8" L
- Max. depth of cut: 3" @ 90°, 2 1/8" @ 45°
- Approx. shipping weight: 546 lbs.

FREE 10" CARBIDE-TIPPED BLADE



**G1023RLW** 3 HP **ONLY \$1175<sup>00</sup>**  
**G1023RLWX** 5 HP **ONLY \$1295<sup>00</sup>**

**\$139** ANYWHERE IN LOWER 48 STATES

### 10" CABINET TABLE SAW with Riving Knife & Extension Rails

- Motor: 3 HP, 220V, single-phase
- Precision ground cast iron table
- Table size with extension: 27" x 74 3/4"
- Arbor: 5/8" • Arbor speed: 4300 RPM
- Max. depth of cut: 3 1/8" @ 90°, 2 1/8" @ 45°
- Max. rip capacity: 50"
- Max. dado width: 1 3/16"
- Approx. shipping weight: 572 lbs.

3 HP LEESON® MOTOR!



**G0691** **ONLY \$1350<sup>00</sup>**

FREE 10" CARBIDE-TIPPED BLADE

**\$139** ANYWHERE IN LOWER 48 STATES

MADE IN ISO 9001 FACTORY!

### 14" BANDSAW

- Motor: 3/4 HP, 110V/220V, single-phase, TEFC
- Precision ground cast iron table size: 14" sq.
- Table tilt: 15° L, 45° R
- Cutting capacity/throat: 13 1/2"
  - Max. cutting height: 6"
  - Blade size: 92 1/2" - 93 1/2" L (1/8" - 3/4" W)
- Blade speed: 3000 FPM
- Cast iron frame
- Steel open frame stand
- Approx. shipping weight: 165 lbs.

CAN BE PLUGGED INTO ANY STANDARD HOUSEHOLD OUTLET



**G0580** **ONLY \$395<sup>00</sup>** **\$69** ANYWHERE IN LOWER 48 STATES

### ULTIMATE 14" BANDSAW

- Motor: 1 HP, 110V/220V, single-phase, TEFC
- Precision ground cast iron table size: 14" sq.
- Table tilt: 10° L, 45° R
- Cutting capacity/throat: 13 1/2"
  - Max. cutting height: 6"
  - Blade size: 92 1/2" - 93 1/2" L (1/8" - 3/4" W)
- Blade speeds: 1500 & 3200 FPM
- Approx. shipping weight: 196 lbs.

MADE IN ISO 9001 FACTORY!



**G0555P** INTRODUCTORY PRICE **\$425<sup>00</sup>** **\$69** ANYWHERE IN LOWER 48 STATES

### 19" HEAVY-DUTY EXTREME SERIES BANDSAW

- Motor: 3 HP, 220V, single-phase, TEFC
- Precision-ground cast iron table size: 26 3/4" x 19"
- Table tilt: 5° L, 45° R
- Cutting capacity/throat: 18 1/4"
- Max. cutting height: 12"
  - Blade size: 143" L (1/8" - 1 1/4" W)
  - Blade speeds: 1700 & 3500 FPM
- Approx. shipping weight: 460 lbs.

DELUXE RE-SAW FENCE INCLUDED

MADE IN ISO 9001 FACTORY!



**G0514X** **ONLY \$1250<sup>00</sup>** **\$89** ANYWHERE IN LOWER 48 STATES

13364

PRICING CODE  
**11WOODM**

MENTION THIS CODE WHEN PLACING YOUR ORDER

**1-800-523-4777**

TECHNICAL SERVICE:  
570-546-9663  
FAX: 800-438-5901



3 GREAT SHOWROOMS! BELLINGHAM, WA • MUNCY, PA • SPRINGFIELD, MO

NOW SHIPPING TO CANADA!



EXCELLENT BROKERAGE RATES! SEE GRIZZLY.COM FOR DETAILS

- OVER A MILLION SQUARE FEET PACKED TO THE RAFTERS WITH MACHINERY & TOOLS
- 2 OVERSEAS QUALITY CONTROL OFFICES STAFFED WITH QUALIFIED GRIZZLY ENGINEERS
- HUGE PARTS FACILITY WITH OVER 1 MILLION PARTS IN STOCK AT ALL TIMES
- TRAINED SERVICE TECHNICIANS AT ALL 3 LOCATIONS
- 24 HOUR ORDERING BY PHONE OR ONLINE • MOST ORDERS SHIP THE SAME DAY

Product Reviews & Awards ONLINE grizzly.com



### 12" JOINTER/PLANER COMBINATION MACHINE

New!

BEAUTIFUL WHITE COLOR!

- Motor: 5 HP, 220V, single-phase
- Jointer table size: 14" x 59 1/2"
- Cutterhead dia.: 3 1/8"
- Cutterhead speed: 5034 RPM
- Max. jointer depth of cut: 1/8"
- Max. width of cut: 12"
- Planer feed rate: 22 FPM
- Max. planer depth of cut: 1/8"
- Max. planer cutting height: 8"
- Planer table size: 12 1/4" x 23 1/8"
- Approx. shipping weight: 734 lbs.

NEW END-MOUNTED FENCE



CARBIDE INSERT SPIRAL CUTTERHEAD!



FREE SAFETY PUSH BLOCKS

\$139 ANYWHERE IN LOWER 48 STATES

G0634XP INTRODUCTORY PRICE \$2195.00

ALSO AVAILABLE G0633 JOINTER/PLANER \$1995.00 ONLY \$1795.00

G0634Z SPIRAL CUTTERHEAD MODEL \$2495.00 ONLY \$2295.00



### CYCLONE DUST COLLECTOR

BEAUTIFUL WHITE COLOR!

- Motor: 1 1/2 HP, 110/220V, single-phase, TEFC, 3450 RPM
- Air suction capacity: 775 CFM
- Static pressure at rated CFM: 1.08"
- Intake port: 6" with included 5" optional port
- Impeller: 13 1/2"
- Height: 68 1/2"
- Built-in remote control switch
- Approx. shipping weight: 210 lbs.

New!

ONLY 68 1/2" TALL!

PLEATED FILTER IS PROTECTED BY A STEEL CAGE



FULLY MOBILE WITH BUILT-IN CASTERS

\$69 ANYWHERE IN LOWER 48 STATES



G0703P INTRODUCTORY PRICE \$695.00



### 8" JOINTERS

- Motor: 3 HP, 220V, single-phase, TEFC
- Precision ground cast iron table size: 9" x 72 1/2"
- Max. depth of cut: 1/8"
- Max. rabbeting depth: 1/2"
- Cutterhead dia.: 3"
- Cutterhead speed: 5000 RPM
- Cuts per minute: 20,000
- Approx. shipping weight: 500 lbs.

New!

FREE SAFETY PUSH BLOCKS

BUILT-IN MOBILE BASE



CHOOSE EITHER 4 HSS KNIVES OR SPIRAL CUTTERHEAD MODEL

G0656P INTRODUCTORY PRICE \$775.00

WITH SPIRAL CUTTERHEAD G0656PX INTRODUCTORY PRICE \$1075.00

\$139 ANYWHERE IN LOWER 48 STATES

### 12" x 60" SHORT BED JOINTER with Spiral Cutterhead

- Motor: 3 HP, 220V, single-phase, TEFC
- Precision ground cast iron table size: 13" x 60"
- Fence: 5 3/8" x 31 1/4"
- Cutterhead dia.: 3 3/4"
- Cutterhead speed: 4,950 RPM
- Bevel jointing: 45°, 90°, 135°
- Max. depth of cut: 3/8"
- Approx. shipping weight: 832 lbs.

MADE IN ISO 9001 FACTORY!

FREE SAFETY PUSH BLOCKS



PARALLELOGRAM TABLE ADJUSTMENT

G0706 ONLY \$2195.00

\$169 ANYWHERE IN LOWER 48 STATES



### 15" PLANERS

New!

- Motor: 3 HP, 220V, single-phase
- Precision ground cast iron table size: 15" x 20"
- Min. stock thickness: 3/16"
- Min. stock length: 8"
- Max. cutting depth: 1/8"
- Feed rate: 16 FPM & 30 FPM
- Cutterhead speed: 5000 RPM
- Approx. shipping weight: 660 lbs.

BUILT-IN MOBILE BASE



CHOOSE EITHER 3 KNIFE OR SPIRAL CUTTERHEAD MODEL

G0453P INTRODUCTORY PRICE \$995.00

WITH SPIRAL CUTTERHEAD G0453PX INTRODUCTORY PRICE \$1475.00

\$139 ANYWHERE IN LOWER 48 STATES

### 10" DRUM SANDER

New!

- Motor: 1 1/2 HP, 110V, single-phase
- Conveyor motor: 1/10 HP
- Drum speed: 2300 FPM
- Drum size: 5 1/8" x 10"
- Max. sanding width: 10"
- Max. workpiece height: 2 5/16"
- Min. workpiece height: 3/16"
- Variable feed speeds: 1-10 FPM
- 4" dust port
- Approx. shipping weight: 220 lbs.

WHEELS & STOWABLE TRANSPORT HANDLES FOR MOBILITY

REMOVABLE HEADSTOCK SUPPORT BRACKET ALLOWS SANDING UP TO 20"



G0716 INTRODUCTORY PRICE \$345.00

\$69 ANYWHERE IN LOWER 48 STATES

### 15" DISC SANDER with Stand

New!

- Motor: 1 1/2 HP, 220V, single-phase, 1720 RPM
- Cast iron sanding disc size: 15"
- Cast iron table size: 12" x 20"
- Table tilt: 0 - 45°
- Floor to table height: 37 5/8"
- Dust port: 2 1/2"
- Approx. shipping weight: 232 lbs.

MADE IN TAIWAN

INCLUDES MITER GAUGE

FEATURES BUILT-IN MOTOR BRAKE & STORAGE CABINET WITH SHELF



G0719 INTRODUCTORY PRICE \$795.00

\$69 ANYWHERE IN LOWER 48 STATES

### 1 HP WALL MOUNT DUST COLLECTOR

- Motor: 1 HP, 110V/220V, single-phase
- Amps: 14/7
- Intake size: 4"
- Bag size (dia. x depth): 13 1/2" x 24"
- Balanced steel, radial fin impeller
- Air suction capacity: 450 CFM
- Max. static pressure: 7.2"
- Approx. shipping weight: 51 lbs.

SPECIAL WALL MOUNT DESIGN!

New!



EASY MOUNTING WALL BRACKET & LOCKING THUMB SCREW SECURES DUST COLLECTOR IN PLACE!



G0710 ONLY \$169.95



FREE 2011 CATALOG! THOUSANDS OF HIGH QUALITY MACHINES & TOOLS

grizzly.com

OVER 12,000 PRODUCTS ONLINE!





54

## PROJECTS

- 32 "Shop-In-A-Box" Compact Tool Storage
- 28 Pocket-Hole Jig Organizer & Base
- 38 Corner Curio Cabinet
- 54 Easy-To-Build Dry Sink
- 70 Scrollsawn Dinosaur Puzzle

## SKILL BUILDERS

- 18 Joinery: Making the Most of Dowels
- 22 Small-Scale, Affordable Spray Finishing
- 49 How to Turn a Green-Wood Bowl
- 54 **On the Cover:** Build Cabinets and Save
- 72 Drawer-Slide Mounting Made Easy

## TOOLS & MATERIALS

- 66 **Shop Test: Oscillating Multi-Function Tools**  
Discover which of these tools will saw, sand, and scrape best in your wood shop.
- 82 **Shop-Proven Products**  
Compact cyclone, carbide planer knives, and more.

## DEPARTMENTS

- 6 Editor's Angle
- 8 Sounding Board
- 10 Shop Tips
- 76 Ask *WOOD*
- 92 What's Ahead



66



32



49



18



72



38

This seal is your assurance that we build every project, verify every fact, and test every reviewed tool in our workshop to guarantee your success and complete satisfaction.



22

### “LIKE” WOOD’S PAGE ON FACEBOOK



Visit [facebook.com/woodmagazine](http://facebook.com/woodmagazine) and click on the “like” button near the top of the page. It’s the fastest and easiest way to learn about the latest videos and tool reviews at [woodmagazine.com](http://woodmagazine.com). You’ll also get discounts on downloadable *WOOD* magazine project plans.



### 110 HANDY HELPERS AND IDEA-STARTERS

- 10 Tablesaw Tips and Tricks: [woodmagazine.com/tstricks](http://woodmagazine.com/tstricks)
- 12 Tested Tips for Turners: [woodmagazine.com/turningtips](http://woodmagazine.com/turningtips)
- 9 Savvy Finishing Solutions: [woodmagazine.com/savvyfinish](http://woodmagazine.com/savvyfinish)
- 10 Shop Set-up Solutions: [woodmagazine.com/setupsolutions](http://woodmagazine.com/setupsolutions)
- 10 Top Tips for Dust Collection: [woodmagazine.com/topdctips](http://woodmagazine.com/topdctips)
- 10 Tips to Sanding Success: [woodmagazine.com/sandingsuccess](http://woodmagazine.com/sandingsuccess)
- 12 Hardware Installation Tips: [woodmagazine.com/hardwaretips](http://woodmagazine.com/hardwaretips)
- 11 Gluing and Clamping Tricks: [woodmagazine.com/clampingtricks](http://woodmagazine.com/clampingtricks)
- 12 Projects by Woodworking’s Greatest: [woodmagazine.com/wwg1](http://woodmagazine.com/wwg1)
- 14 Must-Have Marking & Measuring Tools: [woodmagazine.com/meastools](http://woodmagazine.com/meastools)



Larry Berger  
Livermore, Calif.

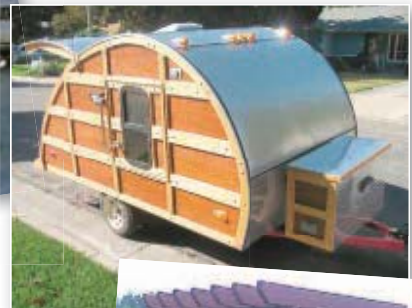

Ed Shaw  
Riverside, Calif.

### GET INSPIRED BEFORE YOU BUILD

Start planning this summer’s outdoor projects with a trip through the reader photo galleries at [woodmagazine.com/galleries](http://woodmagazine.com/galleries).

Tom Baxter  
Conway, Ark.



James Davis  
Kelso, Wash.





# INNOVATIVE PRODUCTS SINCE 1989!



SHOP FOX® machines are backed by a 2 Year Warranty!

## 10" TABLE SAWS with Riving Knife

- 3 HP, 220V, single-phase motor
- Cast iron table size: 27" x 40 1/4"
- Max. rip capacity: (W1819) 29 1/2", (W1820) 50"



Free 10" Carbide-Tipped Blade

- W1819** 10" Table Saw
- W1820** 10" Table Saw w/Long Ext. Table



## SLIDING TABLE and ROUTER TABLE ATTACHMENTS for W1819 & W1820



SAW NOT INCLUDED

### W1821

SLIDING TABLE ATTACHMENT

- Industrial grade anodized aluminum table size: 47" x 9"
- Max. cross cut: 48"

### W1822

ROUTER TABLE ATTACHMENT

- Precision ground cast iron table size: 27" x 20"
- Universal router mount



## 3 HP LOW PROFILE CYCLONE DUST COLLECTOR

- Motor: 3 HP, 220V, single-phase, TEFC class "F", 3450 RPM
- Air suction capacity: 1489 CFM
- Filter: 0.2-2 microns
- 55 gal. steel collection drum with casters



Only 80" Tall!

- W1816** Cyclone Dust Collector

## VARIABLE SPEED PLANER/MOULDER with Stand

- Motor: 2 HP, 220V, single-phase
- Precision ground cast iron table with wings: 36 1/4" L x 10" W
- Max. cutting width: 7"
- Max. planing height: 7 1/2"
- Max. moulding depth: 3/4"



We also carry an extensive selection of moulding knives for this machine!

- W1812** Planer/Moulder

## 10" SLIDING TABLE SAW



- 5 HP, 220V, single-phase motor
- Precision ground cast iron table measures 47" x 40" with extension
- Sliding table measures 63" x 12 1/4"

BLADES NOT INCLUDED

### W1811

10" Sliding Table Saw

Scoring blade eliminates cross grain tearout!

## 8" JOINTER with Parallelogram Adjustable Beds

- 3 HP, 220V, single-phase, TEFC motor
- Precision ground cast iron parallelogram design table measures 8" x 76 5/16"
- Cutterheads: (W1741) 4 HSS knives (W1741S) spiral



Built-in Mobile Base

- W1741** 8" Jointer
- W1741S** with Spiral Cutterhead

## OUTSTANDING SHOP FOX® ACCESSORIES



### ADJUSTABLE MOBILE BASES

STRONGER FRAME WITH IMPROVED WHEELS AND GUSSETED SUPPORTS!

- D2260A** Mini Mobile Base 600 lb. capacity
- D2057A** Heavy-Duty Mobile Base 700 lb. capacity
- D2058A** Super Heavy-Duty Mobile Base 1300 lb. capacity
- D2259A** Extension Kit (fits all models)
- D2246A** 36" Extension Bars (fits all models)

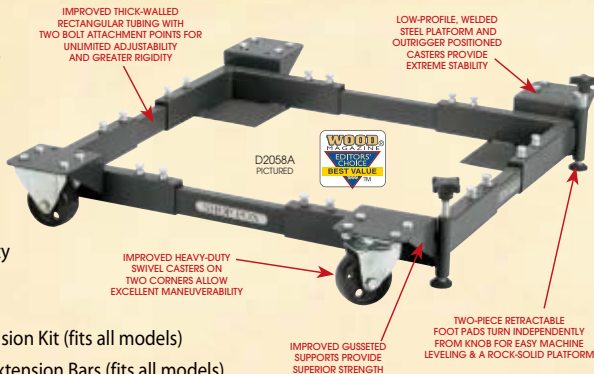

### JOINTER PAL® MAGNETIC KNIFE SETTING JIG

Set jointer knives in perfect alignment every time!

- W1210** Polycarbonate jig for 4" - 8" jointers w/HSS knives
- W1211** Steel jig for 4" - 8" jointers w/HSS knives
- W1212** Carbide jig for 4" - 8" jointers w/carbide or HSS knives
- W1227** Carbide jig for 8" - 14" jointers w/carbide or HSS knives
- W1228** Carbide jig for 12" - 18" jointers w/carbide or HSS knives



### Aluma-Classic® FENCE

Extruded Aluminum & Steel Construction Precision Right Angle Design

- W1716** Aluma-Classic® Fence w/standard 57" rails
- W1720** Aluma-Classic® Fence w/long 79" rails & legs (50" cutting capacity)
- W1721** 79" rails & legs (fence not included)
- W1722** Set of 3 powder coated sheet metal wings



WOODSTOCK INTERNATIONAL, INC. IS ALSO HOME TO THESE OTHER FINE BRANDS:

STEELEX®, PRO-STICK®, PLANER PAL®, JOINTER PAL®, BOARD BUDDIES®, PARROT VISE®, ROMAN CARBIDE® ROUTER BITS AND SHAPER CUTTERS.

VISIT OUR WEBSITE OR CALL TOLL FREE TO FIND AN AUTHORIZED DEALER NEAR YOU.

# SHOPFOX.BIZ

sales@shopfox.biz WHOLESALE ONLY



# 1-800-840-8420

SHOP FOX® is a registered trademark of Woodstock International, Inc.

Better Homes and Gardens®  
**WOOD**

woodmagazine.com

March 2011

Vol. 28, No. 1

Issue No. 203

**What's your fondest memory as a young and aspiring woodworker?**

Cutting out Christmas ornaments on the bandsaw with my dad. That really got me hooked on woodworking.

Making a walnut wall shelf that went to the state fair for a 4-H project.

EDITOR-IN-CHIEF  
**BILL KRIER**

Managing Editor <b>MARLEN KEMMET</b>	Deputy Editor <b>DAVE CAMPBELL</b>
Senior Design Editor <b>KEVIN BOYLE</b>	Art Director <b>KARL EHLERS</b>
Projects Editor <b>CRAIG RUEGSEGGER</b>	Tools Editor <b>BOB HUNTER</b>
How-To Editor <b>LUCAS PETERS</b>	Associate Art Director <b>GREG SELLERS</b>
Administrative Assistant <b>SHERYL MUNYON</b>	Production/Office Manager <b>MARGARET CLOSNER</b>



Working with my dad, especially the time we made a scrap-lumber boot jack I still have.

Photographers **JASON DONNELLY, SCOTT LITTLE, JAY WILDE**  
 Contributing Illustrators **TIM CAHILL, LORNA JOHNSON, ROXANNE LeMOINE**  
 Technical Consultants **BOB BAKER, ERV ROBERTS, DOUG HICKS**  
 Contributing Craftsman **JIM HEAVEY**  
 Proofreaders **BABS KLEIN, IRA LACHER, JIM SANDERS**

**Doug Hicks:**  
When my father let me use his table saw unsupervised (in the days before safety guards!)



When I was in high school, a man offered me \$400 for a cedar chest I'd made. That experience gave me confidence in my abilities.

Publisher **MARK L. HAGEN**  
**ADVERTISING AND MARKETING**

**CHICAGO:** 333 N. Michigan Ave., Suite 1500, Chicago, IL 60601  
 Advertising Manager **JACK CHRISTIANSEN**  
 Direct Response Advertising Representative **LISA GREENWOOD**  
 Account Executive **KEVIN BARRY**

**ATLANTA:** Navigate Media  
**DETROIT:** RPM Associates

Business Manager **JEFF STILES**  
 Consumer Marketing Director **TODD BIERLE**  
 Retail Brand Manager-Newsstand **JESS LIDDLE**  
 Production Manager **SANDY WILLIAMS**  
 Advertising Operations Manager **JIM NELSON**  
 E-Commerce Manager **MATT SNYDER**

Vice President/Group Publisher **TOM DAVIS**

**MEREDITH NATIONAL MEDIA GROUP**

President **TOM HARTY**

**EXECUTIVE VICE PRESIDENTS**

President, Consumer Brands **ANDY SAREYAN**

President, Meredith Integrated Marketing **MARTIN F. REIDY**

Chief Marketing Officer **NANCY WEBER**

Consumer Relationship Management and Digital Media **LIZ SCHIMEL**

Chief Revenue Officer **MICHAEL BROWNSTEIN**

Chief Innovation Officer, Meredith 360° **JEANNINE SHAO COLLINS**

General Manager **MIKE RIGGS**

Director Operations & Business Development **DOUG OLSON**

**SENIOR VICE PRESIDENTS**

Consumer Marketing **DAVID BALL**

Editorial Director, Des Moines **GAYLE GOODSON BUTLER**

Editorial Director, New York **SALLY LEE**

Meredith Women's Network **LAUREN WIENER**

Chief Technology Officer **JACK GOLDENBERG**

Group Publisher **JAMES CARR**

Group Publisher **CAREY WITMER**

**VICE PRESIDENTS**

Corporate Sales **BRENDAN SMYTH**

Direct Media & Travel Marketing **PATTI FOLLO**

New Media & Marketing Services **ANDY WILSON**

Research Solutions **BRITTA WARE**

Communications **PATRICK TAYLOR**

Newsstand **DAVID ALGIRE**

Production **BRUCE HESTON**



Chairman and Chief Executive Officer **STEPHEN M. LACY**

Vice Chairman **MELL MEREDITH FRAZIER**

**In Memoriam — E.T. Meredith III (1933–2003)**

Our subscribers list is occasionally made available to carefully selected firms whose products may be of interest to you. If you prefer not to receive information from these companies by mail or by phone, please let us know. Send your request along with your mailing label to Magazine Customer Service, P.O. Box 37452, Boone, IA 50037-0452.

© Copyright Meredith Corporation 2011. All rights reserved. Printed in the U.S.A.

Retail Sales: Retailers can order copies of WOOD for resale by e-mailing [jennifer.buser@meredith.com](mailto:jennifer.buser@meredith.com)

**SUBSCRIBER SERVICE**

Go to [woodmagazine.com/help](http://woodmagazine.com/help) or write to WOOD magazine, P.O. Box 37439, Boone, IA 50037-0439



**325**  
**Easy-to-Build**  
**Projects!**  
on a space-saving CD-ROM



**Super-high resolution!**

from the Editors of **WOOD** Magazine

**Fully-indexed, searchable and printable.**

*Weekend Woodworking Projects* magazine focused on beautiful projects that could be built with a minimal investment in time, tools, and materials. All projects have been built and proven in the *WOOD* magazine workshop, so you know you can rely on the plans. Back issues of *Weekend Woodworking Projects* are nearly impossible to find anywhere, but this disc makes all of these projects available once again—at a price of only **15 cents per plan!**

See a sample of the projects and order this disc at [woodmagazine.com/WeekendCD](http://woodmagazine.com/WeekendCD)

Or order by phone:  
**888-636-4478**

## Editor's Angle

# Show me the Money!

You've asked us to list the cost of project materials. Starting with this issue, we're doing just that.

**A**lthough many of us took up woodworking as a way to save money, today, most of us build projects purely for the satisfaction of creating something that will last generations, and the pleasure of seeing others enjoy our creations. Still, money matters. No wonder so many of you have asked us to list the cost of materials in the front of project articles. Understandably, you want to know how much to budget before you buy that first board.

We hear you. In this issue, we list our total material cost of larger, costlier projects, such as the corner curio on page 38. There, you'll see that we spent about \$420 to build it with mirrors—you *might* spend about \$380 to make it with wood panels in place of the mirrors. I stress the word *might* because the cost of materials varies widely depending on where and how you obtain them.

For example, if you're resourceful enough to harvest and dry your own lumber, or salvage it from a torn-down structure, the material costs could drop by up to half. Likewise, using a less-expensive wood than cherry also lowers costs. Let's say you live in an area where a local mill sells boards for less than we pay at our nearby hardwood retailer—again, you save.

So please remember that the costs we show are only ballpark estimates. Your

costs can—and certainly will—differ from ours.

I'll be honest with you: Our staff debated long and hard about whether to include these costs. Some were concerned that the expenses would be a turn-off, or that you might be frustrated if you can't find the materials for the same price we did. Ultimately, we decided that readers can't be too informed before embarking on a project. We don't skimp on helpful illustrations, photos, and instructions, so why turn a blind eye to costs?

Please let me know what you think about this new addition to our project articles. The easiest way to reach me is via e-mail at [bill.krier@meredith.com](mailto:bill.krier@meredith.com).

Bill Krier



Blotching happens when areas of varying wood density absorb liquid stain differently, resulting in an uneven stained surface.

ZAR®'s unique full-bodied formula holds the stain pigment in suspension and doesn't begin to penetrate the wood until it is wiped with a cloth. ZAR® does not over saturate the wood and provides rich, even color without streaks, lap marks or blotches.

ZAR® is ideal for all woods, veneers and for faux finishing non-wood surfaces.

For more information or a dealer near you visit [www.ugl.com](http://www.ugl.com) or call 1-800-272-3235





# Complete your Kreg Jig®

Check out these great accessories designed to help you get the most out of the handiest tool in your shop, the Kreg Jig®! Whether you want more precision, more speed, or just a few new project ideas, you'll find everything you need at the new and improved kregtool.com!

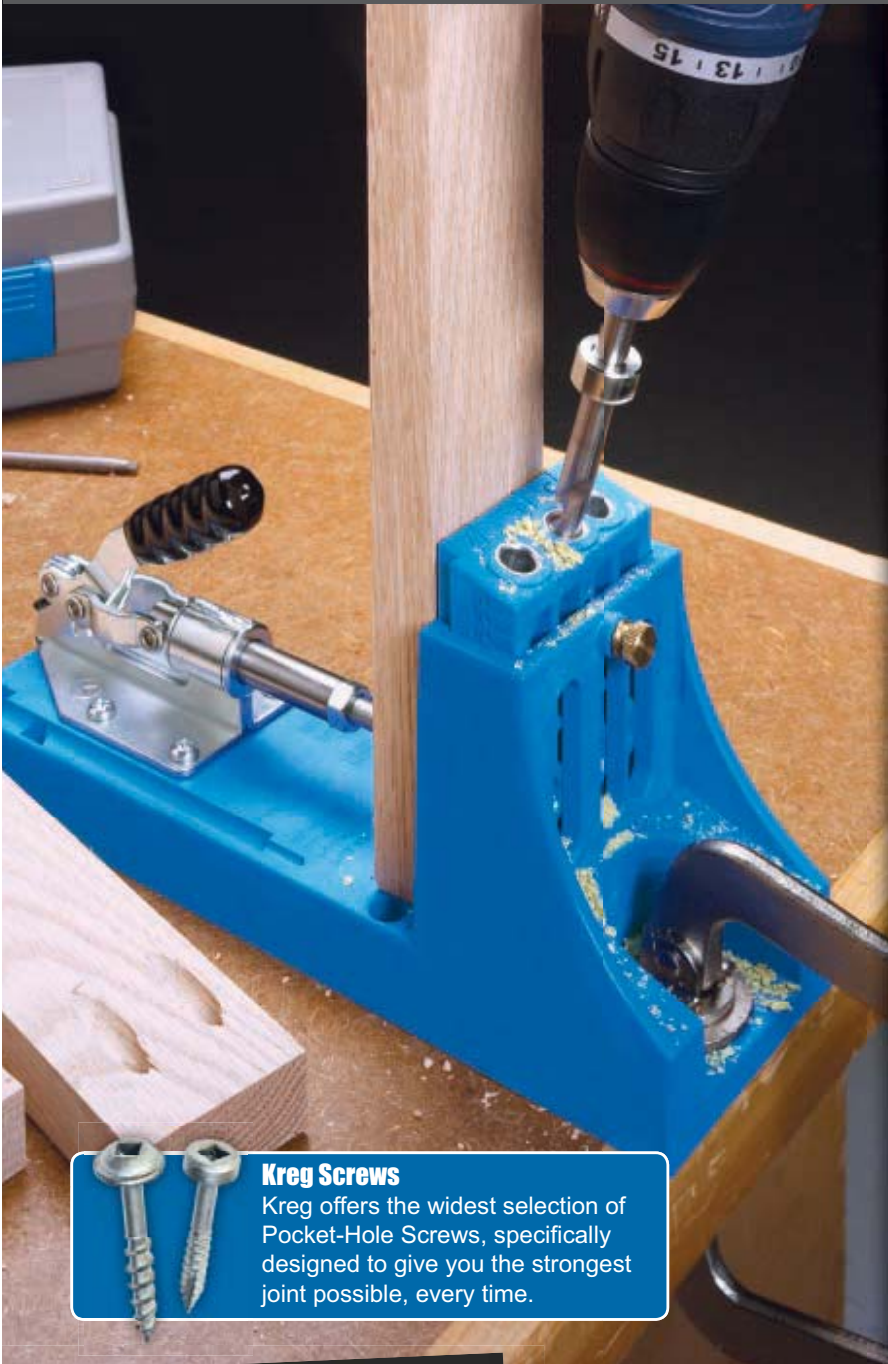

## Kreg Screws

Kreg offers the widest selection of Pocket-Hole Screws, specifically designed to give you the strongest joint possible, every time.



## Micro Pocket™ Drill Guide

Tackle 1/2" material with ease!  
Drills 25% smaller Pocket-Holes.  
Includes Drill Guide and Drill Bit.

\$49<sup>99</sup>



## Portable Base

Give your Kreg Jig® the power of 2-tools-in-1! Connects to most Kreg Face Clamps, for portable use.

\$19<sup>99</sup>



## Quick Change Kit

Quickly switch from drilling Pocket-Holes to driving Pocket-Screws, in just seconds. Includes chuck, Drill Bit, and Driver Bit.

\$29<sup>99</sup>



## Dust Collection Attachment

Faster Drill Strokes, longer bit life, and best of all... no clean up!

\$9<sup>99</sup>



## Material Support Stop

Repeat precise Pocket-Holes over and over, and support large panels with ease.

\$9<sup>99</sup>



## Clamps

Face Clamps, Corner Clamps, Bench Klamps; every type of clamp you need for Kreg Joinery™!

Prices Vary



Find your local dealer and download FREE project plans at the all new kregtool.com



www.kregtool.com | 800.447.8638

# Sounding Board

Our bulletin board for letters, comments, and timely updates

## What's a jewelry box without a ring?

I just wanted to thank you for putting the jewelry box plans in issue 195 (December/January 2009/2010). I built one just like it and used it in proposing marriage to my girlfriend, Kendra.

Here's how it happened. I set up a special table in advance at a restaurant with the finished jewelry box, flowers, and a card. When we arrived that evening, Kendra saw the jewelry box and realized it was a gift I'd made for her. But as she looked it over more closely and found the ring inside, I knelt down beside her and asked her to marry me. (She said yes! We've since gotten married.) This project will always have special meaning to us.

—Joseph Eberle II,  
Watertown, N.Y.



## Finger relief makes tape easier to grab and pull

I made the tape dispenser on page 24 of issue 200 (October 2010), but right away found it was difficult to grab the tape, which sagged below the high sides. So I altered the dispenser by eliminating the dowel and cutting away the sides, as shown at right, to form a pleasing curve.

—Richard Durgin, Vienna, Va.



## Sharpening technique helps reader see the light

I bought a card scraper 12 years ago, but could never get it to produce the fine shavings other craftsmen were getting with theirs. Even after seeing someone demonstrating a scraper at a woodworking show or reading an article, I could never, to my growing frustration, replicate their results.

But after reading the article on scraper-sharpening in issue 198 (July 2010, p. 28) of *WOOD*® magazine, I got my scraper out and tried again, following the steps as shown in the article. When I took it to a piece of wood, I was astounded that tiny curls sprang up with each push. Finally! Thank you for a great technique that really works. 🌲

—Joe Polich, Grapevine, Texas



Watch a FREE video showing how to sharpen a card scraper at [woodmagazine.com/cardscraper](http://woodmagazine.com/cardscraper)

## Please work safely

In order to show you precise details in photos, we frequently remove safety guards. In your work, be sure to use all safety devices, as well as wearing vision, breathing, and hearing protection.

—WOOD magazine editors

## HOW TO REACH US

### ■ For woodworking advice:

Post your woodworking questions (joinery, finishing, tools, turning, dust collection, etc.) on one of our online forums at [woodmagazine.com/forums](http://woodmagazine.com/forums).

### ■ To contact our editors:

Send your comments via e-mail to [woodmail@woodmagazine.com](mailto:woodmail@woodmagazine.com); or write to *WOOD* magazine, 1716 Locust St., LS-221, Des Moines, IA 50309.

### ■ Subscription assistance:

To notify us of an address change or to get help with your subscription, visit [woodmagazine.com/service](http://woodmagazine.com/service). Or write to *WOOD* magazine, P.O. Box 37439, Boone, IA 50037-0439. Please enclose your address label from a recent magazine issue.

### ■ To find past articles:

See our index at [woodmagazine.com/index](http://woodmagazine.com/index).

### ■ To order past issues and articles:

For past issues of *WOOD* magazine in print or on DVD-ROM, our newsstand-only issues, or downloadable articles, visit [woodmagazine.com/store](http://woodmagazine.com/store).

### ■ Updates to previously published projects:

For an up-to-date listing of changes in dimensions and buying-guide sources from issue 1 through today, go to [woodmagazine.com/editorial](http://woodmagazine.com/editorial).

Premier

FUSION

# HOW CAN THE BEST GENERAL PURPOSE SAW BLADE GET EVEN BETTER?

Item #P410

## Make It Available In Thin & Full Kerf Designs For Every Table & Chop Miter Saw!

Introducing the Premier Fusion saw blade in both Thin and Full Kerf design. Now woodworkers have a superior general purpose blade for both the table and chop miter saw in the shop and for the lower horsepower saw on the job site. The New Thin Kerf combines the advanced Premier Fusion features with a thinner kerf design to provide a flawless finish while reducing material waste, which makes it the ideal choice for lowered powered saws.

Freud's patent-pending Premier Fusion Saw Blade is the most technologically advanced blade on the market with a radical new "Fusion" tooth design that combines a double side grind with a 30 degree Hi-ATB to produce a glass-smooth, chip-free top and bottom surface while ripping and crosscutting.

The unique Fusion tooth design, combined with Freud-made TiCo™ Hi-Density Carbide, superior anti-vibration design and patented Perma-SHIELD® non-stick coating create the ultimate general purpose saw blade with flawless cutting performance.

Choose from four blades in the Full Kerf Premier Fusion series – 8", 10", 12" and 14" or try the new Thin Kerf 10" Premier Fusion. Use a Premier Fusion blade once and you'll be convinced.



Item #P410T



### Freud's Fusion Tooth Design vs. Others

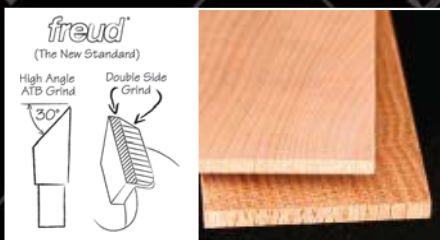

To sign up for Freud's e-mail newsletter or to find a dealer near you visit or call:

[www.freudtools.com](http://www.freudtools.com)  
1-800-472-7307

# freud®

Precisely the best.

# Shop Tips

Helping you work faster, smarter, and safer

## Top Shop Tip

### Varied curves from modified fairing sticks

As a high school science teacher, I often experiment in my shop. Recently, I found that varying the height of the traditional fairing stick, as shown in the photo *right*, creates irregular yet controllable curves. That's because the wider parts of the stick resist bending more, resulting in a broader curve there. The illustrations *below* show some fairing-stick shapes and their resulting curves.

The top stick, a traditional same-height fairing stick, results in the parabolic shape shown. But cut the stick wider in the center and you achieve a more circular curve—see second example. The third stick with a slight taper creates an irregular curve. And exaggerating that taper (fourth stick) increases the asymmetry. The variations are endless!

—*Tod Jervey, Powell, Ohio*



Photo: Jason Joseph Photography.net

To make short work of cutting curves, Tod receives Grizzly's G0555P 14" Bandsaw. Thanks for sending in this issue's Top Shop Tip, Tod!



Fairing sticks - FACE VIEW

Resulting curve - TOP VIEW

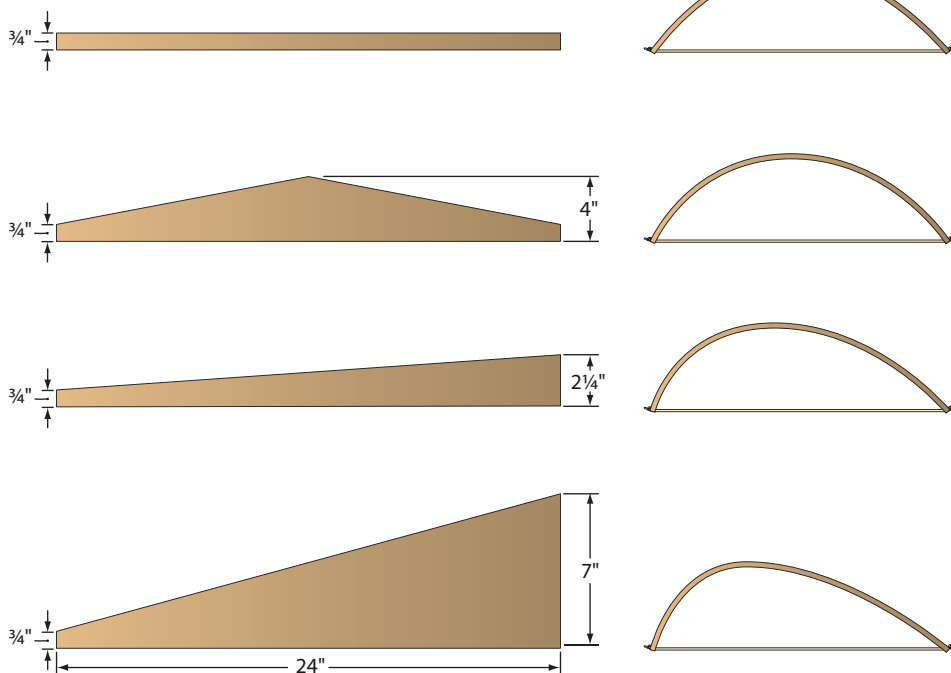

*continued on page 12*

## Your tips earn cash, tools!

Tell us how you've solved a workshop stumper. If we print it, you'll get \$100 and a copy of 450+ *Best-Ever Shop Tips* ([woodmagazine.com/450tips](http://woodmagazine.com/450tips)). And, if your idea garners Top Shop Tip honors, we'll also reward you with a tool prize worth at least \$300.

Send your best ideas, along with photos or drawings and your daytime phone number, to **Shop Tips, WOOD Magazine, 1716 Locust St., LS-221, Des Moines, IA 50309-3023**. Or, by e-mail: [shoptips@woodmagazine.com](mailto:shoptips@woodmagazine.com). Include your contact info in the e-mail.

Because we try to publish original tips, please send your tips only to WOOD® magazine. Sorry, submitted materials can't be returned.



# The Complete WOOD library on DVD-ROM!

Updated  
for 2011!

**What  
you get:**

**305**

Furniture Projects

**250**

Shop Projects

**920**

Weekend Projects

**570**

Tool Reviews

**1,625**

Shop Tips

**810**

Skill-building  
Techniques

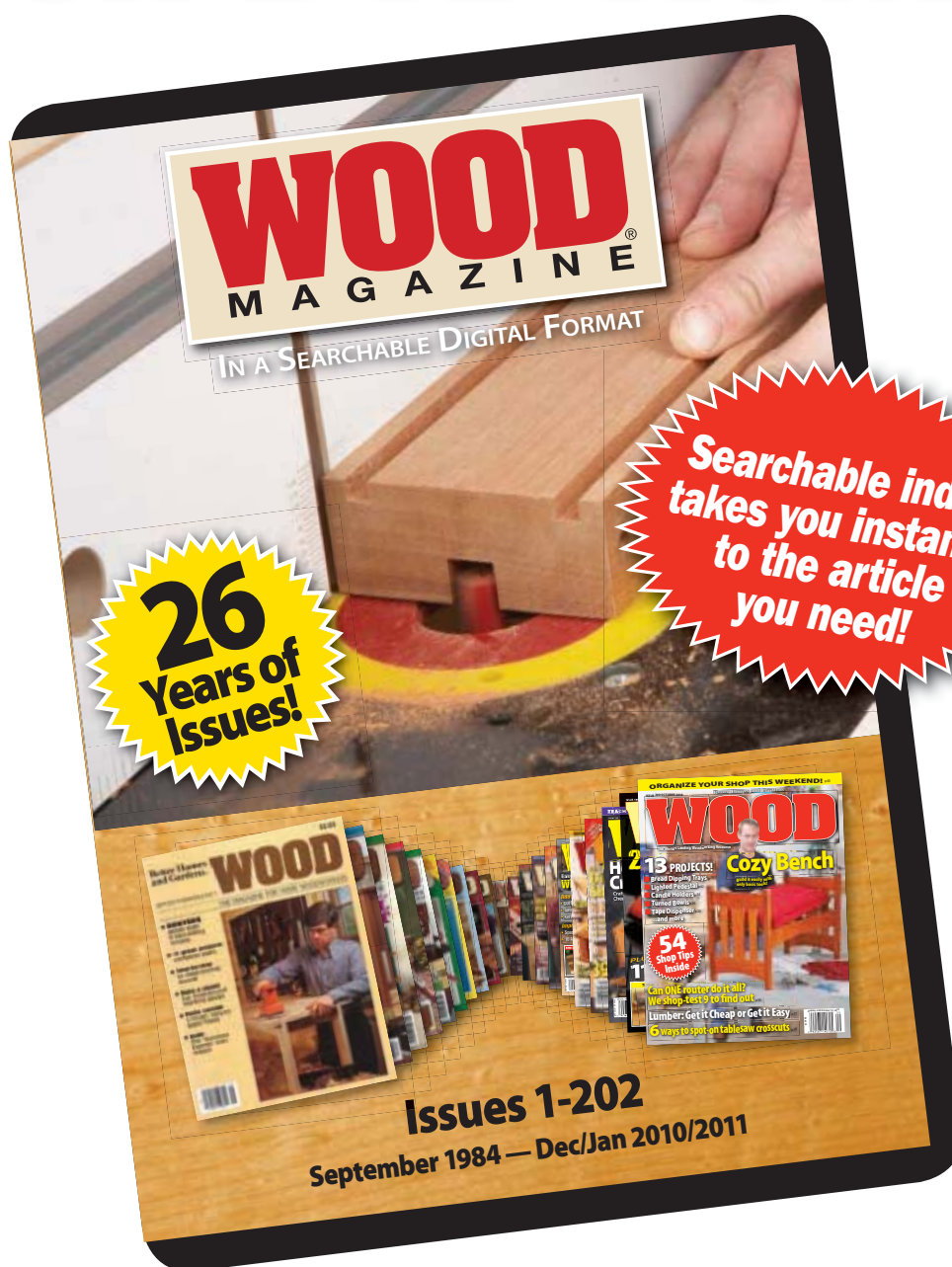

Order online at [woodmagazine.com/DVDlibrary](http://woodmagazine.com/DVDlibrary)  
or by phone at **888-636-4478**

*Special pricing for owners of the 25-year collection!*

## Shop Tips

### Simple subbase spaces shelf holes equally

Many shelf-pin hole jigs consist of a long board with a line of holes drilled into them: sometimes costly to buy, often time-consuming to make, and always a pain to store. But this router subbase solves all of those problems.

The shop-made subbase (I made mine out of 1/2" medium-density fiberboard) has a 1/4"-20 bolt that acts as an index pin. For shelf pin holes 1" apart, drill a 1/2" counterbore 3/16" deep on the face of the base, centered 1" from the center of the router collet; then a 1/4" hole completely through the subbase centered in the counterbore. Counter-sink the hole on the back of the subbase. Now, insert a 3/4" long 1/4"-20 flathead bolt, and secure it with a nut inserted in the counterbore. Mount the subbase to your router and install a 1/4" straight bit, set for a 1/4" plunge depth.

To use the jig, clamp a straightedge to the shelf side to position the bit the desired distance away from the edge of the case. With the base firmly against the straightedge, position the bolt

against the end of the case side and plunge the first hole. Slide the router over, positioning the bolt in the first hole. Keeping the router firmly against the straightedge, plunge the second

hole. Repeat the procedure, using each preceding hole to index the router for the next.

—Bas Plum, Cary, N.C.

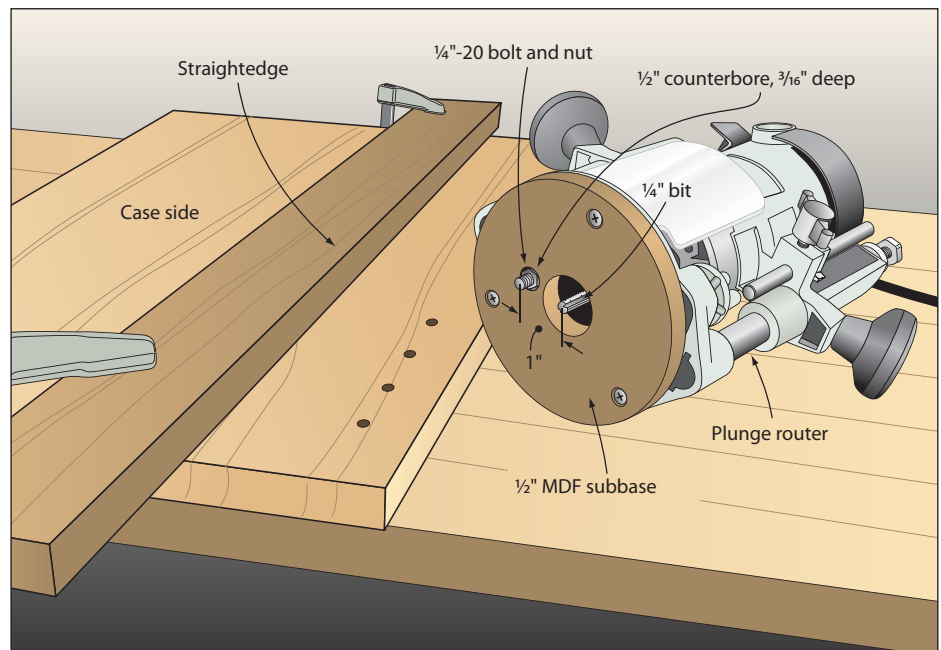

## A Natural Progression to...



**Diagnosis: Cord trouble.  
Prescription: Elevate it.**

For years, I've used my shoulder as a cord manager while routing or sanding. When I finally got tired of the cord slipping into the tool's path or catching on inconvenient corners, I built this cord minder. I drilled and cut a slot in the top, as shown, rounding over the inside edges to ease cord movement. With the cord minder clamped to the bench and the cord draped through the slot, the cord stays elevated and out of the way.

—Raj Chaudhry, New York

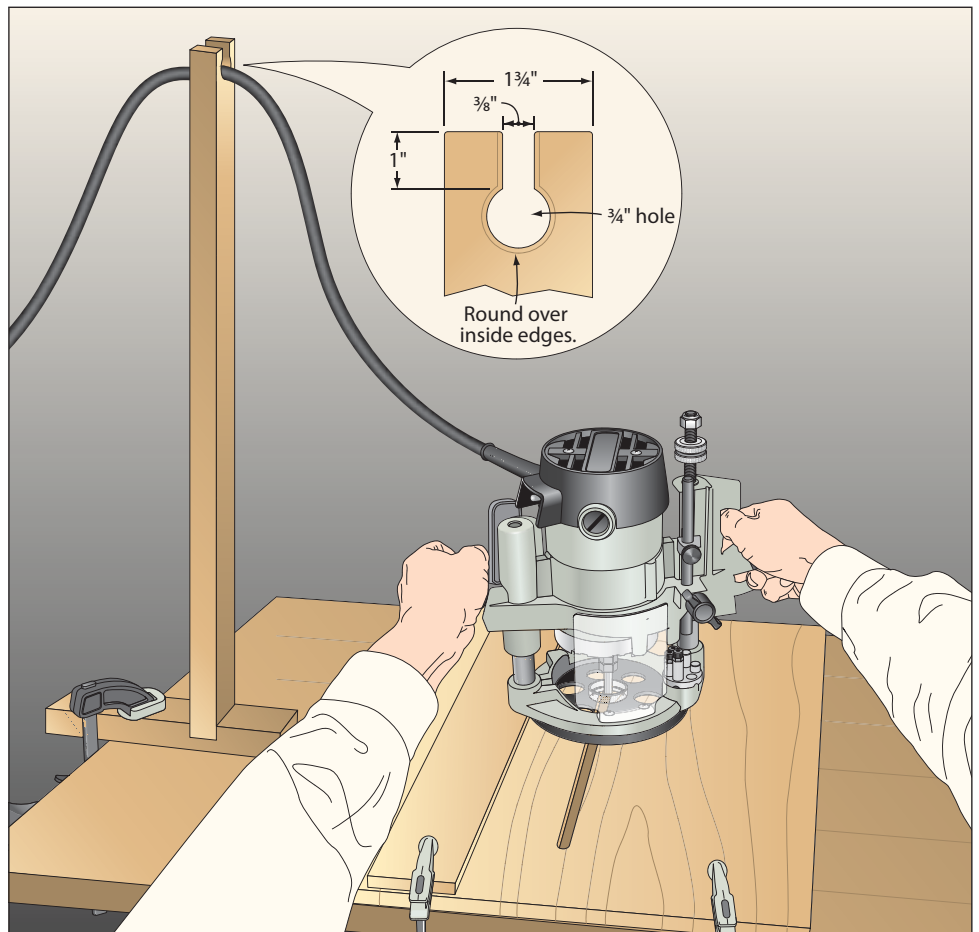

*continued on page 15*

## ... The Best Wood Glue Ever

What makes Titebond® III Ultimate Wood Glue the best ever? It's waterproof, yet cleans up with water. It allows eight minutes of open assembly time and offers an application temperature as low as 47° F.

Plus it's vastly stronger, safer, easier to clean up and less expensive than polyurethane glues.

Titebond® III. We see it as a natural progression of tradition and excellence. You'll see it as the ultimate wood glue.

1-800-347-4583  
titebond.com



# This face launched **1,000** projects.

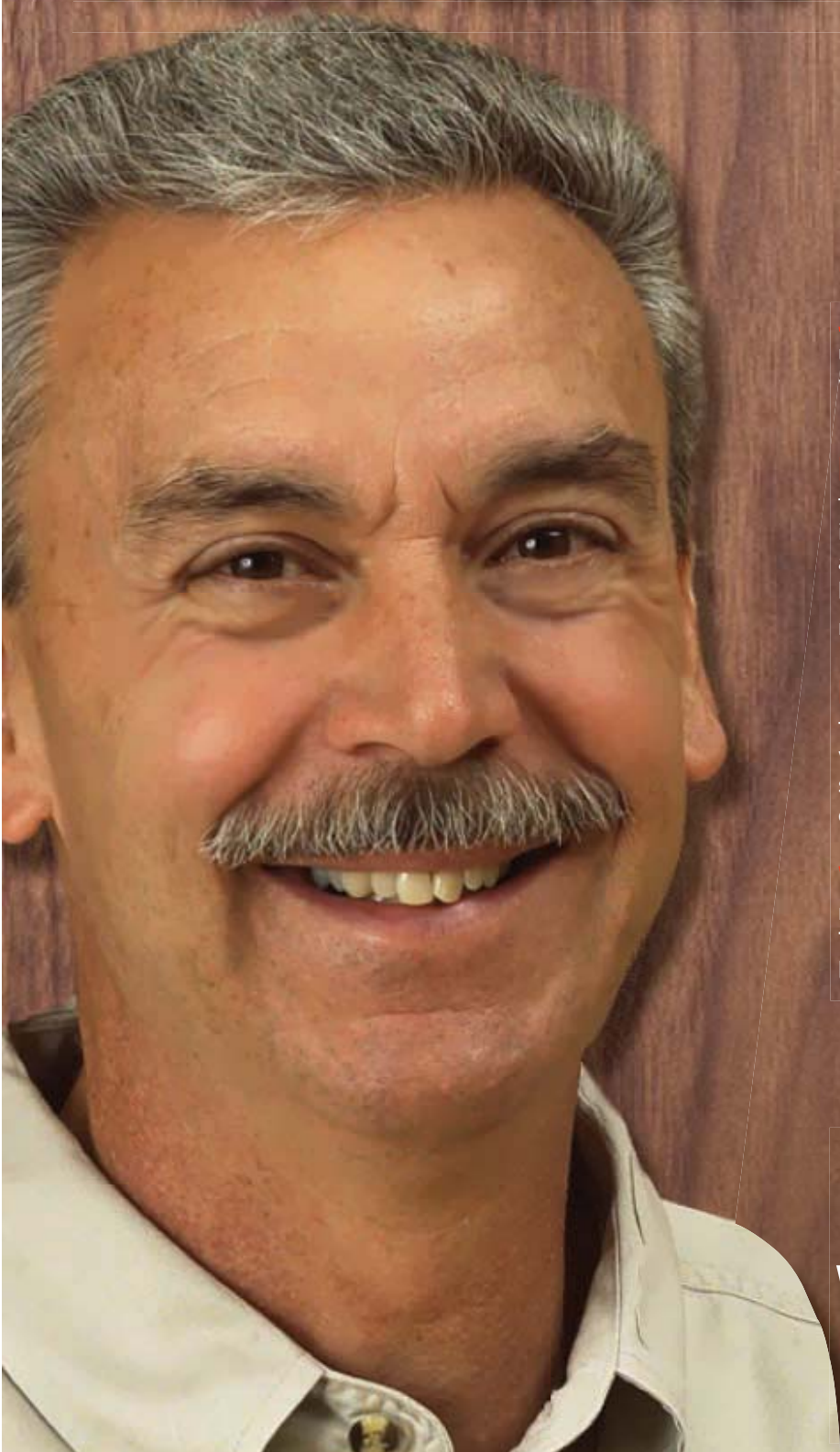

**JIM HEAVEY** is WOOD Magazine's Contributing Craftsman and a popular educator at The Woodworking Shows.

**Favorite Tool:** Most woodworkers will say that the table saw is their favorite but, because of its almost limitless versatility, I count my router as one of my top favorites. The more you use and become familiar with it, the more apt you are to reach for it. You'll see more at this season's shows.

**Best Project:** Bedroom sets that I have made for my children after they celebrate their first wedding anniversaries. I enjoy knowing that something I've made is playing a part in their lives every day.

**Working On:** Remodeling the lower level of my home. Part of this work will be an "Irish Pub". The project has gotten delayed a couple of times but this time for sure!

Launch your DIY or Woodworking project at...



Jim Heavey is just one of **The Faces of The Woodworking Shows**. Meet more Faces at [TheWoodworkingShows.com](http://TheWoodworkingShows.com) and find show info including FREE Education Schedule, Exhibitor info, Shop Tips, ShowOFF! Contest Guidelines, Club links, and more!

## Coming soon to **YOUR** town!

Atlanta, GA Baltimore, MD Chantilly, VA Chicago, IL Columbus, OH Costa Mesa, CA Dallas, TX Denver, CO Detroit, MI Houston, TX Indianapolis, IN Kansas City, KS Milwaukee, WI New England Portland, OR Sacramento, CA St. Louis, MO Somerset, NJ Tampa, FL Twin Cities, MN

[www.thewoodworkingshows.com](http://www.thewoodworkingshows.com) P: 800.826.8257



**A vise for really large workpieces**

Some projects, like this rocking horse, are too large for traditional woodworking vises. Instead, simply position the workpiece between two sawhorses and draw the tops together with pipe clamps, locking the oversize workpiece between them.

—Robert Haase, Benson, Minn.

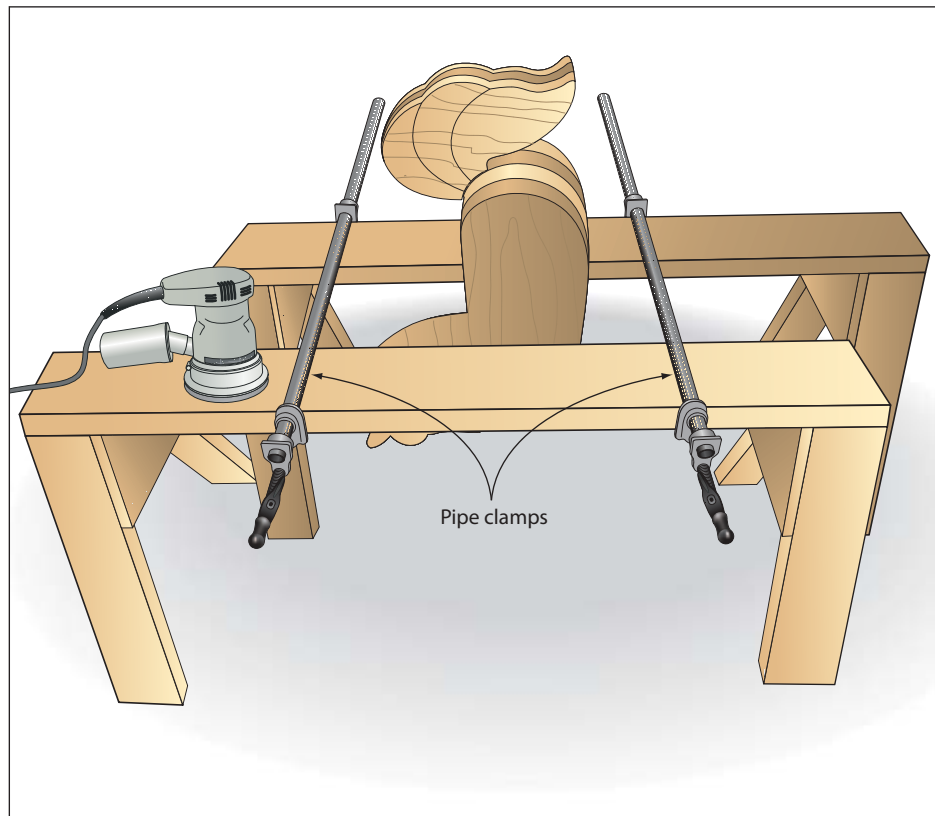

continued on page 16

# More Power! More Features! More Fun!

## Turncrafter Commander Midi Lathes

Packed with features, Turncrafter Commander™ Midi Lathes are the most advanced, powerful and easy to use lathes in their class. These 10" and 12" swing workhorses will help you more easily, effectively and affordably tackle all your turning projects.

Ask about our pen making starter sets and FREE pen making DVD!

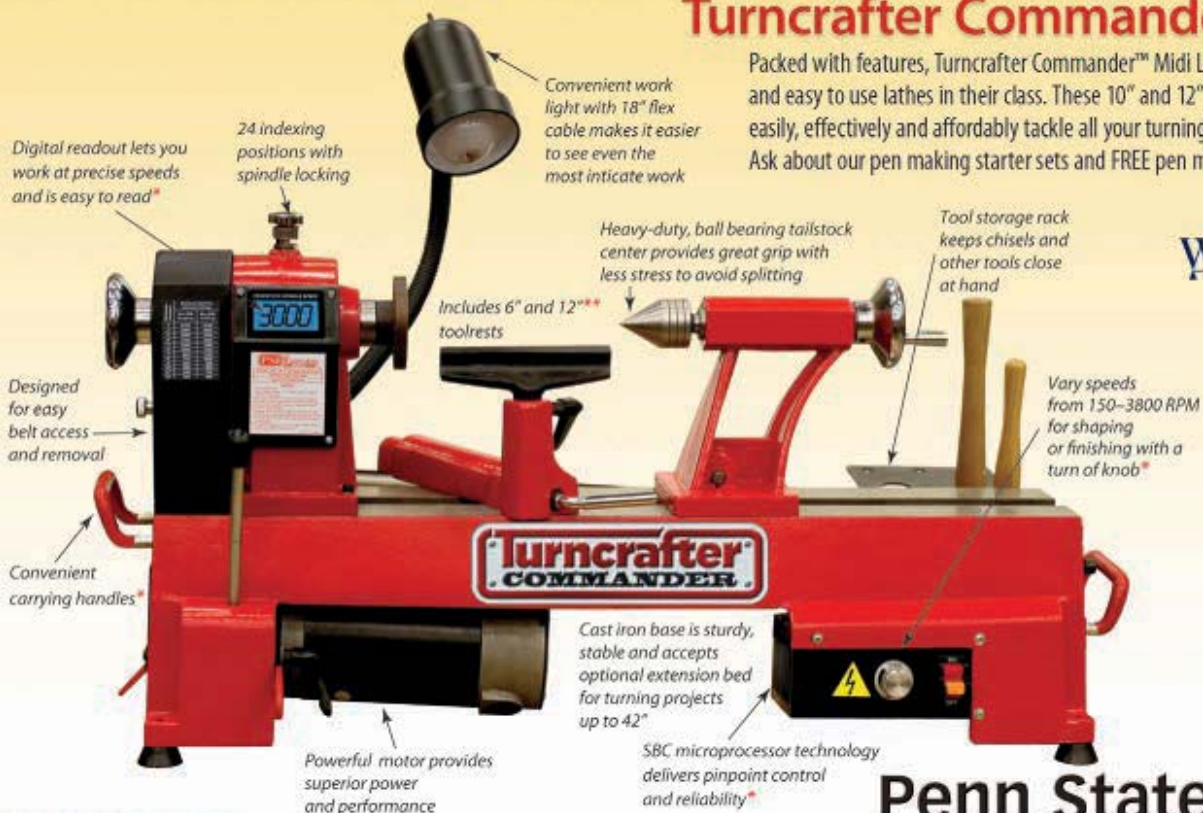

**\$449.95** (shown)

**SAVE \$50**  
**12" Swing 1HP Variable Speed**  
 #TCLC12VS (UPS \$60)

**\$339.95**  
**SAVE \$60**  
**10" Swing 3/4HP Variable Speed**  
 #TCLC10VS (UPS \$50)

**\$279.95**  
**SAVE \$50**  
**10" Swing 3/5HP Multi Speed**  
 #TCLC10 (UPS \$50)

\* Variable Speed versions only  
 \*\* 12" Variable Speed only

**Penn State Industries**  
 1-800-377-7297 [www.pennstateind.com](http://www.pennstateind.com)

# FOR THE TOUGHEST JOBS ON PLANET EARTH.



High strength with a shorter clamp time along with no dyes for a natural finish makes Gorilla Wood Glue ideal for your woodworking and building projects.

FOR THE TOUGHEST JOBS ON PLANET EARTH®

1-800-966-3458 Made in U.S.A. 

© 2010 Gorilla Glue Company

**GORILLA TOUGH** .COM

## Shop Tips

### Project log prevents memory mishaps

Many years ago, my wife suggested that I keep a journal of my projects. The resulting log includes such details as the source of the plans, the project recipient, joinery and finishing notes, jigs used, and “gotchas” to avoid.

This simple form has been extremely helpful over the years. It prevents the duplication of gifts and refreshes my memory if finish repairs prove necessary.

—Lew Zimmer, Bozeman, Mont.

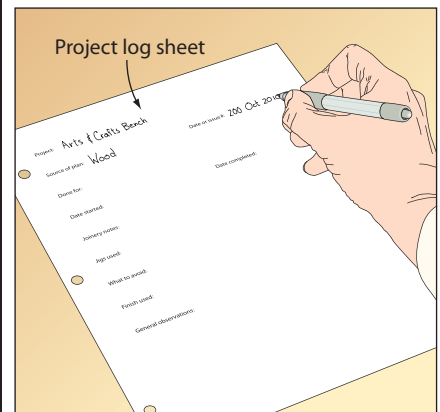

### Corner hook gives a better hold on carvings

After more than 30 years of woodworking, I'm finally trying my hand at carving. But instead of investing in an expensive carver's vise, I improvised this handy benchtop carving “hook.”

Because the bottom cleats bear on the corner of the bench, you can carve from different angles. And because it's portable, you can take it outside to the picnic table to carve on nice days.

—Serge Duclos, Delson, Que.

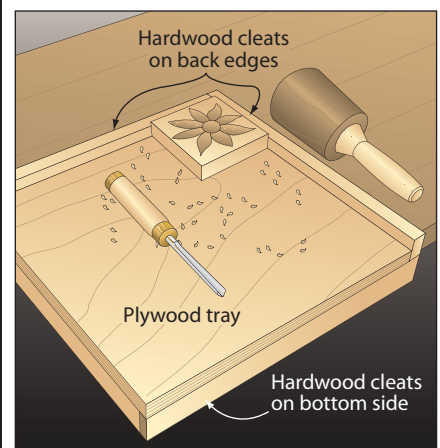

# RELIEF FOR DRY HANDS THAT CRACK & SPLIT

Absolutely Odorless • Non-Greasy



Buy today or find a store near you  
[www.OKeefesCompany.com](http://www.OKeefesCompany.com)

1-800-275-2718 © 2010 The O'Keefe's Company

Also available for your feet.

## “Feather bar” for working wide pieces

The slot-mounted featherboard that normally guides cuts on my tablesaw doesn't work for cutting wide pieces that cover the miter slot. But this oversize “feather bar” that clamps onto the table does the job nicely.

To make one, bandsaw 45° kerfs in a piece of 2x2 and glue in 1½x3" laminate fingers. If the kerfs are too wide, double up the laminate or add wood spacers. Position the 2x2, with all its fingers in front of the blade and against the work-piece, clamp in place, and cut away.

—Bill Wells, Olympia, Wash.

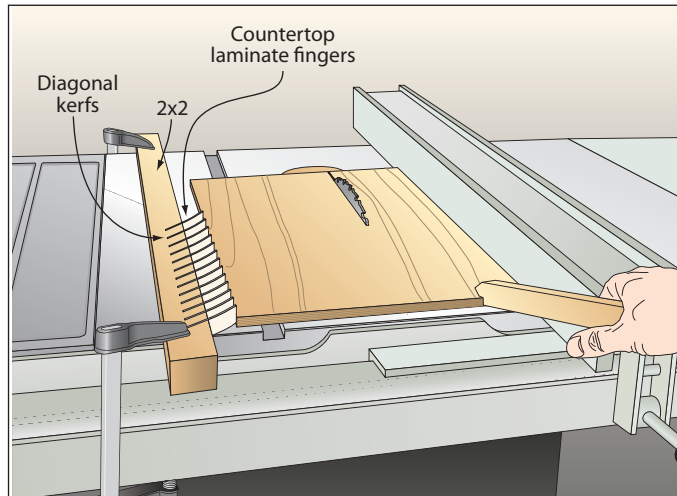

woodmagazine.com

## Custom wrench helps you get a grip

If your hand strength isn't what it used to be, try this shop-made wrench for tightening smallish knobs on shop tools and jigs. The larger diameter makes it easy on fingers and increases your leverage. Simply trace the shape of the knob on a scrap of wood and scrollsaw or jigsaw to shape. 🌲

—Steven Waskewicz, Elbert, Colo.

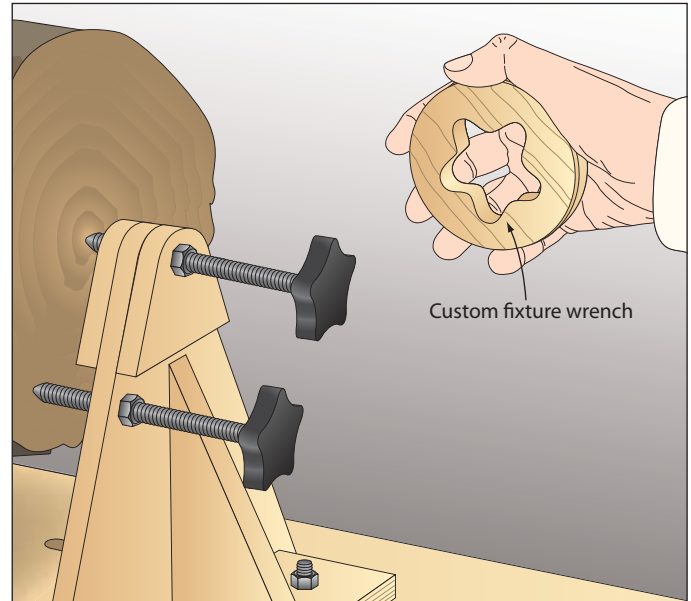

17



# Nanofiber eats the competition's dust!

## (FREE with any Tempest Cyclone!)

The best value in dust collection is now the cleanest.

Our Tempest Cyclone Dust Collectors now include Nanofiber filtration as a **FREE** upgrade (a \$54 value). Industry leading, Merv 15 rated Nanofiber filtration combined with our cyclonic separation process captures 99.98% of wood chips and dust particles to below 1/2 micron. You achieve near surgical quality air and cleaner tools, while practically eliminating dust clean up forever! What's more, Tempest Cyclones never clog, require almost no maintenance and come with a 5 year warranty.

- 2.5 HP - 1450CFM - \$995
- 3.5 HP - 1700CFM - \$1125
- 5.0 HP - 1800CFM - \$1395
- 2.0 HP - Portable\* 1025CFM - \$895+ FREE Shipping

**Ask about our solutions for smaller shops starting at only \$295.**

**SAVE on any system you buy!** PSI offers a variety of discounts and offers on dust collectors too numerous to list here. We're your complete resource for everything you need to get the job done right! To get the best deal on the system sized perfectly for your shop and number of tools, **call Bill at (215) 676-7606 x16.**

## Penn State Industries

Top Quality, Great Prices, and Expert Advice!

1-800-377-7297 • www.pennstateind.com



**FREE Ductwork Plan**  
Plus Save \$100 when you purchase any S-series Tempest™ cyclone!  
Offer expires 6/30/11  
Use Code WOOD13

Clean Air! Clean Shop! Clean Tools!

# Just-Right Joinery

## Dead-on Dowel Joints

Much easier to make than mortise-and-tenon joints, and a lot stronger than biscuits, trusty old dowels still deserve a place in your joinery arsenal.

Using only basic tools and careful layout, you can assemble dowel joints that rival the strength of mortise-and-tenon joinery, and in less than half the time. In fact, dowels beef up nearly any end-to-end, edge-to-face, and mitered joint.

Doweling jigs range from a simple but nonadjustable \$12 jig to the \$310 multiadjustable Dowelmax [Photo A]. But for less than \$60, a self-centering jig with removable drill-guide bushings handles most doweling jobs like the face-frame joints in the dry sink project on page 54. You'll also need a brad-point or bullet-point drill bit to match the jig bushings and a countersink wider than the bit.

Although you can buy dowels in  $\frac{1}{4}$ ",  $\frac{5}{16}$ ",  $\frac{3}{8}$ ",  $\frac{7}{16}$ ", and  $\frac{1}{2}$ " diameters, the  $\frac{1}{4}$ " and  $\frac{3}{8}$ " sizes handle most jobs. (See Sources.) Our favorite dowel pins: expandable fluted dowels like those shown in the Shop Tip that allow glue to escape through the flutes but swell to firmly grip the holes. Either  $1\frac{1}{2}$ " or 2" lengths will work; but the  $1\frac{1}{2}$ " dowels provide ample reinforcement for most joints in  $\frac{3}{4}$ "-thick stock.

### Make end-to-edge or edge-to-edge joints

For a simple butt-joint, first label your parts. To ensure perfectly mating joints, number the joints 1 through 4 on each piece of a four-sided assembly before marking the dowel locations [Photo B].

We positioned these marks to center two  $\frac{3}{8}$ " dowels  $1\frac{1}{4}$ " apart on  $3\frac{1}{4}$ "-wide frame parts. You can add more dowels for increased strength, but avoid spacing them closer than  $\frac{1}{4}$ ". And leave

at least  $\frac{1}{8}$ " of wood between the edge of the dowel hole and any surface of the workpiece.

Next set the drilling depth to half the length of your dowels plus  $\frac{1}{16}$ " to allow for trapped glue. At that distance plus the length of the jig bushing, wrap tape around the bit [Photo C].



### SHOP TIP

#### Fluted dowels expand to create a solid joint

You could cut your own dowels and score glue-relief grooves in the sides, but you'll save time using commercially available dowels. Like pressed-beech biscuits, the compressed wood in these  $\frac{3}{8}$ " dowels expands about  $\frac{1}{32}$ " on contact with moisture in the glue, as shown at far right, creating a tight fit.

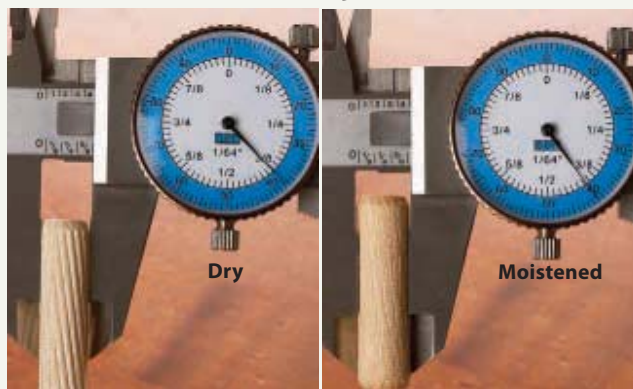

#### JIGS VARY BY PRICE AND FEATURES

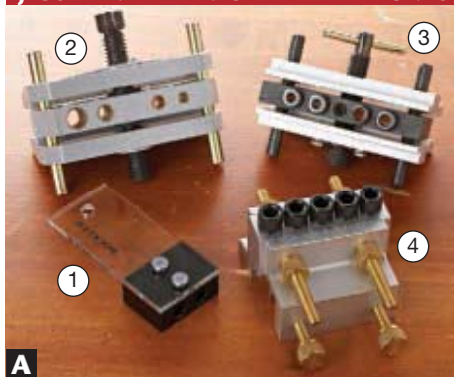

There's a doweling jig for any budget. Shown are jigs from ① Rockler (\$12), ② Woodworker's Supply (\$36), ③ Lee Valley (\$59), and ④ Dowelmax (\$310).

#### MARK DOWEL HOLE LOCATIONS

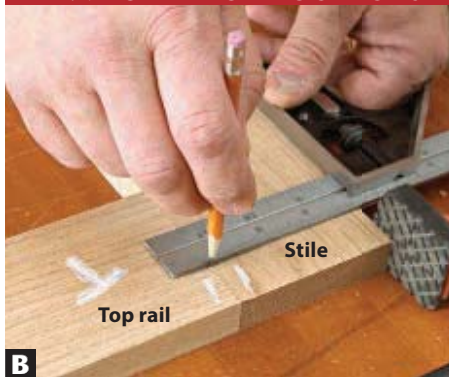

Make a single fine pencil mark across the stile and rail. The doweling jig will space dowels the same distance apart on both pieces, making a second line unnecessary.

#### DRILL TO THE CORRECT DEPTH

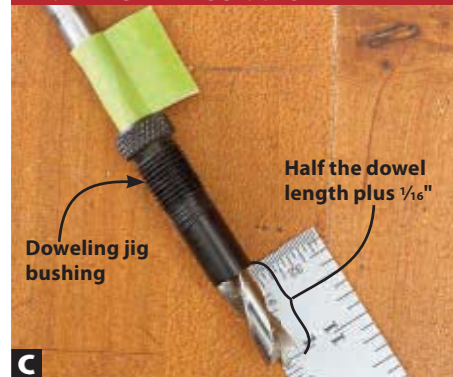

A self-centering doweling jig's bushing helps determine the correct drilling depth, which we've marked with tape.

*continued on page 20*

Act  
**now**  
*SawStop*

for a special free upgrade.

**\$199 Overarm Dust Collection:**  
FREE with every 3.0HP Professional Cabinet Saw.

**\$139 Dust Collection Blade Guard:**  
FREE with every 1.75HP  
Professional Cabinet Saw.  
(Standard with every 3.0HP)

You know the next cut could change your life.  
We'd like to help you make the switch now.

[sawstop.com/upgrade](http://sawstop.com/upgrade)

Upgrade offered on new SawStop Professional Cabinet Saws purchased between January 1 - March 31, 2011. 3.0HP owners will be offered a free Overarm Dust Collection assembly (\$199 value), and 1.75HP owners will be offered a free Dust Collection Blade Guard (\$139 value). While supplies last. See website for details.



"I wish I bought  
this saw before  
I had my accident."  
Watch true story videos:  
[sawstop.com/true](http://sawstop.com/true)

## ONE JIG WORKS FOR DRILLING ENDS AND EDGES

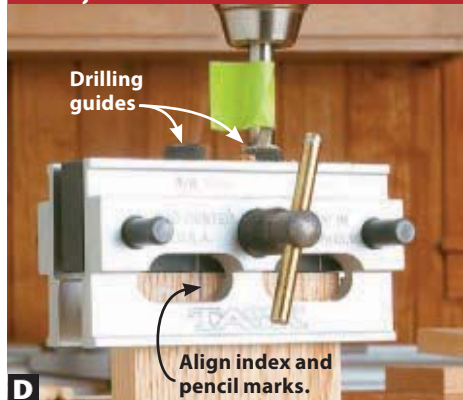

**D** You need only one alignment mark to position this drilling jig on a workpiece end (left) or edge (right). Drilling with the two inside guides spaces holes 1/4" apart.



**E** Align index and pencil marks.

To drill a dowel hole into the end grain of a workpiece, align a self-centering doweling jig index mark over your marked dowel location [Photo D]. Then drill two dowel holes to the tape at both ends on each rail.

Now repeat the process on the edge of the mating workpiece [Photo E]. Moisture in glue can swell the rims of a dowel hole, pushing the pieces apart. To prevent this, bevel the hole edges with a 1/16"-deep countersink [Photo F].

Then glue and insert dowels into either the stiles or rails. Glue the exposed dowels and joint surfaces, tap the parts together, and clamp the joints for one hour.

To make edge-to-edge joints, use the same technique to mark and drill mating edges. Place holes no closer than 1/8" from the ends to avoid breaking out the end grain while assembling the joint.

## Join edges to faces

To make edge-to-face joints, start by drilling dowel holes along one edge as described in the previous section. Drill the holes deep enough to make the protruding dowels at least 3/16" shorter than the thickness of the mating piece.

Use dowel centers (see Sources) to transfer dowel-hole positions from the edge of one piece to the face of the mating piece. Depending on the size of your dowel centers, either place them in the dowel holes you just drilled, or insert a dowel in each hole and slip them over these dowels [Photo G].

To mark the face of the second joint part with the dowel locations from the first one, align the ends of both workpieces using a block. Then tap the face of the second part against the dowel centers [Photo H].

Now use a brad-point or Forstner bit in your drill press to drill the mating

## COUNTERSINK FOR A TIGHT FIT



**F** A 1/16" countersink keeps the hole edges from swelling and pushing the joint apart.

holes at each location marked by the dowel centers [Photo I]. Set the drill-press depth stop for the length of the protruding dowels plus 1/16".

Dry-assemble the joint to test for fit; then carefully disassemble it. Then glue and clamp the pieces. 🌲

## Sources

**Doweling jigs.** 3/8" doweling jig no. 35242, \$12, Rockler, 800-279-4441, rockler.com. Self-centering, fixed-bushing jig no. 109-142, \$36, Woodworker's Supply, 800-645-9292, woodworker.com. Self-centering doweling jig no. 25K64.01 with interchangeable bushings, \$58.50, Lee Valley Tools, 800-871-8158, leevalley.com. Dowelmax Kit with 3/8" bushings, \$310, O.M.S. Tool Co., 877-986-9400, dowelmax.com.

**Countersinks.** Grizzly set of five countersinks no. G5729, \$23 from Amazon.com.

**Dowel centers.** Each come in packs of 5: 1/4" outside, 3/16" inside no. 66J45.01, \$2.70; 3/8" outside, 3/16" inside no. 66J45.02, \$3.20; and 1/2" outside, 3/8" inside no. 66J45.03, \$4.10; Lee Valley Tools.

**Fluted dowels.** 1/4"x1 1/2", \$4.89 per pack of 50, Rockler #70342.

## DOWEL CENTERS ALIGN HOLES FOR EDGE-TO-FACE JOINTS

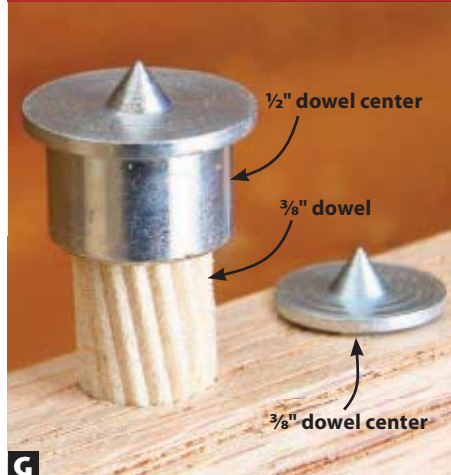

**G** Dowel centers can be placed over the dowels or into the dowel holes. Common dowel center sizes are 1/4", 3/16", 3/8", and 1/2".

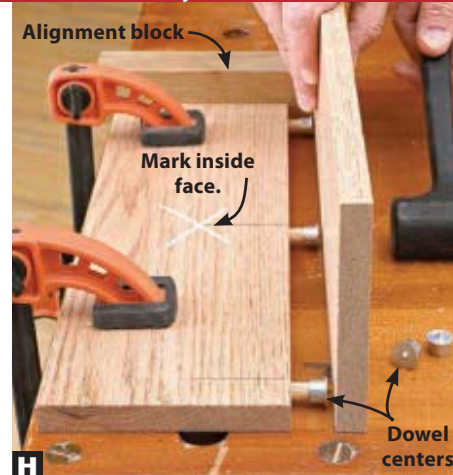

**H** Clamp the part with the dowel centers to a flat surface. Then align and tap the mating part to mark the dowel hole locations.

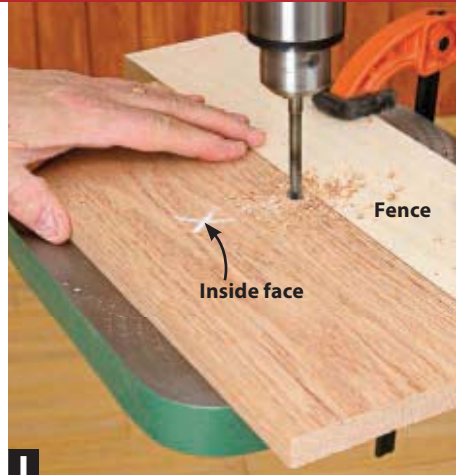

**I** Scrap clamped to the drill-press table acts as a fence for positioning a Forstner or brad-point bit over the dowel-center dimples.

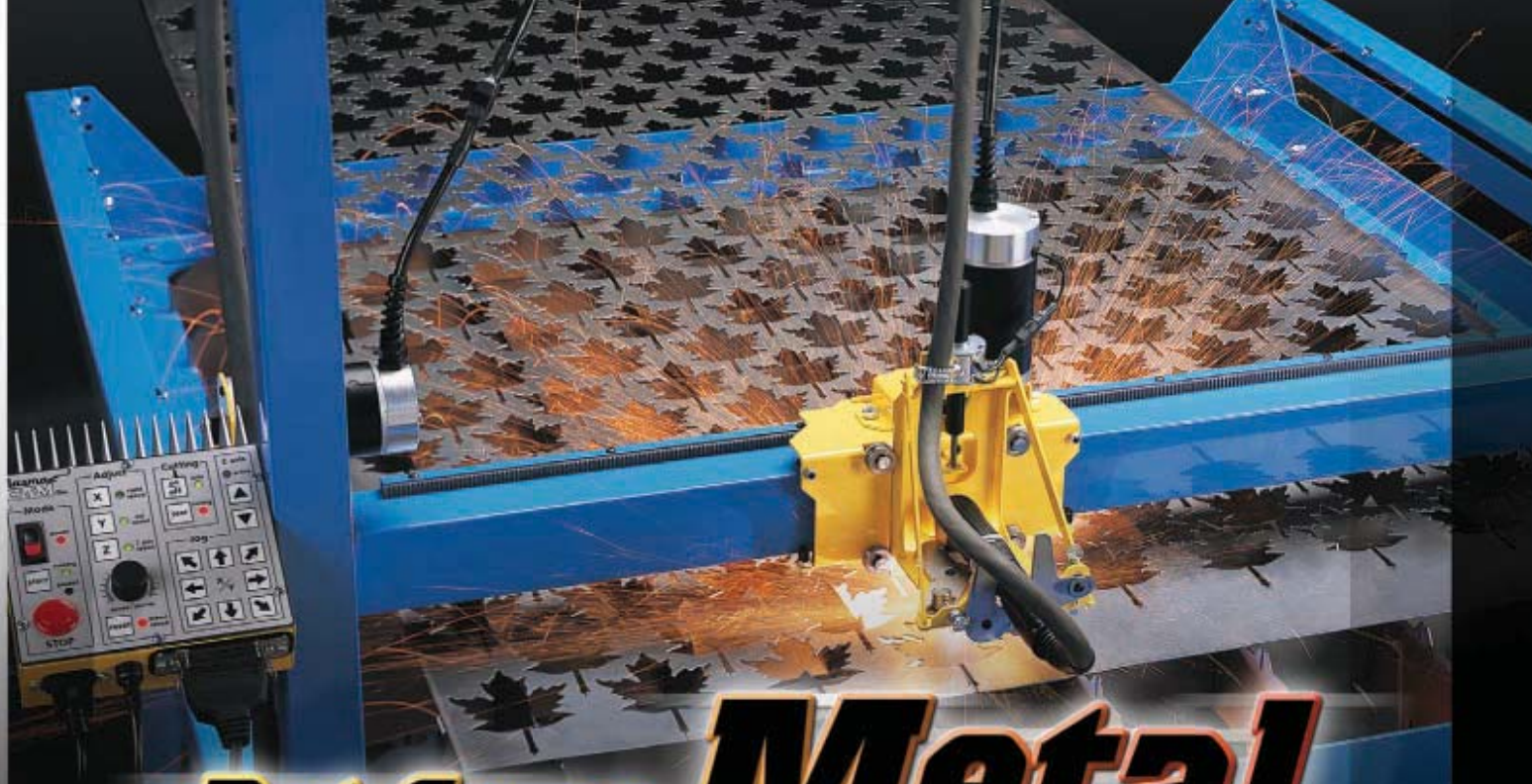

# *Put Some **Metal** In Your Wood*

*The PlasmaCAM<sup>®</sup> machine makes it easy for you to cut intricate metal shapes that really enhance your wood projects.*



*Call today for your FREE demo video to see what you can do with this amazing machine.*

(719) 676-2700 • [www.plasmacam.com](http://www.plasmacam.com)  
PO Box 19818 • Colorado City, CO 81019

**Plasma**  
**CAM**<sub>Inc.</sub>



## Small-Scale Spray-Finishing

Airbrushes and touch-up sprayers provide simple, low-cost ways to spray.

If you've given up on the idea of spray-finishing projects because you think it's too messy, too complicated, and too costly for your small and medium-size projects, maybe you're thinking too big. Airbrushes and some small spray guns cost less than HVLP systems and some full-size spray guns. They reduce overspray and vapor problems when finishing small and medium-size projects, and require only a small compressor or just canned compressed air.

Small sprayers come in three types:

Airbrushes, such as the Badger Model 350-4, have nozzles and fluid jars large enough to handle small spray-finishing jobs like jewelry boxes. (See **Sources**.)

Small spray guns, such as the Paasche Model 62-2-3 and the K-Grip Siphon Gun sprayer, hold and spray more finish than airbrushes, but less than most intermediate spray guns.

Touch-up spray guns, such as the Speedaire 4RR06 (**Sources**), handle large projects, such as cabinets and furniture, but they still require less air than full-size spray guns.

### Airbrush small projects

Airbrushes may seem too small to be practical, but they have advantages. There's less overspray waste on small projects or projects with narrow parts, as shown *above*. Despite their diminutive size, airbrushes can shoot light-body stains, thinned and some unthinned lacquers, shellac, thinned

varnishes, plus water-based finishes. The material needs to be the consistency of skim milk or thinner.

To handle these finishes, select an airbrush with the largest available nozzle and a container that holds  $\frac{3}{4}$  to 2 oz of material. Choose an external-mix, single-action airbrush that mixes the finish and air outside the body of the airbrush and on which the trigger controls just the release of finish, not finish and air flow.

Next, choose an air source that suits your spraying plans. An airbrush can operate off air sources as simple as a compressed air tank you can refill at a gas station. A light-weight tankless

inflator provides a constant air supply, as will portable tank-type air compressors sold at home centers for powering pneumatic nailers.

Before spraying your project, practice on cardboard to adjust the finish viscosity and airbrush settings. If you're using an air compressor, set the pressure reaching the nozzle to 25–30 pounds per square inch (psi). Spray a short burst of finish, and then adjust the fluid flow using your results against the examples shown in the chart *below*. Airbrushes produce a conical spray pattern that can be narrowed by holding the airbrush closer to your work and reducing the fluid flow.

## How to read an airbrush pattern

<b>Pattern</b>				
<b>Problem</b>	There's too little air for the thickness of the finish and nozzle size, producing these splatters.*	You're spraying too little material, which produces a rough, dusty-looking surface.	Spraying too much material produces a hot spot and runs at the center of the pattern.	No problem here. Balanced finish and air flows produce a focused, even pattern.
<b>Solution</b>	Increase the air pressure in 5-lb increments, or thin the finish to compensate for low air pressure.	Adjust the nozzle to draw more finish. Switch to a nozzle with a larger opening, if needed.	Adjust the nozzle or lower the air pressure to release less finish, or spray farther from the worksurface.	

\* We tinted water-based finish to demonstrate different airbrush settings.

continued on page 24

WOOD magazine March 2011





CNC Shark Pro Plus 39500 \$3799.99

## CNC Routing from **only \$2599<sup>99</sup>**

Priced thousands less than most CNC machines, the Shark™, Shark Pro and new Shark Pro Plus give small shops unprecedented access to precision-automated routing. Tools like these will revolutionize your work, bringing pro-level results to every project—another way Rockler helps you *Create with Confidence*.

Materials code: 282



For a store near you or free catalog visit [Rockler.com](http://Rockler.com) | 1-877-ROCKLER

# Finishing School

## Small guns for larger jobs

For larger projects, consider a small spray gun with greater finish storage capacity and a larger fan pattern than an airbrush but with lower air requirements and less overspray than an intermediate spray gun.

For greater versatility, look for models that allow you to control the fluid flow in addition to regulating the air flow at the compressor, such as the K-Grip Siphon Gun sprayer. By using canning jars to store finish and as the fluid reservoir—coupled with a simple siphon action that mixes air and fluid outside the gun—the K-Grip cleans up quickly.

Small sprayers often call for compressors that generate 3 cubic feet per minute (CFM) or more at 90 psi, although we sprayed small projects with the K-Grip using an air compressor producing just 2.4 CFM. The K-Grip needs as little as 20 psi to spray lacquers and 25 psi for polyurethane.

## Just a touch-up larger

Stepping up to a touch-up spray gun gives you more control over the pattern. Unlike airbrushes and some spray guns, touch-up sprayers produce a



For spraying water-based finishes, a box fan with a furnace filter taped to the intake side directs odors toward the nearest window.

fan pattern instead of a conical shape. You can dial in a wide fan pattern to spray a cabinet side or tabletop, as shown *above*, or tighten the pattern to finish narrow table legs. Customizing

the pattern conserves finish material by reducing overspray.

Two other features of touch-up spray guns also let you work faster: Their greater fluid capacity means less refilling when spraying larger projects, and by using larger nozzle sizes than a small sprayer, heavier-body finishes, such as varnish and shellac, can be sprayed with little or no thinning. That means you can spray two or three heavy coats instead of four or more thin ones.

Unlike full-size spray guns, a touch-up sprayer's 3.5-CFM requirements could be met by a 2.6-gallon portable compressor. Even when touch-up sprayers specify an air source requirement like 3 CFM at 90 PSI, most finishing jobs require far less pressure. Thinning may help a slightly undersized air compressor atomize a finish while reducing air use. Lower air pressure also reduces "bounceback"—droplets of finish that ricochet off the surface you're spraying.

## Set up a spray space

The smaller the spray gun, the smaller the work area you'll need. But even a touch-up sprayer can be dialed back to apply water-based finish in a tabletop spray booth made from a large cardboard box.

Whether spraying water-based or flammable finishes indoors, position a fan to draw fresh air into the space, around your workpiece, and toward a window or door without pointing the fan directly at your workpiece. Avoid drawing flammable vapors into the fan motor, where they could be ignited. And wear a respirator made to filter organic vapors.

Then arrange a low-angle light to reflect where your finish lands and call attention to any missed spots. To make small and medium-size projects easier to rotate for spraying, place them on pieces of cardboard or a turntable. 🌿



## Sources

**Airbrushes:** Badger 350-4 set with three nozzles, hose, and two jars, \$102 from [webairbrushes.com](http://webairbrushes.com), 888-499-6996. Badger Air-Brush Co., 800-247-2787 or [badgerairbrush.com](http://badgerairbrush.com). H-Card model set, \$56.50 from Paasche Airbrush, 773-867-9191 or [paascheairbrush.com](http://paascheairbrush.com).

**Small sprayers:** K-Grip Siphon Gun sprayer, \$50 from Woodcraft Supply (no. 149425), 800-225-1153 or [woodcraft.com](http://woodcraft.com). Model 62-2-3, \$42 from Paasche Airbrush.

**Touch-up spray gun:** Speedaire 4RR06, \$77 from Grainger, 800-323-0620, [grainger.com](http://grainger.com).

# There's a mini sprayer for every job

Sprayer	Finishes and Applications	Comments	Cost
 <p><b>Airbrush</b></p>	Thinned lacquer and varnish, shellac, water-based finishes, and light-body stains. Use for small projects, such as the dinosaur puzzle on <i>page 70</i> .	Look for models that use jars instead of cups. Many come in sets with a hose, wrench, finish jars, and assorted nozzles.	\$50–95 (varies with make, model, and kit contents)
 <p><b>Small spray gun</b></p>	Full-strength lacquer, water-based finishes, shellac, stains. Use on medium-size or larger projects, such as the dry-sink cabinet on <i>page 54</i> .	The Critter (shown) has a fluid flow control that the Paasche 62 lacks. Neither lets you alter the conical fan pattern.	\$50 for the Critter Model 118; \$42 for the Paasche 62-2-3
 <p><b>Touch-up spray gun</b></p>	Full-strength lacquer, water-based finishes, shellac, varnish, stains. Big enough to handle large projects, such as the corner curio on <i>page 38</i> .	Includes controls for fluid and air flow and for the fan pattern. Good for big projects, but more output can mean more overspray problems.	\$77 for the Speedaire 4RR06



# Turn Your Hobby into a New Career.

## Learn furniture and cabinet making with training from Penn Foster.

With Penn Foster, you can learn the skills you need to turn a hobby into a profitable career in as little as six months. Learn the advanced woodworking techniques used in furniture and cabinet making. You can work for an established woodworking business or even start a business of your own.

**Convenient.** Penn Foster programs are designed to train adults for employment in the fastest-growing fields. You choose the time and place to complete your coursework, and you work at your own pace. All learning materials are sent directly to you.

**Flexible.** Study online, in print, or a combination of both. You decide which method best suits your learning style. You work independently, but not alone. Expert instructors and support staff — dedicated to helping you complete your coursework — are just a phone call, message board, or email away. And you can interact with other Penn Foster students through eCampus, the school's online community, which includes social networks, blogs, forums, and discussion groups.

**Accredited.** Penn Foster Career School and Penn Foster College are nationally accredited by the Accrediting Commission of the Distance Education and Training Council (DETC). In addition, Penn Foster Career School is regionally accredited by the Commission on Secondary Schools of the Middle States Association of Colleges and Schools.



**Affordable.** Our low-cost tuition includes all study materials including books, study guides, and learning aids. We offer 0% APR financing and customized payment plans to best meet your individual needs.



**Career Services.** Current students and graduates are notified — through their personal message boards — of job openings submitted directly to Penn Foster by employers from around the country. Penn Foster graduates can take advantage of Career Services, which include access to online searches for jobs by industry and region, and even one-on-one help in creating your resume with a Certified Professional Resume Writer.

For fastest service, call toll free:

**1-800-572-1685 ext. 6845**

Call anytime, 24 hours a day, 7 days a week.

Or visit our website at

**www.PennFoster.edu**

Online enter ID# AW8S21T

Or mail the coupon today.



**PENN FOSTER**  
CAREER SCHOOL

925 Oak Street, Scranton, PA 18515-0700  
www.PennFoster.edu

**384 Furniture and Cabinet Maker**

**Building Trades**

- 06 Electrician
- 104 Carpenter
- 15 Home Inspector
- 145 Home Remodeling and Repair
- 14 HVAC Technician
- 102 Landscaper
- 151 Plumber

**Business**

- 70 Small Business Mgmt.

**Mechanics**

- 04 Auto Repair Technician
- 55 Diesel Mechanics
- 33 Motorcycle Repair Technician
- 89 Small Engine Repair

**High School**

- 07 Penn Foster High School
- 756 Penn Foster High School w/ Carpentry Concentration
- 755 Penn Foster High School w/ Electrical Concentration

**Technology**

- 54 Drafting with AutoCAD®
- 79 Electronics Technician
- 27 PC Maintenance and Repair

**Web Page Designer**

- 83 Web Page Designer
- Other Exciting Programs**
- 72 Appliance Repair
- 25 Gunsmith
- 58 Private Investigator
- 31 Professional Locksmithing



**PENN FOSTER**  
COLLEGE

Administrative Office  
14300 N. Northsight Blvd.  
Suite 120  
Scottsdale, AZ 85260  
www.PennFosterCollege.edu

**Associate Degree Programs**

- 61 Accounting
- 60 Business Management
- 418 Computer Information Systems
- 406 Criminal Justice
- 81 Finance
- 407 Graphic Design
- 412 Human Resources Management

- 66 Industrial Engineering Technology
- 80 Marketing
- 62 Mechanical Engineering Technology
- 408 PC Maintenance Technology
- 456 Retail Management

Please send me FREE information on the Career School or College program I have selected above. No obligation. Choose ONE only.

Name \_\_\_\_\_ Age \_\_\_\_\_  
Street \_\_\_\_\_ Apt. # \_\_\_\_\_  
City/State \_\_\_\_\_ Zip \_\_\_\_\_  
Phone ( ) \_\_\_\_\_ Email \_\_\_\_\_

Mail coupon to Student Service Center,\* Dept. AW8S21T, 925 Oak Street, Scranton, PA 18515-0700.

\*Under contract with Penn Foster College, AZ

186G1

# CATALOGS FOR CRAFTSMEN



ADVERTISEMENT

## Select the catalogs you



**1 AMERICAN FABRIC FILTER** – Increase the performance of your shop's dust collector with our economical and low-maintenance optimized dust bags.



**2 AMERICAN FURNITURE DESIGN** – The leader in woodworking plans for furniture! Over 85,000 copies of our Mission Bed have been sold! CAD generated designs, 36"X48" with instructions. Hardware, hand tools, router bits, finishes & books.



**3 COOK'S SAW MANUFACTURING** – Cook's Saw is a leading manufacturer of Portable Sawmills, Board Edgers, Blade Sharpeners, Tooth Setters, Bandsaw Blades, and Sawmill Parts. FREE Catalog.



**4 DETAILED PLAY SYSTEMS** – Features wooden swing sets and backyard playground equipment kids, plans, and accessories to build children's outdoor play structures. Free catalog.

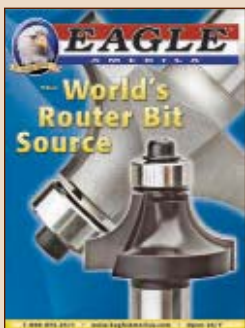

**5 EAGLE AMERICA** – "The World's Router Bit Source" plus so much more. Over 2,000 router bits and 6,000 total items to choose from including many hard-to-find woodworking accessories. New products and specials added online every month.



**6 EPILOG** – Add value to woodworking projects with laser engraving systems from Epilog. Customize anything with a touch of a button.

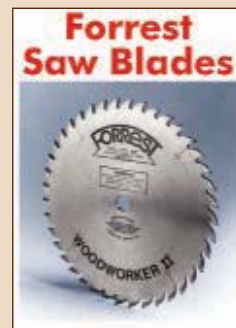

**7 FORREST MANUFACTURING** – The finest, quietest saw blades and dados! Full line of sizes available.



**8 HUT PRODUCTS** – "Turn to Quality". A comprehensive catalog for Wood Turners from HUT Products.

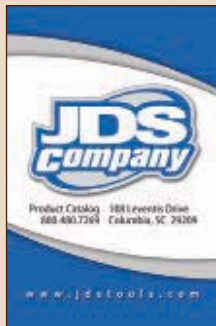

**9 JDS COMPANY** – Providing quality products for over 20 years! Find out more information on JDS Air Filtration, dust collection systems and the amazing Multi-Router!



**10 KLOCKIT** – Whether your next project is to build a beautiful clock or repair a treasured heirloom, Klockit can supply all you need; Plans, Wood Kits and Clock Components.



**11 LIGNOMAT** – Catalog describes full line of wood moisture meters. Convenient, reliable and affordable moisture meters for any hobbyist and woodworker.

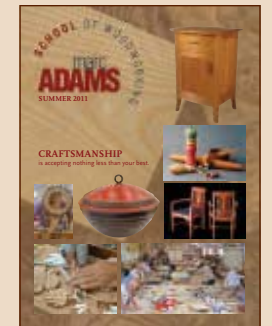

**12 MARC ADAMS SCHOOL OF WOODWORKING** – Committed to fine woodworking excellence through hands-on learning experiences with the best woodworkers of modern time.

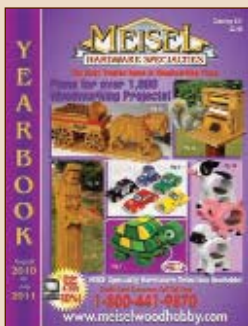

**13 MEISEL HARDWARE SPECIALTIES** – Over 2,000 woodworking project plans for indoor and outdoor furniture, toys, clocks, patriotic, birdhouses, Christmas, etc. Request our full-color catalog.

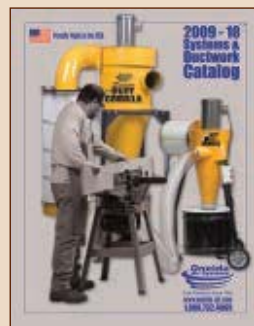

**14 ONEIDA AIR SYSTEMS, INC.** – Offers the finest quality dust collection systems and a complete line of ductwork and accessories. Free catalog.



**15 OSBORNE WOOD PRODUCTS** – 40 full-color catalog pages containing the latest fresh and innovative product releases, our brand new corbels, bun feet, island legs, and molding.



**16 PACKARD WOODWORKS** – Catalog for Woodturners! All major brands of Turning Tools, Chucks, Penmaking Supplies, Finishes, Exotic Woods, Books and DVDs, Pyrography and Carving Supplies and much more!

want from these 24 FREE LISTINGS! See the attached card for ordering info.



**17 PANEL PRO** – Panel Pro is an economical panel saw that makes it easy to handle those big sheets of wood or plastic and cut them accurately.

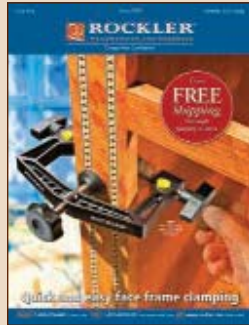

**18 ROCKLER WOODWORKING AND HARDWARE** – A Woodworker's Dream! Full-color catalog features thousands of woodworking products. Hard-to-find hardware, exclusive plans and workshop essentials.



**19 SAWSTOP** – The world's safest table saws. Each high quality saw features the legendary and patented safety technology. Now with multiple dust collection solutions.

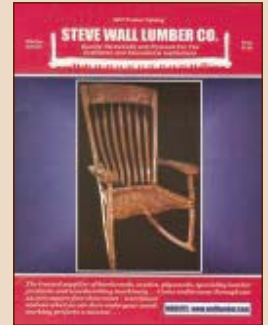

**20 STEVE WALL LUMBER CO.** – Supplier of hardwoods, exotics, plywood, custom panel doors, turning squares, hardwood flooring, Oliver Machinery, and Festool products. Catalog.



**21 WOOD STORE CATALOG** – A free catalog of plans, DVDs, and other products from the editors at WOOD® magazine.

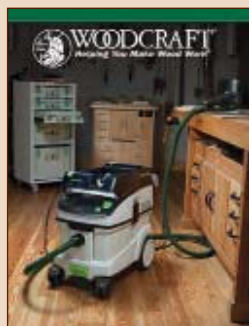

**22 WOODCRAFT** – Woodworking hand and power tools, finishing supplies, hardware, exotic woods and more! Exclusive brands and top-quality tools from around the world, plus hard-to-find jigs and accessories.



**23 WOODMASTER** – 4-Way Money-Maker planes, molds, sands, saws... creates high-profit moldings, picture frames, tongue & groove. 12", 18", & 25" models.

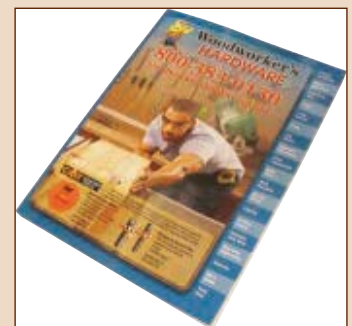

**24 WOODWORKER'S HARDWARE** – Our 544-page catalog features the largest selection of cabinet hardware in this industry, with over 10,000 items in stock.



## CATALOGS FOR CRAFTSMEN Order Form

Fill out the coupon below, circle the numbers corresponding to the catalogs you'd like to receive, and mail to:  
WOOD® Magazine • Catalogs for Craftsmen • Dept. WOCCFM11 • P.O. Box 5135 • Buffalo, NY 14205-5135.

This coupon expires July 18, 2011.

Allow 4-6 weeks for delivery. Expired cards will not be processed.

CIRCLE THE NUMBERS BELOW CORRESPONDING TO ITEMS IN THIS ISSUE.

Dept. WOCCFM11

1	5	9	13	17	21	4000
2	6	10	14	18	22	
3	7	11	15	19	23	
4	8	12	16	20	24	

Discover how rewarding woodworking can be! Get one full year of WOOD® for just \$28.00 (7 issues). Simply circle No. 4000. You will be billed later.

NAME \_\_\_\_\_

ADDRESS \_\_\_\_\_

CITY \_\_\_\_\_

STATE \_\_\_\_\_ ZIP \_\_\_\_\_

E-MAIL ADDRESS \_\_\_\_\_

PHONE (OPTIONAL) \_\_\_\_\_

# Great Ideas for Your Shop



## Pocket-Hole Jig Organizer & Base

Clamp this organizer to your workbench with a pocket-hole jig mounted on top and go to work. When you're done, fill the compartments with screws and accessories and hang it up until the next job.

We sized the organizer and workpiece supports to work with a Kreg K4 jig; you may need to adapt the dimensions and workpiece support height to suit your jig. You can cut all the parts from a quarter sheet of 1/2"-thick Baltic birch plywood. Purchase the continuous hinge at a home center and cut it to 20" long. (See **Source** bottom for the draw catches.)

To help choose the right screw for any job, photocopy the chart below and attach it inside your organizer with spray adhesive. 🌿

Pocket-Hole Screw Guide	
Material Thickness	Screw Length
1/2"	1"
5/8"	1"
3/4"	1 1/4"
7/8"	1 1/2"
1"	1 1/2"
1 1/8"	1 1/2"
1 1/4"	2"
1 3/8"	2"
1 1/2"	2 1/2"

Use fine-thread screws for hardwoods.  
Use coarse-thread screws for softwoods, MDF, particleboard, and plywood.

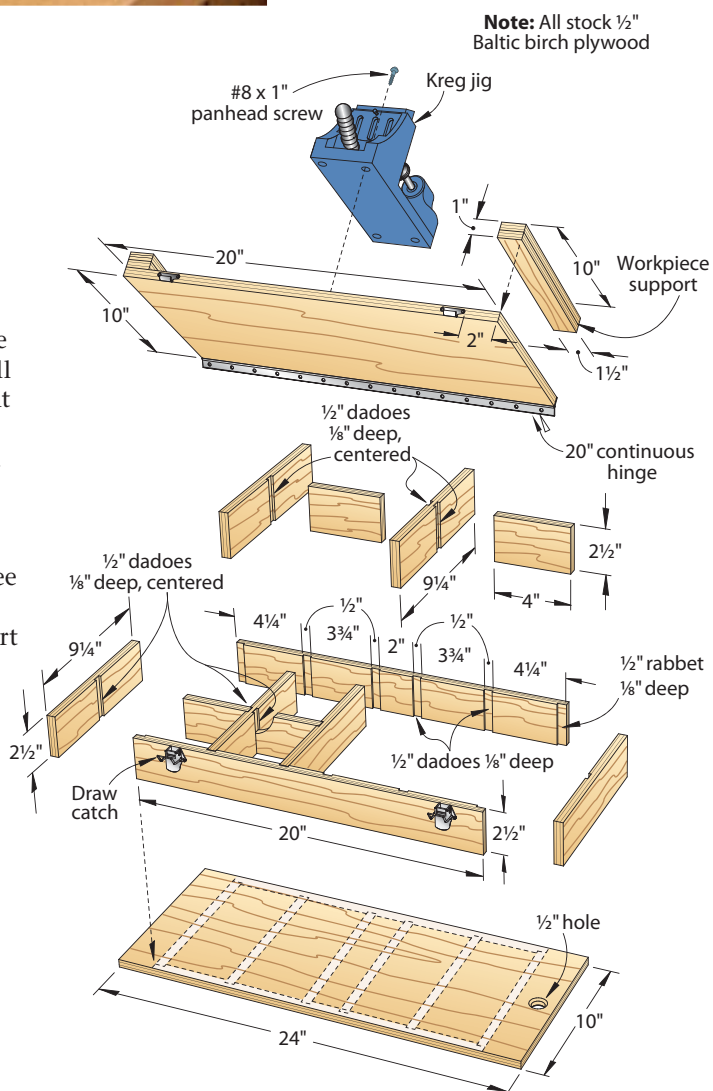

**Source**  
**Latches:** Nonlocking draw catch no. 1889A34 (2), \$4.66, McMaster-Carr, 630-833-0300 or mcmaster.com.

# PowerLift™

## The world's first Motorized Router Lift.

### Only The PowerLift...

lets you do true **Hands Free Plunge Cutting**. Raise the spinning router bit into the wood... *on the fly!* No cranks or handles.



• Pre-mounted 1/4" thick Aluminum Router Table Insert

### Only The PowerLift...

has a bi-directional **Electronic Foot Pedal**, that allows you to make micro-adjustments to a spinning router bit (within .005") for real precision.



Only The PowerLift has a **Digital Control Panel** (with mounting arm included), so you can set the speed, direction, and height of the lift.



### Only The PowerLift...

DC motor action allows you to change the router bit above the table in seconds.



**ONLY AT MLC'S!**

ROUTER NOT INCLUDED

• Make repeatable plunge cuts for mortises and dados. The built in **Depth Stop** sets the maximum height the bit can protrude above the table.

• Tap the footswitch to make incremental passes, achieving clean cuts without turning off the router.



• Make your table a mortising machine. A jig that controls the work piece up top, combined with raising the spinning bit via the footswitch yields perfect mortises.

**PowerLift • #9450.....\$389.95**

### "Fast, Smooth Mortises"

Our solid carbide Spiral Upcut Router Bit Set cuts mortise and tenons cleanly and quickly. Long lasting micrograin carbide also cuts composites, laminates and more. The 1/2" shank bits are 1/4", 3/8" and 1/2" in diameter.



#200.....\$69.95

### "Top Table and Fence"

The customizable Router Table Top with Fence features a 24" x 32" tabletop, miter slot, T-tracks, high split 36" long fence, and Aluminum Router Plate with guide pin.



STAND NOT INCLUDED

Tabletop, Fence & Router Plate #2393.....\$189.95

PowerLift, Tabletop & Fence #2200 SAVE \$40.....\$519.95

### "45 Classic Cut Profiles"

MLCS 45 piece, carbide tipped Router Bit Set includes straight, round over, chamfer, cove, ogee, dovetail, round nose... 20 distinct profiles in all! Wood storage box included. FREE lube!

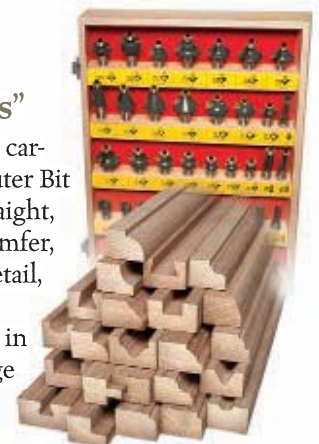

1/4" shank • #6074.....\$119.95  
1/2" shank • #8374.....\$119.95

Now at [MLCSwoodworking.com](http://MLCSwoodworking.com)

1-800-533-9298  
PROFESSIONAL ROUTER BITS & WOODWORKING PRODUCTS



FREE SHIPPING!  
IN CONTIGUOUS USA • P.O. BOX 165 DJ, HV, PA, 19006 \*2011

# A Must Have Catalog for Every Woodworker!

## Functional Hardware



## Kitchen Organizers



**Also see:**

- Locks • Lighting
- Abrasives
- Bar Rail
- Fasteners
- Shelf brackets and much more...

## Tools



## Woodworker's Hardware

woodworkershardware.com  
1-800-383-0130

Request a FREE catalog today!



# Epilog Laser and PhotoLaser Plus

Systems starting at \$7,995!



We've combined Epilog Laser's unbeatable engraving quality with CADlink's powerful laser photo processing software, PhotoLaser Plus.

View an online demonstration of PhotoLaser Plus and see how it will provide stunning photo engraving results at [www.epiloglaser.com/bhg.htm](http://www.epiloglaser.com/bhg.htm).

sales@epiloglaser.com • 888-437-4564

# 4-WAY MONEY MAKER

## MOLDS • PLANES • SANDS • SAWS



Now, turn a \$5.00 rough board into \$75.00 worth of high-dollar molding in just minutes. Make over 500 standard patterns, curved molding, tongue & groove, picture frame stock, any custom design. **QUICKLY CONVERTS** from Molder/Planer to Drum Sander or powerfeed Multi-Blade Ripsaw. Made in U.S.A. 5-Year Warranty. Choose from 12", 18" or 25" models.

### NEW! SHAPE 3 SIDES IN 1 PASS!

**NEW 3-Side Molding System** turns your Woodmaster into a POWERFUL 3-SIDE MOLDER that efficiently & AFFORDABLY cuts T&G flooring, paneling, & more!

**NEW!**  
3-Side Molding System



- Shape 3 sides per pass!
- Over 500+ Molding Patterns!
- RISK FREE 30-Day Trial Offer!
- Highest Profit: MAKE CURVED MOLDING!

### Own a 4-in-1 MOLDING FACTORY!



Quick-Change Molding Head



Commercial-Duty Thickness Planer



Power-Feed Drum Sander



Gang Ripsaw Attachment

Get Your FREE DVD & BUSINESS STARTER KIT!  
**CALL TOLL FREE 1-800-821-6651**

Ext. P355

Woodmaster Tools, Inc. Dept. P355, 1431 N. Topping Ave., Kansas City, MO 64120 [www.woodmastertools.com](http://www.woodmastertools.com)





# WOODCRAFT®



For more information call 800-344-3348,  
visit [www.woodcraftfranchise.com](http://www.woodcraftfranchise.com),  
or email: [WoodcraftFranchise@woodcraft.com](mailto:WoodcraftFranchise@woodcraft.com)

## "When I think about owning my own business ...

When woodworking is your passion, and owning your own business is your goal, Woodcraft can help you take your skill and expertise to the retail level.

*... I think of Woodcraft"*

Carve a niche for yourself in woodworking with a Woodcraft retail store. It is difficult to overstate the importance of a brand name with a reputation for quality. The Woodcraft name is a tremendous asset. If you are a woodworker, you already know what we mean.

Now, after more than 80 years, the Woodcraft name is even more recognizable than at any other time in our history. Are you seriously looking for a franchise opportunity? Are you passionate about woodworking? Would you like to consider opening a store in your area?

**Contact us today to find out how to open the door to your Woodcraft Retail Store!**



Woodcraft Franchise, LLC  
1177 Rosemar Road, P.O. Box 245  
Parkersburg, WV 26102-0245

F11W103Q

**RETAIL FRANCHISE OPPORTUNITIES™**

# WIN a trip of a lifetime with NOVA™

## WOODTURNING CRUISE AUGUST 2011

The most popular brand in woodturning for over 25 years brings you the chance to win a place on a woodturning cruise along Norway's famed western coast



4200 28th Street North, Saint Petersburg,  
FL 33714-3922, USA. Ph: 727 954 3433  
Enter now at [www.winwithnova.com](http://www.winwithnova.com)  
or see instore at participating retailers



Add versatility to your projects  
with our new Table Slides.



Come Visit us at KBIS!

April 26th - 28th

Booth #C4577

YOUR NEW SOURCE FOR TABLE SLIDES



TABLE  
SLIDES

EQUALIZER  
SLIDES

[WWW.BUN-FEET.COM](http://WWW.BUN-FEET.COM)

866.963.5580

# “Wheel”-easy Shop in a Box

For about \$165 in materials, build this accommodating cabinet to store a small-shop's worth of tools, hardware, and supplies.

**BASIC-BUILT™**  
GREAT PROJECTS MADE SIMPLE.



# WHAT YOU'LL NEED

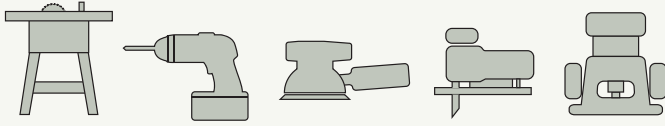

Materials: Two and one-half sheets of 3/4" plywood, one-half sheet of 1/4" plywood, one 1x6x120" pine or poplar board, four casters and screws (see details on page 37).

## PROJECT HIGHLIGHTS

- Overall dimensions: 40" long x 18" deep x 36" high.
- Learn how to size parts correctly when working with undersize plywood thicknesses.
- Simple joinery—mostly glue-and-screw assembly.
- When removed from the cabinet, drawers nest together for safe portage.

## COST

- We paid \$165 for everything and purchased high-quality, void-free plywood. You could save by using a lesser-grade plywood.

Got tools and "stuff" all over your workshop or garage? Round it all up, get it organized, and make it mobile with this simple-to-build project. Each of the bins has two handles and slides out completely so you can take one or more to a job location. Or, remove all of them to lighten the cart for easy carrying upstairs or loading into your vehicle.

### Start with the case

1 From 3/4" plywood, cut the case shelf supports (A) and ends (B) to the sizes listed [Materials List, page 37]. For the

best appearance and void-free surfaces and edges, we used birch plywood from a home center.

2 Using a 3/8" rabbeting bit in your handheld router, rout a 3/8" rabbet 1/4" deep along the back inside edge of two shelf supports (A) to receive the plywood back (G) [Drawing 1]. Glue and clamp the

supports to the ends (B), positioning the rabbets where shown.

3 Refer to the Shop Tip on page 34. Then, determine the exact width for the two tops and the bottom (C) by measuring the width of a shelf support/end assembly (A/B). (Ours measured approximately 17 15/16") Rip the tops and bottom

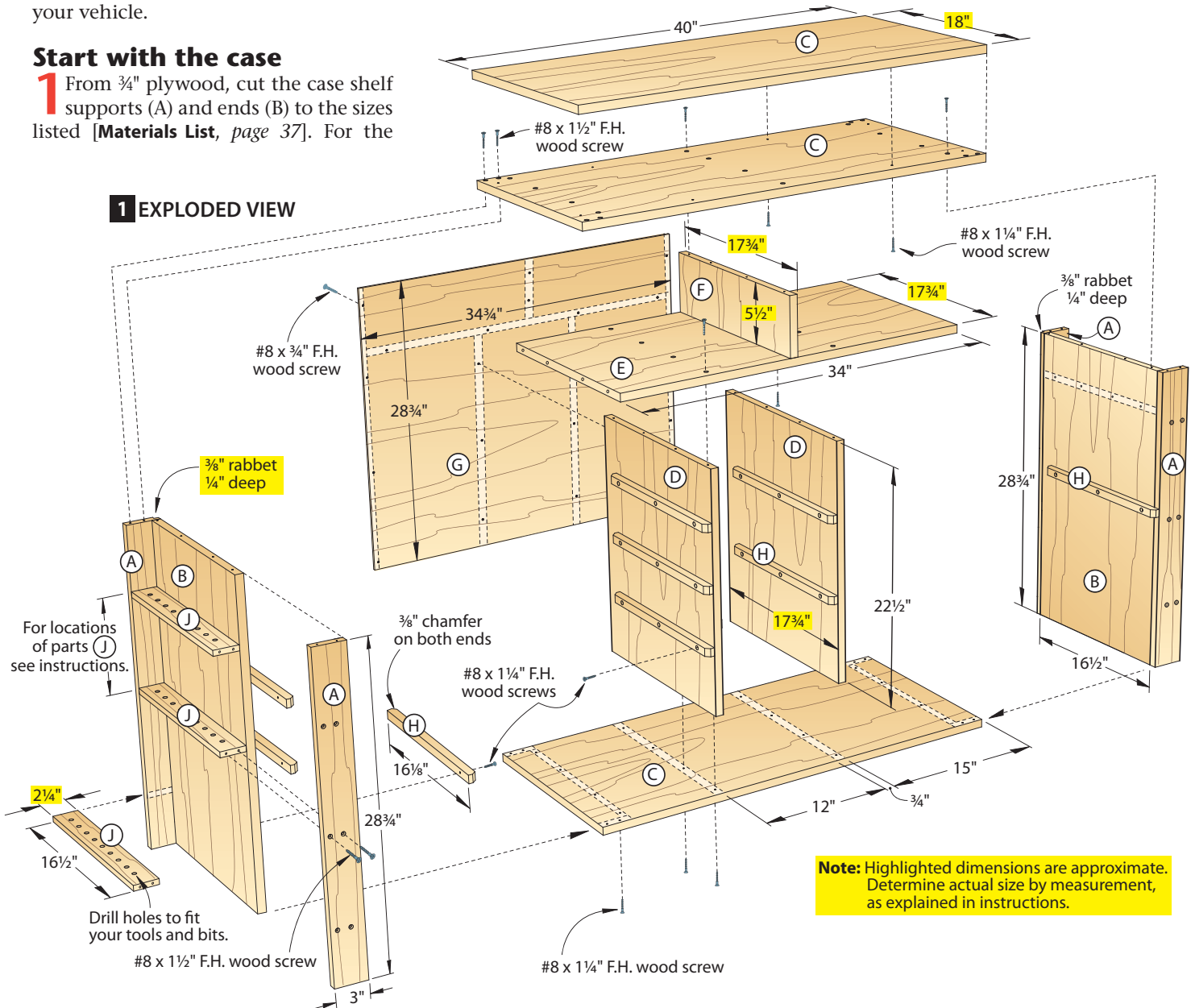

**Note:** Highlighted dimensions are approximate. Determine actual size by measurement, as explained in instructions.

## MOUNT THE END ASSEMBLIES

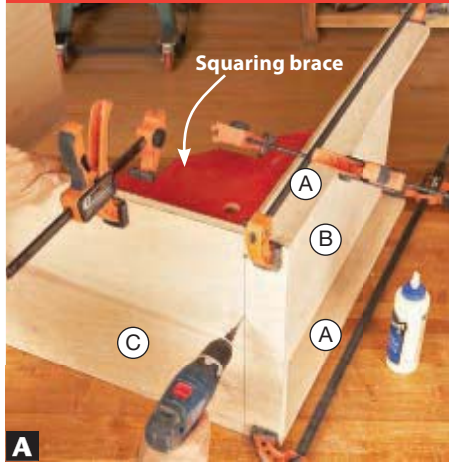

**A** Glue, screw, and clamp the end assemblies (A/B) to the bottom (C). Use a squaring brace to keep the assemblies 90° to the bottom.

## INSTALL THE SHELF

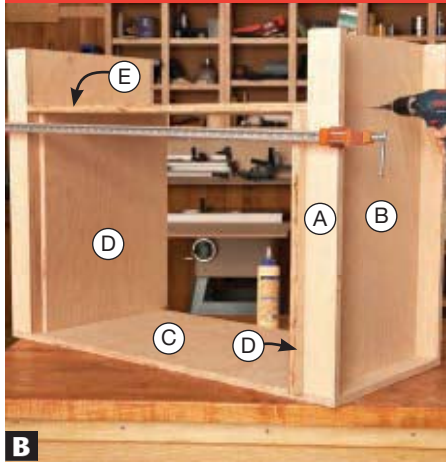

**B** Using the large dividers (D) as spacers to position the shelf (E), drive screws through the case ends (B) and into the shelf.

## SECURE THE LARGE DIVIDERS

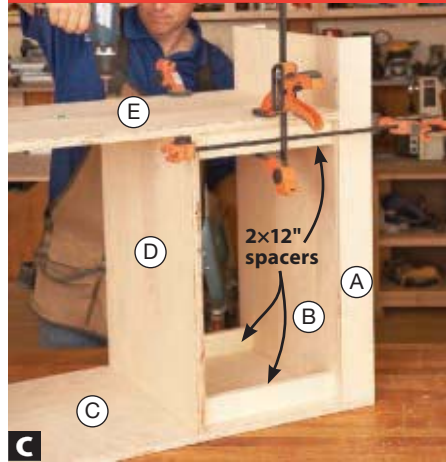

**C** Use 2×12" spacers to align the large dividers (D) in the case. Drive screws through the bottom (C) and shelf (E) into the dividers.

to your measured width and crosscut to a length of 40". Now attach the end assemblies to the bottom [Photo A, Drawing 1]. **Quick Tip!** Drill countersunk shank and pilot holes for the #8 screws in this project. This will prevent splitting the plywood and ensure a smooth surface.

**4** To determine the precise width for the large dividers (D), measure from the front face of a front shelf support (A) to the rabbet on the back shelf support. Rip the dividers' width to your measurement and crosscut to a length of 22½". Next, rip the width of the shelf (E) to the same width as the dividers and crosscut to a length of 34". (It's a good idea to measure between the case ends to verify the length for the shelf.) Now, install the shelf [Photo B].

**5** From ¾" scrap, cut four 2×12" spacers to position the large dividers (D) in the case where dimensioned [Drawing 1]. Screw a divider in place [Photo C]. Use the spacers again to secure the remaining divider. **Quick Tip!** Be sure to use spacers. The spacers ensure correct

alignment of the dividers so the drawers will slide freely in the case.

**6** Measure for the length of the small divider (F) [Photo D]. Crosscut the divider's length to your measurement and the same width as the large dividers (D). Center the divider on the shelf (E) end to end, and screw it in place through the bottom of the shelf.

**7** Position the lower top (C) on the case. Drill mounting holes and drive screws through it, centered into the ends of the end assemblies (A/B) and small divider (F). Then, align the upper top (C) on the lower top and screw it in place. You'll need to angle your drill slightly when drilling the holes and driving the screws along the front and back edges.

**Quick Tip!** Do not glue the upper top to the lower top. By omitting glue, you can replace the top should it become too worn. Also, by securing the top from the lower top, you'll have a smooth, fastener-free work surface.

**8** From ¼" birch plywood, cut the back (G) to fit the rabbeted opening. Although the dimensions should be

exact, it's a good idea to measure the opening to make sure. Set the back aside.

## Next up: Guides, stops, and shelves

**1** To form 30 drawer guides (H), crosscut five 16⅞"-long blanks from a 1×6×120" nominal (¾×5½×120" actual) pine or poplar board. Save the remainder for use later. Using a 45° chamfer bit in your router, rout a ⅜" chamfer across both ends of each blank. Now, using your tablesaw, rip ¾"-wide guides from each blank [Photo E]. You'll mount 12 of the guides inside the case [Drawing 1]. Set aside the remaining guides for installation on the drawer bottoms. These guides allow the drawers to interlock when stacked so that you can safely carry them about when needed.

**2** From ¼" scrap, cut 5⅞×10", 7½×10", and 11¼×10" spacers for positioning the drawer guides (H) in the case where dimensioned [Drawing 2]. **Quick Tip!** Cut the spacers precisely. This will ensure that the drawers will fit correctly when cut to the listed sizes later. Using the

## SHOP TIP

### The skinny on working with undersize plywood

Ever cut plywood parts to the specified sizes and found that some parts didn't fit together correctly? That's because the thickness of nearly all plywood measures slightly less than stated, so you may need to tweak the dimensions of some parts to fit properly. Follow these guidelines for identifying the affected parts and avoiding problems.

- Never pre-cut all of a project's plywood parts to the specified sizes because some of the sizes may be approximate.
- Look over the project drawings beforehand and identify the parts that need measurement to fit correctly. Parts that install between other parts, such as shelves, dividers, and drawers, and parts that match the width or length of subas-

semblies are prime targets. Circle or highlight the applicable dimensions, as we did on the drawings and the Materials List, as a reminder to measure for the exact size during assembly.

- Cut only the parts that have both exact width and length dimensions first. Assemble these parts (dry-assembly is fine), and measure for the custom-fit parts.

## MEASURE FOR THE SMALL DIVIDER

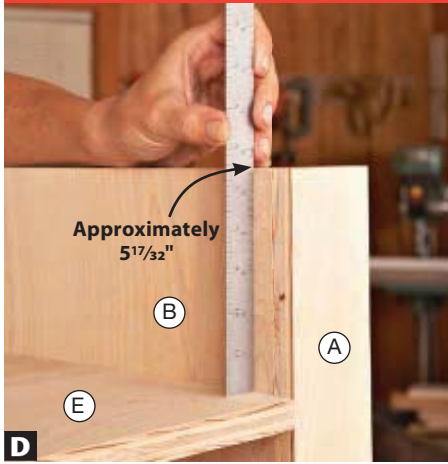

**D** Measure from the top of the case end (B) to the shelf (E) to find the actual width of the small divider (F).

## RIP THE DRAWER GUIDES

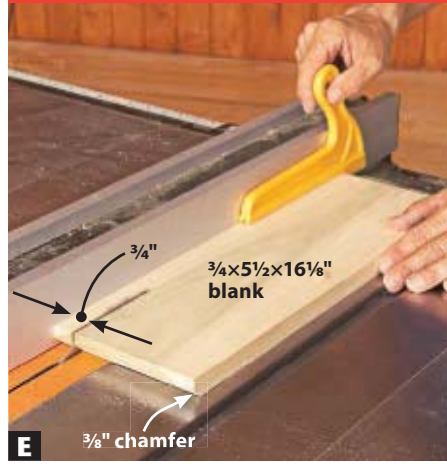

**E** With your table saw fence positioned  $\frac{3}{4}$ " from the inside of the blade, rip six drawer guides (H) from each of the five  $\frac{3}{4} \times 5\frac{1}{2} \times 16\frac{1}{8}$ " blanks.

## MOUNT THE DRAWER GUIDES

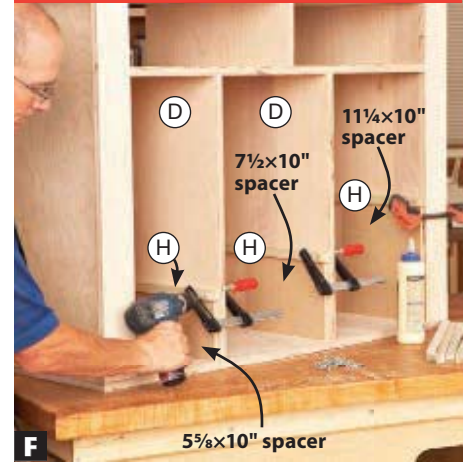

**F** Position the drawer guides (H) on spacers, flush with the front of the case. Glue and screw the guides to the case.

appropriate spacer, glue and screw the guides in the case opening for the large drawer, and only the bottom pair of guides in the openings for the small and medium-size drawers [Photo F]. Next, trim the  $5\frac{5}{8}$ "-tall spacer to  $4\frac{7}{8}$ " and the  $7\frac{1}{2}$ "-tall spacer to  $6\frac{3}{4}$ ". Now install

the remaining guides in the small and medium openings where shown.

**3** Measure the openings between the case ends (B) and small divider (F). From your leftover 1x6, rip two  $\frac{1}{4}$ "-wide strips for the shelf stops (I) [Drawing 2]. Crosscut the strips to length to fit your

openings. Glue the stops in place, flush with the case front.

**4** To determine the width for the end shelves (J), measure from the outside edge of a shelf support (A) to the case end (B). Then rip six shelves to the measured width and crosscut them to  $16\frac{1}{2}$ " in length. Before mounting the shelves, lay out the tools that you wish to hang on the shelves, mark centerpoints where needed, and drill the appropriate-size holes. Mount the shelves at suitable locations to accommodate your tool lengths by driving screws through the shelf supports and centered into the ends of the shelves.

## 2 CASE ASSEMBLY

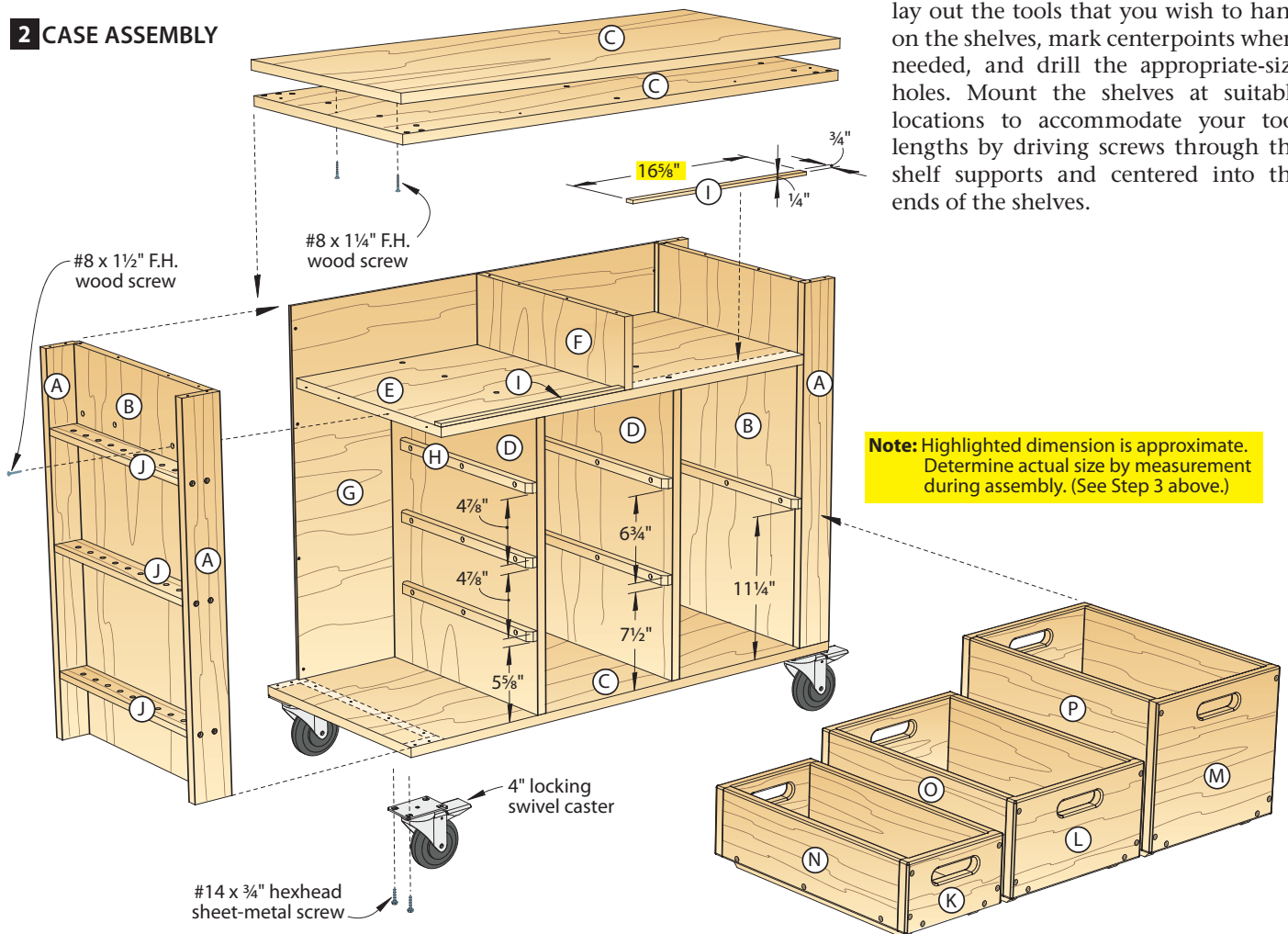

## Fabricate the drawers

**1** From  $\frac{3}{4}$ " plywood, rip the small, medium, and large drawer fronts/backs (K, L, M) to the listed widths. Next, crosscut the medium and large fronts/backs (L, M) to the listed length of  $11\frac{7}{8}$ ". Now crosscut the small fronts/backs (K) to a length  $\frac{1}{8}$ " less than the measured opening. (Our small fronts/backs were approximately  $\frac{1}{16}$ " longer than the listed approximate length of  $8\frac{3}{8}$ ".)

**2** To form the centered grip openings in the fronts/backs (K, L, M), mark centerpoints for 1" holes at the ends of the openings where dimensioned [Drawing 3]. Bore the holes using a spade or Forstner bit in your drill and a backer board to prevent tear-out. If you have a drill press, it's ideal to use it with a fence and stopblock for this. Draw tangent lines to connect the holes. Now complete the openings [Photo G].

**3** Smooth the openings in the fronts/backs using a flat file and a piece of  $\frac{3}{4}$ "-diameter dowel wrapped with 100- or 120-grit sandpaper. Rechuck your router with a  $\frac{1}{8}$ " round-over bit. Now rout along the edges of the openings on both sides of the fronts/backs [Drawing 3].

**4** From  $\frac{3}{4}$ " plywood, cut the small, medium, and large drawer sides (N, O, P) to the sizes listed. (The widths must match the fronts/backs.)

**5** To determine the widths for the small bottoms (Q) and the medium/large bottoms (R) for the drawers, hold two small scrap pieces of your  $\frac{3}{4}$ " ply-

## SAW OUT THE DRAWER OPENINGS



**G** Using your jigsaw, cut along the inside of the lines on the fronts/backs (K, L, M) to remove the waste and complete the openings.

## ATTACH THE DRAWER FRONTS/BACKS

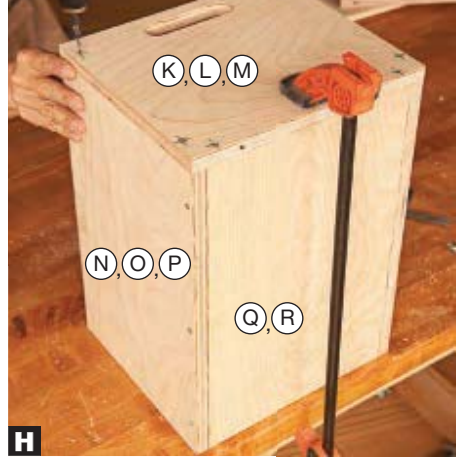

**H** Clamp a drawer front to the side/bottom assembly, drill pilot holes, and drive screws. Repeat the process to add the back.

wood tightly together and measure the combined thickness. Then, subtract this measurement from the length of the corresponding drawer fronts/backs—part K for the small drawers and parts L and M for the medium and large drawers. (Your drawer-bottom widths will be slightly greater than the listed approximate dimensions.) Now, rip the bottoms to the appropriate widths and crosscut them to the listed length of  $16\frac{1}{4}$ ".

**6** Sand all of the drawer parts to 180 grit. Then, keeping the ends of the parts aligned, glue and screw the corresponding sides to the bottoms: small drawer parts N to Q, medium drawer parts O to R, and large drawer parts P to R.

**Quick Tip!** Let the glue dry before driving the screws. This will prevent parts from slipping when screwing them together. 

**7** Mark centerpoints on the drawer fronts/backs (K, L, M) for the screws, where shown [Drawing 3]. Glue and screw the fronts/backs to the corresponding side/bottom assemblies (N/Q, O/R, P/R) [Photo H]. Drive the screws at the bottom first. Then, if needed, slightly flex the sides to align them with the ends of the fronts and backs, and drive the screws at the ends.

**8** Glue and screw a pair of the remaining drawer guides (H) to the bottoms of the small, medium, and large drawers.

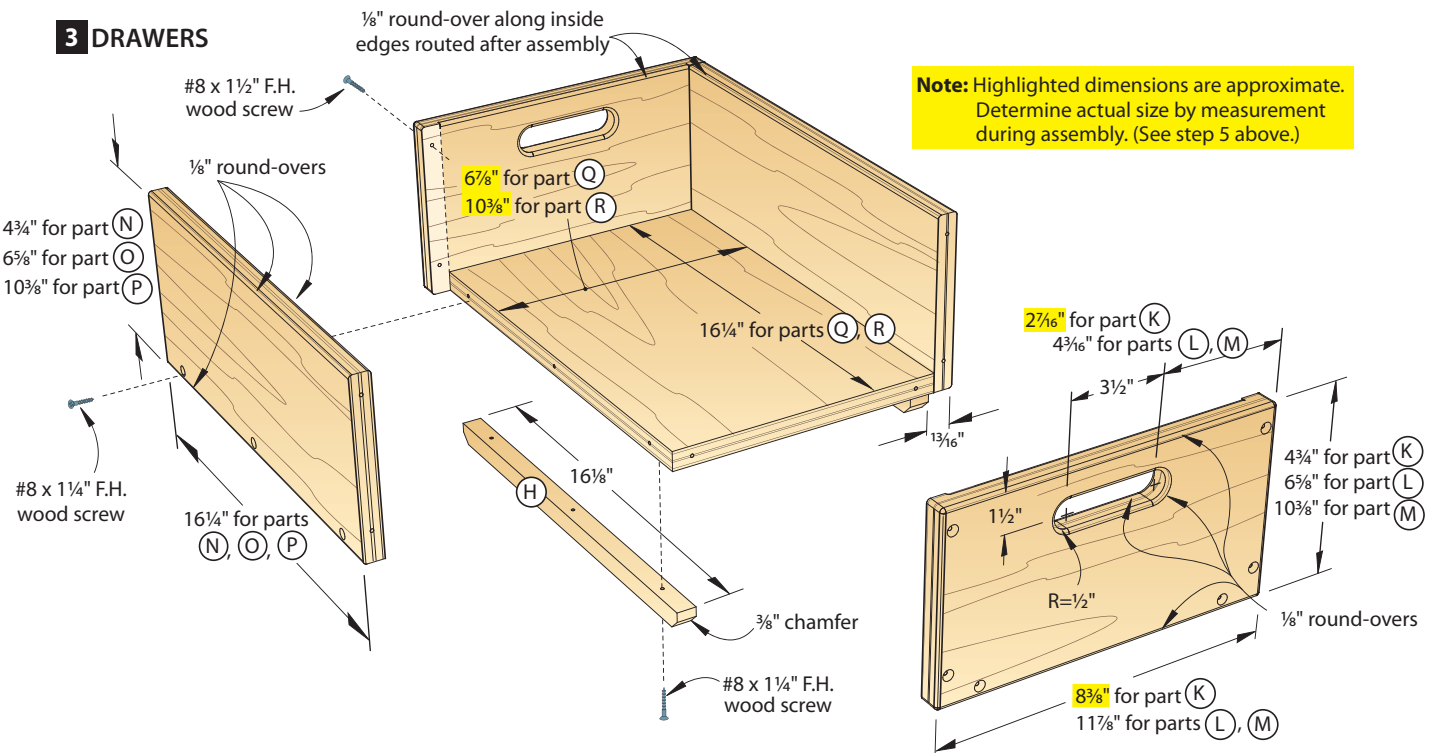

**Note:** Highlighted dimensions are approximate. Determine actual size by measurement during assembly. (See step 5 above.)

Position the guides  $1\frac{3}{16}$ " from the outside face of the sides (N, O, P) and  $1\frac{3}{16}$ " back from the outside face of the fronts (K, L, M), where dimensioned [Drawing 3]. This will allow the guides to fit inside the other drawers when stacked.

**9** Rout  $\frac{1}{8}$ " round-overs along the inside and outside edges of the drawers, where shown.

## A few final details

**1** Finish-sand the cart, drawers, and back (G) to 180 grit, and remove the dust. Drill pilot holes and screw the back to the cart where shown [Drawing 1]. Apply a finish if you wish. We applied boiled linseed oil, which we easily can reapply whenever needed.

**2** Finally, screw-mount 4" locking swivel casters to the case bottom (C) [Drawing 2]. Align the caster mounting plates  $\frac{1}{8}$ " from the ends and edges of the bottom. Now round up your tools, load up the cart, and slide in the drawers. Congrats—you're ready to roll fully organized to your next project! 🌲

## MORE RESOURCES

### RELATED ARTICLES AND PLAN

- Find more Basic-Built projects and information at [\\$](http://woodmagazine.com/basicbuilt)
  - Free squaring brace plan at [\\$](http://woodmagazine.com/brace)
- (\$=Some project plans in this section require a small fee for download.)

### FREE VIDEO

- How to Handle Sheet Goods [\\$](http://woodmagazine.com/sheetgoods)



Produced by **Owen Duvall** with **Jeff Mertz**  
Project design: **Jeff Mertz**  
Illustrations: **Roxanne LeMoine; Lorna Johnson**

## Materials List

Part	Case	FINISHED SIZE			Matl.	Qty.
		T	W	L		
A	shelf supports	$\frac{3}{4}$ "	3"	28 $\frac{3}{4}$ "	BP	4
B	ends	$\frac{3}{4}$ "	16 $\frac{1}{2}$ "	28 $\frac{3}{4}$ "	BP	2
C	tops/bottom	$\frac{3}{4}$ "	18"	40"	BP	3
D	large dividers	$\frac{3}{4}$ "	17 $\frac{3}{4}$ "	22 $\frac{1}{2}$ "	BP	2
E	shelf	$\frac{3}{4}$ "	17 $\frac{3}{4}$ "	34"	BP	1
F	small divider	$\frac{3}{4}$ "	17 $\frac{3}{4}$ "	5 $\frac{1}{2}$ "	BP	1
G	back	$\frac{1}{4}$ "	28 $\frac{3}{4}$ "	34 $\frac{3}{4}$ "	BP	1
H*	drawer guides	$\frac{3}{4}$ "	$\frac{3}{4}$ "	16 $\frac{1}{8}$ "	P	30
I*	shelf stops	$\frac{1}{4}$ "	$\frac{3}{4}$ "	16 $\frac{3}{8}$ "	P	2
J	end shelves	$\frac{3}{4}$ "	2 $\frac{1}{4}$ "	16 $\frac{1}{2}$ "	BP	6
<b>Drawers</b>						
K	small fronts/backs	$\frac{3}{4}$ "	4 $\frac{3}{4}$ "	8 $\frac{3}{8}$ "	BP	8
L	medium fronts/backs	$\frac{3}{4}$ "	6 $\frac{5}{8}$ "	11 $\frac{7}{8}$ "	BP	6
M	large fronts/backs	$\frac{3}{4}$ "	10 $\frac{3}{8}$ "	11 $\frac{7}{8}$ "	BP	4
N	small sides	$\frac{3}{4}$ "	4 $\frac{3}{4}$ "	16 $\frac{1}{4}$ "	BP	8
O	medium sides	$\frac{3}{4}$ "	6 $\frac{5}{8}$ "	16 $\frac{1}{4}$ "	BP	6
P	large sides	$\frac{3}{4}$ "	10 $\frac{3}{8}$ "	16 $\frac{1}{4}$ "	BP	4
Q	small bottoms	$\frac{3}{4}$ "	6 $\frac{7}{8}$ "	16 $\frac{1}{4}$ "	BP	4
R	medium/large bottoms	$\frac{3}{4}$ "	10 $\frac{3}{8}$ "	16 $\frac{1}{4}$ "	BP	5

\*Parts initially cut oversize. See the instructions.

Highlighted dimensions are approximate. See the instructions.

**Materials key:** BP—birch plywood, P—pine or poplar.

**Supplies:** #8x1 $\frac{1}{4}$ " and #8x1 $\frac{1}{2}$ " flathead wood screws; #14x $\frac{3}{4}$ " hexhead sheet-metal screws (16); 4" locking swivel casters (4).

**Bits:**  $\frac{1}{8}$ " round-over, 45° chamfer, and  $\frac{3}{8}$ " rabbeting router bits; 1" spade or Forstner bit.

## Cutting Diagram

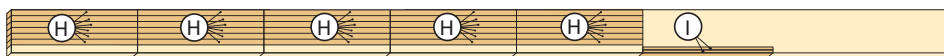

$\frac{3}{4}$  x 5 $\frac{1}{2}$  x 120" Pine or poplar (1x6x10')

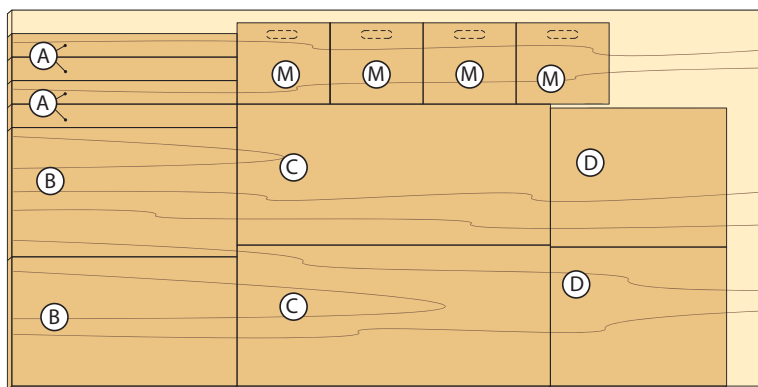

$\frac{3}{4}$  x 48 x 96" Birch plywood

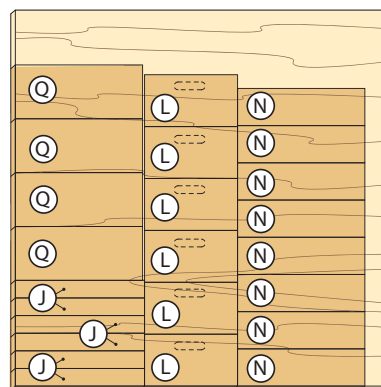

$\frac{3}{4}$  x 48 x 48" Birch plywood

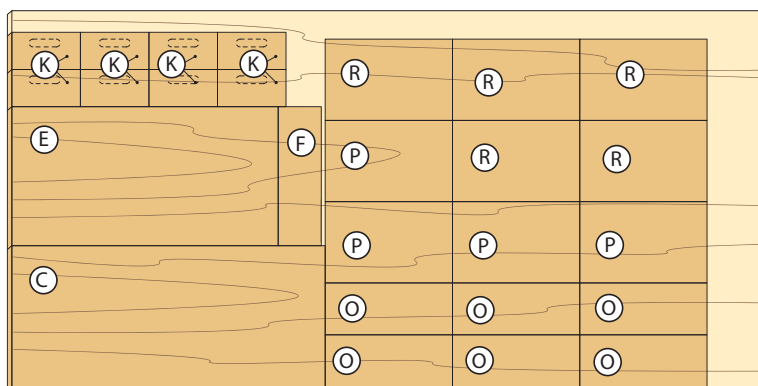

$\frac{3}{4}$  x 48 x 96" Birch plywood

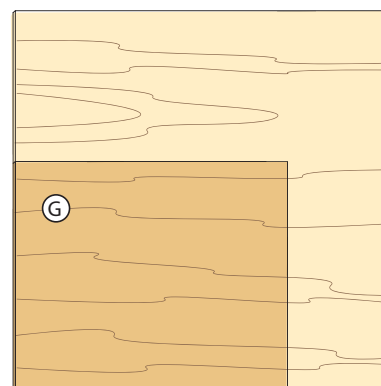

$\frac{3}{4}$  x 48 x 48" Birch plywood

# Corner Curio

Glass, mirrors, and cherry wood give this angled cabinet class.

**T**hough it may appear to be one cabinet, this collectible showcase is actually two identical, stacked units. So once you set up to cut the pieces for the bottom unit, simply cut a second set of identical pieces for the top unit. As shown at *left*, mirrors in the backs and bottoms, and glass shelves and doors add an extra display dimension for showing off treasured pieces. Or for a warmer appearance, swap the mirrors for stained plywood panels, as shown *below*.

## Start with the cases

**1** From  $\frac{3}{4}$ " plywood (birch if you're adding the mirrors; cherry if not), cut the backs (A) and wide backs (B) with a 45° bevel on one edge of each piece [**Drawing 1**, **Materials List**, page 44].

**2** Make six bevel-clamping blocks [**Shop Tip**, *opposite*]. With help from a squaring brace, glue a back (A) to a wide back (B) [**Photo A**]. (See **More Resources** on page 44 for free plans for a squaring brace.) Drill pilot holes, then screw the wide back to the back [**Drawing 1**]. Repeat for the second case.

**3** Cut a 17"-square blank from  $\frac{3}{4}$ " birch plywood for the bottoms (C). Draw a diagonal line across the blank from corner to corner. Jigsaw or bandsaw along the line and sand the cut edges with a belt sander, checking the fit in the case (A/B). The front edge should be flush

Option with cherry plywood panels in place of the mirrors



## PROJECT HIGHLIGHTS

- Overall dimensions: 21 $\frac{5}{16}$ " wide along each side x 72 $\frac{1}{2}$ " high.
- Built from solid cherry and poplar, and birch plywood.
- Pocket lights and glass shelves brighten the inside of the cabinets.
- Cost of materials: \$420 with mirrors, \$380 with plywood panels.



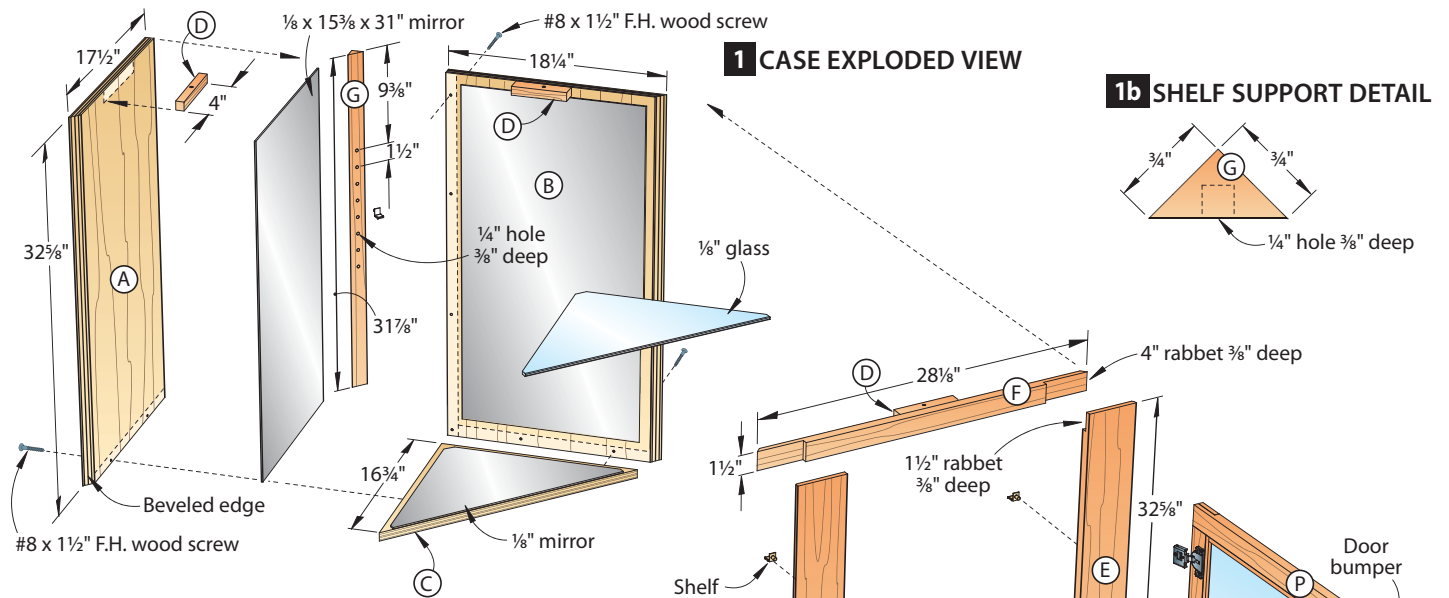

**1a FACE-FRAME STILE DETAIL (Left stile shown)**

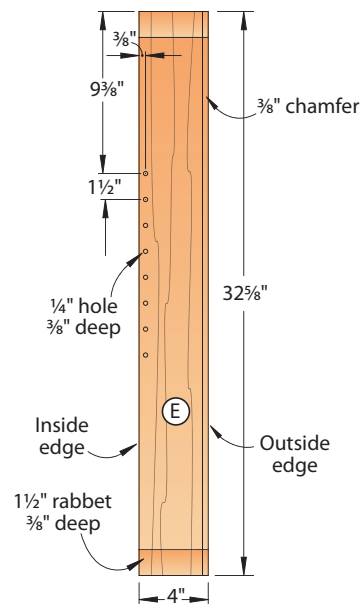

with the bevels at the front. Glue and screw a bottom in each case [Photo B].

**4** Cut six top cleats (D) to size [Drawing 1]. Drill centered mounting holes, then set these aside for attaching the top later.

**5** Cut the face-frame stiles (E) and rails (F) to size [Drawing 1]. Mount a dado set in your tablesaw and cut 3/8"-deep rabbets on the ends of each stile and rail to form lap joints [Drawing 1]. (See **More Resources** on page 44 for more information on cutting lap joints.) Lay out and drill a row of 1/4" shelf-pin holes on the

**SHOP TIP**

**Simple block helps you clamp odd angles**

Clamping directly on the beveled edges of the backs (A,B) can crumple those sharp edges. The bevel-clamping block, shown below, protects the angled edge while keeping clamping pressure parallel to the back. Make six bevel-clamping blocks for assembling this project.

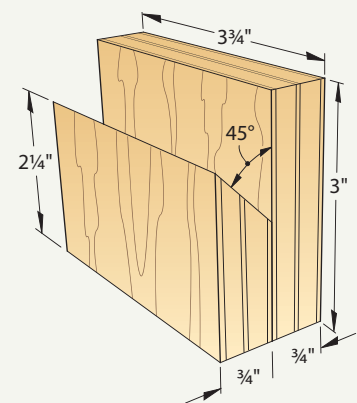

**CLAMP THE BACKS TOGETHER**

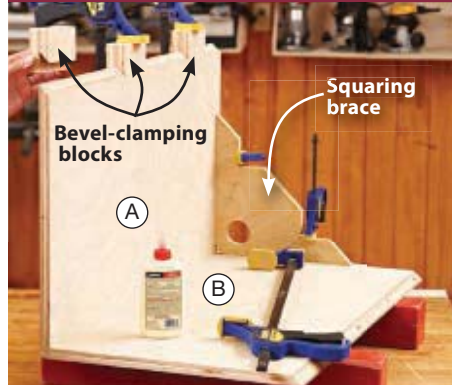

**A** Simplify assembly of the backs (A, B) by using bevel-clamping blocks (Shop Tip, right) and a squaring brace.

**SCREW IN THE BOTTOM**

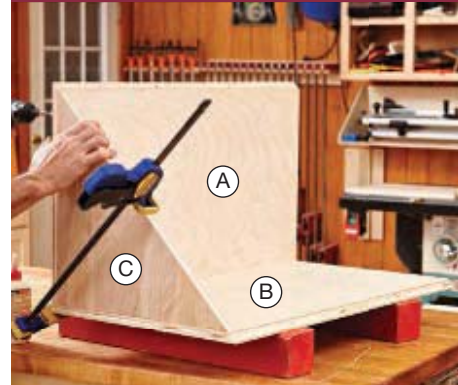

**B** After cutting the bottom (C) to fit, clamp it flush with the bottom edges of the back (A, B) pieces, then glue and screw it in place.

back side of each stile, making sure you end up with mirrored pairs of stiles [Drawings 1 and 1a].

**6** Apply glue to the joints and clamp the face frame, checking that each joint is tight and square [Photo C]. Repeat this process to assemble the face frame for the other case.

**7** After the glue dries on the face frames (E/F), rout a  $\frac{3}{8}$ " 45° chamfer on the back outside edge of each stile (E) [Drawing 1a]. Sand the back side of the face frames to 220 grit.

**8** Screw temporary clamping blocks to the back of the case (A–C) [Photo D]. Apply glue to the beveled front edges of the case, and center the face frame (E/F) side-to-side and flush at the top and bottom of the case. Clamp it in position and let the glue dry. Repeat this process for the second case.

**9** Rip a  $\frac{3}{4} \times 2\frac{1}{2} \times 31\frac{7}{8}$ " blank for the shelf supports (G). Rip two shelf supports from the blank [Photos E, F]. Lay out the shelf-pin holes on the shelf supports

[Drawing 1] and drill them  $\frac{3}{8}$ " deep [Shop Tip, below]. Glue the shelf supports (G) in the back of the cases [Drawing 1].

### Build a base for under the case

**1** Cut the front trim (H) and the back rails (I) to size with 45° miters on the ends of each piece [Drawing 2]. **Quick Tip! Save money on hidden parts.** Because the back rails won't be seen, you can use a less expensive wood such as poplar. Rout a  $\frac{3}{8}$ " chamfer along the top front edge of the front trim.

**2** Dry-assemble the front trim (H) and two back rails (I) and mark locations for #20 biscuit slots centered on each joint. Cut the slots, then glue each joint [Photo G]. Repeat for the other front trim and back rails.

**3** Cut a  $\frac{3}{4} \times 4\frac{1}{2} \times 11$ " blank for the feet (J). Bevel-rip one edge to create a  $\frac{5}{8}$ " chamfer, then rip the blank to a final width of 4". Cut each foot from the blank to a final length of 5" [Drawing 2].

### TRIM OFF A SHELF SUPPORT



E

Tilt your tablesaw blade to 45° and bevel-rip a shelf support (G) from one edge of an oversize blank.

### RIP OFF ANOTHER



F

Cut a shelf support (G) for the other case from the same blank by setting the blade back to 90° and ripping the piece to size.

### ASSEMBLE THE FACE FRAME

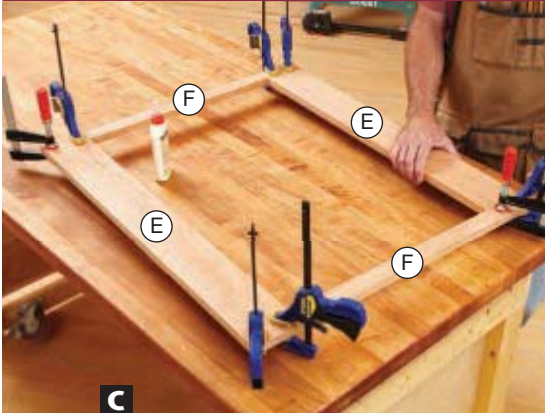

When gluing the wide half-lap joints on the face frame (E/F) use two clamps on each joint, one near the inside and one near the outside.

### GLUE ON THE FACE FRAMES

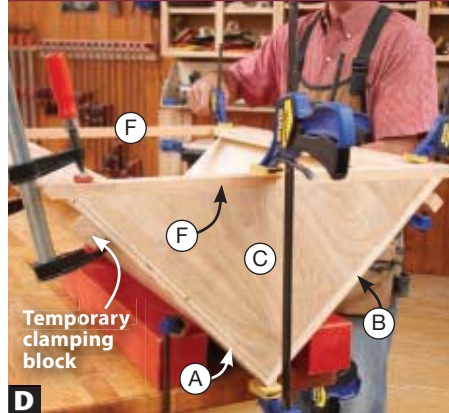

Support a case (A–C) between a couple of blocks on your bench. Then glue the face frames (E/F) to the front of the case.

### SHOP TIP

#### "V" is for victory over hard-to-drill parts

To support the angled shelf supports (G) when drilling, make a 90° V-groove in a 1½"-thick scrap of solid wood. To do this, make intersecting 45° bevel rips on one face of the scrap.

Center the bottom of the V on your drill-press table under the bit, slide the fence up to the block and lock the fence. The V-block cradles the shelf support for rock-solid drilling.

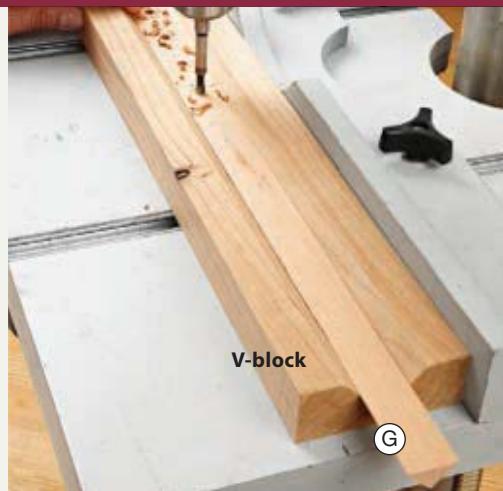

V-block

G

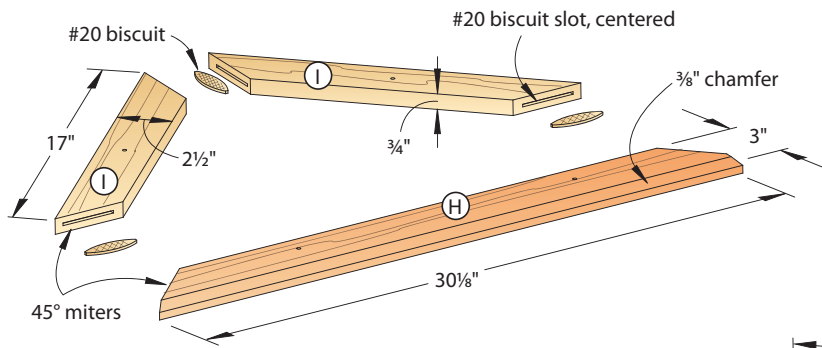

## 2 TRIM AND BASE

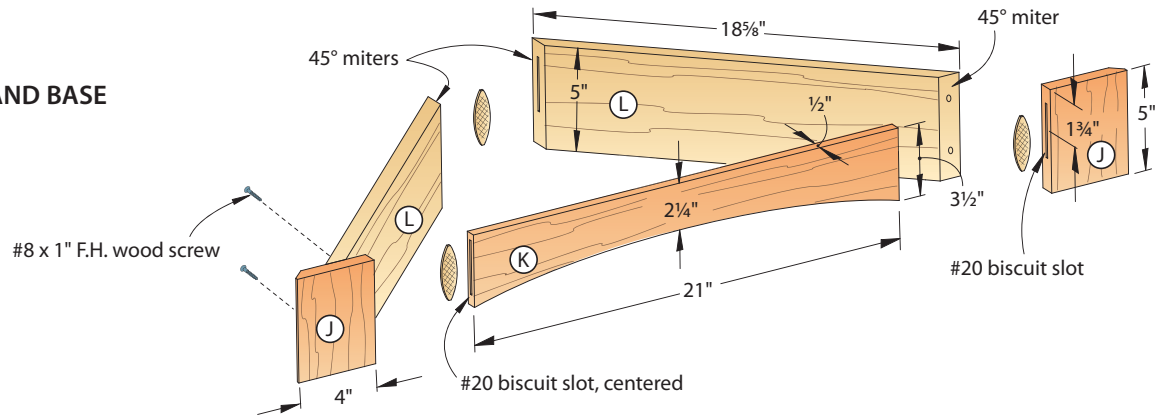

**4** Cut the front rail (K) to size [Drawing 2] and use a fairing stick to lay out the arc on the bottom edge. (See **More Resources** for more information about making and using a fairing stick.) Then cut and sand the arc to the line. Lay out and cut biscuit slots on the front rail (K) and feet (J) where shown and glue the feet to the front rail [Photo H].

**5** Cut the back cleats (L) to size [Drawing 2] and cut biscuit slots in the back corner. Glue the cleats together [Photo I].

**6** Apply glue to the front end of each cleat (L). Then center it on the back of the base-front assembly (J/K) and clamp it in place with a band clamp. Drive 1" screws through the cleats to secure the joints [Drawing 2a, Photo J].

**7** To complete the base, glue one of the frame assemblies (H/I) centered on top of the base frame (J/K/L) [Drawings 2, 4]. Set the other frame assembly aside.

### Start the subassembly

**1** Turn the lower case (A-F) upside down and center the base (H-L) on it. **Note: The miters on the ends of the front trim (H) and the chamfers on the face-frame stiles (E) should be flush.** Drill pilot holes through the front trim and back rails (I) [Drawings 2, 4] and screw the frame in place. Retrieve the other frame (H/I) and screw it to the bottom of the upper case.

**2** Edge-glue a 3/4"-thick blank for the top (M). After the glue dries, cut the

### WRAP IT UP WITH TAPE

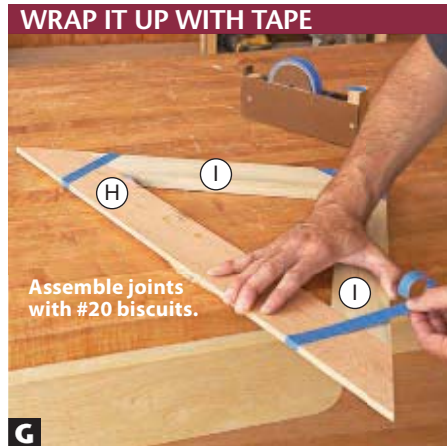

Assemble joints with #20 biscuits.

G

Using painter's tape, clamp the mitered ends of the front trim (H) flush with the edges of the back rails (I).

### PROTECT THE BEVELS

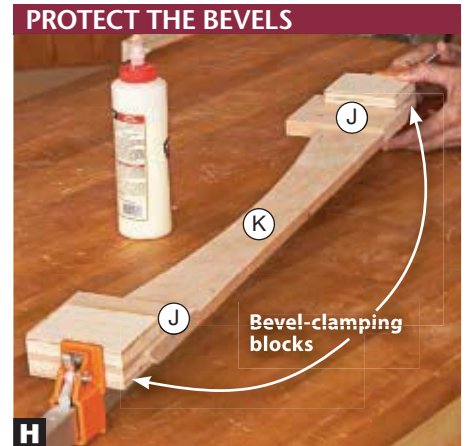

H

Glue the feet (J) to the front rail (K), using the bevel-clamping blocks to protect the sharp points on the bevels from damage.

### SQUARE UP THE BACK OF THE CASE

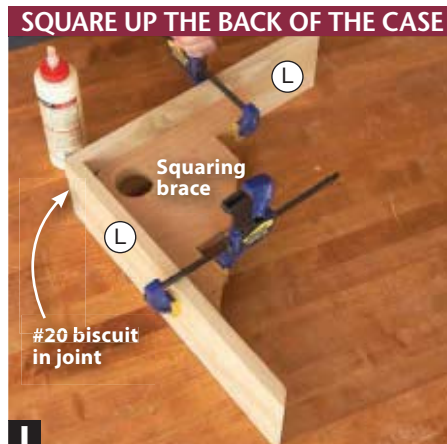

#20 biscuit in joint

I

Join the two back cleats (L) with a biscuit joint and hold them square with a squaring brace while the glue dries.

### ATTACH THE FRONT TO THE BASE



J

Clamp the base-front assembly (J/K) onto the back cleats (L) with a band clamp while driving in screws.

## SHOP TIP

### Perfect pressure for persnickety parts

How do you securely clamp a fragile part, such as the mirrors in this project, without risking part breakage? We placed  $\frac{3}{4}$ "-thick cauls against the mirror being glued, then bent some  $\frac{1}{4}$ "-thick flexible strips of scrapwood to hold the cauls in position while the adhesive dried. Fit one end of each strip into a corner, and bow the strip to put slight clamping pressure on the caul. If the strips slip, cut shallow saw kerfs in the caul to trap the end.



blank to size [Drawing 4] and rout a  $\frac{3}{8}$ " chamfer along the front bottom edge.

**3** Cut a  $\frac{1}{2} \times 2 \times 27\frac{1}{2}$ " blank for the cove trim (N). Rout a  $\frac{3}{8}$ " cove on the edges and ends, then finish-sand the blank. Rip a  $\frac{1}{2}$ "-wide piece of cove trim from each edge of the blank.

### 3a DOOR DETAIL

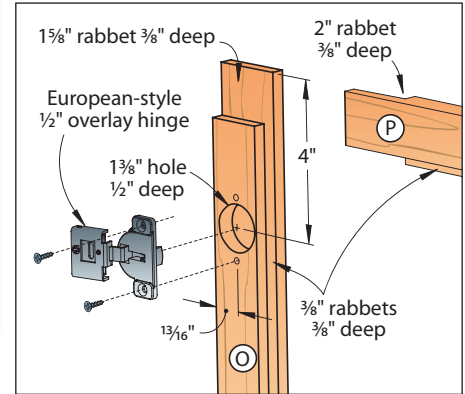

### 3 DOOR

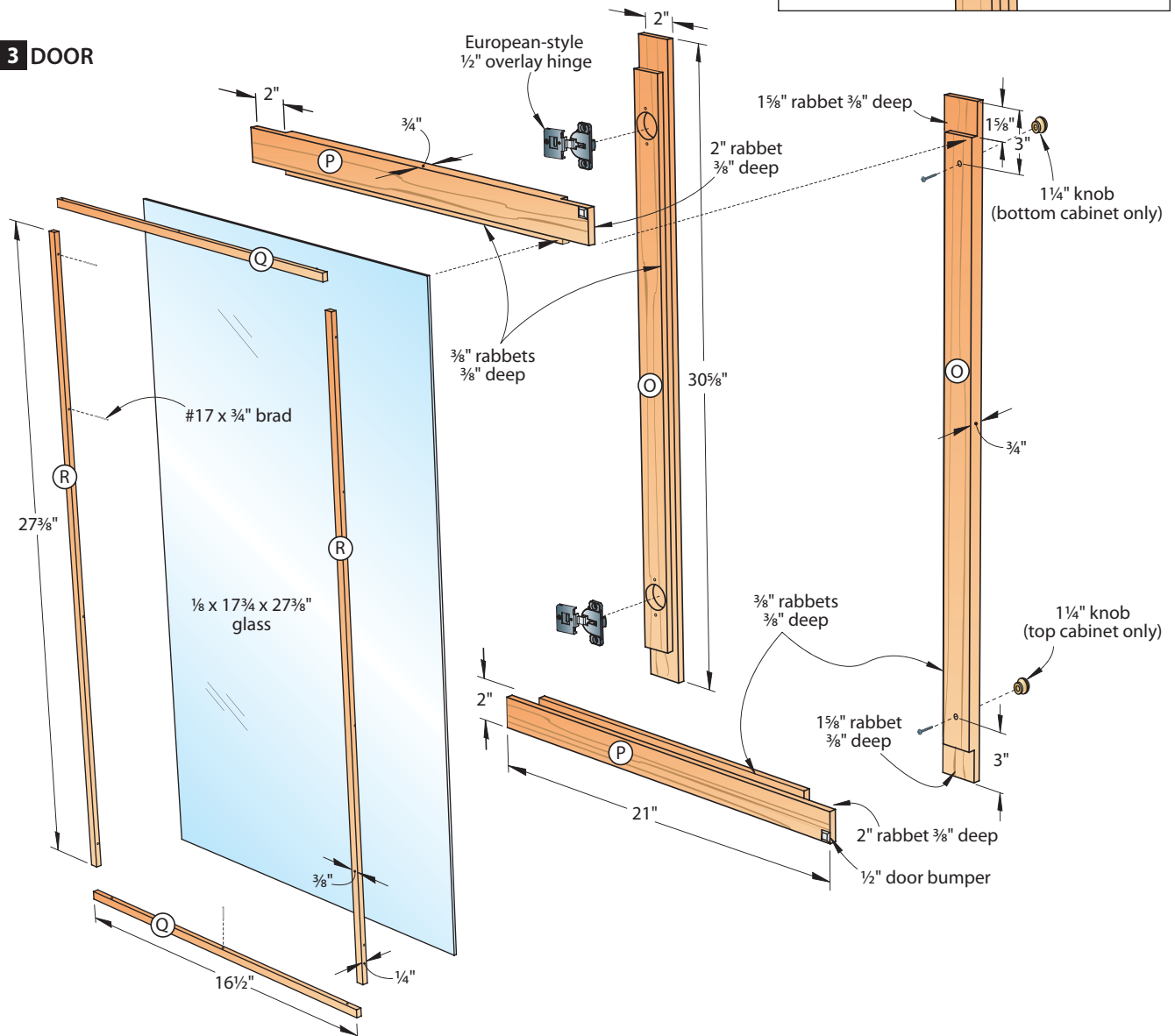

**4** Glue and clamp the cove trim (N) flush with the tops of the face-frame rails (F) [Photo K].

## Build the doors

**1** Cut the door stiles (O) and rails (P) to size [Drawing 3]. Mount a dado blade in your tablesaw, raise it  $\frac{3}{8}$ " above the table, and cut the half-lap joints.

**Note:** The rabbets are different lengths on the stiles and rails. Cut the  $\frac{3}{8}$ " rabbets to hold the glass and stops on the back inside edges of these pieces [Drawing 3a].

**2** Glue and clamp the door stiles (O) and rails (P) together to make each door [Drawing 3].

**3** Finish-sand the doors and drill the counterbores for the cup hinges [Drawing 3a].

**4** Cut  $\frac{3}{8}$ "-wide glass stops (Q, R) from  $\frac{1}{4}$ " stock. Trim each piece of stop to length to fit in the door [Drawing 3]. Drill small holes for brads in each stop, then set them aside.

## Finish it up and reflect on the job

**1** Finish-sand all the parts and apply a finish. **Note:** Mask off the area on the inside of the cases where the top cleats (D) will be glued [Drawing 1]. (We used Minwax Cherrywood no. 607 stain with three coats of satin polyurethane as a topcoat.)

**2** Measure inside the cases for the exact size of  $\frac{1}{8}$ " mirrors and  $\frac{1}{8}$ " glass shelves and then have a glass shop cut these to size. Apply an even coat of mirror adhesive to the back of the triangular bottom mirrors and place them on the case bottoms (C). Next, apply adhesive to the mirror backs and position them in the cases against the backs (A, B). (See Shop Tip opposite.)

### GLUE ON THE TRIM

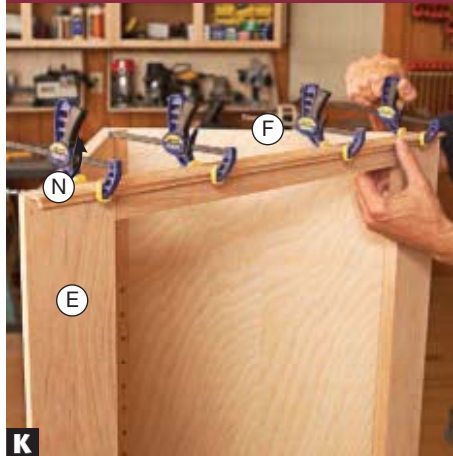

**K** Apply glue on the back of the cove trim (N), and glue and clamp it centered along the front top edge of each case.

## 4 FINAL ASSEMBLY

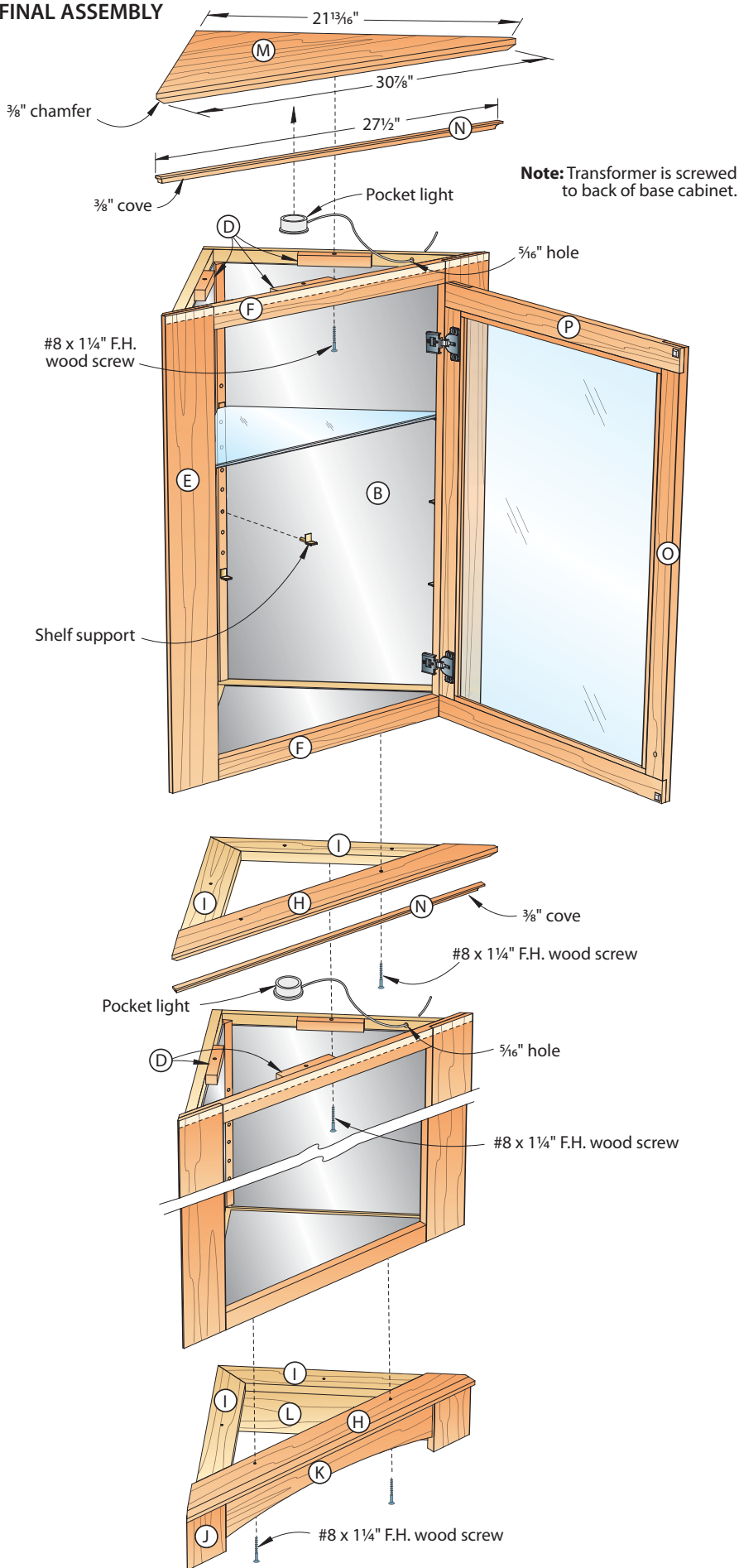

**3** After the adhesive cures, retrieve the top cleats (D) and glue them in place [Drawing 1]. Center the upper case over the lower case and secure using #8×1¼" flathead wood screws [Drawing 4]. Attach the top (M) in the same manner.

**4** Drill holes for the pocket-light wires [Drawing 4] and screw the lights to the top (M) and bottom (C) of the top cabinet. Install the glass in the doors and secure the stops (Q, R) with small brads [Photo L]. Attach the hinges to the doors, and mount the doors to the face frames, centering them top-to-bottom in the opening.

**5** Mount the knobs and bumpers on the doors [Drawing 3] and add the shelf supports. Shine up the mirrors and glass shelves, then install the shelves. 🌳

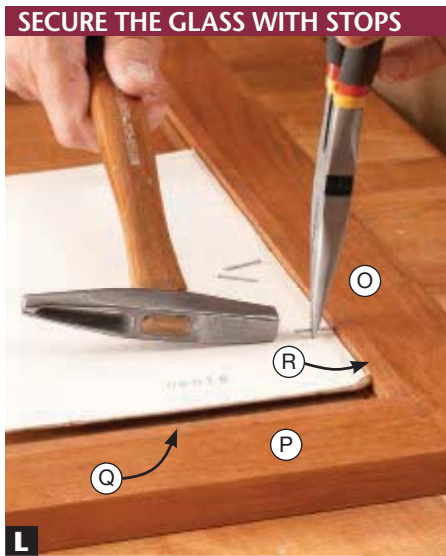

**L** The glass stops (Q, R) are held in place with #17×¾" brads. Lay down some cardboard to protect the glass while driving the brads.

### SECURE THE GLASS WITH STOPS

## Materials List

Part	FINISHED SIZE			Matl.	Qty.	
	T	W	L			
<b>Cases</b>						
A	backs	¾"	17½"	32½"	BCP	2
B	wide backs	¾"	18¼"	32½"	BCP	2
C*	bottoms	¾"	16¾"	16¾"	BCP	2
D	top cleats	¾"	¾"	4"	C	6
E	face-frame stiles	¾"	4"	32½"	C	4
F	face-frame rails	¾"	1½"	28½"	C	4
G*	shelf supports	¾"	¾"	31½"	C	2
<b>Base</b>						
H	front trim	¾"	3"	30½"	C	2
I	back rails	¾"	2½"	17"	P	4
J*	feet	¾"	4"	5"	C	2
K	front rail	½"	3½"	21"	C	1
L	back cleats	¾"	5"	18½"	P	2
M*	top	¾"	13¾"	30½"	EC	1
N*	cove trim	½"	½"	27½"	C	2
<b>Doors</b>						
O	door stiles	¾"	2"	30½"	C	4
P	door rails	¾"	2"	21"	C	4
Q	horizontal glass stops	¼"	¾"	16½"	C	4
R	vertical glass stops	¼"	¾"	27½"	C	4

\*Parts initially cut oversize. See the instructions.

**Materials key:** BCP-birch or cherry plywood, C-cherry, P-poplar, EC-edge-glued cherry.

**Supplies:** #8×1½", #8×1¼", #8×1" flathead wood screws; #17×¾" brads; bumpers (4); #20 biscuits; ½×15¾×31" mirrors (4); ½×16×16" mirror (cut diagonally); ½×16×16" glass (2, cut diagonally to yield 4 shelves); ½×17¾×27¾" glass (2); shelf supports (12); European-style ½" overlay hinges (4); 1¼" knobs (2); mirror adhesive.

**Blade and bits:** Stack dado blade; ¾" cove, 45° chamfer router bits; 1¾" Forstner bit; ¼", ⅝" drill bits.

### Source

**Lights:** Low-profile xenon Pocket lights no. 30394, \$74.99, Rockler Woodworking and Hardware, 800-279-4441, rockler.com.

Produced by **Doug Hicks** with **Kevin Boyle**

Project design: **Jeff Mertz**

Illustrations: **Roxanne LeMoine; Lorna Johnson**

## Cutting Diagram

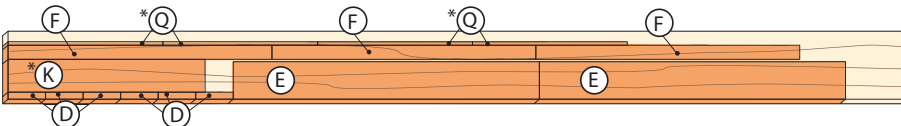

¾ x 7¼ x 96" Cherry (5.3 bd. ft.)

\*Plane or resaw to the thicknesses listed in the Materials List.

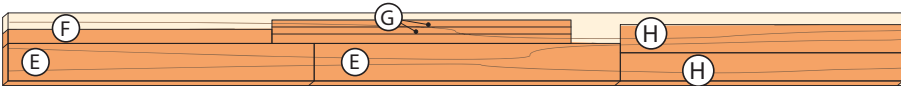

¾ x 7¼ x 96" Cherry (5.3 bd. ft.)



¾ x 5½ x 60" Poplar (2.5 bd. ft.)

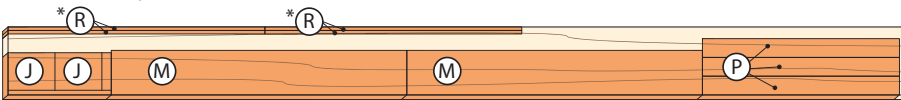

¾ x 7¼ x 96" Cherry (5.3 bd. ft.)



¾ x 7¼ x 96" Cherry (5.3 bd. ft.)

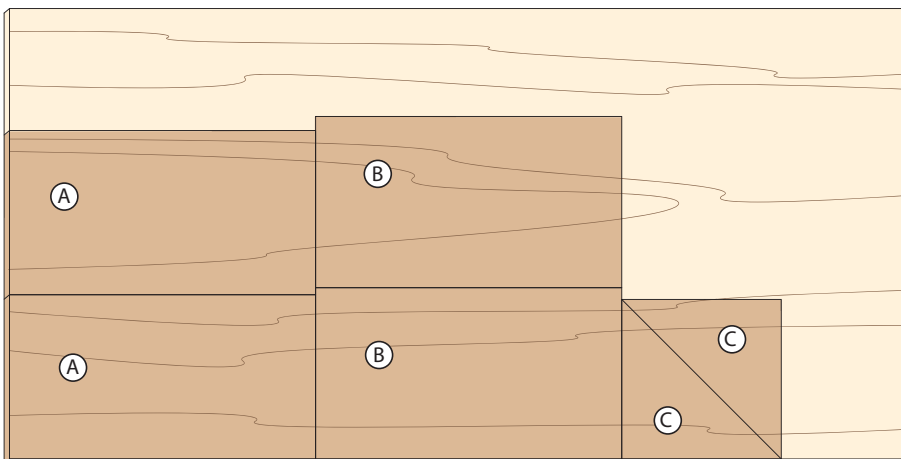

¾ x 48 x 96" Birch plywood if adding mirrors; cherry plywood if not.

## MORE RESOURCES

### FREE PLANS AND ARTICLE

- Learn how to make a squaring brace at [www.woodmagazine.com/brace](http://www.woodmagazine.com/brace).
- For more information on making and using a fairing stick, visit [www.woodmagazine.com/fairing](http://www.woodmagazine.com/fairing).
- "Half-Lap Joints Made Easy" [www.woodmagazine.com/halflap](http://www.woodmagazine.com/halflap).



# WOOD PATTERNS®

March 2011

Issue 203

Dear Reader: As a service to you, we've included full-size patterns on this insert for irregular-shaped and intricate project parts. You can machine all other project parts using the Materials List and the drawings accompanying the project you're building.

© Copyright Meredith Corporation, 2011. All rights reserved. Printed in the U.S.A. Meredith Corp., the publisher of WOOD Patterns®, allows the purchaser of this pattern insert to photocopy these patterns solely for personal use. Any other reproduction of these patterns is strictly prohibited.

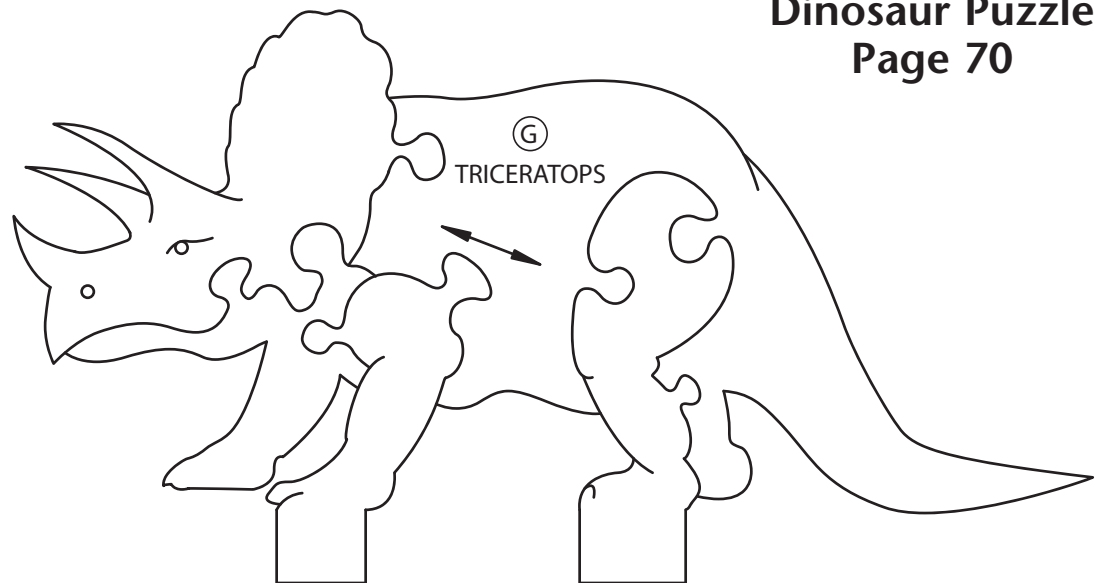
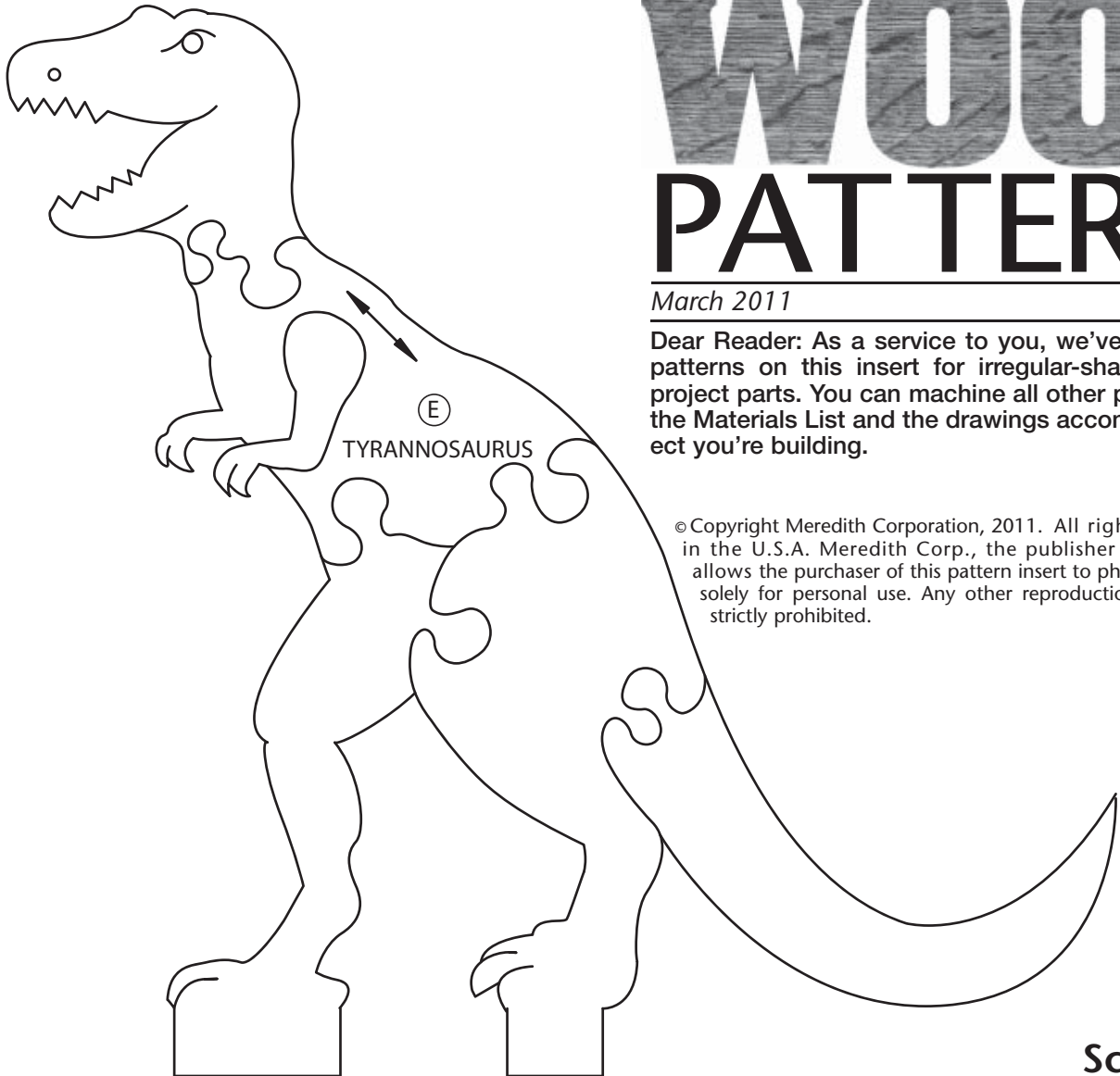

**Scrollsaw  
Dinosaur Puzzle  
Page 70**

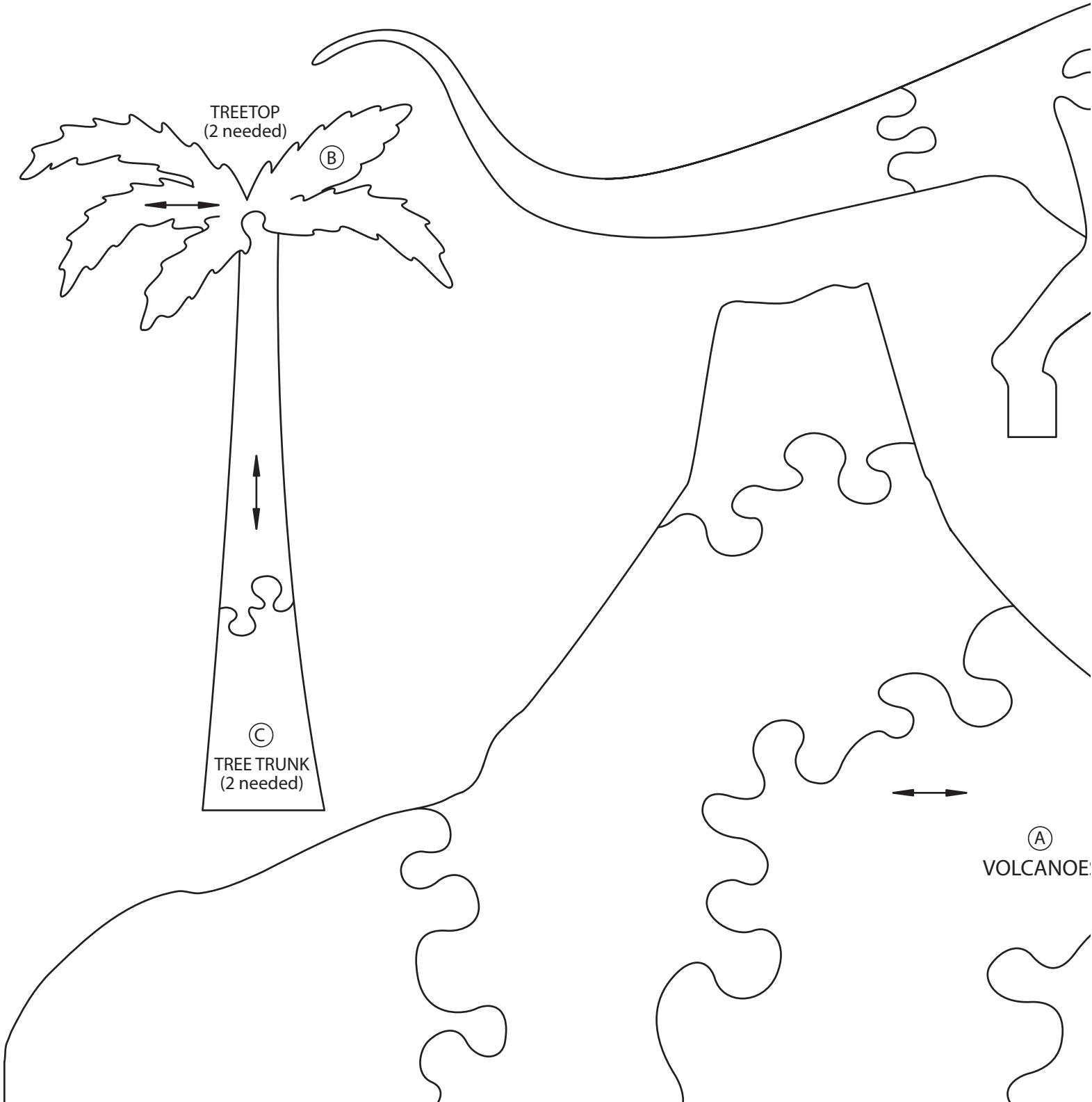

TREETOP  
(2 needed)

(B)

(C)

TREE TRUNK  
(2 needed)

(A)  
VOLCANOE



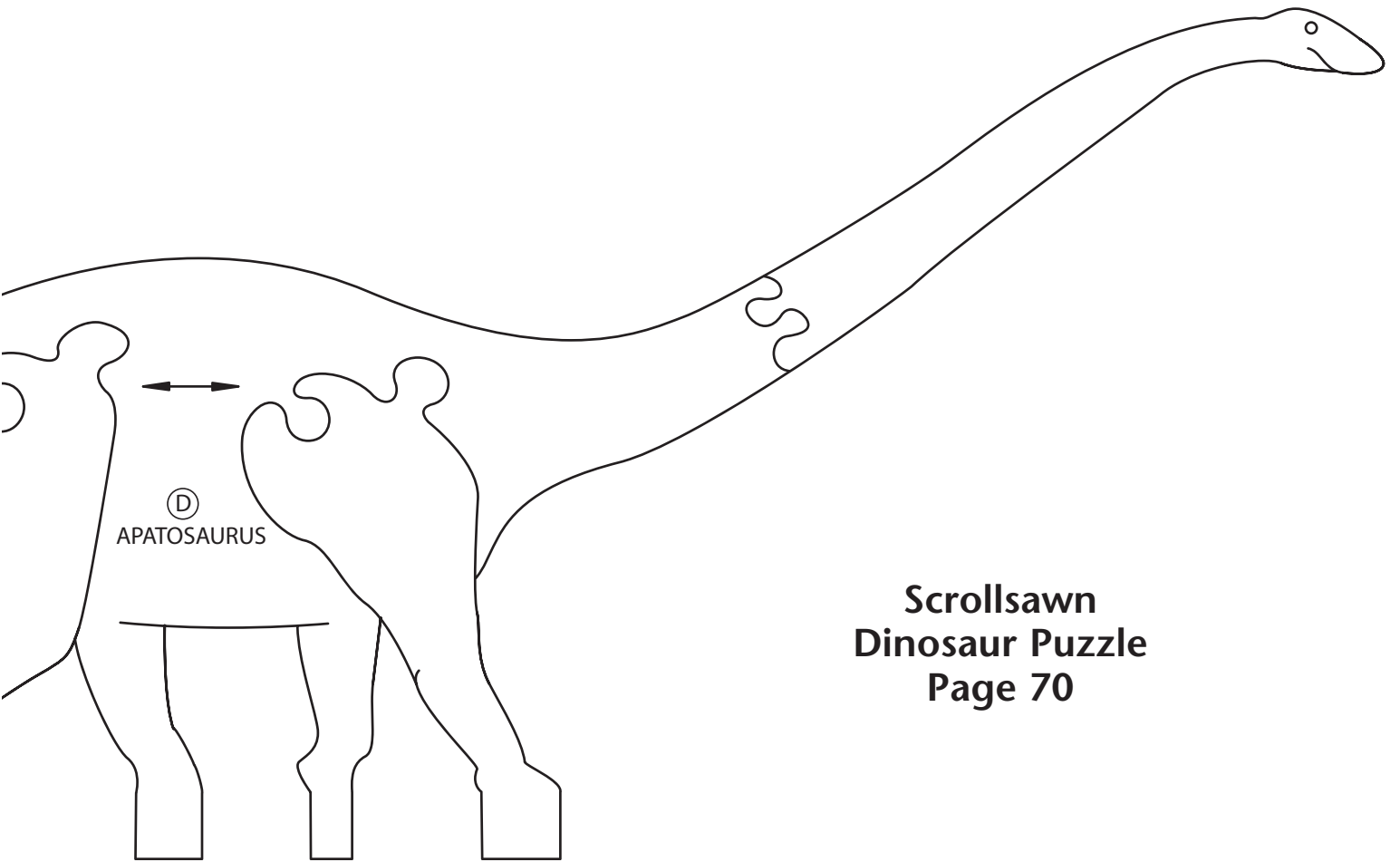

**Scrollsawn  
Dinosaur Puzzle  
Page 70**

**Note:**  
Grain direction

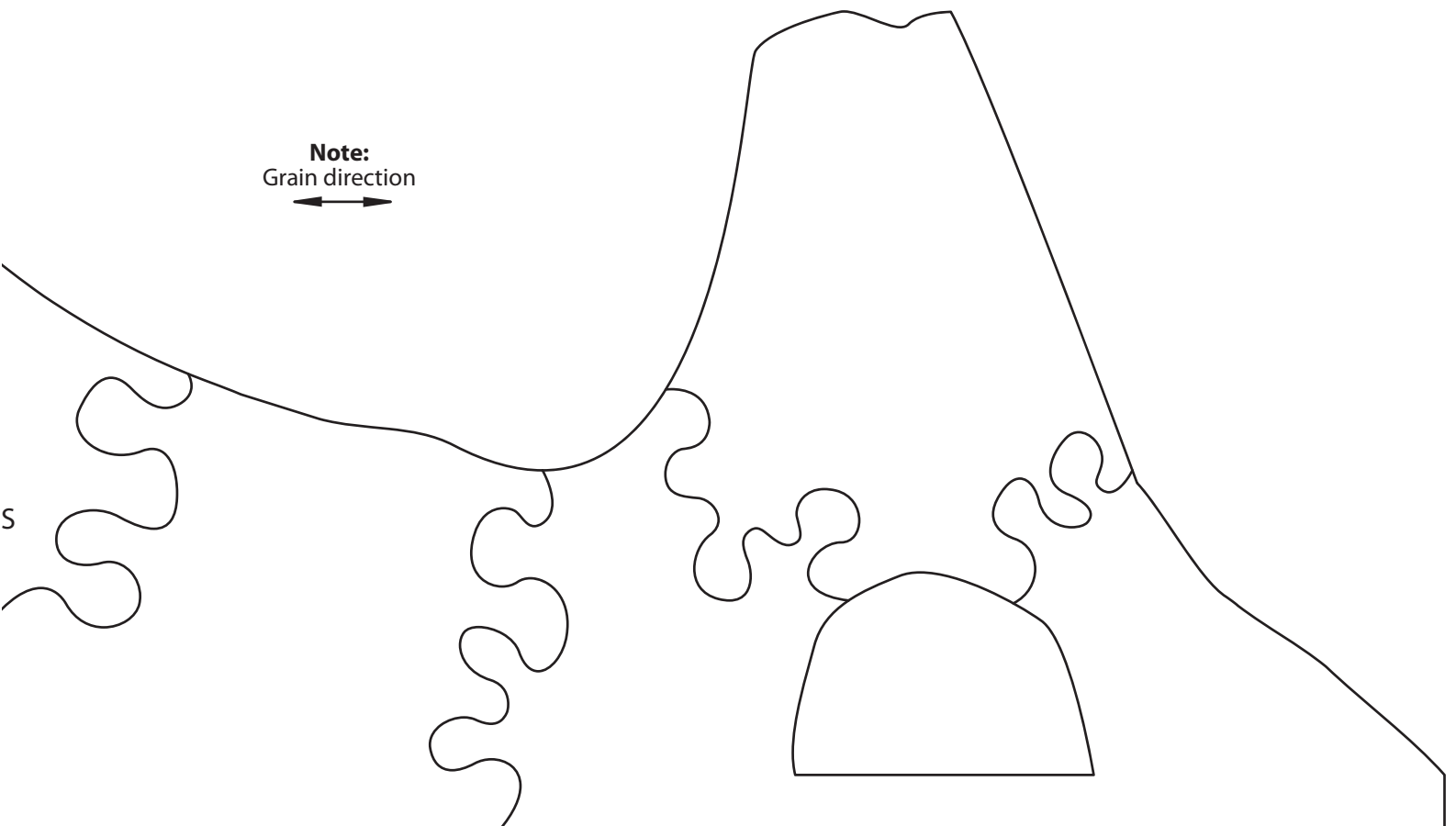

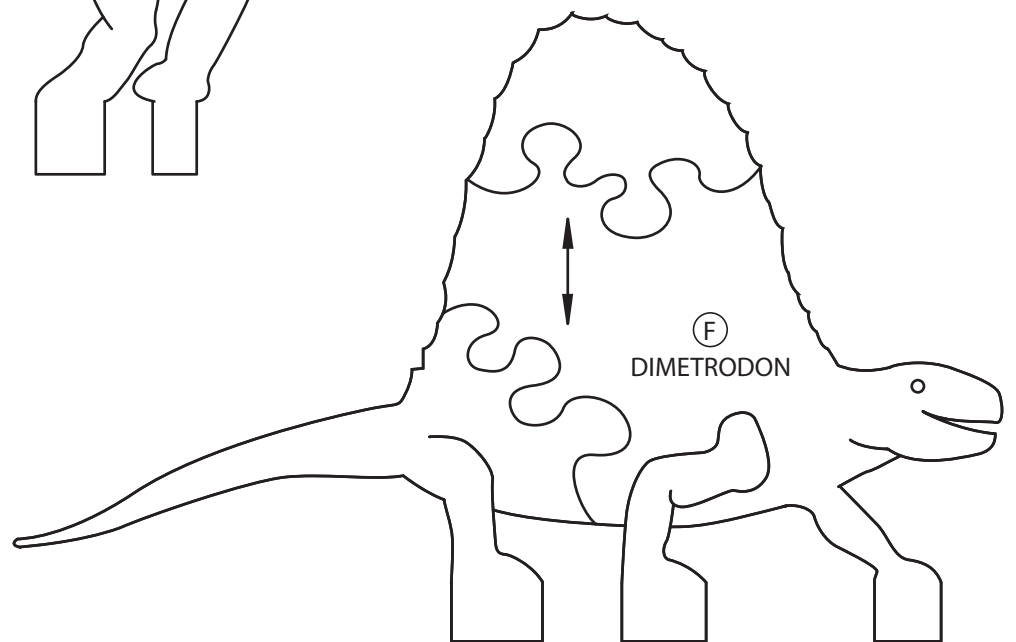
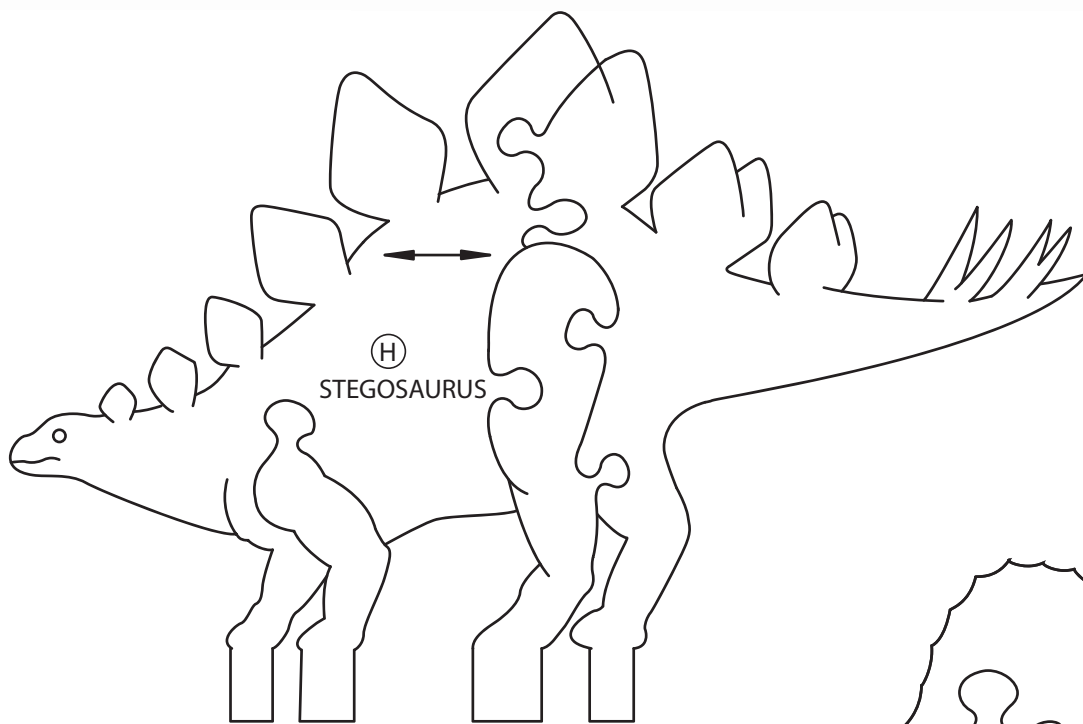



# Turn a Green Bowl

With just a few basic tools and these easy-to-follow steps, you'll be turning out dazzling bowls in no time.

**T**urning a bowl from fresh-cut wood—"green," in the woodworking world—is like gambling with house money. If you mess up a piece, it's no big loss. Just grab another block from the firewood pile. And we've never yet come across a species that doesn't yield great-looking bowls.

Chuck Dowler, leader of the woodturning special-interest group of the Des Moines, Iowa, Woodworkers Associa-

tion, loves to turn green wood. He agreed to show how he does it. As luck would have it, Chuck came across a few cherry logs just days before we called.

With any green wood, cracking caused by too-quick drying will be your biggest concern. So keep green-wood sealer on hand and coat the ends of any blocks or logs immediately when you get them. Because of the high moisture content of this wood, you turn a green

blank about three-fourths of the way, then set it aside to dry for six months or more, depending on the thickness of your bowl. After it dries, you can turn it to final shape and apply finish.

To turn green wood you'll need a small chainsaw, a lathe of any size, a bench grinder (preferably with a sharpening jig), a four-jaw chuck with a center screw, a live center, ½" bowl gouge, a parting tool, and thickness calipers.

## First, prepare the bowl blank

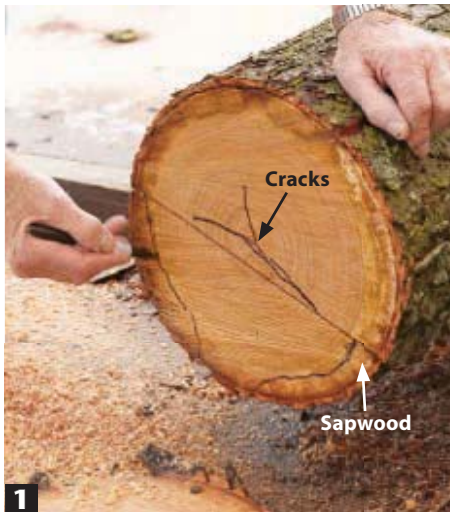

**1** After cutting a couple of inches off the end, mark the location for your bowl. Position it to avoid any cracks emanating from the pith (the log's center).



**2** Chainsaw a thin slab off the outer edge; then saw the blank away from the block. These parallel, flat surfaces make it easier to prep the blank for the lathe.



**3** Make scrap templates of different diameters for quick and easy layout of your bowl on the blank. Be sure to mark the center hole for the chuck or faceplate mounting.

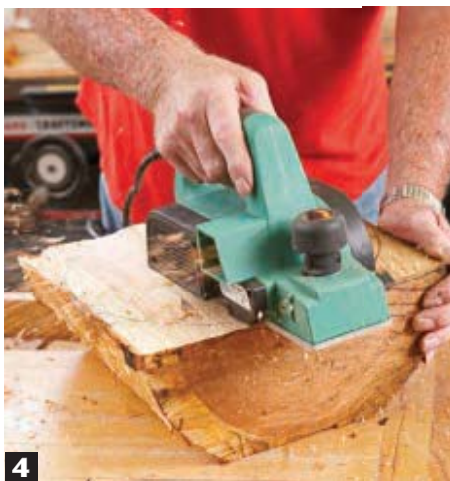

**4** Use a handheld planer (or a hand plane) to flatten the center area. Chucks and faceplates need a flat surface for optimum grip when mounted.



**5** Drill a pilot hole for the screw-chuck threads in the center of the blank. Or, if you use a faceplate, drill pilot holes where needed for the mounting screws.



**6** Bandsaw the blank round. Don't suck the moist debris into your dust collector—it could plug the filter. After sawing, clean your bandsaw to prevent tabletop rust.

## Next, turn the blank to rough shape



**1** Thread the bowl blank onto your screw-chuck with the drive spindle locked. Snug the blank up so it sits flat against the jaws around the entire chuck.



**2** With the tailstock and live center helping to support the blank and the lathe running at its slowest speed, use a  $\frac{1}{2}$ " bowl gouge to begin shaping the outer surface.

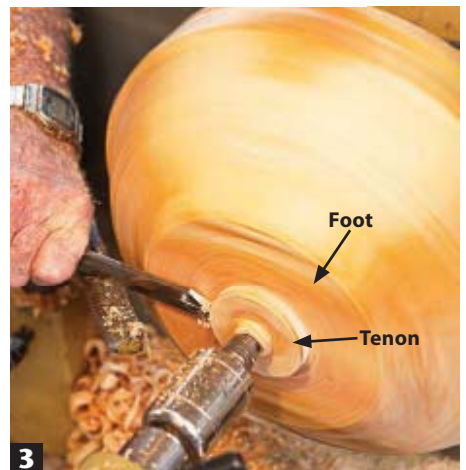

**3** Turn a tenon as big as will fit in your chuck, about  $\frac{1}{4}$ " to  $\frac{5}{16}$ " long. Then form a foot about 40 percent of the bowl's diameter. Square the tenon shoulders to the foot with a parting tool.

## Turn the blank to rough shape (continued)



**4** Define the top rim of your bowl (as marked) to eliminate the small-diameter growth rings around the pith. Keeping them will only cause your bowl to warp and crack.



**5** Step up the lathe speed to the second-slowest setting. Using your parting tool, cut a perpendicular groove into the bowl about  $\frac{3}{4}$ " deep along the line you just marked.



**6** Peel away green-wood ribbons with the bowl gouge as you turn the bowl to its outer shape. You only need a basic shape, so don't fuss over getting it perfectly smooth.

## Shape the inside of the green bowl

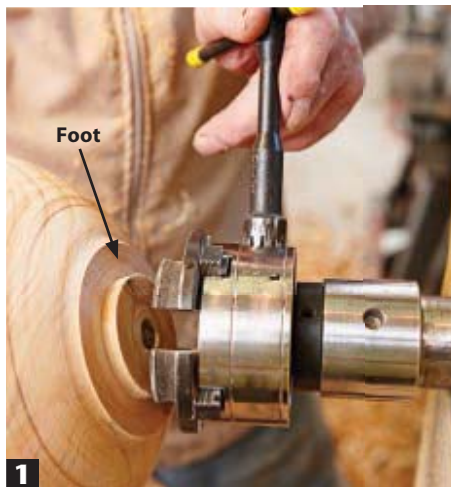

**1** Mount the bowl's tenon in your four-jaw chuck. Be sure the bowl's foot rests flat against the jaws when tightened. If it's not, go back and make it flat.



**2** With the tailstock live center supporting the bowl, remove the waste down to the bowl's rim. Use a pull cut toward you for this, holding the gouge's bevel against the wood.



**3** Remove the tailstock, position your tool rest as shown, and begin hollowing the bowl. Start your gouge near the rim and make incremental push cuts toward the center.



**4** Continue to make successive cuts toward the bowl's bottom. Rest the gouge's beveled edge against the bowl wall as you push the cut to maintain the shape with each pass.



**5** Stop turning when the bowl's wall measures about 10 percent of its diameter. For this 10" bowl, he stopped when the wall was 1" thick. Calipers like these work great for this task.



**6** You've gone as far as you can; time to set the green bowl aside to dry for six months. Coat it with a wood sealer or latex paint and store it in a dry place to prevent cracking.

## Jump ahead 6 months: Turn the dried bowl blank to final shape



**1** Mount the dried bowl by trapping it between the live center and the four-jaw chuck. Use a folded sanding pad as a buffer to add grip. Center the bowl as best you can.

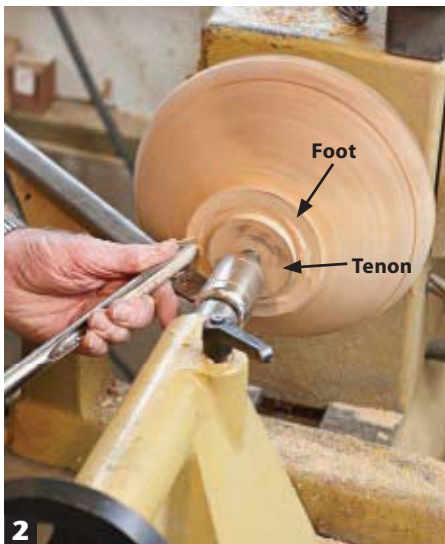

**2** The bowl likely warped as it dried, so you first need to reshape the tenon round and the foot flat. Use the same  $\frac{1}{2}$ " bowl gouge, freshly sharpened.



**3** Turn the outer surface of the bowl to make it round again. Place the gouge's bevel against the wood near the foot and push-cut toward the rim. Use ultralight cuts to finish the shape.



**4** As you did with the green bowl, use the parting tool to define the rim. Continue cutting until you have a rim that's true around the entire bowl.



**5** With the bowl's outer shape to your satisfaction, sand it smooth, beginning with 120-grit sandpaper and continuing through 320 or 400. Apply finish to the bowl's outside.



**6** Before tackling the inner shape, measure the bowl's depth from rim to foot. This lets you know how much material to remove without cutting through the bottom.



**7** Holding the gouge as shown, push into the spinning bowl, removing about  $\frac{1}{8}$ " per pass. Hold the gouge's beveled edge against the bowl wall and chase the shape to the center.



**8** Measure the wall thickness until reaching your desired amount. Leaving the "stump" in the center serves as a gauge of how much material you've removed since starting.



**9** After rounding over the rim, turning away the stump, and cutting to final shape, sand the inner wall smooth. A right-angle sander like this helps hide sanding scratches.

## The home stretch: Trim off the tenon and apply the finish



**1** Here's a low-cost way to hold the nearly complete bowl: a 3/4"-thick MDF jam chuck on a faceplate. Use the parting tool to turn a groove equal to the bowl's rim diameter.



**2** Your bowl should snap into the groove with just a slight push of your hand. Too tight and it could split the bowl. Too loose and it won't hold the bowl securely.



**3** With the live center holding the bowl against the jam chuck for added support, slice away most of the tenon with light pull cuts. Do this with a freshly sharpened bowl gouge.



**4** Remove the live center and tailstock. Secure the bowl to the jam chuck with filament packing tape; about 8 to 10 loops should be enough to hold it safely.



**5** Making light shaving cuts to avoid loosening the bowl, pare away the tenon stub with your bowl gouge. Finally, cut a slightly concave shape on the foot so it will sit flat.



**6** Coat the bowl with your choice of finish. Chuck prefers tung oil to bring out the natural colors of the wood. Wipe away any excess, and apply 3 to 5 coats before buffing.

### MORE RESOURCES

- Watch FREE videos that show how to use and sharpen bowl gouges and other turning tools at [woodmagazine.com/turning-vids](http://woodmagazine.com/turning-vids).
- Download a FREE article about how to get the best yield for turning blanks from green logs at [woodmagazine.com/chainsawblanks](http://woodmagazine.com/chainsawblanks).
- To post questions about woodturning or read other questions and comments, go to [woodmagazine.com/forums](http://woodmagazine.com/forums). Click on the woodturning link.
- For a small fee, download turning project plans from a wide selection at [woodmagazine.com/turnedprojects](http://woodmagazine.com/turnedprojects). 🌲



Produced by **Bob Hunter** with **Chuck Dowler**

### MEET CHUCK DOWLER

Although Chuck's passion is woodturning, he does own a tablesaw. It holds his coffee-maker! In addition to turning bowls, Chuck loves to turn hollow vessels, thin-stemmed goblets, eggs, and egg cups. He also teaches turning classes for the Des Moines Woodworkers in his home shop.



### Sources

**Right-angle sander:** Item #TZ20000, \$59.95, Klingspor's Woodworking Shop, 800-228-0000, [woodworkingshop.com](http://woodworkingshop.com).  
**3" hook-and-loop sanding flex-pad:** Item #FP75200, \$12.95, Klingspor's.  
**3" hook-and-loop sanding discs:** 10-packs from 60 to 400 grit, \$5.75 each, Klingspor's.  
**Wood sealer:** Anchorseal 2, 1 gallon, #150809, \$21.99, Woodcraft Supply, 800-225-1153, [woodcraft.com](http://woodcraft.com).

# How to Build Cabinets the Quick-and-Easy Way

America's leading woodworking instructor, Marc Adams, shows you how to design and make your own custom cabinets.

In this article, you'll learn essential cabinetmaking skills as we build this dry sink.





There are as many approaches to building cabinets as there are cabinetmakers. We asked one of the best, Marc Adams, *right*, to show how he balances the demands of fast-but-simple construction, durability, function, and appearance to create the dry sink shown *opposite*. This dry sink is essentially a typical face-frame base cabinet, just like

the ones in most kitchens, but with a base and top to give it a furniture appearance. You can easily modify this basic design and technique to fit your needs or to create a roomful of cabinets.

Though cabinets may appear intimidating to build, they require only basic skills that you can hone into furniture-making proficiency.



**Marc Adams** understands the value of building your own cabinets. He was a full-time cabinetmaker before opening The Marc Adams School of Woodworking in Franklin, Indiana, in 1994. In addition to teaching at his school, Marc has authored numerous woodworking books and magazine articles, and produced a series of instructional videos. (See **More Resources**, page 63.)

## Why build when store-bought cabinets are so cheap?

Any home center offers a selection of ready-made cabinets at reasonable prices. But building your own allows you to select the hardware, wood species, finish, and other details. Store-bought cabinets are typically made of particleboard held together with staples and hotmelt glue. Building

them yourself, you can use better materials and stronger joinery, and still be dollars ahead. And custom cabinets can be sized to use floor space efficiently. Ready-made cabinets come in 3" length increments and require filler strips to bridge gaps between the end of a row of cabinets and the wall.

## FIRST, SELECT FROM THREE TYPES OF DOORS AND DRAWERS

As you begin designing a cabinet, consider the look of the drawers and doors, because they make up much of the visible portion of a cabinet. Choose from full-overlay, partial-overlay, or inset [**Drawing 1**].

A **full-overlay** is easiest to make because the door or drawer front rests in front of the face frame. This overlay masks any discrepancies in the fit between the face frame and the drawer or door. Marc chose this style for the dry sink.

A **partial-overlay** requires rabbeting the back faces of the door and drawer. This slightly reduces the door and drawer-face size and their exposed thickness, revealing more of the face frame.

An **inset** offers a sleek, custom look, but requires a precise fit of the drawer face and door into the face-frame openings. Precision in construction and hardware installation is critical to create even gaps around all four edges.

### Make hard(ware) choices

The most important hardware decision is the type of **drawer slides**. For the light-duty use expected of most cabinets, epoxy-coated roller slides from the home center provide good performance at an economical price. (See *page 72* for other drawer-slide choices, and details on mounting them.)

**Adams' Insight:** If the drawer-slide manufacturer offers a mounting jig, buy one; it greatly simplifies installation.

**Knobs and pulls** add character to a cabinet. You'll find hundreds of styles in catalogs and online.

The type of door determines the **hinges**. You'll find dozens of hinge choices for each type of door. The dry sink uses a 35mm European-style cup hinge with a 1/2" overlay [**Photo A**]. The hinges hide behind the closed door and offer easy three-way adjustability.

### HINGES FOR EASY-FIT DOORS

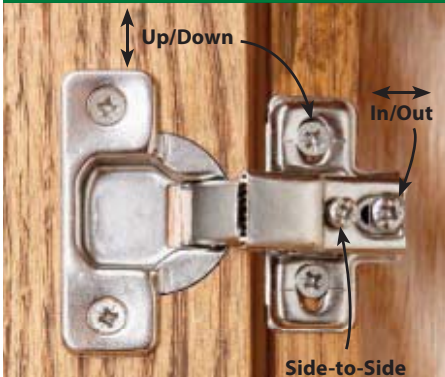

**A** European hinges adjust in three planes: up/down; in/out; and side-to-side for adjusting the door square with the face frame.

### 1 DOOR AND DRAWER OPTIONS

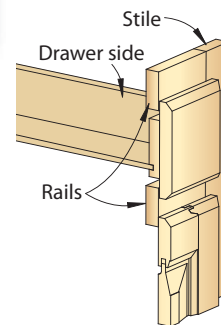

#### FULL-OVERLAY

Full thickness of drawer face and door rests on surface of face frame.

Make drawer faces and doors 1" longer and wider than openings.

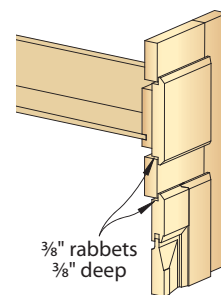

#### PARTIAL-OVERLAY

One-half of drawer-face and door thickness rests on surface of face frame.

Make drawer faces and doors 1/2" longer and wider than openings.

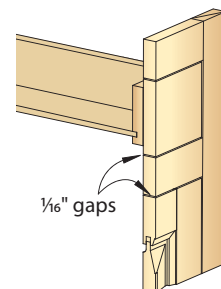

#### INSET

Fronts of drawer face and door rest flush with face frame.

Make drawer faces and doors 1/8" shorter and narrower than openings.

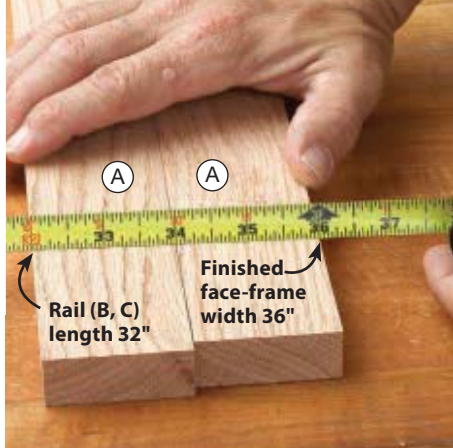

**B** THE TAPE TELLS THE TALE

With the stiles (A) side by side, align the face-frame width (36") with one edge. Read the rail length (32") at the opposite edge.

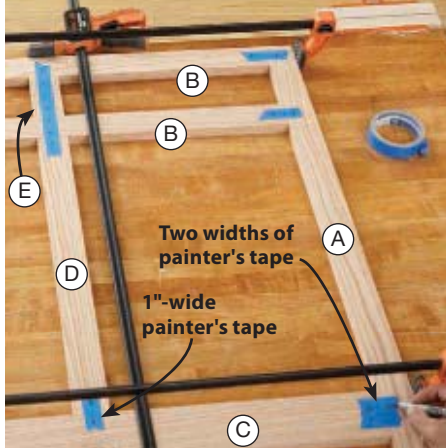

**C** TAPE ACROSS EACH JOINT

Label each half of each joint with matching numbers for easy repositioning of the parts after drilling the dowel holes.

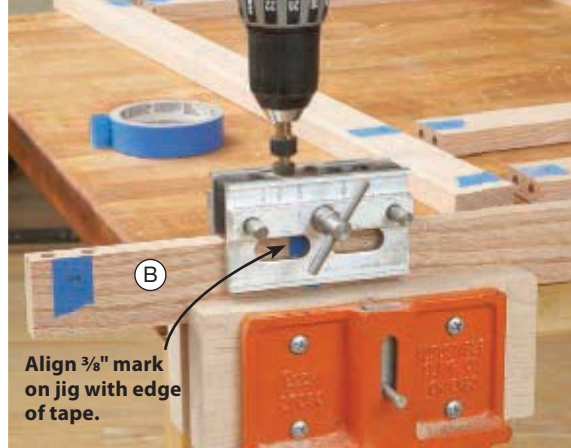

**D** DRILL THE DOWEL HOLES

Align the jig's 3/8"-dowel index mark with one edge of the tape. Drill the hole. Reposition to the other tape edge and drill the second hole.

**START WITH THE FACE FRAME**

Marc's method of cabinet construction utilizes a solid-wood face frame attached to the front of a plywood carcass. The face frame strengthens the carcass and provides mounting points for drawer slides and door hinges. Marc joins his face-frame components with dowels because they're strong, instantly align the parts, and the holes are quick to drill. Dowels also allow for cutting grooves in the assembled face frame without any danger of hitting a screw.

**Adams' Insight:** Cabinet carcasses consume a lot of shop real estate. Save space by building the face frames first. Half a dozen face frames stack against a wall in less space than a single carcass. Take measurements for the doors and drawers from the face frames, build them, and build the space-eating carcasses last.

The standard maximum width for a cabinet is 36". Beyond that, doors tend to warp, and their solid-wood panels expand excessively. For spaces wider than 36", design two narrower cabinets.

On typical 36"-tall cabinets, the face frame stops 3 1/2" from the floor to provide toe room. However, this dry sink has no toekick, so the face frame runs the full height of the carcass. Allowing for the 3/4"-thick top (V) makes the face-frame stiles (A) 35 1/4" long [Drawing 2].

**Adams' Insight:** You can make face-frame parts any width you like, but building them with 2"-wide material greatly simplifies math. And to further reduce the chance for errors, always take measurements directly from previously cut or assembled project parts whenever possible.

Use the stiles (A) to determine the length of the upper and lower rails (B, C) [Photo B].

Next cut the door divider (D) and drawer divider (E) to length.

On your bench, arrange the face-frame pieces and hold them together temporarily with 1"-wide painter's tape [Photo C]. The edges of the tape serve as layout marks for the doweling jig later, so center the tape across each joint. Use two strips side by side across the lower rail (C) and stiles (A).

With a razor knife, cut the tape across each joint, then drill the dowel holes [Photo D, Drawing 2].

Glue and clamp the dividers between the rails [Photo E]. After the glue dries, glue the stiles in place, checking for square and that the frame lies flat.

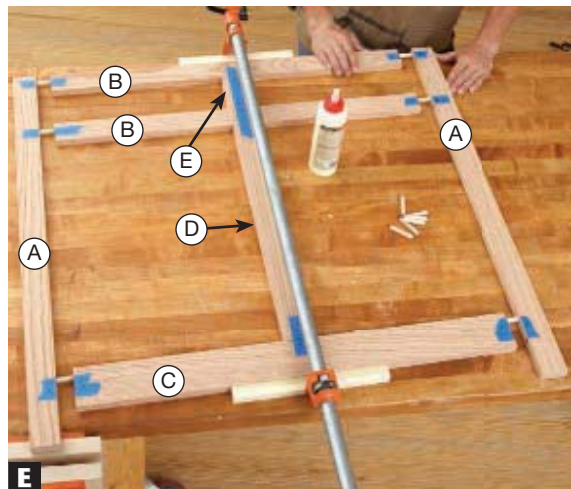

**E** STILES HELP JOIN THE DIVIDERS

Dry-fit a dowel in each stile (A) joint to hold the rail (B, C) ends in position while gluing the dividers (D, E) between the rails.

**2** FACE FRAME

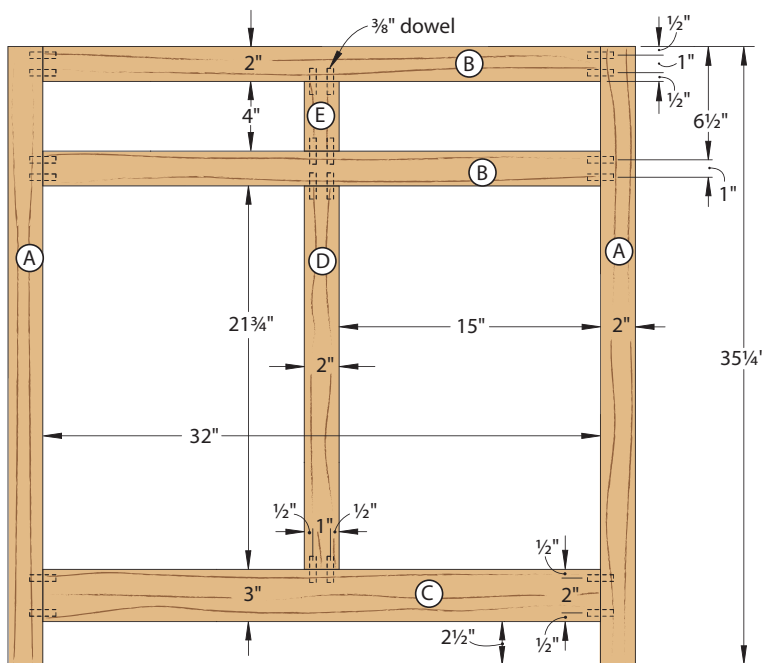

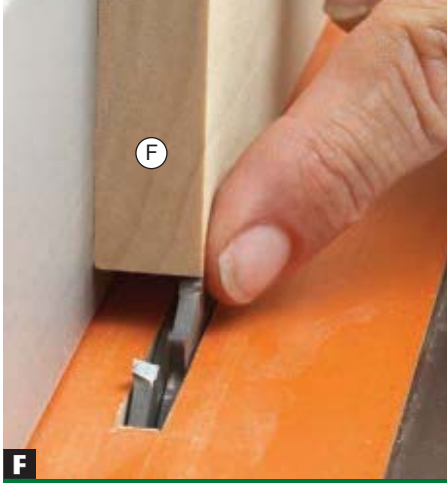

**F**  
**SET UP FOR A LOCK-RABBET JOINT**  
 Place a drawer front (F) against the rip fence. Position the fence so the face of the front is flush with the outside edge of a tooth.

## BUILD THE DRAWERS

Choices abound in drawer joinery, from simple nailed-together butt joints to the classic beauty of dovetails. Marc prefers the strong, quick-to-make **lock rabbet**, a joint that can be cut on the tablesaw with a dado blade.

**Adams' Insight:** Most drawer slides require a drawer box 1" narrower than the drawer opening in the face frame, allowing 1/2" clearance for each slide. With the face frame built, this makes easy work of determining the drawer-box width. Exact drawer height matters less, so keep the math easy by making the width of the drawer sides, front, and back 1" less than the height of the opening.

As for the length of the drawer, 22" slides are the longest that fit in a 24"-deep cabinet. Epoxy-coated roller slides have mounting brackets at the rear [Drawing 8]. Allowing 1" for the bracket makes the drawer length 21".

With dimensions determined, cut the drawer fronts and backs (F), and sides (G) to size [Drawing 3], along with an extra front to use as a test piece when setting up the tablesaw.

Mount a 1/4" dado blade in your table-saw. Use a drawer front (F) to set the rip fence [Photo F], then set the blade 1/4" above the table [Drawing 4].

Cut a dado across each end of the drawer sides (G) [Step 1, Drawing 4]. With the same setup, cut a groove in the drawer sides and drawer fronts and backs (F) to accept the drawer bottoms (H). Raise the blade to 3/8" above the table, attach an auxiliary fence to the rip fence, and adjust the auxiliary fence next to the blade [Step 2, Drawing 4]. Make a cut on the test piece with this setup and check that the tongue fits the

### 3 DRAWER

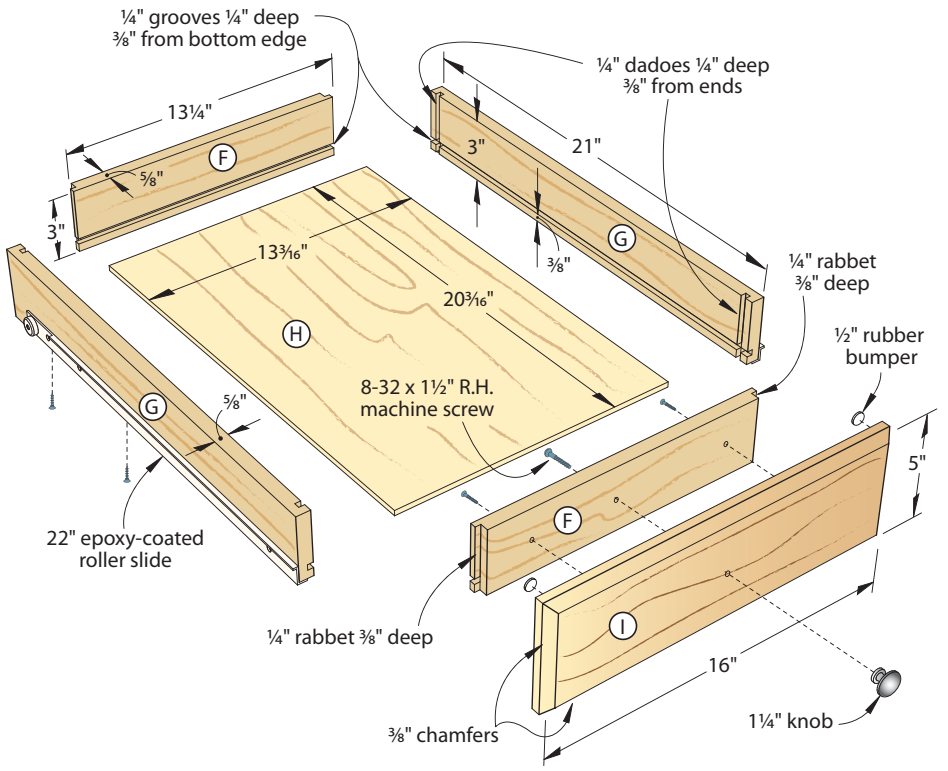

dadoes in the sides; then rabbet the drawer fronts and backs.

Dry-fit the drawers, and cut the drawer bottoms (H) to size to fit between the grooves, less 1/16" in each dimension. Finish-sand the parts to 220 grit, easing the sharp edges of the drawer box, then glue them up. As with the face frame, assemble them on a flat surface to prevent twist, and compare the diagonal measurements to ensure square.

**Adams' Insight:** The length of the drawer faces (I) should match the door width, and the door width depends on the type of door and hinge you choose. This cabinet's doors use hinges with 1/2" of overlay in each direction, making the doors 1" wider than the door openings. So the drawer faces must be 1" longer than the drawer openings. Likewise, the width of the drawer face is 1" greater than the opening's height.

After cutting the drawer faces (I) to size, rout 3/8" chamfers around the front edges [Drawing 3]. Then, finish-sand them to 220 grit, and set the drawers and faces aside.

### 4 HOW TO CUT A LOCK-RABBET JOINT

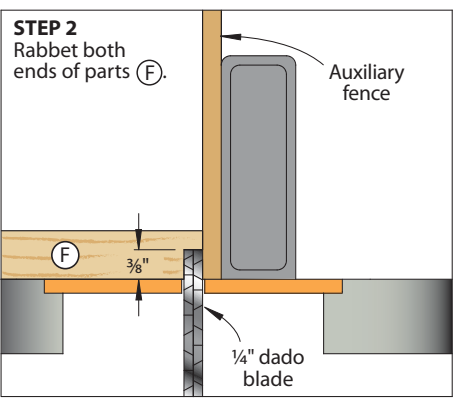
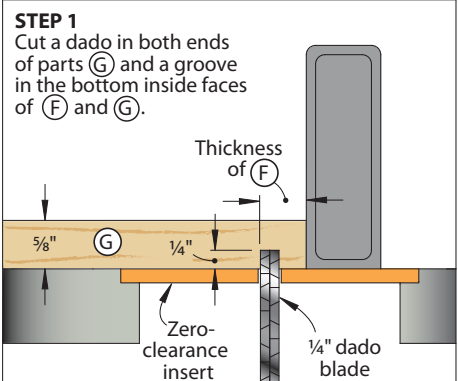

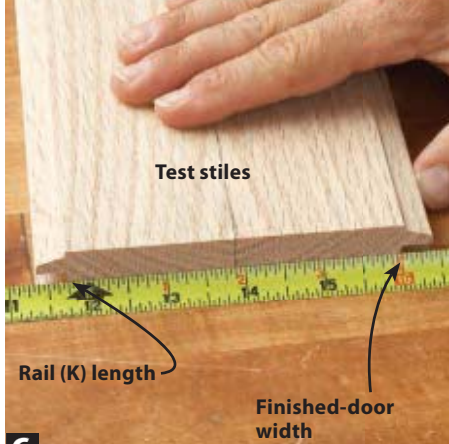

### G HOW TO FIND THE RAIL LENGTH

Align the finished-door width (16") with the bottom of a groove. Read the rail (K) length (11¾") at the bottom of the other groove.

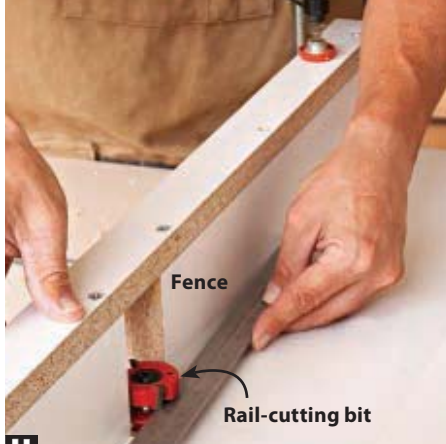

### H MOUNT THE JIG

Clamp one end of the jig to the router table, align the fence with the rail-cutter's bearing, then clamp the opposite end of the jig.



### I SET THE RAIL-CUTTER HEIGHT

Rest a rule on a cutoff from the jig's runner. Set the bit height to create a 3/16"-deep rabbet on the back of the ¾"-thick rails (K).

## 5 COPE-AND-STICK JOINERY

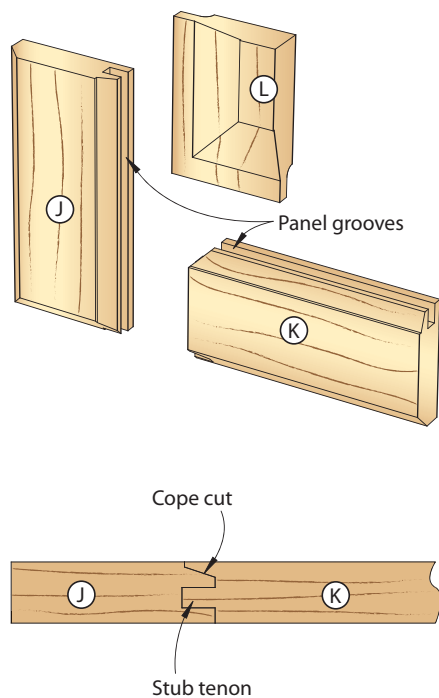

## 6 DOOR

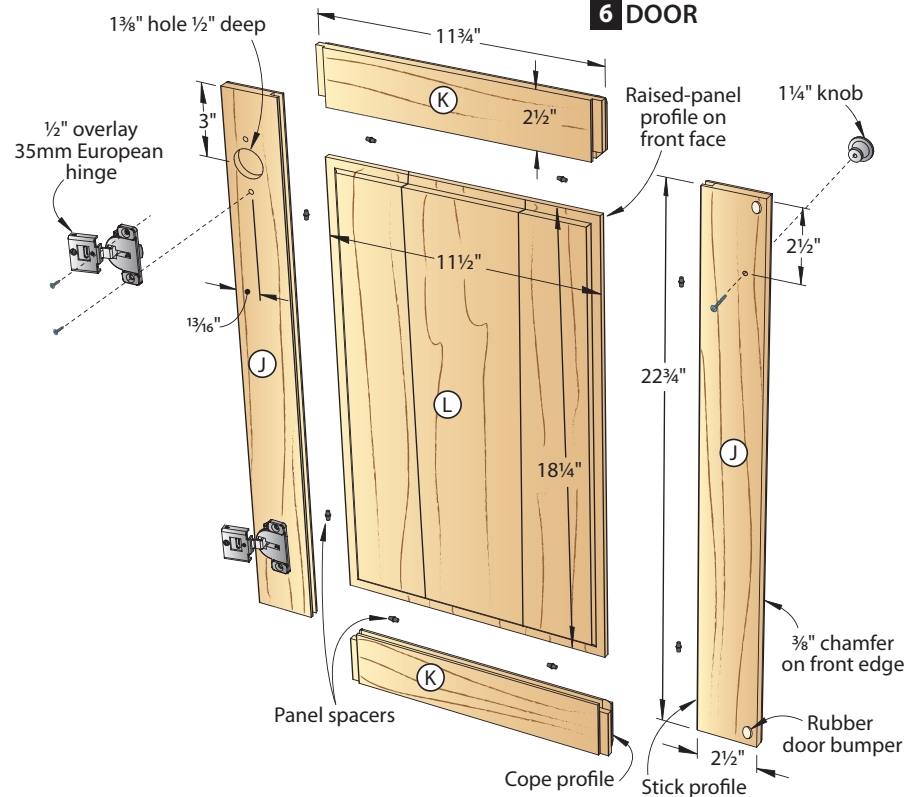

## SWING ON TO MAKING THE DOORS

**Adams' Insight:** I prefer a **cope-and-stick** joint [Drawing 5] for doors because the decorative profile adds visual interest. A special router bit (a rail cutter) forms a stub tenon on the ends of the rails (K) as it copes them to mate perfectly with the profile on the stiles (J). A mating bit (a stick cutter) mills in the rails and stiles a groove to accept the panel as it also creates the decorative profile on the outer face of the groove.

It takes test cuts to set up each bit, but once set, pieces can be routed quickly. I use the jig shown *opposite* for cutting these joints.

**Note:** Routing the raised panels for the doors requires a router with at least 2¼ hp and variable speed.

Plane stock to ¾" thick for the door stiles (J), rails (K), panels (L), and a couple of extra rails to use as test pieces, then rip them to width [Drawing 6]. Glue up oversize door panels, then set them aside.

Determining the length of the door stiles (J) is easy. To account for the ½" overlay at each end, cut the stiles 1" longer than the height of the door opening.

The rails (K) require a bit more math. They need to fit between the stiles, and account for the stub-tenon lengths, the width of the stiles, and the overlay.

**Adams' Insight:** There are a lot of chances for error to creep in when determining rail length. To get an accurate dimension, make a gauge for taking direct measurements. First, set up a stile-cutting router bit in your router table and set the height to roughly center the groove cutter on the thickness of a test piece. Make a pass along one edge of a test piece, then crosscut the piece in half.

Knowing the finished width of the door (1" more than the door-opening width—16" in this case), place the test stiles back to back and take one simple measurement to determine the rail length [Photo G].

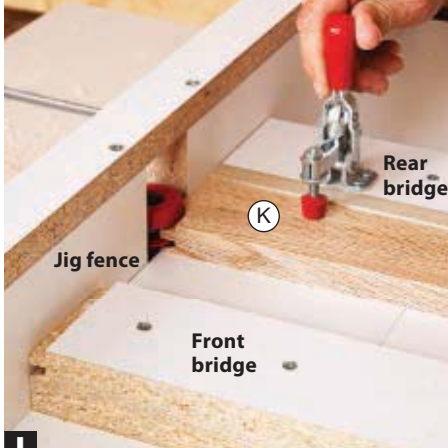

### J COPE THE ENDS OF THE RAILS

Clamp a rail (K) onto the sled, tight to the jig fence and the backer board. Cope each end of each rail, keeping the face side down.



### K ROUT THE PROFILE ON ALL PIECES

With a springboard applying consistent downward pressure, use a push pad to keep the piece against the fence as you rout.

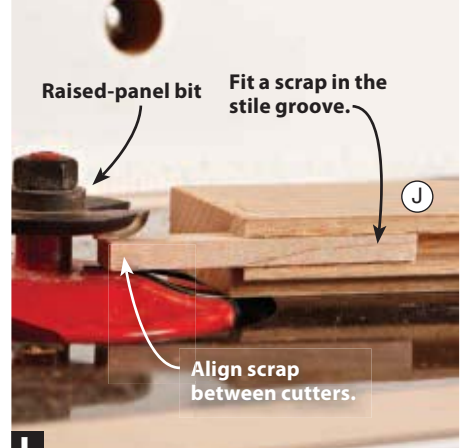

### L SET THE PANEL BIT HEIGHT

To make the panel's (L) face flush with the door face, use a stile (J) to help adjust the raised-panel bit height as shown.

## 7 SPRINGBOARD

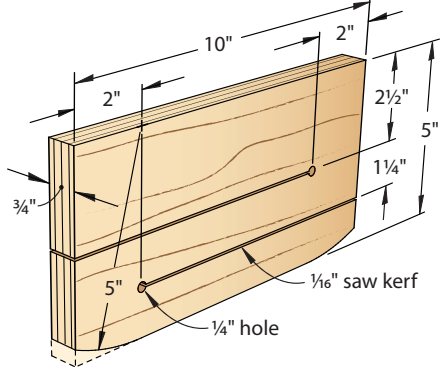

Clamp the cope-and-stick jig to your router table [Photo H], then adjust the height of the rail-cutting bit [Photo I]. With the good face of each rail (K) down on the jig, cope the ends [Photo J].

Install the stick cutter in the router table. Using the coped end of a rail (K) as a gauge, align the cutter on the bit with the tongue of the rail [Photo K]. Clamp a springboard [Drawing 7] or featherboard to the jig fence, then rout the inside edge of each stile (J) and rail.

Retrieve the door panels (L). To allow for expansion and contraction of the solid-wood panels, cut them 1/4" narrower than the length of the rails (K).

To determine the length of the door panels, put the rails edge to edge, align the 22 3/4" (the length of the stiles) mark of your tape at the bottom of one groove, and read the measurement at the other groove. Subtract 1/4" from this measurement to keep an even reveal around the panel. Cut the panels to size.

Remove the jig from the router table, and mount a raised-panel bit in the router [Photo L].

## COPE-AND-STICK JIG IMPROVES CUT QUALITY

To cut the cope-and-stick joints, build the jig illustrated below. First, cut the 1"-radius bit opening in the base, then glue and screw the fence to the base. To ensure that the guides sit parallel to the fence, place the wide runner against the fence, then position the guides with a narrow runner and paper spacers between them, right. Screw the guides in place.

Screw, but don't glue, a replaceable backer board to the front edge of the rear bridge. Position the remaining narrow runner to the outside of the guides, then screw the rear and front bridges to the runners, square to the fence. Screw a toggle clamp [Source] to the rear bridge.

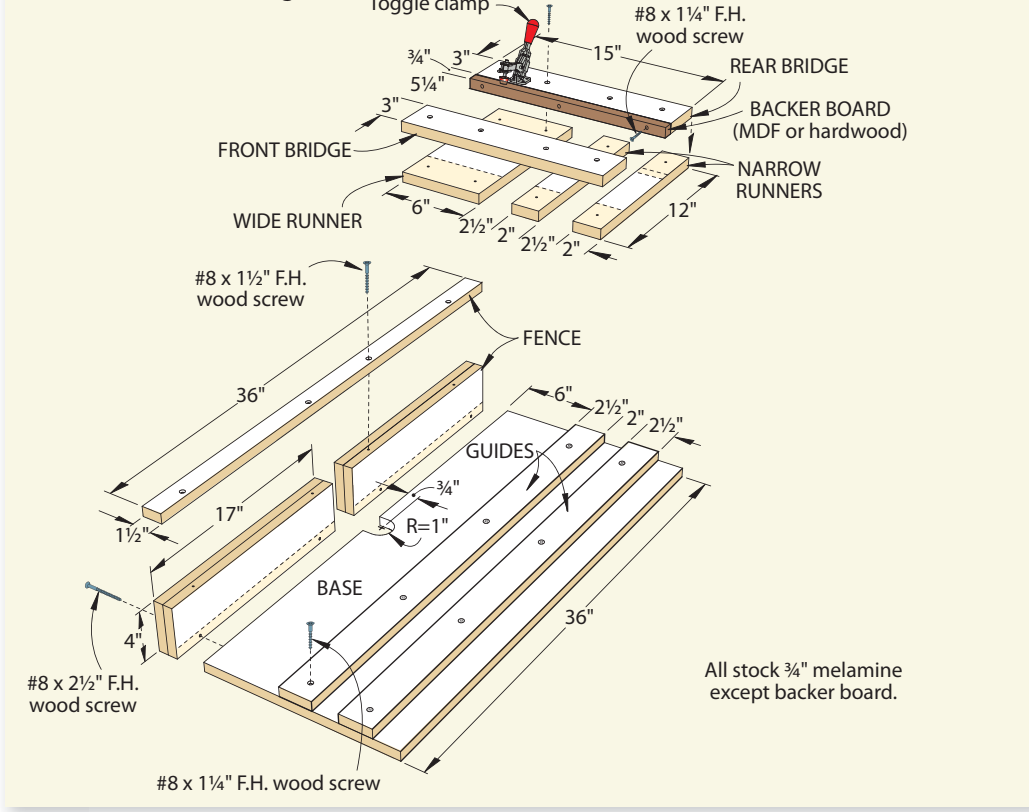
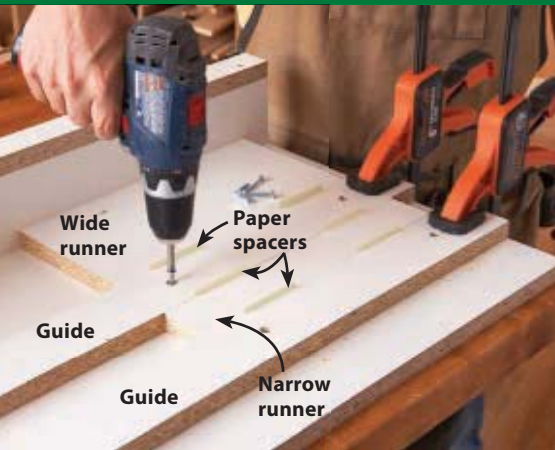

**Adams' Insight:** If the hole in your router-table insert plate is too small for the raised-panel bit, make a new insert from hardboard or plywood.

Position the router-table fence to reveal about one-third of the bit's profile. Set the router to its slowest speed. Rout the raised panel in several passes, moving the fence back between each pass to reveal more of the bit until, on the final pass, the bit's bearing aligns with the router-table fence.

Dry-fit the door with the panel to test the fit, then disassemble it. Finish-sand the profiles on the stiles (J) and rails (K). Finish-sand the panel (L) and apply a stain to it. (We used Varathane gel stain no. 21179 Early American.)

**Adams' Insight:** Staining the panel before assembly prevents unstained edges from showing when the panel contracts due to seasonal wood movement.

Brush glue on the rail (K) tenons, insert two panel spacers [Source] in each groove [Drawing 6], and clamp up the door [Photo M]. Do not apply any glue to the panel. Check that the assembly remains flat and square.

After the glue dries, drill the hinge cup holes [Drawing 6].

**Adams' Insight:** Don't fret if you can't find a 35mm Forstner bit. A 1 3/8" Forstner bit measures 34.925mm and works fine.

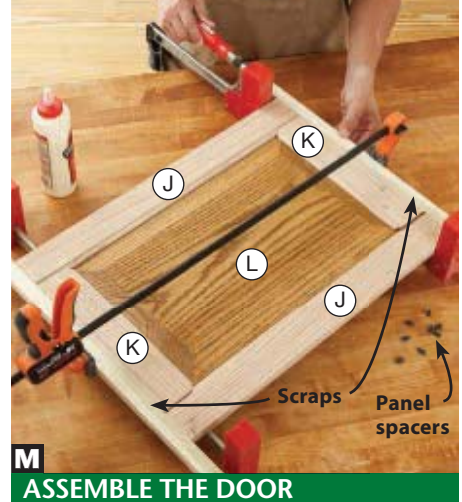

**M ASSEMBLE THE DOOR**

Scraps align the tops of the rails (K) with the ends of the stiles (J). Remove the scraps after tightening clamps against the stiles.

Rout 3/8" chamfers around each door front to match the drawer profile, then finish-sand the rails and stiles to 220 grit.

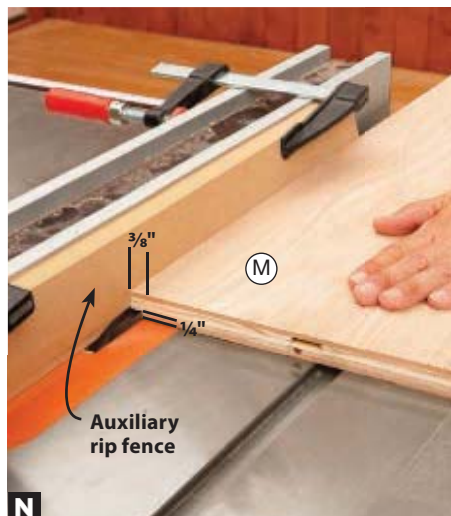

**N RABBET THE SIDES**

Cut a 3/8" rabbet, sneaking up on the blade height to create a tongue that fits the groove in the face-frame stiles (A).

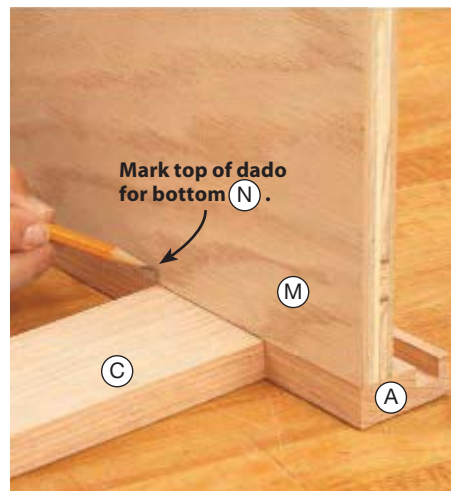

**O MARK THE BOTTOM DADO**

Position a side (M) flush with the bottom of the face-frame stile (A) and mark the position of the top of the lower rail (C).

**CREATE THE CARCASE**

Size the sides (M) [Drawing 8] to create a 24"-deep cabinet with the face frame attached. (Allow for the 3/8"-deep groove cut in the stiles in the next step.)

Mount a 1/2" dado blade in your table-saw. Retrieve the face frame (A-E) and cut a 3/8"-deep groove on the inside face of each stile (A) [Drawing 8].

**Adams' Insight:** Cutting the groove 1/4" from the edge leaves extra stock on the edge of the face frame that you'll need if you have to scribe the frame for a tight fit to a wall. For a row of cabinets, it also provides 1/2" of "fudge" room with each cabinet for fitting them in place.

Attach a 3/4"-thick auxiliary face to the tablesaw rip fence. Raise the blade 3/8" into the outside edge of the auxiliary fence, then reposition the fence, lower the blade, and cut a rabbet in the front edge of the sides (M) [Drawing 8, Photo N]. Slide the fence over to expose 1/4" of the blade, and rabbet the inside back edges of the sides to accept the back (O).

Without changing the blade height, add chippers so the dado set matches the thickness of the bottom (N). (See **More Resources** for a free video to help with this.)

The top face of the bottom (N) aligns with the top edge of the lower rail (C). Transfer this location to the sides (M)

**Plywood balances durability and expense**

**Adams' Insight:** Sheet goods make carcass construction quick and easy. Although particleboard and MDF are widely used in commercial cabinets, plywood better tolerates damp kitchen and bathroom conditions. It comes in a variety of species, even prefinished. A single sheet of 3/4" plywood yields one cabinet using the methods shown here. (See **More Resources** for tips on working with sheet goods.)

For a series of base cabinets mounted side by side, as in a kitchen, save money by choosing plywood with a lower-grade veneer, then covering only the exposed face of the end cabinet with 1/4" plywood to match the face-frame material.

[Photo O] and cut the dado for the bottom in both sides.

**Adams' Insight:** Leaving the blade at the same height when cutting the rabbets that accept the back and the dados that accept the bottom makes the length of the bottom and the width of the back identical.

Measure between the grooves in the face-frame stiles (A) to find the length of the bottom (N) and the width of the back (O). Measure between the rabbets in a side (M) to determine the bottom's width. The back's length equals the distance from the top of a side to the dado's

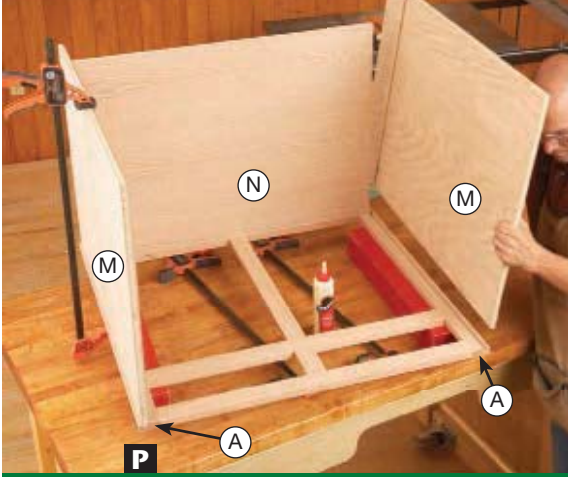

### START WITH A SIDE

Glue a side (M) into a face-frame stile (A), with their tops and bottoms flush. Add the bottom (N), then the remaining side.

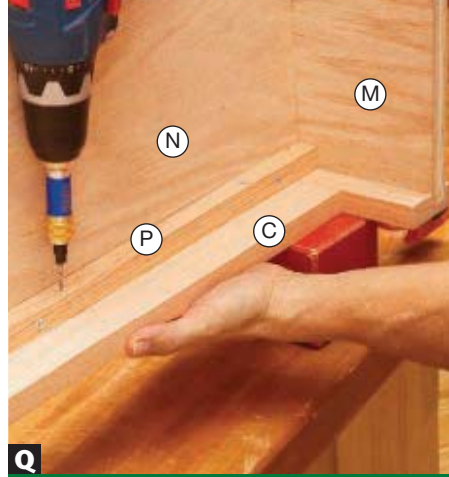

### POSITION THE BOTTOM CLEAT

Position the bottom (N) flush with the top of the lower rail (C). Screw the bottom cleat (P) to the lower rail and bottom.

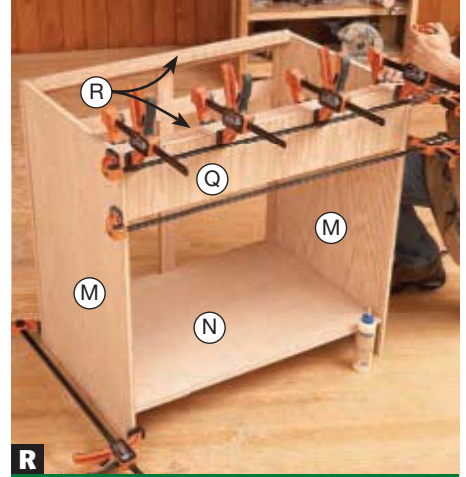

### INSTALL THE CLEATS

Glue a top cleat (R) to the top rail (B). Glue the back cleat (Q) to the rear top rail and sides (M), flush with the rabbets.

## 8 CARCASE EXPLODED VIEW

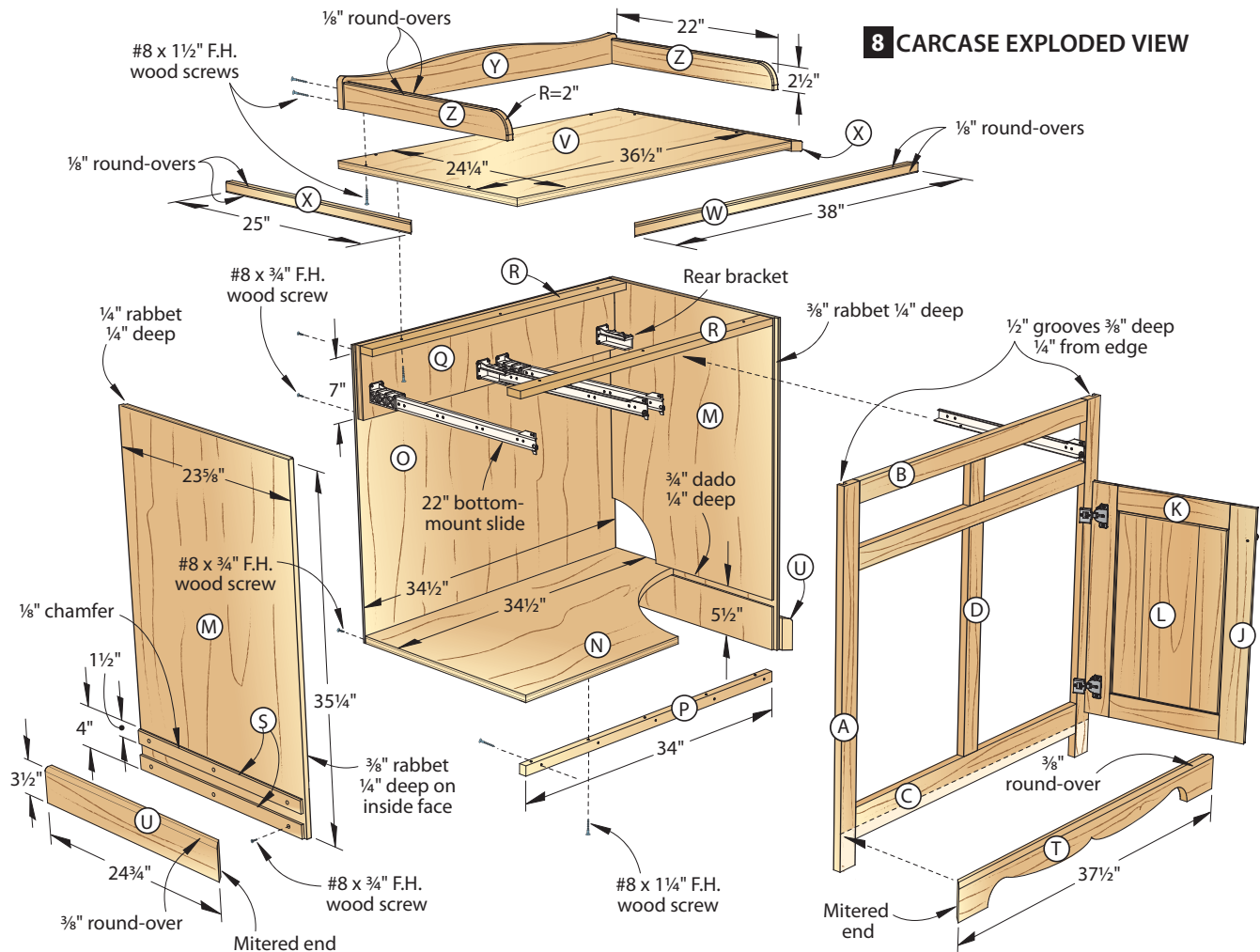

bottom edge. After determining these dimensions, cut the pieces to size.

**Adams' Insight:** Making the back flush with the bottom prevents it from hanging up on a high spot on the floor, and, if you're making several cabinets, also allows for three backs instead of two to be cut from a single sheet of plywood.

**Note:** If you plan to brush on a finish, apply it to the inside faces of the sides (M), bottom (N), and back (O) now.

(For a topcoat, we applied three coats of wipe-on polyurethane, buffing lightly with 320-grit sandpaper between coats.)

**Adams' Insight:** Applying only clear finish to the interior leaves it lighter, making it easier to see inside.

Begin assembly of the carcass as shown in **Photo P**. Screw the bottom cleat (P) in place next [**Photo Q**]. Cut the back cleat (Q) and top cleats (R) to fit between the sides (M) [**Drawing 8**]. Drill countersunk shank holes in the top cleats and glue them in place with the countersinks on the bottom face [**Photo R**]. Glue in the back cleat, then glue and screw the back (O) in place.



### S INSTALL THE FILLERS

Glue and screw the chamfered fillers (S) 4" from the bottom, and the unchamfered fillers flush with the bottoms of the sides (M).

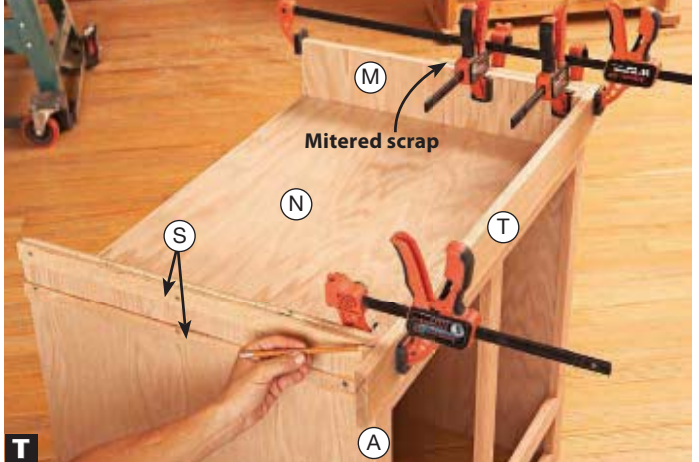

### T MARK THE BASE FRONT'S LENGTH

Create a tight joint with the mitered scrap and base front (T), then mark the length of the base front at the face-frame stile (A).

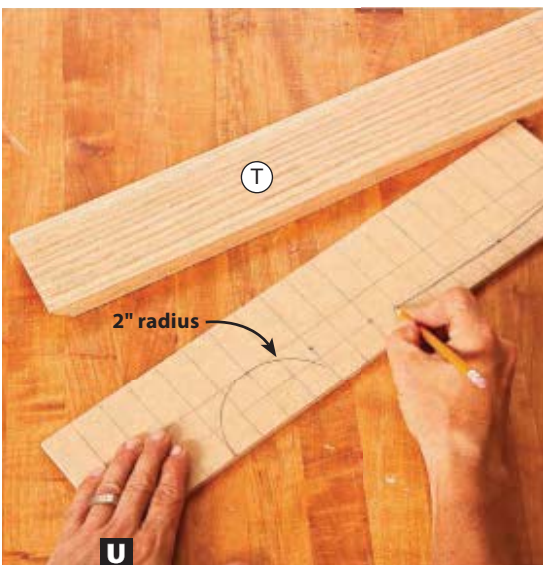

### U LAY OUT THE PROFILE TEMPLATE

Lay out the 2" radius and several points in the arc. Connect the dots and radius with a sweeping line. Cut and sand to the line.

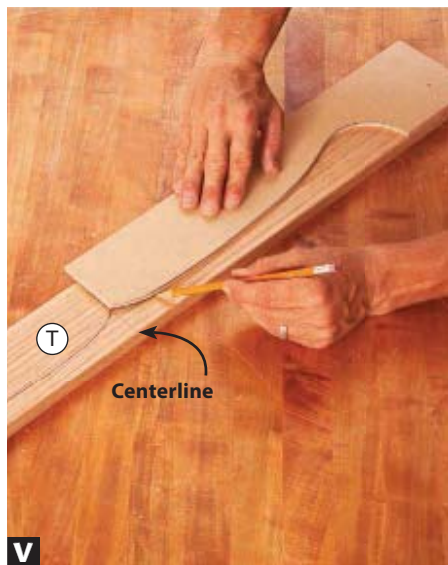

### V LAY OUT THE BASE PROFILE

Draw a centerline on the base front (T). Trace around the template on one side, then flip the template and draw the other half.

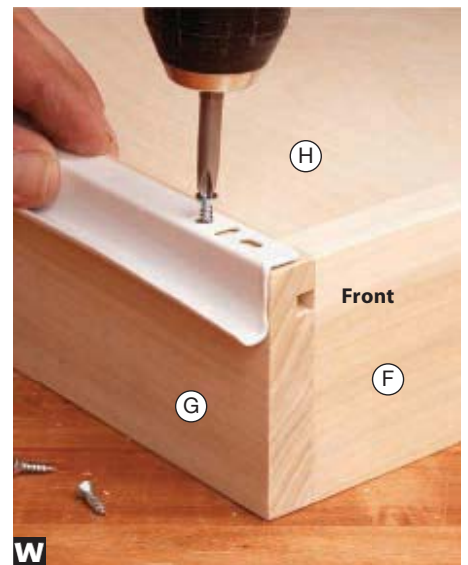

### W INSTALL THE DRAWER SLIDES

Mount the drawer half of the slides on the bottom edge of each side (G), flush with the front of the drawer.

## TRIM IT UP AND APPLY A FINISH

Plane stock for the fillers (S) to fit the gap between the edge of the face-frame stiles (A) and the sides (M). Rip the fillers to width [Drawing 8] and crosscut them to fit between the rear face of the stile and the rear edge of the sides. To dress up the visible edge, rout a 1/8" chamfer on two of the fillers, then glue and screw the fillers in place [Photo S].

Cut the base front (T) 2" longer than the cabinet's width, and the base sides (U) 2" longer than the cabinet's depth, and rout 3/8" round-overs along the top edges [Drawing 8]. Miter one end of each piece and a 3/4 x 3 1/2 x 12" piece of scrap. Clamp the base front and the scrap to the cabinet and mark the opposite end of the base front [Photo T].

Miter-cut the base front (T) to length, then clamp the base pieces around the

cabinet. Mark the length of the base sides (U), and crosscut them. On a piece of 1/4" hardboard, lay out a 1" grid and transfer the **Base Front Pattern** to it [Drawing 9, Photo U].

**Adams' Insight:** Don't worry about matching the exact shape of the pattern; instead, work for a smooth, flowing line close to what's shown.

Cut and sand the template to shape, then use it to lay out the profile on the base front (T) [Photo V]. Cut and sand the profile, then glue the base pieces around the carcass.

Screw the drawer half of the slides to the drawers [Photo W], then mount the cabinet portion of the slides to the face frame only.

With the drawer faces (I) facedown on your bench, position the drawer boxes (F/G/H) on the faces 3/4" from the bottom edge and centered side-to-side. Drive screws from inside the drawer to secure the faces. Clamp a drawer in place [Photo X], position the drawer-slide rear brackets and tack them in place. Test the drawer operation, then drive the bracket screws. Repeat this for the remaining drawer. Install the hinges in the doors [Photo Y], then hang the doors [Photo Z].

Cut the top (V) to size from 3/4" plywood [Drawing 8]. Cut the front trim (W) and side trim (X) to width and 2" overlength, and rout 1/8" round-overs on the top and bottom edges. Miter the trim to fit around the top using the same technique as used with the base trim. Then, glue the trim in place, keeping the



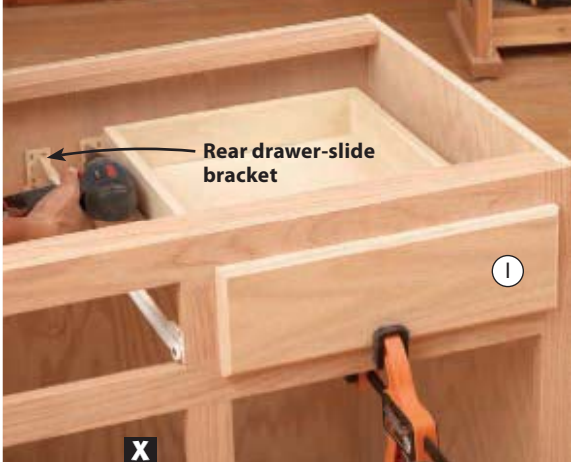

Rear drawer-slide bracket

X

### INSTALL THE REAR BRACKET

Use a drawer to find the rear-bracket location. The slotted bracket holes allow for minor adjustments side-to-side and up and down.



Y

### MOUNT THE HINGES AND DOORS

Use a square to align the hinges as you drive the screws, *left*. Set the cabinet on its back and place a 1"-wide spacer below the drawer face (I), *right*. Install the door so when closed, it rests against the spacer. Use the hinge-adjustment screws for fine-tuning the door position.



Z

## 9 BASE PATTERN

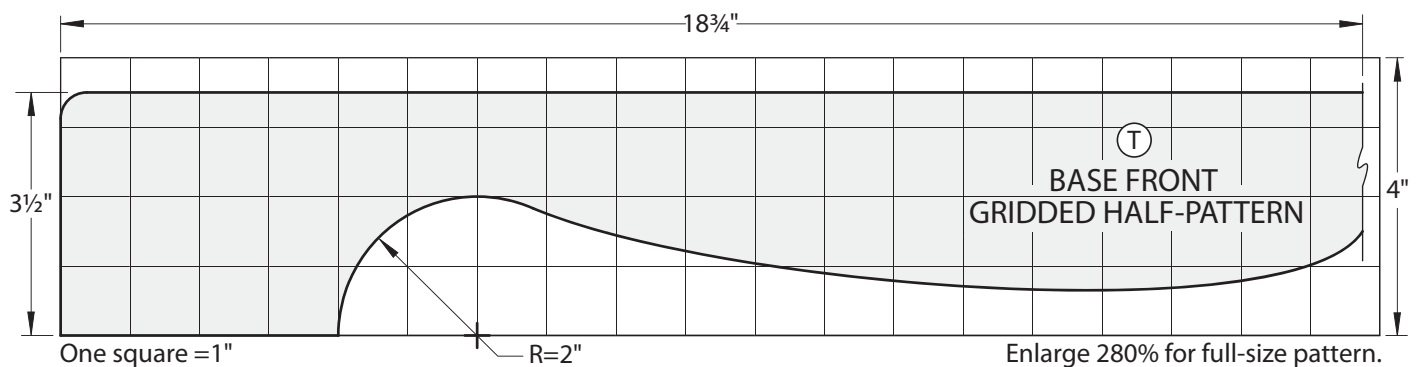

## 10 BACKSPLASH PATTERN

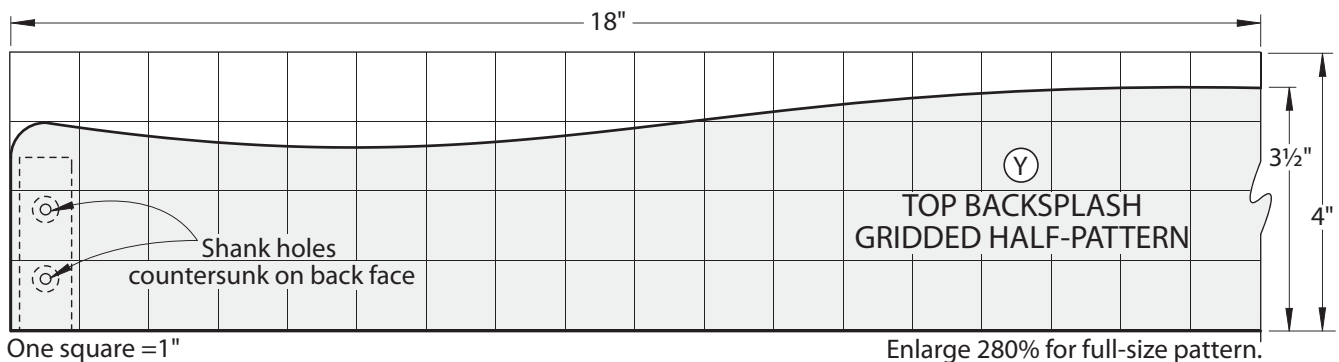

top faces flush. Finish-sand the top (V/W/X) to 220 grit after the glue dries.

As with the base, create a template [Drawing 10] for the backsplash (Y). Cut the backsplash and splash sides (Z) to size and shape [Drawing 8]. Round over the top edges and rounded front ends of the splash sides, then sand the splash sides and backsplash to 220 grit. Screw the backsplash to the top (V/W/X), flush at the rear and centered side-to-side. Then screw the splash sides to the top and backsplashes.

## MORE RESOURCES

### FREE VIDEOS

- Learn our two-cut method for perfect-fitting dados on the tablesaw at: [woodmagazine.com/deadondado](http://woodmagazine.com/deadondado).
- Handle sheet goods the easy way with tips at: [woodmagazine.com/sheetgoods](http://woodmagazine.com/sheetgoods).
- Break down sheet goods easily and accurately with a circular saw or router: [woodmagazine.com/straightedge](http://woodmagazine.com/straightedge).

### RELATED VIDEOS

- Download Marc Adams' video "Cabinetmaking" and his other video titles by searching "Marc" at: [woodmagazine.com/betterwoodworking](http://woodmagazine.com/betterwoodworking). \$

\$ = Download these videos for a fee.

## Materials List

Part	FINISHED SIZE			Matl.	Qty.	
	T	W	L			
<b>Face frame</b>						
A	stiles	¾"	2"	35¼"	O	2
B	upper rails	¾"	2"	32"	O	2
C	lower rail	¾"	3"	32"	O	1
D	door divider	¾"	2"	21¾"	O	1
E	drawer divider	¾"	2"	4"	O	1
<b>Drawers</b>						
F	fronts/back	⅝"	3"	13¼"	P	4
G	sides	⅝"	3"	21"	P	4
H	bottoms	¼"	13⅜"	20⅜"	BP	2
I	faces	¾"	5"	16"	O	2
<b>Doors</b>						
J	stiles	¾"	2½"	22¾"	O	4
K	rails	¾"	2½"	11¾"	O	4
L*	panels	¾"	11½"	18¼"	EO	2
<b>Carcase</b>						
M	sides	¾"	23⅝"	35¼"	OP	2
N	bottom	¾"	23"	34½"	OP	1
O	back	¼"	34½"	30½"	OP	1
P	bottom cleat	¾"	¾"	34"	O	1
Q	back cleat	¾"	34"	7"	OP	1
R	top cleats	¾"	1¾"	34"	O	2
<b>Base and top</b>						
S	fillers	¼"	1½"	23¼"	O	4
T*	base front	¾"	3½"	37½"	O	1
U*	base sides	¾"	3½"	24¾"	O	2
V	top	¾"	24¼"	36½"	OP	1
W*	front trim	¾"	¾"	38"	O	1
X*	side trim	¾"	¾"	25"	O	2
Y	backsplash	¾"	3½"	36"	O	1
Z	splash sides	¾"	2½"	22"	O	2

\*Parts initially cut oversize. See the instructions.

**Materials key:** O—oak; P—poplar; BP—birch plywood; EO—edge-glued oak; OP—oak plywood.

**Supplies:** ⅝" dowels (20); #8×¾", #8×1¼", #8×1½", #8×2½" flathead wood screws; 22" bottom-mount epoxy-coated roller slides (2 pr.); ½" overlay 35mm European hinges (4); ½" rubber bumpers (8); door knobs (2); drawer knobs (2).

**Blade and bits:** Stack dado blade; cope-and-stick, raised-panel, 45° chamfer, ⅜" round-over, ⅜" round-over router bits; ⅜" drill bit; 1⅜" Forstner bit.

### Source

**Rubber panel spacers:** Space balls no. 142284, \$5.99 [pack of 100], Woodcraft, 800-225-1153, woodcraft.com.

**Toggle clamp:** 2¾×4" vertical toggle clamp no. 143934, \$11.99, Woodcraft.

## Cutting Diagram



¾ x 7¼ x 96" Oak (5.3 bd. ft.) \*Plane or resaw to thicknesses listed in the Materials List.



¾ x 7¼ x 72" Poplar (4 bd. ft.)



¾ x 5½ x 96" Oak (4 bd. ft.) (2 needed)



¾ x 5½ x 72" Oak (3 bd. ft.)



¾ x 5½ x 60" Oak (2.5 bd. ft.)

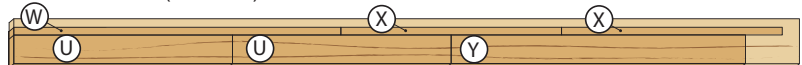

¾ x 5½ x 96" Oak (4 bd. ft.)

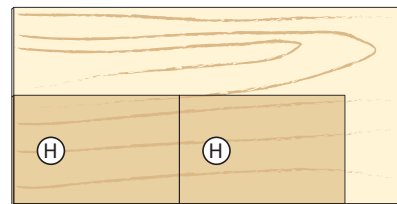

¼ x 24 x 48" Birch plywood

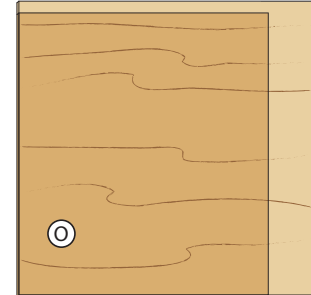

¼ x 36 x 36" Oak plywood

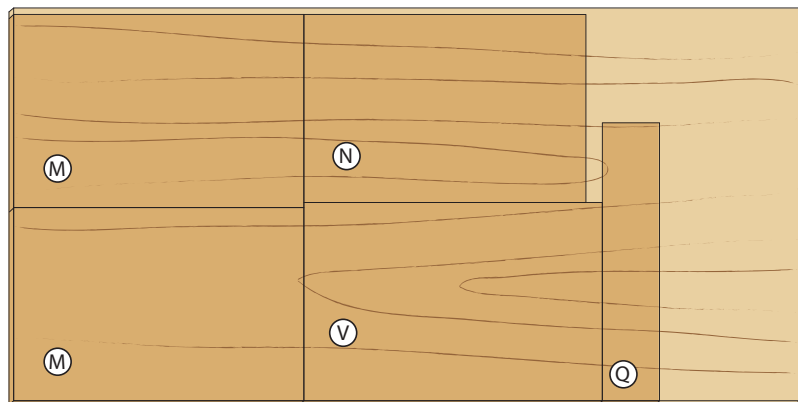

¾ x 48 x 96" Oak plywood

Center the top (V–Z) side-to-side on the carcass and flush at the back. Drive #8×1¼" flathead wood screws through the top cleats (R) into the top.

Install the drawer knobs, centering them on the drawer faces. Position each

door knob so its top edge aligns with the bottom of the top door rail (K).

Remove the hardware and the splash (Y, Z) and apply a stain (if desired) to the outside surfaces, and a topcoat to all surfaces. 🌱

Produced by **Craig Rueggeger** with **Marc Adams** and **Jeff Mertz**  
Project design: **Marc Adams; Jeff Mertz**  
Illustrations: **Roxanne LeMoine; Lorna Johnson**

# SAVE When You Grow A Zoysia Lawn From Plugs!



From Plugs

To A Fabulous Lawn



Zoysia Lawns are thick, dense and lush!

**GRASS SEED WILL NEVER GROW A LAWN LIKE THIS!**  
**Save Water! Save Time! Save Work! Save Money!**

### Grass Seed Is For The Birds!

Stop wasting money, time and work sowing new grass seed each spring, only to see birds eat the seed – or rain wash it away – before it can root. Plant a genuine Amazoy™ Zoysia lawn from our living Plugs only once... and never plant a new lawn again!

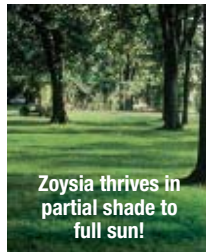

Zoysia thrives in partial shade to full sun!

### Zoysia Grows Where Other Grass Doesn't!

Zoysia is the perfect choice for hard-to-cover spots, areas that are play-worn or have partial shade, and for stopping erosion on slopes. North, South, East, West – Zoysia will grow in any soil, no ifs, ands or buts!

Each Zoysia Plug You Plant In Your Soil Is **GUARANTEED TO GROW** Within 45 Days Or We'll Replace It FREE!

To ensure best results, we ship you living sheets of genuine Amazoy™ Zoysia Grass, harvested direct from our farms. Plugs are not cut all the way through. Before planting, simply finish the separation by cutting 1" sq. Plugs with shears or knife. Then follow the included easy instructions to plant Plugs into small plug holes about a foot apart. Our guarantee and planting method are your assurance of lawn success backed by more than 5 decades of specialized lawn experience.

©2011 Zoysia Farm Nurseries, 3617 Old Taneytown Rd, Taneytown, MD 21787

### Eliminates Endless Weeds And Weeding!

No more pulling out weeds by hand or weeds sprouting up all over your lawn. Zoysia Plugs spread into a dense, plush, deep-rooted, established lawn that drives out unwanted growth and stops crab-grass and summer weeds from germinating.

### Environmentally Friendly, No Chemicals Needed!

No weeding means no chemicals. You'll never have to spray poisonous pesticides and weed killers again! Zoysia lawns are safer for the environment, as well as for family and pets!

### Cuts Watering & Mowing By As Much As 2/3!

Many established Zoysia lawns only need to be mowed once or twice a season. Watering is rarely, if ever, needed – even in summer!

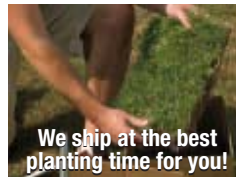

We ship at the best planting time for you!

Meyer Zoysia Grass was perfected by the U.S. Gov't, released in cooperation with the U.S. Golf Association as a superior grass.

[www.ZoysiaFarms.com/mag](http://www.ZoysiaFarms.com/mag)

### Stays Green In Summer Through Heat & Drought!

When ordinary lawns brown up in summer heat and drought, your Zoysia lawn stays green and beautiful. The hotter it gets, the better it grows. Zoysia thrives in blistering heat (120°), yet it won't winter-kill to 30° below zero. It only goes off its green color after killing frosts, but color returns with consistent spring warmth. Zoysia is the perfect choice for water restrictions and drought areas!

### Our Customers Love Their Zoysia Lawns!

One of our typical customers, Mrs. M.R. Mitter of PA, wrote how "I've never watered it, only when I put the Plugs in... Last summer we had it mowed 2 times... When everybody's lawns here are brown from drought, ours just stays as green as ever!"

### Order Now And Save!

The more Amazoy™ Zoysia Plugs you order, the more you SAVE! And remember, once your Zoysia lawn is established, you'll have an endless supply of new Plugs for planting wherever you need them. Order now!

**FREE! PLANTING TOOL** With Order of 400 Plugs or More!

Saves time, work and effort when making holes for Plugs!

**Order Your ZOYSIA Plugs Now — Harvested Daily From Our Farms And Shipped To You Direct!**

**ZOYSIA GRASS SUPER SALE — SAVE OVER 50%! Get Up To 900 Plugs — FREE!**

Please send me guaranteed Amazoy as checked:

# PLUGS	+ FREE Plugs	FREE Bonus	Retail Value	Your PRICE	+ Shipping	SAVINGS
<input type="checkbox"/> 100	—	—	\$ 8.95	\$ 8.95	\$ 5.00	—
<input type="checkbox"/> 200	+ 100	—	\$ 26.85	\$ 17.90	\$ 5.00	30%
<input type="checkbox"/> 400	+ 200	Free Step-on Plugger	\$ 62.65	\$ 35.80	\$ 7.50	40%
<input type="checkbox"/> 500	+ 300	Free Step-on Plugger	\$ 80.55	\$ 44.75	\$ 10.00	42%
<input type="checkbox"/> 600	+ 400	Free Step-on Plugger	\$ 98.45	\$ 53.70	\$ 12.50	44%
<input type="checkbox"/> 900	+ 700	Free Amazoy Power Auger	\$ 168.15	\$ 80.55	\$ 15.00	50%
<input type="checkbox"/> 1000	+ 900	Free Amazoy Power Auger	\$ 195.00	\$ 89.50	\$ 17.50	54%

Extra Step-on Plugger \$8.95 + \$3 Shipping  Extra Amazoy Power Auger™ for 3/8" Drill \$24.95 + \$5 Shipping

Amazoy is the trademark registered U.S. Patent Office for our Meyer Zoysia grass.

Mail to: ZOYSIA FARM NURSERIES  
 3617 Old Taneytown Road, Taneytown, MD 21787

Dept. 5628

Write price of order here \$ \_\_\_\_\_

Payment method (check one)

Md. residents add 6% tax \$ \_\_\_\_\_

Check  MO

Shipping \$ \_\_\_\_\_

MasterCard

ENCLOSED TOTAL \$ \_\_\_\_\_

Visa

Card # \_\_\_\_\_ Exp. Date \_\_\_\_\_

Name \_\_\_\_\_

Address \_\_\_\_\_

City \_\_\_\_\_ State \_\_\_\_\_

Zip \_\_\_\_\_ Phone \_\_\_\_\_

We ship all orders the same day plugs are packed at earliest correct planting time in your area.

**Order Now! [www.ZoysiaFarms.com/mag](http://www.ZoysiaFarms.com/mag)**

Not shipped outside the USA or into WA or OR

SHOP TESTED

# Oscillating Multi-tools



They saw, sand, scrape, and more. Is it time to add one to your tool box?

**Y**ou've seen the TV infomercials where these tools tackle a variety of DIY jobs: scraping adhesive, breaking out tile grout, cutting through pipes, bolts, and drywall. We tested 10 multi-tools and found that, at times, nothing else works as well or as fast.

## How they work

Whether corded or cordless, an oscillating multi-tool vibrates a blade or other

attachment back and forth in a narrow arc (3–4°) at up to 21,000 strokes per minute. Because of the tool's short range of blade motion, small front-end profile, and blades that extend past the snout of the tool, it reaches into tight spots other tools can't. A multi-tool also works well for flush cutting because the stepped profile of many blades and other attachments allows the attachment to rest flat on a surface.

## Uses in the woodshop

For woodworkers, we found the detail-sanding heads, *below*, the most useful attachments. They sand small project parts and fit in tight quarters—but don't plan on smoothing a large panel with a multi-tool.

With a wood-cutting blade installed, you can make plunge cuts in the middle of a panel to create a cord pass-through in a desktop or cabinet back; trim plugs or splines nearly flush to a surface; and cut away sections of baseboard to install built-in cabinets. For such tasks, the aggressive teeth of the wood-specific blades cut slightly quicker than the combination wood- and metal-cutting blades, but left rougher surfaces. So we prefer the cleaner cuts, ease of control, and smoother cut edges left by the combination blades. The trade-off: burning if you get impatient and push the blade too quickly.

We were surprised to find that even when a blade jammed in a tight spot, no motor ever bogged down; instead, the oscillating motion transferred to the tool body, vibrating the operator's arm.

## NO OTHER SANDER GOES HERE

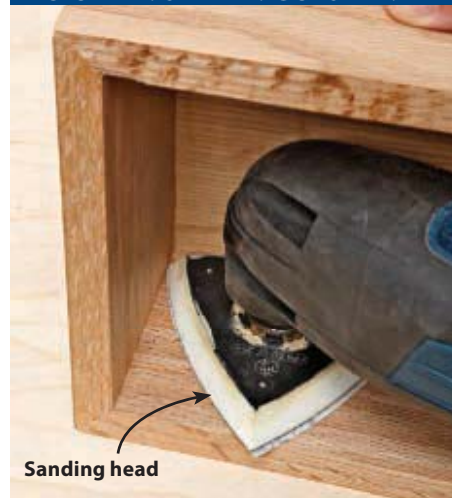

A triangular sanding head reaches into corners like those on this narrow drawer. Soft edges prevent marring adjacent surfaces.

## What to look for

■ **Comfortable grip.** Because you typically wrap one or both hands around the tool's barrel, its circumference and shape determine how well the tool fits in your hand, *opposite page, top*. Circumferences under 7" suit small hands best. (See **Circumference at grip** in the chart on *page 68*.)

The extra weight of the Fein Multi-Master 250Q—at 4 lbs 1 oz it was nearly twice as heavy as most other models—

**Fein MultiMaster** 7<sup>7</sup>/<sub>8</sub>" circumference  
**Rockwell RK2514K2** 6<sup>1</sup>/<sub>4</sub>" circumference



### GET A GRIP THAT FITS

With a test-largest circumference near 8", the Fein, left, is a handful. The cordless Rockwell, right, has the smallest circumference.

helps it sand quickly, but made it tiring to hold during extended use. It also felt back-end heavy, making it challenging to keep it level and avoid dishing.

■ **Minimal vibration.** The Bosch Multi-X runs smoothest; the Ridgid JobMax buzzes most, probably due to play in its removable head. (The JobMax body accepts drill, auto-hammer, impact driver, and ratchet heads.) Fein's Multi-Master runs loudest when cutting (106 dB), while the Rockwell RK2514K2 goes easiest on the ears at all speeds, registering 62 dB running at low speed, and 93 dB during a cut at high speed.

Further smoothing things out, the Fein and the Dremel Multi-Max 6300 and 8300 feature soft-start motors that ease the tool up to speed and prevent it from jerking to the side when switching on the power.

■ **Variable speed.** Slower speeds make delicate sanding jobs more manageable. Cutting and grinding work best at the highest speeds. Every tool except the cordless Craftsman 17438 offers variable-speed control.

■ **Quick accessory changes.** With as many attachments as these tools accept, swapping them becomes a common task. Fein's toolless system, shown on the next page, takes only seconds. All others, except the Dremel models, require completely removing the retaining bolt with a supplied hex wrench. However, by using Dremel's adapter (see **The Fit Can Give You Fits**, above), any tool benefits from the Dremel blades' unique mounting, shown on the next page.

Before purchasing a multi-tool, find out if the attachments your local retail-

## THE FIT CAN GIVE YOU FITS

With so many multi-tool manufacturers, each with its own mounting system, attachments aren't always interchangeable from brand to brand. As you can see in this chart, Dremel tools accept only Dremel attachments (unless you purchase Bosch's adapter, bottom), while Milwaukee (below) and Ridgid accept attachments from any other maker using a provided adapter.

Taking a different tack, Bosch and Dremel recently introduced universal adapters (bottom photo). Instead of adapting the other guys' attachments to fit Bosch or Dremel multi-tools, the adapters allow all current multi-tools to accept either the Bosch or Dremel attachments.

TOOL MANUFACTURER	ATTACHMENT MANUFACTURER*					
	BOSCH	CRAFTSMAN	DREMEL	FEIN	RIDGID	ROCKWELL
<b>BOSCH Multi-X</b>	F	-	A/D	A	-	-
<b>CRAFTSMAN Multi-Tool</b>	B	F	D	F	F	F
<b>DREMEL Multi-Max</b>	B	-	F	-	-	-
<b>FEIN MultiMaster</b>	B	F	D	F	F	F
<b>MILWAUKEE</b>	F	A	A/D	A	A	A
<b>RIDGID JobMax</b>	A/B	F	A/D	F	F	F
<b>ROCKWELL SoniCrafter</b>	B	-	A/D	-	F	F

A = Fits with adapter included with tool  
 B = Fits using Bosch adapter  
 D = Fits using Dremel adapter  
 F = direct fit  
 - = does not fit  
 \* Milwaukee does not sell individual attachments.

### FIT THE TOOL TO ANY BLADE...

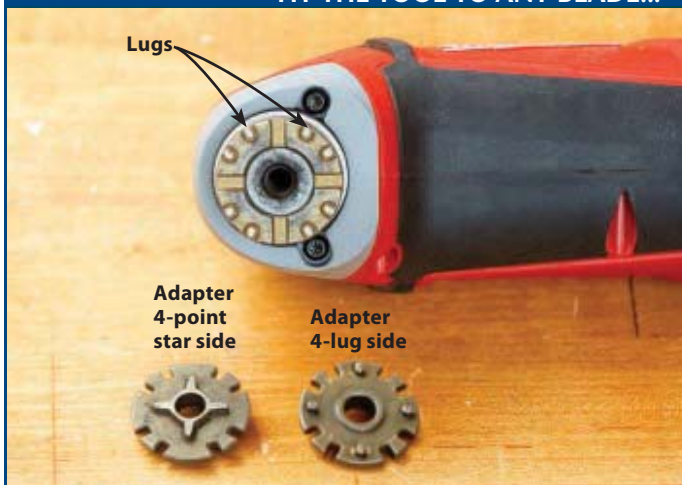

The Milwaukee tool uses 10 lugs molded around its head and a two-sided adapter to match every blade-mounting configuration.

### ...OR FIT THE BLADE TO ANY TOOL



Owners of any multi-tool can increase their choices to include Bosch or Dremel attachments by using Bosch's two-sided adapter or Dremel's single-sided adapter.

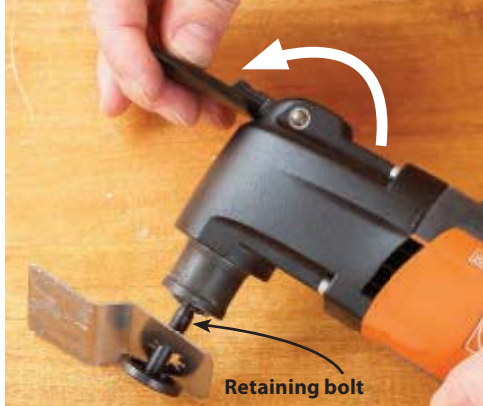

Retaining bolt

### CHANGE ATTACHMENTS QUICKLY

Lifting a lever on the Fein MultiMaster releases the retaining bolt. Seat the blade, press the bolt in, then flip the lever back down.



### U-SHAPE FOR EASIER MOUNTING

The open end of the Dremel attachments allows you to slide them in place without fully removing the retaining bolt.

ers carry fit that tool. A local supplier provides more convenience, and often lower cost, than ordering attachments online.

■ **Task lights.** Because multi-tools work well in tight quarters, such as inside a cabinet, we appreciate the LED task lights on the Craftsman 17438 and 23465, Ridgid, and cordless Rockwell.

## These tools make the cut

If you do much built-in work or installation, you'll love a tool like this. Likewise, if you have lots of general repair and renovation jobs around the house. We found these tools handy for some sanding and cutting jobs in the woodshop, too.

The tank-like construction, good dust collection, and quick-change accessory mount of the Fein MultiMaster 250Q earn it our overall Top Tool award. However, it can be a handful, literally, and requires a fine touch to get good results. The Bosch Multi-X earns Top Tool among the cordless versions. It's best for users who want a lighter, smooth-running tool with cordless convenience. The Craftsman 23465, at just \$80, is our Top Value. Steer clear of the cordless Craftsman 17438. Its slow fixed speed takes longer to do jobs, and it comes with just one battery (as does the Ridgid), so you'll have to wait for a recharge. 🌱

Bosch Multi-X PS50-2B \$200  
877-267-2499, boschtools.com



Craftsman Multi-Tool 17438 \$100  
800-383-4814, craftsman.com



Craftsman Multi-Tool 23465 \$80  
800-383-4814, craftsman.com



Dremel Multi-Max 6300 \$100  
800-437-3635, dremel.com



## GOOD VIBRATIONS:

BRAND	MODEL (KIT)	TOOL DIMENSIONS		NO-LOAD STROKES PER MIN (x1,000)	BLADE CHANGE (1)	DUST-PORT SIZE (INSIDE DIAMETER)	TASK LIGHT (YES, NO)
		LENGTH	CIRCUMFERENCE AT GRIP				
BOSCH MULTI-X	PS50-2B	11¼"	6½"	5-20	H	NA	N
CRAFTSMAN MULTI-TOOL	17438	9¾"	6⅞"	15 only	H	1¼"	Y
	23465	10⅜"	7⅜"	11-19	H	1¼"	Y
DREMEL MULTI-MAX	6300 (-05)	9½"	7⅞"	10-21	H	NA	N
	8300 (-01)	10⅞"	6⅞"	3-21	H	NA	N
FEIN MULTIMASTER	FMM 250Q (Select Plus)	10"	7⅞"	11-20	T	1⅞"	N
MILWAUKEE	2426 (-22)	11"	6¾"	5-20	H	NA	N
RIDGID JOBMAX	R82235	11½"	6⅜"	0-20	H	NA	Y
ROCKWELL SONICRAFTER	RK2514K2	11¼"	6¼"	5-20	H	1¼"	Y
	RK5101K (37-pc. professional)	10⅞"	7¾"	11-20	H	1⅞"	N

### NOTES

1. (H) Hex wrench  
(T) Toolless

2. **A** Excellent  
**B** Good  
**C** Fair  
**D** Poor  
**NA** Not Applicable

3. (A) Straight wood blade  
(B) Semicircular wood blade  
(C) Straight bi-metal blade  
(D) Semicircular bi-metal blade  
(E) Semicircular grout blade  
(F) Triangular grout blade  
(G) Scraper blade

Dremel Multi-Max 8300 \$150  
800-437-3635, dremel.com



Milwaukee 2426 \$149  
800-729-3878, milwaukeetool.com



Rockwell SoniCrafter RK2514K2 \$170  
800-514-7625, rockwelltoolsdirect.com



Fein MultiMaster FMM 250Q \$329  
800-441-9878, fein.com



Ridgid JobMax R82235 \$100  
866-539-1710, ridgid.com



Rockwell SoniCrafter RK5101K \$140  
800-514-7625, rockwelltoolsdirect.com



## GET A GRIP ON OSCILLATING MULTI-TOOLS

PERFORMANCE GRADES (2)																						
VIBRATION	SEMICIRCULAR BLADE PLUNGE CUT				STRAIGHT BLADE PLUNGE CUT		FLUSH CUTTING		SANDING	GRINDING TILE GROUT		CUTTING #8 COMMON NAILS		INCLUDED ACCESSORIES (3)	TOOL WEIGHT (LB-OZ)	NOISE LEVEL UNDER LOAD (in dB) (4)	CORD LENGTH (IN FEET)	BATTERIES		WARRANTY (YEARS) (6)	COUNTRY OF ASSEMBLY (7)	PRICE (8)
	SPEED	LACK OF TEAR-OUT	ABSENCE OF BLADE DEFLECTION	ABSENCE OF BLADE DEFLECTION	SPEED	LACK OF TEAR-OUT	ABSENCE OF BLADE WANDER	LACK OF TEAR-OUT	ABSENCE OF SANDING MARKS	SPEED	ABSENCE OF NICKS IN TILE	SPEED	DUST-COLLECTION EFFICIENCY					NUMBER INCLUDED (5)	CHARGE TIME (MIN.)			
A-	A	B	A	A	B	A-	B	A	A	C	A	NA	A-E, G, H, I (24), K	2-2	97	NA	2	30	3*	M	\$200	
B	B-	B	A	C	C	B	C	B	B-	A	D	B	A, B, D, G, H, I (9), J, L	1-13	100	NA	1	45	1	C	\$100	
B+	B-	B	A	B	B	A	A	B	B	A	A	C	A, B, D, G, H, I (9), J, L	2-11	100	8	NA	1	C	\$80		
B+	B	B	B-	C	C	A	A	B	B	A	A	NA	A, B, H, I (3), K	1-15	98	6	NA	2	X	\$100		
B+	B-	B+	A	B	B	A	B+	B	B	A	A	NA	A, B, H, I (3), K	1-13	102	NA	2	60	2	X	\$150	
B	A	A	A	A	D	B	B	B	A	C	A	A	A, B, C, E, G, H, I (20), J, K, M (2)	4-1	106	16	NA	1, 3*	G	\$329		
B	B	A	A	B	B+	A-	A-	B	A	B	A	NA	A, H, I (5), L	2-3	103	NA	2	30	5	C	\$149	
C+	B	A-	B	B	B+	A-	A	B-	B	A	A	NA	C, D, H, I (5), L	2-4	98	NA	1	30	3, LIFETIME*	C	\$100	
B	B-	A-	B	B	B+	A	A	B	B	A	A	A	A-C, E, G, H, I (20), L, M	2-3	93	NA	2	30	2	C	\$170	
B+	B-	A-	A	B	C	A	A	B	B-	A	B	A	B, C, E, G, H, I (30), L	3-10	95	10	NA	2	C	\$140		

(H) Triangular sanding pad(s)  
(I) Sanding sheets (qty.)  
(J) Triangular carbide rasp  
(K) Hard-shell case  
(L) Soft case  
(M) Accessory box for attachments

4. Every increase or decrease of 3dB is a doubling or halving of perceived volume.

5. All 12-volt lithium-ion  
6. \*Register for warranty of this length.  
7. (C) China  
(G) Germany  
(M) Malaysia  
(X) Mexico

8. Prices current at time of article production and do not include shipping, where applicable.



# Scrollsawn Dinosaur Puzzle

Park Jurassic in front of a youngster and watch his or her imagination go into high gear. It's dino-mite!

## PROJECT HIGHLIGHTS

- Overall dimensions are 22" wide × 5½" deep × 6¾" high.
- Learn how to scrollsaw perfectly fitted parts from two different wood species at the same time.

**1** Edge-glue a panel for the volcanoes (A) blank. Then, paying attention to grain orientation, cut blanks for parts B–H and cut the base (I) to size [Materials List]. Sand the blanks to 180 grit.

**2** Make four photocopies of the tree (B/C) pattern on the *WOOD Patterns*® insert and one copy each of the patterns for the volcanoes (A) and the dinosaurs (D, E, F, G, H). Apply the patterns to blanks using spray adhesive, noting the grain orientation shown. Using a #2 scrollsaw blade, cut the outlines of parts A, D, E, F, G, and H.

**3** Now rough-cut the treetops (B) along the edge where they join the trunks (C). For each tree (B/C), attach a treetop blank to a trunk blank with

double-faced tape [Photo A], and scrollsaw the shape of the trees.

**4** Switch to a #2/0 blade for a close fit between the puzzle pieces. Drill and cut the dinosaurs and volcanoes. Then scrollsaw the individual puzzle parts where shown on the patterns.

**5** Cut ½" grooves ⅜" deep in the base (I) where shown. Sand the base to 180 grit, touch-up-sand the figures as needed and apply three coats of clear finish. (We used spray lacquer, sanding between coats with 320-grit sandpaper.)





### CUT TWO-THICK FOR PERFECT FIT



**A** Align the patterns on the treetop (B) and tree trunk (C), then stack-cut both pieces to shape. Keep them together until you finish cutting the lobe that connects the two parts.

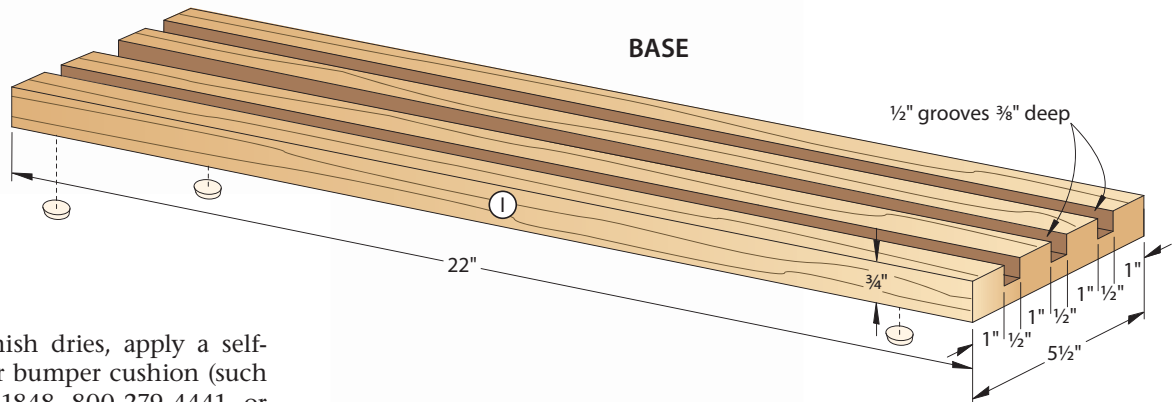

**6** After the finish dries, apply a self-sticking door bumper cushion (such as Rockler no. 31848, 800-279-4441, or rockler.com) to each of the bottom four corners of the base. 🌲

Produced by **Dave Campbell** with **Kevin Boyle**  
 Project design: **Roxanne LeMoine**  
 Illustrations: **Roxanne LeMoine; Lorna Johnson**

## SHOP TIP

### Start by becoming a Scrapwood Selectosaurus

You can craft this puzzle mostly out of pieces from your scrap bin, but being selective about the scraps you choose elevates the project from good to great. For example, we took advantage of a streak of light-colored sapwood in the walnut to make the tall volcano look snow-capped. The ray flecks in the lacewood suggest the “armor”

that jackets a Stegosaurus.

And the bold stripes of the zebrawood help create the illusion of the ribs on the “fin” of the Dimetrodon, as shown *here*.

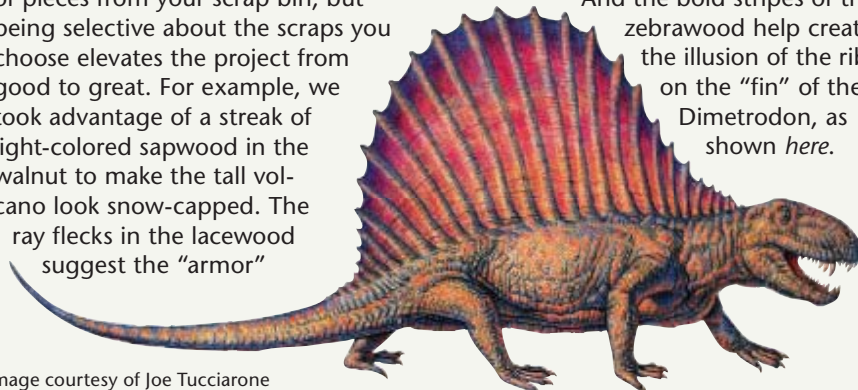

Image courtesy of Joe Tucciarone

## Materials List

Part*	FINISHED SIZE				Matl.	Qty.
	T	W	L			
A volcanoes	1/2"	6"	15 3/4"	W	1	
B treetops	1/2"	1 3/4"	3 1/4"	P	2	
C tree trunks	1/2"	1"	4 1/2"	W	2	
D Apatosaurus	1/2"	4 1/2"	13 1/2"	P	1	
E Tyrannosaurus	1/2"	5"	7 3/4"	W	1	
F Dimetrodon	1/2"	5 1/4"	3 1/4"	Z	1	
G Triceratops	1/2"	3 1/2"	5 3/4"	M	1	
H Stegosaurus	1/2"	4"	6"	L	1	
I base	3/4"	5 1/2"	22"	M	1	

\*All part dimensions, except for the base (I), are for blanks to be scrollsawn.

**Materials key:** L-lacewood, M-mahogany, P-poplar, W-walnut, Z-zebrawood.

**Supplies:** Spray adhesive, double-faced tape, door bumper cushions (4).

**Blades and bits:** 1/2" dado set or straight router bit, #2 and #2/0 scrollsaw blades, 1/16" drill bit.



# Easy Sliders

How to choose the right drawer slides and mount them for smooth results.

Some woodworkers avoid drawers in their projects because they perceive them to be difficult to install. Truth is, once you know a few tricks, you'll soon be installing drawers with ease. In this article, you'll learn about three common types of tandem (two-piece) drawer slides frequently found on WOOD® magazine projects. We'll demonstrate on face-frame cabinets, which

typically require mounting brackets at the rear of the slides and sometimes at the front. These slides install even easier in frameless cabinets.

Before building the cabinet or drawer boxes, purchase your drawer slides, or at the least know their dimensions and mounting criteria. Then build the cabinet to suit the slides. Your drawer boxes *must* be flat with square corners.

Nearly all side-mount slides, when coupled together, measure ½" thick. So when sizing your drawer boxes, allow ½" of space between the drawer side and cabinet. (Bottom-mount slides typically measure ⅜" thick; see instructions on page 75 for these.) If you're using a bracket to attach the slides to the rear of the cabinet, reduce the drawer's length so it doesn't hit the bracket when closed.



# Epoxy-coated roller slides: low cost and easy to find

## Why choose these?

- Typically less than \$10 per pair, and available in most home centers.
- Because the drawer-mount members wrap around the drawer side's face and bottom edge, they're nearly impossible to install incorrectly.
- More forgiving than other slides if the mating slides don't align precisely, because the slide track has wiggle room for the plastic wheels to move side-to-side about  $\frac{1}{16}$ ".
- With no lubricant needed, they're ideal for dusty applications, such as shop cabinets.

For ease of installation, we attached the slide to the back of the cabinet with a standard mounting bracket. (These sell for about \$2 a pair.) Start by separating the drawer slide into its two parts: the cabinet-mount member and the drawer-mount member.

## Attach to the cabinet first

**1** Rest the cabinet-mount member on the cabinet's face frame,  $\frac{1}{32}$ " back from the front face. You can use an accessory device for holding the slide in position [Photos A, B], or simply hold it freehand, aligning it in the next step. Drill a pilot hole and drive one screw into the face frame.

**2** Measure the gap between the slide and the cabinet side to ensure you mount it perpendicular to the face-frame opening [Photo C].

**3** Drive a screw into one of the horizontal slots on the rear mounting bracket [Photo D].

**4** Repeat Steps 1–3 for the other side of the drawer opening.

## Now mount to the drawer

**1** Install the drawer-mount member on the drawer side, keeping it  $\frac{1}{32}$ " back from the drawer front. [Photo E]. Repeat for the other side of the drawer.

**2** Insert the drawer into the cabinet-mounted slides and test its fit. If the drawer binds, loosen the screw on the rear mounts and adjust the bracket side-to-side until the drawer slides smoothly.

**3** Use a straightedge to check the drawer front's fit to the face frame [Photo F]. If you need to adjust the drawer up or down, first drive a screw in the center of the rear-brackets' vertical slot. Remove the screw from the horizontal slot, make the necessary adjustments up

## START AT THE FACE FRAME



**A** Hold the slide perpendicular to the face frame—we like Kreg's magnetic mounting tool, shown—while attaching with screws.

## HERE'S ANOTHER WAY



**B** If your cabinet is sitting on a level surface, you can line up your slides by temporarily taping a torpedo level to the bar.

## KEEP IT PARALLEL



**C** Measure at the front and rear of the cabinet to make certain the slide runs parallel to the cabinet side.

## SECURE THE REAR BRACKET



**D** A single screw in the horizontal slot allows you to make slight side-to-side adjustments after mounting the opposing slide.

## SCREW THE SLIDE TO THE SIDE



**E** Drive an included screw nearest the front of the drawer first; then add a second one at the rear of the slide.

or down, and reattach it with a screw in the horizontal slot.

**4** Once the drawer front aligns with the face frame and the drawer slides smoothly, drive the remaining screws to secure the slides in place.

(If you've built inset drawers, the drawer front will be the finished face. If you'll attach an overlay drawer front to the drawer box's front, do this after installing and aligning the drawer slides.)

## AIM FOR A FLUSH-FIT DRAWER



**F** If your drawer has a gap like this, loosen the rear mounting brackets and adjust the slides down until the gap disappears.

## Source:

Magnetic drawer slide mounting tool: #NZ03, \$30, Kreg Tool Company, 800-447-8638, kregtool.com.

## Ball-bearing slides: built for heavy loads

### Why choose these?

- Ideal for drawers with hefty contents, such as silverware or tools.
- Full-extension range allows the drawer to open fully for best access to contents in the back. Less-costly,  $\frac{3}{4}$  extensions open to expose all but the back fourth of the drawer. Installation is the same for each style.
- Lubricated bearings make for the smoothest sliding action.
- Typical ball-bearing slides sell for about \$8 to \$25 per pair. Additional features, such as self-closing mechanisms or higher weight ratings, increase this cost.

### Mount to the drawer first

**1** Begin by attaching the drawer-mount member. With the slide aligned flush to the drawer front and bottom edge, attach with a screw at the front in a vertical slot [Photo G], and then add one at the rear.

**2** Repeat for the other side of the drawer; then separate the cabinet-mount portions of the slides.

### Now for the cabinet

**1** With the cabinet-mount member clipped into its front mounting bracket (about \$1 apiece), seat the bracket's wrapped shoulder snugly against the back of the face frame for the correct offset [Photo H].

**2** Tape a torpedo or any short level onto the slide—or use one with a magnet that will grip the slide—and use it to align the slide up or down. (The cabinet must be shimmed level for this to be accurate.) Measure the gap between the slide and cabinet side to ensure the slide mounts parallel to the cabinet side.

**3** Secure the rear mounting bracket (\$1.50 each) to the cabinet [Photo I].

**4** Slide the drawer into the cabinet mounts until the catches lock. To adjust the fit, use the same techniques from Step 4 of the roller slides.

**5** Drive the remaining screws to secure the slides in place.

### START WITH THE DRAWER MOUNT



**G**

With the slide still joined together, align it with the bottom edge of the drawer side. Slide it back to reveal a screw slot and drive a screw.

### FASTEN TO THE FACE FRAME



**H**

With the bracket resting on the face frame, hold the slide as level as possible, and then secure it with two screws in the frame.

### ATTACH THE BACK END



**I**

Use a self-centering bit to drill pilot holes and then drive a screw into the center of the horizontal slot to allow for adjustment later.

## Bottom-mount slides: completely hidden from view

### Why choose these?

- The mounting position allows you to make drawers nearly the full width of the drawer opening—minus  $\frac{1}{8}$ " on each side, netting more storage space than with other slides.
- Using a single slide (\$8 to \$20 per pair) in the center of the drawer reduces hardware costs.

When you use only one slide per drawer, you reduce the weight-carrying capacity to less than half that of a similar drawer with two slides. (Single bottom-mount slides typically rate for 25-pound capacity.) In order for the mounting screws to hold, you'll need to make your drawer bottoms  $\frac{1}{2}$ " thick, or add a spacer—shown on the bottom drawer on *page 72*—if using thinner bottoms. Most bottom-mount slides are  $\frac{3}{8}$ " thick, but leave  $\frac{5}{16}$ " under your drawer bottom for mounting. The extra  $\frac{1}{16}$ " provides clearance between the drawer sides and the face frame after mounting.

### Attach to the drawer first

**1** For inset drawers, align the slide flush with the drawer front and centered across its width. If your drawers will have an overlay front, notch the drawer box [Photo J] so the slide sits flush with the front face of the drawer box.

**2** Center the slide and attach it with screws at the front and back [Photo K].

### Add the cabinet mount

**1** Install the slide to the face frame, securing it with one screw [Photo L]. For inset drawers, first attach a mounting block  $\frac{3}{4}$ " thick inside the face frame to which you can screw the slide.

**2** Attach the slide to the rear of the cabinet with a mounting bracket, making sure it is square to the face frame. If your cabinet has a dust frame, you can mount the slide to it rather than the back.

### OPEN A PASS FOR THE SLIDE



**J** Cut the notch for the slide at least  $\frac{1}{8}$ " wider on each side, to the depth of the drawer bottom. Then chisel out the waste.

### AIM FOR THE CENTER



**K** With one screw holding the front of the slide in place, measure from the drawer side to make sure the slide sits centered and parallel.

### SET BACK AND IN THE MIDDLE



**L** Mount the slide  $\frac{1}{32}$ " back from the front of the face frame. You might need to angle the screw slightly to avoid the frame above.

### A SMOOTHER RIDE



**M** Glide pads not only prevent the drawer from rocking on a single slide, but they also make for smoother operation.

**3** To help support the drawer, add nail-in or self-adhesive glide pads to the face frame where the drawer-side bottom edges will pass [Photo M]. 🌿

Produced by **Bob Hunter** with **Kevin Boyle**

## MORE RESOURCES

- Watch FREE videos on making and installing drawers, at [woodmagazine.com/simpledrawers](http://woodmagazine.com/simpledrawers) and [woodmagazine.com/drslides](http://woodmagazine.com/drslides).
- Read about a simple technique for making drawers at [woodmagazine.com/easydrawers](http://woodmagazine.com/easydrawers). \$

- Learn for FREE how to make drawer-lock joints on your tablesaw at [woodmagazine.com/lockrabbet](http://woodmagazine.com/lockrabbet).
- Or, get a FREE article on making lock-rabbet drawer joints on your router table at [woodmagazine.com/drawerlockbit](http://woodmagazine.com/drawerlockbit).

## Sources

Drawer slides and mounting brackets, available at most home centers and these retailers:

- Lee Valley, 800-871-8158, [leevalley.com](http://leevalley.com).
- Woodworker's Hardware, 800-383-0130, [woodworkershardware.com](http://woodworkershardware.com).
- Rockler, 800-279-4441, [rockler.com](http://rockler.com).
- Woodcraft, 800-225-1153, [woodcraft.com](http://woodcraft.com).

# Ask WOOD

Answers to your questions from letters, e-mails, and WOOD Online®

## HAVE A QUESTION?

For an answer to your woodworking question, write to **ASK WOOD**, 1716 Locust St., LS-221, Des Moines, IA 50309-3023 or e-mail us at [askwood@woodmagazine.com](mailto:askwood@woodmagazine.com). For immediate feedback from your fellow woodworkers, post your questions on one of our woodworking forums at [woodmagazine.com/forums](http://woodmagazine.com/forums).

### Dirty dust bags: Launder as a last resort

**Q:** The inside of my dust collector's filter bag is really gunked up with a solid layer of powdery sawdust. The collector seems to be drawing less air than it used to. Should I throw the bag into the laundry to get it clean?

—Scott Villalon, Jacumba, Calif.

**A:** Scott, according to the experts at American Fabric Filter Co., a fine layer of dust coating the inside surface of the bag actually works with the fibers of the filter to trap small particles. But if you notice a thick crust of dust (called "dust cake"), or you're seeing dust bleed through the filter, or you experience significantly decreased suction, it's time to act.

Before you toss the filter bag in the washer, try these steps: With the dust collector running and the bag inflated, tap the bag with your hand or a

broomstick. If that doesn't clear up the cake, try blowing compressed air against the outside of the bag with the collector running. Still not getting satisfactory results? Then remove the bag, turn it inside out and vacuum any remaining dust cake, as shown below.

If you're still not happy with the bag's performance, the folks at American Fabric and Filter say that a spin in the washing machine could clear up any remaining problems, acting as a "reset" for the filter. (We suggest an industrial machine at your local laundromat rather than the one that normally keeps your whitie-tighties white and tight.) Turn the bag inside out, use the cold setting, and wash it on a gentle cycle with laundry detergent. Tumble-dry the bag on the air-only, no-heat setting or hang it outdoors in nice weather to dry completely before using it again.



Vacuuming the inside of your dust filter bag will remove most of the built-up dust cake that can clog the fabric.

### Wood strips stretch your clamp dollars

**Q:** I don't have many long clamps yet, but I want to tackle a bookcase for my next project. Is there a cheaper solution than dropping a lot of dough on long clamps I won't use often?

—Robert Templeman, Tampa, Fla.

**A:** Here's a slick trick for stretching your smaller clamps so they do the work of the big boys, Robert. Cut scrap strips of plywood just shorter than the case side that you're clamping. Drill holes at the ends using a bit or holesaw large enough to accommodate the jaws of your smaller clamps. Then, use this as a clamp stretcher as shown below.

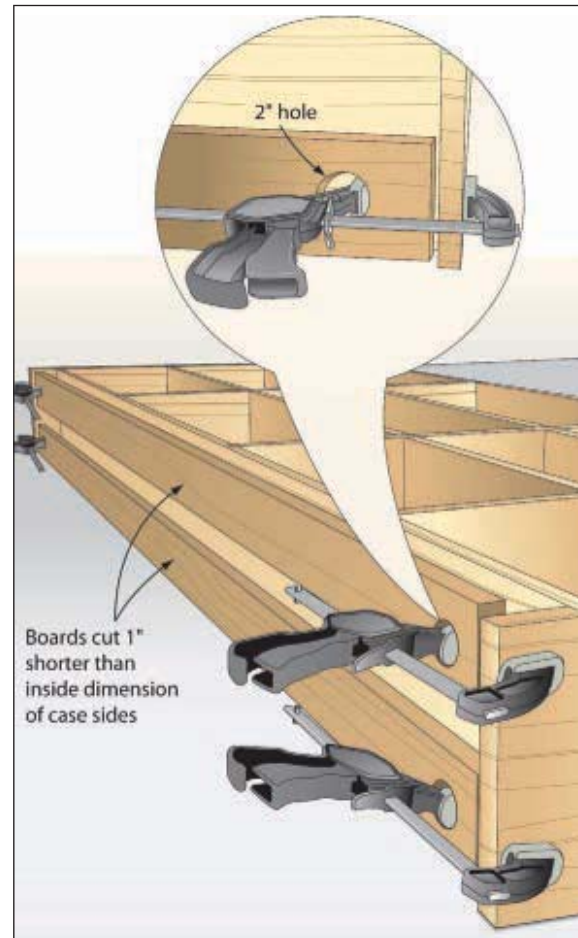

continued on page 78

# A BIG ASS FAN FOR MY SHOP?



## ABSOLUTELY!

You've got this great shop with high ceilings. It's too hot in the summer and too cold in the winter. The solution is the all new ShopFan™ from The Big Ass Fan Company, engineered with our patented airfoil technology to improve conditions in workshops up to 5000 square feet.



The monthly operating cost of a ShopFan is less than 50 cents per day...yet it does the work of more than twenty standard ceiling fans. It's an investment that will pay dividends for a lifetime.

### QUIRKY NAME. SERIOUS FANS.

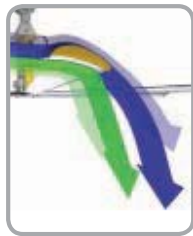

For over a decade, The Big Ass Fan Company has been engineering large, high-performance ceiling fans for tens of thousands of satisfied industrial customers worldwide. Like all of our fans, ShopFan is engineered, precision balanced and hand built with aircraft-grade aluminum and industrial components right here in Lexington, Kentucky. You can have this fan up and running in a couple of hours. And best of all, it's a genuine Big Ass Fan.

**TRY A SHOPFAN IN YOUR SHOP  
FOR 30 DAYS  
CONTACT US FOR DETAILS  
877-326-0599  
WWW.BIGASSFANS.COM**

### Truly A Big Ass Fan

- High Volume/Low Speed air movement technology
- Industrial ceiling fan quality

### Easy Installation

- Weighs less than 145 lbs
- Pre-wired for 115V 20A operation
- Includes 50-ft motor cord

### Keeps Things Cool

- Improves workplace comfort
- Increases productivity and accuracy

### Sized for Small Shops

- Air circulation for spaces up to 70 ft x 70 ft
- For ceilings as low as 14 ft
- 14-ft diameter fan

### Full-featured Controls

- Fully adjustable speed settings
- Compact control unit is pre-wired

### Year-round Energy Savings

- Low energy air circulation
- Provides cooling breezes in summer
- Heater runs less frequently by redistributing rising heat back down to floor level

Optional mounting bracket and 1 ft extension tube shown in photo.

**BIG ASS FANS**<sup>®</sup>  
No Equal.

# "Editors Choice!"

## Best Dust Collector

### Smart Dust Collector



American Woodworker Magazine Dec / Jan 2011 Issue #151 tested the 2 hp Smart Dust Collector

#### Most Powerful Tested

- Most Airflow (CFM)
- 2 - 3x the Suction (Static Pressure)

- Best Filtration  
GE H12 certified HEPA media filter (99.97% @ 0.3 - 0.5 microns)

**New!**  
Variable Speed - automatically adjusts to maximize suction and CFM  
Patent Pending

**New!**  
Compact! Only 77" High  
Strobe Light - flashes when dust barrel is full!  
Patent Pending

**New!**  
Flame-Guard Protection  
Patent Pending

Drop down dust barrel on castors

- IWF Challenger Award Finalist  
Innovative Wood Processing Technology 2011

- INNOV8 2011 Award  
Wood Magazine, Dec/Jan. 2010/2011

[www.oneida-air.com](http://www.oneida-air.com)  
has all of our portable dust collectors

Patented Technology  
Patent # US 7,824,457 B2  
Patent # US 7,550,021 B2

Top Award Winner in All Independent Tests Since 1993.



Made in the USA  
"Built to last a lifetime"

Call Today for **FREE** Catalog!  
**1.800.732.4065**  
[www.oneida-air.com](http://www.oneida-air.com)



## Ask WOOD

### Let's make a (tablesaw) deal

**Q:** I found a used, brand-name tablesaw for less than half the cost of new. What should I look for to make sure I'm not getting a lemon?

—Brad Bowers, Reno, Nev.

**A:** The price sounds right, Brad, and because it's a well-established brand, getting service and parts should prove easy.

Now do your research. Google the model number to learn about any problems other users have identified.

Many machine manufacturers archive product manuals on their Web sites. Download and print the manual and refer to it when you inspect the saw. As you make your external inspection, talk to the owner about the saw's history. Is he the first owner or did he purchase it from a high school shop? Is he a woodworker who barely had time for his hobby? This will give you an idea about the saw's "mileage."

Look out for signs of neglect or abuse. A little surface rust can be removed, but a deeply pitted table may need to be replaced or re-ground, nullifying your savings. Are there cracks or dents in the cabinet? A jolt hard enough to damage a tablesaw's casing may have damaged internal components. Don't be too shy to ask about mishaps.

Check for missing parts, such as the miter gauge, blade guard, dado insert, and blade wrenches. Mentally add up the replacement cost of any missing parts and add it to the cost of the saw. Does it still seem like a good deal? Or perhaps you've gained some negotiation room.

Now let's open 'er up. Unplug the saw and take off the blade. Rotate the arbor, then gently wiggle it up and down. If you feel any play or hear any clicking sounds it could indicate worn bearings that need replacing. Brush off the height- and bevel-adjustment gears, and check for cracked or missing teeth. Raise and lower the blade completely and tilt the bevel through its full range to ensure smooth movement.

With the blade still off, plug in the saw and fire it up. If you feel or hear any vibration, remove the belts and power up the saw again to see if the vibration continues. If so, it could be a problem with the motor or bearings. Figure in repair or replacement costs.

Finally, ask the seller if you can cut some wood with the saw to see how it handles under load. Install your own sharp blade and make multiple cuts in hardwood scrap. Does the saw bog down easily or stop completely? Feel the motor afterward. Is it hot to the touch? If so, figure in the cost of a new motor.

If, after all of this, you've decided that the tablesaw is indeed a good deal, there's one last thing to consider. Who can you bribe to help load it?



Wiggle the arbor shaft to check for any looseness. Any play could translate into a wobbly blade and poor cut quality.



## Rule of thumb guides best workbench height

**Q:** I'm ready to design and build a workbench for my shop. How tall should I make the bench for comfortable woodworking?

—Samuel Johnson, Mesa, Ariz.

**A:** Workbench height depends largely on how your bench will be used, Samuel. The standard height of 34" matches most tablesaw heights, allowing the workbench to double as an outfeed support.

Many hand-tool woodworkers, though, prefer a bench 1 or 2 inches lower allowing more leverage for hand-plane and chisel use. If you're mainly a power-tool woodworker, adding a couple of inches may make power-sanding and assembly operations more comfortable.

To dial in a height to match your stature, use the "rule of thumb": Make your workbench height the distance from the floor to your first thumb knuckle, with your arms hanging relaxed at your sides.

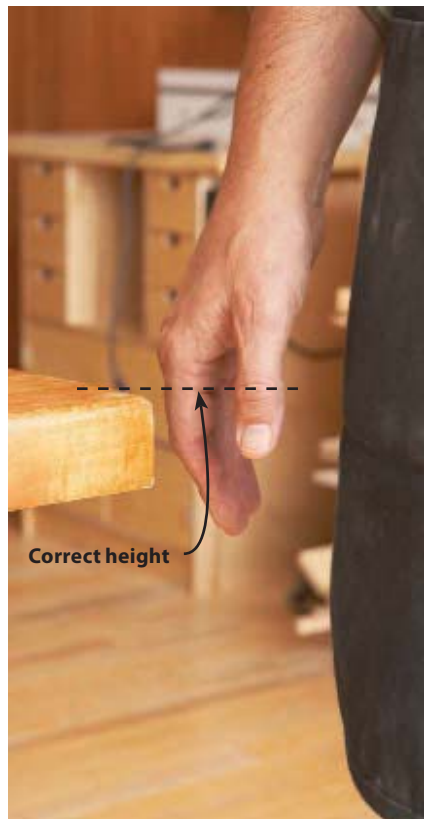

A workbench sized to meet your hand at your thumb's knuckle provides a comfortable working height for a mix of power- and hand-tool woodworking.

*continued on page 80*

## Your New Panel Sawing Solution!

**Limited Time Offer! \$899**  
Includes Free Lower Extensions

- One Person Sawing
- Over 8ft. Of Panel Support
- Requires Little Floor Space
- Portable To The Job Site
- Very Safe To Use
- Quick & Easy Set-Up
- Optional: Upper Extension Brackets, Dust Kit & Quick Stop Angle

Vertical Panel Saw

[www.panelpro.com](http://www.panelpro.com) • 800-599-1655

*Warm to the comfort of radiant heat*

# RADIANT

**Floor Company**

*Efficient, Quiet, Reliable*

*It's never been easier to do it yourself*

*compatible with any fuel source:*  
GAS, PROPANE  
SOLAR, OIL, WOOD  
ELECTRIC,  
GEOTHERMAL

**VISIT OUR WEBSITE**  
**CALL FOR A FREE QUOTE**  
[www.radiantcompany.com](http://www.radiantcompany.com)  
Barton, Vermont  
(toll free) 1.866.WARM-TOES (927.6863)

# CMT ORANGE TOOLS®

## New Box & Finger Joint Set



Order No. 230.224.08

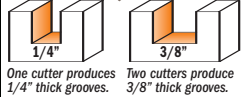

The best solution on the market for making box and finger joints easily and quickly. This set, shipped in a sturdy reusable carrying case, contains two identical blades featuring 8" diameter, 24 teeth and 5/8" bore, offering the distinctive advantage to produce 1/4" grooves by using only a single blade, but also to extend the groove to 3/8" thickness by laying the two blades upon each other, with no setting and shims needed. PATENT PENDING

CMT USA, Inc.

Toll-free 888.268.2487

info@cmtusa.com www.cmtusa.com

TM: CMT, the CMT logo and the orange color applied to tool surfaces are trademarks of C.M.T. UTENSILI S.P.A. © C.M.T. UTENSILI S.P.A.

## Ask WOOD

### A guide to getting grain textures in SketchUp

**Q:** I downloaded the wood grain textures for SketchUp from your Web site ([woodmagazine.com/woodgrain](http://woodmagazine.com/woodgrain)). Can you tell me how to get those into SketchUp and then onto my project design?

—Donald Baker, Wayne, N.J.

**A:** Sure, Donald. You're just a few mouse clicks away:

In SketchUp, choose Windows, then Materials to display the Materials list panel. To add the texture to the Wood list, select Wood from the top drop-down menu. Then, in the Color drop-down menu, choose New Texture, as shown *below top*. Navigate to the textures that you downloaded from our site and choose a wood image. In the dialog box that appears, type in a name for your texture and give it a scale size. (Ours are about 6x6"). Then click OK.

Now, when you choose the paint-bucket tool, your texture will be waiting for you in the materials list. Simply select the grain and click on the project part you'd like to texture, as shown *bottom*.

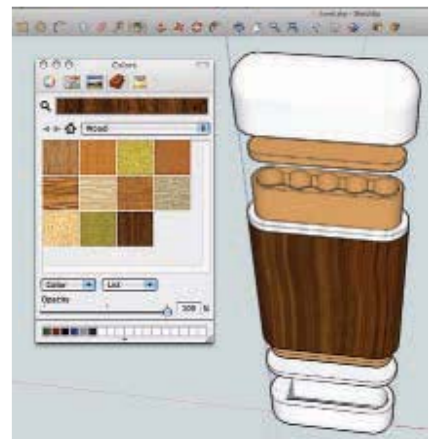
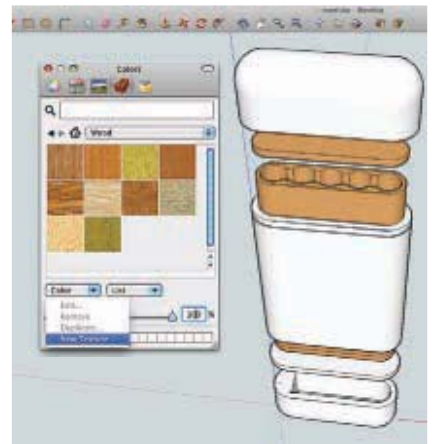

## READ, LEARN, BUILD!



Chock full of simple shop solutions and projects to practice them on.

\$6.99 U.S. \$8.99 Canada

On Newsstands NOW!

Order online at [woodmagazine.com/publications](http://woodmagazine.com/publications) or call toll free 888-636-4478

AD#WD0311

# WOODCRAFT®

For A Free Catalog Or To Find Your Local Woodcraft Store, Visit [woodcraft.com](http://woodcraft.com) Or Call 800-225-1153.

## Woodpeckers® SideWinder Router Lift

Woodpeckers SideWinder Router Lift combines instant elevation change with remotely operated, micro-adjustments to dramatically reduce the time it takes to change a router bit while providing a tool-free method of bit height adjustment. With a simple twist of the spring-assisted lift wrench, the router motor is free to be moved to any vertical location without requiring any other action. Fine, precise bit height changes are equally as effortless by "cranking" the handle located where you want it most.

- Remote Actuated Crank Precisely Adjusts Bit Height Through Tough Steel Flex Shaft
- Accurately Machined Carriage, With Integral Motor Clamping Mechanism Fits Industry Standard PC 7518 (Model 420) Or 3/2" Motors (Model 350)
- CNC Milled To Exact Tolerances For Perfect Fit In Router Tables With A 9 1/4" x 11 3/4" Opening
- Large 1.025" Ground & Polished Steel Posts And Precision Machined Guide Bearings
- 3 9/16" Bit Opening Accepts Molded Insert Rings; Includes 2 5/8", 1" And 1 3/16" Guide Bushing Openings
- Includes Spring-Assisted Lift Wrench, Threaded Starting Pin, Spanner Wrench & Detailed Instructions



151242 Model 420

151241 Model 350 also available.

10W110R

QUALITY WOODWORKING TOOLS • SUPPLIES • ADVICE®

# HARBOR FREIGHT TOOLS

Quality Tools at Ridiculously Low Prices

**SALE STARTS TODAY!**

## FACTORY DIRECT TO YOU!

How does Harbor Freight Tools sell high quality tools at such ridiculously low prices? We buy direct from the factories who also supply the major brands and sell direct to you. It's just that simple! Come see for yourself at one of our 330 STORES NATIONWIDE and use this 20% OFF Coupon on any of our 7,000 products\*. We stock Automotive products, Shop Equipment, Hand Tools, Tarps, Compressors, Air & Power Tools, Material Handling, Woodworking Tools, Welders, Tool Boxes, Outdoor Equipment, Generators, and much more.

**NOBODY BEATS OUR QUALITY, SERVICE AND PRICE!**

- ✓ Over 4.5 MILLION NEW CUSTOMERS in the Last 18 Months!
- ✓ NO HASSLE RETURN POLICY
- ✓ Family Owned & Operated
- ✓ We Will Beat Any Competitor's Price Within 1 Year of Purchase!

**LIFETIME WARRANTY**  
ON ALL HAND TOOLS!

**SUPER COUPON!** **20% OFF** ANY SINGLE ITEM!

**HARBOR FREIGHT TOOLS - LIMIT 1** Use this coupon to save 20% on any one single item purchased when you shop at a Harbor Freight Tools store. \*Cannot be used with any other discount or coupon. Coupon not valid on any of the following: prior purchases, gift cards, Inside Track Club membership, extended service plans, Compressors, Generators, Tool Cabinets, Welders, Floor Jacks, Campbell Hausfeld products, open box items, Parking Lot Sale items, Blowout Sale items, Day After Thanksgiving Sale items, Tent Sale items, 800 number orders, or online orders. Coupon cannot be bought, sold, or transferred. Original coupon must be presented in-store in order to receive the offer. Valid through 5/19/11. Limit one coupon per customer and one coupon per day.



**SUPER COUPON!**

**CENTRAL MACHINERY**  
**12" x 33-3/8" WOOD LATHE WITH REVERSIBLE HEAD**  
LOT NO. 34706

**SAVE \$100**

**\$199.99**

REG. PRICE \$299.99

**HARBOR FREIGHT TOOLS - LIMIT 1** This valuable coupon is good anywhere you shop Harbor Freight Tools (retail stores, online, or 800 number). Cannot be used with any other discount or coupon. Coupon not valid on prior purchases. Coupon cannot be bought, sold, or transferred. Original coupon must be presented in-store, or with your order form, or entered online in order to receive the coupon discount. Valid through 5/19/11. Limit one coupon per customer and one coupon per day.

53852182

**SUPER COUPON!**

**CENTRAL MACHINERY**  
**2 HP INDUSTRIAL 5 MICRON DUST COLLECTOR**  
LOT NO. 97869

**REG. PRICE \$249.99**

**SAVE \$110**

**\$139.99**

**HARBOR FREIGHT TOOLS - LIMIT 1** This valuable coupon is good anywhere you shop Harbor Freight Tools (retail stores, online, or 800 number). Cannot be used with any other discount or coupon. Coupon not valid on prior purchases. Coupon cannot be bought, sold, or transferred. Original coupon must be presented in-store, or with your order form, or entered online in order to receive the coupon discount. Valid through 5/19/11. Limit one coupon per customer and one coupon per day.

59420588

**SUPER COUPON!**

**CHICAGO Electric Power Tools**  
**OSCILLATING MULTIFUNCTION POWER TOOL**  
LOT NO. 67256

**REG. PRICE \$59.99**

**SAVE 50%**

**\$29.99**

**17 DIFFERENT ATTACHMENTS AVAILABLE IN OUR STORES!**

**HARBOR FREIGHT TOOLS - LIMIT 1** This valuable coupon is good anywhere you shop Harbor Freight Tools (retail stores, online, or 800 number). Cannot be used with any other discount or coupon. Coupon not valid on prior purchases. Coupon cannot be bought, sold, or transferred. Original coupon must be presented in-store, or with your order form, or entered online in order to receive the coupon discount. Valid through 5/19/11. Limit one coupon per customer and one coupon per day.

34943167

**SUPER COUPON!**

**CHICAGO Electric Power Tools**  
**3 GALLON 100 PSI OILLESS PANCAKE AIR COMPRESSOR**  
LOT NO. 95275

**SAVE 46%**

**\$39.99**

REG. PRICE \$74.99

**HARBOR FREIGHT TOOLS - LIMIT 1** This valuable coupon is good anywhere you shop Harbor Freight Tools (retail stores, online, or 800 number). Cannot be used with any other discount or coupon. Coupon not valid on prior purchases. Coupon cannot be bought, sold, or transferred. Original coupon must be presented in-store, or with your order form, or entered online in order to receive the coupon discount. Valid through 5/19/11. Limit one coupon per customer and one coupon per day.

26878330

**SUPER COUPON!**

**CENTRAL MACHINERY**  
**4" x 36" BELT/6" DISC SANDER**  
LOT NO. 93981/97181

**SAVE \$50**

**\$49.99**

REG. PRICE \$99.99

**HARBOR FREIGHT TOOLS - LIMIT 1** This valuable coupon is good anywhere you shop Harbor Freight Tools (retail stores, online, or 800 number). Cannot be used with any other discount or coupon. Coupon not valid on prior purchases. Coupon cannot be bought, sold, or transferred. Original coupon must be presented in-store, or with your order form, or entered online in order to receive the coupon discount. Valid through 5/19/11. Limit one coupon per customer and one coupon per day.

96394085

**SUPER COUPON!**

**WINDSOR DESIGN**  
**60" HARDWOOD WORKBENCH**  
LOT NO. 93454

**SAVE \$70**

**\$129.99**

REG. PRICE \$199.99

**HARBOR FREIGHT TOOLS - LIMIT 1** This valuable coupon is good anywhere you shop Harbor Freight Tools (retail stores, online, or 800 number). Cannot be used with any other discount or coupon. Coupon not valid on prior purchases. Coupon cannot be bought, sold, or transferred. Original coupon must be presented in-store, or with your order form, or entered online in order to receive the coupon discount. Valid through 5/19/11. Limit one coupon per customer and one coupon per day.

41148552

**SUPER COUPON!**

**CENTRAL PNEUMATIC**  
**18 GAUGE COMBINATION NAILER/STAPLER KIT**  
LOT NO. 97525

**SAVE 57%**

**\$14.99**

REG. PRICE \$34.99

**HARBOR FREIGHT TOOLS - LIMIT 1** This valuable coupon is good anywhere you shop Harbor Freight Tools (retail stores, online, or 800 number). Cannot be used with any other discount or coupon. Coupon not valid on prior purchases. Coupon cannot be bought, sold, or transferred. Original coupon must be presented in-store, or with your order form, or entered online in order to receive the coupon discount. Valid through 5/19/11. Limit one coupon per customer and one coupon per day.

47230263

**3 EASY WAYS TO SHOP!**

- 1. VISIT!** 330 Stores Nationwide
- 2. GO TO!** [www.HarborFreight.com](http://www.HarborFreight.com)
- 3. CALL!** 1-800-423-2567

# Shop-Proven Products

These woodworking wares passed our shop trials

## Compact cyclone proves ideal for basements

I've always wanted a cyclone dust collector for my low-ceiling basement shop, but most models simply stand too tall. Grizzly's G0703 portable cyclone measures only 65½" tall—fitting easily in my shop—and rolls around smoothly on casters. But that doesn't make the G0703 a lightweight. It's made of beefy 18-gauge steel with a 1½-hp, 110-volt motor; a respectable 695 cfm of air flow through 5" duct; and a fine-filtering, 2-micron, pleated canister that trapped all dust. I measured the noise level from 3' away and found it produced 85 decibels, loud enough to wear hearing protection. But in the ground-floor room directly above, that measurement dropped to a hardly noticeable 60dB.

I hooked up this collector to all of my stationary machines with 13' of 5" flex-hose—using the included reducer to step down the G0703's 6" inlet and another to fit the machines' 4" ports—and it cleared the dust and chips from each tool with ease.

—Tested by Jan Svec,  
a former WOOD® magazine project  
designer, builder, and editor



**Portable cyclone dust collector, #G0703**

Performance	★★★★★
Price	\$850
Grizzly Industrial 800-523-4777; grizzly.com	

## Finally, carbide knives for benchtop planers

We all know carbide tips on saw blades and router bits outlast steel edges, but until recently you couldn't get carbide knives for your benchtop planer. Infinity Cutting Tools' carbide-edged knives delivered about 10 times the life of new carbon-steel knife edges on my DeWalt DW735 planer. Analyzing motor-ampage draw and observed cut quality, I judged the steel knives dull after planing 48' of particle-board (chosen for its accelerated abrasive dulling effect) in each of two tests. The Infinity carbide knives planed 492' and 528', respectively, before dulling.

A set of three single-edge Infinity

knives sells for \$250. Five sets of double-edge disposable knives (\$50 per set) would yield the same edge life, making the effective cost a wash. But you'll save yourself the hassle of nine knife changes. (Resharpening the Infinity knives isn't practical because they reference off cutterhead pins, and so their height cannot be adjusted.)

At the time of testing, Infinity had carbide-tipped knives only for DeWalt's DW735, but had plans to make them for other models.

—Tested by Bob Hunter,  
Tools & Techniques Editor



**Carbide-edged planer knives, #CPJK-041**

Performance	★★★★★
Price	\$250
Infinity Cutting Tools 877-872-2487; infinitytools.com	

## About our product tests

We test hundreds of tools and accessories, but only those that earn at least three stars for performance make the final cut and appear in this section. Prices are current at the time of article production and do not include shipping, where applicable.

## Bosch gets a good start with pneumatic nailers

Known more for making power tools, Bosch recently jumped into the pneumatic-nailer business, and the three nailers I tested—finish, brad, and narrow-crown stapler—proved nimble and drove fasteners well. All three feature bodies smaller than comparable nailers I've used, making them lighter (by a half-pound) without sacrificing power. They all switch from single shot to sequential fire with the flip of a switch. Each has dry-fire lockout when it's out of fasteners (to prevent damage to the drive pin), tool-free depth adjustment, a narrow nose with removeable no-mar tip (that stores on the tool when not in use), and front-hinged access gate to clear jammed nails.

Although they performed like champs, I had minor problems loading fasteners. The finish nailer's rear-loading magazine proved awkward to use, and the stapler's top-loading magazine seemed flimsy and not on par with the rest of the tool. The brad nailer's side-load magazine was the easiest to use among the trio.

Bosch does not make fasteners, but I used nails and staples from four other companies with no glitches.

—Tested by Dave Fish,  
pro trim carpenter and cabinetmaker



**Bosch pneumatic nailers**

Performance	★★★★☆
Price	16-gauge finish nailer, #FNS250-16 \$170
	18-gauge stapler, #STN150-18 \$120
	18-gauge brad nailer, #BNS200-18 \$120
Bosch 877-267-2499; boschtools.com	

continued on page 85



# SPECIAL MARKET OPPORTUNITY



Your Expert Guide to the World's Finest Coins

Nicholas J. Bruyer, CEO, First Federal Coin Corp.  
ANA Life Member Since 1974

## How can two \$5 Gold Eagles have a 600% difference in value?

If you're not interested in the answer, give this to your best friend.

Almost everyday, very successful, very sophisticated business people tell us they're interested in buying gold. The problem is, they don't have the first notion of where to begin.

Our response is always the same: there's bullion gold, and then there's collectible gold. We're not talking about bullion gold. We're talking about a special kind of gold that collectors climb all over themselves to get their hands on.

### Use our Collector's Checklist when you go shopping for gold.

First on our list: *collectors look for a coin that's in demand.* And there are few gold coins that collectors want more than the American Gold Eagle. It was created during Ronald Reagan's administration.

In real estate, value is driven by location, location, location. In coins, it's quality.

For collectors, the higher a coin's grade, the higher the coin's value. That's number #2 on our checklist. One of those \$5 Gold Eagles is the highest collectible grade possible: the absolutely flawless grade of MS70 (MS stands for "Mint State"). It's referred to as the "perfect" coin.

Consider this: In its bullion grade, a 2001 \$5 Gold Eagle is valued at \$150—but a perfect grade MS70 is valued at \$950—a **staggering 600% difference!**

Of course you have to understand that the population of this MS70 coin is small, but it's an example of a coin in its finest Mint State grade.

**No. 3 on our checklist: Collectors covet First Strikes.** If a \$5 Gold American Eagle in MS70 is sizzling hot, what happens when it achieves the exalted status called First Strike™?

This is the pinnacle of a coin's state of quality. It just doesn't get any higher. Bottom line: collectors often pay more for them.

You want to buy collectible gold, but not just any collectible gold.

You've paid close attention to our collector's checklist: Is it in demand? Has it earned the highest grade possible? Is it a First Strike?

Our recommendation:

A 2010 \$5 Gold American Eagle MS70 First Strike.

You'd expect to pay a premium for such a unique combination of quality factors.

But we have a special opportunity for you:

\$279 each for up to 4 coins  
\$265 each for 5 to 9 coins  
The best deal—\$249 each for 10 coins or more!!

Hurry! This is a first come, first served offer! Call 1-888-201-7047 to find out how you can qualify for free shipping. Mention offer code: PGE178-02

**Call First Federal Toll-FREE today 1-888-201-7047 to Reserve Your 2010 \$5 Eagle MS70 First Strike!**

Offer Code PGE178-02  
Please mention this code when you call.



*Past performance is not an indicator of future performance. Prices subject to change without notice.*

*Note: First Federal Coin Corp. is a private distributor of government and private coin and medallic issues and is not affiliated with the United States government. Facts and figures were deemed accurate as of August 2010.*



American Numismatic Association  
Nicholas Bruyer  
Life Member 4489

**1-888-201-7047**  
[www.1stfederalcoin.com/10eagle65](http://www.1stfederalcoin.com/10eagle65)





# They're not just pennies.

## Get four unique Lincoln Commemorative Cent rolls for as little as \$3.99 a roll!

In 2009, the U.S. Mint released four special cents to honor the 200th Anniversary of President Lincoln's birth.

They celebrate his birthplace, formative years, professional life and presidency.

People stood in the rain *for hours* to get 50-coin rolls. The rolls disappeared quickly, proving that sometimes a penny is not just a penny.

Many Americans were left empty-handed.

Until now.

## Wells Fargo emptied its vaults

We bought every Lincoln Cent roll they had. And you save big—  
**50% off what others sell them for.**



## Order now. Risk-free!

You get the complete set of four 50-coin rolls, one each of the four different designs. **That's 200 coins!** Each one is mint red Brilliant Uncirculated—what collectors want.

Best of all, your order is risk-free with our 30-day unconditional return privilege. Don't wait! Call toll-free now to get your Lincoln Commemoratives!

## Buy more and you save more!

One 4-roll Lincoln Commemorative Set \$20\*  
Five Sets (1,000 coins) for only \$17.40 a Set\* **Save \$13**  
12 Sets (2,400 coins) for only \$15.96 a Set\* **Save \$48.48**  
*\*Plus Shipping and handling*

Toll-Free 24 hours a day  
**1-888-870-7338**

**Offer Code LPS153**  
*Please mention this code when you call.*

 **GovMint.com**  
YOUR ONE BEST SOURCE FOR COINS WORLDWIDE

14101 Southcross Drive W., Dept. LPS153  
Burnsville, Minnesota 55337

[www.GovMint.com](http://www.GovMint.com)

## Shop-Proven Products

### Switch to a tool-triggered shop-vacuum assist

Although it's not the first accessory switch for joining a shop vacuum to a tool for one-touch activation, the iVac Switch Box goes beyond its competitors to power up to three devices simultaneously. I love it for use with my shop vacuum and my sander or router. And when I want to switch over to my router table—with a 15-amp router mounted in it—I simply plug the iVac's two power cords into separate outlets (on separate circuits), and still get the same one-switch activation for both. I tested it with every tool in my shop, adding extension cords and power strips, and did not trip a 20-amp breaker until I tried 10 tools and the vacuum simultaneously. Very cool!



—Tested by Doug Hicks, a former shop teacher and woodworking magazine editor



#### iVac Switch Box

Performance	★★★★★
Price	\$45
M Bright Tools 613-826-2200; ivacswitch.com	

### Separator slows vac filter clogging

I used the latest version of Oneida's Dust Deputy extensively over several months as I framed, drywalled, and trimmed my basement, and it saved me from many shop-vacuum filter cleanings. The Dust Deputy is a mini-cyclonic separator that traps about 95 percent of all debris in its plastic bucket before it reaches the attached vac. It reduced my filter cleaning by about 80 percent.



I experienced two minor hassles. First, the dust port on top of the separator was too small for my vacuum's hose, so I had to rig it together with tape. When screwed to the side of my vacuum, the Dust Deputy proves awkward to move around and tippy as it begins to fill up. If I had it to do over again, I'd mount the Dust Deputy and my vacuum to a plywood base, and then install the casters for a more stable unit that rolls easily. 🌲

—Tested by Bill Krier, Editor-in-Chief



#### Dust Deputy

Performance	★★★★☆
Price	\$99
Oneida Air Systems 800-732-4065; oneida-air.com	

# AGE™ SERIES

## GET THE ULTIMATE FINISH

No need for sanding!

**100% GERMAN MADE**

**#MD10-800R**

Industrial Quality  
ATB Grind  
Low Noise Elements  
Laser Cut  
Micrograin Carbide  
Non-Stick Coating  
For Soft & Hardwoods

*THE FINITO BLADE  
ELIMINATES THE  
SANDING PROCESS*

SPECIAL PRICE

## \$71.62

LIST PRICE ~~\$95.00~~

Visit Our Website  
[www.agecuttingtools.com/armormax](http://www.agecuttingtools.com/armormax)

For A Dealer Nearest You  
Call 1-800-445-0077

**ARMOR MAX**  
NON-STICK COATING

**NEW**

**by Amana Tool®**

# SAND CREEK Post & Beam

## Traditional Wood Barns

...and so much more.

Call Today

## 888-489-1680

[sandcreekpostandbeam.com](http://sandcreekpostandbeam.com)

# KLOCKIT®

Leading Supplier To WoodWorkers For 39 Years!

**FREE  
Catalog!**

Call Today or  
Visit  
[www.klockit.com](http://www.klockit.com)

Klockit Offers The Largest  
Selection Of Clock:  
Movements • Dials • Hands  
• Kits • Plans • Hardware &  
Much More!

**Act Now!**  
Receive 10% OFF  
your Order!  
Mention Offer: 7A438  
Expires: Mar. 31, 2011

**1-800-556-2548**

Follow Klockit on:  

Dept: WD211



**EAGLE**  
AMERICA  
The World's Router Bit & Woodworking Source!

**OVER  
2,000  
Router Bits!**  
**OVER  
6,000  
Woodworking  
Items!**



**FREE Shipping** On your order of \$75. Use offer code WD1102. Prior orders excluded. Ends 3/31/2011.

1-800-872-2511 • [www.EagleAmerica.com/WD1102](http://www.EagleAmerica.com/WD1102)

# Forrest Sharpening

Helps Prevent Bad Cuts Like These

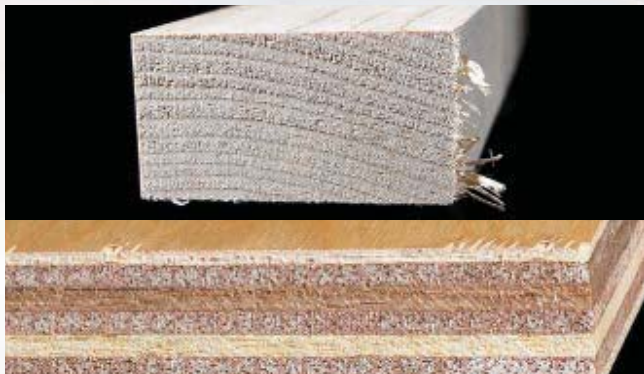

Abrasion, pitch buildup, micro chipping and poor sharpening jeopardize the life and performance of even the finest carbide-tipped blades and dado sets. Our *expert factory sharpening* will help protect your investment. We handle *all types and makes of blades*. Typical turnaround is just 4 to 5 days.

We've been the leader for over 60 years, so contact us today.

**FORREST**

The First Choice of Serious  
Woodworkers Since 1946

[www.ForrestBlades.com](http://www.ForrestBlades.com)  
1-800-733-7111

(In NJ, call 973-473-5236)

© 2010 Forrest Manufacturing Code WM

# Refinish Your Future.



Own your own business.

Let your passion for furniture lead you into a new business with a Furniture Medic franchise. We're a complete on-site repair and restoration-refinishing business servicing homes and companies as well as handling moving and insurance claims. We offer extensive training and support with a low initial investment and manageable overhead. Financing is available to qualified candidates and franchises are offered nationwide. Call today to brush up on the details.

 **FURNITURE MEDIC**  
the prescription for damaged furniture™

[www.furnituremedicfranchise.com](http://www.furnituremedicfranchise.com) 1-800-RUN YOURS



## FREE Product Information from Advertisers in This Issue

Looking for FREE product information? Fill out the coupon in this section to receive FREE product info and catalogs. Or, for quicker service and instant access to information, visit us online at [www.woodworkerscenter.com](http://www.woodworkerscenter.com)

### Adhesives & Finishes

**TITEBOND® III ULTIMATE WOOD GLUE** Superior bond strength, waterproof, longer open-assembly time. The Best Wood Glue Ever! **Circle No. 24.**

**GORILLA WOOD GLUE** High strength, shorter clamp time, and no dyes for a natural finish. Try it today on your next building project. **Circle No. 50.**

**UNITED GILSONITE LABORATORIES** Finishing Touch Brochure — guide for best results using ZAR Wood Stain/Finishes. **Circle No. 128.**

### Bits, Blades, Cutting Tools

**AMANA TOOL** Amana Tool is recognized worldwide as leader in cutting tools for professional woodworkers and hobbyists alike. **Circle No. 170.**

**CMT ORANGE TOOLS** Top quality industrial saw blades and router bits at affordable pricing. **Circle No. 180.**

**EAGLE AMERICA** Largest selection of professional quality, American-made router bits + 100's of unique accessories. **Circle No. 193.**

**FORREST MFG. CO., INC.** Top quality blades and dados for an ultra smooth finish. **Circle No. 206.**

**FREUD SAW BLADES** This 48-page catalog illustrates the features and benefits for all Freud saw blades. **Circle No. 219.**

**FREUD ROUTER BITS** All Freud router bits are represented in this 84-page catalog, including more than 130 new bits and sets. **Circle No. 232.**

**MLCS WOODWORKING** Best quality, huge selection, low prices, superior service. Free Shipping! **Circle No. 245.**

**SAWSTOP** SawStop table saws stop the blade upon contact with skin. **Circle No. 280.**

### Books, Plans and Videos

**AMERICAN FURNITURE DESIGN CO.** 150 of America's best furniture plans, comprehensive instruction guide. Catalog. **Circle No. 336.**

**MEISEL HARDWARE SPECIALTIES CATALOG** 2,000+ full-size project plans and hard-to-find hardware. **Circle No. 401.**

**WOOD MAGAZINE WOODWORKING PLANS** 1,200+ top-quality furniture, shop, and yard-figure plans from the editors of WOOD® magazine. Catalog. **Circle No. 459.**

### General Woodworking Catalogs

**ARMOR CRAFTS** Full-size plans to build cradles, rocking horses, clocks and more. Also hardware and wood craft supplies. **Circle No. 556.**

**THE BEALL TOOL COMPANY** Inventive solutions for shop problems: wood threading, buffing & more. **Circle No. 558.**

**GRIZZLY INDUSTRIAL, INC.** 12,000 woodworking and metalworking machines, tools and accessories — unbeatable prices! **Circle No. 583.**

**ROCKLER WOODWORKING & HARDWARE** Our premium tools make woodworking efficient and enjoyable. FREE Catalog. **Circle No. 661.**

**WOODCRAFT SUPPLY CORP.** Over 15,000 top quality woodworking tools, supplies, and accessories. **Circle No. 700.**

**WOODWORKERS HARDWARE** Over 8,000 items stocked. Largest selection of cabinetmakers hardware. Lowest prices. **Circle No. 713.**

### Hand Tools, Jigs & Clamps

**KREG TOOL CO.** Your one stop shop for everything Pocket-Screw related. **Circle No. 802.**

### Hardwood & Lumber

**STEVE H. WALL LUMBER CO.** Quality hardwoods, plywood, exotic lumber. Ship UPS/motor freight, wholesale prices. **Circle No. 856.**

**WOODWORKERS SOURCE** Hardwoods from around the world. **Circle No. 869.**

### Income Opportunities & Education

**FURNITURE MEDIC** Offering franchise licenses to qualified individuals to perform mobile, on-site furniture repair & restoration services. **Circle No. 895.**

**MARC ADAMS SCHOOL OF WOODWORKING** Over 125 summer hands-on workshops with the best instructors of modern time. **Circle No. 916.**

### Kits

**BUILD YOUR OWN MURPHY BED** Create-A-Bed® murphy bed mechanism includes complete illustrated instructions and DVD. **Circle No. 951.**

**DETAILED PLAY SYSTEMS** Wooden swingsets and playground equipment for the backyard. Free catalog. **Circle No. 958.**

**KLOCKIT** The leading supplier of clock-making supplies for over 35 years! **Circle No. 973.**

**SAND CREEK POST & BEAM** Rustic barn kits; full-dimension, rough-cut posts, beams, millwork and accessories. **Circle No. 1001.**

**WOODEN-GEAR-CLOCKS.COM** Create a wooden gear clock—kits and plans available. **Circle No. 1008.**

### Lawn & Garden

**ZOYSIA FARMS NURSERIES** Amazon Zoysia grass saves you time, work and money. **Circle No. 1017.**

### Miscellaneous

**AZTEC STEEL CORP.** Quality pre-engineered arch-style steel buildings at the lowest cost anywhere. **Circle No. 1064.**

**ENTAB INDUSTRIES, LLC** Cut crown molding easily with our Crown Master Mitre Box. **Circle No. 1161.**

**O'KEEFFE'S WORKING HANDS, RELIEF FOR HANDS THAT CRACK AND SPLIT** Never greasy or oily and free of scents. **Circle No. 1290.**

**RADIANT FLOOR COMPANY** Radiant Heating Systems—design, manufacture and sale for the DIY. **Circle No. 1301.**

### Power Tools

**COOK'S SAW MFG., L.L.C.** Portable sawmills, Edgers, Sharpeners, Band Blades... Free catalog. Video available. **Circle No. 1480.**

**EPILOG** Wood engraving and cutting systems — Low Price, High-Quality Laser Systems. **Circle No. 1515.**

**PLASMA CAM, INC.** Put metal into your wood projects! Free Demo Video! **Circle No. 1641.**

**RADARCARVE** Manufacturer of specialized wood carving duplicators. **Circle No. 1673.**

**PANEL PRO VERTICAL PANEL SAW** Economical panel saw makes handling and cutting wood/plastic sheets easy. **Circle No. 1708.**

**SKIL POWER TOOLS** SKIL Power Tools is a leader in portable electric power tools and accessories. **Circle No. 1740.**

**WOOD-MIZER PRODUCTS** Eight Portable Sawmills Available starting with the LT10 at \$3995. **Circle No. 1805.**

**WOODMASTER TOOLS** Multi-duty planers that mold, sand & saw. **Circle No. 1820.**

**WOODSTOCK INTERNATIONAL, INC.** SHOP FOX Woodworking Machines offering professional-level quality. Dealer supplied. **Circle No. 1824.**

### Project Parts & Materials

**OSBORNE WOOD PRODUCTS, INC.** A free catalog of table legs, corbels, and island legs. **Circle No. 1849.**

### Shop Accessories

**AMERICAN FABRIC FILTER CO., INC.** Manufacturers of custom-made filter bags for the wood industry. **Circle No. 1868.**

**THE JDS COMPANY** Specializing in the finest air filtration and dust collection equipment. **Circle No. 1974.**

**LIGNOMAT USA, LTD.** Affordable, reliable, pin and pinless moisture meters for wood. Free catalog. **Circle No. 2013.**

**ONEIDA AIR SYSTEMS, INC.** Free informative catalog contains dust collection systems and complete ductwork. **Circle No. 2039.**

**PENN STATE INDUSTRIES** Award-winning dust collection. Collectors, Cyclones, Ductwork and more. **Circle No. 2045.**

### Woodturning Supplies

**HUT PRODUCTS** Woods, acrylics and supplies for pen and game call turning. **Circle No. 2133.**

**NOVA. SMART TOOLS, POWERFUL SOLUTIONS** NOVA lathes, chucks and accessories consistently lead the way in innovative design with their unique mix of powerful features and great value. **Circle No. 2134.**

**PACKARD WOODWORKS** Free Catalog for WOODTURNERS! — Quality Lathes, Tools and Supplies. **Circle No. 2143.**

**PENN STATE INDUSTRIES** Leading supplier of Turning Products. Pen kits, project, finishes and more. **Circle No. 2151.**

## FREE Product Information

DEPT. WOFM11

CIRCLE THE NUMBERS BELOW CORRESPONDING TO ITEMS IN THIS ISSUE.

24	219	558	895	1064	1708	2013
50	232	583	916	1161	1740	2039
128	245	661	951	1290	1805	2045
170	280	700	958	1301	1820	2133
180	336	713	973	1480	1824	2134
193	401	802	1001	1515	1849	2143
205	459	856	1008	1641	1868	2151
206	556	869	1017	1673	1974	4000

Discover how rewarding woodworking can be! Get one full year of WOOD® for just \$28.00 (7 issues). Simply circle No. 4000. You will be billed later.

NAME \_\_\_\_\_

ADDRESS \_\_\_\_\_

CITY \_\_\_\_\_ STATE \_\_\_\_\_ ZIP \_\_\_\_\_

E-MAIL ADDRESS \_\_\_\_\_

PHONE (OPTIONAL) \_\_\_\_\_

TO ENSURE PROMPT HANDLING OF YOUR ORDER, PLEASE:

- Circle Your Choice(s) in the box above
- Send card to WOOD® Magazine, Dept. WOFM11, P.O. Box 5135, Buffalo, NY 14205-5135
- Allow 4-6 weeks for delivery
- This card expires July 18, 2011

# Put the world's best woodworkers in your pocket

What if you could have the world's best woodworkers teaching you in your shop?

**Now you can!**



Paul Schurch



Marc Adams



Judy Gale Roberts



Mike Mahoney

Learn joinery from **Marc Adams**... Tablesaw tips and tricks from **Gary Rogowski**...  
 Veneering and marquetry from **Paul Schurch**... Woodworking secrets from  
**Jim Heavey**... Turning from **Mike Mahoney**... Intarsia from **Judy Gale Roberts**...  
 Super-simple finishing from the **Wood Whisperer**...



**WOOD** Magazine's Video Library

Shop for dozens of downloadable videos from top woodworkers. View them any time on your computer, or take them with you on your iPod or other portable media player.

[woodmagazine.com/videos](http://woodmagazine.com/videos)



As Used in  
**The American Woodshop**

[www.dowelmax.com](http://www.dowelmax.com)  
 1-877-986-9400

**DOWELMAX**  
PRECISION ENGINEERED MULTIPLE DOWEL JOINERY SYSTEM

TURN  
 TO  
 PACKARD  
 FOR  
 QUALITY  
 TURNING  
 TOOLS  
 AND  
 SUPPLIES



"Playing Hooky" by Keith Tompkins

1-800-683-8876  
[PACKARDWOODWORKS.COM](http://PACKARDWOODWORKS.COM)



**EXCLUSIVE!**

**INFINITY**  
CUTTING TOOLS

**Carbide & HSS Knives**

**DEWALT**  
**DW735 PLANER**



- ✓ Thicker
- ✓ Stronger
- ✓ Lasts Longer **From \$79.90**

[infinitytools.com](http://infinitytools.com) | 877-USA-BITS

## Moisture Meters

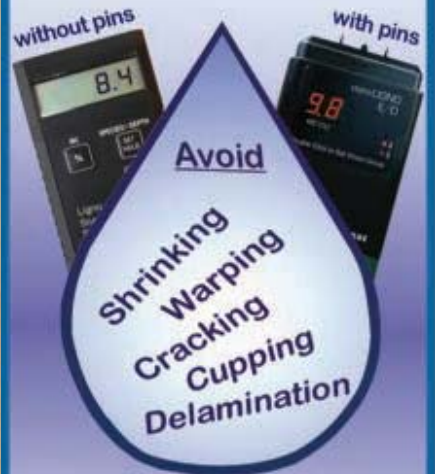

**The Woodworker's Choice:**

Accurate, sturdy and reliable moisture meters from Lignomat. Protected by a two year warranty.

New Web-site: [moistureproblems.info](http://moistureproblems.info)

**800-227-2105**

Lignomat USA LTD

PO Box 30145, Portland, OR 97294

[www.lignomat.com](http://www.lignomat.com)

# Your Source for Wood

Lumber • Veneer • Turning Stock



Over 100 Beautiful Woods in stock  
Easy & Secure Online Ordering  
Domestic & Exotic woods  
100% Satisfaction Guarantee



Get a \$10 Coupon online at: [www.101woods.com](http://www.101woods.com) 800-423-2450

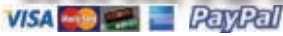

# WINTER SALE

up to **50%** savings



Limited Time Offer!



Made in the USA!



[www.steelspan.com](http://www.steelspan.com)  
**800-891-6733** ext 018

The Crown Master Mitre Box  
by Entab Industries, LLC

Finally Cut Crown Molding with Ease!

Save Time and Money!

Fits Most Major Brands of Mitre Saws

Increase Accuracy  
Avoid Costly Mistakes!

[www.crownmastermitrebox.com](http://www.crownmastermitrebox.com)  
1-855-263-6784 \$79.99 plus S&H

**DR® POWER GRADER TRANSFORMS YOUR ROUGH DRIVEWAY INTO A SMOOTH RIDE**

**PATENTED DESIGN** easily fills in potholes, smoothes washboard.

**POWERED ACTUATOR** controls grading depth with a remote control.

**LOOSENS AND REDISTRIBUTES** composite driveway surfaces without the need to haul, shovel, or rake new material.

**CARBIDE-TIPPED SCARIFYING** teeth loosen the hardest surfaces.



70564X © 2011

Call For a FREE DVD & Catalog  
TOLL FREE **1-888-213-2106**  
[www.DRpowergrader.com](http://www.DRpowergrader.com)

Create A Classic

size 21x35x39

Baby Cradle Plan # M62 \$15.95

Cycle Rocker Plan #M82 \$18.50

Trim pack info at [armorcrafts.com](http://armorcrafts.com)

Size 44L x 27H

VISA/MC 1-800-292-8296  
Armor Box 576 Monterey TN 38574

## Woodworking Plans!

Make This Un-Alarmingly Clock Order Plan #W3556

Meisel Hardware Specialties, P.O. Box 70  
Mound, MN 55364

FREE color catalog with plans for over 1,000 different projects.  
Mention Offer #1347



Call: **1-800-441-9870** Or visit our web site  
[www.meiselwoodhobby.com](http://www.meiselwoodhobby.com)

## SANDPAPER

**BUY DIRECT AND SAVE**

Abrasive Belts any Size any Grit  
Sheets-Discs-Rolls & More

Serving Woodworkers for 30 Years

SEE OUR CATALOG AT [Econabrasives.com](http://Econabrasives.com)

No Computer? Can't Find It?  
CALL 800-367-4101

The Wood Buff  
3-ON LATHE MANDREL

Do all three wood buffing steps without changing wheels! Great for pens & other small items.

**THE BEALL TOOL CO.**  
541 Swans Road N.E. Newark Ohio 43055  
1-800-331-4718 [www.bealltool.com](http://www.bealltool.com) Dept. MW

## BOW ARM MORRIS CHAIR

This award winning chair has been featured in Magazines and has won woodworking contests across the country. Our assembly directions have over 25 step by step photographs to assure a great project.

WIN A GRIZZLY TABLE SAW IN OUR YEARLY CONTEST

FREE CATALOG

AMERICAN FURNITURE DESIGN  
P.O. BOX 300100 ESCONDIDO, CA 92030  
BOW ARM MORRIS CHAIR \$19.95 + \$5.00 S/H  
Phone 760 743-6923  
[www.americanfurnituredesign.com](http://www.americanfurnituredesign.com)

Plan #181

## Projects and Plans



### Vendor Cart

Kit to build includes 2-24" iron wheels that really work, axles and step-by-step plans. Finished project measures 50"L x 25"W x 34"H. \$76.80 plus S/H

**ByeGone Workshop**  
**888-279-3941 8-5 M-F EST**  
[www.byegone.com](http://www.byegone.com)

## STEVE WALL LUMBER CO.

Quality Hardwoods and Plywood For The Craftsmen and Educational Institutions

Alder	4/4	Select	3.30
Ash	4/4	Select	2.60
Basswood	4/4	Select	1.95
Birch	4/4	Select	3.50
Butternut	4/4	1C	3.05
Cedar	4/4	1C+Btr.	2.00
Cherry	4/4	Select	4.90
Cypress	4/4	Select	2.60
Hickory - Pecan	4/4	Select	3.00
Mahogany (Genuine)	4/4	Select	4.90
Maple (Hard)	4/4	Select	2.80
Maple (Soft)	4/4	Select	2.50
Oak (Red)	4/4	Select	2.70
Oak (White)	4/4	QS	2.80
Poplar	4/4	Select	1.80
Walnut	4/4	Select	4.90
White Pine (Soft)	4/4	F.G.	1.25
Yellow Pine (Soft)	4/4	Clear	2.20

**UPS  
Specials**



			\$ 90.00
			\$ 96.00
			\$ 82.00
			\$ 110.00
			\$ 90.00
			\$ 80.00
			\$ 119.00
			\$ 92.00
			\$ 102.00
			\$ 114.00
			\$ 110.00
			\$ 90.00
			\$ 98.00
			\$ 98.00
			\$ 80.00
			\$ 117.00
			\$ 72.00
			\$ 84.00

Above prices are for 100' quantities of kiln dried rough lumber sold by the Bd. Ft. FOB Mayodan, NC. Call for quantity discounts. Other sizes and grades available.

Above prices are 20 bd. ft. bundles of clear kiln dried lumber 3"-10" wide • 3'-5' long (Random widths & lengths) Surfaced 2 sides or rough. Delivered Ground prepaid in the Continental U.S.

OLIVER MACHINERY DEALER

HARDWOOD PLYWOOD

CUSTOM RAISED PANEL DOORS

CUSTOM PLANK HRDWD FLOORING

THIN CRAFTWOOD

EXOTIC LUMBER

### STEVE H. WALL LUMBER CO.

BOX 287  
 MAYODAN, N.C. 27027  
 336-427-0637  
 1-800-633-4062  
 FAX 336-427-7588  
 Email: [wood@walllumber.com](mailto:wood@walllumber.com)  
 Website: [www.walllumber.com](http://www.walllumber.com)

Send \$1.00 For Lumber Catalog  
 Prices Subject to Change Without Notice

## STUMP REMOVAL FAST & EASY!

Eliminate Landscape Eyesores with a DR® STUMP GRINDER!

- Make stumps **DISAPPEAR!**
- **EXPAND** lawn areas!
- **OPEN UP** fields & meadows!
- **BLAZE** new trails!
- **REMOVE** mowing hazards!



TheDR® STUMP GRINDER uses carbide-tipped cutting teeth that take over 400 "bites" per second, to pulverize stumps into a pile of wood-chips. Quickly and easily, you can grind any size tree stump below ground level. Gone forever!

Call for a FREE DVD & Catalog!



TOLL-FREE  
**1-888-213-2106**  
[DRstumpgrinder.com](http://DRstumpgrinder.com)

## Can Your Old Dust Collector Work Better Than A New One?



Yes, with Optimized Filters from...



- Optimum Performance
- Low Maintenance
- Custom Designs
- Cleaner Air
- Longer Life
- Economical
- Best Size & Fit
- Proudly Made In USA

We Design & Fabricate Custom Filter Bags That REALLY WORK!

**American Fabric Filter Co.**

(800) 367-3591 [americanfabricfilter.com](http://americanfabricfilter.com)

## Need more space? Build your own murphy bed.



Piston-lift mechanism kit includes step-by-step construction plans and instructional DVD

### Create-A-Bed®

Toll Free **1-877-966-3852**

[www.wallbed.com](http://www.wallbed.com)

## Turn logs into lumber.



8 models to choose from

**Wood-Mizer**

800.553.0182  
[SawBoards.com](http://SawBoards.com)

dream to the

Better Homes and Gardens®

**WOOD**  
 MAGAZINE



For advertising in the Woodworker's Marketplace, please call Lisa Greenwood at 1-800-950-3829 or

[lisa.greenwood@meredith.com](mailto:lisa.greenwood@meredith.com)



**Make Time!**  
Create your own wooden gear clock!  
Order the pattern or the complete kit. Build it your way!

Wooden-Gear-Clocks.com  
715-955-4104  
www.wooden-gear-clocks.com

The DR® POWERWAGON is a Self-Propelled **EASY HAULER**

Sized and Priced for Home Owners!

**HAULS UP TO 800 LBS.** – firewood...mulch...gravel...stone. Powers up hills and down...even through soft, wet soil!

**ELECTRIC-START** and powered dump options available.

**EASY TO USE!** Rear caster and differential drive for easy turning...4 speeds, reverse, dump-bed, hand brake all included.



Call for a FREE DVD & Catalog!



TOLL-FREE  
**888-213-2106**  
DRpowerwagon.com

**Get Into Wood**  
**Sawing Lumber Made Easy!**

**MP-32 Sawmill** Cut Wood For:  
•Home •Barn •Fencing •Cabinets  
•Stables •Decking and more...

**5 Money Saving Package Deals!**

**FREE Catalog!**  
**1-800-473-4804**  
www.cookssaw.com

**WWW.RADARCARVE.NET**  
Wood Carving Duplicators

- Furniture
- Gunstocks
- Millwork
- Decoys
- Musical Instruments



*Incredibly accurate*

Thousands of Uses 505-948-0571

**Turn to Quality**



**One-stop shop**  
for all turning supplies

**Easy online ordering!**  
www.hutproducts.com  
**1-800-547-5461**



**HUT**  
Products

**WOOD**  
MAGAZINE



For advertising in the Woodworker's Marketplace, please call  
**Lisa Greenwood**  
at 1-800-950-3829 or  
lisa.greenwood@meredith.com

**DETAILED** Backyard Playground Equipment  
Play Systems

**FREE CATALOG!**

**Just Add Lumber!**

**FREE SMILES!**

**Do it Yourself and Save!**  
www.detailedplay.com  
**1-800-398-7565**



**WEEK LONG & WEEKEND WORKSHOPS**  
RUNNING APRIL - OCTOBER

**SUMMER WORKSHOPS**

- Cabinet Making • Carving
- Chair Making • Design
- Finishing • Furniture Making
- Joinery • Turning
- Veneering • Marquetry
- And Much More!

**www.marcadams.com**  
5504 E 500 N · FRANKLIN, IN 46131  
317-535-4013 · FAX 317-535-1713  
marc@marcadams.com  
Masters Programs & Scholarships Available



**SCHOOL OF WOODWORKING**  
**marc ADAMS**

# What's Ahead

Coming up in the May 2011 issue (on sale March 15)

## BASIC-BUILT™

GREAT PROJECTS MADE SIMPLE.

### Garden-tested planter box and trellis

Whether you build only the box, or add the copper-pipe-accented trellis for climbing plants, in just a weekend you can add a splash of greenery (and a touch of privacy) wherever you need it.

### Pint-size flinger

Escalate the office rubber-band fights with a fully functional desktop trebuchet! Perfect for flinging treats or waking up snoozers during meetings. Tell your spouse it's a physics lesson for the kids.



### Contemporary-yet-classic side chair

Craftsman Tom McLaughlin shows you how to build a solid-wood chair using easy-to-follow techniques.



### Sharpening Forstners

In just a few minutes, put a fresh edge on your Forstner bits using an inexpensive kit.



### TOOL TEST

### 14" bandsaws

We test seven fully loaded models that excel at resawing as well as curve-cutting.



### 2HP Cyclone

1700 Max CFM!  
68 inches tall!  
Quick Drum Lever  
35 Gallon Drum  
Portable!

**\$1299.<sup>00</sup>**

The JDS 2HP Cyclone is the most powerful and compact 2HP Cyclone in the industry. This unit is 68" tall and has a footprint of 40"x 28". The perfect size for basement shops and shops with limited space. The unique "Turbo-Fan" impeller provides outstanding CFM especially under a high amount of resistance. The cyclone is also portable and can be easily transported anywhere! The 35 gallon steel drum has a window on the side so you can see how much dust you are collecting. Removing the drum is quick and easy, just lift the drum lid levers and roll out the drum! Disposable bags can be used with the Bag Gripping Frame. The frame keeps the bags shape in the negative pressure inside the drum. The self cleaning 1 micron canister filter has a motor that automatically rotates flappers inside the filter knocking dust down into a collection bag.

## The Ultimate in Dust Collection

### Accessories



2HP RF Remote  
**\$89.<sup>00</sup>**

3HP RF Remote  
**\$99.<sup>00</sup>**



2HP Bag Gripper  
**\$39.<sup>99</sup>**

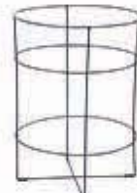

3HP Bag Gripper  
**\$49.<sup>99</sup>**

5-Pack  
Bag Kits



2HP Drum Bags  
**\$18.<sup>99</sup>**

3HP Drum Bags  
**\$18.<sup>99</sup>**

Canister Filter Bags  
**\$14.<sup>99</sup>**

**800.480.7269**



### 3HP Cyclone

2300 Max CFM!  
Self Cleaning 1 Micron Filter  
Quick Connect Drum Lever  
55 Gallon Drum  
Portable!

**\$1799.<sup>00</sup>**

With high performance and more features, the JDS 3HP Cyclone is raising the bar for 2-stage dust collectors. The TEFC motor has an aluminum housing that keeps it cooler and helps it run more efficiently. The "Turbo-Fan" impeller produces high amounts of CFM when placed under high amounts of resistance. Removing the steel drum is quick and easy, just lift up the drum lid levers and roll out the drum. The drum is on wheels and has a window on the side so you can see how much dust you are creating and when you need to empty the drum. The "Bag Gripping Frame" will allow disposable bags to be used in the drum. The frame will keep the bag shape in the negative pressure environment. The self cleaning 1 micron canister filter has a motor that automatically rotates flappers inside the filter knocking dust down into a collection bag.



[www.jdstools.com](http://www.jdstools.com)

# SKIL<sup>®</sup>

Do it right. Do it with Skil.<sup>™</sup>

## Precision is where we draw the line.

**The SKIL 12" Compound Miter Saw with laser cut line ensures the right cut every time.**

Your confidence has you ready to take on even the most complex projects around the house. That's why we engineered the SKIL 12" Compound Miter Saw. Patented laser cut line for perfect cuts. Left/right extension rails for better control. Nine positive stops for pinpoint accuracy. And the highest-rated motor in the industry. It's not just the best saw for the money, it's the only saw at this price with so many advanced features. After all, you draw the line on precision, too.



AVAILABLE AT



SKIL 12" Compound Miter Saw

skiltools.com

CORDLESS TOOLS | CORDED TOOLS | BENCHTOP TOOLS