

WORK

An Illustrated Magazine of Practice and Theory FOR ALL WORKMEN, PROFESSIONAL AND AMATEUR.

[All Rights reserved.]

VOL. II.—No. 66.]

SATURDAY, JUNE 21, 1890.

[PRICE ONE PENNY.]

A FEW HINTS TO INTENDING PURCHASERS OF CYCLES.

BY P. B. H.

WHEN walking along a good main road in the country, it is often both interesting and amusing, and affords a good subject for thought, to note the various, and sometimes absurd, positions in which cyclists hold their bodies when riding. Some with straight backs inclined to the horizontal at angles of 45 degrees; some with well-rounded backs like a drawn bow; others bending

Fig. 1.—Rider on badly designed Safety Bicycle. Distance between Handles and Seat much too great.

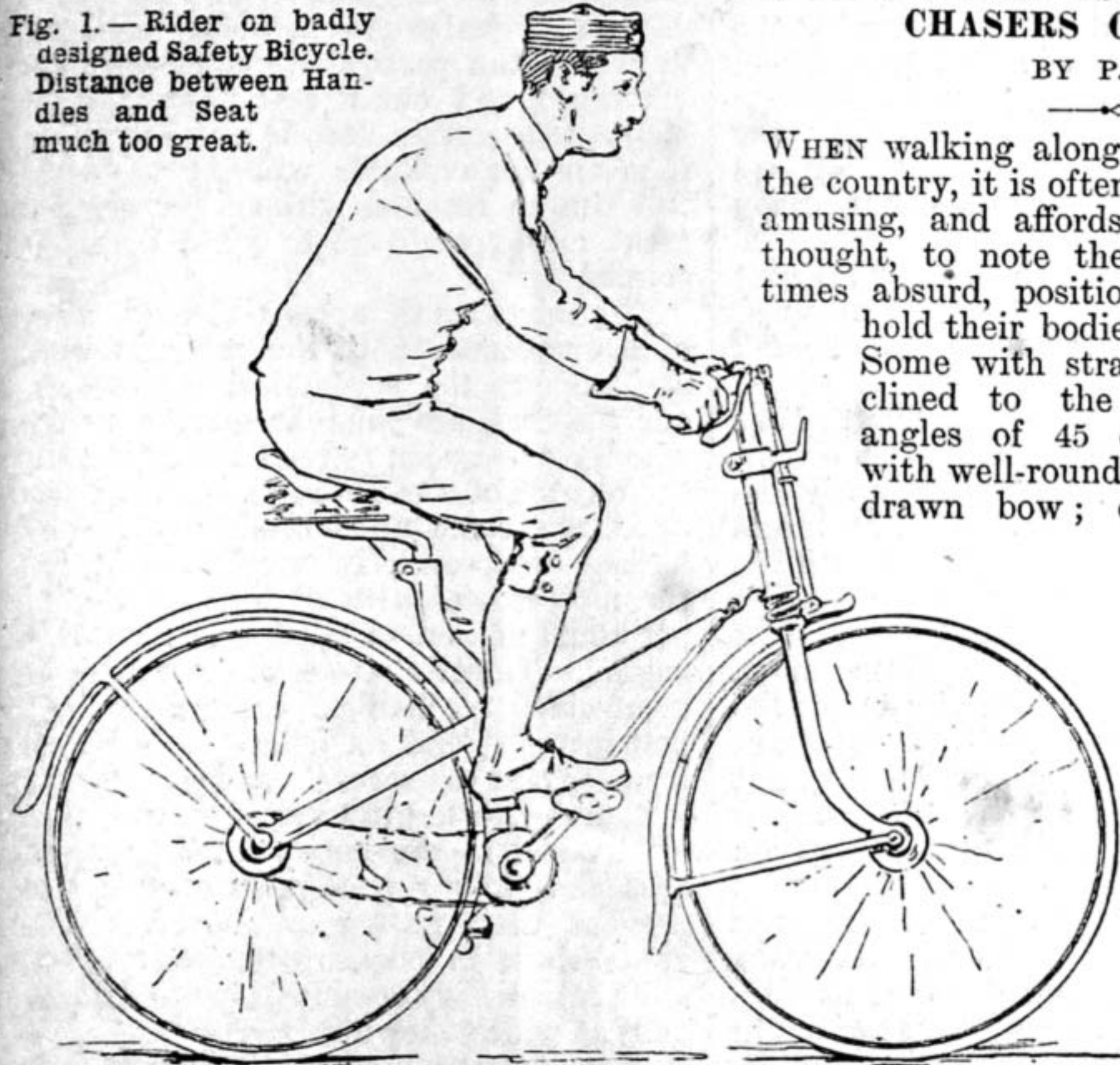

Fig. 4.—Rider on Ordinary Bicycle, showing best Relative Positions for Seat, Handles, and Crank.



almost horizontal, with their noses in dangerous proximity to the front wheel, at the same time swaying their head and shoulders from side to side like the pendulum of a clock, this side motion being combined with a vertical motion caused in their endeavour to increase the propelling power. Again, how easy some others seem to glide along; in fact, judging from these latter, it seems to the pedestrians so easy that they immediately draw the conclusion that scarcely any exertion is required to ride

Figs. 1, 2, and 3 should be carefully compared and Change of Position noted.



Fig. 2.—Rider on Seat too far back, but not so much as in Fig. 1.

Fig. 5.—Relative Positions of Handles and Seat in Safety Bicycle.

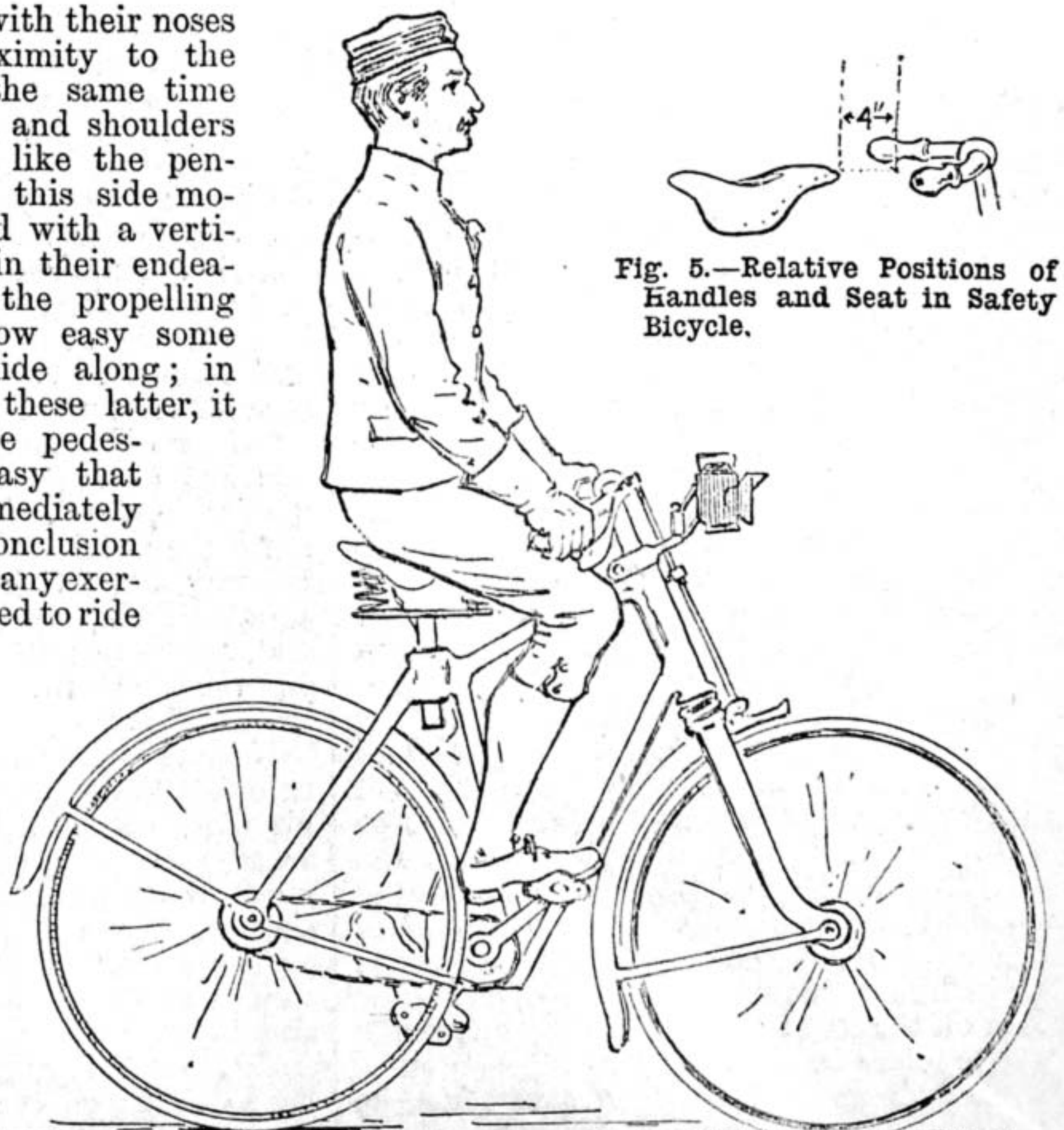

Fig. 3.—Rider on Safety Bicycle in Perfect Position.

a cycle along the road. This appearance of ease is caused by the rider sitting perfectly upright, the power driving the machine passing imperceptibly by tension through the arms from the handles to the shoulders, and from them to the pedals, and not by the awkward, jerky motion of the body before alluded to.

Most of the positions can be traced to some peculiarity in the designs of the machines. The rider of a well designed machine, that is, a machine made to suit his build, and with the seat, handles, and pedals placed in the best relative positions to each other, can always sit upright, though some still choose to stoop, and this rider, if placed on a badly designed one, would from use still sit more upright, and appear to travel more easily than a man who had ridden an inferior designed machine continuously, and some of the latter riders would not be able to sit upright on a good machine from the habit of stooping which has been acquired by having a badly designed machine.

I shall endeavour, by the aid of the accompanying sketches, to engraft on the mind of intending purchasers the principal points which go to make a good machine, by contrast with two badly designed ones, so that any reader, though inexperienced in the art of riding, may, when buying a machine, whether new or second-hand, form a good judgment of its qualities. I shall not enter into the subject of workmanship here, as it is generally in proportion to the price that is paid.

The sketches that I have made are of bicycles, as may be seen, but the remarks apply equally to tricycles.

Fig. 1 shows a rider with exceedingly round shoulders, caused, as can be seen, by a badly designed machine. In this particular case, the great defect is that the distance between the handles and seat is much too great. The seat, as here shown, is too far back, being almost over the centre of the driving wheel, having been placed there, no doubt, to secure adhesion, which it certainly does, but at the expense of steady running, machines of this class running very "wobbly," if I may use the term. Imagine a locomotive with nearly all the weight on the drivers, and only a comparatively small amount on the leading wheels or bogie. There would be a great many more coroners' inquests in this country if this custom were followed in these quick-running engines. The seat is the correct height relatively both to the crank shaft and handles, but it should be placed only slightly behind the centre of the crank shaft, when, if the rake of the front fork were slightly increased, the rider would be able to sit straight and thus be able to use his power to the best advantage. The seat in the position which is shown in Fig. 3 gives quite sufficient adhesion for the steepest hills capable of being ridden, and at the same time the weight is distributed more evenly.

Now compare all the angles formed by the arms, body, and legs in Fig. 1 with those in Figs. 3 and 4. In the former figure the rider would, when climbing a hill, be compelled to increase the pressure on the treadles by the ungainly jerky motion of the body before-mentioned, as the pull of the arms would only have a tendency to make him more round-shouldered, and draw him off the seat while but slightly increasing the pressure on the pedals.

To sum up Fig. 1. The seat must be brought forward almost centrally above

crank shaft, when the work will be applied in the best manner, which is directly downwards, and not, as shown, at a considerable angle. The rake of the fork should be slightly increased to bring the handles nearer the seat when the rider could sit perfectly upright, and apply his power through the arms without the fatiguing exertion of swaying the body vigorously about. In Fig. 2 the seat is still too far back, but not as much as in Fig. 1. The principal defect is that the handles are too high. In this case, the rider, when on a level, good road, can sit quite upright because little work is required to propel the machine, but a slight incline in the road would compel him to bend forward to apply the necessary pressure, as the pull through the arms does not help the application of the power to the pedals even as well as in Fig. 1, and you will again see the ungainly swaying motion of the body. The angles formed by the various members are again in this figure very awkward, and can bear no comparison to those of Figs. 3 and 4.

The position of the rider in Fig. 3 is about the nearest perfection that can be attained in a Safety machine. The wheels should be about 30 in. diameter. The seat is placed only slightly behind the crank shaft; thus the rider gives a vertical pressure on pedals, and his weight is more advantageously distributed in relation to the front wheel, and the rake of the front fork, together with the curve in the handle bar, brings the handles well towards the thigh. The question might be asked—"Why not curve them more, and bring them almost vertically below the shoulder?" In this case, the torsional strain in the head carrying them would be so great that they would most probably twist off.

Fig. 4 shows the rider mounted on an ordinary, and I have sketched it not to persuade any reader to buy an ordinary, but simply to show what may be considered the best relative positions for the seat handles and crank if they could only be attained in the Safety.

It does not follow that the riders of ordinaries always sit straight, but they have, if they desire, the best opportunity for doing so, and it is their own fault if they choose to ride in an inelegant position. I have seen riders bent almost double even on these machines. In all well-designed Safeties, the pedals are movable in a slot—that is, you can shorten or lengthen the stroke; the seat is also adjustable vertically, and handle bar likewise. Suppose all three fixed midway in the extent of motion—that is, the pedals in the centre of their slot, the seat and handle bars likewise. Now, to see if the machine is suitable, turn the crank till the pedal attains its lowest position, then mount the seat and extend the leg downwards, when, if suitable, the heel of the boot should just touch the pedal. This will be found a good working length. The handles should be about 4 inches away from the end of the seat, as shown in the sketch given in Fig. 5, and the top of the seat should be level with the handles.

If these instructions are followed, I have no doubt the purchaser will be satisfied with his machine, and not get disgusted with it, as a great many do, a result which arises most probably from some defect in the design. The use of the bicycle and tricycle as the means of locomotion must be regarded as extending daily in this country, and is becoming of increasing importance from a military point of view, and what I have written on the subject cannot be regarded as ill-timed or out of place.

MECHANICAL MOVEMENTS.

BY FRANCIS CAMPIN, C.E.

CONVERTING RECTILINEAL RECIPROCATING INTO CONTINUOUS ROTARY MOTION AND THE REVERSE—RECTILINEAL VIBRATING AND ROTARY MOTION, RECIPROCATING AND INTERMITTENT.

IN the inception and development of an invention there are several stages, and in some of these peculiar difficulties present themselves, especially if the inventor is not an accomplished mechanic. Setting aside accidental discoveries—which are not, strictly speaking, inventions—the course of evolution starts from the necessity or desirability of some mechanical method of performing some definite operation, suggesting itself to some individual usually in the class of business in which the particular operation is used. Having found out a real want, the next step is to ascertain how it may be met, and if means are available whereby the desired end can be reached without incurring too great an expenditure to yield economical results.

The mistakes that occur through a want of acquaintance with the mode of action, and scope of the mechanical movements at our disposal, are familiar enough to those who have occasion to refer to any extent to the records of the Patent Office, where we constantly come upon mechanical impossibilities, and, even in our days, encounter that most ridiculous of all fallacies, attempted perpetual motion, or apparatus for creating energy. The two classes of error arise from insufficient mechanical experience in the first instance, and an ignorance of physical principles in the second; and in this article it is my intention to treat of matters purely mechanical in the hope of rendering such assistance to my readers as shall not only prevent their falling into error, but also guide them in choosing the simplest and most satisfactory combinations to secure the ends at which they aim.

It very often happens that a contrivance which, on first consideration, appears a simple affair, becomes, by the time, it is made to perform its duty perfectly, of so complex a character as to put it quite out of the market; it is, therefore, of the first importance to design every part with an unceasing regard to simplicity, and to design and re-design, over and over again if necessary, to retain it; and as a machine is built up new ideas will arise as to the details already set out by which great improvements are often suggested.

A very helpful course to pursue, especially when novel combinations are contemplated, is to make models of each part as we progress, and this can generally be done in thin wood, working on pins and guides on a stout board, or the working parts may be made of stout millboard or of several layers of Bristol board fastened together with thin glue. This last material I have found very convenient on account of its uniform texture and freedom from grain; moreover, it does not warp after it is once made up. For tubes and other cylindrical parts, ordinary note-paper gummed together answers very well and keeps its shape admirably. If a semi-cylinder is required, it is best to make a complete cylinder by continuing to roll and gum the paper round a roller until a suitable thickness is obtained; when the whole is thoroughly dry the cylinder is cut in half longitudinally, and will retain its form. Most people will have their own opinions as to gums, but I have always found clear gum arabic dissolved in warm (not hot)

water the most satisfactory. Where pieces of cardboard have to be fixed by their edges diamond cement will be found reliable. No special tools are required for this class of card model making—a metal straightedge, a pen-knife, pair of scissors, a small keen chisel, and a carpet-needle in a handle for a piercer to mark centres, will suffice for all practical purposes, with a few weights to hold gummed and glued parts together until they are set.

Having opened with these few introductory remarks, I will now proceed to describe the different kinds of mechanical movements in classes according to the duties they are required to perform, and to show also methods of setting them out for practical purposes, and the peculiarities of their action.

Converting rectilinear reciprocating into continuous rotary motion and the reverse.—The most common arrangement for this purpose is the crank, Fig. 1. The length of the crank between centres B C is one half the rectilinear travel of the block A, which moves in guides of some sort to preserve the direction of its motion. If the block A moves with uniform speed the rotary motion will not be uniform; starting from the point D, the crank pin C will have its greatest velocity relatively to that of the block, and falls to its minimum speed when at right angles to the connecting rod A C, from which position it again increases until it reaches the point E. The points D and E are called dead points, because the force on the block A has no tendency when C is at either of those points to move the crank in either direction. In order to render the velocity of rotation as nearly uniform as may be required—as in a steam engine for instance—a fly wheel is fixed on the main-shaft B, but its duties and action will be treated subsequently. The dead point difficulty is obviated by having two driving cranks on the same shaft placed at an angle, most commonly a right angle to each other, so that while one is passing a dead point, the other is exercising almost its highest power; this arrangement also serves to equalise in some measure the force exerted during the revolution. It is evident that the block A will make a stroke forward and back again for each revolution of the crank. The length of the path travelled by the crank pin in one revolution is equal to the stroke, D E, multiplied by $3\frac{1}{2}$ (the ratio of the circumference of a circle to its diameter), and during this passage the block A makes two strokes, therefore the *mean* pressure on the crank pin will be the pressure upon the block A multiplied by 11 and divided by 7. If the crank pin is made so large as to extend beyond the main shaft B, as shown in Fig. 2, we have a modification which is called an eccentric, because the wheel F G H is fixed eccentrically upon the shaft; the eccentricity C B, which is called the throw of the eccentric, is equal to half the travel of the block A. Although the crank and the eccentric are the same in principle, yet practically there are considerable differences; for long travels of the block A the crank is decidedly preferable, for it is desirable to keep the crank pin as small as possible so as to lose as little power as may be in friction, and for a given pressure the work lost in friction varies as the diameter of the crank pin—this is evident, for as the pin revolves in its bearing, the friction on its circumference due to the pressure upon it must be overcome at each revolution through a distance equal to its circumference. If, however, the throw is small,

the crank pin may encroach upon the shaft; these cases occur chiefly where rotary is to be converted into reciprocal rectilinear motion, and it is for that purpose that the eccentric is chiefly used. By its adoption, the cranking of the shaft is avoided, and where a number of different movements have to be derived from one shaft, it is of great advantage to keep the shaft intact throughout its length; it will then be more uniformly strong, and therefore work with more steadiness and freedom from vibration than if it is bent about. If there is no room for the connecting rod A C between the block A and the main shaft B, a device shown in Fig. 3 may be used—it is very commonly found in small pumping engines; the crank pin works in a block F, which is fitted to slide in the vertical slotted bar D E; the rod A carrying the block F is supported in guides G G. The block F may be replaced by a roller to reduce friction, but in order to allow it to act there must be some play in the slot, and this involves some blow at each change of direction of the driving block, hence there is a disadvantage to set off the gain. Without the roller, the friction is necessarily great, and the arrangement is not one to be chosen, and in any case should only be used with short strokes, as otherwise the twisting strains upon the rod A will be very considerable. With a proportionately enlarged width of slot, this arrangement can be applied to eccentric movements, and for very short travels will often be found very convenient by reason of its compactness.

If it is required that both the rectilinear and rotary motions shall be uniform in speed the combination, Fig. 4, may be used. It consists of two parallel racks D E facing each other in an oblong frame G H, carried at each end by bars A A, which lie in a straight line and work in guides I; B is a toothed segment keyed on the shaft C. When the racks are moved back and forth to their full extent, they gear with the segment B alternately, and the same thing occurs when the racks are driven by the segment; it is obvious that the periphery of the segment will move with the same velocity as the rack, and, therefore, if the motion of one is uniform, so will that of the other be. The teeth must be so set out and arranged, that exactly as the last tooth of the segment leaves one rack, the first tooth takes into the other; of course the number of teeth will be the same in the segment and in each rack, and each stroke will have a length equal to the arc of the segment measured on the pitch line. Fig. 5 shows another method of obtaining uniform reciprocating motion when a long travel is required, which, were the previous mechanism used, would require an inconveniently large segment. The driving pinion A is carried on a short shaft working in movable bearings in the vertical slot B B in fixed parts of the framing. C C show a groove in one of the side plates attached to the double rack D D; in these grooves, the ends of the shaft carrying the pinion A and band pulley G work, and so the pinion is kept in gear with the rack. After the pinion has pushed the rack to the end of its stroke, it turns round the end teeth, and operating on the under rack, makes the return stroke and then mounts to the top again, its bearings falling and rising in the slot B B at the respective ends of the stroke. The pulley G is driven by a band F F from the pulley E, which is so placed that its centre is equidistant from that of the pinion shaft whether the latter is in its upper or lower position,

and, therefore, the tension on the band is constant when the pinion is driving. Of the rack and pinion methods of attaining the changes of motion now under consideration, I might give a very great number of varieties, but the object in view is to describe only such as may be relied upon as efficient, and in this connection it may also be said that moving bearings should only be used when unavoidable, as they add to the friction and liability to derangement.

When anything approaching high speed is used in parts that reverse the direction of their motion, care must be taken to have racks and toothed wheels made of tough material; if they cannot be cut out of wrought steel or wrought iron, they should be made of cast steel or "mitis" metal, to enable them to resist the shocks to which they will be subjected. Wherever toothed gear can be replaced by link-work, it is best to use the latter, as it saves noise and vibration. A friction-clutch connection by which rectilinear can be converted into rotary motion (but not the reverse) is shown in Fig. 6. A is the shaft to be driven, and upon it is keyed a disc B, having a groove cut in its circumference. To fit this groove, two friction pawls M and N, of which one is shown enlarged at O, are made, so that if pressed against it they will squeeze into the groove and bite, but if drawn in the other direction will merely slide over it. P is an end view of the driving disc showing the pawl groove Q, in which the pawls N and M work. On each side of the disc B, are arms R and S, which revolve freely upon the shaft A, but are prevented from sliding along the shaft by collars provided for that purpose; one pair of arms, R, carries the top pawl N, and the other pair, S, carries the bottom pawl M, the pawls being turned in opposite directions.

The pawl N is jointed to the arms R by the pin G and to the connecting rod D by the pin F. When the block C moves in the direction of the arrow, the connecting rod D pulls upon the pin F, and turning the pawl N upon the pin G, throws it into the groove Q, where it bites and thus turns the disc B and shaft A, the pawl M meanwhile sliding backwards over the groove, a small stop at the end of the arm S preventing its falling too far back; on the return motion the pawl N is released, and the disc driven by the pawl M connected by the pin I to the arms S, and by the pin H to the connecting rod E. The motion of the disc will be in the direction shown by the arrow at A.

Rectilinear, vibratory, and rotary motion, reciprocating and intermittent.—Vibratory motion can be obtained from rectilinear, and rectilinear from vibratory, from either the crank or eccentric, or from a toothed sector and single rack. In Fig. 7, A B is a crank on a continuously revolving shaft A, from which a vibratory motion is communicated to the rocking arm C D by the connecting rod B C. The arm C D may be made to give an intermittent reciprocating motion to a bar carried in guides, G G, by prolonging it and fixing on the prolongation a pin E, which takes into the teeth F F on the bar during part of the vibration, and thus gives an intermittent and reciprocating movement to the bar, such as might be suitable for feeding material to certain machines. In order to hold the bar at rest when it is not being moved by the pin E, which may be furnished with a roller to reduce friction, the teeth F F may be replaced by a slotted plate, H. The curved slots I I are made to the radius of the path of the pin E, and while it

is in either of those branches the bar is held at rest, but when it descends into the part κ of the slot the bar is moved. In some cases, an intermittent feed is required of some considerable extent, but no return of the feeder is permissible—a device for effecting this is shown in Fig. 8. $B A$ is a crank continuously revolving upon a shaft A . The feed roller D requires to be rotated intermittently. There is a friction bar $B C$, which at the end B is jointed to the crank, and at the other end is weighted, pressing sometimes on the feed roller D , and at others on the loose roller E , carried upon a dead centre fixed to the framing. While the friction bar presses upon D , the latter revolves, but always in one direction, because on the return stroke the bar rests on the roller E , as shown by the dotted lines. The spring H presses a light brake against the roller D to keep it at rest when not acted upon by the bar $B C$. By making the dead centre upon which the roller E runs adjustable, the amount of motion that is given

In the friction bar, in arrangement in Fig. 8, in which no back motion is allowable, the length of the crank $A B$ must be equal to half the maximum travel required (if it is variable), then a straight line $A I$ being drawn from the centre A to touch the upper surface of the feed roller D , the relief roller E must be so placed as to touch the line I with its upper side; and if it is made adjustable it must be so set that it cannot be lowered. By raising it by means of the screw adjustment κ the amount of feed at each stroke is reduced.

It seems advisable here to point out the advantages gained by friction rollers, as I have already had occasion to refer to them; and shall again. If a pin, say, or a block, works upon a slide, then the amount of work lost in friction in foot-lbs. during each stroke will be equal to the friction resistance multiplied by the length of the stroke. For example, the friction of a smooth block on a smooth guide, both being of iron, will be about one-fifth of the pressure on the block.

larger the diameter of the roller in relation to the pin the less will be the friction; but, even when there is very little room for difference, the advantage of easier lubrication will make it worth while to use rollers. It is, however, not to be overlooked, that if a single roller is used, it must be made a little less in diameter than the distance between the guides to allow it to turn; and, with very heavy pressure, this might cause rather heavy knocking.

Considering the saving of wear, especially on the guides themselves, it is worth while to take a little trouble to obviate this evil where it exists in any appreciable magnitude. In Fig. 9 is shown an arrangement of rollers, of which the simplest form will be two, A, B , running between guiding surfaces C and D . In this case, the rollers may always be in contact with the guides, and with each other, and be held in position by pins fixed in side plates. More than one pair of rollers may be used in the same block if desired; but, of course, there must

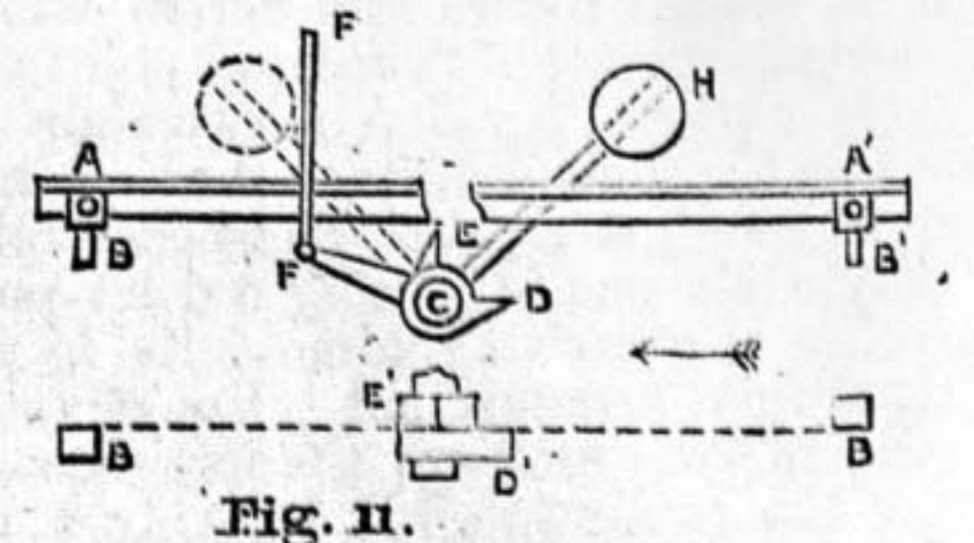
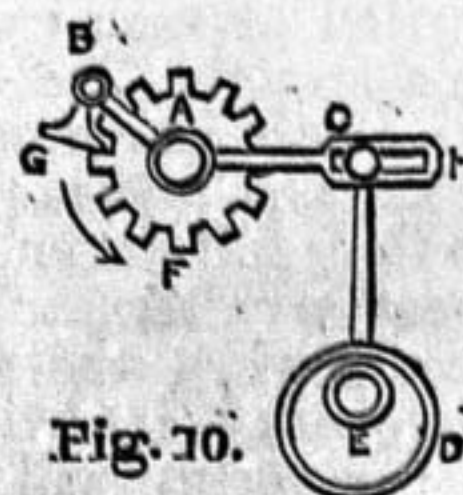
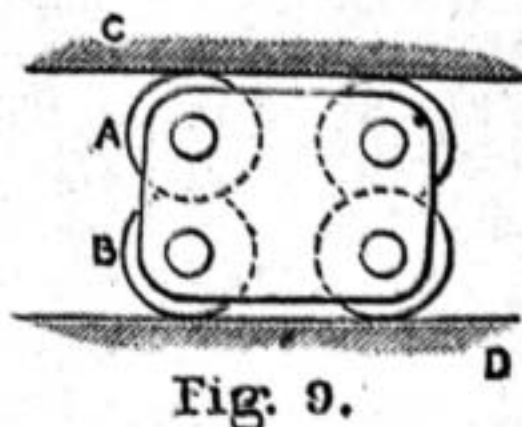
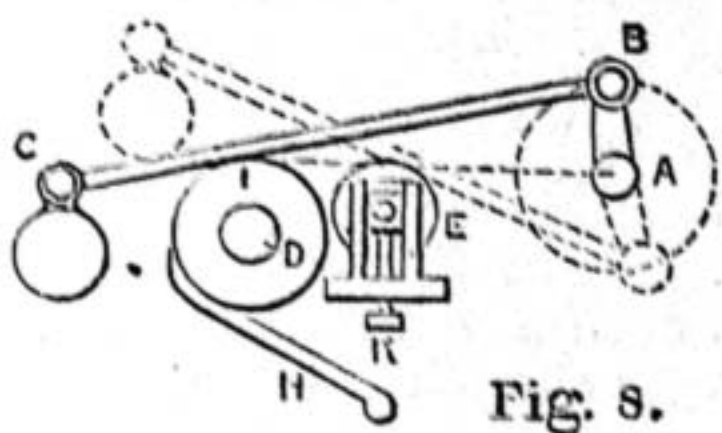
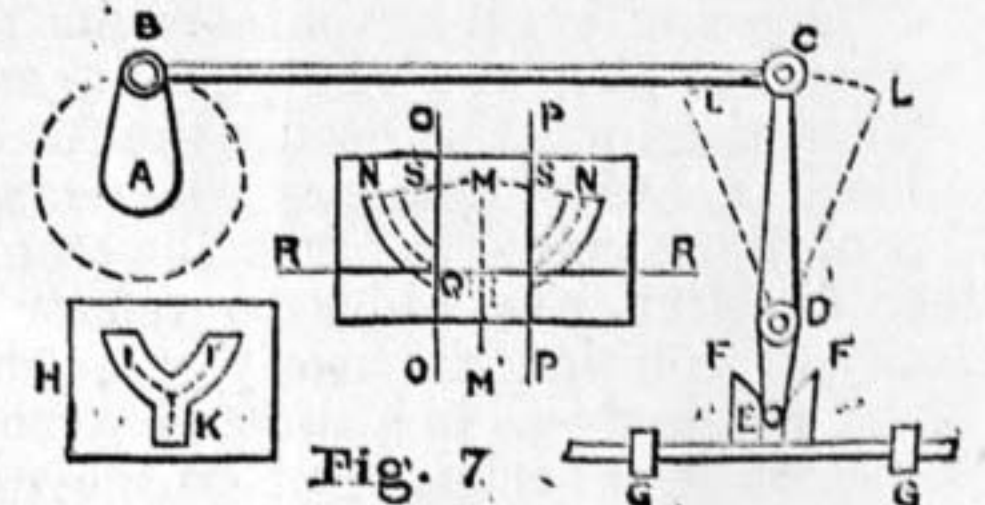
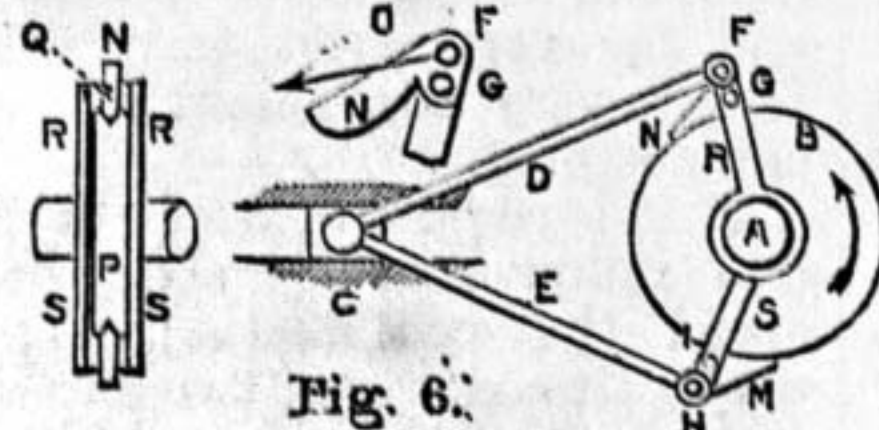
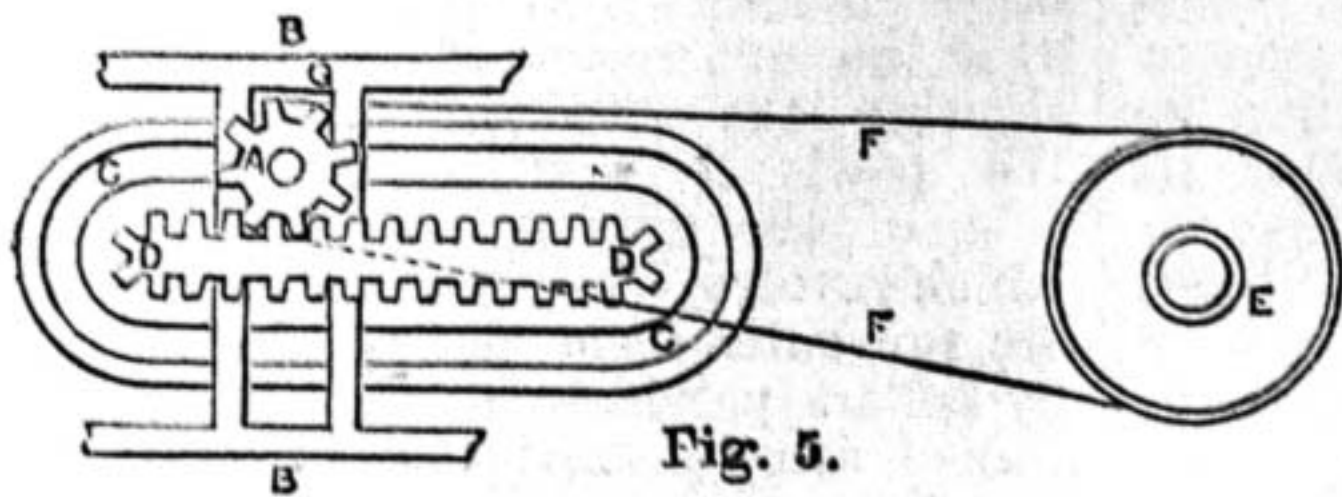
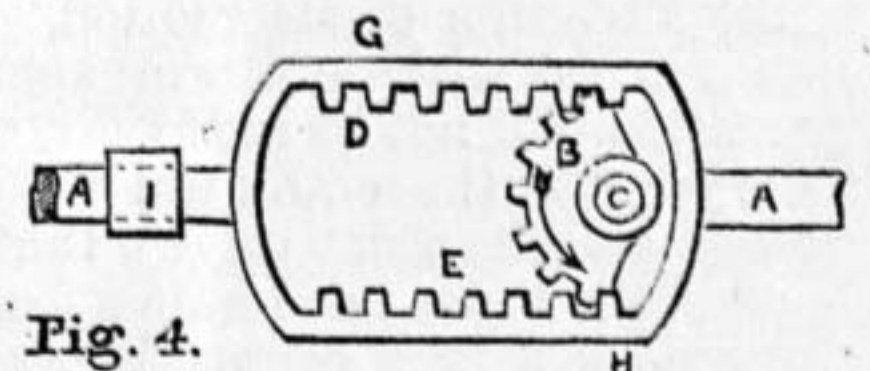
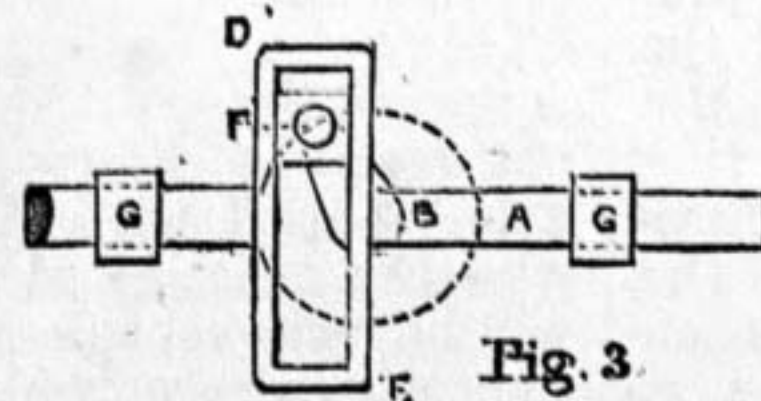
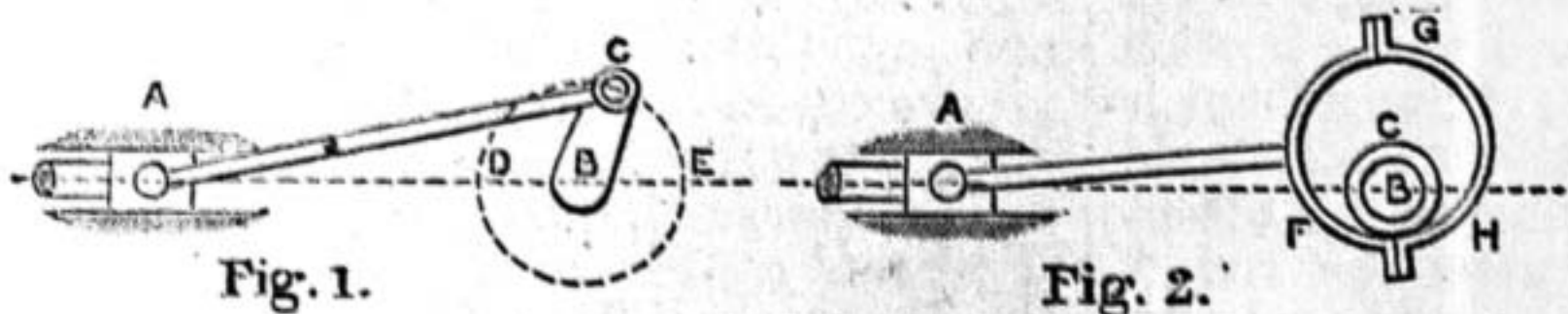

Mechanical Movements. Fig. 1.—Crank and Connecting Rod. Fig. 2.—Eccentric and Connecting Rod. Fig. 3.—Crank and Cross-Slotted Rod. Fig. 4.—Double Rack and Segment. Fig. 5.—Returning Rack and Pinion. Fig. 6.—Pawl and Disc Movement. Fig. 7.—Crank and Vibrating Arm. Fig. 8.—Intermittent Roller Feed. Fig. 9.—Anti-friction Rollers. Fig. 10.—Intermittent Ratchet Feed. Fig. 11.—Adjustable Stop Feed.

to the feed roller D may be regulated without any difficulty.

In setting out the movement in Fig. 7, the length of the crank $A B$ will be one half the chord $L L$ of the arc $L O L$; the travel of the pin E will be to that of the point C as the length $E D$ is to $D C$. In order to determine the form of slot for any given travel of the bar in the guides $G G$, draw the straight line $M M'$ at right angles to the bar, and from M , with a radius $M N$ equal to $D E$ enlarged, describe the dotted arc $N N$ equal to the arc of travel of the point E ; draw the straight line $R R$ at right angles to $M M'$ and cutting it in the point Q , then from the point Q on the line $R R$ mark off half the required travel of the bar on each side, and through the points so found draw parallel to $M M'$ the straight lines $o o$ and $p p$, intersecting the dotted arc at $s s$, then the two arcs $s N, s N$, brought together so that the line $o o$ coincides with $p p$, and the points $s s$ coincide, will form the upper branches of the slot; the vertical slot must be carried low enough to clear the bottom of the whole arc $N N$. The centre lines being thus obtained, the width of the slot is set out to suit the diameter of the pin or roller intended to work in it.

If, then, there is 40 lbs. load on a block moving 3 ft. each stroke, the loss by friction would be 40 divided by 5 and multiplied by 3, equal to 24 ft.-lbs. Suppose, instead of the sliding block, a pin one inch in diameter surrounded by a roller two inches in diameter is used, then the friction is between the pin and the roller carried by it; and as the pin is one half the diameter of the roller, the distance travelled by the rubbing surface within the roller will be one half of that travelled by the rolling surface upon the guide; and, therefore, the work lost by friction will be reduced by one half. In both cases the friction may be reduced from one half to a third by the use of lubrication; and when this is done, there is a further advantage in the use of rollers, because the oil is held by capillary attraction between the roller and the pin; and the pressure between the surfaces, although forcing it forward, keeps it upon the surfaces to be lubricated, and it is not exposed to the drying influence of the air; whereas, the lubricant upon a guide is pushed by the block beyond the working surfaces, and the greater part of it is at all times freely exposed to the air. It is obvious that the

be some clearance between each pair of rollers. Fig. 10 shows a device very much used for giving the feed in machine tools for shaping, milling, and other purposes. To the shaft A (which may have a screw thread cut upon it to give motion to a tool box or a table carrying work) is keyed a tooth wheel F ; and upon the same shaft there also oscillates freely a bell crank $C A B$; the end C is caused to oscillate by the rod $C E$, which is actuated by the eccentric D upon the shaft E . The double pawl G is made so that in one direction it will slip over the teeth of the wheel F , but in the other direction catch in them and turn the wheel, in the direction of the arrow if in the position shown, but in the opposite direction if the pawl is turned over to the position shown by the dotted lines. This pawl and wheel arrangement is sometimes actuated by stops and a tumbler, as shown in Fig. 11. $A A'$ represent the two ends of a travelling table, on which are fitted adjustable stops $B B'$, by the position of which the traverse of the table is governed. C is a shaft carried in fixed bearings, and carrying on an arm a weight H ; this arm moves between fixed stops, which limit its throw between the

position shown and that in which H would be, as indicated by the dotted lines. Upon the shaft c is fixed a boss carrying two projections, D and E, the latter lying behind the former, as shown at D' and E' in the plan view; so that the stop B' will act only on the tooth D, and the stop B on the tooth E. If the table be moving in the direction of the arrow, the stop B' will come in contact with the tooth E' and throw the shaft a quarter round, the feed being actuated by the short arm c F and rod F F; on the return of the table the stop B will strike the tooth D, and throw the gear back to the position shown. This tumbler arrangement can also be used to reverse the direction of the table by various means which come under the head of reversing gear. The travel of the pawl G (Fig. 10) can be adjusted by making the end of the arm A C with a slot, in which the pin, carrying the upper end of the actuating rod, can be secured at any desired distance from the centre A. The use of the weight H (Fig. 11) is to keep the shaft c and its appendages at rest when not acted on by the stops B and B'.

I must reserve my remarks on release and trip movements and cams and cam bars for another brief paper.

A PORTABLE FOLDING BOOKCASE.

BY GEORGE H. BLAGROVE,
Author of "Decorative Woodwork," etc.

A BOOKCASE which can be folded up and packed in a small compass is likely to prove a useful article to many persons who live habitually in furnished lodgings, having their own stock of books, and now and then changing their place of abode. The idea of a folding bookcase is not new. One was described and illustrated in *Amateur Mechanics* in January, 1883, the description and illustrations having been reproduced from some other publication. But the constructive details, so essential for workmanlike execution, were wanting. The present design is new, and the construction has been, in some slight respects, modified, and, it is hoped, improved.

The plan is shown in Fig. 1, and it will be seen that the sides of the bookcase consist of two boxings made out of 1½ in. stuff, which would probably finish 1¾ in. thick, grooved and tongued together. Between the back and front is a clear space of 11 in., to allow depth for the books. The back is formed with four pieces hinged together, each piece being made to finish 8½ in. wide and ¾ in. thick.

Fig. 2 shows a section taken longitudinally from side to side through the bookcase

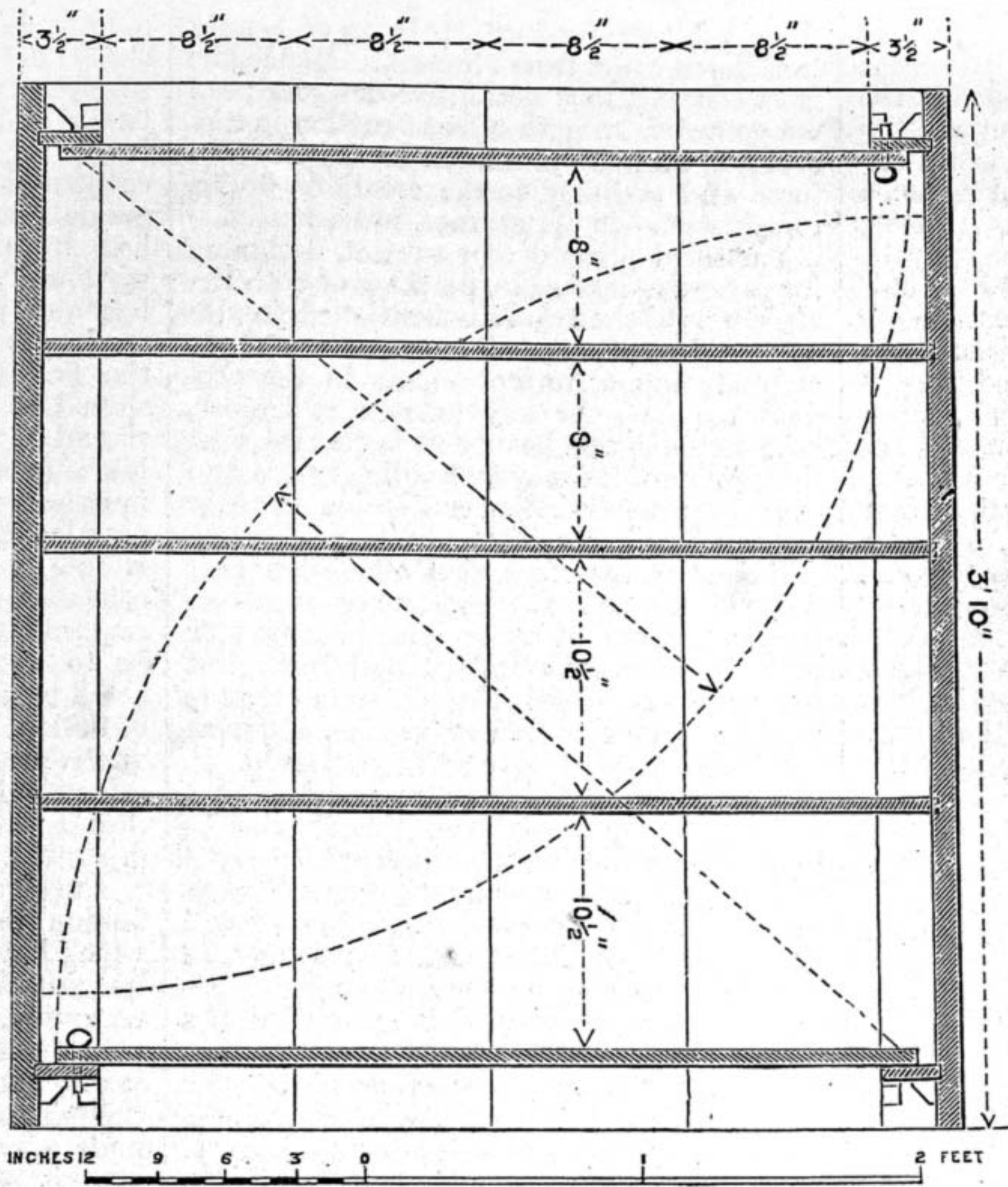

Fig. 2.—Section lengthways from Side to Side of Bookcase when open. (Scale applies to Figs. 1, 2, and 3.)

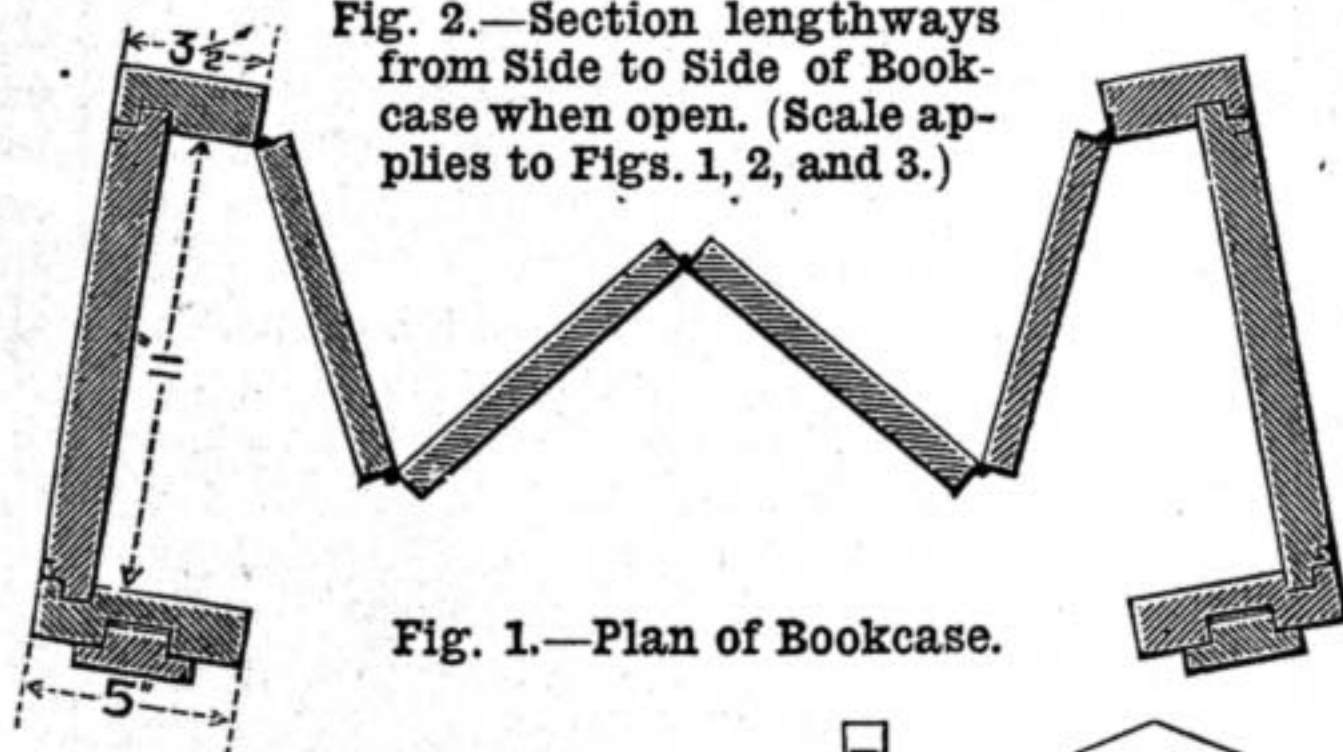

Fig. 1.—Plan of Bookcase.

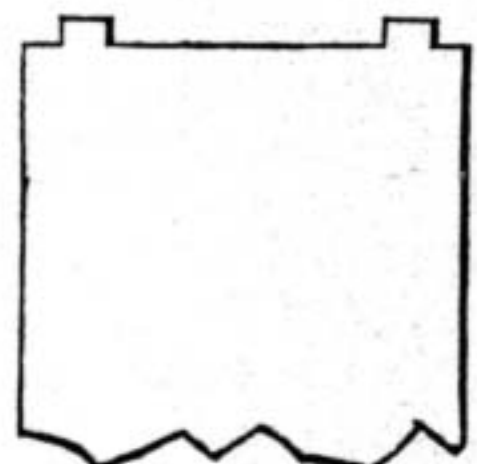

Fig. 3.—End of Shelf.



Fig. 4.—Section of Cornice.



Fig. 5.—Section of Top, Bottom, and Shelves.

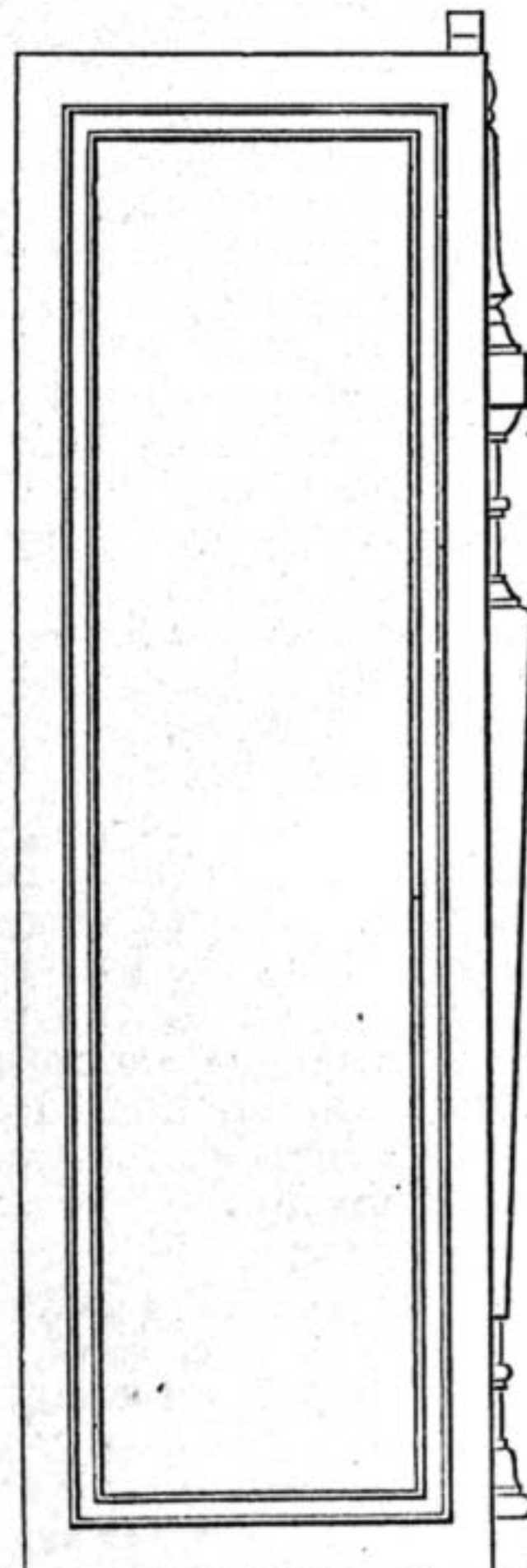

Fig. 6.—Side Elevation.

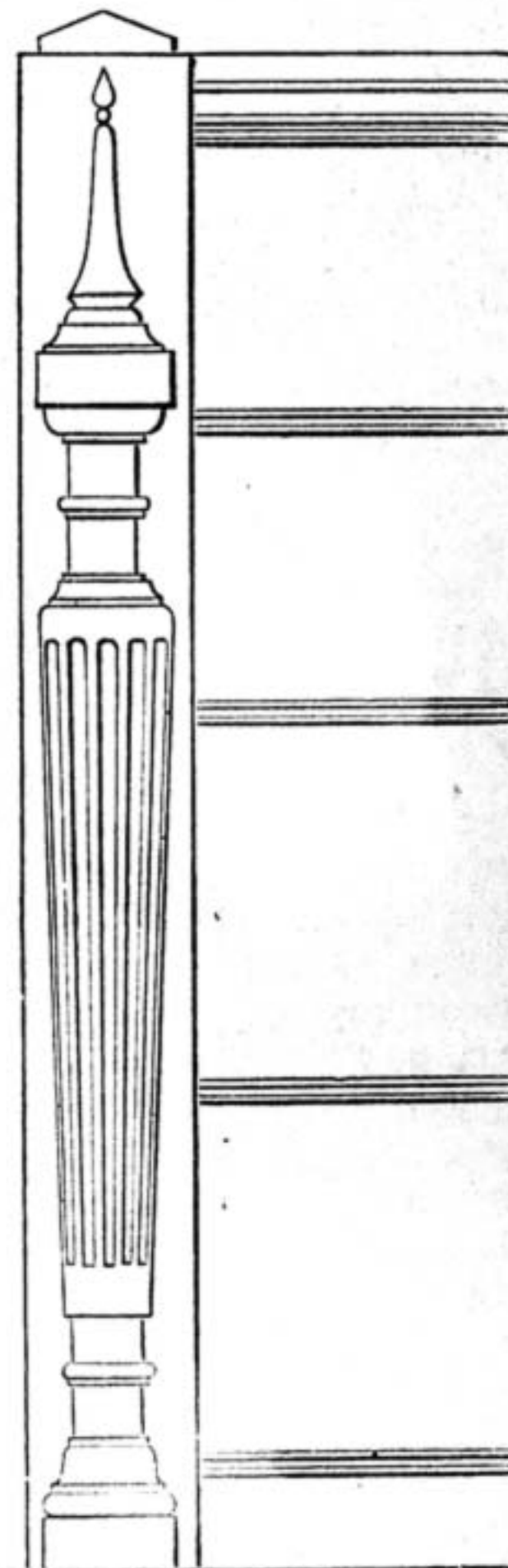

Fig. 7.—Front Elevation.

when open. At each end of the side boxings a piece, 12 in. by 2½ in. by ¾ in. thick, is housed into the front, back, and side of each boxing, and sustained firmly in position by means of angle-blocks, glued in as shown. These pieces serve to strengthen the boxings, and it will be seen from Fig. 2 that they also serve as stops, against which the top and bottom of the bookcase are closed when the whole is in use. The top and bottom are out of ¾ in. stuff, and should finish about 1 1/8 in. thick. They are, moreover, 11 in. wide, and should finish a little under, to allow them free play inside the boxings. The same remarks apply to the shelves. The top of the bookcase is hinged to the under side of the left-hand upper cross-piece in the side boxing, and it closes against the under side of the right-hand upper cross-piece, to which it is firmly secured by means of two thumbscrews. Similarly, the bottom is hinged to the right-hand lower cross-piece, and closes upon the left-hand lower cross-piece, being similarly secured with thumbscrews. When the bookcase is to be folded up, we will suppose the shelves to have

been removed. The top is now unscrewed and moved down so as to close against the side of its boxing. The bottom is next unscrewed, and it is to be observed that it must be made of such a length that it will clear the thickness of the top hanging vertically, and move up with a vertical position against the side of its own boxing. The remaining depth in the side boxings will be occupied by the shelves, two of which will be in one boxing and one in the other. There would be space for another shelf, if desired, which might be if there were many small books. Each shelf has two stub tenons, 1 in. wide by ½ in. projection at each end, which fit into holes or mortises cut at the required levels in the sides of the boxings. One end of a shelf is shown in Fig. 3. When the bookcase is closed together, the front pieces of the boxings, which are 5 in. wide, close together, and the back pieces, being only 3½ in. wide, have a space of 3 in. between them, which allows for the four ¾ in. pieces of the folding back to lie between them. The pieces of the back being only 8½ in. wide, this leaves a space 2½ in. deep by 3 in. wide between them and the front pieces of the boxings. This space is occupied by the cornice, of which Fig. 4 is a section. When the bookcase is open for use, there is a clear space of 2 ft. 7 in. between the front pieces of the two side boxings. This, then, is the length of the moulded part of the cornice, beyond which there should be at each end a tenon

1½ in. deep, ¾ in. thick, and 1 in. projection, with corresponding mortises in the front pieces of the boxings, so arranged that the cornice, when fixed, shall rest upon the top of the bookcase. Perhaps the reader can improve upon the section of the cornice shown here. Fig. 5 shows the section of the top, bottom, and shelves, and this also may be open to improvement. It is easy to see how the bookcase can be opened, by means of its hinged back, so as to allow the tenons of the shelves and the cornice to be fixed in position. After this is done, the top and bottom can be fixed with the thumbscrews, and the whole will make a firm, strong piece of furniture. A side elevation and part of a front elevation are shown in Figs. 6 and 7. A species of ornamental pilaster is housed or tongued on to the front piece of each side boxing, the side of which is treated as a bead-flush panel. Here again it is left to the reader to improve upon the ornamental part of the design. The space occupied by the entire bookcase when folded for packing does not exceed 4 ft. by 15½ in. by 10 in.

DESIGNING FOR WORK: HOW TO GO ABOUT IT.

BY JOHN WHITFIELD HARLAND.

END, AIM, AND OBJECT OF DESIGNING—CONVENTIONAL TREATMENT—IMPRESSIONISM.

SINCE writing my last article on this subject, I must perforce prelude present and future remarks by systematising so vast a field for speculation by subdividing and classifying its various ramifications, so that my readers in pursuing it in one direction may not lose sight of their object in an opposite one, but can come back to a common starting-point. It will then have a more logical sequence; and if I classify all designing according to its purpose or object, I shall be saved much confusion of thought, both to myself and the practical readers of WORK. I shall therefore show that all designing, being a means to an end, is classifiable according to its purpose; and deduce therefrom what is the requisite power of conception and inception necessary for each particular class of designing, and instance the kind of knowledge and training most suitable for obtaining such mental power in each purposeful direction.

All designing is capable of reference to this common characteristic, its object, thus—

1. Designing for construction, involving *strength*. 2. Designing for decoration, involving *beauty*. 3. Designing for inventiveness, involving both strength and beauty.

In this classification all designing is embraced.

Designing for construction, be it for buildings, machinery, bridges, public works, furniture, or any other construction, strength is, and must be, its aim, since safety of human life is involved. Economy of material is a secondary consideration, whilst other side issues, such as sanitation, public convenience, etc., will inevitably modify all designing in this direction; mere beauty ought not to have any sway to the sacrifice of its primary purpose of strength.

Designing for decoration involves no danger to life, such as construction inherently entails, therefore the artistic instinct and imagination has free vent, unfettered by fears of future remorse, such as would inevitably haunt the designer of bad construction should human life be thereby

sacrificed, to reproduce anything of beauty considered apart from strength. Hence, the most conscientious decorative designer need not consider strength of construction in any other light than inasmuch as it will give force and stability to the creations of his imagination—in appearance, not actually.

The third phase of our subject, designing for inventiveness' sake, partakes of both the attributes of the two fore-mentioned classifications. Invention creates improved methods of producing, or improvements in the product required for any purpose, therefore, both strength and beauty (it is granted that their proportions may and will vary greatly) enter into the design or conception more or less in every instance.

It follows, therefore, that all design that does not aim either at strength of construction, or beauty, of some type or other, or both, is valueless, aimless, and bad. Put imaginatively, from the creation of the world—as told poetically in Genesis, with the prototype of strength portrayed in Adam, and that of beauty limned in Eve—down to the present time, it is impossible for any human being to admire or be pleased with anything weak or ugly, *per se*, although such emotions as pity, compassion, and moral condonation of such faults may be brought into play as mere sentiment. Instinctively, admiration is produced by strength or by beauty, or by a combination of both, and not by any other ideality or reality. Mental strength, power of intellect, can be equally recognisable; mental beauty, the beauty of thought and feeling, calls up the same sympathetic admiration as the physical forms of strength and beauty, but I maintain that whether mentally or physically both are absent no human feeling of pleasure can result; by pleasure, I mean the highest and best sense of the word, a plea admitted, an influence over the human spirit welcomed for its inherent good, and for the deep impression on the mind for good. This is, or ought to be, the ultimate of all design. In decoration, a moment's thought will suffice to show that if the governing idea is the producing of such an effect of true pleasure on the minds of others, usefulness as well as mere beauty will result; for children, whose minds are so much more susceptible of impression produced by their surroundings "than is dreamt of in our philosophy," will retain in after-years some associations that have beauty in them which will bear some trace of refinement, even if it is only the mere prettiness of the public-house, or the well-arranged windows of the shops, to say nothing of good pictures, happy effects of colour, and other refinements in their homes. My reason for thus entering into ethics is the very frequent recurrence amongst artists of the expression when just commencing a subject that they "do not feel fit," they "are not in the humour," "ideas do not seem to come," etc. Imagination, like the palate, requires some stimulating sauce, and I think the best sauce to tempt it is the thought of the ultimate result; not to dwell on the commencement, but to look forward to the finished conception realised; the humour for work will soon come, the fitness for the task will soon develop itself, and success will be achieved.

The first step in designing is to decide what the mind is most capable of. If the mind has a natural bent for mathematics, accuracy of reasoning, and not of a poetical and imaginative turn, with a strong will to overcome obstacles, and a strong mechanical tendency, the would-be designer should devote himself to constructive design, and

qualify for his future career by thorough study of mathematics, including natural sciences—mechanics, dynamics, hydrostatics, chemistry, physics—with enough knowledge of anatomy to understand the construction of the frames of man and animals, and enough botany to teach him how trees and plants resist strains from without; and, in fact, every subject which has any bearing, near or remote, on the principles of construction in nature, or in the previous work of man. His training should be theoretical as well as practical; he should be able not only to make a drawing himself for others to carry out, he should be practically able, if necessary, to carry into practice his own drawing. As his vocation is mostly to reproduce and copy existing construction, his imagination will not require much training or culture, and may be to some extent impaired and counteracted by the study of fact to the exclusion of fiction, unless he possesses the gift of inventiveness, when imagination, curbed by scientific knowledge, will put him at once into the ranks of the third category of designing.

The alternative to this selection of a profession in designing is that of the mind which hates arithmetic and mathematics, is imaginative and dreamy, cares but little for reasoning, but tends to the refinement of voluptuous form and colour; poetical, and seeks change and variety, new themes, fresh thought, and pastures new; such a nature finds a sympathetic field for its powers in pursuit of the second category, decorative design. The studies necessary for the earlier training in this line are drawing and modelling; the education of the eye and hand firstly for the expression of form, and subsequently for that of colour; optics, including perspective, elementary geometry, botany, anatomy, light and shade; the chemistry of colours and pigments; something of architectural style and architectural history. All these, besides being in themselves useful in his future career, will have during the acquisition a marked influence on his refinement and mental culture, and assist in forming correct taste. His light reading should be poetry, or imaginative standard works, his observation of men and things ever constant and watchful, and above all, his memory (owing to the absence of mathematical study) should be constantly trained to treasure up form and colour. Foreign travel, if possible, should be undertaken, whence spring new ideas, natural effects—novel and suggestive—and that change and variety that so stimulate the imaginative mind by instituting that great educator of artists, comparison. Here the associations of the student's childhood will affect his future to an extent quite incalculable. Apart from the theory of hereditary transmission of mental as well as physical qualities, no one can but admit that if a plant, the lowest form of created life, can be subjected to the nurture of a hot-house and surrounded with all the refinements of a wise plant-culture and thereby become more symmetrical and beautiful than a similar one left to grow up in a wilderness under only nature's auspices, a human being will be to a greater extent mentally as well as physically made or marred by its surroundings whilst young. This channel leads on to endless speculative thought; but in returning to our subject, let us ask, Is our board-school system education at all, in the broad sense of the term? Are our children ever surrounded with the purely artistic forms and colouring of continental

cities, examples of the work of the Dark (God save the mark) Ages? Are even flowers, that cost so little, ever found decorating the hideously painted and badly proportioned schoolrooms; and even from a sanitary point of view, why is not their fragrance used to overcome that faint odour of a crowd we all know so well? And yet we find our statesmen wondering how it is that in artistic feeling our working-men are behind their continental *confrères*, and how it is that ideas in design, ideas which I hold have been sown like seed in childhood and youth, do not come so spontaneously with us as with foreign workmen. Fellow British workmen, amateur or professional, despise not the day of small things, surround your offspring with even the most inexpensive decorations possible—good form, good colour, cheerful light—even if their food is less choice; good examples, however cheap, of chromos, and change them from time to time; you will thus develop in their minds those ideas which will, like a grain of mustard seed, bring forth in due season, some perhaps “an hundredfold.” The food for the mind is more important than the food for the body, yet how seldom is this admitted. Designing for the future career of one’s own offspring is the highest form of design—it combines strength and beauty. Perhaps I am straining my subject in this latter truth, but its importance excuses my digression.

Workmen, as workmen, whether amateur or professional, are most palpably much more nearly affected by the second category of my classification of designing than either the first or third. I will then give, as in my first paper, which bears chiefly on decorative design, a few suggestions which I hope may prove practically useful. There are, firstly, many terms used every day which I prefer to consider here as so many cant phrases. There is no obstacle to free and original thought so great as this adoption of cant phrases, and in designing, the ideas following in their wake, and the monotonous trail of froth and foam they leave on the ocean behind them are valueless, colourless, and an obstruction diverting the mind from looking ahead. One of the commonest of these cant phrases is the application of the word *conventional* to the treatment of any design. Now, what on earth does this mean in nine out of ten cases? It has degenerated into a phrase to express a *motive* suggested by the form or colour of a prototype in nature, such as a flower, messed about and treated, as another cant phrase has it, *æsthetically*. I like to call things by their true names, and I have never been able to see that finite man can ever improve on nature, even by going back centuries, when bad drawing—which was very good if judged by what had gone before, but which modern science proves by photography to have been very “bad form” indeed—or the adoption of semi-barbarous ideas of such form and colouring as Japanese ornament furnishes, could never obtain for a moment any foothold on refined taste, but for the insane dictates of fashion. If a writer quotes from another author and does not acknowledge the source whence he derives his inspiration he is a plagiarist (a mild term for literary thief), and if an artist “cribs” from nature, form, or colouring, or arrangement, why should he systematically disavow it by pretending to adopt the barbarian Japanese style? If English artists and designers cannot paint from nature more truthfully and more characteristically than savages centuries behind them in art, in Heaven’s name let it be openly confessed and put to shame at once.

If we with our traditional art, with a school of painting of which we have nothing to be ashamed, cannot go to nature, and by our fidelity to nature admit the source whence our inspiration is derived, it is time to “shut up shop.”

“Conventional treatment,” however, used to have a meaning. It used to mean that some form was selected from nature’s book, and for the purposes of decorative design it was repeated over and over again in a modified manner, either wholly or in part so as to come within the influence of geometrical dimensions and proportions. Hence the trefoil, quatrefoil, and cinquefoil of Gothic architecture; but now it is used for any debasement of which designers can possibly think. We see bands and bends, borrowed from heraldry, with patches of Japanese patchwork; dados, with disproportionately large sunflowers, drawn as if we did not know how to draw; and small storks, and doves, and trees painted as if our sole source of knowledge was a Chinese willow-pattern plate put forth as the crowning efforts of English taste and art! Faugh! “Consider the lilies of the field.” Do not let workmen mistake me. I do not advocate servile imitation of nature. Mere imitation, be it ever so clever, is not art; it is the imitation of the monkey, not the man’s rendering of nature’s creation. True art is this:—That a man shall endue his rendering of nature with the stamp of his own individuality of feeling, influenced by his own acquired knowledge, with his own originality of conception, his own light and shade, his own sentiment, his own telling of a sublime story in nature’s words, with a pen or pencil steeped in his own vehicle, which shall hold spellbound those who care to prepare their own souls to receive its great message.

Another cant phrase, often in the mouths of those who think not at all, refers to a peculiar style called *impressionism*. Impressionists slur and blur their work until all form is lost in absolute indefiniteness, colour alone being left to tell the story; and very often the colouring is as indefinite as the form, or, rather, the absence of form. I can only regard this “school,” as it is termed, as *art intoxicated*, so drunk as to blend one idea into another in an incoherent fashion utterly foreign to nature, and, therefore, to art. Nine out of ten of the “impressionists” cannot draw an outline decently; those who can, have only to finish a drawing and then soak it with water and let the colours and form run at their own sweet will into one another by capillary attraction, and they will produce a much better “impressionist” drawing than its proud professors. Impressionists in oil can readily produce their nondescript effects by putting in pure, but extraordinary and eccentric, colours, utterly untrue to nature, at one sitting, and afterwards, before drying, scumbling over all so as to blend everything together. And this is “Art,” forsooth! No! but it is Fashion. It is the outcome of competition. It is one of the penalties paid for attempting to educate “hewers of wood and drawers of water” up to the level of leaders of the art education of the people.

It must not be supposed that I am seeking to depreciate Japanese designs and to discredit those who frequently adapt them to their own purposes, and use them with good effect. I merely enter a protest against too servile an imitation of them. Many contributors to WORK have used them with good effect, and will doubtless recur to them again to the benefit of its numerous readers.

MODERN FORGING.

BY J. H.

BARs: ROUNDS, SQUARES, AND FLATS—MAKING UP FIRE—FIRING TOOLS—TONGS—CHISELS.

IN the judicious choice of that which is the best method out of several possible, lies much of the skill of the experienced smith. For it by no means follows that a method by which a piece of work can be forged to shape, is necessarily the quickest, cheapest, or best; or that what may be the best method in any given circumstance is also the best under circumstances of a different character. And often a man will perforce have to adopt some method which he knows is not the best from a craftsman’s point of view, because he either does not possess the iron of proper section, or the tools, or other assistance necessary.

This fact is brought home forcibly to us when we consider the numerous sections of iron required by the all-round smith. Even in large shops, where several men are employed, and steam hammers are available, it is often impossible to manipulate the heavier sections of iron. For these, very powerful hammers are required, in order that the force of their blows shall penetrate to the interior of the mass. Hence many engineers find it necessary to order for massive work specially heavy forgings, or “uses,” as they are called at the rolling mills. And every smith is thus subject to limitations in the sections which he can make use of, by the power as well as by the assistance at his command.

The stock-in-trade of a smith who works single-handed, and that of an amateur, must needs be limited to small sections. With a small forge no great heat is possible, and a man working single-handed cannot manipulate any heavy sections. Then, again, bars of iron are made in lengths of several feet, and the purchasing of a fair stock of entire bars of several sizes would prove a heavy expense. It is best then to select a few entire bars of the most useful dimensions according to the class of work which it is intended chiefly to do, and when any other sections happen to be wanted, to purchase them in short lengths of some friendly local smith, or iron stores.

The principal sections of iron used by the smith are “round,” “square,” and “flat” bars. These are made in almost all minute fractions of ordinary dimensions, and in different qualities. The Earl of Dudley’s brands are among the best known in this country, and I will therefore here make use of the published list of sections rolled at his immense iron and steel works.

The round bars are rolled in the following W.G. sizes, 7, 6, 5, 4, 3, 2, 1; and in diameters ranging from $\frac{3}{16}$ in. up to 2 $\frac{5}{8}$ in., advancing by sixteenths; from 2 $\frac{5}{8}$ in. to 5 in., advancing by eighths; from 5 in. to 5 $\frac{1}{2}$ in. by quarters; from 5 $\frac{1}{2}$ in. to 6 in. by eighths; and from 6 in. to 6 $\frac{1}{2}$ in. by quarters; and each of these can be rolled to “full,” and “bare,” as well as to exact sizes. Thus there are sixty-eight different diameters of round bar obtainable from $\frac{3}{16}$ in. to 6 $\frac{1}{2}$ in.

The squares advance from $\frac{3}{16}$ in. to 1 $\frac{5}{8}$ in. by sixteenths; from 1 $\frac{5}{8}$ in. to 4 in. by eighths; from 4 in. to 5 $\frac{1}{2}$ in. by quarters; and from 5 $\frac{1}{2}$ in. to 6 $\frac{1}{2}$ in. by half-inches; giving fifty-one sizes in square sections from $\frac{3}{16}$ in. to 6 $\frac{1}{2}$ in.

The flats range from $\frac{3}{8}$ in. to 12 in. wide in almost all thicknesses from $\frac{1}{4}$ in. upwards, advancing by sixteenths and eighths. Flats in sixty-five different widths are obtainable.

These bars are made in four qualities—the “ordinary,” or common, “best,” “best

best," and "best, best, best." The current price of the first is roughly £10 per ton, of the second £11 10s., of the third £13, of the fourth £15. But as in plates, and angle and channel irons, extra prices are charged for bars below or above certain sizes.

I need not enter into such details, but as the extras amount to from 10s. to even as much as £4 and £5 a ton in some few very large sections, and as 10s. a ton extra is always charged for quantities of any iron of less than 5 cwt., purchasers, especially small smiths and amateurs, would do well to consult the price list before ordering indiscriminately.

Good metal being rather costly, a careful smith will preserve all odds and ends of iron and steel for minute work, and for velding on to other portions, so saving the cutting off of small pieces from long bars.

It is not economical to buy inferior iron.

and copper as in many cases to totally and absolutely change appearance and physical qualities. But in wrought iron, where the percentage of foreign ingredients is extremely small, seldom amounting to more than 1 per cent., often ½ per cent. only, those very minute percentages are found to affect the metal to an extent that makes itself very evident at the anvil. The best and most readily forged, whether hot or cold, is that which is the purest. When iron will forge well while hot, but not when cold, the "cold shortness" of this iron is due to very minute quantities of phosphorus, antimony, or silicon. When iron is apt to develop cracks while being forged hot, this "hot shortness" may be due to a minute quantity of sulphur present, whose amount may not perhaps exceed .03 per cent., or it may be due to antimony. Only delicate chemical analysis could demonstrate the

able degree, in the course of a day's work is that central portion. The stock, though highly heated, does not burn away sensibly, partly because it is protected from the direct action of the blast, and partly because the upper portions are kept damp with water. Yet the inner faces, being in direct contact with fuel supplied from time to time to the central part of the fire, are at a glowing heat.

To make a fire, therefore, the stock is first built at the back and front of the hearth, and beaten hard with the slice or with the sledge, the choking of the tuyere-hole being prevented by passing an iron rod temporarily into it. The fire is then lit in the central portions with a handful of shavings and a little coal, assisted by a gentle blast.

The only firing tools necessary are the poker, Fig. 12, A, the slice B, and rake C, whose uses are obvious.

Before we can do any forging at all, tongs

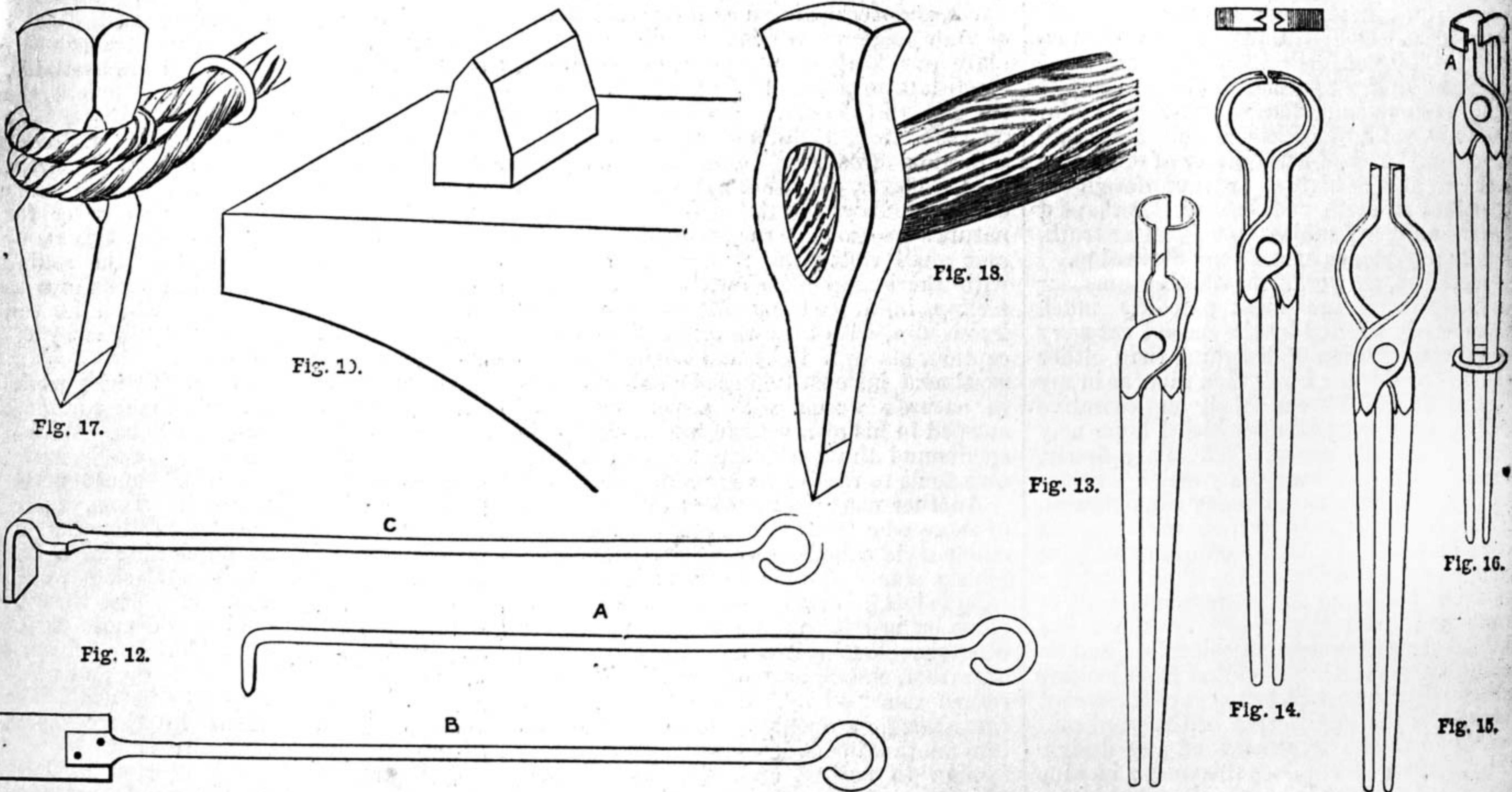

Fig. 12.—Firing Tools—A, Poker ; B, Slice ; C, Rake. Fig. 13.—Hollow-Bit Tongs. Fig. 14.—Pincer Tongs. Fig. 15.—Ordinary Tongs. Fig. 16.—Crook-Bit Tongs. Fig. 17.—Cold Set. Fig. 18.—Hot Set. Fig. 19.—Anvil Cutter.

Though advisable in some classes of common work, it is seldom so for amateurs, nor for men doing the finer classes of work. The quantities used in light work are so small that the saving is scarcely worth taking account of, while the annoyance of producing spoiled or unsatisfactory results is always likely to arise. Inferior iron, like any other inferior material, is a constant source of anxiety to its possessor. The differences in the qualities of iron are broadly these. A good iron is silvery and clean-looking, a bad iron is dull and dirty by comparison. A good iron is free or nearly free from flaws. A bad iron contains these flaws, and they show up when it is brought to a red heat. They are due to the intermixed cinder and scale left by insufficient puddling. The only way to get rid of some of these is to subject the iron to a welding heat, and hammer it thoroughly all over to consolidate it in some degree.

The more the metals and their alloys are studied, the deeper seems our ignorance respecting their qualities. Carbon, manganese, phosphorus, and silicon exercise so vital an influence upon the numerous alloys of iron

presence of these foreign elements, but the smith sees their results under the hammer and punch.

Before beginning work there is a proper and improper way of making up the fire for the heating of the iron.

The "stock" is the term given to the mass of hard-caked coal on a smith's hearth, between which the heat is confined; and it also in some degree forms a reserve of fuel. But its primary purpose is to prevent radiation of the heat, and to cause its concentration upon the work of the hearth. If it were not for the stock too much of the heat would go up the chimney, and the work also would be oxidised more rapidly than it is, by reason of its partial exposure to the air. The size of the stock will evidently be proportioned to the mass of the work, and its shape will be modified by the shape of the work. In an ordinary smith's fire the stock consists of two portions—one lying against the tuyere and hearth-back, the other placed opposite to the first in the direction of the coal and water bunks, the work lying mid-way between the two. The only portion of the fire that is replenished, at least to any consider-

are necessary. There are two or three dozen tongs to a moderately well-appointed forge, but it is not necessary to get them all at once. I will, therefore, figure and describe a few of the simpler tongs that we shall have occasion to make use of immediately, leaving some of the others to be noted later on. I may mention, once for all, that each of these tools is made in several sizes to suit the character of the various kinds of work done.

Fig. 13 shows the hollow-bit tongs, used for holding rods and bars of iron. Enclosing and gripping the rod for a length of 2 or 2½ in., they take a very firm hold of it. When there are collars or other expansions at one end of a bar, the pincer tongs (Fig. 14) are sometimes employed to enable a firm grip to be taken; the jaws are veed, as shown in plan. But the tongs in Fig. 15 are more generally useful, because owing to the elongation of the V-shaped jaws the grip is stronger, and the rod or bar less liable to shift sideways.

When a bar is so long that it cannot be held with these tongs, a cranked tool (Fig. 16) called crook-bit tongs, is used. The jaws being turned round to one side permits the

bar to pass down to one side of the pivot, alongside the handles. The lip A serves to retain the bar in place, otherwise it would be apt to slip out sideways. With these four types we can commence work on round rods and square bars of iron. For flat iron, punched, and other work there are other forms which will be noticed in due course. The ring shown encircling the handles or reins of these tongs is called a "coupler." By its means the handles are tightened, the coupler being slid over them; and owing to their tapered form a tap or two with the hammer tightens the coupler on the handles. The work is thus grasped without need of any further effort on the part of the smith, who can devote his whole attention to its manipulation on the anvil.

Before we can cut off a bar we want one or two chisels, or "sets," as they are called. To cut a bar cold it is nicked round with a chisel (Fig. 17), ground comparatively thick and called a "cold set." The bar is laid across the anvil with the chisel-edge upon it, and the chisel being struck with a hammer nicks the bar. The bar is rotated slightly and another blow struck, and so on rapidly until there is a sharp indentation of the bar all round. Then it is struck sharply across the edge of the anvil and snapped in two at the nicked section.

If a bar is divided while red-hot, a

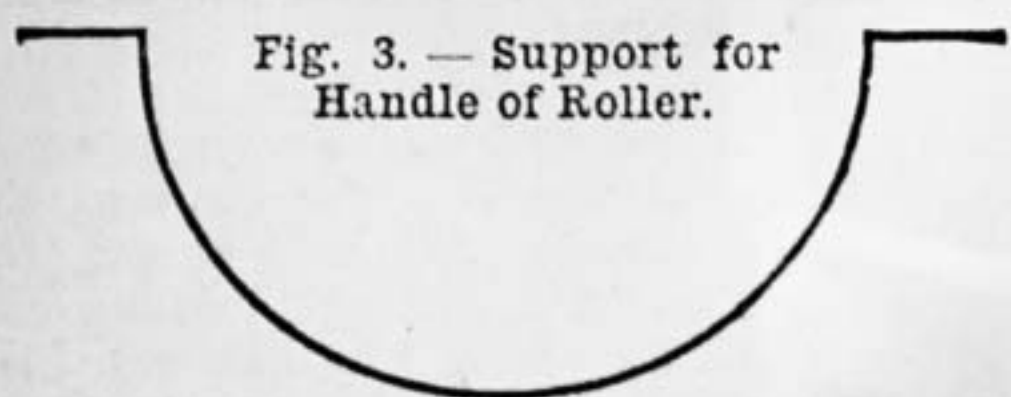

set ground comparatively thin (Fig. 18), and called a "hot set," is used, and the smith holds it in place while the hammer-man strikes it. But in this case the bar is more than nicked. The set is driven in deeply and several blows are given at one spot, the set penetrating deeply before the bar is rotated; and by the time it has been turned completely round the set has almost or entirely severed it.

If the bar is of only moderate dimensions the set becomes so hot that it would lose its temper altogether, and become soft. But after every four or five blows the smith dips it into water to cool it, and then goes on again. Often, but not invariably, the hot sets are handled differently from the swages. Sometimes, like the swages, they are provided with iron handles, or with withy handles like Fig. 17. But because they are subjected to more heat than the swages they are often handled as in Fig. 18; that is, like hammers, but without wedges. The wedges would be of no use, because they would shrink and become loose, and they are not necessary in the sets. For when the handle becomes loose, just striking its butt end upon the anvil jumps the set down to a firm hold, ready for immediate use. There are several other tools, as gouges and flatters, similarly handled with wood.

If a smith is working single-handed, then the anvil cutter is used for nicking bars. It is essentially a chisel (Fig. 19), having its edge uppermost and fitting into the square hole in the anvil by means of a square shank. When, therefore, a bar is laid upon it and struck with the hammer, the effect is to nick the under side of the bar, and rotating and striking it with the hammer will have the effect of nicking it circularly.

A HOME-MADE GARDEN ROLLER.

BY W. H. WOODWORTH, F.C.A. (IRELAND).

HAVING need for the use of a garden roller, and not caring to go to the price usually asked for such an article, I set to work to devise something which, if not as good, might still be a fair substitute for the commodity in question.

As I have been successful in turning out an article which does all that a roller is required to do, I shall, without any further

Fig. 1.

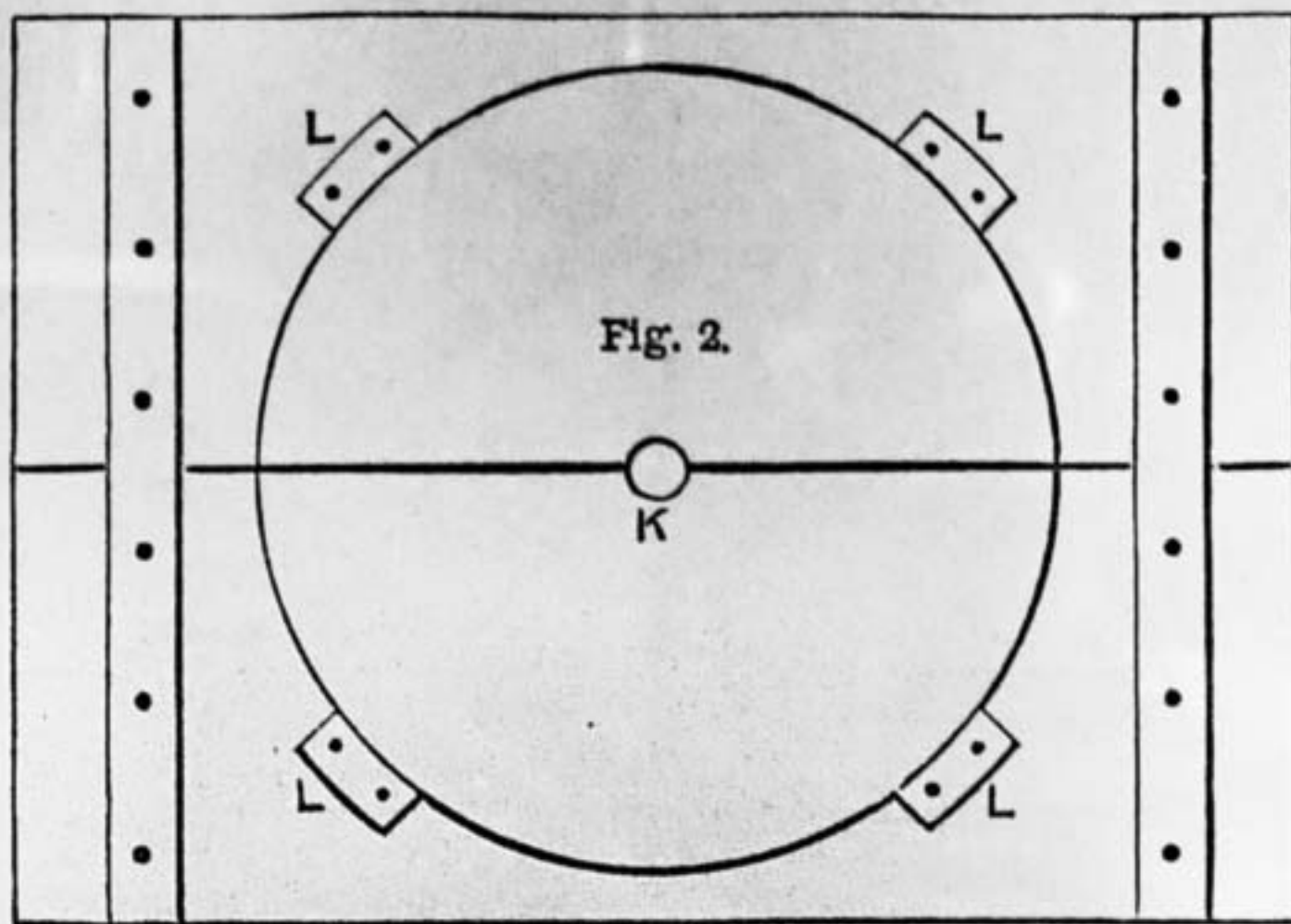
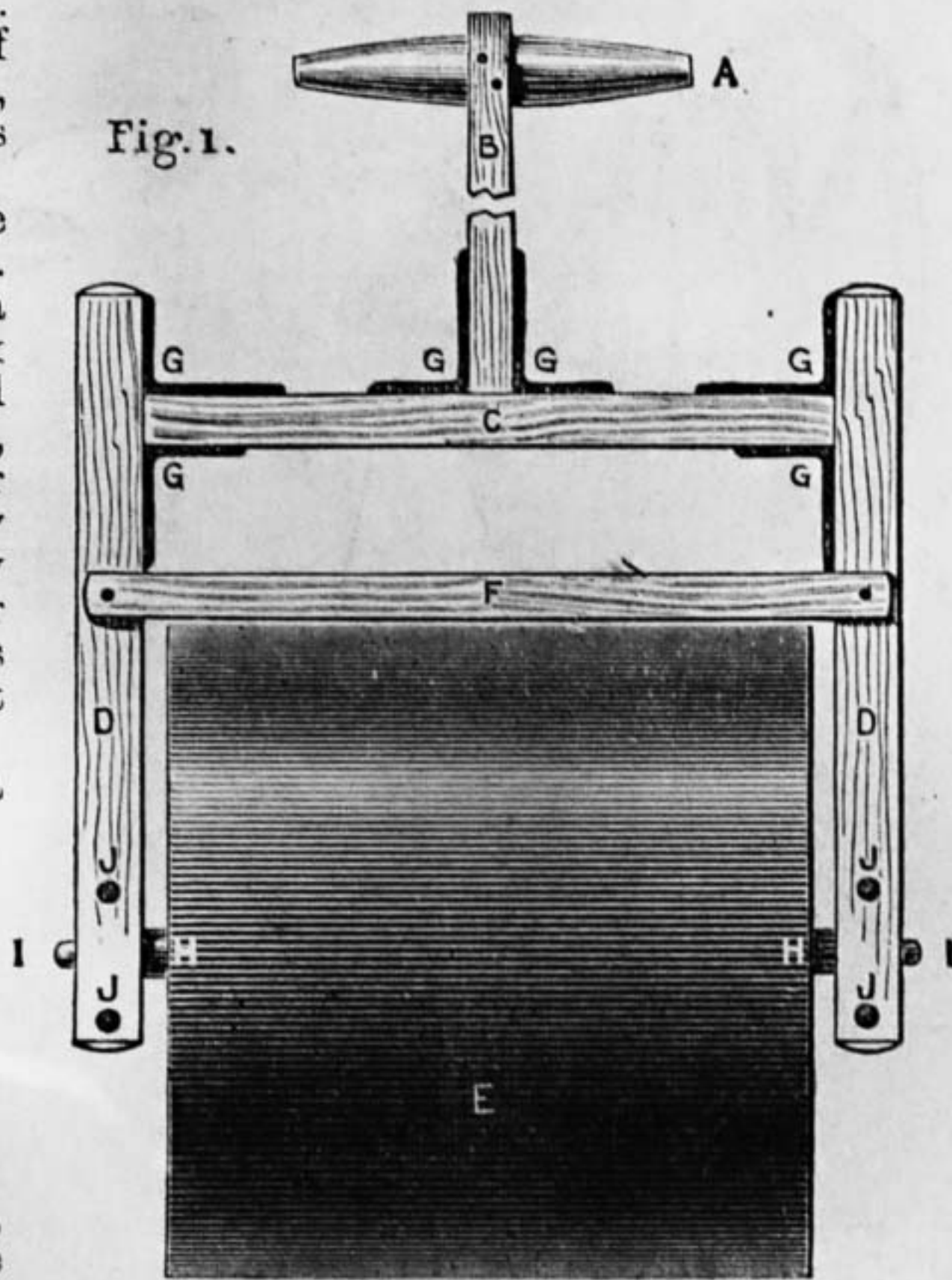

Fig. 1.—Garden Roller in Plan. Fig. 2.—Platform on which to build Roller. Refs. to Letters—A, Handle; B, Handle Bar; C, Cross Bar; D, Side Pieces; E, Roller; F, Scraper; G, Angle Pieces; H, Gun Barrel; I, Ends of Axle Bar; J, Bolts and Washers; K, Hole for Barrel; L, Oak Stops; M (Fig. 4), Hole in Frame to take Axle.

preface, describe the process by which I accomplished my object. I may say, at the outset, that any one having the slightest practical knowledge of the use of tools will be able to complete a similar one to his satisfaction.

Materials Required.—A sewer pipe, 17 in. long, diameter 14 in., $\frac{3}{4}$ in. thick; a piece of gun barrel, 19 in. long, diameter $1\frac{1}{4}$ in.; an iron bar, 25 in. long, and of sufficient diameter to allow it to work freely inside of gun barrel; six wrought iron angles such as are used in supporting shelves; four $2\frac{1}{2}$ in. bolts and washers; some well-seasoned oak battens, 1 in. \times $1\frac{1}{2}$ in.; some steel laths such as are used to form lattice support in iron bedsteads; two deal boards, 3 ft. \times 9 in. \times

1 in.; Portland cement, gravel, stones, etc.; some strong inch screws and washers.

Having all my supplies ready, I made a rough platform (Fig. 2) of the inch boards battened together, on which to build the roller; on this I rested the sewer pipe on end, and, having drawn its external outline on platform by running a carpenter's pencil round it, I proceeded to find the centre of the circle thus formed, in which, with a bit and brace, I bored the hole K. Placing the pipe once more in its former position on the platform, I nailed pieces of wood at four points round it, L, to prevent it from shifting from its position, and placing the gun barrel (H, Fig. 1) with one end inserted in the hole (K, Fig. 2) in platform, which it fitted tightly, I secured the other end so as to be truly in the centre of sewer pipe, and filled in to about 4 in. deep with good concrete (one part best Portland cement to two parts of well-washed river gravel).

After leaving this for a day to set, I filled to within four inches of the top with rough stones—small lumps of rock, and completed filling to the top with concrete, same as at bottom, ramming it thoroughly down, and finishing off smooth with a trowel.

When this had set I had a roller (to all practical purposes of solid stone) weighing about $1\frac{1}{2}$ cwt., having an iron tube running

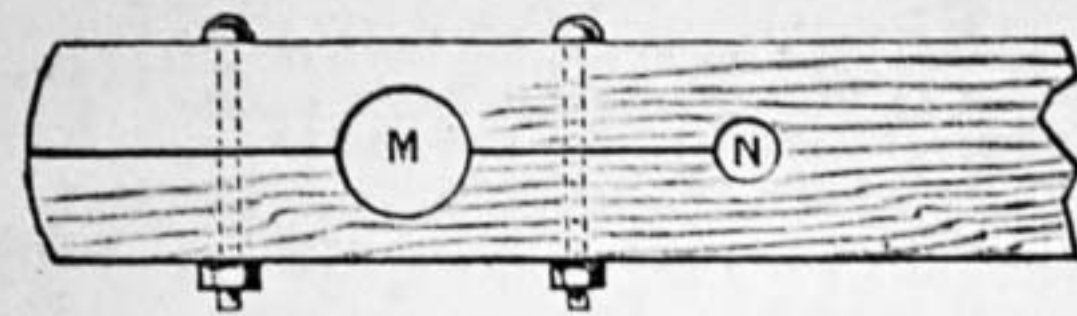

Fig. 4.—Mode of fitting Axle to Frame.

through its centre and protruding about an inch at each end.

To this I mounted a simple carriage, consisting of two side pieces, 18 in. \times $1\frac{1}{2}$ in. \times 1 in.; one cross-piece, 21 in. \times $1\frac{1}{2}$ in. \times 1 in.; one handle bar, 17 in. \times $1\frac{1}{2}$ in. \times 1 in.; one handle, 10 in. \times $1\frac{1}{2}$ in. \times 1 in., tapering towards both ends, which were rounded off.

All these parts I joined together simply by the iron angle pieces, and a reference to Fig. 1 will show better than any description the manner in which this was done.

A reference to Fig. 4 will show how I secured the ends of iron bar axle on which the roller was to turn.

One and a half inch from the extremity I bored, with a bit and brace, the hole, M, which should be slightly smaller than the bar to be inserted in it. One and a half inch from this I bored a second hole, N, of about half the diameter of the first (the object being to prevent the wood splitting during the operation of mounting), then, with

a saw, I cut through the centre till I reached the smaller hole. I then wedged open this slit until the centre hole, M, was wide enough to admit of the iron axle passing easily through it.

This being accomplished, I completed the mounting of the roller by passing the bar through the hole, M, in one side of the frame, then through the centre pipe of roller, and finally out through the other side of frame. Knocking out the wedges, I tightened up and secured both ends of the axle with bolts and washers, as shown in Fig. 4. I may say that I inserted between ends of tube and sides of frame a couple of loose washers, to reduce wear and tear.

The roller and carriage were now com-

plete, with the exception of scraper and support, which I subsequently added.

This scraper is simply a piece of steel lath, 23 in. long × 1 in. wide, secured to side of frame at each end by screws and washers. Its object is to remove anything which might stick to the surface of the roller when being used in wet weather, and its edge should be sufficiently close to allow the roller to pass freely without actually touching it.

The support consists of a similar piece of steel, shaped as shown in Fig. 3, and secured to cross-bar by screws and washers. Its object is to keep the handle from coming in contact with the ground when not in use. Our roller is now complete, and nothing remains but to paint or stain and varnish it according to taste.

The roller of which the foregoing is a description I have had in use for over two years, and it has given thorough satisfaction.

OUR GUIDE TO GOOD THINGS.

Patentees, manufacturers, and dealers generally are requested to send prospectuses, bills, etc., of their specialties in tools, machinery, and workshop appliances to the Editor of *WORK* for notice in "Our Guide to Good Things." It is desirable that specimens should be sent for examination and testing in all cases when this can be done without inconvenience. Specimens thus received will be returned at the earliest opportunity. It must be understood that everything which is noticed, is noticed on its merits only, and that, as it is in the power of any one who has a useful article for sale to obtain mention of it in this department of *WORK* without charge, the notices given partake in no way of the nature of advertisements.

30.—BRITANNIA COMPANY'S NO. 12 DOUBLE-GEARED MILLING MACHINE.

ALTHOUGH the majority of readers of *WORK* may find the smaller and less expensive articles that are mentioned from time to time in "Our Guide to Good Things" more generally useful and attractive, yet as the tools and machines and appliances of all makers who wish mention to be made of their specialties must perforce be noticed, I call attention in the present number to three pieces of useful machinery manufactured by the Britannia Company, Col-

chester. The powerful machine—the Company's No. 12 Double-Geared Milling Machine—illustrated in Fig. 1 is so clearly shown in all its parts that it needs but little description. It is suitable for the general requirements of an engineer's and machinist's shop. Headstock, body, and base are cast in one piece, the body being hollow, and forming a receptacle for cutters, etc. The spindle of headstock is of steel with conical neck, running in hard gun-metal bearings. The back gearing

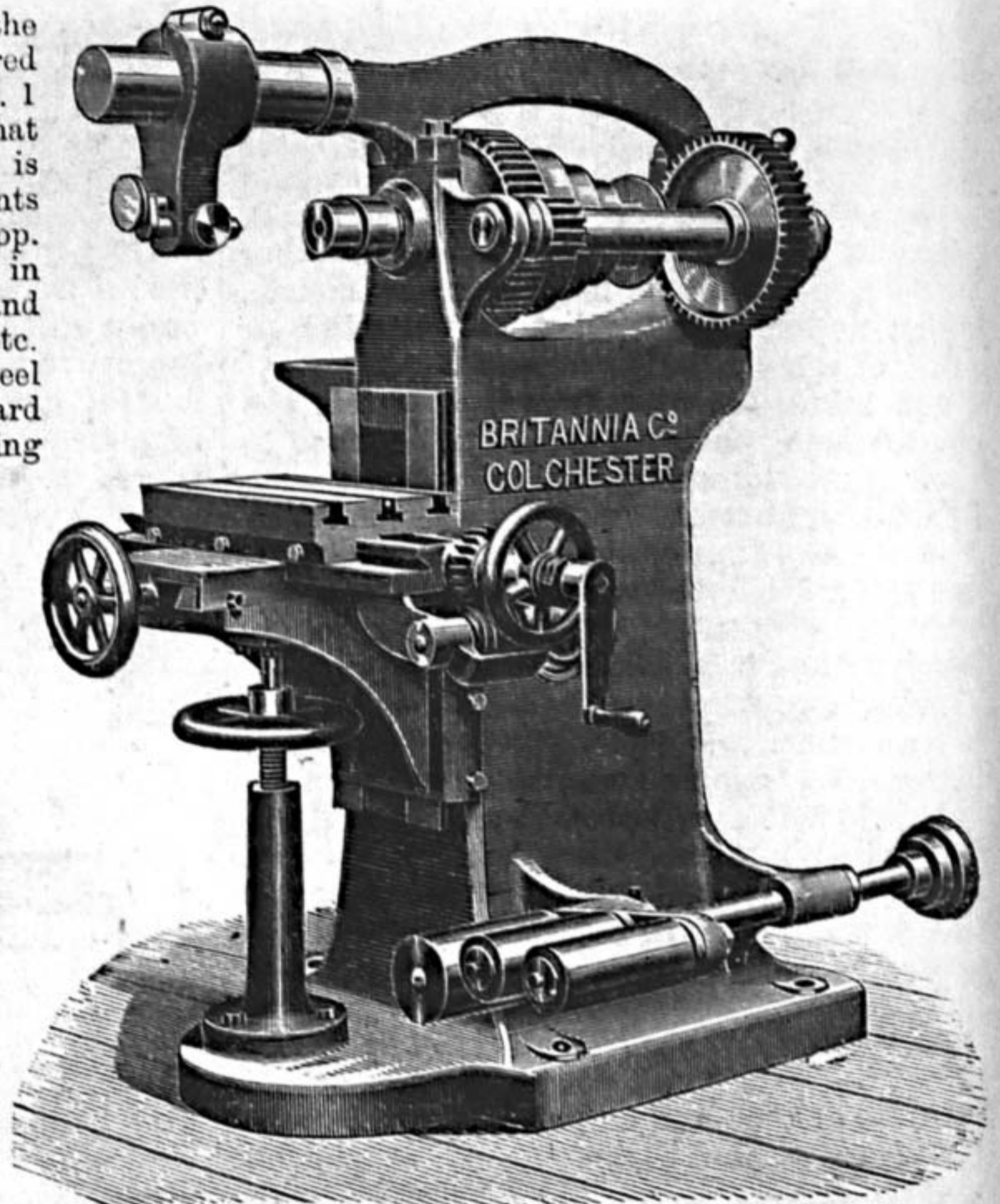

Fig. 1.—Britannia Company's No. 12 Double-Geared Milling Machine.

carrying a bracket which swivels entirely round it, and carries a circular work-plate, which also swivels on its own centre, giving every facility for adjusting the work bolted to it under the drill. It has two driving shafts, that for the treadle or power running to the back, and that for hand motion to the right side, and these drive the spindle by bevel and spur gearing. It has single and double gearing for small and large holes, and has both self-acting and hand feed. The treadle driving gear is made independent of the machine to fix under the bench, the wheel having four speeds to drive the speed cone fitted to the driving shaft, thus giving with the double gearing eight changes of speed. The pillar is 4 in. in diameter and 11 in. high; the diameter of spindle is $\frac{3}{4}$ in. drilling up to $\frac{3}{4}$ in. in diameter and 5 in. in depth, the distance from drill point to pillar being 5 in. The diameter of fly wheel is 18 in., of driving wheel of treadle motion, 20 in. The circular table is 10 in. in diameter, and will rise and fall $6\frac{1}{2}$ in. on pillar. Price, as hand-drill, only £6 10s.; as hand and treadle drill, £8. Top-driving apparatus for power driving can be fitted for £2. It is illustrated in Fig. 2.

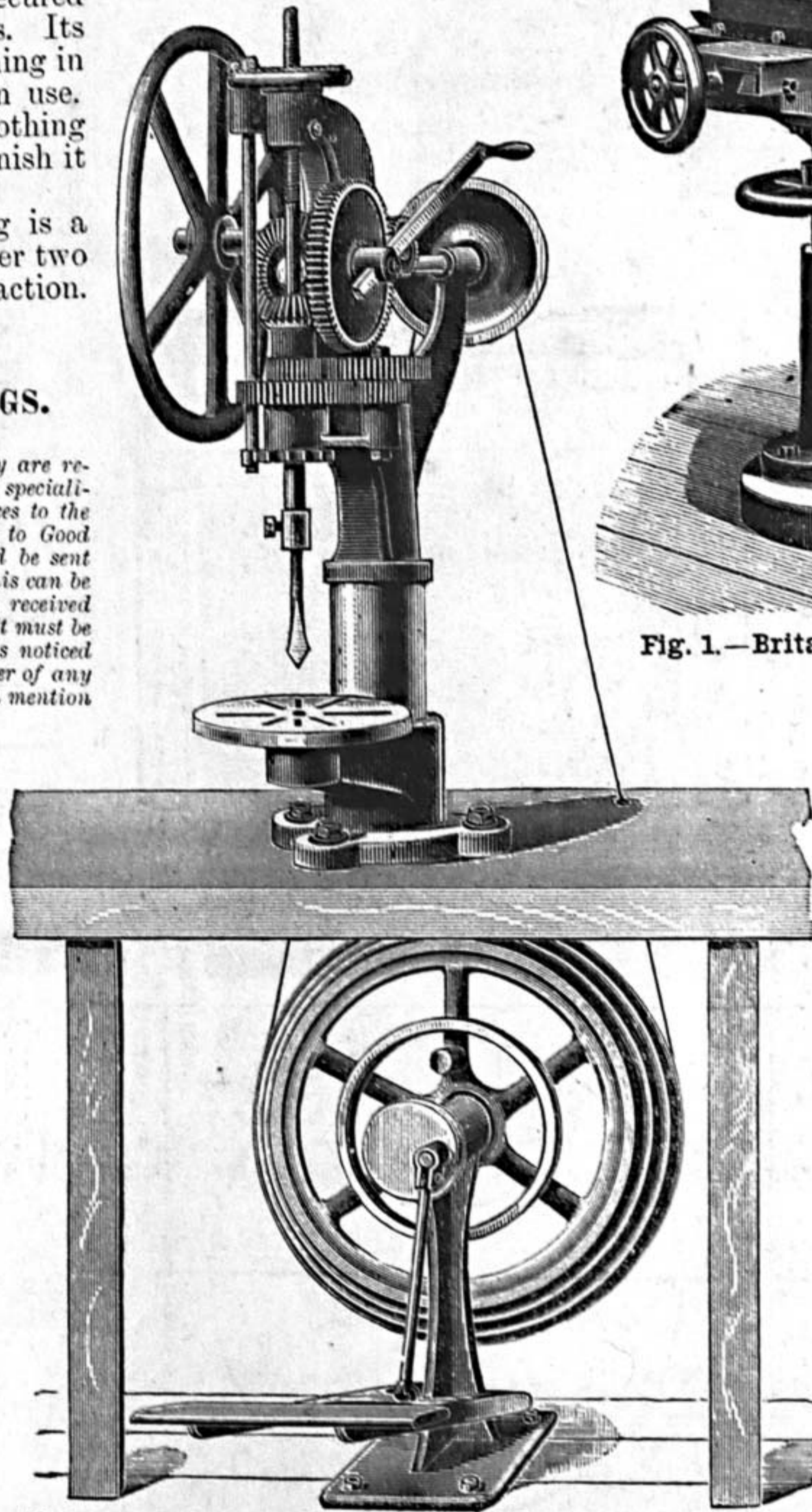

Fig. 2.—Britannia Company's No. 5 Bench Drilling Machine.

is put in and out of gear with eccentric motion. The knee slide is fitted to the front of body, and rises and falls 14 in. The longitudinal slide is 24 in. long and $7\frac{1}{2}$ in. wide, and has a transverse traverse of $7\frac{1}{2}$ in. The work-table is 14 in. long and $8\frac{1}{2}$ in. wide, with T-slots

planed out for fixing the work. It has a longitudinal traverse of 18 in. The entire machine, which is fitted and finished in a superior manner, is 4 ft. 4 in. high, 3 ft. wide, and 4 ft. deep; and its price, including top driving apparatus, is £45.

31.—BRITANNIA COMPANY'S NO. 5 BENCH DRILLING MACHINE.

This handy drill for light work can be driven by hand or by treadle, or both combined, and it can be driven by power if desired. It is constructed with a web section body, turned to fit on to and swivel round a stiff turned pillar, cast with a strong foot to bolt on to the bench,

32.—BRITANNIA COMPANY'S NO. 6 NEW PORTABLE RADIAL DRILLING MACHINE.

This machine is intended to take the place of the old ratchet brace, and is well adapted for bolting to locomotive frame-plates or similar work for drilling and reaming holes up to $1\frac{1}{2}$ in. diameter by 4 in. deep. It consists of a strong steel tubular pillar forged on to a wrought iron slotted foot, as shown in Fig. 3, capable of being turned to any desired angle, and capable, when bolted in position, of drilling all holes within a radius of 18 in. from centre of pillar. The steel spindle is $1\frac{1}{2}$ in. in diameter, driven by strong gearing, arranged to drive either from a swinging counter-shaft, as used in locomotive shops, or from a fixed counter-shaft, if desired. It has both a variable self-acting feed and hand feed. The drill will rise and fall on the pillar for 18 in. The bevel and driving gear is $\frac{3}{4}$ in. pitch. Prices, for swinging counter-shaft, £22; for fixed counter-shaft, £27; counter-shaft to sink, if required, £2 10s. This machine, as well as the other two noticed above, is well made and carefully finished. THE EDITOR.

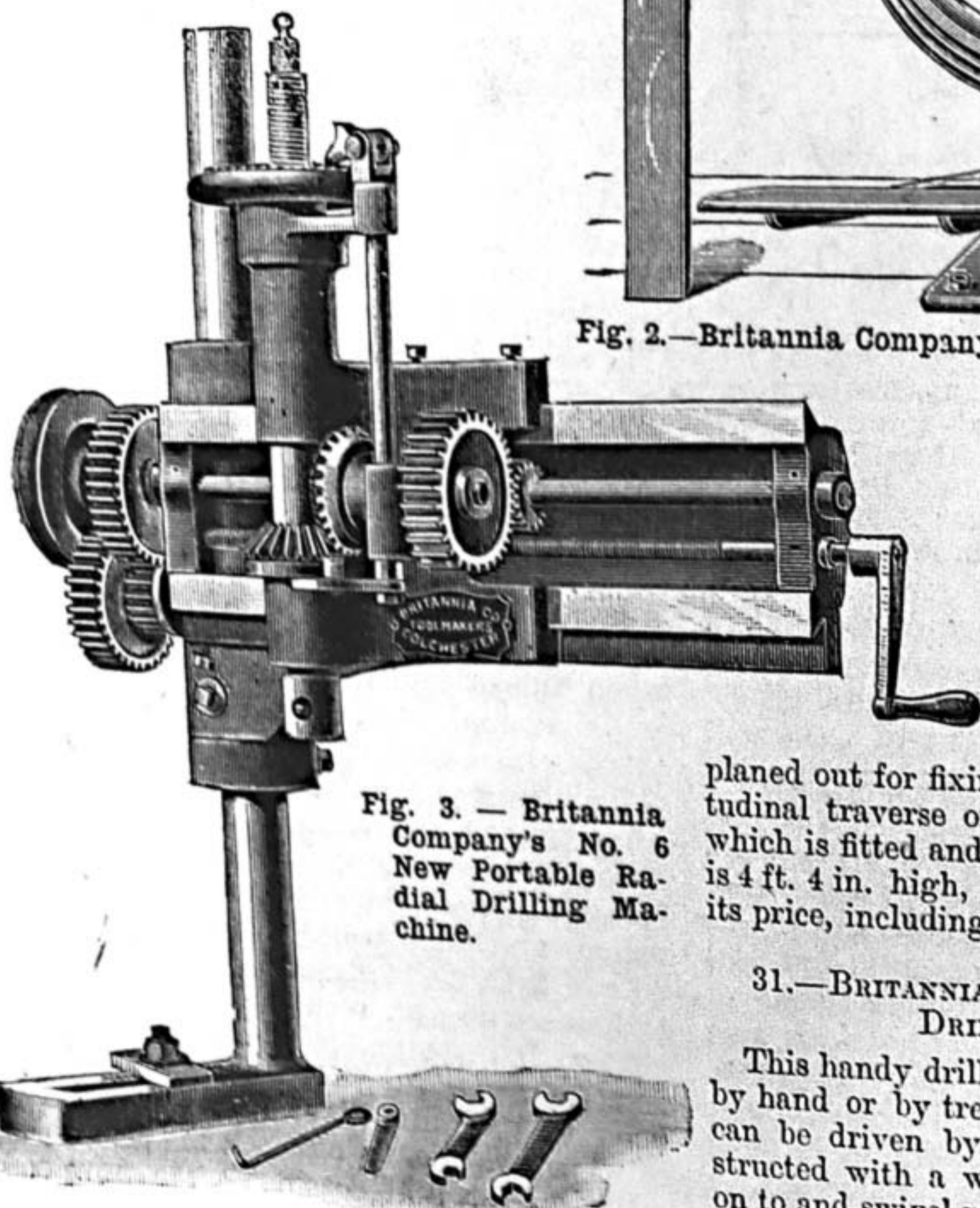

Fig. 3.—Britannia Company's No. 6 New Portable Radial Drilling Machine.

SHOP:

A CORNER FOR THOSE WHO WANT TO TALK IT.

NOTICE TO CORRESPONDENTS.

In consequence of the great pressure upon the "Shop" columns of WORK, contributors are requested to be brief and concise in all future questions and replies.

In answering any of the "Questions submitted to Correspondents," or in referring to anything that has appeared in "Shop," writers are requested to refer to the number and page of number of WORK in which the subject under consideration appeared, and to give the heading of the paragraph to which reference is made, and the initials and place of residence, or the nom-de-plume, of the writer by whom the question has been asked or to whom a reply has been already given. Answers cannot be given to questions which do not bear on subjects that fairly come within the scope of the Magazine.

II.—QUESTIONS ANSWERED BY EDITOR AND STAFF.

Timber Frame.—J. R. (*Idless*).—You must understand that a roller feed log frame is not suitable for English-grown timber, but the rack log frame is. In the roller feed very crooked timber cannot be sawn, but with the rack feed both crooked and straight may be sawn. For converting logs into thick planks, the rack circular saw bench is the quickest, if the saw is large enough to span the piece to be sawn. For very large logs a very large saw is needed, which will require a deal of power to drive it, and a good practical man to sharpen and to work the saw. If J. R. intends cutting logs above 22 in. deep, I would recommend the rack log frame, but if below that depth the rack circular saw bench will suit his purpose best, and will do a greater amount of work in a given time, providing he has plenty of power to drive it and a good man to keep saws in order and to work them; for it must be understood that more skill is required in the working and sharpening of circular saws than in frame saws. Write at any time in reference to working or fixing saw-mill machinery, and I will do my best to give a satisfactory answer.—A. R.

Dulcimer Stand.—F. W. (*Doncaster*).—With reference to the stand about which F. W. asks, it is used, as he aptly puts it, to "rear the back end up" when playing, so that the upper notes of the instrument may be brought more easily within reach, and also to facilitate striking the notes clear of each other. Music, wire, and all other fittings, as well as instruction books, may be purchased of Messrs. Chilvers & Co., St. Stephen's, Norwich.—R. F.

Tinman's Pattern Book.—G. J. P. (*Manchester*).—There is such a book as you mention; it is called the "Sheet Metal Worker's Instructor," and gives full directions for striking out the various patterns required in that and kindred trades. I have not seen it, but have heard it spoken of very favourably. The price of it is 10s. 6d., and it can be had of the author (or his successors, for I believe he is dead), R. H. Warne, 94, St. Augustine's Road, London, N.W. The articles on sheet metal working will be continued in due course.—R. A.

Teeth of Wheels.—TANCRED (*Liverpool*).—You will find the information you require in full detail in an article on toothed gearing, by Francis Campin, C.E., printed in our issue of November 30th, 1889, page 581, Vol. I. No algebra is used, and the illustrations make clear the method described.—F. C.

Work Numbers and Index.—B. J. (*London, W.*).—All back numbers of WORK can be obtained through any bookseller, or upon application to the publishers, Cassell & Co. (Limited), London, E.C. An index of Vol. I. of WORK is ready, and can be had of any bookseller, price 1d.—F. J. C.

Publications.—J. R.—"Mineral Water Trade Review" is published by J. G. Smith, 165, Queen Victoria Street, London, E.C. Britten's "Watch and Clock Makers' Handbook," price 5s., is published by Spon & Co., 125, Strand, London, W.C.—F. J. C.

Gesso Work.—C. B. (*Highbury*).—A former paper on this art appeared in WORK, No. 25, which gives full particulars concerning the materials and the method of working. Gesso composition and tools can be obtained at the studios of the

Society of Artists, 53, New Bond Street, W. C. B. would do well to get No. 25 of WORK, and the two other papers on the subject that followed.—E. C.

Lending Library.—J. B. (*Tiverton*).—It would not be possible to give effect to your scheme. If you have the desire to interchange books, I have no doubt that an advertisement to that effect in our "Sale and Exchange" column would bring you into contact with any others of the same mind as yourself. Try such a step.—F. J. C.

A Simple Incubator.—WHATELEY (*Birmingham*) asks:—(1) What is the best kind of oil to use for the lamp? (2) Should the eggs be turned, and what temperature maintained during the process of incubation? (3) How long is it before the eggs are hatched?—(1) Any kind of oil will do for the lamp—either paraffin or colza; but the latter is safer in the event of an accident. (2) Yes; the eggs should be turned, and a temperature from 103° to 106° kept up. (3) With hens' eggs you may obtain results in about three weeks.]

Looking Glass.—LANE (*Nottingham*).—I send you a sketch which, I think, will give you what you want, viz., something to match the first prize bookcase I made for WORK (see pp. 695, 696, Vol. I.). You will notice that the shelves at the sides are

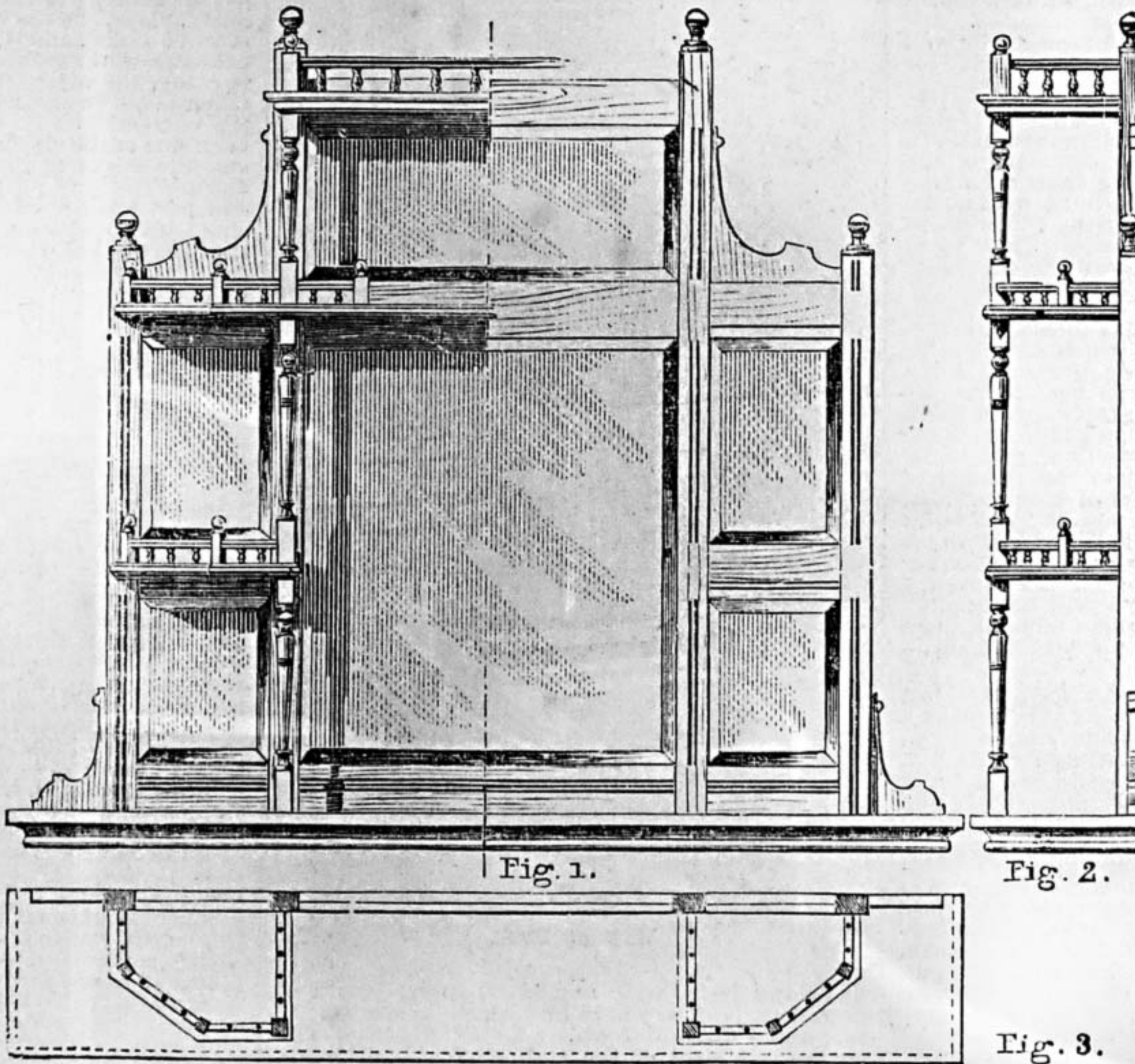

Fig. 1.

Fig. 2.

Fig. 3.

Looking Glass.

very similar, with the difference that, not having the sides of case to support them, I have substituted turned columns. The two bottom shelves could easily be supported on brackets, and the columns going from these upwards; this would have the advantage of leaving the mantelshelf clear of any obstructions; but for my part I always prefer to run a standard of some sort down to the mantel if possible, to obviate the appearance of the upper part falling towards you. The top shelf is retained, but, instead of having a cove under it, it is supported simply by the turned columns mentioned above. The plainness of the shelf directly over the large square is relieved by a short piece of gallery rail at each side. I have purposely made this sketch rather plain, with the object of giving you the opportunity of adding any ornamentation, etc., as you feel inclined.—E. D.

Barnes's Foot Power Saws.—H. B. (*Carlisle*).—W. F. and John Barnes & Co., of Rochford, Illinois, U.S., America—English importers of Barnes and other American machinery, Churchill & Co., 21, Cross Street, Finsbury, London, E.C. Their catalogue is admirable, and contains illustrations of many American tools and much interesting information.—F. A. M.

Pinhole Camera.—WELLWISHER.—If you have read the article on "Pinhole Photography" in No. 17 of WORK, I do not understand what instructions you can want to enable you to make a camera for this kind of photography. All you require is a box and dark slide to hold the plate. In the front of the box the "pin hole" takes the place of the ordinary

lens. If after you have read the article above referred to, and cannot manage to make the camera (3), let us know on what points you want advice, and we will see what can be done to help you. I am afraid though that any one who wants directions how to make such a simple thing would not be able to use it when made.—L. J. P.

Foreign Stamps.—ERNEST (*Longton*).—These are best preserved in a book. If you have not a proper stamp album, you can easily make one from any ordinary note or manuscript book. Cut out every third page all but a margin about an inch wide; this is to counterbalance the thickening of the book when the stamps are inserted. Now head the different pages, arranging the countries in alphabetical order, taking those in Europe first, then those in Asia, Africa, and America, respectively; remembering that whilst for some countries, such as Greece and Russia, one page is sufficient, for others, as England, France, etc., more are required. By no means paste or gum the stamps in, but proceed as follows: gum some thin paper and allow it to dry—the gum paper often given with postage stamps does capitally—and cut it up into little pieces about 1/4 in. by 1/4 in. Take one of these pieces and double it in half lengthways with the gum outside, stick one half to the stamp, and then the other to the book. By this means the stamps are pre-

served and yet can be taken out at any time without destruction or spoiling, as is the case if gummed in. Arrange the stamps according to their date of issue, or if you do not know this, to their original value, and endeavour to be continually replacing them with cleaner and more perfect specimens to increase their market value.—F. B. C.

Stylographic Pen.—P. J. M. (*Glasgow*).—I cannot give you all details of the interior of a stylographic pen, but I can give you some particulars which may be of interest to you. The holder of the pen is hollow and forms the ink reservoir. The "needle" is fixed inside in some way, but loosely, so that when writing it is pressed back; it is solid and merely serves as a conductor of the ink through the small hole in the point, which is protected against wear by a small nosing of some metal. I do not think an amateur could manage to make a stylographic pen. I have used one for some time and find it a great convenience—in fact, I am using it to write this. My pen cost 5s., and it is quite equal to some of the more expensive—no pun—makes. The feeling when using is more like that of a pencil than of an ordinary pen. It writes all one thickness of line, not light and heavy strokes, and requires to be held upright. It is not conducive to good penmanship.—D. D.

Cleaning Gold Bands.—G. S. (*Nunhead*).—The simplest material I know of for this purpose is liquid ammonia diluted with the same amount of water, and

the way of using it will be by rubbing the lace, with something dampened with it. For example, a soft rag, or better, some soft paper such as tissue paper; the latter should be crumpled up into a compact mass. Before applying either to the lace, squeeze out all the moisture you can, then rub your lace round and round with it carefully, and finish up with tissue paper or a piece of cloth that is quite dry. If you use great care you might do as I should myself, and that is as follows: Moisten a soft brush that has been used for polishing plate with whiting, or else a soft tooth brush lightly charged with whiting, and rub it across a clean piece of wood to remove as much of the whiting as possible, then put a drop or two of diluted ammonia on the brush, and brush the lace tenderly. The things you have to avoid in this latter process are too much fluid and too much whiting, which, if it does fill up the lace, will be a rare bother to get out again. So far the method of cleaning can be applied to lace anywhere, but if it be in the form of braid and is removable, then after the gentle rubbing with whiting and brush it can be rapidly washed with soap and hot water in which some twenty or thirty drops of the diluted ammonia have been added to each half pint of water, and again you must use a soft brush, and do it rapidly; do not let one end soak in the basin while you are doing the other. Finish up by pouring some scalding hot water on it, then shake it and dab it as dry as you can in the folds of a soft cloth, and place it in some warm place where it will be dried gradually, such as an oven, with the door open until it is dry. It may curl or twist a little; if

it does, and you cannot get it straight again when it is replaced, it can be ironed, but the hot iron must not come in contact with the lace. Again, I must repeat that this washing must be done quickly.—H. S. G.

Photographic Lens.—J. M. R. (*Aberdovey*).—If this correspondent wishes a full reply to his queries it is necessary he should learn the business of an optician; he can scarcely appreciate the meaning of his questions if he thinks they could be answered in the limited space of correspondence columns. A photographic lens is essentially an instrument for collecting rays of light and transmitting them in a parallel form on to a sensitive surface. The greater the curvature of the glass the shorter the focus, and *vice versa*. The two principal classes are portrait and landscape. The portrait form gives *exceedingly* sharp definitions over a small area, and has what is usually termed a round field. Whereas the landscape form has a flat field but with less absolute sharpness, thus covering a larger space with a *distinct* image than the portrait form will. The question how to make plates is too ambiguous. There are many kinds of plates, of what kind is information required?—E. D.

Silicine Glass Painting.—W. G. H. (*Liverpool*).—The tint x is a sepia tint produced by dark brown mixed freely with "Silicine" medium. I may repeat that this colour should be especially well mixed with the medium, using a palette knife for mixing, not the brush.—F. B.

Sawdust and Tar.—D. C. D. (*Ireland*).—Undoubtedly there is a way of making such fuel blocks, as the following will show. In the days of the Crimean War small blocks made from such substances, and probably fine coal dust worked in, were submitted as a patent fuel to the Government for sending out to the seat of war. They burnt rather rapidly, however, and were made chiefly for kindling wooden logs for burning in the trenches. At the present day a quantity of blocks of patent fuel are made in the South Wales towns of Swansea, Newport, and thereabouts, which are exported abroad as well as used to a small extent in the United Kingdom. How far the method or processes are patent I cannot say; their size is about 10 in. by 6 in. by 6 in., and these burn for some time, but nothing like so successfully as coal. Coal dust, I believe, is largely used in the making of them. Concerning the chief part of your question, I should think they are turned out without much trouble from the moulds, but whether the latter are of metal, and whether requiring any preparation for ensuring this result, I cannot learn. Personally, I don't think the game will be "worth the candle" in your case, although under some circumstances it might be worth going into experimentally.—F. P.

Bedstead Varnish.—F. W. R. (*Norfolk*).—Most manufacturers of varnish and liquid paints make a cheap and durable class of enamel, or coloured varnish, solely for implements and iron goods, but, as you require it solely for domestic use, a tin of any good maker's enamel would answer. If you wish to varnish it only, "Church," or hard drying copal varnish is the best for such work. It is never advisable to mix dry powder pigment with varnish for such a purpose as you require. Your best plan would be to first wash with soda water and rinse well with clean water, then either paint the bedstead with quick and hard-drying paint, made from the pigment and turps and varnish of equal parts, and finish with a coat of varnish; or else to use enamel ready prepared, but two coats may be necessary in the latter case.—F. P.

Draught Screen.—G. S. (*Paisley*).—There are so many varieties of draught screens that it is hard without clearer questioning to reply distinctly. The ordinary screen of three or four folds covered with some textile may be seen in every upholsterer's window. For a stout one special reversible hinges are sold, but as these are somewhat costly, many prefer to study the humble—or kitchen—clothes horse, and fashion joints of webbing after its pliable yet hardly workmanlike joints. Most screens have an after embellishment of scrap pictures, cretonne, Japanese gold leather paper, or some such stuff. The framework is just a simple skeleton of wood, that is rigid enough to keep its shape, but as light as may be safely chosen. When the frame is covered, take care to prove that your calico or canvas *does* shrink when wet by trying a sample. I remember a large four-fold screen that hung in classic but unnecessary folds when wet size was applied. Use also copper tacks, to avoid the unattractive line of rusty spots, that will certainly attend tin tacks sooner or later. Any more detailed queries will receive careful reply from E. B. S.

Splitting Laths.—P. A. (*Hanley, Staffs.*).—Unless timber is cleft or split at the first and when it is somewhat damp, it is unadvisable to try to split "evenly, small laths about $\frac{1}{4}$ by $\frac{1}{4}$ in." If P. A. can get plasterers' laths or the stuff they are split from, or, better still, see a lath-render at work, by all means do so, but failing these he had better be content with sawn stuff, if he wishes it for kite stand or any similar purpose. The lath-renders use a tool like a chopper, but the handle and the holding are different, and they also require a shield for the left wrist, without which last the splitting tool would perhaps do serious injury to the operator.—B. A. B.

Writing Desk.—PLEASURE AND PROFIT (*London, W.*).—As our favourite "Shop" is always so crowded with applicants, I cannot say so much about this desk as I should like; it is not for the want of attendants, but for the lack of space, that we must be brief. I presume this is the very article you mean by a "desk with sliding shutter to cover drawers inside and to lock up with flap outside." When the drawer (Fig. 1) is pulled out, the shutter slides away from sight, and the flap flies round to the front. To shut the desk the flap is put back into its place and the drawer pushed in. Now it has never been my pleasure to handle one of these articles, although I have engravings of it. I cannot say that I can tell you exactly how they are made to work. It is a very difficult thing indeed to get a manufacturer—unless he is a personal friend—to allow one to examine any of his articles sufficiently to enable one to understand thoroughly the method of their construction. However, if the desired result can be attained it matters little how the article is made; therefore, although I have never seen the inside of one, I have worked out the following description, which, no doubt—as the chances are a "million to one"—will be found to be the correct one, or nearly so. A convenient size will

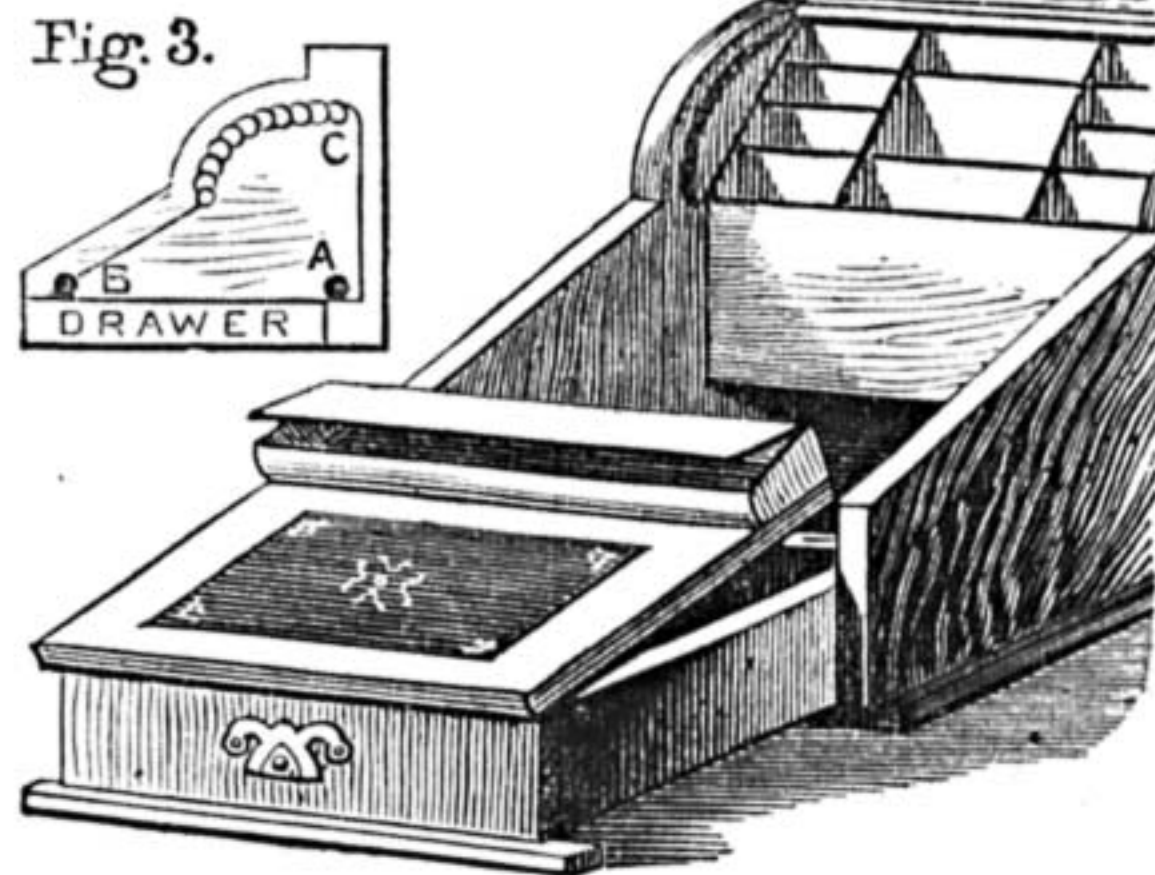
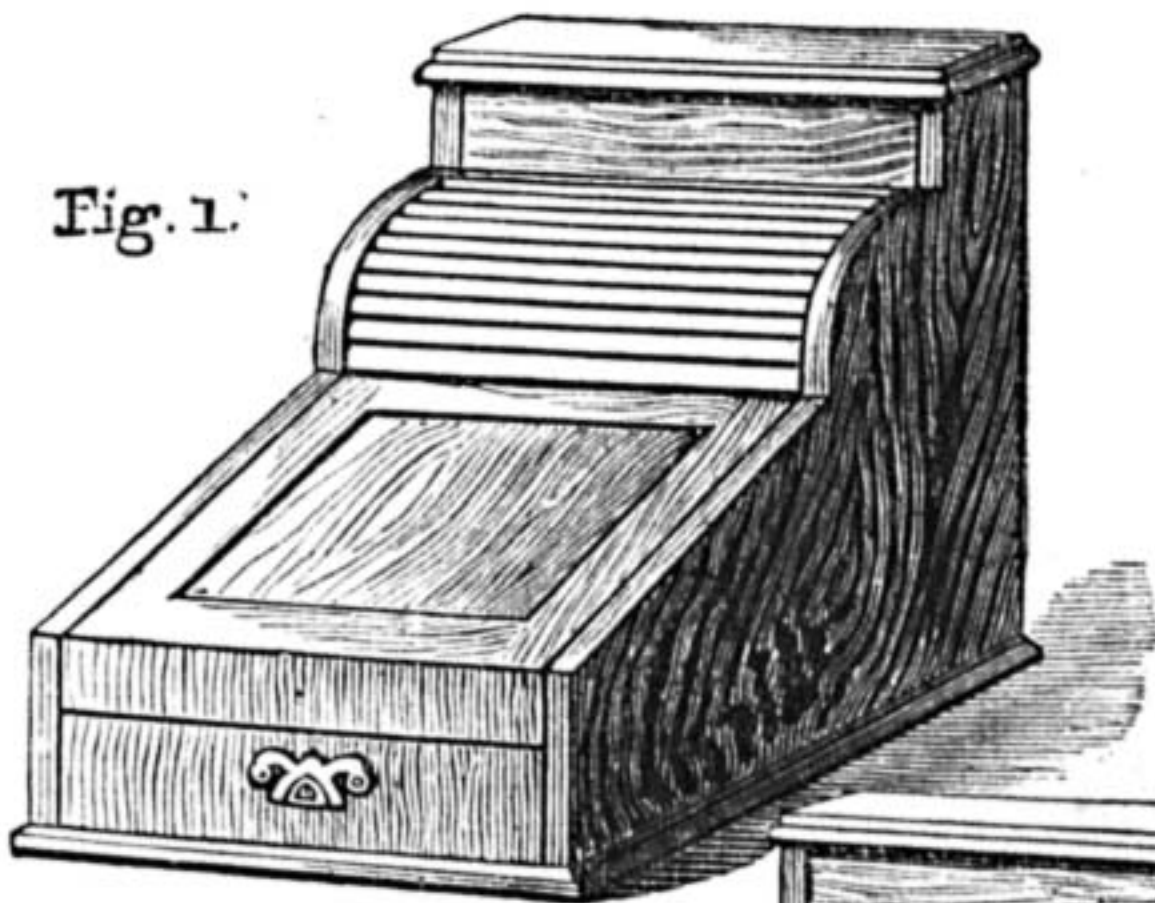

Fig. 2.
Writing Desk.

be: sides, 16 in. wide and 14 in. high; length of flap, 12 in., and width, 10 in.; length of drawer, 12 in.; and width of the entire article about 13 in. The shapes and sizes of the stationery compartments are quite optional; but a clear space of an inch or so must be left at the top, back, and bottom of them. On the inside of the sideboards, round the circular part, at a slight distance from the top edge, runs a groove which is continued down the back (see Fig. 3). For the shutter, several laths, *i.e.*, rather narrow strips of wood, are glued on to a piece of canvas, and work in the above-mentioned grooves. No more laths are necessary than are sufficient to cover the opening. The end lath must be thicker than the others. On the back of this shutter, the ends of two pieces of stout, strong string are attached; the other ends being fastened to the back of the drawer. These strings travel round either a rod, pegs, or wheels, fastened at about points A and C shown in Fig. 3. When the drawer is pulled out it pulls the string and thus pulls the shutter. To close the shutter we want more string; two ends fastened to the front of it; and two to the edges of the drawer near the back. Pegs, wheels, or a rod must be fitted at point B in Fig. 3, for this part of the string to travel round. I should advise you to have the flap merely pivoted or hinged—not made to fly. If made as the latter it will require a spring. As an improvement, I have intended the front piece above the drawer to be fixed to the flap; and with three more pieces and a lid—with a fastening, of course—it will form a neat pen-box. Fig. 2 explains this. A narrow piece of the front of the bottom board should be cut off and attached to the front of the drawer at the bottom; it will then keep the drawer steadier than it would otherwise be. For the making, $\frac{1}{4}$ in. wood would be as suitable as any, with a bottom board $\frac{1}{4}$ in. thick. The stationery box will be made of very much thinner wood. Get the carcass of the job together first; then fix the pegs, wheels, or rods and the string; lastly, fix in the stationery

box. A lock on the drawer will be quite sufficient whether a spring on the flap is used or not. The end of the flap must fit just underneath the edge of the shutter.—J. S.

Carved Wood Impressions.—W. S. (*Mile End*).—You do not say the size of the panels you wish to mould, nor if they are portable or fixed, still less the important point of all, if they are undercut. So in place of a special reply I give the following:—All that is required is some modelling clay, plaster of Paris, and a little oil. No tools are needed, except a penknife, which is used if the cast should require paring. A paper knife may perhaps be added for flattening the clay. Both the clay and the plaster should be of the finest description. The clay costs 4s. per cwt., the plaster 5s. per cwt. Both can be obtained from James Stiff & Son, London Pottery, High Street, Lambeth. The clay should be kept in a crock, and water added when required to keep it in a moist state. When a cast is to be taken, a lump of clay should be placed on a board and cut into slices about an inch thick. This is best done by placing a string round the clay and pulling it through, holding one end of the string in each hand. A great deal depends on the clay being of the right consistency—like putty. If too hard it will not enter the crevices, and if too soft it will stick there. If too soft it must either be left for a night to grow harder, or, if wanted in a hurry, placed in the oven; if it is too hard water must be added, and it must be kneaded to an even consistency throughout. When the slice of clay is ready, the object from which the cast is to be taken must be lightly brushed over with oil, and the clay laid on it and firmly pressed in. The back side of the clay must then be made quite flat, and the edges trimmed with the knife or paper knife. The clay must next be carefully removed and laid upon a board, and a wall of additional clay built up all round, sufficiently high to contain the plaster that will presently be poured in. The dry plaster should now be placed in a bowl, and as much water added as will barely cover it. If mixed up with a spoon it will then be about the consistency of thick cream. It should be at once poured into the clay mould. It will take about twenty minutes to half an hour to harden. It ought not to be touched until it is quite hard, except for the purpose of scratching any inscription which may be desired upon the back. When the clay is removed, it may be found desirable to pare the edges of the cast with the penknife. A coat of stearine, which can be obtained from any chemist, helps to keep the cast clean. The method described applies to ornament in low relief only; objects in high relief have to be cast in pieces, and the process is more complicated.—E. B. S.

Incubator.—D. F. A. (*Winona, Ontario*).—The chief and distinguishing feature of Hearson's "Champion" incubator is the arrangement for regulating the temperature: this is patented, and the full details I do not know. D. F. A. may be able to learn from the following description:—The vital feature of this excellent incubator—the flue—which heats the tank is formed like the letter T sideways, thus —, the lamp being under the upright arm, and a damper is arranged so that the heat is either allowed to pass upwards and away, or if the damper is closed the heat is compelled to pass through the horizontal flue, which thereby heats the water in tank. The movement of this damper is dependent upon the expansion of a thin metal capsule, or lozenge-shaped receptacle, which contains a certain liquid boiling at the required temperature. Our readers will see at once that a contrivance which does not diminish the source of heat, which to a lamp would be difficult and perhaps dangerous—certainly hurtful to its efficiency—but shunts it and gives visible token in the slightly open valve that the temperature is enough and slightly to spare, is exactly what is needed.—B. A. B.

Fixing Brass Plate to Wood.—F. J. C. (*Maidstone*). There are many cements recommended for fixing brass on wood; etc., many of them having been already mentioned in WORK; but our experience has taught us that the best way to make sure of your brass adhering is to use small screws or pins; first drill your holes in the brass, then make a corresponding small hole in the wood with your "brad" so that the screw or pin may not split it. You will find this last longer than any cement, but if you do use cement such as jewellers', etc., the best way is to warm a little and put it on the wood where you want the brass to fit. Then heat the piece of brass and lay it on, when you will be able to force it down into place. Let it cool and chip off the cement all round. If you do not use the pins or screws try plaster of Paris.—M. S. S.

Bookbinders' Materials.—J. R. (*Birmingham*).—The best place to buy bookbinders' presses and sewing frames, or benches as they should be called, that I know of is at Mr. McKinnon's, Carrick Street, Glasgow. We used to get them there long ago, and were always well satisfied. Messrs. Geo. Royle & Sons, Lovell's Court, Paternoster Row, London, also supplies them. If J. R. writes to either of these addresses stating his requirements, I am sure he will get suited.—G. C.

Index to WORK.—F. E. (*Wakefield*) and numerous other readers are again informed that an Index has been prepared, and is on sale as advertised in No. 52 of WORK, and can be had from any bookseller, or from the publishers, Messrs. Cassell & Co. Price 1d.

Windmill Sail Paint.—MILLWRIGHT (*Doncaster*).—The substance you mention, coal tar, is, doubtless, a good one for your purpose. Pitch is used to a considerable extent in the manufacture of certain black varnishes. Most of these preparations, however, are more for ironwork and heated situations than for your purpose, and I am inclined to think there would be some prospect of such a coating cracking and chipping off, from canvas especially. So far as my practical experience and knowledge go, I believe a liquid made from boiled linseed oil and patent (paste) driers would be a far more durable and protective coating for the canvas. Seven pounds of the latter to one gallon of the oil would do. This class of liquid is used to make sailors' oil-skins. You could please yourself about adding any pigment to this.—F. P.

Varnishing and Sizing Oak Frames.—J. B. (*Manningham*).—Give the oak two coats of thin size, then varnish with crystal varnish. If the frames are of flat oak, and are at all dark with age or dust, scrape with a piece of glass before sizing.—F. B.

Patenting an Improvement on an Existing Patent.—HANDYCOME should get a copy of the specification of the existing patent and examine it carefully, and see how far that patent is elastic. It may be that the original patentee has made provision for such an improvement as H.'s, or for a similar one. Should such not prove to be the case, H. should obtain protection for his improvement (simply as an improvement) and then wait on the proprietor of the already patented article and make arrangements with him for working the original patent and the improvement together. If no such arrangement can be arrived at, H. will have to wait for the expiration or determination of the original patent before he can make his improvement available.—C. C. C.

Organ Matters.—Z. Y. X.—Cyphering is caused by damp swelling the woodwork of the action, rusting of pins or wires, bending of wires, weakening of springs, wrinkling of pallet coverings, and innumerable other accidents or defects, but damp is the most frequent cause.—M. W.

Dulcimer.—L. G. (*Middleton*).—I tried in my paper on the dulcimer to make everything as plain as possible, and flattered myself that I had succeeded; but I find, alas! that I am not quite so clever as I thought myself. Allowing for one or two slight inaccuracies which have crept in, the paper and diagrams I hoped would be sufficiently explicit for anybody. The idea I intended to convey on page 490, Vol. I., was that if one block of wood, 18 in. long, 3½ in. wide, and 2½ in. thick, was divided along its whole length by the diagonal mark shown in Fig. 1, the result would be two blocks, each of which would measure on its freshly cut or sloping face 3½ in. As a matter of fact, the measurement would be somewhat less, but the method of getting out the blocks remains the same.—R. F.

Sheet Brass.—G. M. (*Bradford*).—If you cannot get the kind you require of local ironmongers try Messrs. Tonks & Son, Birmingham, or Evered and Co., Drury Lane, London, W.C. Price, about 11d. or 1s. per lb. according to the state of the market; in ordering state what gauge and size you require it.—R. A.

Spelter Solder.—A. C. (*Bradford*).—You can get spelter in small quantities at almost any good ironmonger's or metal merchant's. Mr. H. Ponder, 40, Drury Lane, London, W.C., will supply you if you write enclosing remittance to cover cost of material and postage. With regard to using it, instructions have been given in No. 42 of WORK, page 660.—R. A.

Picture Composition.—H. G. (*Bishopsgate*).—For gilt frames a little putty is used to fill up the chip and then dry bronze powder put on with the brush; the putty has enough moisture to hold the bronze. Black frames—heelball is used, same as shoemakers use; hold it over a light, and let it drip in until well filled, then rub smooth with a piece of cloth. White frames—a little Aspinall's white enamel, or white lead; get a large kettle of boiling water; see that you have plenty of water, and it must boil; take two large cups full of flour in a pail, and halfpennyworth of alum; mix well with a little cold water, only sufficient to wet it, and stir all the lumps out. Keep stirring and gently pour boiling water; it will get thick and turn yellow colour; it is then as good a paste as you can possibly get. We use in our factory a bucket per day.—G. R.

Ticking of Alarm Clock.—CLOCK (*Stamford Hill*).—The annoyance is due more to increased sensitiveness on your part than to increased loudness of the ticking of the clock. Sound may be deadened by enclosing the clock in a wooden case lined with sawdust, kept in place by green baize.—G. E. B.

Bennett Battery.—CHIP (*Bridgnorth*).—Only the upper part of the cells should be soaked in hot paraffin wax to prevent the solution of alkali from being spoiled by air. The inner cell should be airtight above the solution. If you soak the whole of it in wax you will not get any current.—G. E. B.

Light Hand-Cart Wheel.—W. S. (*Newcastle-on-Tyne*).—The easiest way of making a light wheel for your hand-cart is by making it cart fashioned, being easier and simpler than coach fashioned. Get your oak naves turned in the lathe 7 in. by 8 in., and then let the smith fret them with two iron bands which keep the naves from splitting when driving the spokes in. Fig. 1 shows the oak spokes dressed off cart fashion, and are 24 in. long, 2 in.

wide, by 1½ in. thick when dressed off. You say that you want ten spokes in each wheel. Get your compasses to divide the nave into ten equal parts, an inch from the line which is marked on the nave. When you have divided the nave make a mark at each one, and bore straight down half way; bore all the others the same, then fix the nave in the frame described and illustrated in No. 15, Vol. I., with the face towards you. Next get a face-stick or spoke-boy, and screw it to the nave so that you can work the stick about; now insert a piece of whalebone in tightly, the dimensions of which will be ¼ less than the distance between the tenon of the spoke and the stick; this you will see in Fig. 2, which shows the nave cart fashion, and the face-stick with the spoke in the nave, and you will see how a wheel is dished; moreover, it is to guide you in driving the spokes in straight, as the front of each spoke must just touch the cane or whalebone. You therefore get a spoke and place the end upon the nave, letting the front of the spoke be in a line with the one already run upon the nave. Get your pencil and run round the

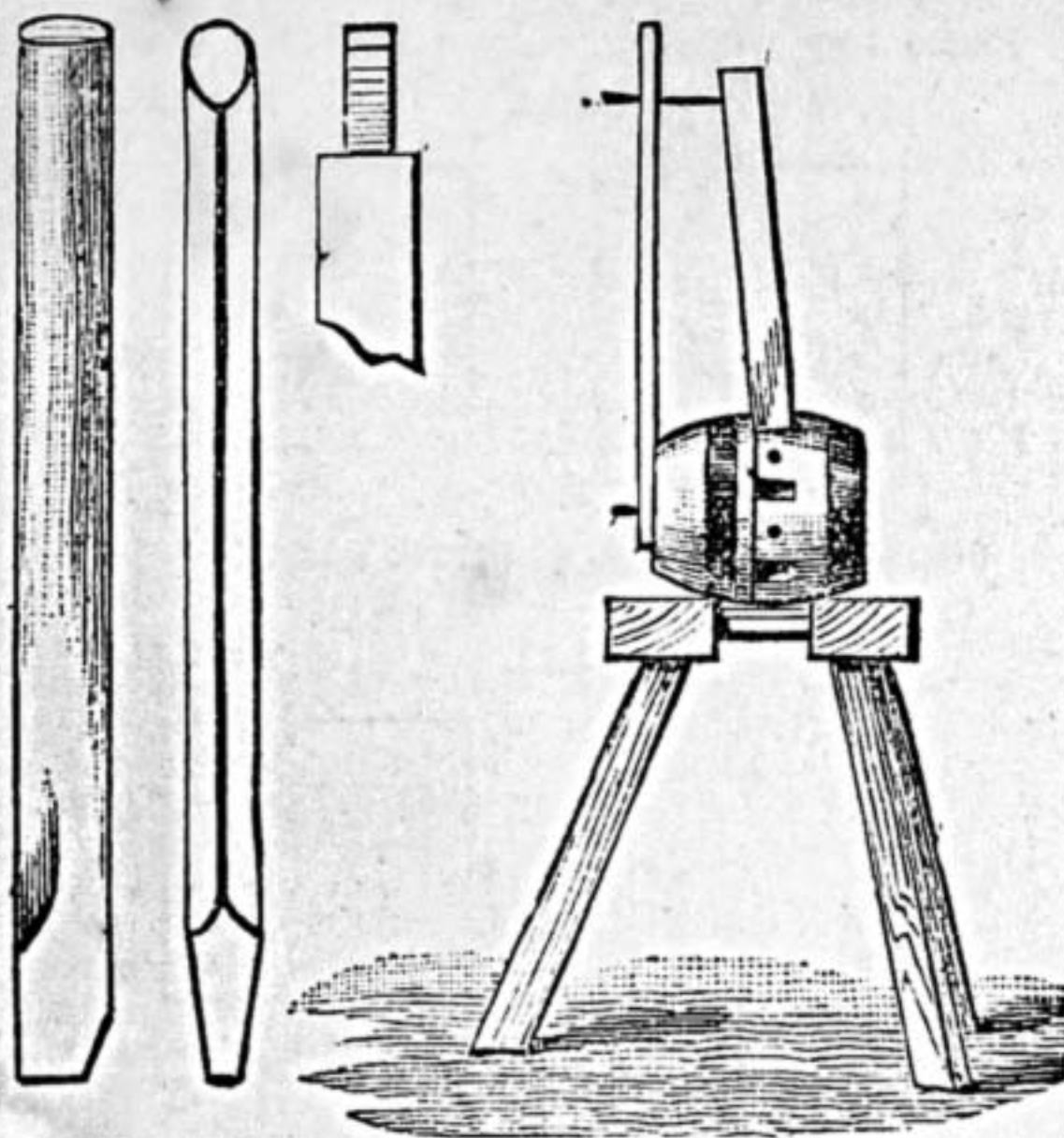

Fig. 1.

Fig. 2.

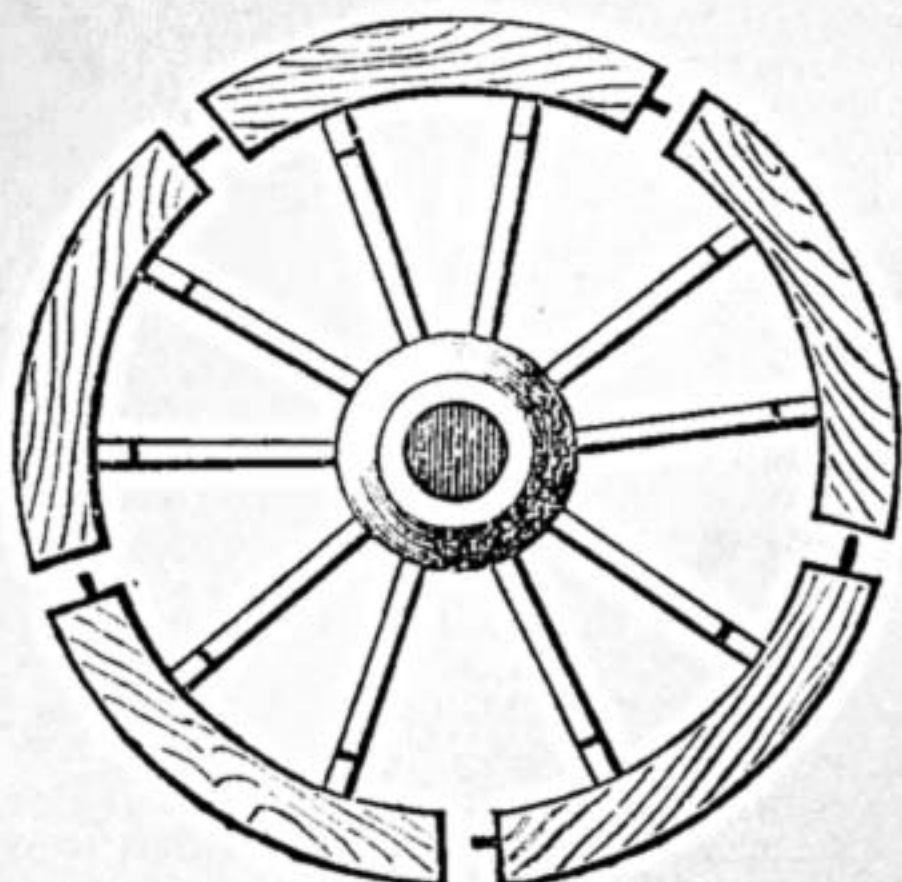

Fig. 3.

Light Hand-Cart Wheel. Fig. 1.—Spokes. Fig. 2.—Cart Nave, Spoke-stick in position. Fig. 3.—Showing how the Wheel is put together.

two sides and the back, then pare out the mortise and drive in the spoke. In driving keep trying the stick to see that you are driving straight; when a spoke is driven in up to the 3 in. compass mark on the face of the spoke. You mortise and drive in the others alternately, leaving a space between for a mortise and spoke; if you drove in the spokes one after the other the nave would split into two halves. You now get your felloes: these are of ash 2 in. square thickness; as you are not a wheeler you will not have a 3 ft. 9 in. felloe pattern. To make one get a piece of pine, lay it on the floor or fasten to the wall, and describe a circle with the compasses set 22½; set the compasses again 20½; now divide this circle into five divisions, each one being a felloe, and be sure that one of these felloes is marked upon the board, as you want to saw this pattern out. When sawn and dressed out, place it upon your ash felloes and mark all round; saw the ends off straight and plane them up, having one side planed straight and true. You now get a scribe, made with a short staff 24 in. long; one end is narrowed at the side like a wedge to fit between the spoke on the nave; measure from this end 13 in. and insert a sharp bradawl in at the mark; let the end of the staff rest up on the nave between the spokes, and mark each spoke at both sides. Next saw the ends of the spokes off up to this line. Measure 11 in. on the staff and insert the bradawl in, or 2 in. lower down than it was before. Mark each spoke all round; this is for shouldering and tenoning the spokes. Get a piece of hard wood and bore an inch hole in; make the tenons 1 in. diameter, and keep them

straight; keep trying to see if you can fit this mortise on the tenon; keep paring the tenon down until you can; at the top you can have the tenon a little slack, but have it to fit on the shoulder or end of tenon. You now lay the wheel down on a block with the face up and place your felloes resting upon the tenons; let a felloe rest upon two spokes; the half of felloe or the joints always also come in the centre between two spokes, or meet the ends abutting against each other; fit these felloes all round, sawing a little out of the joints if required; when right, mark the mortise out of the felloes by running your pencil alongside of the tenons; also draw a line traversing the joints. Next number the spokes and felloes to correspond when putting them together. Square and mark the lines at the inner and outer side of the felloes. Next find the centre between the lines and bore an inch mortise hole; also with the ½ in. bit bore a hole in the end of the felloes to hold a 2 in. dowel ½ in. round iron, therefore bore 1½ in. in each end, boring in the direction of the traversing line, which you marked at the side of the felloe; take the average off the inner edge of the felloe and dress it round at the front; at the back of the felloes, which will be at the back of the wheel when on, you only dress between the mortises. You now fit your felloes upon the spokes. All the felloes are put on just a little at first until they are in their places, then they are all driven up and wedged. Saw the wedges off level with the sole of the felloe and plane the joints on the sole straight. Give the wheel a coat of paint, and when dry have it hooped. After the tire is on dress the joints off level at the inner side, and dress the sides off smooth, and box the nave, and fit in the bush. It is needless to say that there is machinery to do all this, but I hope that this description will be plain to enable you to work by until my articles, which I am writing, on making wheels appear in WORK.—W. P.

Book on Metal Plate Work.—PLUMBER (*Slade*).—Millis' "Metal Plate Work," 9s. (Spon). This is a useful book for your purpose.—F. J. C.

Ebonite.—H. J. G. (*Coventry*) asks for information "as to composition and details of process for making ebonite." Ebonite is composed of india-rubber, sulphur, and some black colouring matter. With regard to the details of the process the limits of "Shop" admit only an outline. The india-rubber is prepared in a machine called a masticator—which generally consists of an iron cylinder in which a fluted drum revolves—with about 30 per cent. of finely sifted flowers of sulphur and sufficient colouring matter. When these substances are thoroughly mixed the material is placed in a prepared mould made of plaster of Paris and of the required shape. This is then placed in a steam boiler and subjected for two hours to a heat of 315°, and a pressure of about 12 lbs. to the square inch. When cold the article is ready for carving—turning in a lathe or otherwise finishing in the same manner as ivory. From this sketch of the process you will see that special machinery and power is required, and that, having regard to the nature of the ingredients, and to the necessity for high temperature and pressure, there is no "short cut" to the manufacture of ebonite. Ebonite may be purchased in sheets of various thicknesses at about 6s. per lb. at such houses as Elvay & Co., 31, Conduit Street, New Bond Street, W., and Elephant House, 46, Lower Sackville St., Dublin.—OPIFEX.

Battlesden Cart.—L. M. (*Roscrea*).—I do not know of a firm that will supply both shafts and iron work for Battlesden. Noting your address I recommend you to apply to J. Potter, North Wall, Dublin, for shafts, wheels, etc., and Henshaw & Son, Christ Church Place, Dublin, for springs, axle, etc. I am glad you appreciate WORK, and wish you success with the Battlesden.—OPIFEX.

Dye for Brown Leather.—C. S. G. (*Somerset*).—You can make a simple black dye for brown leather by the following recipe: Boil a handful of iron shavings in, say, a quart of good vinegar, and let it stand for eight or ten days; heat again and let stand for the same length of time. Strain off the liquor and bottle for use. I do not know that there is such a thing as "jet black oil." You can, of course, colour any oil by the addition of lampblack, etc. There is an oil called "molluscum," which is dark in colour, but not black, and which may be got at almost any saddler's. I also give you a recipe for another very dark oil, but as I do not know what you want it for I cannot answer for it. Olive, or rape, oil, 1 pint; oil of turpentine, 2 oz.; mix and add gradually 6 drs. sulphuric acid; leave the bottle open till cold.—OPIFEX.

Cut Work in Printing.—E. J. J. (*Romford*).—"Cut work" means printing engravings at hand press or machine. "Modern Printing Machinery" (Cassell & Co., 21s.) contains a chapter on this subject. It cannot be treated in WORK at present in consequence of the pressure of other subjects.—J. F. W.

Brass Engraving Tools.—BRASS EYE (*Southgate*).—The tools used for cutting sheet brass are various, according to the size and thickness of the metal. For cutting the thickest metal large shears are used, fixed to the ground by a heavy iron stand; the metal is then held between the shears while great force is brought to bear on the end of the knife. Metal up to a very thick gauge is cut this way. For thinner metal there are, we believe, one or two patents. They have one at Harrison's, Drury Lane, very much after the style of a small mangle, which pulls the metal in and cuts it at the same

time, all that is needed being to guide it. But for the use of BRASS EYE we should advise a scriber or fret saw, to be obtained at any tool warehouse. We cannot tell exactly at what temperature brass will melt, but zinc and copper (of which two metals brass is composed) melt at 680° Fah. and 1,994° Fah. respectively.—S. M. S.

Galvanic Battery.—R. R. (Limehouse) asks:—"Will you kindly explain to me the simplest way to make a galvanic battery for home use?" Such questions as these cannot be satisfactorily answered in "Shop," because the writer fails to state what "home use" is intended for the battery. By "home use" I should understand that the battery was required for ringing electric bells, working model motors, or working a shocking coil. Now, for each of these purposes a different battery will be needed, and I cannot undertake to describe some two or three batteries on the mere chance of one of them being the thing wanted. In asking for information on batteries, you must give me some idea of the work to be done by the battery.—G. E. B.

Copper Bronzing.—H. T. (Wolverhampton) asks:—"Could any kind reader of WORK tell an amateur the solution for copper bronzing, and how to use it?" This is another indefinite query. A bronze appearance may be given to copper by dipping it in a solution of sulphide of ammonium. See article on "Bronze," p. 643, No. 41, Vol. I., and also article on "Brassing," p. 598, No. 38, Vol. I., of WORK. If this does not suit you, please write again and tell us exactly what you require.—G. E. B.

Pocket Accumulators.—T. W. A. (Dulwich).—The containing cells are made of ebonite, and the lead plates are cut to fit these. You will find information on how to make accumulator plates in a reply to D. S. (Holloway), on page 477, No. 30, Vol. I., of WORK. I do not know of a book on the subject of making pocket accumulators, but this will, doubtless, receive attention in these pages at some future date.—G. E. B.

Magnetic Belt.—W. C. (Dukinfield).—(1) Some pieces of hard crinoline steel two and a half inches in length, magnetised as directed in replies to V. R., ANXIOUS (Liverpool), and others in back numbers. (2) These pieces of steel should (theoretically) be sewn into the belt about an inch apart, with north and south poles alternate. (3) Any number of these you may desire, or the belt will hold. Quilt each magnet in its place between two pieces of jean, line the belt with red flannel, and bind the edges with soft leather. If you think this will do you any good, by all means make one. You will be benefited by the employment, and the belt will comfort your mind as long as you have faith in its curative properties.—G. E. B.

Capability of Battery.—A. G. R. (Southport).—The battery is a single fluid bichromate of potash battery. The red and amber crystals are those of bichromate of potash; the purple-black and dark ruby-red crystals are those of chrome alum deposited from the partly spent solution above. Throw all the solution away, and the crystals also, unless you want them for experimental purposes. Dissolve the dark crystals by pouring into the cells a little warm water acidulated with muriatic acid. When the cells are clean, charge them with a solution of chromic acid (three ounces in one pint of water), acidulated with three fluid ounces of sulphuric acid. Clean the zincs, and reamalgamate them with mercury; also clean all connections, and see that they are perfectly in contact with each other. You will now have a battery similar to that illustrated in my forthcoming articles, "Model Electric Lights" (Fig. 11), and it will serve a similar purpose. It will light up a 10 volt. 5 c.p. incandescent lamp, or, perhaps, a 10 volt. 10 c.p. lamp. It will not be suitable for electro-plating, although, in a pinch, some few jobs might be done with it, if you couple all the zincs to one leading wire and all the carbons to the other.—G. E. B.

Silicene Glass Painting.—PAINTER (Cork) can obtain silicene materials through J. Gilbert, 120, Patrick Street, Cork. I am sorry I am not in a position to recommend any work on gilding and embossing on glass, but I believe Messrs. Brodie and Middleton of Long Acre publish books of that nature.—F. B.

Safe.—R. C. W. (Lewisham).—If the room is, as you say, a dry one, the moisture must be in the formation of the safe. The only thing I can suggest is that you should dry them occasionally. You might also keep some chloride of calcium in the safe, as it absorbs moisture very readily. Of course as it deliquesces it will require occasional attention; or your safe might admit of a wooden casement, with or without partitions, being placed inside it—especially if it be a safe without fittings. Doubtless the moisture proceeds from the sand in the safe's walls.—D. D.

Address of Vendor of Electrical Goods.—A. H. (Ashton-under-Lyne).—I do not know the address of a vendor in your town. The goods can be sent by post. Try Messrs. T. Gent & Co., Braunstone Gate, Leicester.—G. E. B.

Clocks.—TIM BOBBIN.—Some papers on "Clocks and Clock Cleaning" will appear shortly.

Canvas Canoe.—T. H. D. (York).—The best covering for a collapsible canoe is a kind of canvas known as "crash." It is very strong and closely woven, and splendidly adapted for canoe making. You can obtain it at most linen-drapers in widths of about 5 ft., and of any length. After you have stretched the canvas on frame, give

it two coats of boiled linseed oil, letting the first coat dry thoroughly before applying the second, which will take two or three days; after this give it two coats of good paint, when you will find your boat perfectly waterproof. The paddle should be made of fir or yellow pine, in three pieces. The handle should be oval, and the blades at right angles to the broadest part of the oval.—G. J. E.

Switch for Electric Alarm.—H. M. (Hatton Garden).—Wood for all three forms of switch: Half-inch pine, teak, mahogany, or beech, 3½ by 5½ inches, planed and polished. Fittings: Switch arm, A, spring brass ¼ in. thick, 2½ in. in length, by ⅞ in. in width. Drill hole for half-inch round-head brass screw at one end, cut off head of round-head brass screw, and solder to other end. Fig. 1.—Fix a thin strip of boxwood, ebony, ebonite, or gutta-percha at B by two flat-headed brass screws, slightly countersunk. Insert two round-headed brass screws at C and D to act as stops for the arm, A. Place a thin brass collar or washer under the upper part of A, clip the line wire between them, and secure with a round-headed brass screw. The end of the other line wire will go around the two screws at C. Fig. 2.—Make the stops and contact pieces (C and D)

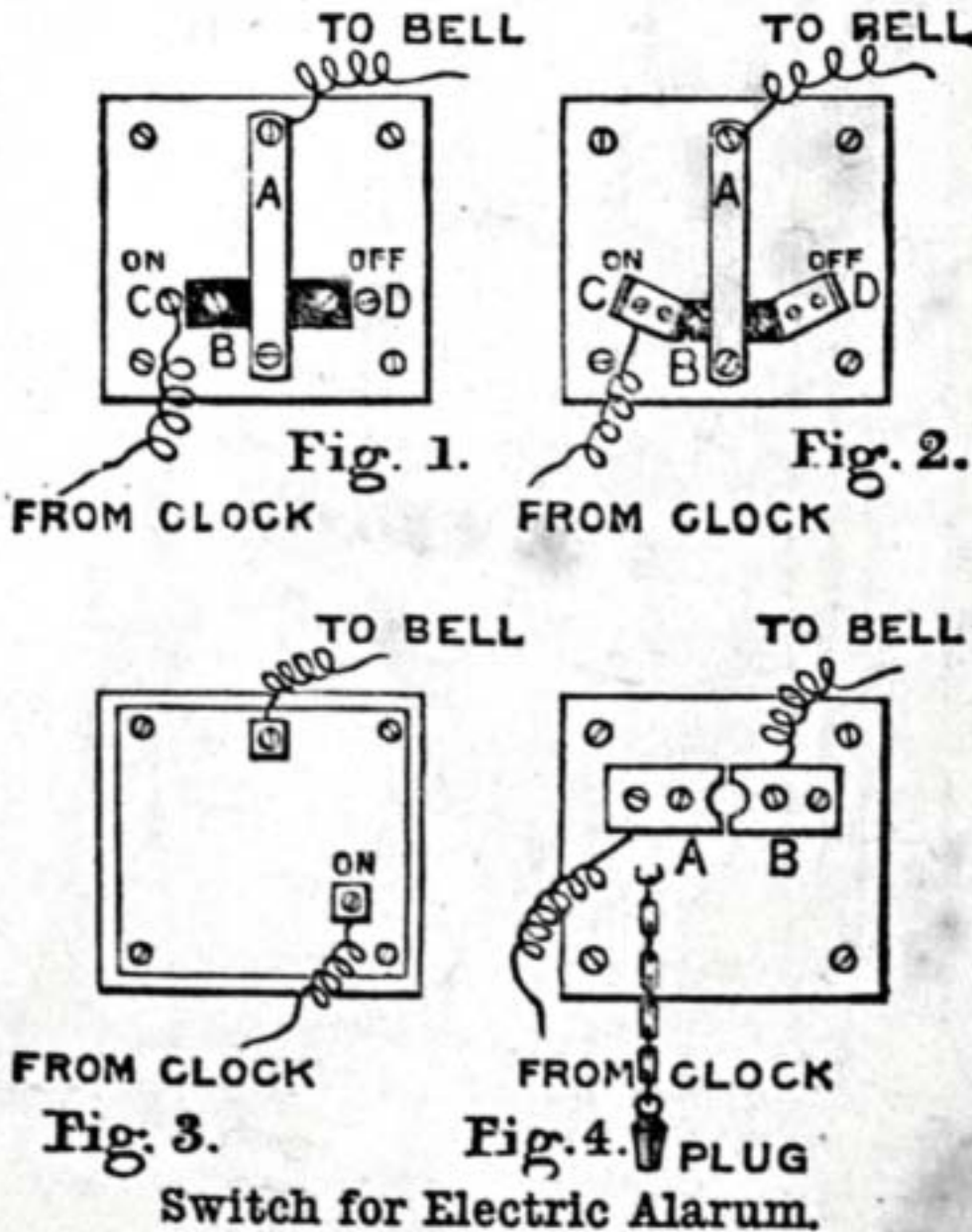

of ¼ in. brass, bent up at the ends, and fixed to the board by two brass screws, countersunk level. Fill in the space between the ends of these with a thin strip of boxwood or ebonite. Fix the wires as shown in the figure. Fig. 3.—If you do not care to see the connections for the wires in the face of the switch, make the pivot for the arm like a bolt, and secure the wire to a nut beneath, as shown. Fig. 4.—This shows a cheap form of plug switch. A and B are two strips of ¼ inch brass, nearly but not quite touching each other. In the centre is drilled a half-inch hole broached taper from the outside. In this is fitted accurately a taper plug of brass, which may be hung by a chain when not in use. Place the plug in the hole when the switch is wanted on. From these I think you will get an idea how to make a cheap switch for your time alarm.—G. E. B.

Mica.—G. P. (Edinburgh).—You ought to be able to get mica in Edinburgh. Lamp dealers, gas-fitters, etc., use it in the form of "mica tops," and they, dealing with manufacturers, should have no difficulty in procuring the raw material for you. I am supposing you want only a small quantity, but if I am mistaken you might apply to Grew & Bridge, Summer Row, Birmingham. They, however, only supply wholesale, I believe.—D. A.

Horse-Power Lathe.—ÉCOLIER.—A 6½ in. lathe can be driven by the foot; you may, therefore, reckon the power required to be that of one man, say ½ of a horse-power. An engine capable of exerting ¼ of a horse-power would be suitable, and you can put a fast and loose pulley on the right-hand end of the crank shaft of the lathe and drive it direct from the engine. The size of the fly-wheel depends on the speed of the engine. A ¼ horse engine might have a wheel of about 16 in. diameter, and be bored to fit a ¾ in. shaft. I have written a series of papers on the construction of such an engine to appear in WORK with working drawings. F. A. M.

V.—BRIEF ACKNOWLEDGMENTS.
Questions have been received from the following correspondents, and answers only await space in SHOP, upon which there is great pressure:—ELGER; IVANHOE; CARTRIDGE; DIAMOND; CORCORAN; J. S. W. (West Bromwich); W. B. (Castlegate); R. L. H. (Glasgow); THE ALLIANCE ALUMINIUM CO., LIMITED; F. A. W. (Handsworth); T. H. (India); T. J. (Liverpool); J. W. (Scrimdon); R. T. (Paisley); E. C. B. (Leytonstone); BOOK-BINDER (Woolwich); J. C. (Belfast); C. A. (Birmingham); SCULPTOR (Chester); W. D. (Bath); C. J. H. (Birmingham); G. B. (Accrington); W. BROS. (Hereford); COSMOS; C. C. & CO., LIMITED; A. R. (Scorrier Saw Mills); PESSEZ A MOI; F. M. (Thornton); W. G. S. (Bristol); G. M.; E. J. (Barnsley); J. W. R. (Horbury); DOUBLE GLOSTER; PAINTER; AMATEUR; MARBLE; JOINER; G. L. (Halifax); F. G. H. (Kent); J. C. (Hemwood); J. B. (Doncaster); A. W. D.; CHORLEY; W. R. (Heaton); A. B. (Salford); W. D. (Liverpool); BRITANNIA CO.; J. T. E. (Seacombe); POLYSMATTER; J. M. (Midhurst); SECOND HAND; G. A. N. (Wolverhampton); J. N.; IGNORANT; F. G. H. (Kent); I. S. K. (Kirkcaldy); E. B. C. (Coseley); W. H. N. (Oldham); A CONSTANT READER; J. K. (London, E.); J. P. (Brigetown); INVALID; N. F. P.; A. H. (Ripon); J. R. W. (Portsmouth); G. B. (Accrington); W. B. (Thurs, York); A NEW READER; T. H.; AN ENQUIRER; F. J. P. (West Bromwich); F. C. (Leytonstone, E.); E. E. (London, E.); W. J. S. (Caversham); AMATEUR (Kilkenny); J. G. B. (Dearsden).

Trade Notes and Memoranda.

MESSRS. ROBERT WETHERILL & Co., of Chester, Pa., are to build the largest Corliss engine in the world. It is to be used in the steel works of Messrs. Carnegie, Phipps & Co., at Homestead, Pa. The cylinder will be 54 in. by 72 in., and will weigh 40,000 lbs. The fly wheel will be made in ten segments, and will weigh 200,000 lbs. The crank pin will be made of the best forged steel, and will weigh 1,700 lbs. The shaft will be made of standard steel, and will weigh 40,000 lbs. The casting will be of iron. The total weight of the engine will be something over 500,000 lbs., and will furnish 3,500 horse-power.

PAPER or pasteboard may be rendered waterproof as follows:—Mix four parts of slaked lime with three parts of skimmed milk and add a little alum; then give the material two successive coatings of the mixture with a brush, and let it dry.

SOME interesting experiments were made the other day in the vicinity of Copenhagen with tree-felling for military purposes by dynamite. The object was to ascertain the saving of time and labour effected by this method, and the results were exceedingly satisfactory—far more so than is understood to have been the case elsewhere. Trees of so much as three feet in diameter were brought down in some twenty to twenty-five minutes, whereas the time occupied by ordinary felling would probably have been ten times as much.

THE most powerful electric light in the world is said to be one at the Houtholm lighthouse, on the dangerous coast of Jutland. It is of 2,000,000 candle-power, and is visible 40 miles.

FILES can, it is said, be recut by cleaning them in acidulated water between two plates of carbon and closing the circuit, so as to form a real voltaic cell.

THE tramways in London consist of nearly 117 miles of line. The principal companies are the North Metropolitan, owning 41 miles; the London, nearly 22 miles; the London Street, just over 13 miles. Five other companies between them hold 41 miles. These are the South London, Southwark and Deptford, London Southern, North London, and West Metropolitan Tramways. There are, at present, several London tramway companies whose receipts barely equal their expenses. This little fact will materially reduce the 5.79 per cent. return shown by the three great successful companies, and the 3 per cent. at which the County Council can get money would not leave much profit.

A TELEGRAM from Constantinople received in London states that the Sultan has issued his Imperial irade, dated the 13th inst., to Mr. J. K. Pilling, of Sacksteads, near Manchester, for the construction of a railway from Damascus to the natural harbour formed by the Bay of Acre, with branches to divers other places. It is believed that the projected line will divert into that country the considerable export trade of Syria and Arabia, and tap the rich agricultural district of the Hauran. The trunk line from Damascus to the sea will be 115 miles long, and the junction from the great caravan route to Mecca will be at Cæsarea Philippi, the ancient Dan.

WORK

is published at La Belle Sauvage, Ludgate Hill, London, at 9 o'clock every Wednesday morning, and should be obtainable everywhere throughout the United Kingdom on Friday at the latest.

TERMS OF SUBSCRIPTION.

3 months, free by post	1s. 8d.
6 months, " "	3s. 3d.
12 months, " "	6s. 6d.

Postal Orders or Post Office Orders payable at the General Post Office, London, to CASSELL and COMPANY, Limited.

TERMS FOR THE INSERTION OF ADVERTISEMENTS IN EACH WEEKLY ISSUE.

	£	s.	d.
One Page	-	-	12 0 0
Half Page	-	-	6 10 0
Quarter Page	-	-	3 12 6
Eighth of a Page	-	-	1 17 6
One-Sixteenth of a Page	-	-	1 0 0
In Column, per inch	-	-	0 10 0

Small prepaid Advertisements, such as Situations Wanted and Exchange, Twenty Words or less, One Shilling, and One Penny per Word extra if over Twenty. ALL OTHER Advertisements in Sale and Exchange Column are charged One Shilling per Line (averaging eight words).

Prominent Positions, or a series of insertions, by special arrangement.

* * * Advertisements should reach the Office fourteen days in advance of the date of issue.

SALE AND EXCHANGE.

Belt's Patent Enamelled Adhesive Water-Proof Advertising Paper Letters and Figures in all Colours and Sizes.—Sole and Original Manufactory, 17, Arthur Street, New Oxford Street, W.C. Agents apply. Sample sheet gratis. [24 R]

Six Cabinet Copies, from Carte or Cabinet Photo, for 3s. 6d. Originals returned unjured.—ETHELBERT HENRY, Alvaston, Derby. [22 R]

Victor Cycle Co., Grimsby, sell Mail Cart Wheels. [26 R]

Amateur Photographers are invited to send for Trade List of Photographic Printing.—ETHELBERT HENRY, Alvaston, Derby. [1 S]

Designs.—100 Fretwork, 100 Carving, 100 Repoussé, 100 Sign Stencils, (all full size), 300 Turning, 400 Stencils, 500 Shields etc. Each packet, 1s. 100 Decorators' Stencils, 60 sheets, 2s. 6d. All post free. Lists sent free.—F. COUTHARD, 113, Old Christchurch Road, Bournemouth. [8 R]

I.—LETTERS FROM CORRESPONDENTS.

Artificial Marble.—E. T. (London, E.C.) writes:—"Having observed in WORK on several occasions a desire to obtain a good imitation marble, and as I know one that is not very expensive, and far superior to those that you have mentioned in WORK from time to time, I thought that it would not be out of place to write and place it at your disposal. It is not difficult to make; it does not require many tools; and when it is finished properly it is most difficult to tell from the real article unless on very close inspection. The ingredients required are Keen's superfine cement, Keen's coarse cement, colours to match veins, marble, etc. Tools: Small trowel, some stopping tools (one will do), rushes for fining up, a stone for fining up beading, and some ordinary French polish for polishing (or it may be polished with putty powder if preferred), a piece of glass for bench for slabs, and moulds for other articles, such as columns, brackets, etc.; the moulds are the ordinary plaster moulds varnished inside with spirit varnish; some raw silk in bunches, cut into lengths of about one yard and knobbed at the ends to keep it from unravelling. The method of making is as follows:—If for slab, place the glass bench perfectly flat and thoroughly clean it; now mix some fine cement in a basin and colour it as required for veins (it should be about as thick as cream); now take the skeins of silk and dip them well in the colour; just run them down lightly with the hand on removal to prevent them from dripping and lay them on the glass, well opening them out to represent veins. When the slab is covered with the silks, mix some more cement without colouring of about the same thickness, and dipping the hand into it sprinkle it on the glass lightly until the silks are covered; the cement should now be about $\frac{1}{4}$ in. deep; now carefully remove the silks and wash them and hang them up to dry for future use; now carefully smooth the cement over with the trowel, care being taken not to smudge the face; when perfectly smooth, coarse dry cement can be lightly sprinkled over the top to draw out the water, carefully removing it with the trowel when wet; it can (the slab) now be left for a couple of hours, after which it must be backed up (strengthened) with coarse cement to any thickness required and left till morning, when it will be found properly set; it must now be removed from the glass, stopped, fined up, and polished, and I am sure the result will be found highly satisfactory. This is a similar kind of thing to what was advertised and sold some time ago as Athenian marble. Of course for brackets, columns, etc., the silks must be spread out over the moulds and the same process carried out."

Amateur Iron Founding.—E. P. D. (Sherborne) writes:—"Perhaps it is not generally known that iron can be melted in a crucible on a Rowson and Drew's fan forge; I enclose drawing of a fur-

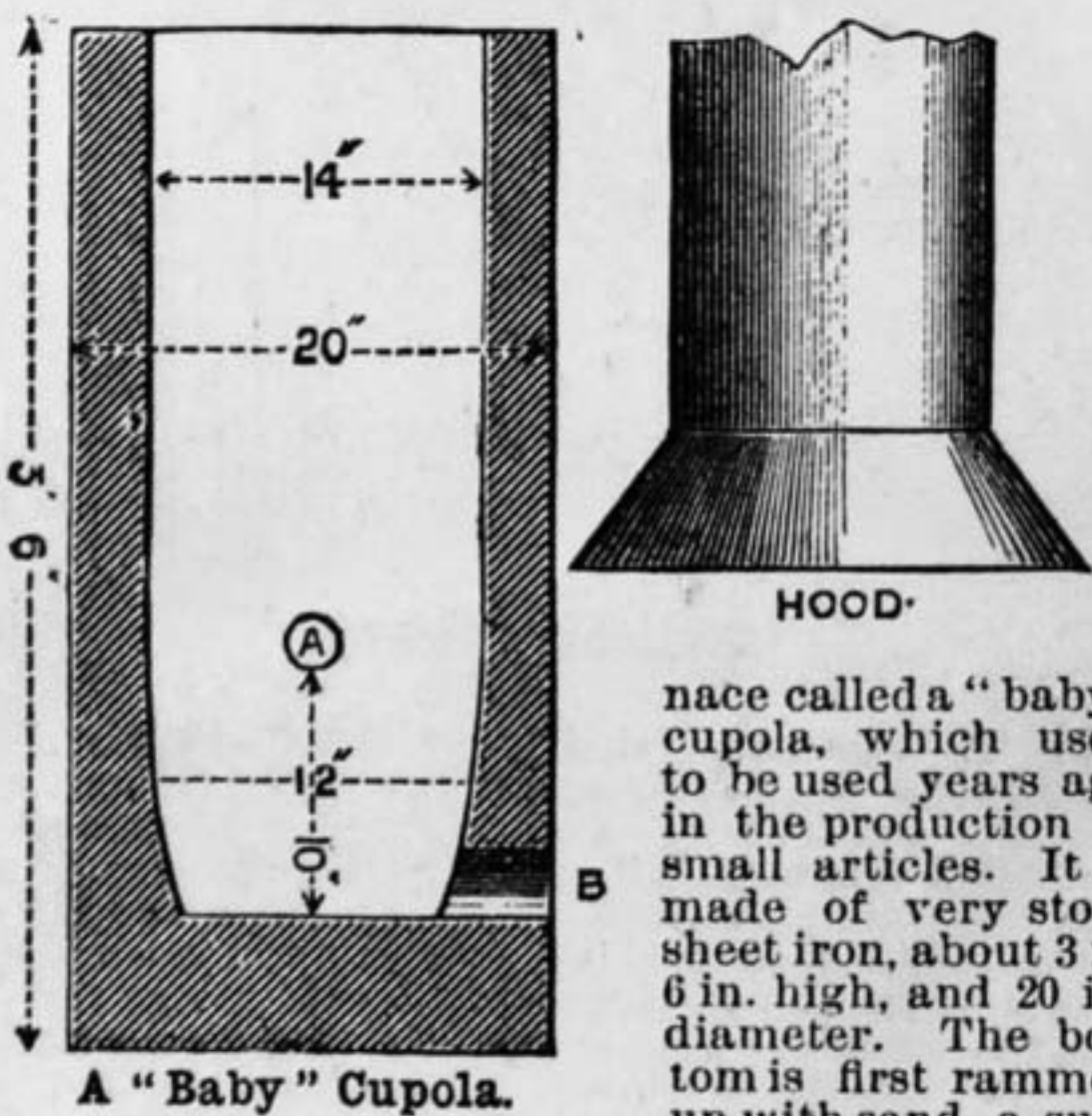

nace called a "baby" cupola, which used to be used years ago in the production of small articles. It is made of very stout sheet iron, about 3 ft. 6 in. high, and 20 in. diameter. The bottom is first rammed up with sand, a suitable 'former' is

II.—QUESTIONS ANSWERED BY EDITOR AND STAFF.

Lincrusta Hanging.—B. G. (Hampstead).—Until very recently, lincrusta was sent out by F. Walton & Co. with a backing of thin calico or some such fabric; it is now substituted by a brown paper backing. The best paste for fixing is about half each of flour-paste and glue. Make the paste thick, dissolve the glue—the 6d. per lb. article will do—by heat, and then mix. The glue will require to be thoroughly amalgamated with the paste, and the latter should be properly made and free from lumps. This is the paste used generally by the trade for lincrusta, Japanese papers, anaglypta, etc. Trim them all with a cobbler's knife and metal straight-edge upon a bench, cutting the article slightly inwards from the face, and so ensuring the face of the joints meeting nicely. The roller must not be used on such articles and designs when rolling is likely to injure the "relief" or raised parts. A few small upholsterer's gimp pins should then be tacked in to keep the joints well down until the paste sets; the heads of these will not show if you get them

light or dark according to the colour of your material. The lengths of lincrusta and any other thick and heavy material should always be cut, trimmed, and matched to the exact size before fixing; it could not be done upon the wall or ceiling in a workmanlike manner. Having been familiar with lincrusta since its introduction some ten years ago, when Mr. Walton called his invention "lincrusta muralis," and when it required, of course, a special cement to fix it with, I shall be able and pleased to give you any further help in such matters. Although, for the present, a special paper upon its uses and treatment may not be much called for, its treatment in connection with graining and imitation of carved woods will be considered in the "Art of Graining."—DECORATOR.

Photo-Mounts and Sizes.—J. A. McLEOD (Glasgow).—Mounts are usually cut to suit the photographs, the amount of trimming being decided by the subject of the picture itself—in many cases a $\frac{1}{4}$ in. less way would be right; that is, less than the negative from which the print is made. Prints are of the following dimensions: $3\frac{1}{2}$ in. by $4\frac{1}{2}$ in., $6\frac{1}{2}$ by $4\frac{1}{2}$, 8 by 5, $8\frac{1}{2}$ by $6\frac{1}{2}$, 9 by 7, 10 by 8, 12 by 10, 13 by 8, 15 by 12, and 11 by 8. In some cases much larger negatives are made, and the subjects masked down to the sizes above; in such cases the opening of mounts would have to be as large as the sizes enumerated. Bronze ink is made by rubbing down a sufficient quantity of Bessemer's gold-bronze with thin gum-water. Red-gold ink is made by carefully triturating gold-leaf with gum-water. The gold paper (bronze) is machine-made on a large scale, and is retailed at 6d. a sheet. Red-gold paper is made by laying down gold-leaf on a suitable paper, but the edges of mounts are frequently gilded by brushing over them gold or bronze paint. The papers for edging are also brushed over the backs with a strong solution of gum with which a little sugar has been mixed.—D.

Belt Saw.—J. C. (Cork).—One of the hand-worked band-saws made by Hindley, of Bourton, in Dorsetshire, will prove much cheaper than anything you could make. Send to him for price list.—J.

Books on Pattern Making.—W. H. P. (Loughborough).—"Pattern Making," 7s. 6d., published by Lockwood; "Iron Founding," 4s., published by Whittaker; "Mill Gearing," 6s., published by Spon; "Templeton," 6s., published by Lockwood; "Machine Design," 6s., published by Longmans. Read occasional articles in *Industries, Practical Engineer, English Mechanic, WORK*, by the author of the first two books in this list.—J.

Ointment Vending.—BIRKENHEAD can sell without restriction any ointment or other compound not containing a poison within the meaning of the Pharmacy Act. Should his ointment contain a poison within the meaning of that Act, such as, say, precipitate of mercury (said to be an ingredient in Holloway's ointment), he should shelter himself under the Government stamp, and can further protect himself from piracy by a patent. To quote from the official circular of the Patent Office: "Communications with respect to the preparation and supply of medicine stamps appropriated to a particular medicine, or as to the liability to stamp duty of so-called 'Patent Medicines,' should be addressed to the Secretary, Stamps and Taxes, Inland Revenue, Somerset House, London, W.C." As regards "chip boxes" for his ointment, let him try Messrs. Ayrton and Saunders, Liverpool, who are makers of repute. From them he will best get information as to sizes and prices.—C. C. C.

Hinges for Screen.—D. S. (Auchenheath).—If you had read what has already appeared on hinges in WORK, I do not think your question would have been put. Your difficulty appears purely an imaginary one, evolved out of your own inner consciousness. Of course the screen will fold unless you do something egregiously wrong in fitting the hinges on. Imagine one of the folds to be a door, and the other one to be a wall to which it is hinged. Where is your difficulty then? You may either use "screen" hinges for double action, or butt hinges fastened to edges of frames, or back flaps on the face of the framing. With screen hinges the folds will work both ways, with the other kinds only one way. You may also use hinges of webbing à la folding clothes-horse.—D. D.

Carving Tools.—HOMO (Wellingborough).—It is quite impossible to tell you what are the best sizes for tools for executing carvings to designs given in WORK, for much depends on the sizes in which they are to be made. A good deal also depends on the amount of detail you intend to work in; as, if you only want good broad effect, of course you do not require so many tools as otherwise. I take it you are a beginner at carving; if so, most of the designs which have been given are not suitable for first attempts; and my advice is, get a few simple tools, straight, not bent—say, half a dozen—of moderate size, and add to your list as your skill increases.—D. D.

Mail Cart Wheels.—J. S. C. (Bradford).—No doubt by now you will have received a reply from Mr. H., as I went to see him, and he said that he had been ill, and was unable to do any corresponding, as he does not keep a clerk or any assistant to help him in the shop. Had you written to any of the others whom I recommended you would have received a reply the next day. Have you tried "The Victor" Cycle Company, Grimsby?—W. P.

Fretwork.—W. B. (Inchinnan).—You have been singularly unfortunate in the method you have adopted for transferring designs to wood, for you could hardly have a slower or more tedious one,

though there are plenty quicker and easier. One of them is to trace the design by means of carbon or manifold paper, on to the wood. Lay the carbon paper between the wood and the design, then go over this with a hard pencil or style. By the same means—carbon paper—you may multiply designs to be stuck on the wood. If you have one piece of fret cut, and want to keep copies for reproduction, the simplest method is to take heel-ball rubbings on paper, and stick them on to the wood to be cut. By this means you may dispense with tracing or drawing at all, as you can stick the original design down.—D. A.

Queen Anne Sideboard.—GLASGOW.—It is impossible to give answers to questions within a fortnight, and you need not be surprised at not getting an answer yet. The subject is quite within the scope of this magazine, but you must remember that everything cannot be attended to first. "Wait a little longer," and you will, no doubt, find your wishes gratified. I am unable to recommend you any better book than WORK.—D. A.

Pantograph.—R. A. S. (Stainley).—This may be got from any artist's colourman. If you cannot obtain it in Ripon, ask some one in this trade to procure it for you from Lechertier, Barbe & Co., or some other wholesale firm with whom he may deal.—D. D.

Fire-Proof Box.—H. H. (Sidcup).—I know of no way by which you could make a fire-proof box which is not at the same time a "safe." This you say you do not want to make; and I may add that safe-making is not a branch of labour in which an amateur could hope to succeed. Of course you can make a wooden box, and to some extent render it less combustible than it would otherwise be by treatment with some of the preparations used for such purposes. Your idea, though, seems rather too much of a fad; for the only thing that would resist the intense heat of a conflagration is a thoroughly good fire-proof safe; and a small box such as you contemplate would surely be kept as far as possible from any risk of fire. The best thing I can suggest is that you should make a double box, and fill the space between with some non-combustible; but I am afraid, from your inquiry about rule, that you have hardly sufficient knowledge to enable you to do so. Before the marks or scales on your rule can be explained, you must say what they are. If you do this, no doubt you will have your desire gratified.—D. D.

Jensen Electric Bell.—C. D. (Rochester).—I give, as requested by you, a rough sketch of a Jensen electric bell in section. This will enable you to trace the connections. One of the line wires is connected to the loop of the bell. In practice the wire is connected to the bracket on which the bell is hung. One end of the bobbin coil is brought into close contact with a cleaned spot on the bell at A, and is clipped there by the box-wood disc, which insulates the movement from the bell. The other end of the bobbin coil is attached to a screw which holds the contact spring at D. This spring is also

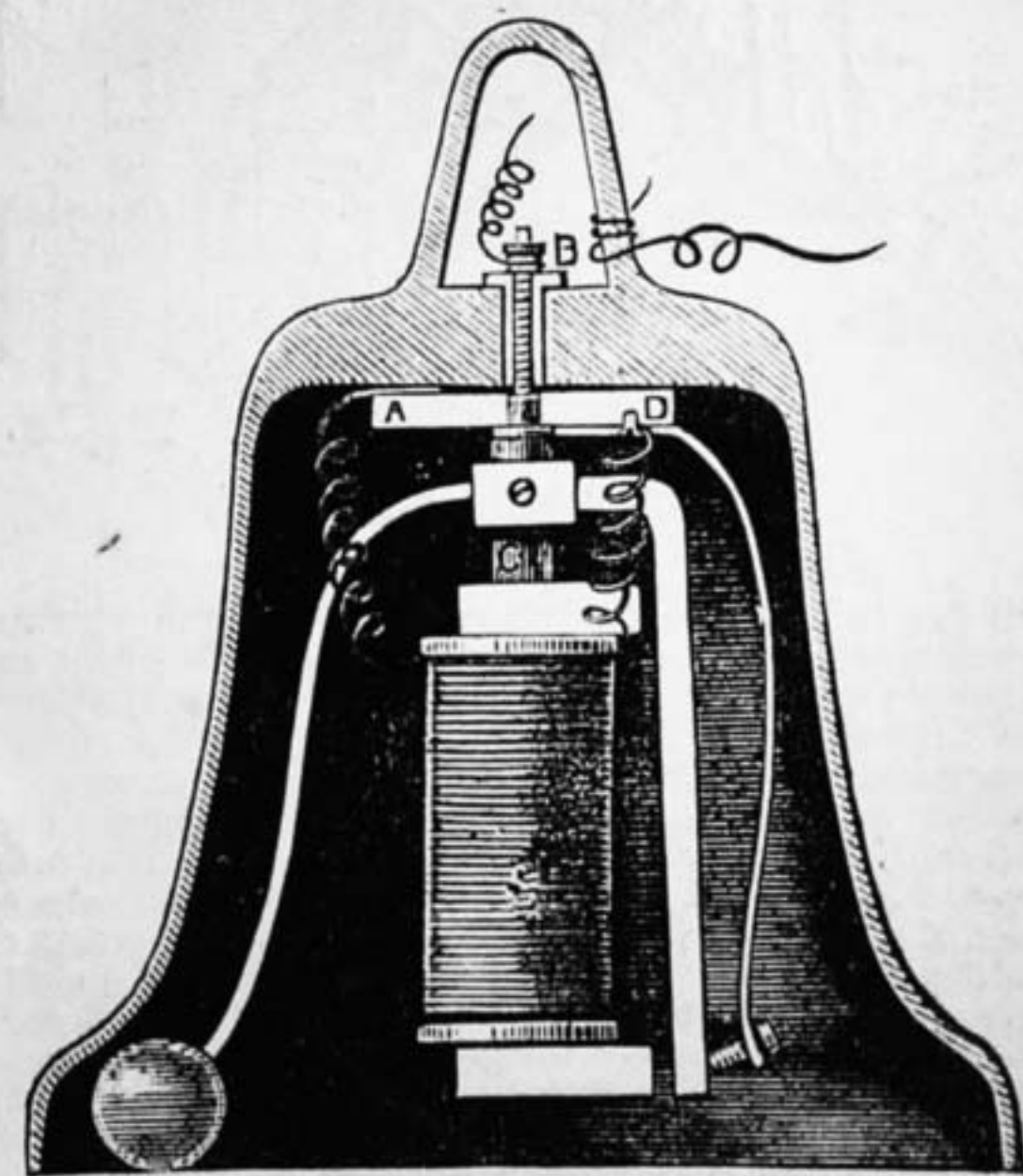

insulated from the rest of the movement by being fixed to the box-wood disc, so that it does not touch the metal of the core. The other line wire is fixed to the binding screw, B, on the top of the bell, and this screw also helps to hold the core of the bobbin in its place. The course of the current is, therefore, from B, through the core, C, and its armature, by way of the contact spring, then through the coil, and back through the bell at A. As you know how to make the fittings, this will set you right, will it not?—G. E. B.

Burnishing Gold.—GOLD LEAF (Halifax).—In Vol. I. (No. 38) you will find nearly a column of "Shop" devoted to an answer on gilding. The subject of burnishing is therein explained in as lucid a manner as space permits; I must, therefore, ask you to turn up that answer, which I suppose you have overlooked, otherwise you would not have written your query. Respecting the second item, gold leaf is affixed to glass, the surface of

which has been well cleaned and polished by a very weak gelatinous solution. Russian isinglass is the best, and a few shreds only are required to be dissolved in a half pint of boiling water to make it sufficiently strong for the purpose. The addition of a few drops of spirits of wine is usually recommended, but such is not necessary. The size requires to be free from the slightest taint of greasiness, and should be strained through the purest white blotting-paper. The portion of glass to be gilded is floated with the size by a camel-hair tool; the gold is then laid on. When the first gilding is thoroughly dry it is necessary to refloat the work with size and gild it the second time, otherwise imperfections of the gold leaf and its manipulation would be apparent when backed with black japan. If it is letters to be gilded on glass, draw them first on paper same as desired on glass and fasten temporarily to back of glass. Then you can see where to gild. Keep the work on the slant whilst gilding and the superfluous size will run off. After second gilding is dry coat the gold with thin clear size. Then convey your letters in the proper reversed position, by means of a pounce, and write the design with best black japan. When the writing is dry, clean off the superfluous gold with wadding and warm water. This is a rough outline of the process, space will not permit more at present. The subject of gilding with gold leaf is a very pleasing one, but when the worker can lay a book of gold his knowledge of the subject is just commencing.—**DECORATOR.**

Music Stand.—**FIDDLER (Glasgow).**—Have you seen my music stand described in pp. 552 and 553, No. 35? It is a folding article, but can scarcely be called portable. However, to meet your requirements I have specially designed the folding and portable stand here shown. You do not say whether

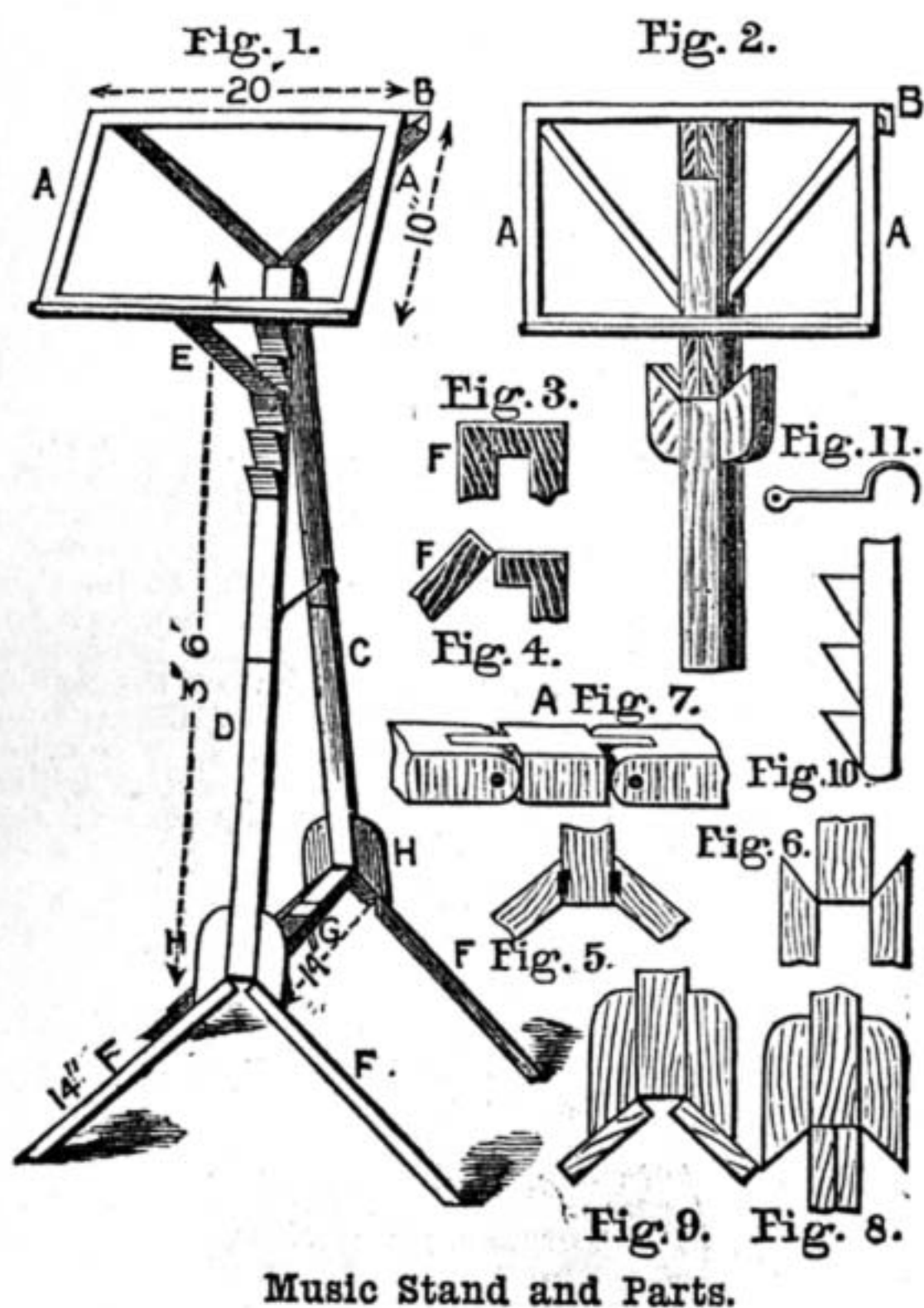

Music Stand and Parts.

you are tall or short, although I presume you are the former, as I generally find that fiddlers are majestic and imposing individuals! Pray, excuse the insinuation. This stand can be made to any dimensions; but in case you may experience some difficulty in deciding the sizes, I give some which will doubtless prove suitable to you. But you must bear in mind that a great deal depends upon your height. Your case seems to be that you want an article which will fold up into a very small space—here, then, is just the thing. You must not complain of the number of hinges, etc.—they, or similar connections, are absolutely necessary. The music frame (of which for the pins, etc. see No. 35) might be 20 in. by 10 in. This is hinged to a triangular backpiece, Figs. 3 and 4 (in which F represents the frame). On each side of the bottom extremity of this last-named piece are hinged the supports, D and C. To save as much space as possible I have marked the measurements on the drawings, so I need not repeat them. D and C are divided and hinged at the same distance from the top of the stand as from the extremity of F F. A good strong hook (such as Fig. 11) must be fastened to either D or C to keep them from collapsing when extended. At the extremity of D and C are small blocks (Figs. 8 and 9), which keep the feet, F F, firm. These feet can be seen in the last-named diagrams, open and shut. The cross rail, G, is connected at each end by hinges to the rails, D and C, and is made in the middle, after the manner shown in Fig. 7. The length of the piece, A, in this diagram is according to the thickness of the supports and feet; it must be as long as these thicknesses combined. The under part of the music frame should be cut away to admit the rail, E (Fig. 1), which is hinged to it so as to fold underneath it, the other end of it being quite free. By having notches along the

upper part of D, similar to those shown in Fig. 10, the frame can thus be adjusted to any desired angle. If the blocks, H H, are also hinged, to fold outwards, the stand can be stowed into even a smaller space, as the feet will fold over on to D and C, and the rail, G, can be placed higher up, thus allowing the hinges on D and C to be also placed higher up, thereby permitting them to fold smaller. One particular thing must be remembered, the distance from the hinge on the end of the rail, G, to the middle of that rail must be the same as the distance from that hinge to the hinge in the middle of the upright supports—I mention this in case the rail, G, should be required shorter on account of the wide spread between the feet at the bottom of D and E. To fold the stand, close together D and C by pushing upwards the middle of G—the feet will fall together. Then release C and fold over the bottom halves of D and C. Figs. 5 and 6 show how D and C are hinged to the triangular frame at the top of the stand. As you want a light stand do not have the rails, with the exception of D and C, more than $\frac{1}{2}$ in. thick.—**J. S.**

Banjo Book.—**G. D. F. (Sheffield).**—You say that you are about to make a six-stringed banjo, and would feel obliged for information where to purchase a book of instructions. I suppose you require a book teaching you how to make a banjo, if so, there is no book published on that subject. I have a paper in hand on banjo making which will appear in this journal as soon as I can find time to finish it. If, on the other hand, you require a book of instructions how to play the banjo, there is one for the five-stringed banjo by Ellis, price 2s. 6d.; ditto by Ballantine, 1s. 6d.; ditto by Roylance, in two parts, 1s. each. For six and seven strings there is Ballantine's, 2s. 6d.; Ellis's, 1s., also one at 6d.; W. Williams', 1s.; and many others, which I will mention if required.—**J. G. W.**

Patent Agent.—**E. W. M. (Redhill).**—I cannot undertake to mention in these columns any firm of patent agents, but if you send a stamped and directed envelope to me I may be able to help you.

Electrotypes.—**A. W. (Manchester).**—Your electrotypes, 7 in. by 4 in., should have a shell of at least 22½ grains in the square inch, or about the thickness of No. 32 B.W.G. This will take 630 grains of copper. As copper is deposited at the rate of 18 grains per hour ampère of current, it follows that you must have a current of 35 ampères to get the required deposit in an hour, or a current of 1 ampère flowing for 35 hours through your solution. If you wished to get 630 grains deposited on 28 square in. in an hour, you would have to connect your mould by means of thick copper straps to a source of current capable of yielding 35 ampères per hour, because the conductors must be able to carry the current at a pressure of not more than 1 volt. If copper is deposited at a high pressure, it is apt to be unsuitable for electrotypes. You will see from the foregoing that it will be difficult for me to say how long it will take to properly coat your moulds with copper whilst using current from the two Daniell cells described in your letter. The cells will only yield a current of 2 ampères on a short circuit, and this would be very much reduced by the resistances of the conducting wires, the coating of the mould, and the depositing solution. I advise, therefore, that you make up three such cells as you propose; connect these in series to start the deposit, until the mould is covered; then connect several wires to various parts of the mould and arrange your cells in parallel with connecting wires and anode to finish off deposit at a higher rate. Connecting the cells in series means connecting the zinc of one to the copper of the next, and so on through the series. Connecting in parallel means connecting all the copper of the cells to the anode, and all the zincs to the wires leading to the mould. The best rate to obtain a good tough deposit is found by actual trial, as experience alone can teach you how to use your own tools to the best advantage.—**G. E. B.**

Clock Regulating.—**CLOCK.**—Having shortened the pendulum, you must make it up by putting a new wheel, or wheels, or pinions. If a new scape wheel was put it would, perhaps, be sufficient, but then you would almost be certain to find the pallets would not suit; another third wheel would probably correct it. If you will take your clock to pieces and count the number of teeth in the scape wheel, the next or third wheel, and the one with the long spindle which carries the hands and is called the centre wheel, also the number of leaves in the scape and third pinions, also give me the exact length of pendulum at present, I will tell you then how you can alter it to make it go correctly. The cost would depend on how many wheels or pinions would have to be changed, also by who did it; and when I know what will be required I will tell as near as I can the price it should be.—**A. B. C.**

Lantern Slide Painting.—Several having written asking for instructions on this subject, I will place the required information in the hands of the Editor at an early date.—**O. B.**

Repoussé Work.—**M. S. (Gateshead).**—Haslope's "Repoussé Work," 2s. 6d., 170, Strand; Gawthorp's "Hints on Repoussé Work," 6d., 16, Long Acre. At the latter address illustrations and prices of the kind of tools required may be obtained gratis.—**J. G.**

Phonograph.—**A WOULD-BE ELECTRICIAN.**—The old-style phonograph, with tin foil cylinder, may now be bought for some 40s. or 50s., or perhaps less. Advertise for one in the Sale and Exchange column

of WORK. It is being superseded by the more modern graphophone."—**G. E. B.**

Stationery Holder.—**M. A. (Suffolk).**—I daresay you will find this stationery cabinet suitable for what you require. I do not think there is anything exactly like it in the market, my purpose being to give you something a little fresh. I have taken it for granted that you want it to contain foolscap, as well as note-paper and envelopes; and I have also shown a date box, and penholder, and ink-bottle shelf. Foolscap and other large sheets can be placed in the large compartment, envelopes in the top spaces on each side, and note-paper in the spaces under them. The length of the large compartment should be about 13½ in.; depth, 8½ in.; and the width, 4½ in. The compartments on either side will be 4½ in. long, 2 in. wide, and about 4½ in. deep. I have not drawn this sketch to true perspective, so that you will find both sides of the various parts of it are exactly similar and the same size. To reproduce the design the required size, draw a number of squares, any size, but all of equal proportions, on a sheet of plain paper; then draw the same number of squares on this small sketch. You will then find it is not a very difficult job to copy it. Or you might use a pantograph, one of which is described in "Shop" in No. 42, page 669. If, however, you cannot accomplish the enlarging, I will draw out full-size designs (which it is almost impossible to do in the pages of WORK) and send them you, if you will forward me your full address, through the

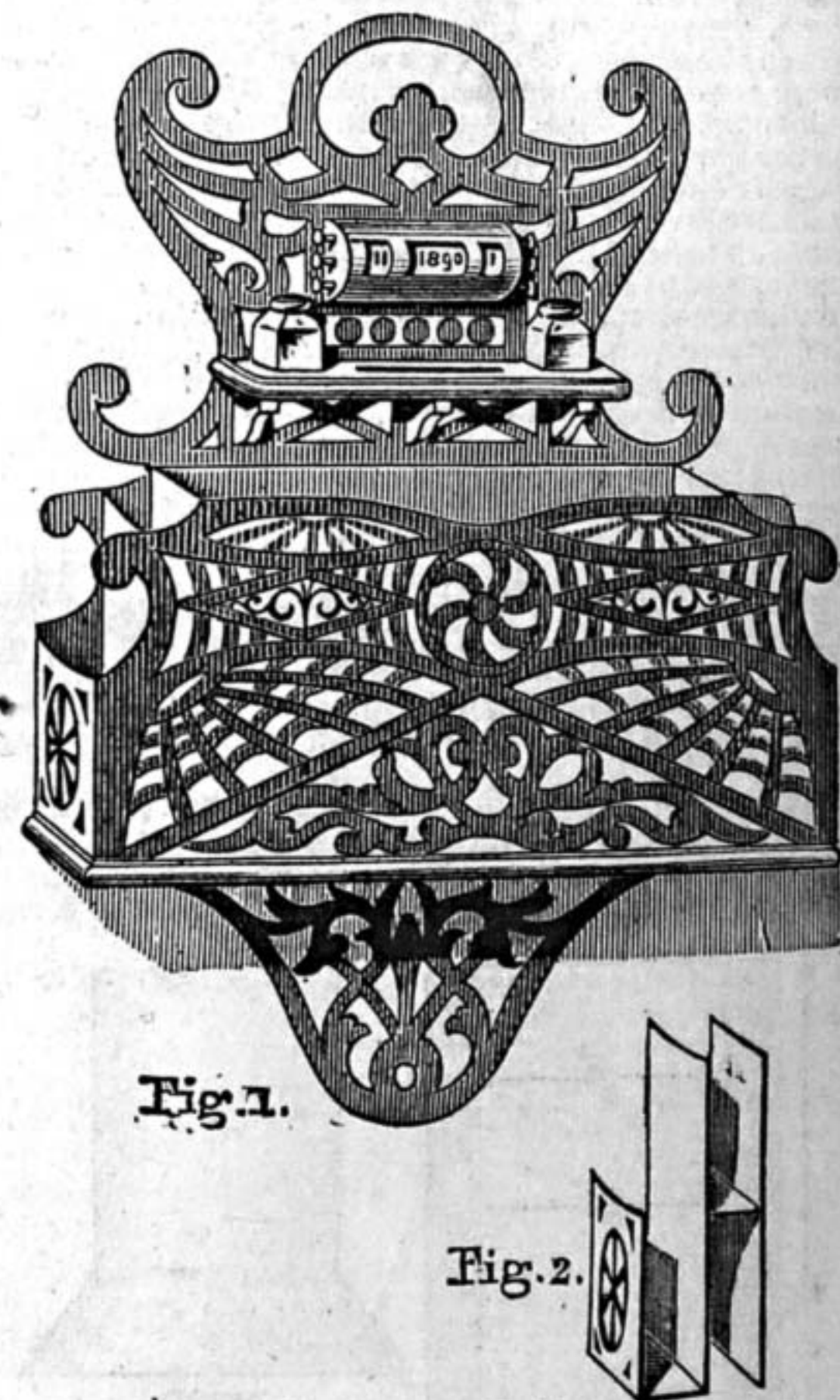

Stationery Holder.

Editor. The small shelf may be of any size, and should be shaped to admit the ink-pots, and also for the penholders. You might purchase a small date box and attach it—they are so cheap that it is needless to make one. Fig. 2 shows the boards necessary for each side; you can tell the sizes of them from the dimensions I have given for the compartments. I have shown this as an article to hang on the wall, but, by leaving out the fretwork below the bottom of the compartments, it can be made to stand on a table. If you have it as this latter, I should advise you to fret-cut the other side the same as the front, and have the top fretwork running along and down the middle of the foolscap compartment, thus dividing it into two. To give it an effective appearance, you might fasten some nicely-coloured silk, satin, or velvet behind all the fretwork.—**J. S.**

Magic Lantern.—**MARION** asks for instruction to make a magic lantern for home use. This is too big a subject for "Shop." I am, however, preparing an article on the subject, which will, I think, help MARION and others. I also intend to describe various appliances to use with it, such as microscope, polariscope, etc., by the use of which interesting objects which are usually seen by one at a time may be viewed by a number at once.—**O. B.**

Intensity Coil.—**J. M. (Nottingham).**—To get three separate strengths from your coil, bring out the finish end of the first coil to a binding stud on the base of the instrument. To this same stud connect the commencing end of the second coil, and bring the finish end out to a second stud. To the second stud attach the commencing end of the third coil, and bring the finish end out to a third stud. If now you have a switch lever to move from one to other of these studs, you may get at pleasure a shock from one, two, or three coils, all differing in strength.—**G. E. B.**

Painter's Easel.—F. B. F. (Oswestry).—The space you require an easel to fold into is very small, but still I have managed to design the one here shown. Before giving sizes, I must explain the construction, as no doubt you will look at the drawings for a long time in vain if I do not do so. Fig. 1 shows it open, and a firm job will be the result if made properly. To fold it, A, A, A are pushed inwards and upwards; then E, E, E are pushed upwards, at the same time closing together B, C, B, C, B, C; then D (which is shown by itself in Fig. 3) falls downwards through the grooves in C, C, C, to the notches in the tops of B, B, B; after which C, C, C, fold outward over B, B, B. A glance at Figs. 1 and 2 while reading the above will fully explain. The total length of each leg or upright might be five feet, width two inches, thickness one inch; but, of course, you will know what dimensions will suit you best. They might be rounded on the top; and after the necessary grooves, etc., are cut, they should each be divided into three equal parts, and hinged to fold as described above. Unless you have the cross rails, E, E, E, the easel will be almost useless; and you must have these to fold upwards, as in Fig. 2, otherwise they will be of little use. To allow them to be pivoted and to work properly, you must cant the sides of B, B, B. You will require several hinges (twelve in all) and six pins or rivets, but this cannot be helped, unless you have it

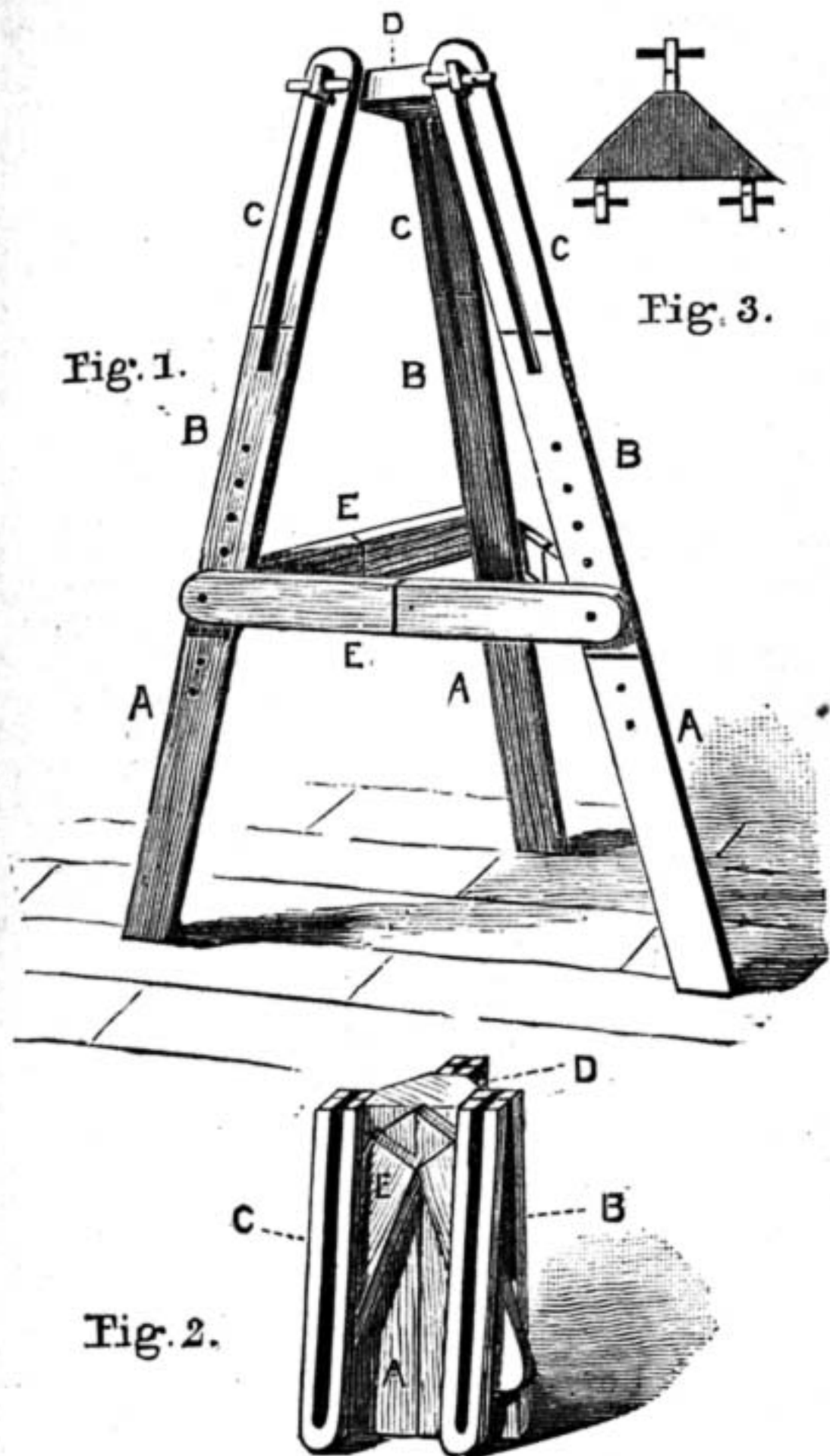

Painter's Easel. Fig. 1.—Easel expanded. Fig. 2.—Easel closed and folded. Fig. 3.—Movable Block at top of Easel.

to fold up into a longer compass than you asked. You can accomplish this by either preserving A and B all in one piece, or by leaving this as shown, and having B and C in one piece (which will then not require any grooves in them). In this easel no piece comes right apart from its fellow-pieces, and this is what I always aim at in designing such things. You might, by a little thought, manage to pack it into a smaller compass, by having the various pieces to detach from each other, but, by doing so, you might find when you settle on a spot in which you wish to sketch, that you have left one or more of the pieces behind you. How then? According to the length and position of the rails, E, E, E, so depends the stretch you will have between the legs, and, consequently, the angle at which your canvas will be when upon the peg, for which latter bore as many holes as you please in B and A. I should advise you to do as I have done—make a small rough model of it with some ordinary firewood. Then you will be able to determine whether one according to the pattern will suit you, and also get at the length you will prefer, E, E, E. These latter rails must be as thin as possible, as C, C, C, fold over the ends of them, and will, of course, prevent their laying quite flat. The pin at the back of D will have to be longer than the others; and all three should be strong and thin. To get more slope for your canvas, you should shorten the back leg. To open it, you will, of course, reverse the order of folding it. It is almost unnecessary to say that it must be made in a good strong wood, and that the hinges must be nicely fitted and strongly screwed.—J. S.

Mandoline Making.—MANDOLINE (London, E.C.).—The name of the instrument you have sketched is called the Bandurria, and is strung with six double strings; the 1st, 2nd, and 3rd are gut, the 4th, 5th, and 6th are silk covered with wire. You have only marked eight pegs, therefore I presume the one you require describing is the Neapolitan mandoline strung with four double strings; the 1st and 2nd are thin steel, the 3rd and 4th are steel covered with wire, and tuned the same as a violin, G, D, A, E. The American style of mandoline will be much the easiest for you to make (see sketch), so I will confine myself to description of that alone. The first thing that you must do is to make a full-sized drawing of the instrument on a piece of paper or board to sizes marked on sketch; you can make it larger if you choose, but you must remember that the larger you make it the lower in pitch it will have to be tuned. The depth from back to belly, say, 2½ in., or to your own fancy. Having drawn out the outline, draw a line across finger-board where the nut will come; the nut is the strip of wood or ivory at the extreme end of finger board which supports and keeps the strings in position, then mark the bridge 4 in. from bottom. The next thing to be done is to mark off the frets. Take a pair of compasses, or spring dividers in preference, and divide the distance from the nut to the bridge into eighteen equal parts, that is to say, set your dividers to about 1/18 in. from point to point, and putting one point exactly on the inside of nut, work the dividers along the drawing until you come to the bridge, counting as you go along. If the point of the dividers at the eighteenth part finishes exactly on the bridge, then the distance between the points of your dividers will give you the exact distance from the nut to the first fret; if the point of dividers comes short of the bridge at the eighteenth space, you must open them a shade and try again until you do get it right; or if they come over the bridge *vice versa*. Having marked the first fret, divide the space from the first fret to the bridge into eighteen parts, that will give you the distance of the second fret from the first, and so on with the rest of the frets, dividing the space from each fret to the bridge until you get as many frets marked as you require. You can put more frets than are shown in sketch; if you put seventeen frets you will get the notes, C, G, D, A, at the seventeenth fret. Having marked the seventeen frets, mark the sound hole in place; make it about 2 in. in diameter, letting the edge come close to the seventeenth fret. You will now have a working drawing from which you can make any number of instruments of that particular size. The frets may not be absolutely correct according to the science and theory of music, but you will find them practically so. The neck could be made out of a piece of walnut, beech, mahogany, or other hard wood; the belly of Swiss pine, or, failing that, a piece of nice dry pine; the back and sides of sycamore, walnut, rosewood, maple, etc.; the finger-board, ebony or hardwood stained black. In drawing out the neck you can make it a little wider where it joins the body of the instrument, say, 1½ in. or 1¾ in., tapering down to 1¼ in. at the nut. Get a block of wood 2 in. thick and a little larger than the outline of your drawing (hard wood will be the best; failing that, a piece of pine would do), plane it up true, then draw the outline of body of instrument upon it, take it to a sawmill and get it cut out with a fret saw. You will now have a mould cut to the exact shape that you want your instrument to be when finished (see Fig. 2). Cut out the piece for sides or ribs 2½ in. wide, ¼ in. thick; clean up the side of piece that will be the outside of instrument when finished; make it as hot as you can without burning it, then bend it round inside the mould, taking care to keep the side that is cleaned up next to the mould. You will require small iron cramps to fix round the mould to pull the veneer to the shape of mould, or, failing these, notch out some pieces of wood wide enough to clip over the inside and outside of mould; cut some wedges, and drive in between notch and outside edge of mould. If you cut the narrow part of mould longer than you require the body of mandoline, it will give you room to get your sides in and to pull them to shape. Now take a block of wood, fit it tight in narrow part where the neck joins the body (the neck is fixed to this block), make it the exact depth of sides, take out the block, and cut a taper groove in it 1½ in. deep; the groove at the part of block that comes against the belly must be ¼ in. wide, tapering to 1/8 in. at the part that touches the back. The reason for tapering the groove in block is that when the neck is properly fitted and glued in it is held fast and prevents the strings from pulling it forward. Glue in the block. Take a strip of veneer 3/8 in. wide and glue it on the inside of sides all round, again using the cramps. When the glue is dry dress off level with sides, make a piece of pine 1/8 in. by 1/8 in., and long enough to go across at the widest part; notch a little out of the fillet that goes round sides, cut the piece of pine tight in at widest part, notch a piece out of each end to allow it to drop down level with sides, and glue in. This piece helps to support the back and prevents it from getting split or smashed in. Prepare the wood for back, mark and cut to shape, and glue on. Allow the narrow part of back long enough to cover the heel of neck when it is fixed, and dress off after the neck is fixed. Prepare the neck, letting the part that joins the body of instrument be deep enough to meet the back; cut a tenon on end of neck; taper shape to fit groove in block tight; the face of neck must be level with top of belly when fixed. If you are going to use a machine, cut out the slots in head, boring the holes for the

barrels of the machine to go through and screw on (see sketch); or the machines can be screwed on underneath the head, and holes bored for the barrels to come through; the barrels of the machine will then project like ordinary pegs. If preferred, pegs can be used instead of the machine; the last named is the best for the mandoline, steel strings being easier to tune with the machine; the least move of a peg will throw them up or down a lot in pitch, much more so than gut strings. Glue in the neck, cut the belly to shape, glue a fillet along the inside of top edge of sides, fit a piece of pine across the widest part about where the bridge comes, glue in, fit a block at bottom end of instrument to support the pins that hold the ends of strings, glue in, then glue on the belly, first cutting the sound hole. After the back is glued on, the body can be taken out of mould to fit the neck, but before taking it out of mould it will be advisable to glue the fillet round the sides for the belly the same as was done for the back. Having got the belly glued on, dress off the neck level with belly, and the edges of belly and back level with the sides; prepare the piece of wood for the finger-board, about 1/8 or three 1/16 in. thick, making it long enough to come to the edge of sound hole; glue it on, dress off level with the neck, cut a groove across the neck for the nut, made

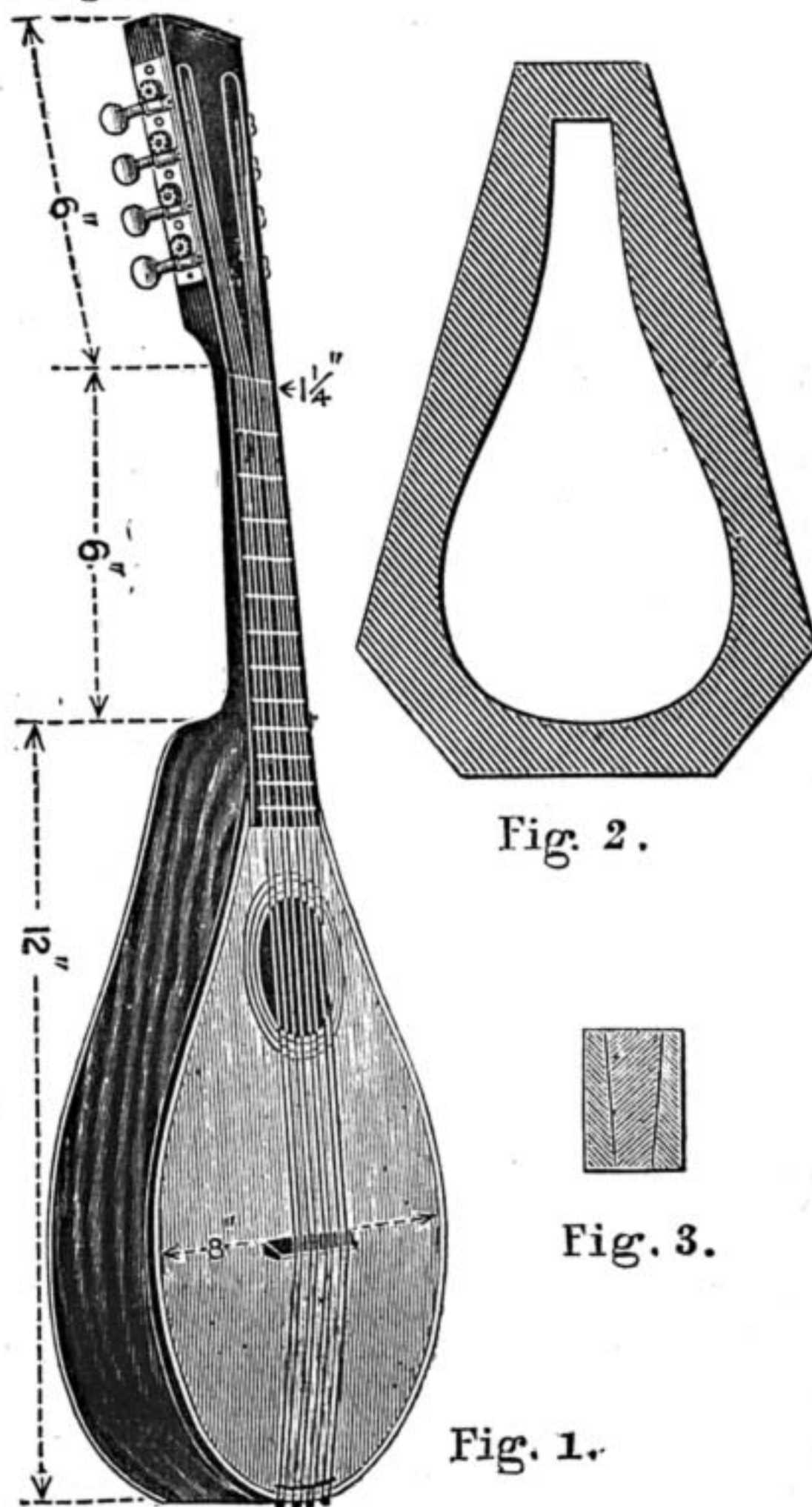

Mandoline Making. Fig. 1.—Mandoline. Fig. 2.—Mandoline Mould. Fig. 3.—End of Neck showing bevelled tension.

ditto out of ebony or ivory, and fix; mark the frets on neck, and cut the grooves for the fret wire with a fine saw; be sure the wire fits the grooves tight or the frets will drop out. The best fret wire is made of German silver, and can be bought at music warehouses. The best way to mark the frets off the drawing on to neck of mandoline is to lay a thin narrow strip of wood on drawing, mark the frets on strip, then lay the strip on the neck and mark it. Be sure you cut the grooves for frets square across. After fixing fret wires, file off the corners so that they do not cut the fingers in running along the neck. Next bore holes at the bottom of instrument for the pins to fix the strings to. Small round-headed screws would do, or ivory pins can be purchased. Four pins only will be required, each pin holding two strings. Clean up and polish to your satisfaction, and then put on the strings; the first is fine steel, the second a trifle thicker, the third a thin covered string, the fourth a trifle thicker. Make a bridge same as one in sketch, and put exactly the same distance from the nut as you have in your working drawing; if you do not, your frets will be all false or out of tune when you finger the strings. I forgot to say that the back and belly should be 1/8 in. thick or a shade under that thickness. Tune up your instrument, purchase a plectrum (a piece of tortoiseshell to strike the strings with), get an instruction book, and practise diligently. The more you play on your mandoline the better you will like it, and also be able to show it off to your friends to the best advantage. If there is anything in this you do not quite understand write again, and I will endeavour to put you right.—J. G. W.

Modelling Wax.—LOVER OF WORK (*Manchester*).—An ordinary modelling wax may be made with beeswax and Venice turpentine—say, in the proportion of three to one—melting in an earthen pipkin, and stirring with a tallow candle. The colouring matter (Venetian red, or whatever may be preferred) should be stirred in whilst the composition is hot. A harder or a more plastic material may be formed by varying the proportions of wax, Venice turpentine, and grease. The composition is highly inflammable, and needs much care in the melting. If a small quantity of wax only is required, it is better to buy it ready prepared from the artist's colourman.—M. M.

Battery for Incandescent Lamp.—J. D. N. (*Glasgow*).—Kindly see replies to other correspondents on this subject, and read carefully my future articles on "Model Electric Lights."—G. E. B.

Castin^g Lead Caps to Leclanché Carbons.—N. M. (*Hirwain*).—After casting the lead caps, whilst the lead and carbon is still hot, well coat the cap with Brunswick black, and let this soak into the carbon just below the cap, so as to form a black band $\frac{1}{8}$ in. wide all around the top of the carbon. If the caps and carbons are cold, first make them scalding hot before applying the Brunswick black. If treated in this way they will work for two or three years or more without showing signs of corrosion.—G. E. B.

Battery for Coil.—H. E. A. (*Hackney*).—(1) You cannot have a handier battery for a coil. Of course, the solution will become exhausted after the battery has been used several times. The cells must then be recharged with fresh solution, and the zincs reamalgamated. (2) Leclanché cells are not suitable for working large coils, but two cells might work your small coil. (3) You will get no good effect from the second coil by sending into its primary a current from the secondary of the first. You must have a longer coil to get stronger effects. Am glad to hear of your success with the electric bell.—G. E. B.

Windmill for Electric Lighting.—WINDMILL (*Kent*).—A windmill is rather an unsteady and unreliable motor for the purpose. However, as you intend trying it, allow me to give you a few hints in its construction and mode of working. The speed of the windmill itself may be partially controlled by a series of levers connected with the vanes of the mill and a ball governor. As the speed of the mill increases, the vanes are opened, and thus less surface is exposed to the wind. Any engineer will tell you how to do this. The speed of the machinery to work the dynamo may also be regulated by a pair of cone pulleys and shifting strap worked by levers controlled by ball governors. The strap is shifted by the varying speed from one part of the cone pulleys to another, and thus corrects any great increase or decrease in the speed. The device is in use at potteries and elsewhere, but I have not time or space to describe it here. Even with the speed of the mill thus regulated, it will be advisable to adopt the precaution of having a fusible cut-out in circuit with your dynamo and lamps, to provide against overheating the carbons with a sudden rush of current.—G. E. B.

Varnish.—KING BRUCE.—Sorry I cannot oblige you with the recipes you ask for. I do not believe in the policy of "home-made" varnishes, but in your case I fancy there is every reason to persevere. The nature of your goods requires something which will quickly harden and keep quite free from stickiness, hence a methylated spirit varnish is, I think, the only safe direction to work in. The best commercial "white hard" is used for light woods, fancy work, etc., and the brown hard for dark woods. The colour appears to trouble you most. I can only advise you to seek counsel with a thoroughly experienced French polisher, one who makes his polishes, and see what he advises for colouring. I should think the stained varnishes would be as cheap as anything for you, and these spirit varnishes are, I believe, least liable to blister for your purpose. Besides the above commercial varnishes, there is on the market a "patent glaze," used by brush makers for finishing work, previously coated with white or brown hard. If you do not succeed in getting the aid I indicate, write me through the Editor and I will try some of the leading varnish makers for help.—DECORATOR.

Steel Bronzing.—NEMO (*Manchester*).—It is a very difficult matter to both understand your question and answer it with any degree of confidence. Having submitted it to Mr. G. E. Bonney—our able writer on all that appertains to plating—who does not know of any such process whereby brass and iron may be "steel bronzed," the representative of "the brush" appends a few lines which may assist you. I suppose the surface you wish to get is a bright steel appearance and not like oxidised silver. I have covered wrought iron grille work with silver leaf to imitate the solid *argent*, and have also treated modelled, decorative materials to get "steel" colours and effects. Silver leaf is laid, like gold leaf, upon *gold size*; but silver discolours very rapidly, and should be coated immediately after laying with a solution of white shellac in methylated spirit. "Silver bronze," so called, in powder and liquid forms, can be bought which are much nearer steel, in colour, than the silver leaf. The powder is rubbed with a piece of wash leather upon copal varnish when nearly dry. A coat of grey colour quick drying paint before bronzing is advisable. Silver can be lacquered down by stains in the varnish if desired.—F. P.

Oval Drawing.—A. B. (*Clapton Park*).—You give me a diagram, not of an oval, but of a segment either of a circle or an ellipse, which I cannot determine; you do not say what you require it for, so I am almost inclined, like most people do when they are asked a conundrum, to "give it up." Still, you want some information, and though you have not asked for it properly I will do what I can to supply it, and, if you find it is not exactly what you require, write again, and explain as fully as possible what you do want. Firstly, an oval, or, more correctly speaking, an ellipse, is the periphery of a section of any cylinder or cone which is not parallel to the base or the axis, and which does not intersect the base. It is the only conic section which occurs in the cylinder also. To make this clear, Fig. 1 is a cone, Fig. 2 a cylinder; the line, A B, in both shows the plane of an ellipse; A B dotted line shows another elliptic plane; if through either of these lines (or any other line which is neither parallel to axis or base, and does not intersect it) you saw the solid into two, the pieces sawn will show an ellipse, and if laid flat upon paper and a line in pencil be drawn round it on the paper, such line will be a true and perfect ellipse. Now according to the angle at which the section is cut, so will the proportion of the ellipse be; the nearer it is to a parallel of the base, *i.e.*, square

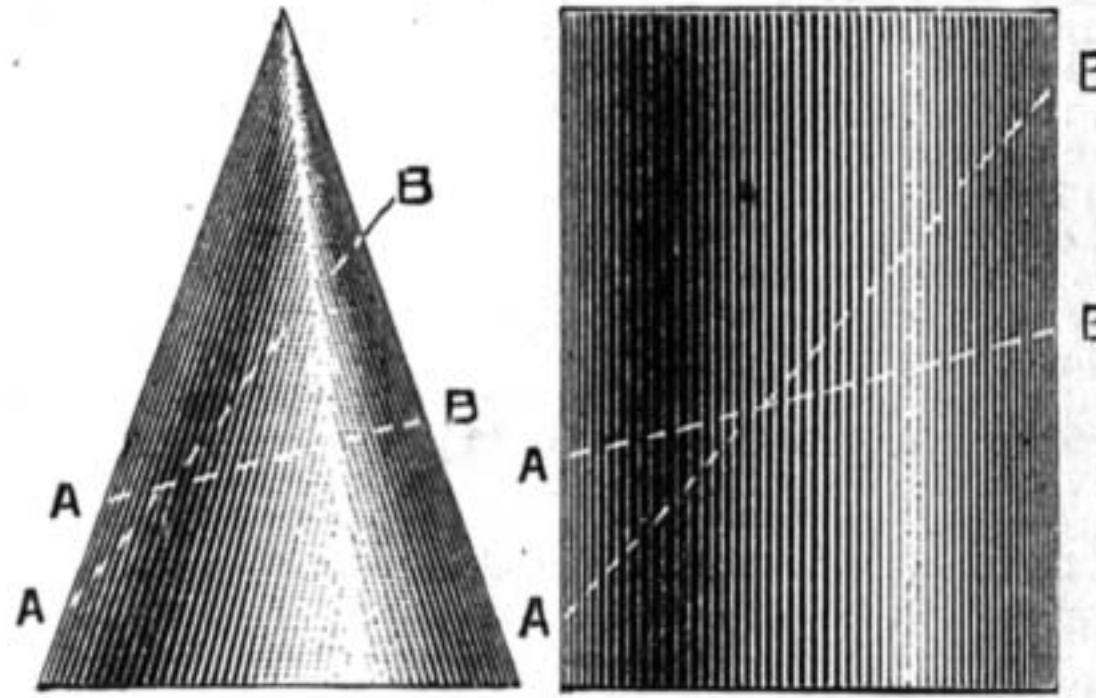

Fig. 1.

Fig. 2.

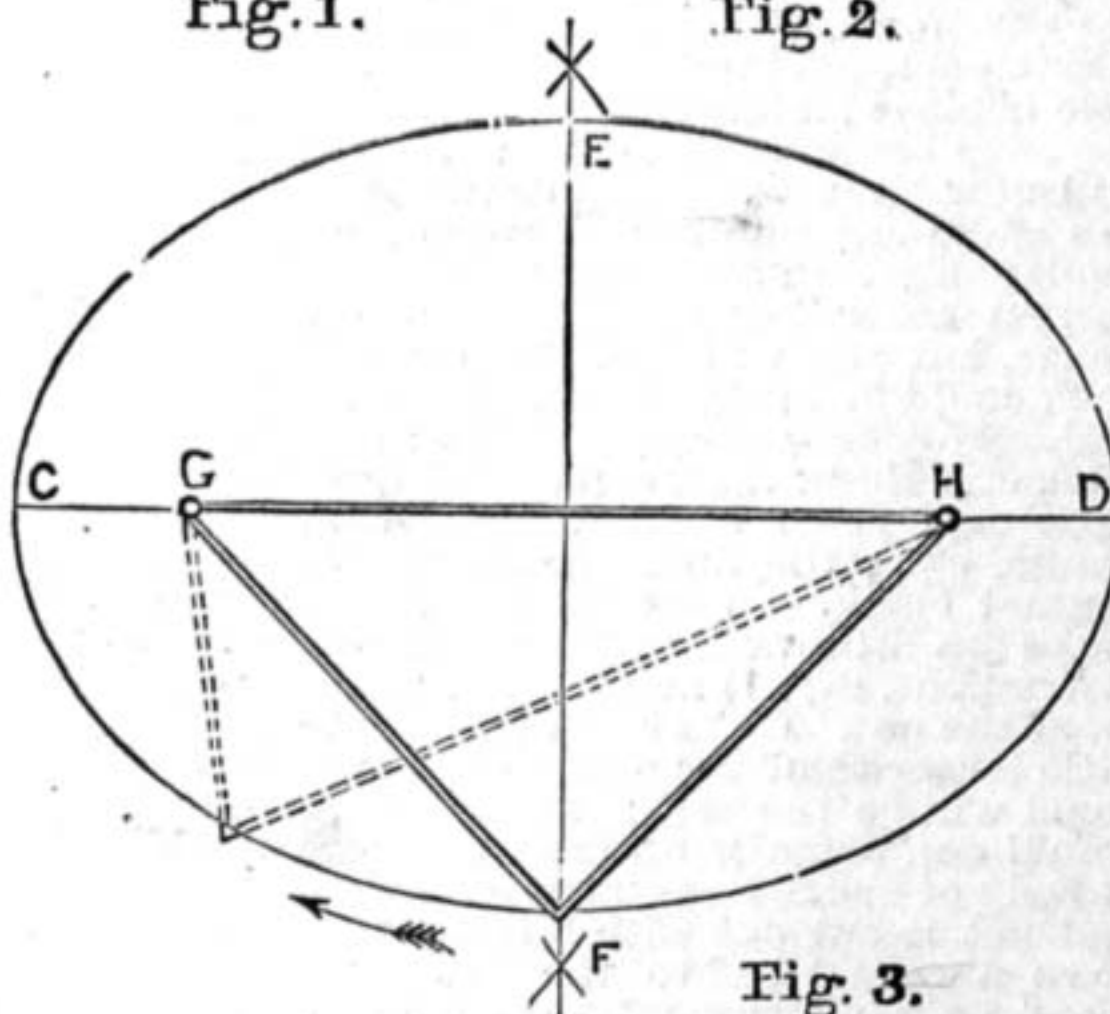

Fig. 3.

Oval Drawing.

with the axis, the nearer does it approach to the circle—which we know the base of both cylinder and cone are, as it is one of their definitions. The converse, the more acute the angle of the section with the axis of the cone or cylinder the more removed the ellipse becomes from the circle—that is, the longer it becomes in proportion to its width. So much for proportion. Now for size. As any circle may be drawn from a centre with any radius you like—inches, feet, miles, degrees, etc.—so can an ellipse be produced, but it must be from two centres influencing one another. Mathematically, it can be proved that if the major and minor diameters of an oval be known, or decided upon, or given, the two centres, or "foci," as they are called, can be found and the periphery drawn correctly from them. Practically the rule is to draw a line representing the major diameter—*viz.*, the extreme length of the ellipse—and then bisect it at right angles, *i.e.*, divide it exactly into two equal parts and draw a line square with it through this point; now take half the minor diameter, and from the bisection mark off the two ends of this diameter, *i.e.*, get the length of the width of intended ellipse, centered at right angles (square) to the length; mark in pencil (see Fig. 3) these points thus, C D, E F; these may be omitted when you have thoroughly come to understand the method of working. Now, C D represents any length you like, and E F any width you like. Now you take in the compasses as length half of C D, and with one leg at E describe a small arc crossing C D, and again with the same leg at F do the same. If your lines, C D and E F, are exactly at right angles, and correctly bisected, these short arcs will intersect exactly upon the line, C D; if not, you have not been sufficiently accurate, and you should erase the line, C D, and re-draw it through the intersections of the arcs, taking care that the points, C and D, are equidistant from the line, E F. Now into the board on which your paper is fixed put two strong needles

or pins at the intersections of the arcs, *viz.*, at G and H, firmly pressing them until they are rigidly fixed; then stick another pin at E or F, and tie tightly round them a piece of inelastic thread, so that it cannot stretch. This forms a triangle, inside which, after removing the third pin, at E or F, place a sharp-pointed pencil, and, keeping the point in contact with both paper and thread, bearing outwards, draw the line the thread compels you to draw; such line will not only pass exactly through the points marking the major and minor diameters of the ellipse, but can be demonstrated to pass through all other points of the true elliptic orbit. Further, all ellipses so drawn, either inside or outside this ellipse, where the proportion of major to minor diameter is the same, irrespective of size, will, and must, be parallel to the first. As an additional proof of this method, if you are curious on the matter, I give you a means whereby you can describe—that is, draw—an ellipse mathematically correct from (apparently) one centre, of any size or proportion you want with a pair of pencil compasses only and a piece of turned wood, or, in fact, any cylinder. Hold firmly a sheet of stiff paper round your cylinder, and, with any radius you please, try to turn a circle with your compasses on the curved surface. Result, a true ellipse when the paper is once more flat!—J. W. H.

Paint Addresses.—PAINTER.—Messrs. Aspinall's factory is situated at New Cross, London, S.E. As the specimen colour cards—which the student of colour was advised to procure in connection with the papers on "House Painting"—issued by Aspinall are doubtless made up at some considerable expense, you cannot expect to get one with every 10d. pot. The retailers have a limited number given them, and they naturally go to the best customers. If you wrote direct to the firm for one and enclose a few stamps I daresay you would get one. The best book on sign writing yet published is the "Art and Craft of Sign Writing," 21s., published at 15, St. Anne Street, Manchester. Crosby Lockwood & Son, 7, Stationers' Hall Court, E.C., publish many works dealing with writing, graining, and decorative art; write for catalogue. The first named and latest published, "The Art and Craft," is thoroughly reliable, and a sound investment to a working man.—DECORATOR.

IV.—QUESTIONS ANSWERED BY CORRESPONDENTS.

Boat Building.—E. L. R. (*Oxford*) writes to BOATHOOK (*Manchester*) (see page 30, Vol. II.):—"The fault of your boat is you have not given it enough floor. Such a boat as that requires a deal of floor, something of this shape, except just fore and aft. The only thing you can do is to pull it to pieces and build another. You should get someone to show you a boat of that sort. As to width, length, and depth, that is all right."

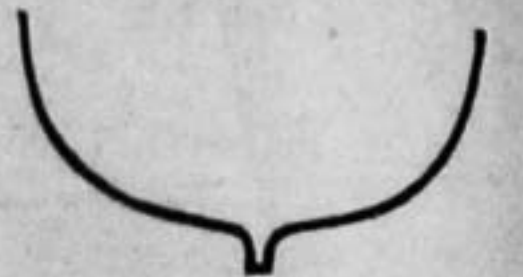

Boat Floor.

Cutting Music for American Organette.—HERR VON MUTZ writes in reply to AMATEUR MUSICIAN (see page 814, Vol. I.):—"I infer from your *nom de plume* that you know a little of music, if so, it will serve you. There are rules for harmonising melodies, but they and their exceptions would occupy a whole number of WORK, for they are embraced in the extensive subjects—'harmony' and 'counterpoint.' To use an accompaniment of common chords similar to what you have got would have the effect of the 'vamp' on a banjo, and be entirely unsuitable for an instrument with a sustained tone like the organette. Why not cut your sheets from music already harmonised, pianoforte music, or, better still, music arranged for the English concertina? I do not know the compass of your instrument, or I could advise you better. However, you could not do much better than use music arranged for the latter instrument, as there is much of it arranged in four-part harmony, and is very effective. I have cut excellent pieces from it myself. Boosey & Co. and Chappell & Co. publish a variety of shilling books. I can recommend Boosey's 100 secular airs, 100 sacred airs, and 50 national and patriotic airs—the latter is excellent. Certainly, if your instrument is not chromatic you would require to transpose some of the airs into the key your instrument is arranged in. This would not be a difficult matter, granting you have an acquaintance with music. Suppose your instrument be in C, and a piece you selected be in D, you would simply lower all the notes in the piece one note; if in A you would raise all the notes a third, and so on with all other keys. In setting out the music, you would use a strip of stout paper wide enough to pass freely beyond the width of the reeds, and long enough to contain the tune and a short blank for joining the ends to make it continuous. Then set out a staff or template marked to the distances the centres of the reeds are apart, faintly line out the length of your sheet from the staff, afterwards set out the number of bars in the tune in equal divisions, remembering that the wider your divisions the quicker you will have to turn your sheet through, and the more power you will get from the bellows, and *vice versa*, so you will have to determine a suitable pitch of the bars for your instrument. Afterwards sub-divide the bars to obtain the length of the different notes; be careful to leave a slight distance between the different notes or chords to detach them, except where a slur is marked on the music."

LEWIS & LEWIS,

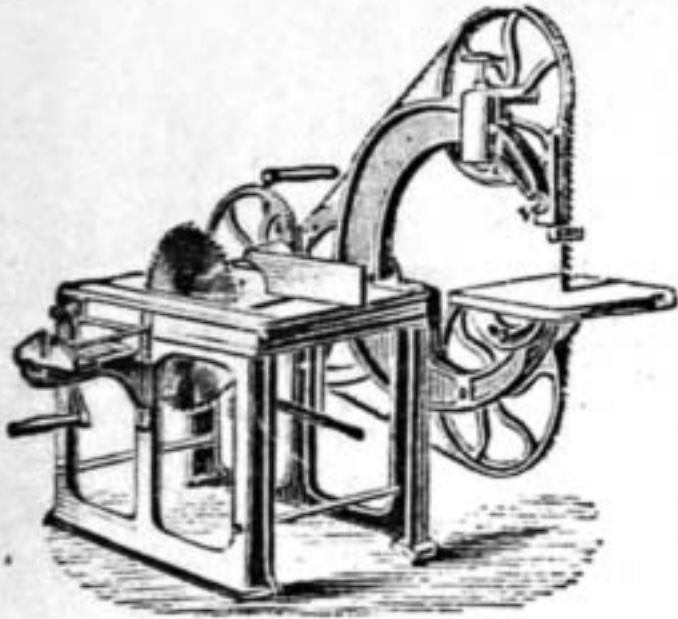

ENGINEERS,
CAMBRIDGE
HEATH,
LONDON,
N.E.

THE "ANERLEY"
COMBINED
CIRCULAR AND BANDSAWING
MACHINE,

For Hand or Power, will take in 22 in. Circular Saw, and will cut by hand-power up to 5 in. deep.



THE "HACKNEY"
MORTISING & BORING MACHINE,
With 8 Chisels, 1 Coredriver,
Key, 3 Augers, and 3 Drills.



FRETWORK PATTERNS.

FRETWORKERS who appreciate First-class Designs should write for our Catalogue of nearly 400 Patterns, admitted to be the best in the Trade. Catalogue sent post free on receipt of 4d. stamps. List of Tools and Materials is also enclosed.

BOOTH BROTHERS,
TOOL MAKERS,
DUBLIN.



HENRY MILNES,

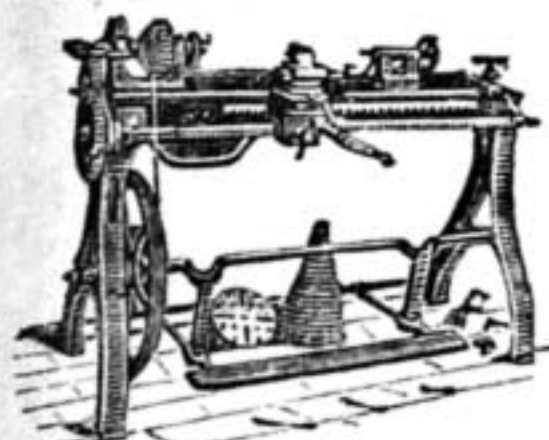

MANUFACTURER OF
HIGH-CLASS LATHES
FOR
SCREW-CUTTING & ORNAMENTAL TURNING
TREADLE MILLING MACHINES, HAND
PLANING MACHINES, &c.

Ingleby Works, Brown Royd, Bradford.

ACCURACY AND LIGHT RUNNING GUARANTEED. ESTABLISHED 1858.

ESTABLISHED 1851.

BIRKBECK BANK.

Southampton Buildings, Chancery Lane, London.
THREE per CENT. INTEREST allowed on DEPOSITS, repayable on demand.
TWO per CENT. INTEREST on CURRENT ACCOUNTS calculated on the minimum monthly balances, when not drawn below £100.
STOCKS, SHARES, and ANNUITIES Purchased and Sold.

HOW TO PURCHASE A HOUSE FOR TWO GUINEAS PER MONTH or A PLOT OF LAND FOR FIVE SHILLINGS PER MONTH, with immediate possession. Apply at the Office of the BIRKBECK FREEHOLD LAND SOCIETY, as above.

The BIRKBECK ALMANACK, with full particulars, post free on application.
FRANCIS RAVENSCROFT, Manager.

DELICIOUS TEMPERANCE DRINKS.



Mason's Non-Intoxicating Beer.
Mason's Wine Essences produce in a few minutes a delicious Temperance Wine or Cordial, Ginger, Orange, Raspberry, Black Currant, Lime Fruit, etc.

One Tablespoonful of Mason's Extract of Herbs makes one gallon of splendid Beer, refreshing and non-intoxicating.
A Sample Bottle of either Essence or Extract sent on receipt of 9 stamps, or a bottle of each for 15 stamps.

AGENTS WANTED.
NEWBALL & MASON, Nottingham.

MANUALS OF TECHNOLOGY.

Edited by PROF. AYRTON, F.R.S., and RICHARD WORMELL, D.Sc., M.A.

- THE DYING OF TEXTILE FABRICS. By J. J. HUMMELL, F.C.S. With Numerous Diagrams. Seventh Thousand. 5s.
- STEEL AND IRON. By W. H. GREENWOOD, F.C.S., M.I.M.E., &c. With 57 Diagrams from Original Working Drawings. Fourth Edition. 5s.
- SPINNING WOOLLEN AND WORSPED. By W. S. BRIGHT MCLAREN, M.P. With 60 Diagrams. Second Edition. 4s. 6d.
- CUTTING TOOLS. By Prof. H. R. SMITH. With 14 Folding Plates and 51 Woodcuts. Third Edition. 3s. 6d.
- PRACTICAL MECHANICS. By J. PERRY, M.E. With numerous Illustrations. Third Edition. 3s. 6d.
- DESIGN IN TEXTILE FABRICS. By T. R. ASHENHURST. With 10 Coloured Plates and 15 Diagrams. Third Edition. 4s. 6d.
- WATCH AND CLOCK MAKING. By D. GLASGOW. 4s. 6d.

CASELL & COMPANY LIMITED, Ludgate Hill, London.



BEAUTIFULLY COOL and SWEET SMOKING.
SMOKE

PLAYER'S NAVY CUT.

Ask at all Tobacco Sellers, Stores, &c., and take no other.

Sold only in 1oz, Packets, and 2oz. and 4oz. TINS,

which keep the Tobacco always in fine smoking condition. Player's Navy Cut Cigarettes can now be obtained of all leading Tobacconists, Stores, &c., in packets containing 12.

The Genuine bears the Trade Mark, "NOTTINGHAM CASTLE," on every Packet and Tin.

Stephens Stains FOR WOOD.

Specimens and Prospectus giving full details as to use free by post.

H. C. STEPHENS, 191, Aldersgate St., London, E.C.

TO INVENTORS.

If you have an idea for an invention PATENT it for a trifling cost. Particulars and Pamphlet free.

RAYNOR & CASSELL, Patent Agents.
37, CHANCERY LANE, LONDON, E.C.

WATERPROOF FLUID GLUE.

(Patent.)

By post, 1s. 3d. and 8d.

WATERPROOF GLUE CO.,
62, Dale Street,
LIVERPOOL.

JUST PUBLISHED, price 1s.

SCIENCE APPLIED TO WORK.

By JOHN A. BOWER. With 66 Illustrations.

CASELL & COMPANY, LIMITED, Ludgate Hill, London.

JUST PUBLISHED, price 1s.

SCIENCE of EVERY-DAY LIFE.

By JOHN A. BOWER, F.C.S. With 49 Illustrations.

CASELL & COMPANY, LIMITED, Ludgate Hill, London.

NOTICE.

In No. 350 of

Cassell's Saturday Journal,

Price 1d., is commenced a New Serial Story of Life in the Far West, entitled

"CALAMITY JANE."

** In this story are pictured a series of exciting incidents illustrative of life and character in the "City" of Deadwood. To this famous Western gold-mining settlement a New York lawyer and his wife betake themselves in quest of fortune; and in vivid colours the author depicts their varied adventures—their perilous journey by road, with the midnight attack on the stage coach, their life amidst the rough and lawless mining population of Deadwood; and particularly their association with the mysterious personage called "CALAMITY JANE," and the remarkable chain of events which followed it.

CASELL & COMPANY, LIMITED, Ludgate Hill, London.

ASPINALL'S

INCOMPARABLE,

COLOURS

BEWILDERING,

BEAUTIFUL.

PRINCESS.

TO AMATEURS.

The roughest proscenium, or fittings, knocked up for the occasion in Hall, School, or Country House, may be made not only beautiful, but very like the real thing by a pot or two of ASPINALL'S ENAMEL at the cost of a few shillings, and the success of a show is frequently enhanced by bright surroundings. *Verò.sap.*

SOLD EVERYWHERE,
In Tins, or post free, 7d., 1s. 6d., and 3s.
For Baths, 9d., 1s. 9d., and 3s. 6d.,

FROM
WORKS, LONDON, S.E.

ASPINALL'S EBONICA,

A JET BRILLIANT BLACK, FOR
Cycles, Basket Carriages, Bedsteads, &c.

Sample Tin, 9d., post free.

COLOUR CARDS POST FREE.

ENAMEL.

C. BRANDAUER & CO'S
CIRCULAR PENS
NEITHER SCRATCH NOR SPURT.
SAMPLE BOX 6P.
OR FOR 7 STAMPS
BIRMINGHAM.

[33

GRATEFUL—COMFORTING.

EPPS'S COCOA

BOILING WATER OR MILK.

Bovril Invaluable as a
Strengthening and In-
vigorating Beverage.

Indispensable for enriching Gravies,
preparing Soups, Entrées, &c.

Pure, Palatable,
instantly prepared. **Bovril**

WILL KEEP ANY LENGTH OF TIME.

SOLD EVERYWHERE.

A WONDERFUL MEDICINE.

BEECHAM'S PILLS

FOR FEMALES THESE PILLS ARE

"A priceless boon, a treasure more than wealth; the banisher of pain, the key to health."

These are FACTS testified continually by members of all classes of society, and one of the best guarantees to the nervous and debilitated is,

BEECHAM'S PILLS have the Largest Sale of any Patent Medicine in the World.

Prepared only by the Proprietor, T. BEECHAM, St. Helens, Lancashire, in Boxes 1s. 1d. and 2s. 9d. each. Sold by all Druggists and Patent Medicine Dealers everywhere. N.B.—Full Directions are given with each Box.

DISEASE EXTERMINATED from the System, and every form of Nervous, Muscular, **WEAKNESS** speedily overcome, without Poisonous Drugs or Quack Medicines.

Invalids should know that there is positively no Nerve Tonic and Health Restorative agent on earth so valuable and harmless as Nature's own remedy, "ELECTRICITY."

MR. C. B. HARNESS,
President of the British Association of Medical Electricians,
Confidently recommends all Sufferers from RHEUMATIC and NERVOUS AFFECTIONS, LIVER and KIDNEY DISEASES, LADIES' AILMENTS, or any form of Local or General Debility, to wear his Patent

ELECTROPATHIC BELT.

Thousands of Testimonials.

WRITE FOR COPIES.

HARNNESS' ELECTROPATHIC BELTS
Sole Proprietors: The Medical Battery Co., Ltd., 52, Oxford Street, London, W.

ALL who wish to be Healthy and Strong permanently should wear one of these comfortable Appliances.

They are guaranteed to produce a mild, soothing, invigorating, imperceptible current of Electricity which speedily vitalises every Nerve, Muscle, and Organ of the Body.

They Prevent and Cure all NERVOUS AFFECTIONS, and are invaluable in cases of RHEUMATISM.

Sufferers should call without delay, and inspect the Thousands of Testimonials received from all classes of society.

CONSULTATION FREE of Charge, personally or by letter, on all matters relating to Health and the application of Curative Electricity, Massage, and Swedish Mechanical Exercises. If you cannot call, write for Descriptive Pamphlet and Private Advice Form.

Note Address—THE MEDICAL BATTERY CO., Ltd.,
52, OXFORD ST., LONDON, W.
(Corner of Rathbone Place),
All Communications treated as STRICTLY PRIVATE & CONFIDENTIAL.

Are universally admitted to be worth a Guinea a Box for Bilious and Nervous Disorders, such as Wind and Pain in the Stomach, Sick Headache, Giddiness, Fulness and Swelling after Meals, Dizziness and Drowsiness, Cold Chills, Flushings of Heat, Loss of Appetite, Shortness of Breath, Costiveness, Scurvy and Blotches on the Skin, Disturbed Sleep, and all Nervous and Trembling Sensations, &c. &c. The first dose will give relief in twenty minutes. This is no fiction, for they have done it in countless cases. Every sufferer is earnestly invited to try one Box of these Pills, and they will be acknowledged to be

Worth a Guinea a Box.