

# WORK

An Illustrated Journal of Practice and Theory  
FOR ALL WORKMEN, PROFESSIONAL AND AMATEUR.

[All Rights reserved.]

VOL. IV.—No. 178.]

SATURDAY, AUGUST 13, 1892.

[PRICE ONE PENNY.]

## WORK WORLD.

THE longest tunnel in the world will be that about to be made through the Simplon. According to the final plans adopted, it will have a length of  $12\frac{6}{10}$  miles, which is  $3\frac{1}{10}$  miles longer than the St. Gothard Tunnel.

\* \*

The Board of Trade experts are now determining the exact weight corresponding to the attractive force of an ampère under certain fixed conditions, with the view of defining a standard to be called the legal unit, so that electrical measurements may be well "understood of the people."

\* \*

At the Manningham Mills stands a power loom by which Utrecht velvets—mohair—can be made. The production of this material has hitherto been confined to the Continent. By a new method of combining the back or ground with the pile, a perfect cloth is woven, face to face, with fineness and evenness of surface, and a greatly increased brightness and superiority of colour. For many years past the material for the production of mohair velvet has been sent from Bradford to the Continent to be worked up and returned to England.

\* \*

An investigation made shows that the spectrum of burning magnesium approaches most nearly of the spectra of artificial light to that of the sun. The temperature of the magnesium flame is about  $1,340^{\circ}$  centigrade, though the character of its spectrum would correspond to  $5,000^{\circ}$  centigrade in a light due to ordinary incandescence. The radiant energy of burning magnesium is 75 per cent. of the total heat of combustion. In ordinary illuminating gas this is only 15 to 20 per cent. Considering the greater luminosity of the rays of the visible spectrum of burning magnesium, its light-giving power per unit of energy expended is from fifty to sixty times greater than that of gas.

\* \*

The largest masonry dam in the world has just been completed in India in connection with the Waterworks of Bombay. It is about two miles in length, 118 ft. high, 100 ft. thick at its greatest depth, and  $15\frac{1}{2}$  ft.

at the top. The lake which will be formed when the valley is filled with water will cover an area of eight square miles, and it is estimated that it will supply 100,000,000 gallons per day throughout the year. In the construction of this work nearly 15,000,000 cubic feet of rubble stone have been used, 2,200,000 cubic feet of lime, and 3,300,000 cubic feet of washed sand. The water is distributed through 50,000 tons of pipes, some of which are 4 ft. in diameter.

\* \*

Band saws may be joined as follows:—Bevel each end of the saw the length of two teeth. Make a good joint. Fasten the saw in brazing clamps with the back against the shoulder, and wet the joints with solder water, or with a creamy mixture made by rubbing a lump of borax in about a teaspoonful of water on a slate. Put in the joint a piece of silver solder the full size thereof, and clamp with tongs heated to a light red (not white) heat. As soon as the solder fuses, blacken the tongs with water, and take them off. Remove the saw, hammer it, if necessary, and file down to an even thickness, finishing by draw-filing lengthwise.

\* \*

An immense fortune awaits the man who will invent a cheap and effective system of purifying the sewage of our large towns. Land filtration is out of the question because of the large areas of land required, and it seems as though the only refuge was in some system of chemical precipitation. Almost every kind of chemical substance has been tried for this purpose—lime, alum, alumina, iron salts, and a host of others—but the fact remains that the perfect system has yet to be discovered. The authorities in Lancashire and Cheshire are getting anxious on account of the approaching completion of the Manchester Ship Canal, when it will be impossible to discharge their untreated sewage into the canal without serious danger to health.

\* \*

At the Newbottle collieries great improvements are being made by an important electrical installation. A current from dynamos is taken to a distributing centre about 390 yards from the bottom of the shaft, from whence it is conveyed to the pump, the haulage engine, and the winding

engine, the latter being 2,800 yards from the distributing centre. In another part of the northern coal-fields three-throw electric pumps are being fixed at a distance of 2,700 yards from the shaft. In some coal mines also, compressed air coal-getting machines are being displaced by electrical devices. The facility of transmission gives electricity its great value as a motive power for mining uses.

\* \*

To successfully photograph the successive phases of motion, a dead black background is required, and the object should be painted white. To prevent superposition of the successive images, an opaque disc, with a series of holes cut in it, is placed behind the objective of the camera and caused to revolve at a known speed. The speed of revolution may be very high, as under favourable conditions an exposure of  $\frac{1}{25000}$  of a second is sufficient to act on the plate, though more usually an exposure of about  $\frac{1}{5000}$  of a second is used. The sensitive film is mounted on rollers and rotated by clockwork at a suitable speed. By such means twenty to thirty exposures per second can be made, and amongst other things, the movements of the wings of flying birds have been clearly shown. This may help the flying apparatus inventor.

\* \*

Brass has been made by the compression of its constituents at ordinary temperatures. A specimen, reddish in colour, was made by compressing a mixture of nine parts of copper with one of zinc; a pale yellow brass was produced by compressing seven parts of copper with three of zinc. Both these specimens had been filed up twice and consolidated again by pressure. The reddish metal is softer than cast brass, and can be slightly flattened under the hammer; the yellow metal is harder than common brass, and is also brittle. Both varieties appear to be amorphous, and show a uniform granular appearance without any trace of the beautiful crystallites found in copper-zinc alloys obtained by fusion. There is evidence of flow in the yellow alloy, but nothing to indicate an actual liquid condition of the alloy or one of its constituents. It seems probable that by the compression of mixed metallic powders some alloys may be produced which are not to be obtained by fusion.

**FISHING-GUT: HOW IT IS PREPARED, AND HOW TO TIE IT.**

BY F. CROCKER.

REARING THE SILKWORMS—TYING—TYING ON HOOKS—TYING THE GUT TO THE FISHING-LINE.

SOME time ago a correspondent asked to be supplied with information respecting the manufacture of the above, and as it may be of interest to many WORK readers to know how it is prepared, I here devote a short paper to its production, and how to tie it; although, for an angler to prepare fishing-gut for his own use, the writer can safely say from experience that it will be found more expensive, and the article produced will be inferior to that which may be obtained from the tackle shops, cheaper than the cost of rearing the silkworms; still, some of our readers may like to take the matter up as a hobby, and hobbies are not always expected to be financially a success.

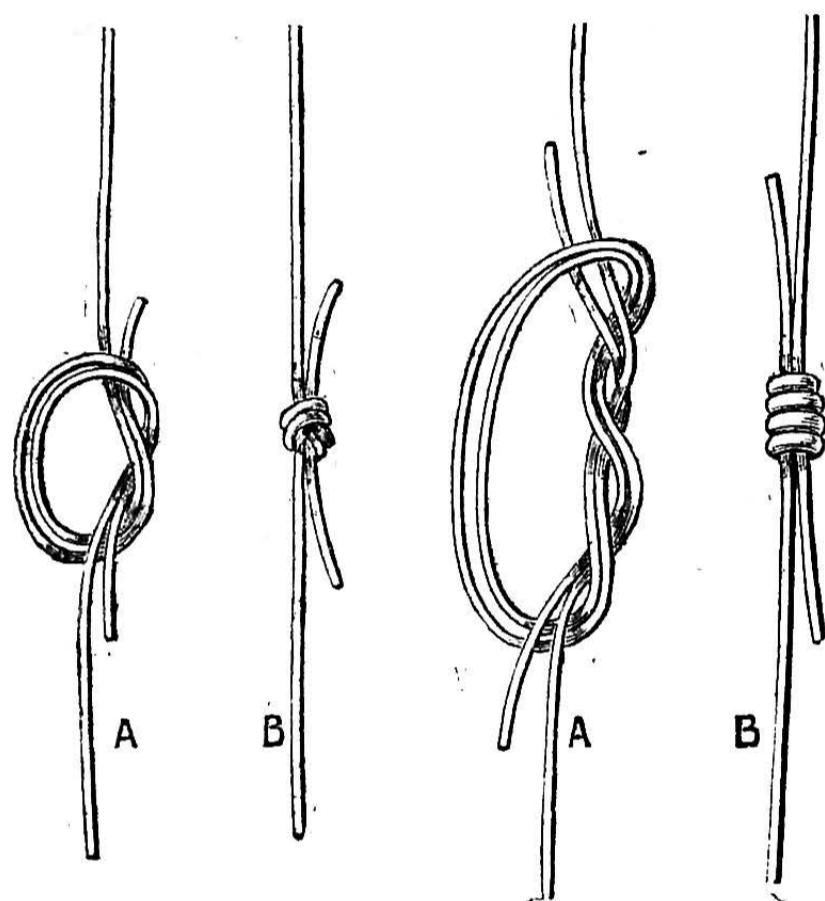

Fig. 1.

Fig. 2.

Fig. 1.—Overhand Knot—A, Loose; B, Tight.  
Fig. 2.—Double Overhand Knot—A, Loose; B, Tight.

*Rearing the Silkworms.*—Procure some silkworms' eggs, place them in shallow cardboard trays, and put in the sun to hatch. As soon as the worms appear, feed them with mulberry, or, failing these, lettuce leaves. The trays must be cleaned out and fresh leaves put into them every day until the worms are ready to spin. At this period they get darker in colour, and refuse to eat. Put them into hot vinegar for three or four hours, take them out, and pull asunder, when three or four strands of gut will be found. Stretch these between pins driven into a board 8 in. or 9 in. apart, according to the length of the gut, and place in the sun to dry. The gut is not the intestine of the silkworm, but the silk before it is spun. When dry and hard, wash the gut in strong soda-water, dry it, and draw each strand between two pieces of india-rubber, and it will be ready for tying.

*Tying.*—Gut may be bought tied up into bundles of 100 strands. It is generally tied with purple thread, and if this is faded in colour it may be inferred that the gut is old, and perhaps brittle; it may be tested by tying into a knot, when—if brittle—it will split or break.

As the strands of gut are not long enough for fishing purposes, several are tied together to form a length of from 1 yard to 2 yards, according to the fancy of the angler. For this purpose the best and roundest pieces

are selected, the rough ends are cut off, the thicker strands are arranged to be at the top, the finer at the bottom, nearest the hook. The ends to be tied are then placed into warm water or into the mouth, which

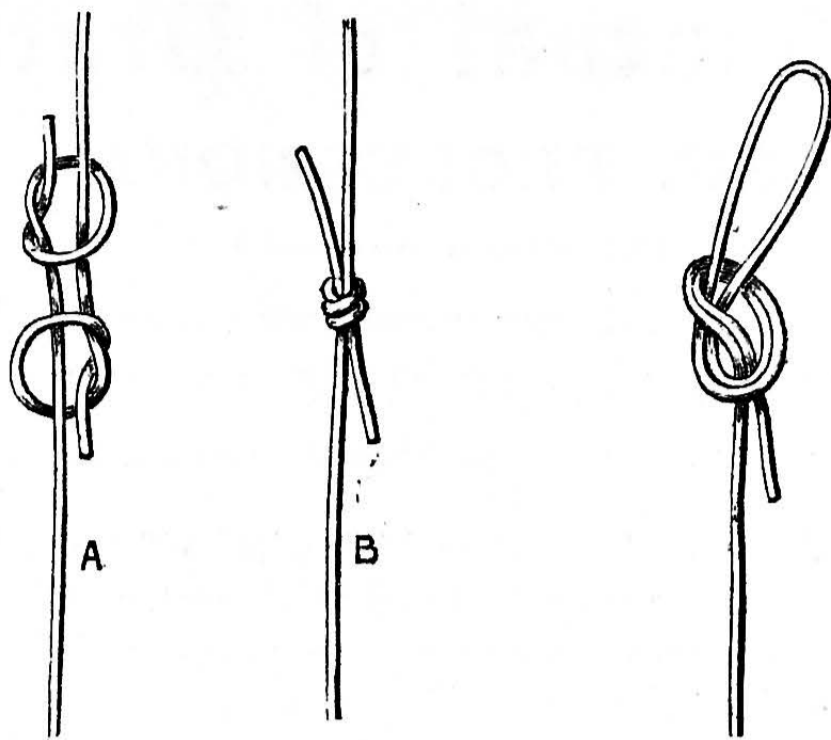

Fig. 3.

Fig. 4.

Fig. 3.—Fisherman's Knot—A, Loose; B, Tight.  
Fig. 4.—Loop.

will soften them, and make it easier to draw the knots up tightly. Several kinds of knots are used, a few of which are illustrated.

Fig. 1 is made by placing the strands side by side, tying an overhand knot, as shown at A, and drawing tight, when it will have the appearance shown at B. In this case it will not be advisable to cut the ends off quite close to the knot.

Fig. 2 shows the same kind of knot tied double; A shows the method of tying, B the knot when finished. This is a good method of tying, and the appearance of the knot may be improved by rolling between two pieces of wood. The ends may be then cut off close up to the knot.

Fig. 3 shows a fisherman's knot. This is made up of two single overhand knots, the method of tying which may be gathered

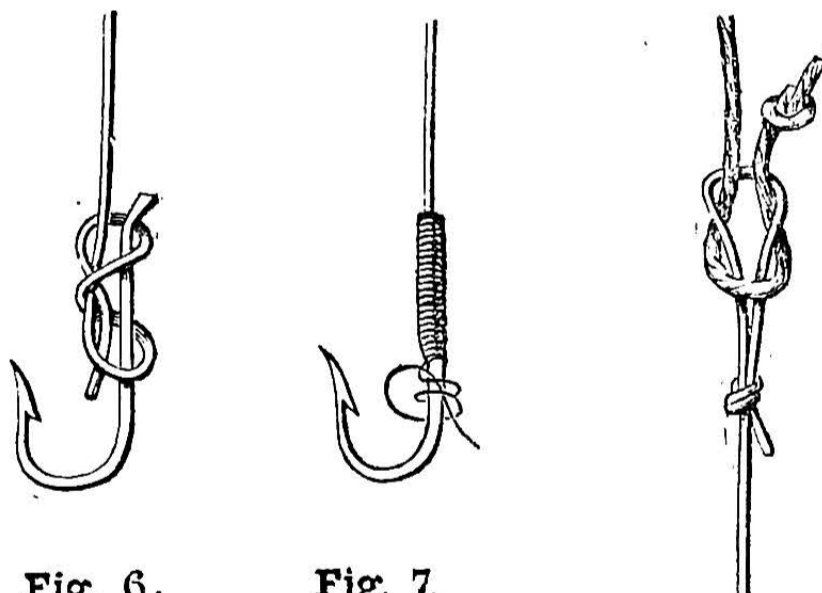

Fig. 6.

Fig. 7.

Fig. 8.

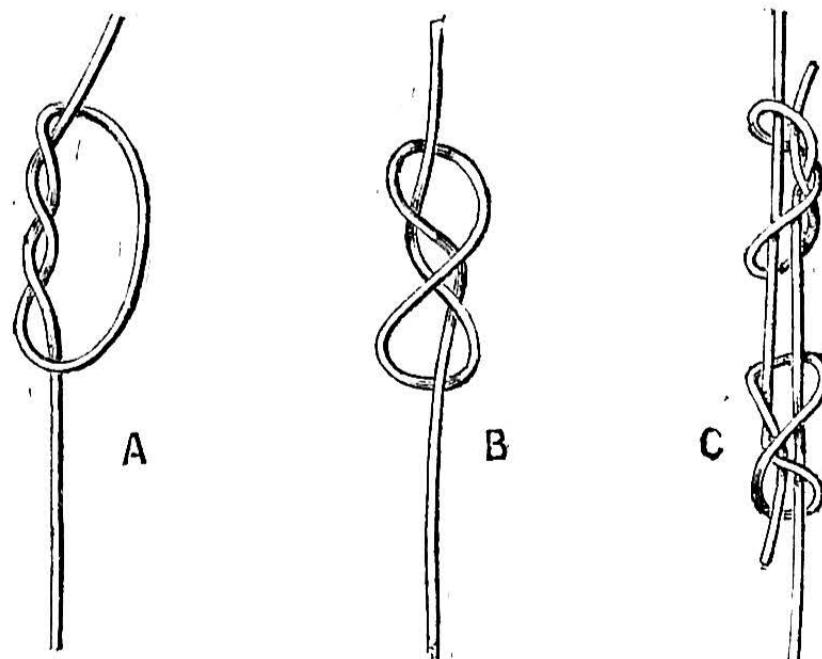

Fig. 5.

Fig. 5.—Method of tying a Double Fisherman's Knot. Fig. 6.—Method of tying on Hook with flattened End. Fig. 7.—Method of whipping on Hook. Fig. 8.—Method of securing Gut Collar to the End of Fishing Line.

from A, and the appearance when finished from B.

Fig. 4 shows the method of tying a loop, the knot in this case being similar to Fig. 1. If greater security is required, the knot may be tied double, as Fig. 2.

Fig. 5 gives a double fisherman's knot. A double overhand knot is first tied as shown at A, the two ends are pulled, when it will assume the form of a figure 8, as shown at B. Both pieces are tied in the same manner, then the free ends are put through both loops of the 8 on each piece. The two knots are then drawn tight and pulled together by pulling the free ends. The appearance may be improved by rolling as mentioned for Fig. 2, and the ends cut off close. The finished knot will be similar to B (Fig. 2). This is the strongest and neatest knot that can be used.

*Tying on Hooks.*—Fig. 6 shows the method of securing those hooks that are provided with a flat end to the shank to prevent the knot slipping off. A double overhand knot similar to A (Fig. 5) is first tied; this is pulled into the form shown at B (Fig. 5), and

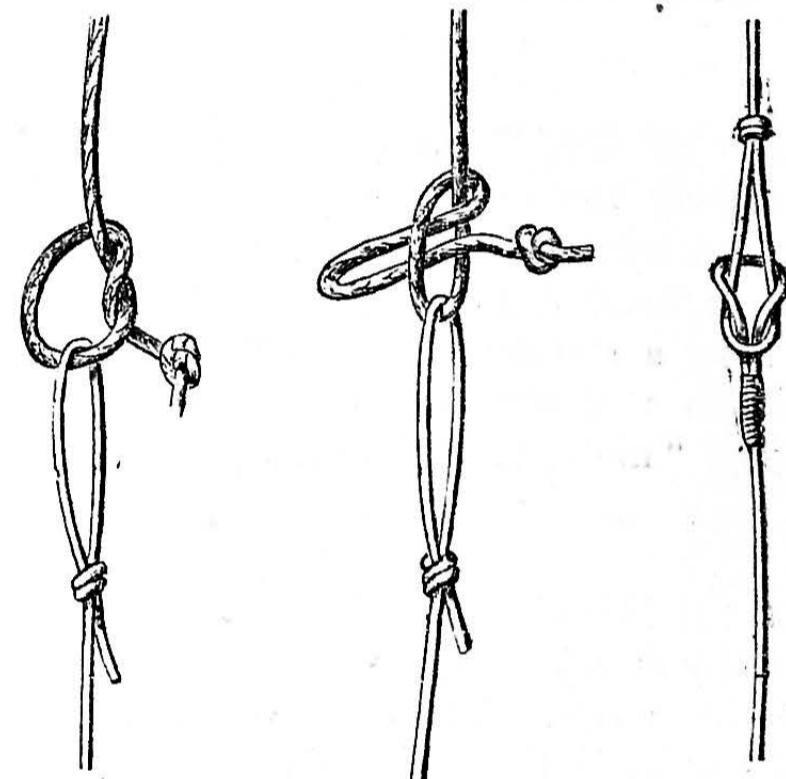

Fig. 9.

Fig. 10.

Fig. 11.

Figs. 9, 10.—Methods of securing Gut Collar to the End of Fishing Line. Fig. 11.—Method of securing Hook to the End of the Gut Collar.

the shank of the hook is put through the loops of the 8, when the knot may be drawn tight.

Fig. 7 shows the hook whipped on. For whipping, a piece of fine silk is used. It should be waxed: a convenient method of doing which is to dissolve some black wax in methylated spirits and dip the silk into it. The silk should then be bound tightly and evenly round the shank of the hook and the gut, and finished by putting the end through the last two coils, as shown at Fig. 7. It will be found necessary to slightly grease the silk at the end, to allow of the finishing tie being drawn tightly. The appearance may be improved by rolling, and when the wax is hard, varnishing. For the varnish, dissolve a little shellac in methylated spirits, and colour with vermilion. The colouring will brighten the appearance of the worm when on the hook. A loop is made on the opposite end of the strand of gut to which the hook is attached, by turning back and whipping, shown at Fig. 11, which also shows the method of attaching the gut of the hook to the collar.

*Tying the Gut to the Fishing-Line.*—Fig. 8 shows one method of doing this by a reef knot. Fig. 9 shows an overhand knot for the same purpose. Fig. 10 shows a tie that may be loosened by pulling the end, but there is danger of this catching against the ring at the top of the fishing-rod, and setting the gut collar, float, hook, and perhaps the fish, free.

**ELECTRIC CARRIAGE.**

THIS novel and useful vehicle is an American production. The motor is mounted centrally on the front axle, with the armature above, and parallel with the axle; on each end of the armature shaft is a crank disc, from which extend connecting-rods to clutches below the axle, these clutches being mounted upon short shafts, arranged to revolve beneath the axle, with pinions mounted upon the outer end, and set to mesh into gears mounted upon the hubs of the wheels. The motor is of a closed field type, working at 1,000 revolutions per minute, with a potentiality of forty volts. Upon level grade, a speed of from ten to fifteen miles an hour can be accomplished. The steering apparatus and brake are ingenious, and readily operated by the person in charge of the vehicle. Relying upon these auxiliary attachments, the steepest hills may be climbed. The vehicle cannot go backwards unless so directed. Should the motor fail to act, a connection break, or an accident of any kind occur, the carriage will stop, and this irrespective of the brake. Incidentally it may be mentioned that the storage cells with which the carriage is fitted will also furnish light and heat, if requisite, at but slight increase in cost of running. Taken as a whole, the combination is decidedly in the line of progress. A careful investigation and test disclose no defects that cannot be easily remedied. For the transportation of passengers and baggage over routes where travel is insufficient to justify the laying of rails, or over hilly or otherwise difficult roads, coaches could thus be run with success.

**A RUSTIC PEDESTAL FOR SUNDIAL OR FLOWER-VASE.**

BY ARTHUR YORKE.

AN OPENING WORD ON THE DESIGN—MATERIALS—CONSTRUCTION.

*An Opening Word on the Design.*—A pedestal such as that shown in the accompanying illustrations is a piece of garden decoration easily made, and if not required to support a horizontal dial, may well serve for a flower-vase; such as one of those for the adaptation of which from waste materials directions are given in Vol. III, p. 129 (No. 113).

If a sundial is to be mounted, it will be necessary that the top of the pedestal should be true to the plane of the horizon, or, in other words, lie perfectly flat, and also that it should be firmly fixed. As the pedestal is a hollow box, the easiest way of fixing will, perhaps, be by letting a piece of wood into the ground like a post, adjusting the pedestal accurately upon it, and then securing it by a screw or two. But if a vase only is to be set on the pedestal, it can be slipped over a stake merely driven into the ground, and this will suffice to keep it from being thrown down. It can then readily be removed at pleasure: as, for instance, before winter, to be put under shelter. The scale of the illustrations is 1 in. to the foot.

*Materials.*—The body of the pedestal is made of 1 in. elm board, the top being a piece of 2 in. slab. Some tolerably large pieces of rough stuff are required for the base, but for that position it will not greatly matter of what kind of wood they are, so long as they are moderately straight. The split rods used in the rustic mosaic work are shown as rather larger than usual—say, 2 in.

in diameter. This size will be most effective. Wych-elm or maple, with a little mixture of peeled withy, will perhaps look best. A few bits of crooked stuff—say, apple-tree—will also be wanted.

*Construction.*—The horizontal section (Fig. 2) shows how the carcass is nailed together in 1 in. boards, and that it is 1 ft. square. For the given height (3 ft. 6 in.), these boards need to be 3 ft. 4 in. long,

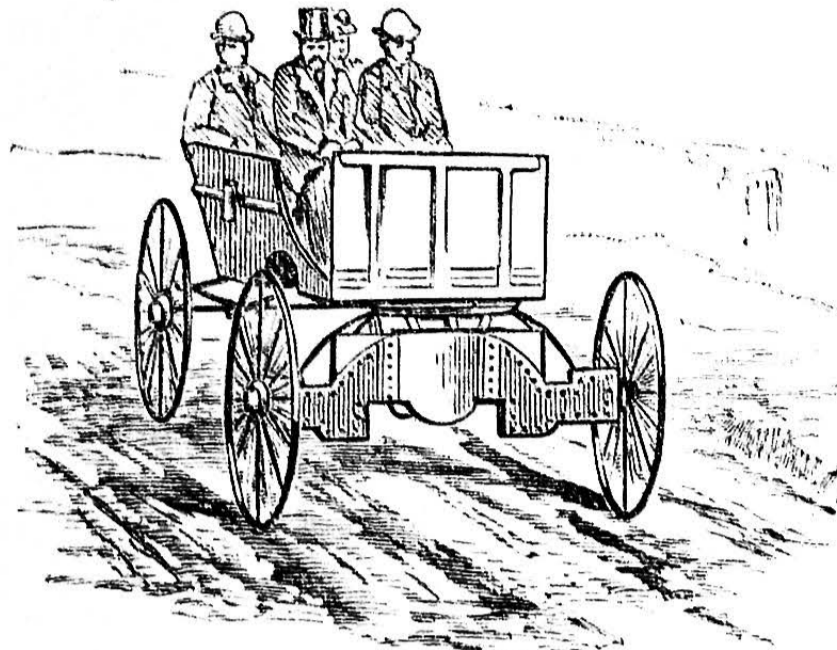

Electric Carriage.

which allows 2 in. for the solid piece of slab or plank which forms the top. This top is 16 in. square, so that when split rods have been nailed round its edge it may be about 18 in. square.

The base is made of four pieces of rough round stuff, 5 in. in diameter by 21 in. long, which will need to be trimmed a little on that side which lies against the board. The vertical section (Fig. 3) shows how these

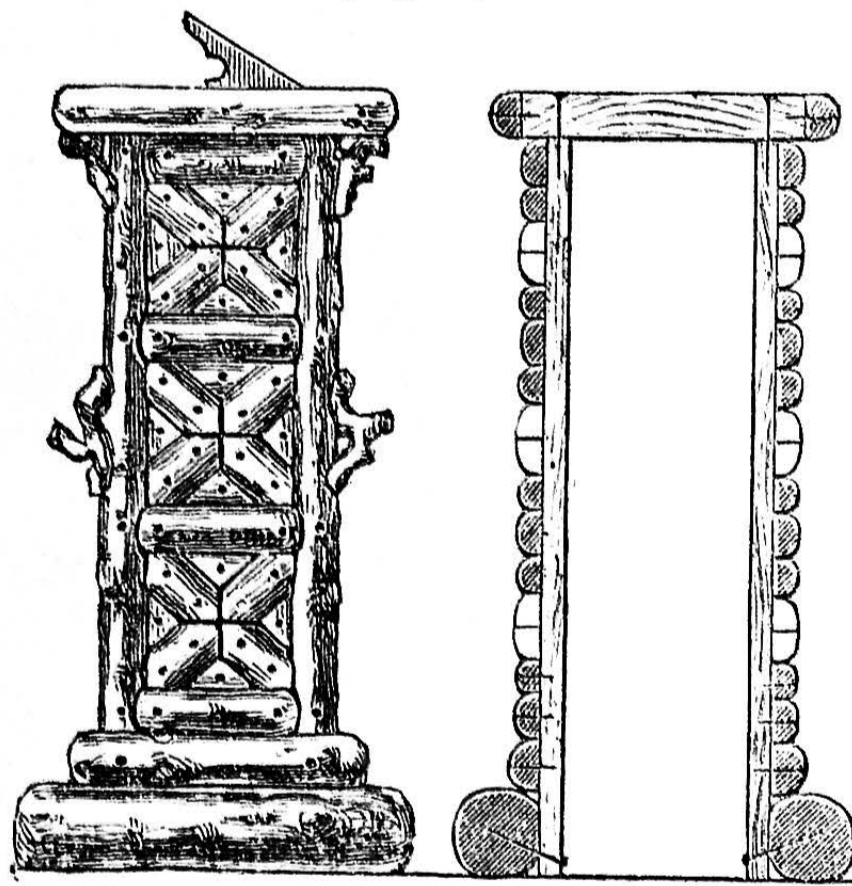

Fig. 1.

Fig. 3.

Fig. 1.—Elevation. Fig. 2.—Horizontal Section through Centre.

Fig. 3.—Vertical Section through Centre.

Fig. 2.

pieces are fixed by nailing through the boards into them; they should also be nailed to each other at the corners. Next above, a 3 in. rod runs round. Two lengths of 2 in. split rod run up each corner, as shown in Fig. 2, and between these the ends of the small projecting pieces of crooked stuff are fitted in. They should be neatly trimmed for this purpose, and as their position may expose them to be knocked off, it will be better to screw than to nail them into the board. The arrangement of the rustic mosaic pattern is so clearly shown in Fig. 1, that it can need no explanation.

**CYCLE TIRE ACCIDENTS: HOW TO REPAIR.**

BY ONE WHO KNOWS

THE object of this article is to enable possessors of a pneumatic-tired machine to make good a puncture or damage whilst on the road, and without calling in the aid of a professional repairer.

The pneumatic tire for cycles seems destined to be the tire of the future, the small solid, and even the cushion, being even now only used on the ground of their cheapness, as compared with the pneumatic. There are now numerous makers of pneumatic tires, and new tires are coming out almost every week. Among the first of the pneumatic or compressed air order of tires, and one which still holds a high place, is the Dunlop tire. Among the other now well-known tires may be mentioned the "Clincher," which is said to be non-puncturable; the Boothroid, also said to be unpuncturable; the Silvertown "Closure," composed of a raw rubber (*i.e.*, pure rubber) which, on being punctured, closes and adheres of itself; the "Smith" Balloon tire, which, instead of having the canvas cemented to the rim, has it laced together between the spokes. The "Dunlop" tire is said to be the fastest on the racing-path; why this is so I am not prepared to say.

The rim of a wheel for a "Dunlop" tire is about 2 in. broad, and but slightly curved in section. The tire itself is made up of: first, an inner inflating tube made of good rubber, and furnished with an inlet or valve for pumping in the air. This inner tube is encased in a second tube made of a canvas composition, this canvas tube serving to keep the inner rubber tube of a uniform size throughout the circumference of the wheel, which it would not otherwise do, as any thinner or weaker parts in the inner tube would bulge out with the air pressure. On the outer or hollow side of the rim is cemented a strip of canvas covering the heads of the spokes, and on this is placed the canvas-covered air tube, having the valve passing through a hole in the rim between the spokes. To hold the tire in place and take the wear, the outer tire is placed over the canvas one; this consists of good rubber, and may be termed a rubber tube with one side cut open; it is about 1/4 in. thick in the middle, and thins down to nothing at the edges. When in position, it covers the canvas tire already described, and overlaps the edges of the rim about 1/8 in. on each side. It is held in place by a strip of canvas cemented to its edges, the canvas being first cemented to one edge, then slit half-way across to pass the spokes, and cemented to the other edge. This completes the tire so far as we have it at present. It is inflated by a small force-pump, which is carried in the tool-bag. If the tire and the valve are perfectly air-tight, the hard-pumped tire will remain up for an indefinite period; if, however, the valve leaks, the tire gradually gets emptied of air. Many riders are troubled with their tires going down, the true cause being, not a puncture, but a leaky valve. Punctures do take place, however; then the sorrows of the rider begin, as the slightest puncture is fatal to the tire until repaired, and the repairer will not undertake the job under a charge of 7s. 6d. or 10s.

An outfit for repairing these tires is got from most cycle shops for 2s. 6d. It consists of a tube of rubber solution, a small tin of French chalk, a small web of canvas, and a small web of thin rubber for patching.

It is only when the *inner* tube is damaged by puncture that the compressed air escapes; consequently, it is the inner tube that has got to be repaired, and in order to find the puncture the tube must be removed from its double casing.

First of all, about 12 in. of the canvas on the under side of the rim must be detached from the edge of the outer rubber covering, the valve being in the middle of the part so detached: this will expose the canvas tube which encloses the rubber air tube. This canvas tube is ripped carefully for four or five inches on either side of the valve, exposing the inner rubber tube. This tube will be found to have been joined in making in the vicinity of the valve; dissolve this joint by applying benzene, and part the tube. Tie a long cord round the end of the tube that has *not* got the valve attached, pull the valve end gently, and the tube will be easily extracted entirely from its casing, taking care that the cord is long enough to pull it back again when repaired. Search now for the puncture; it is usually found by the appearance

of a small white mark on the surface of the rubber. Having found the hole, clean the surface thoroughly, and coat a surface about  $\frac{1}{2}$  in. in diameter (having the hole in the middle) with the solution in the collapsible tube; also cut a small round patch of the rubber web, and coat one side. Before applying the patch, let the solution dry for an hour or so, then apply the patch, pressing it carefully, and taking great care that the tube is not smeared with the solution other than under the patch. After patching, leave to dry, then rub with

French chalk to prevent the tube adhering to its canvas covering. Now proceed to draw the tube through its casing with the cord back to its former position, clean the lapping ends, and smear with the solution; in joining them, great care must be taken that they are perfectly joined all round. Now pump in a little air, to see that the tube will inflate properly at the joining; again rub with French chalk, and cover in the air tube by stitching together the canvas covering, a needle and thread being part of the afore-said outfit. The canvas stitched, wrap a bit of the canvas web of the outfit round the part so stitched, and sew it also. Now cement the outer canvas to the rim and edges of the outer tire, and the job is complete. It will be seen that the task is somewhat tedious, and the rider who elects to do his own repairing while on a journey must carry his repairing kit with him, and must calculate upon spending about two hours at his inn or by the roadside.

To test a diamond in the dark, draw the diamond smartly over the surface of smooth unpainted wood, and it will show a phosphorescent streak.

## SEWING-MACHINES: HOW TO BUY AND USE THEM.

BY CYCLOPS.

THE WILCOX AND GIBBS' CHAIN-STITCH SEWING-MACHINE—GENERAL DESCRIPTION OF MACHINE—PARTICULAR FORMATION OF STITCH—THE "TAKE-UP"—REGULATION OF THE TENSION—POSITION OF NEEDLE IN RELATION TO HOOK—THE FEED AND STITCH REGULATOR—THE COMPLETE ACTION.

*General Description of Machine.*—This machine, as I said in the previous paper, is among the most beautiful in construction and arrangement of modern sewing-machines.

Fig. 6 gives a view of the machine from the front, with under cap open, showing rotating hook, or looper, and feed arrangements. The main shaft, A, runs through the base of the machine, and under raised work-table, carrying at one end the small grooved balance-wheel, B, which is rotated by a band, or belt, C, and the two eccentrics, D and E, one operating the rocking arm, F,

the work the appearance shown in Figs. 1, 2, and 3 (see No. 168, page 178).

*The "Take-up."*—It will be easily understood that the quantity of thread required to go round the rotating hook at each stitch is much greater than is required for the stitch, and as there is no means of holding it below the needle, as in the Wheeler and Wilson, which we shall describe hereafter, some mechanism has to be provided for taking up the superfluous thread, so that the stitches will be drawn tight and not lie slack, as would be the case without such an appliance. In order to overcome these seeming difficulties, an arrangement has been provided called the "take-up" (see L, Fig. 6). The thread is passed through a kind of slide, L, and a projection on the needle-bar, K, raises the thread up when the hook is ready to release it. This action, combined with the tension which we shall now describe, is perfectly automatic, and requires no attention or adjustment from the operator.

*The Tension and its Regulation.*—The automatic tension shown at G (Fig. 6) is designed to hold back the thread while the take-up is drawing away from the hook the superfluous thread, and release it when the needle requires a fresh supply, both of which movements take place at each revolution of the shaft. The eccentric, D, on the shaft, A (Fig. 6), opens and shuts the tension, G, at the required time.

The most notable feature of these machines is that whatever the length of stitch the work may require, the tension and take-up require no alteration. And in this lies its claim to the name given

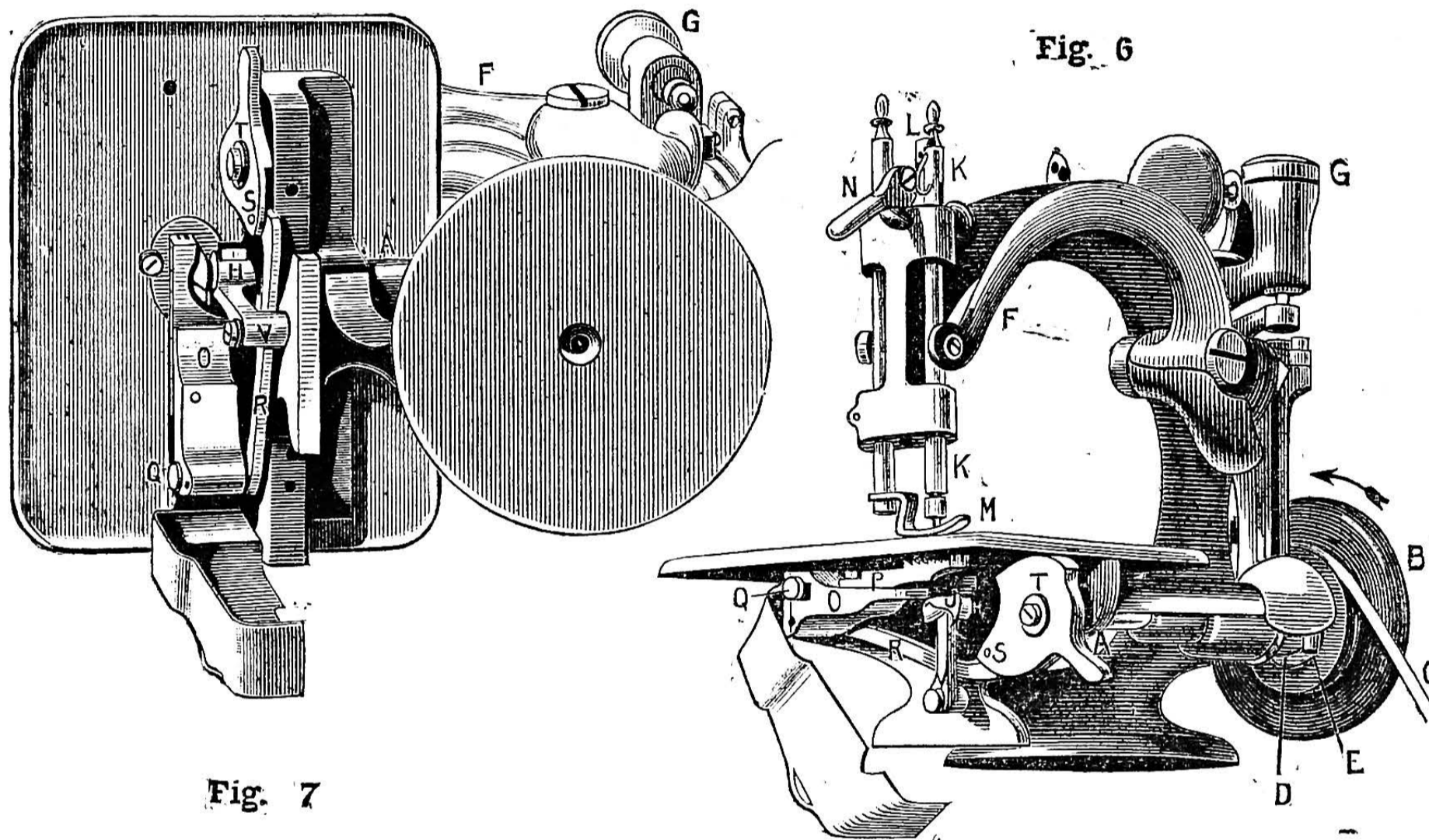

Sewing-Machines. Fig. 6. Front View of Wilcox and Gibbs' Machine with Cap open. Fig. 7.— Under View of Machine with Cap open.

and the other the automatic tension, G. At the other end it carries the eccentric cam, H, operating the feed mechanism, and the rotating hook, or looper, J, for forming the stitch.

All the bearings on this machine are thoroughly hardened, and true and accurate in their fitting, and the makers claim for it that at low speeds it is perfectly silent. Owing to having no shuttle, with its consequent friction and dead points, it is very easy running, and can be operated at extraordinary speeds.

In one test it was operated ten hours a day for eight months, at the rate of 1,500 revolutions per minute, without any adjustment or repairs whatever.

*Particular Formation of Stitch.*—The formation of stitch in this machine is peculiar, and rather difficult to explain. The rotating hook, J (Figs. 6 and 7), makes one revolution to every downward movement of the needle-bar, K. The needle descends, and forms a loop exactly in the way of the point of the rotating hook, so that the hook takes hold of the loop, and twists it round in such a way that on its second descent the needle passes the thread through the first loop, and forms a second loop, to be caught by the point of the rotating hook. It is this action which gives to

it by the makers—the "Automatic." *Position of Needle in relation to Hook.*—It will be seen, on a closer examination of the hook, J (Figs. 6 and 7), that it revolves in the direction of a right-hand screw and point first. It is this point which catches the loops made by the needle on its ascent, and the position of the needle should be such that when the loop is thrown out the rotating hook shall be advancing ready to catch it. This relation of one movement to another entirely depends on the position of the eccentric, E, on the shaft.

*The Feed and Stitch Regulator.*—The arrangement of the feed, or appliance for moving the work on at the end of each stitch, is shown under the cloth plate in Figs. 6 and 7. It consists essentially of a lever, having on its end, teeth, which project through a hole in the cloth plate, called the throat, and engage with the material being sewn, pushing it on at the conclusion of each stitch, and when, of course, the needle is at the top. In order to accomplish this, two movements of the feed lever are required—one an upward one, to allow the teeth to take hold of the material being sewn, and one an onward one, to carry the material along. These two movements are accomplished by an eccentric cam on the

shaft, A, just behind the rotating hook, and a system of levers, which we shall now explain.

The lever, o (Figs. 6 and 7), carrying on its upper surface the toothed feed bar, P, is free to move backwards on the pivot-screw, q. At the farthest end from the pivot it rests on the eccentric cam we have mentioned, and which gives its upward and downward movement. A lever, R, pivoted on to the lever, o, is carried across the front bed of the machine, and has at its end a long slot, or sliding way, in which a pin, s, on the adjusting cam, r (Figs. 6 and 7), is free to move backwards on the turning of that cam.

Another lever, v (Figs. 6 and 7), pivoted at its bottom end on a screw-stud, is attached at its top end to the cam on the shaft, and by the action of that cam rocks backwards and forwards. This is the lever giving the onward movement to the feed in the following way:—

A projection on the lever, R, presses, by the action of a spring not shown in our sketch, against the right side of the lever, v, so that as the lever, v, rocks backwards and forwards, it gives to the lever, R, a backward and forward movement, carrying with it the feed lever, o. Now, it will be seen that the point of contact of the lever, R, with the lever, v, can be varied by turning the cam, r, which has the effect of raising and lowering the end of the lever, R. And if the point of contact is near the top of the lever, v, it will have a very much longer stroke than if it were at or near the bottom. This, then, constitutes the adjustment of the length of the stitch.

Let us now briefly go over the complete action. The needle descends through the work, and the automatic tension lets the thread run; the hook advances and catches the loop, the needle ascends, and the take-up draws away the superfluous thread, while the feed draws on the material ready for the next stitch, all of which actions take place at every revolution of the shaft.

Before leaving the consideration of this machine it will be well to say something about the chain-stitch. Its great disadvantage is that it so easily comes undone, and it takes nearly three times the quantity of thread that is required by the ordinary lock-stitch; but at the same time, the advantage of doing away with the shuttle, and all its inseparable wear and loss of time in winding and threading, gives to this machine an advantage which, in the opinion of many, counterbalances its disadvantages.

## HAND-WORKING OF SPECULA FOR THE NEWTONIAN TELESCOPE.

BY EDWARD A. FRANCIS.

### THE POLISHER AND POLISHING.

THE finely-prepared glass surface is polished with rouge, carried on a pad formed of pitch, which easily assumes and temporarily retains any desired curve.

The glass tool must be covered with a coat, about  $\frac{1}{4}$  in. thick, of pure black pitch; and the pitch must be faceted as in Fig. 14, in order that the surface may be free to expand, and that the moisture which carries the rouge may easily circulate. It is better not to arrange the facets so that the centre of the central facet coincides with the centre of the tool, or a short, straight stroke may cause the speculum to be polished in rings. Fig. 15 shows a method of arrangement

adopted after exhaustive experiments with polishers of many shapes. By such an arrangement a great part of the polishing can be safely done with straight strokes, and this is a decided advantage to an inexperienced workman. The white spot in the centre of the engraving indicates the centre of the glass tool.

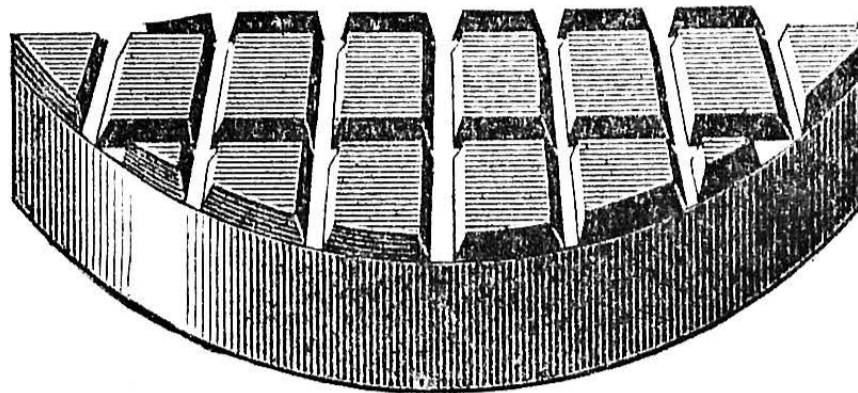

Fig. 14.—Facets of Pitch on Glass Surface.

I shall give one method only of forming the facets. Fig. 16 is a little tool formed of three pieces of wood screwed together. The blades, A, A, should be about  $\frac{1}{4}$  in. thick, and very slightly bevelled at the lower edge, which edge should be of the same curve as the metal gauge (Fig. 11, page 183). The centre-piece, B, will need to be of the same

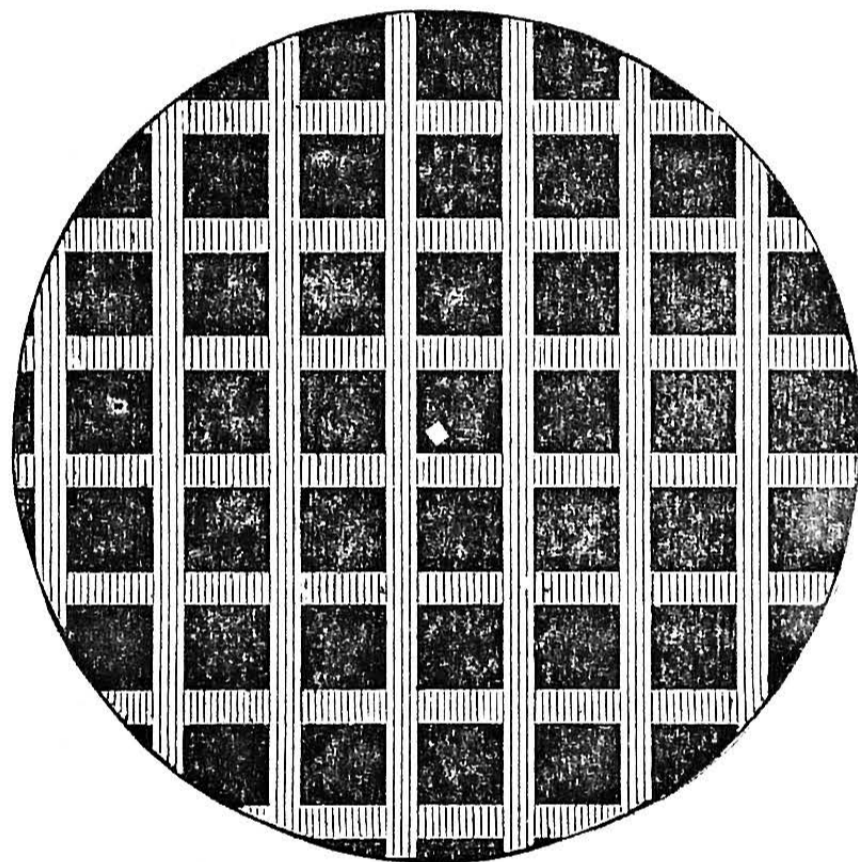

Fig. 15.—Arrangement with Polishers of many Shapes.

width as that proposed for the facets—that is, about  $\frac{3}{8}$  in. The facets are stamped out by pressing the little tool, wetted to prevent adhesion, on to the warm pitch.

Pitch, as obtained from the chemist, is practically free from grit; but if any doubt exist as to its purity, it may be strained through a sieve of distended muslin. It is safest to melt pitch in an oven and in an earthenware vessel. If it be allowed to boil, air bubbles will form and destroy the homogeneity.

All things being ready, a bowl of luke-warm water, sufficiently large to permit the speculum to be immersed, should be placed near to hand, together with the little stamping tool. A strip of stout paper, wetted with rouge and water, should be fastened round the edge of the glass tool, so as to form a rim about  $\frac{1}{4}$  in. high, and thus prevent the liquid pitch from flowing off. The tool being then carefully dried and slightly warmed, the pitch may be poured out. The black mass, which will spread slowly and cover all the surface, should be immediately shaped to proper thickness by the aid of the wetted speculum, and, the stamper being

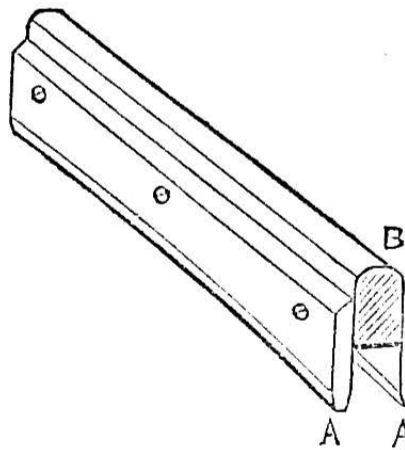

Fig. 16.—Wooden Tool with Brass Screws—A, A, Blades; B, Centre-Piece.

brought into play, the facets should be formed as speedily as possible. If necessary, the pitch may be warmed again and again, but, of course, not sufficiently to cause it to run.

In practice it will be found that facets moulded by a stamper will present a slightly concave surface. This may be remedied by bevelling their edges with a sharp chisel or an old razor, and then shaping the whole surface again, after warming, by the aid of the wetted speculum. The greatest care must be taken not to allow the speculum to dry, and so adhere to the pitch, and for this reason its position should be constantly altered a little, and rouge and water should be used, instead of water only, for the damping.

Finally, the facets having been trimmed square and regular, the paper rim and any superfluous pitch should be neatly cut away.

A properly prepared polisher should be everywhere in contact with the speculum. To test this, paint the facets separately with rouge, and lightly apply the clean, dry speculum. The imprint will indicate where contact is imperfect.

The rouge will require no further preparation than is entailed by placing a portion of it in a bottle and mixing it to a loose paste with water. It is best applied to the pitch with a flat camel's-hair brush. Every precaution must be taken to prevent dust or grit from settling on it. It is difficult to describe how to determine the proper hardness of the pitch, but it will be speedily perceived if it be too yielding or too rigid. When cold, a moderate pressure with the nail should indent it. The pitch purchased from a chemist is commonly of a quite suitable consistency. To soften pitch, add oil of turpentine; to harden it, add resin.

The remaining processes are two: polishing and figuring. The term "polishing" is self-explanatory; "figuring" is the giving to the polished surface the necessary parabolic curve.

The processes may be combined or performed separately. The former course was that pursued by the old workers. It is based on "rule of thumb," and needs a wide experience. In the latter course the spherical curve possessed by the smoothed glass is maintained unaltered until polish is complete, and is then deliberately changed to the parabola, the work being carried out under the guidance of the Foucault shadow test, to be hereafter described.

We shall first roughly notice the method of working by "rule of thumb"—a method which, however, by its very nature, cannot be satisfactorily taught on paper. Let it be borne in mind that a spherical mirror can be made parabolic and perfect for the telescope either by *deepening* the curve regularly from edge to centre, or by *flattening* the curve regularly from centre to edge.

If the fine grinding has been properly performed, the prepared speculum is spherical. Work is proceeded with, using short (one-third to one-fourth) straight strokes, the direction of each stroke being, of course, carefully varied, and an occasional irregularity being introduced. As the polish approaches completion, the stroke is changed to a very short curved stroke, the edge of the speculum overpassing the edge of the tool but very slightly. This flattens the curve from centre to edge, and thus parabolises it. At the close the straight stroke is again, for a very short time, reverted to.

The result may be successful, but lack of experience necessitates almost blind working, and tells severely in favour of failure; for the success or failure depends on a knowledge, only to be gained by experience, of the length of time for which each variety of stroke should be used. If unsuccessful, one of the methods of testing to be referred to in the next notes will indicate where the imperfection lies, and the curve must be corrected by careful work.

The second, or scientific, method is that which should be followed by an inexperienced worker. The same short straight stroke is used, with slight variation, until the polish appears. It will then be perceived that abrasion is taking place equally on the whole surface, or in excess either at the edge or at the centre—most probably the latter. The stroke is accordingly maintained or modified, as it is found that the wear is equal, or more at the centre than at the edge, or *vice versa*. The object is to determine, by a little slow experiment, the exact stroke which will distribute the polish equally. The work should then be steadily continued until the polish is sufficient to permit the shadow test to be applied. As in elutriation of emery, so in polishing: every workman worthy of the name has a private method.

After a mirror is quite polished on the large polisher, it is sometimes discovered, under test, that some particular narrow zone of the surface needs reducing, and that this cannot be easily accomplished on the main polisher without endangering the rest of the otherwise perfect curve. In such a case the speculum is laid face upwards on the bench, and a tiny polisher of faceted pitch, formed on a basis of turned wood, is moved with spiral stroke over and over the faulty zone until enough of the glass is cut away. This, for obvious reason, is termed "local polishing." It is advocated by some experienced speculum polishers and deprecated by others.

Sometimes the spherical curve with which the glass leaves the tool at the close of the fine grinding is mechanically deepened to the parabola by the use of a shaped polisher. The ordinary square facets are gradually and very slightly diminished in width from the centre to the edge, so that the abrasion, with a stroke which would otherwise secure uniform action, becomes greatest at the centre and least at the edge.

The same principle applies when the spherical curve is flattened to the parabola by the use of a polisher rather larger than the speculum, so that, instead of equal wear, the abrasion is greatest at the edge and least at the centre.

During polishing and testing (*and the polishing should not be proceeded with until the notes on testing have been studied*), manuscript record should be kept of the observed result of any given mode of working. Reference to such a record at later stages will to some extent compensate for lack of experience.

HARD cement for barn floors and out-buildings is made of two-thirds lime, one-third finely sifted coal ashes, and a small quantity of stiff clay. Well mix with water to make pasty, then let it stand heaped for ten days. Mix up and turn over to temper it. When yielding, tough, and gluey, lay it 2½ or 3 in. thick on a well-rammed foundation. Sleek it smooth on the surface with a bright trowel; it will soon harden.

## INDUCTION COILS: HOW TO MAKE AND WORK THEM.

BY G. E. BONNEY.

LONG SPARK COILS—DIMENSIONS OF THE VARIOUS PARTS—COILS GIVING SPARKS FROM 1 IN. TO 6 IN. IN LENGTH—SPECIAL CARE REQUIRED IN MAKING LARGE COILS—COILS WOUND IN DIVISIONS—BREAKS FOR LARGE COILS—REPAIRING FAULTS IN COILS.

*Long Spark Coils.*—Coils to give sparks in air (from the ends of the secondary wires), ranging from 1 in. up to 6 in. in length, are made according to the same principles which have guided us in making the small coil just described. The same rules must be observed, but must be more rigidly enforced. The dimensions of the various parts will be, of course, different from those of a small coil, and these I will now give. The general rule for length and size of core, is to have the core three times the length of the diameter of the finished coil, and rising  $\frac{1}{8}$  in. in diameter for each additional inch in length of core and of spark desired from the coil. The length and size of primary should be

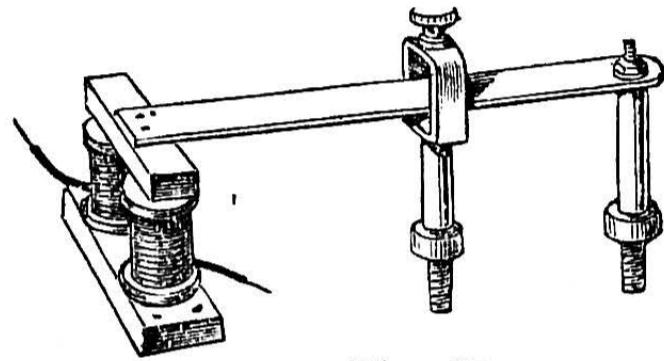

Fig. 25.

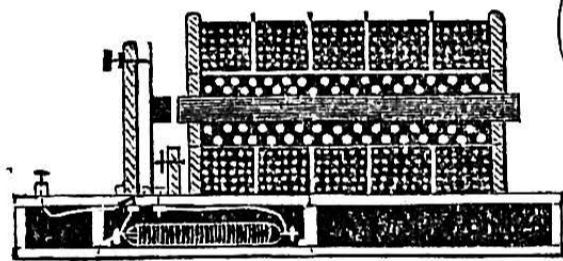

Fig. 23.

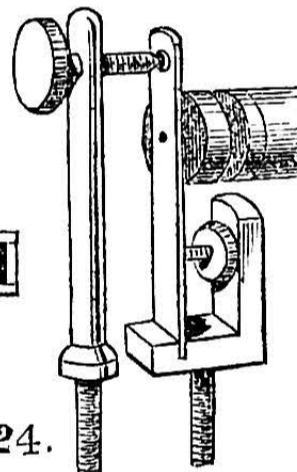

Fig. 24.

Fig. 23.—Diagram of Coil with Secondary wound in Divisions. Fig. 24.—Vertical Contact Breaker for Large Coils. Fig. 25.—Horizontal Independent Contact Breaker.

just enough to magnetise this core without unduly heating the wire. The length and size of secondary wire depend upon the desired length and fulness of the spark. Thick sparks are obtained from thick wires, but the sparks are short unless a great length of wire is employed. Long thin sparks are obtained from long thin wires. The rule is—Multiply the strength of the current in the primary wire by the number of turns in the secondary wire to get the total E.M.F. at the ends of the secondary coil, and reckon 1 in. of spark for each 50,000 volts. But we may expect 1 in. of spark for each mile of No. 36 silk-covered copper wire used in the secondary coil. This supposes everything in the coil to be perfect, including a condenser of the right proportions.

*Dimensions of Parts for Long Spark Coils.*—The following dimensions have been employed in making large coils. 1 in. spark:—Core, 9 in. by 1 in.; primary, two layers of No. 18 silk-covered copper wire; secondary, 1 lb. No. 38 silk-covered copper wire; condenser, 100 sheets of tinfoil, 7 in. by 5 in. 2 in. spark:—Core, 10 in. by 1½ in.; primary, two layers of No. 16 silk-covered copper wire; secondary, 3 lb. No. 38 silk-covered copper wire; condenser, 100 sheets of tinfoil, 9 in. by 7 in. 3 in. spark:—Core, 12 in. by 1¾ in.; primary, two layers of No. 16 silk-covered copper wire; secondary,

5 lb. No. 36 silk-covered copper wire; condenser, 150 sheets of tinfoil, 9 in. by 7 in. 6 in. spark:—Core, 14 in. by 1½ in.; primary, two layers of No. 14 double silk-covered copper wire; secondary, 12 lb. of No. 36 silk-covered copper wire; condenser, 200 sheets of tinfoil, 9 in. by 9 in. These coils may be all worked with current supplied by from four to six cells (of quart size) in series of a Bunsen, Grove, bichromate, or chromic acid battery. The bobbin ends of each should have a diameter three times that of the core.

*Special Care required in building Large Coils.*—In building large coils to give a 1 in. spark and upward, great care must be exercised in selecting, insulating, and winding the secondary wire. The strain on the insulation increases with the number of turns of wire wound on the coil, as each turn increases the tension of the induced current, and this tension is present in every part of the secondary coil. If, therefore, the insulation of the first layers are imperfect, the coil will break down at the defective spot, although all the other parts may be good. As explained before, in the opening papers of this series, this breakdown is brought about by sparks piercing the insulated covering of the wire, burning this away, and establishing communication between contiguous coils of wire. These coils then unite to form one large conductor, in which the inductive effects set up by the other coils are absorbed, thus causing a loss of power from this cause, in addition to that caused by ineffective turns of wire. It will now be clearly understood why greater care is needed in winding coils to give from 1 in. to 6 in. sparks, and why the danger of defective insulation increases with the size of the coil. This danger of internal sparking with 6 in. coils has led makers to wind such coils in divisions, to minimise as much as possible the tendency of the induced current to spark back through the insulation. This method of winding will now be considered.

*Winding a Coil in Divisions.*—When more than a mile of very fine wire is wound on a coil, the tension of the induced current increases enormously with each extra layer of wire, and this tension is greatest at the ends of each layer where the wire turns back on itself. It is just at these points we need more careful and perfect insulation than in the middle of the coil, for, just here, the higher tension current in the ends of the overlying layer of wire has a tendency to overcome the resistance of the insulation, and send a spark through it to the underlying layer of wire next below the last layer. For this reason it is always safer to increase the thickness of the insulation at these points by placing an extra layer of paraffined paper at the ends of each layer. It should be understood that each layer of wire in a large spark coil should be insulated from the next by a layer of thin tough paper well soaked in melted paraffin. It will also conduce to the safety of the coil if the top layers are gradually reduced—say, by one turn on each layer—so as to give an egg-shaped appearance to the coil when finished. The coil can be levelled when finished by filling up the end space with worsted, so as to give the whole a good appearance.

In the construction of large coils it is even safer to wind the secondary wire in divisions, as shown at Fig. 23. In planning a coil of this kind, it will be advisable to make the primary coil and the secondary coil on two bobbins, the primary and core forming one small bobbin, made to slip into the interior of the secondary bobbin. For this purpose

the exterior of the primary must be left even and smooth, and the interior of the secondary tube must also be smooth and true, for all unnecessary air space between the coils must be avoided. The tube for the body of the secondary bobbin may be of sheet ebonite rolled whilst warm on a former of wood, with joints of shellac made with a hot iron; and the dividing discs may be of the same material, but both tube and discs may be made of papier-mâché well soaked in melted paraffin, or may be built up of sheets of paper glued together, and the dividing discs of good thin cardboard, all well soaked in melted paraffin. The discs must be made to exactly fit the tube, and should be not only well glued to the tube, but all space between the inner edges of the discs and tube filled up with shellac. Whilst winding one division of the coil, all the unoccupied spaces must be kept well filled with half-rings of wood or of cork bound with twine to keep them in their places. The divisions must all be filled with the secondary wire wound continuously, so as to have all the turns in the same direction, for if one division is wound with a right-hand spiral, and the next with a left-hand spiral, they will neutralise each other. A wooden mandrel must be kept in the tube whilst winding on the wire, to prevent collapse of the tube. If the ends are all made of wood, and the tube and discs of paper, it will be advisable to soak the whole in melted paraffin when finished.

**Coil Winder for Large Coils.**—Large coils may be wound in a lathe, but lathes are not found in every household, and the amateur may not wish to purchase one. It will, therefore, be advisable to consider how a coil may be wound without the use of a lathe. This is a most simple matter, and may be overcome by making a coil winder out of a few scraps of wood and iron. Procure a stout board several inches longer and wider than the baseboard of the coil, to ensure steadiness; erect on this two wooden standards at a sufficient distance apart to receive the coil bobbin. In each of the standards, cut holes near the top to just fit the mandrel placed in the coil, then have this long enough to allow a protrusion of 1 in. at one end and 2 in. at the other end, after being placed in the coil. One end should then be squared to fit a winch handle. Press the mandrel into the coil bobbin after this has been placed between the standards, leaving the squared end to the right for the handle. If there is too much play between the standards and the ends of the bobbin, put a few washers on the mandrel to fill up the space, and keep the bobbin from shifting endwise. This is the most simple and inexpensive form of winder that can be obtained. Those who have the means at their disposal can improve upon this suggestion by having an iron or a steel spindle to the mandrel, and run this in properly constructed bearings mounted on iron standards. It will be found, however, that the wood standards and bearings will outlast the winding of one coil, and may never be wanted again.

If the bobbin of wire, for winding on the coil, is placed on a stout wire held in the standards, so as to run the bobbin between them a little below the coil, the wire may easily be run on by hand from this position, and guided on regularly, the bobbin slipping freely to and fro on the stout wire as the fine wire is being guided on, and thus facilitate the winding.

**Breaks or Interrupters for Large Coils.**—The breaking or interrupting apparatus

previously described and illustrated will do fairly well for small coils, and has been described because of simplicity and ease of construction. When using large coils giving long sparks, it is necessary to provide a substantially made interrupter, because the current employed in working large coils is stronger than those employed in working small coils, and the stronger current has a tendency to burn away the contact points of the break spring and screw. The spring of the interrupter must also be made longer and stronger, so as to work slower, and thus allow the core of the coil to become fully magnetised before the current in the primary is interrupted. Unless this is done, the sparks will be short and feeble, instead of being long and strong.

The breaks for moderately large coils may be of the ordinary type worked by the cores of the coils, if modified as shown in the annexed sketches.

It will be seen, on reference to Fig. 24, that the break spring is made long, the hammer is fixed at a point one-third the length of the spring from the top, the contact spot is placed near the top, and the foot of the spring is fixed in a brass bracket furnished with a set-screw pressing against the spring from the back. When thus constructed, the

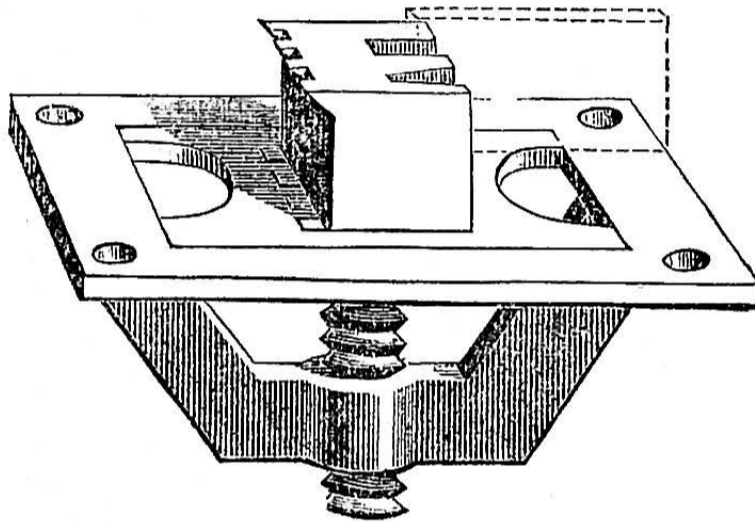

American Bench Stop.

spring bends a little when the hammer is attracted by the magnetised core, and thus the actual interruption does not take place until the core is strong enough to pull the spring clear away from the contact-screw. The set-screw at the back also keeps the spring stiff, and allows of the hammer being kept at a proper distance from the end of the core. The hammer of this spring should be heavy, having a diameter equal to that of the core. The platinum contacts should also be thick, to withstand corrosion by the spark which passes between them. The dimensions of the various parts must be arranged to suit the coil for which they are made.

Another form of interrupter, or "rheotome," as it is called, is shown at Fig. 25. This is made up of a horseshoe magnet wound with wire of the same gauge as that employed for the primary coil, and an armature of soft iron held over the poles of a magnet at the end of a long brass spring, the other end of which is attached to a brass pillar connected with the primary wire of the coil. This spring passes through the arch of the contact breaker, as shown in the sketch, a platinum-tipped screw passing through the crown of the arch to make contact with a platinum speck on the spring. This form of rheotome is not favoured very much by coil makers, as it takes up more space than the form previously described, and has no compensating advantage.

The mercury break has a similar arrangement to this. It has a long lever pivoted to the back pillar, and a spring beneath the lever to keep it in contact until the armature is pulled down by the electromagnet. An extension of the lever behind the back pillar is made into the form of

a hooked fork, the prongs of which dip into two iron cups filled with mercury, but insulated from each other. These cups are connected with two portions of the wire leading to the primary coil, the two parts being connected as with a bridge when the two prongs of the fork dip into the cups. When the armature at the other end of the lever is drawn down by the electromagnet, the prongs are lifted out of the mercury and the primary current is interrupted. This arrangement is worked by a separate cell—the primary current being furnished by a strong battery; it is, therefore, not subjected to the strong current employed in working the coil, and the spark at the back is, in consequence, small. This form of rheotome is employed with very large coils giving long sparks exceeding 6 in. The condenser must, in this form of rheotome, be connected to the two ends of the primary coil as they leave the bobbin, instead of to the separate parts of the break.

**Repairing Faults in Coils.**—It not infrequently happens that a coil goes on well at first, giving a spark of the desired length and size, but afterwards fails to give such a long spark. As the operator cannot look into the coil for faults, he suspects the cause of his failure to be in the battery, and forthwith proceeds to strengthen this by placing a stronger solution in the cells or by adding more cells to the battery. This remedy may be effectual if the battery solutions are nearly worn out, the battery plates dirty, or the connections of the various parts of the circuit corroded; but it is clear, even in this case, that the remedy is worse than the disease. If, however, the failure is not due to these causes, but is caused by defective insulation of the wire or of the condenser, then the addition of more cells will intensify the evil, for the higher tension current will be sure to complete the destruction of the insulation, with the result of causing a fainter spark or no spark at all.

The fault sometimes lies in the interrupter, which works too rapidly or has not enough play; or the contact points may be worn and corroded. A close examination will soon detect a fault here, and a touch with a fine file remove the corroded part. The insulation of the condenser may have broken down. It is well to have a spare condenser at hand, when the suspected condenser may be readily taken out and a new one substituted. If the coil sparks all right with the new condenser, the fault has been located, and may be found in the old condenser by pulling it in pieces and examining each sheet as it is held to a strong light, which will show up the pin-holes pierced by the sparks. If the condenser is all right, we must proceed to unwind the secondary and search for the fault here, paying close attention to the ends where one layer turns back on the other. The smallest bare spot must be freshly insulated, and the whole coil wound again, with special care to have the insulation perfect this time. Only by such heroic measures as these can faults in coils be repaired.

#### BENCH STOP.

WE give above an illustration of a new American invention in the shape of a bench stop. It has no set-screws, springs, or eccentrics. To raise or lower the head, it is necessary to remove the lock-plate and turn with the fingers. The head has slots to hold strips edgewise while being dressed, as shown by dotted lines.

**"WORK" PRIZE SCHEME.  
NOTICE.  
"WORK" COMPETITION COUPON**  
will be found on page 351.

**CASSELL'S  
MANUALS OF TECHNOLOGY.**

Edited by PROFESSOR AYRTON, F.R.S., and  
RICHARD WORMELL, D.Sc., M.A.

*Illustrated throughout.*

The Dyeing of Textile Fabrics. By Prof.  
HUMMEL. 5s.

Watch and Clock Making. By D. GLASGOW.  
4s. 6d.

Steel and Iron. By Prof. W. H. GREENWOOD,  
F.C.S., M.I.C.E., &c. 5s.

Spinning Woollen and Worsted. By  
W. S. B. McLAREN, M.P. 4s. 6d.

Design in Textile Fabrics. By T. R. ASHEN-  
HURST. With Coloured Plates. 4s. 6d.

Practical Mechanics. By Prof. PERRY, M.E.  
3s. 6d.

Cutting Tools worked by Hand & Machine.  
By Prof. R. H. SMITH, M.I.M.E., Ass. M.I.C.E.  
3s. 6d.

CASSELL & COMPANY, LIMITED, Ludgate Hill, London.

**PRACTICAL MANUALS.**

Practical Electricity. A Laboratory and  
Lecture Course for First-Year Students of Electrical  
Engineering. By Prof. W. E. AYRTON, F.R.S.  
Illustrated throughout. Fourth Edition. 7s. 6d.

Numerical Examples in Practical Mechanics  
and Machine Design. By ROBERT GORDON  
BLAINE, M.E. With an Introduction by Prof. JOHN  
PERRY, M.E., D.Sc., F.R.S. Twenty-six Diagrams.  
2s. 6d.

CASSELL & COMPANY, LIMITED, Ludgate Hill, London.

**CASSELL'S  
TECHNICAL MANUALS.**

*Illustrated throughout with Drawings and Working  
Diagrams. Bound in cloth.*

Applied Mechanics. By Sir R. S. BALL. 2s.

Bricklayers, Drawing for. 3s.

Building Construction. 2s.

Cabinet-Makers, Drawing for. 3s.

Carpenters and Joiners, Drawing for. 3s. 6d.

Gothic Stonework. 3s.

Handrailing and Staircasing. 3s. 6d.

Linear Drawing and Practical Geometry. 2s.

Linear Drawing and Projection. The Two  
Vols. in One, 3s. 6d.

Machinists and Engineers, Drawing for.  
4s. 6d.

Metal-Plate Workers, Drawing for. 3s.

Model Drawing. 3s.

Orthographical and Isometrical Projection.  
2s.

Practical Perspective. 3s.

Stonemasons, Drawing for. 3s.

Systematic Drawing and Shading. 2s.

CASSELL & COMPANY, LIMITED, Ludgate Hill, London.

**THE POLYTECHNIC SERIES.**

Consisting of Practical Illustrated Manuals specially pre-  
pared for Students of the Polytechnic Institute, Regent  
Street, London, and suitable for the use of all Students.

Forty Lessons in Carpentry Workshop  
Practice. Cloth gilt, 1s.

Practical Plane and Solid Geometry,  
including Graphic Arithmetic. Vol. I., ELEMENTARY  
STAGE. Cloth gilt, 3s.

Forty Lessons in Engineering Workshop  
Practice. 1s. 6d.

Technical Scales. In set of Ten in cloth case,  
1s. per set. Also on celluloid, in case, 10s. 6d. per set.

Elementary Chemistry for Science Schools  
and Classes. Crown 8vo, 1s. 6d.

Building Construction Plates. A Series of  
40 Drawings. Cloth, 10s. 6d.; or copies of any Plate  
may be obtained in quantities of not less than one  
dozen, price 1s. 6d. per dozen.

CASSELL & COMPANY, LIMITED, Ludgate Hill, London.

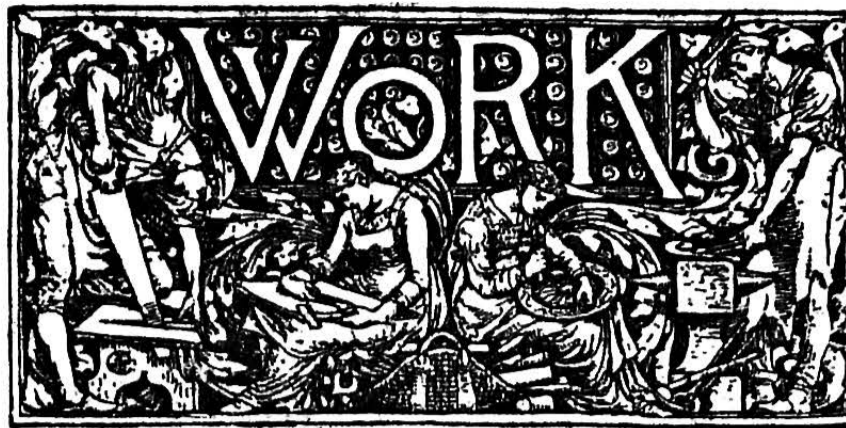

is published at La Belle Sauvage, Ludgate Hill, London, at  
9 o'clock every Wednesday morning, and should be obtainable every-  
where throughout the United Kingdom on Friday at the latest.

**TERMS OF SUBSCRIPTION.**

(Sent post free to any part of the world.)

3 months, free by post	.. ..	1s. 8d.
6 months, "	.. ..	3s. 3d.
12 months, "	.. ..	6s. 6d.

Postal Orders or Post Office Orders payable at the General  
Post Office, London, to CASSELL and COMPANY, Limited.

**TERMS FOR THE INSERTION OF ADVERTISEMENTS IN EACH  
WEEKLY ISSUE.**

	£	s.	d.
One Page - - - - -	12	0	0
Half Page - - - - -	6	10	0
Quarter Page - - - - -	3	12	6
Eighth of a Page - - - - -	1	17	6
One-Sixteenth of a Page - - - - -	1	0	0
In Column, per inch - - - - -	0	10	0

Small prepaid Advertisements, such as Situations Wanted  
and Exchange, Twenty Words or less, One Shilling, and One  
Penny per Word extra if over Twenty. ALL OTHER Advertisements  
in Sale and Exchange Column are charged One Shilling per Line (averaging eight words).

Prominent Positions, or a series of insertions,  
by special arrangement.

\*\*\* Advertisements should reach the Office fourteen  
days in advance of the date of issue.

**HANDICRAFT EDUCATION FOR ARMY AND NAVY.**—The Duke of Devonshire has been uttering some well-judged remarks upon the subject of Technical Education, laying stress upon the advantage of knowledge concerning the resources of our own country. All interested in the various branches of technical work, and especially those who wish to see the great trades of this country restored to that position of supremacy which they might again occupy, will rejoice to find this nobleman interesting himself in a subject as akin to the welfare of the country as any phase of politics can be. Could the noble Duke take up the question of technical training of some kind for the soldier and sailor? Thousands of these, when their service to the country has expired, are thrown upon the labour market with absolutely no resources beyond the fact that they have been in the army or navy. They know practically nothing, and are only useful as porters or messengers. Time lies heavily on their hands, whether in barracks or on board, and thousands of them would probably welcome a plan by which, when leaving the service, they would be, to some extent, qualified for marketable work. The Post Office and railway companies have considered the matter—which in itself proves its urgency—but they give it up. Now it remains for the authorities to determine whether ground really exists for public interest in discharged sailors and soldiers. If it does, men of influence ought not to be wanting to take up the cause. Opportunities for learning handicrafts in barracks and on board ship seem to us to offer a natural and easy solution to what, judging from that we read, is becoming quite a question of public interest. The British Services are not yet a disgrace to the country, but it is a sorry spectacle to behold thousands who have worn Her Majesty's uniforms thrown upon the labour market with no better recommendation behind them than an intense anxiety to find employment. We could wish this subject brought under the notice of soldiers and sailors, and would thank our readers to help in this. The views of both would be of service in deciding whether, while many best years are being spent in training for

emergencies which rarely happen, it would not be a merciful provision for our soldiers and sailors to gain some insight into craft training, so that when discharged they would have some chance in the labour market. "Shop" is open for correspondence.

**WORKERS' RENTS AND WAGES.**—Rent is a serious item in the outlay of the weekly wage-earner—so serious, indeed, that as rents range now it is difficult to see how the mass of workers in large cities can command adequate and wholesome house accommodation. A married man cannot do with less than a couple of rooms and a kitchen, and for these he will pay at least 6s. a week in a block of "models." If he cannot get into models he must go out of town, incurring thereby the expense of a daily railway journey. Even so he will have to pay 6s. a week for a cottage, and have another shilling or two per week added for railway fares. A house in London—except it be in a slum, where he sub-lets in single rooms to families—is impossible for the workman; in fact, it is impossible for classes usually supposed to be far removed from those that form the so-called working classes. Such people take London houses, but they depend on boarders and lodgers to enable them to face the rent and taxes, just as poorer people depend on lodgers to enable them to face the weekly collector of rents for slum property. Now, 30s. a week is above the average wage—a man with constant employment at that figure is considered nowadays a lucky man—and out of that, for the modest accommodation of two small rooms and a smaller kitchen, he has to yield up 6s. It is a big slice, and the hard worker is apt to wonder why, since he has to pay so much for so little, he is himself paid so little for so much work. By the time a man in constant employment has paid his landlord, furnished his table, paid his club money, kept his own and his wife's clothes up to the mark, there is little left for an occasional doctor's bill or to bring up children with. With figures like these it is impossible for him to make provision against old age or to lay by for a rainy day. The consequence is, when misfortune comes and slack work he soon gets ejected from his tenement, and naturally thinks himself rather harshly used. Rooms which working men can live in, and have some inducement to remain in during the leisure evenings, at rents bearing some fair relation to the wages earned, constitute a subject which has yet to be solved for the working classes.

**GRAPHITE PAINT.**—Iron-ore paint, as it is sometimes called, or oxide paint, as it is occasionally named, has been the regular thing for use by iron and tin roofers, as well as by mechanics in many other lines. More recently, however, leading roofers have been experimenting in paint materials, and have reached the conclusion that iron-ore paint is not necessarily the best, and, accordingly, we find numerous authorities giving their approval to other kinds of paint. Oxide of iron has the dubious advantage of requiring the least oil for the largest amount of pigment. Since oil is the preservative agent in paint, this would seem to indicate that oxide of iron paint is one of the poorest that could be used for any purpose whatsoever. The new paint which seems to have greatest favour in various directions is graphite, made from the highest grade of Ceylon graphite. It is not affected by creosote, by gases, by salt water, by acids, by dampness, or by various accidents liable to occur to roofs, sidings, ceilings, etc.



ABOUT BORDER ORNAMENT.

BY CHARLES KELSEY.

GUILLOCHE BORDERS.

INTRODUCTION—DEFINITION—ANTIQUITY AND EXTENT OF USAGE—DESCRIPTION OF THE ILLUSTRATIONS—APPLICABILITY TO MODERN WORK—AS OBJECTS OF STUDY—CONCLUSION.

Introduction.—The previous paper on "Border Ornament" (see No. 162) dealt with fret or key borders, showing their gradual development and some of the modifications they underwent in the hands of the art workers of subsequent periods, tracing their progress through the various nations of the past to modern times. In the present paper it is proposed to

deal with guilloche borders in a similar manner.

Definition.—The term "guilloche" (derived from the French) is used to designate ornament of the character here illustrated, formed by two or more bands intertwining, so as to repeat the same figure in a continued series by the spiral returning of the bands. Many of the early writers on ornament used the terms "fret" and "guilloche" in a very indiscriminate manner, frequently interchanging them; but the settled practice with modern writers is to apply the terms as now used.

If this fact is borne in mind by those who intend to prosecute their studies in this subject further, much perplexity and confusion will be avoided. The guilloche

patterns have some affinity to the frets; but their distinguishing feature is the curvilinear shape as contrasted with the rectilinear character of the frets.

Antiquity and Extent of Usage.—This type of patterns have been in use for twenty-five centuries, and are still "stock patterns" with the designers of modern articles. This prolonged use is in itself ample evidence of their decorative value.

As evidence of antiquity, it may be stated that fully-developed specimens of the type shown in Fig. 5 have been discovered amidst the ruins of Nineveh, being there used for mural decoration, and also upon vessels and drapery. It seems probable that the Assyrians drew the idea, if not the actual form, from the still more

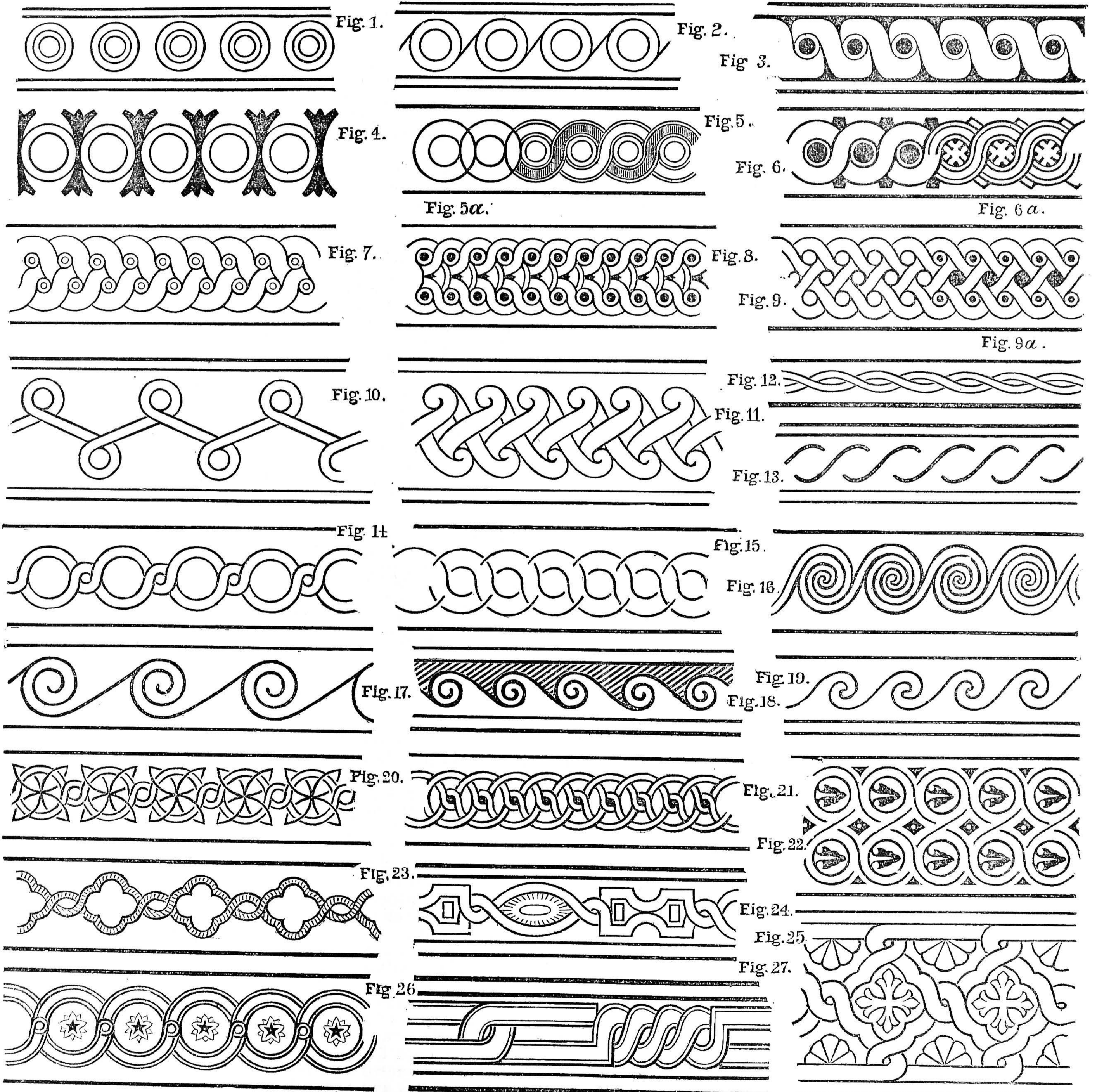

Guilloche Borders. Figs. 1—4, 10, 13, 16—18.—Archaic Greek. Fig. 5.—Assyrian. Figs. 6—9, 19.—Greek and Roman. Fig. 6 a.—Hispano-Moresque. Figs. 14, 15, 20—22, 25.—Byzantine. Fig. 23.—Buddhistic. Figs. 11, 26.—Elizabethan. Figs. 12, 24, 27.—Renaissance.

ancient Egyptian works, in which patterns of the type of Fig. 16 frequently appear. These are supposed to have been suggested by coils of rope, and may have been developed into the guilloche.

The Assyrian craftsmen do not appear to have carried the pattern further: a fact which adds weight to the view that it was a borrowed form.

It is to Greek art that we turn as the fountain-head of the ornament of the civilised western nations. It is quite possible that the Greeks, in their turn, received this idea from Asiatic sources, as much of their early work shows signs of such influence. For example, Fig. 16, from the so-called treasure-house of Atreus at Mycenæ—one of the most ancient Greek buildings extant—resembles closely the "coiled rope" ornament of the Egyptians. This type of pattern, however, is frequently met with in the work of many barbaric people in different parts of the globe, and so may have been developed, as in their case, without external influence, or have been derived from some ancient common stock. Indeed, if Figs. 1 to 4 are examined—specimens culled from the archaic Greek pottery in the British Museum, dating about 500 B.C.—it seems difficult to believe that the Greeks are not entitled to the credit of inventing, or at least re-inventing, these patterns.

Be that as it may, these patterns were greatly developed and perfected in Greek hands. As in the case of other forms taken up by Greek artists, they practically made them their own by a refining and perfecting process, carried to such a pitch of perfection that it is scarcely possible to add or take away anything without marring the beauty of their work. This is as true of the minor ornamental forms as it is of their grand architectural works.

Since the Greek era many developments have been made (as shown in the illustration) by the art workers of Rome, Byzantium, and of other vanished nations.

At the period of the Renaissance this, with other classic forms, was revived and modified by the workers in Italy, France, and England, and varied according to the spirit of the age and the nationality of the worker.

*Description of the Illustrations.*—Figs. 1 to 4 have been previously spoken of as prototypes of the pattern; whole ranges of examples similar to Fig. 1 are exhibited, apparently the first step. An advance is shown in Fig. 2, which is carried still further in Figs. 3 and 4. Fig. 5 shows the example from Nineveh, the intertwining bands being in different colours. In Fig. 5a the working lines are displayed. Fig. 6 exhibits a perfect Greek specimen—a painted treatment from pottery in the British Museum. The prototype of the additional feature on the outer margins may be seen in Fig. 4. It is a valuable addition, contrasting with the curved forms and giving piquancy of effect. An echo of this treatment is seen in Fig. 6a, from an old Spanish tile in South Kensington Museum. In the Greek carved examples a rosette was worked in the centre and a fillet round the margin of the coils (as in Fig. 6a). This imparted a richness to the effect, and secured the necessary variety in the light and shade.

Further developments are shown: in Figs. 7 and 8 double, and Fig. 9 treble varieties. These were used by Greeks and Romans principally as carved enrichments of the torus in the base of their columns, and also as painted or carved ornamentation on

the soffit or under side of the architrave beams in their porticos, and for interior ceilings.

Fine examples are met with worked in Mosaic pavements in Roman buildings. Many appear in the Roman villas discovered in England. Specimens may be seen in the British Museum and elsewhere.

Fig. 10 is a suggestive archaic Greek specimen from pottery in the British Museum.

Fig. 16 has been before referred to. Its antiquity bears a relation to the perfected Greek works, similar to that of Stonehenge to our Gothic buildings. Figs. 17 and 18, from archaic Greek pottery, are echoes of this, tending toward the development of the "Greek wave scroll," shown in Fig. 19. This latter was used as an enrichment of the wide fillets or fascias in architecture, and also largely round the upper edges of vessels holding liquids, typical of their rippled surfaces. It was used in other connections to indicate the waves of the sea. It is a beautiful example of the simple grace of Greek work. Students should observe the beauty, not only of the form itself, but of the intervening background space. Ornamental-shaped spaces of this kind should be aimed at when coloured ornament is being designed. By judicious colouring, an additional grace may be thus secured.

Byzantine examples are shown in Figs. 14, 15, 20, 21, and 25, carved examples; and Fig. 22, a painted example. Patterns of this character appear in the Mosque of St. Sofia, Constantinople, in St. Mark's at Venice, and in other buildings of that period. Figs. 14 and 15 were frequently elaborated with detail (as shown in Fig. 25).

These examples show additional variety, gained by using circles of varying diameters, by intertwining two specimens, and by using foiled shapes—all very suggestive of further modifications.

The seat of the Roman Empire being removed to Constantinople—the ancient Byzantium—western workers came in contact with Oriental art, and ornament entered into a new phase as the result. An inkling on this may be gained by comparing Fig. 23, a Buddhistic example, the original of which appears upon a Burmese shrine exhibited at the Crystal Palace. Here the intertwining bands have a rope-like surface ornament.

Fig. 12 is a Renaissance example from Italian majolica in South Kensington Museum.

Figs. 24 and 27, French Renaissance from carved oak furniture, originals in the Hôtel Cluny; and Figs. 11 and 26, English Renaissance, the originals from Burton Agnes, in Yorkshire. These are suggestive in their combination of right-lined forms with the curved convolutions.

*Applicability to Modern Work.*—It is hardly necessary to point out how useful these examples may be made by readers of WORK. They can hardly be misapplied, being suitable to any flat or relief decorative process; far preferable as decoration to much of the flimsy ornament oftentimes used. The least skilled draughtsman, with a little patient industry, aided by a pair of compasses, may, by working from these examples, "set out" a satisfactory border design. They will be most effective and also most easily executed, either upon flat or convex surfaces, and may be elaborated by working the centres into rosettes and enriching the coils with lines or fillets.

They are specially suitable for bands round articles circular or curvilinear in plan; their rope-like appearance and compact nature harmonise with the function of bands and borders, whose duty it is to bind looser ornamentation into a whole.

In working, each band should pass alternately over and under its fellows. In flat treatments a little shading at these points may be introduced.

*As Objects of Study.*—The chief lessons the student in design may learn from these examples are the decorative value of the circle in its simple, combined, and intersecting forms, and the principles of repetition and continuity of line.

The circular form is always a pleasing one, appearing so perfect and complete; while the shapes made by its combinations and intersections are not less beautiful. The gradual gliding of the one circle into another, exhibited in these patterns, adds an additional charm, and carries the eye along the whole length of the border.

Repetition is an essential requisite in most ornament designed to be mechanically reproduced; but apart from that, it has great decorative value. A pattern may be made from any form if it is repeated upon some well-defined plan; whilst if the form is well chosen, the regular recurrence of the figure cannot fail to produce a satisfactory effect. In these patterns the original element is very small, the effect being produced by the process of repetition. Continuity of line is a principle possessing considerable decorative value. There is always a certain amount of interest aroused in tracing the course of lines through a pattern, especially when beautiful curves are formed. This is well exemplified in these examples; but the principle is not less valuable in other types of pattern, where it is, as it were, suggested rather than displayed.

*Conclusion.*—No doubt these examples will prove useful to my readers, whether they simply wish to utilise such patterns for the embellishment of some article, or for those who are desirous of designing satisfactory patterns of their own. The latter class may learn much by studying the growth and developments of the patterns illustrated, and absorbing their fundamental decorative principles, which give them their value as ornament, and have enabled them to survive all the changes involved in so great a period of time, and yet retain their popularity. Every workman in the land ought to know something of the history of design and ornament, occurring, as these constantly do in all work.

#### TIPS FOR TYROS.

To fasten lamp tops to glass, use 3 parts resin, 1 part caustic soda, and 5 parts of water boiled. This forms a resin soap to which half its weight of plaster-of-Paris must be added. It hardens in forty minutes. This resists petroleum.

Glycerine and litharge mixed thoroughly is a cement to join iron to iron or iron to stone, unaffected by water or acids.

Starch and chloride of zinc is a durable cement for blowholes in castings.

A glass cement is made of two ounces of the best glue and one ounce of linseed oil varnish thoroughly stirred and boiled. It needs three days to set the joints firmly.

**SOME GOOD THINGS.**

**Enamelling.**—Enamelling and varnishing are such necessary accompaniments to much of the constructive work carried out by our readers, that we have no hesitation in attracting their attention to any really good thing which presents itself in the way of paint or enamel. Thus we draw attention to "Porcelaine," an invention to supersede enamels and paints. It is non-poisonous, durable, and will dry quickly; nor will it crack, chip, blister, or peel off. The sole manufacturer and inventor is Mr. T. R. T. Maurice, whose advertisement appears in our

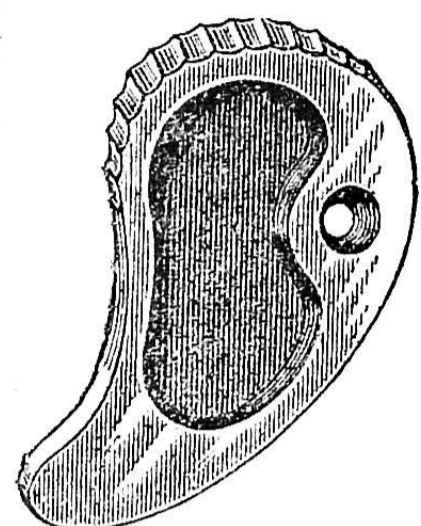

Fig. 1.—Lewin's Eclipse Cam Grip.

columns. Porcelaine is the result of long, careful, and exhaustive tests and experiments, and is held to be a perfectly pure chemical composition entirely free from lead or other deleterious mineral. It is prepared in any colour—even of the most delicate tints—and it sets with a hard, bright face, which does away with the necessity and cost of varnishing. For economy, adhesiveness, durability, purity, and cleanliness, we predict a great future for "Porcelaine."

**Window Fastener.**—Lewin's Eclipse Cam Grip is an ingenious patent for the better protection of window-sashes, panels, and sliding doors, from the intrusion of either the curious or the unprincipled visitor. It is constructed with a grooved and biting edge, as seen in Fig. 1. When the fastener is properly fixed on to the window frame this edge catches the sash and grips it, making it next to impossible for a burglar to enter your house through the window without breaking the sash or glass. The Grips are automatic, simple, and durable, their price being from 2d. each, so that, considering their utility, they should command a very large sale. Fig. 2 shows the application of the Grip to the window.

**Nutshell Carving.**—We like our pages to be serviceable to the fancy worker, as well as others, and willingly draw attention to some interesting specimens of nutshell carving, in the shape of miniature baskets with handles, sent us by Mr. Frederick Tennant.

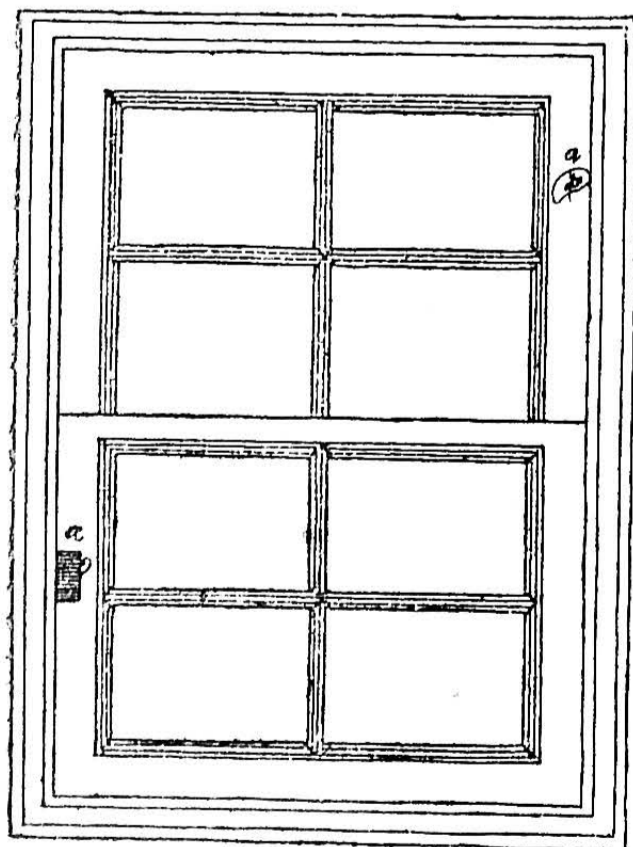

Fig. 2.—Application of Lewin's Cam Grip to Window.

as well as the work of poor cripples. When the nuts are carved they are suspended upon a "stand" card, with a rhyme or some motto written under the carving.

**Broom Fastener.**—We present the drawing of a fastener for brooms, patent for which has been applied for by Mr. C. Copus. That shown in Fig. 1 is made of brass or malleable iron, price 6d., the socket of which is slightly tapered

and cut lengthways into four divisions, which thus allows for expansion and contraction. The handle of the broom is thus held firmly by the fastener, and can be used on any number of new brooms by the unscrewing of small screws. No. 2 is made of sheet metal, price 3d., and will last a short time in comparison with the other. There is practically no wear in the fastener, and therefore it will last until the metal perishes. They are easily fixed by anyone, and the same handle can be used over and over again.

**Blowpipe.**—We give an illustration of a new mechanical blowpipe, for gas or spirit torch, patented by Mr. George Herbert. It is specially adapted for electricians, jewellers, gas fitters, plumbers, and general mechanics, where a continuous blast is required. It is worked by a finger on the lever when the effect required—an advantage over pipes, as the operator gains a better flame, and gives his work so constructed use with blowpipe it can be used for ordinary purposes. For jewellers, mechanics, ama-

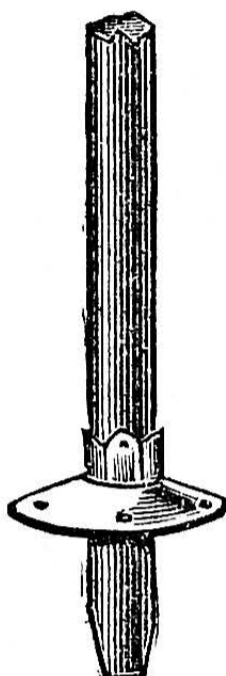

Fig. 3.

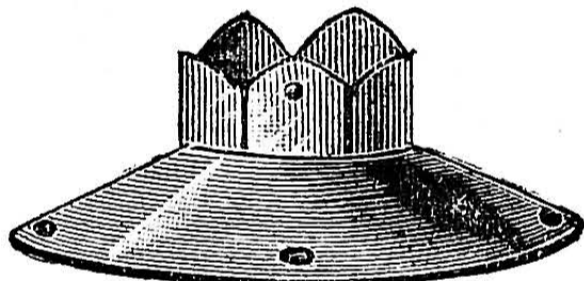
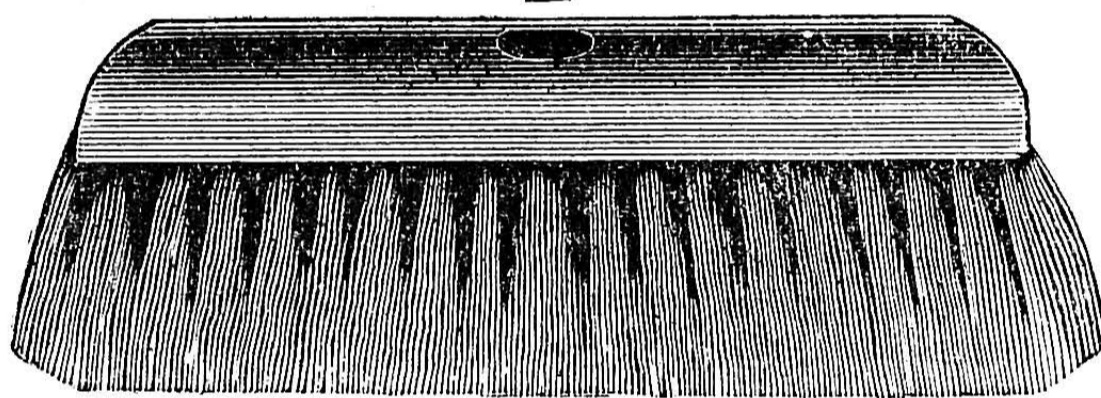

Fig. 1.

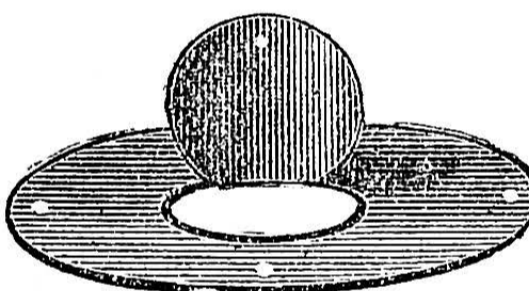

Fig. 2.

Fig. 1.—Brass Form. Fig. 2.—Cheaper Form. Fig. 3.—Fastener attached to Broom-handle.

others, this will supply a long-felt want; it will entirely do away with the injurious effects of the gas inhaled, and will also be found to comprise a double tool. The article complete costs 12s.

**Hinge.**—Here are two figures illustrating an ingenious device in the form of a reversible hinge. Fig. 1 shows the patent as designed for ordinary clothes horses, where it is screwed or made fast on the edges. Fig. 2 illustrates it as more especially adapted for folding screens, and is screwed on the side instead of on the edge. Its inventor, Mr. Glazier, of Messrs. Gibson and Glazier, Limited, says:—"This invention has for its object a hinge that will fold both ways—that is, 180 degrees; but it is also applicable for cheaper hinges that will only fold to a less number of degrees. I form the two edges to be united of a semicircular contour, and place in each semicircle a rack gearing one into the other. These racks have lugs that are firmly screwed to the woodwork like hinges; the two centres of the racks are united directly by a link. There may be two or more pairs of racks, and two or more links; one pair and a link being near to the top of the door, screen, or other articles, and another near the bottom. The links are immediately on the racks, being pivoted there by rivets or their equivalent. In the place of two racks I may use only one rack let into the edges to be united, and a pad of indiarubber or other elastic material secured to the other edge into which the teeth of the rack work. The hinge is applicable for screens, folding doors, clothes horses, or the like, and when

used for doors one of the racks is secured to the door and the other to the post."

**Photography.**—"Cyclopædia of Photographic Brass Work and Camera Furniture." (Lonsdale Brothers.) This is an illustrated price list of fittings, materials, and workshop appliances, most of them illustrated to their exact sizes, which every photographer should have by him. Many useful hints, recipes, and information are contained in the book. Its cost is threepence.

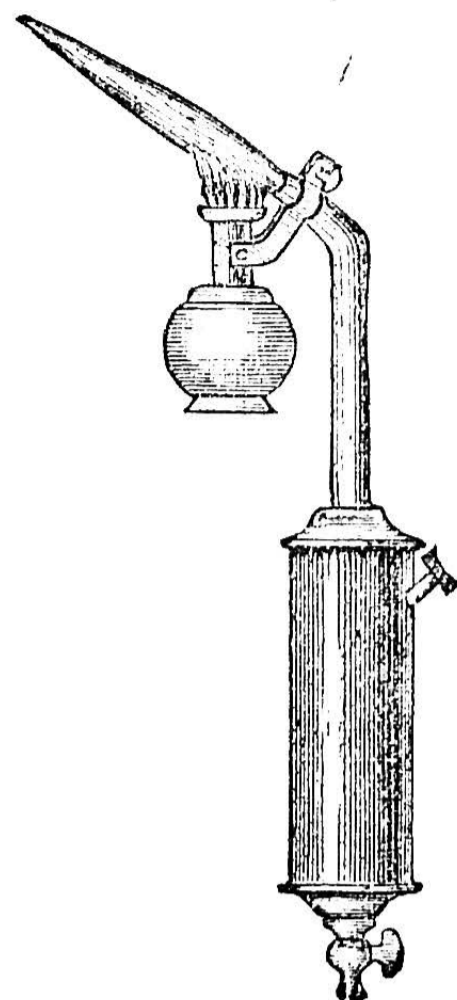

Herbert's Mechanical Blowpipe.

**Photography.**—"My Camera, and How to Use It." W. Scorer. (Trivess). A pamphlet and catalogue combined, giving much useful information concerning the points and parts of the specialty for which Mr. Scorer is so well known.

**Cordage.**—"Knotting, Looping, and Plaiting." Lucy R. Latter. (George Philip & Son.) A useful little manual, intended to instruct and afford examples for children in classes and elsewhere in the work of knotting strings and cords. The instruction is set forth in three stages, and the graduated exercises cannot fail to prove interesting and useful wherever cheap and amusing occupation is wanted for children.

**BOOKS.**

**Telephones.**—"Telephones: Their Construction and Fitting." F. C. Allsop. (E. & F. N. Spon.)—At a time when speedy communication is becoming more and more a matter of paramount importance, especially to business men, the development of telephonic machinery must, perforce, be watched with the greatest interest. As a branch of trade, too, the erection and maintenance of telephones is rapidly assuming enormous proportions. Little wonder, then, that the demand has arisen for a cheap and practical treatise—of which the copy before us is a second edition, revised and enlarged—setting out everything that it is necessary to know concerning the fitting-up and maintenance of telephones and the auxiliary apparatus. From such an authority as Mr. Allsop, it goes without saying that the subject is thoroughly handled. We wish the

Fig. 2.

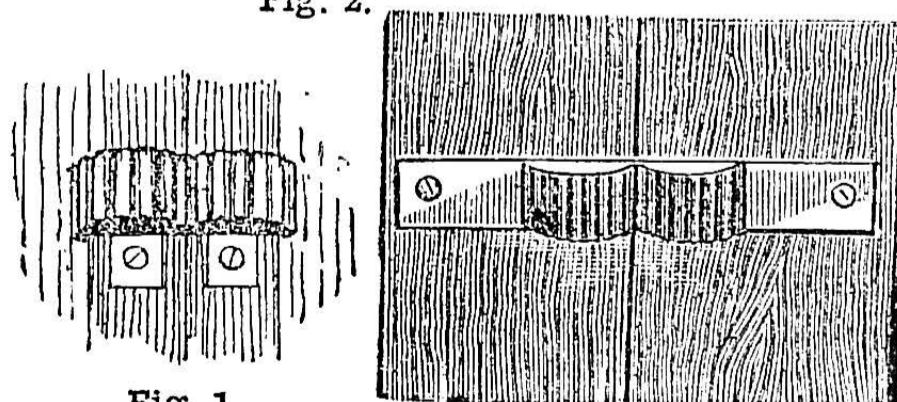

Fig. 1.

Glazier's Hinge. Fig. 1.—As applied to Clothes Horse. Fig. 2.—As applied to Screen.

second edition the same rapid sale which was accorded to its predecessor.

**Decoration.**—"The Decorators' Assistant." (Crosby Lockwood & Son.)—This is the fifth edition, revised, of an extremely useful handbook which every decorator might well purchase, containing, as it does, upwards of six hundred receipts useful alike to decorative artists, amateurs, painters, writers, and gilders. The price is 1s.

## TRADE: PRESENT AND FUTURE.

**\*\* Correspondence from Trade and Industrial Centres, and News from Factories, must reach the Editor not later than Tuesday morning.**

**SILVER TRADE.**—There is a great lack of activity in the silver trade.

**HAT TRADE.**—The Stockport hat-making firms are now experiencing, for the first time, the effects of foreign competition. The industry is an important one, as is evidenced by the fact that the exports for the first half of the current year exceeded £500,000 in value. The Stockport Town Council are wisely taking steps to meet the changed conditions of manufacture, and special technical classes are to be formed for the teaching of the methods of hat making, dyeing, etc. Financial assistance is being given to the scheme by various local bodies.

**STEEL RAIL TRADE.**—A good order has been secured by a leading firm for steel rails at a large advance on last month's prices—viz., 7s. per ton. Firms are now getting £4 8s. per ton for rails of 41 lbs., and £5 per ton for lighter sections. India is the principal market to date. Germany has also afforded some good orders. The Australasian demand is quiet. Tenders are expected to be invited shortly in connection with railway extensions in South Africa.

**TIMBER TRADE.**—The increase in the timber trade is still going on, and several good sales are reported. The F.O.B. trade is fairly active, but at the present sale prices there is little encouragement for shippers to consign goods for the market. The dock deliveries show an increase, being 454 standards of deals and battens and 237 standards of prepared boards more than the corresponding week last year. Mention was made in WORK some time ago that prices for spruce and pine were likely to remain firm throughout the year, and the great fire at St. John's will strengthen them, as a large amount will be required for rebuilding purposes.

**COTTON TRADE.**—The suggestion to enforce a 10 per cent. reduction of wages in the cotton-spinning industry is receiving the general support of the employers, especially of those in the Oldham district. The operatives contend that the reduction of wages suggested will not materially improve the situation, and that the only satisfactory way of reducing the abnormal stock of yarn is to work three or four days per week. The masters, however, will not agree to this arrangement, and, as each side professes to be equally determined not to yield to the proposals of the other, there is every prospect of a prolonged and severe struggle. Our Rochdale and district correspondent writes:—The result of the bad trade has been that the Masters' Federation has under consideration the question of putting all the mills on short time.

**BUILDING TRADE.**—The Bolton building trade dispute has been settled. The plasterers of Colne and Nelson are, however, now on strike, demanding an advance of wages of from 7d. to 8d. per hour. The masters offer an advance of ½d. per hour, but the men refuse to accept this. In Aberdeen matters are very brisk. In the masons' and stonecutters' branch of the trade there is rather a scarcity of men.

**IRON AND COAL TRADES.**—There is an improved tone in the Sheffield markets, and prices are firm. Hematite pigs, 55s. to 57s. per ton according to brands. Forge iron, from 40s. to 41s. per ton. Our Bishop Auckland correspondent writes:—The northern coal trade continues active. Steam coals are firm. Gas coal is in full demand, and higher prices are asked. Bunker coals are dull. Smithy coals are firm. Household coals are quiet. Coke is in fair demand, and is quoted from 15s. to 17s. per ton free on board. In the Middlesbro' iron trade makers are not prepared to take less than 40s. per ton for prompt deliveries of No. 3 G.M.B. The stocks in Connal's warrant stores show a week's decrease of 4,112 tons. No change can be reported in the finished iron and steel trade, either in price or demand, and prospects are not encouraging.

**CUTLERY TRADE.**—The only present prosperous branch of cutlery is to be found among manufacturers of reaping machine knives and such-like agricultural implements.

**CHEMICAL TRADE.**—Chemicals are quiet. Soda crystals are £2 17s. 6d. Bleaching powder is firm at £7 10s. South Durham salt is steady at 9s. 6d. to 10s.

**ENGINEERING TRADE.**—There is a decided improvement in the engineering industry of the Manchester district. Stationary engine builders have orders of some importance, while the leading

machine tool making firms are better employed than for some time past. The locomotive engineering branch shows no improvement, nor does the Mersey shipbuilding trade. Makers of textile machinery are feeling the effects of the depressed condition of the cotton trade, as no new mills of any size are being built. Boiler makers are somewhat better off for work, but in many cases the prices taken for the work are very low—a fact that indicates a scarcity of orders in this section of the industry. A slightly better tone characterises the iron trade, and although the prospects are by no means satisfactory, there is certainly more business being done. Some of the manufactured iron makers are rather busier than they have been for some months, but in the steel trade the orders coming forward are almost all for immediate delivery, while there is only a moderate weight of business being done.

## SHOP:

A CORNER FOR THOSE WHO WANT TO TALK IT.

## I.—LETTERS FROM CORRESPONDENTS.

**Co-operative Home Industries' Society.**—J. P. (Newton Abbott) writes:—"The premises and interest of the 'Home Industries' Agency' have been taken over by the new society at 15, Princes Street, Hanover Square, where further information may be obtained."

**Novelties in Arithmetic.**—WORKER writes:—"Write down any amount under £10 in pounds, shillings, and pence, and any less amount under it composed of the same figures reversed in position; then subtract this from the upper row of figures; again reverse the figures of this amount, and add them together: the total will always be £12 18s. 11d., no matter what figures are used under £10 and over £1. Thus:—

£	s.	d.
9	19	8
8	19	9
<hr/>		
0	19	11
11	19	0
<hr/>		
£12	18	11

or,

£	s.	d.
2	1	1
1	1	2
<hr/>		
0	19	11
11	19	0
<hr/>		
£12	18	11

Why is it?"

## II.—QUESTIONS ANSWERED BY EDITOR AND STAFF.

**Testing Lightning Conductors.**—J. N. (York).—Lightning conductors should be frequently tested for electrical continuity and conductivity. There can be only one effectual method of doing this. A light wire cable of known resistance must be taken to the point of the conductor, and there made fast by a thimble passing over the point, or a sleeve or a shackle clamped to the conductor, so as to make a clean metallic contact with the rod. At the ground end of this cable there must be a testing battery giving a strong current, and a direct reading ammeter or a galvanometer and set of resistance coils. We have to find the resistance of the lightning conductor, and compare that with its normal resistance with sound joints. This may be done with a direct reading ammeter and a strong battery in circuit by first noting the number of amperes obtained through the testing cables alone, and then noting the difference with the lightning conductor on circuit. For instance: a copper conductor ½ in. in diameter and 250 ft. in height should have a resistance of 0.011 ohm.; and a 7/22 cable of the same length should have a resistance of 0.49 ohm. With a battery of six Hellesen testing cells in series, we should get two amperes of current through cable and conductor, connections being made at point and base. If the current obtained is 1 ampere, or only the fraction of an ampere, we may suspect a corroded joint, and should test the conductor joint by joint until it is found. If the conductor appears to be all right above ground, it must next be tested at earth by driving a stout copper rod into the earth near its base, and connecting this with the battery and testing instruments. Faults are common here at this point. They are, mainly, corroded junction of rod with earth plate and dry earth. Several pails of water will remedy the latter defect. Tests made by the aid of a bridge, set of coils, and galvanometer are most accurate, but previous training in the use of these instruments is necessary. Tests made with an ordinary galvanometer alone are not reliable, as only the continuity of the electric conductor can be thus ascertained, whilst its capacity is the most important feature.—G. E. B.

**Iron for Electro-Magnet.**—J. M. (Kirkham).—Swedish iron is best for cores of electro-magnets, because it is tough and soft, but any good soft iron will serve your purpose. It may be obtained from any ironmonger or tool merchant. (See advertisements in WORK.)—G. E. B.

**Cottage Designs.**—W. H. B. (Salford).—In reference to the letters E M I represented on plan E represents the scullery or back kitchen; the size of same is 10 ft. by 8 ft. The letter M represents the ashpit, which is only 3 ft. by 3 ft. square, which is quite large enough for the cottages they are intended for; and the letter I does represent the back yard, as you say. The plans and specification would be sufficient for you to get an estimate from. I have omitted in my specification what you say: "gas and water pipes, and fire-grates." The reason for my doing was that if they were erected in a country place, they could not have gas or water pipes, as they generally use oil lamps, and the water there use is from a well, and is therefore pumped up. If you wanted to get an estimate from three or four contractors, you would almost be compelled to have bills of quantities taken out, and in these quantities there would be a lump sum set down for pumps and fire-grates. You also ask me if I would advise you to engage an architect to superintend their erection or not. No, certainly not, if you engaged a thoroughly practical builder. My originals were drawn to a scale of 4 ft. to 1 in.—W. B.

**Plates for Micro. Photography.**—MICRO.—There are no plates on the market specially suitable for your purpose; but if you used some developer which gives very transparent glass in the high lights of the picture, you ought not to get any grey surface when magnified. Have you tried hydroquinone or ferrous oxalate? I presume you made your transparencies by reduction from a large picture, which, of course, allows for considerable magnification. If you made them direct it would account for the grain. Failing the above developers or if they will not answer your purpose, you must sensitise your plate yourself with collodion, etc., and for the wet process in the "good old days." This should not give you the faintest shade of grey in the high lights, as it will give perfectly clear glass.—A. R.

**Continuous Alarm Bell.**—C. S. L. (Manchester).—Your correspondent aims at a continuous alarm bell for cycle; his idea would certainly work. The arm marked 2 would have to be of an elastic or springy nature, so as to press the wheel 3 down on the tire of the bicycle. The small rubber tire on the wheel 3 would be better flat, or even hollow than round as shown. In continuous alarms it is desirable that the bell should be silenced on occasion; there is no arrangement shown to accomplish it. About a dozen patents exist of continuous alarms. I may refer to two which your correspondent may procure of Mr. R. E. Phillips, Patent Agent, Royal Court Chambers, 70 and 72, Chancery Lane, London, W.C.—Purdon's Patent, No. 371 (1877), price 2d.; Rudling's Patent, No. 3482 (1883) price 8d., with drawings.—A. S. P.

**Motor.**—AMATEUR.—The price per lb. of No. 36 silk-covered wire is about 14s., but in buying small quantities you may have to give a little more; as to how many yards go to the lb. in such a fine wire greatly depends on the quality of the silk covering. You are anxious, you say, of making the little model in Vol. III., No. 154; if you manage to get 20 yards of No. 36 on to the armature you will be right, and this will cost you about 2s.—J. B.

**Dry Plates Backing.**—J. M. (Derby).—The following formula will be found to answer every purpose:—Obtain some burnt sienna, ground in water, from the oil and colour shop, say, a quarter of a pound—the exact quantity is immaterial—add a little mucilage of gum-arabic, and then thin down to the consistence of a thick cream with equal parts of methylated spirit and water; to this quantity add about an ounce of burnt sugar or caramel, and stir it well together, and then with a stiff brush paint thinly on the back of the plates, and set them in a dark room, face to the wall, to dry, which they soon will do. Caramel alone is not suitable as it is too long drying, and when mixed with spirit the colour is too much diluted to be an effective backing. The mucilage is added to prevent the colour rubbing off when dry. This backing will not interfere with the development in any way if left on the plates, but it is more convenient to wash it off under the tap of the dark room before beginning.—D.

**Piano Iron Frame.**—AN OLD SUBSCRIBER.—I do not comprehend your reason for making a pattern for iron frame, since you can purchase them ready-made; but probably you intend to make one that differs from the ordinary. They, generally speaking, allow ¼ in. to the foot for contraction in casting iron frames. Make your scale to shape of your frame, where the pins are wanted, out of a piece of zinc, and punch holes through, and send to Birmingham with your pattern. You can make a cheap bronze for your iron frame by mixing bronze powder with French polish; in this way it forms a lacquer. But I can recommend to you Ardenbrite Liquid Gold—advertised in the pages of WORK—if you require good results and brilliancy. Write to E. Whitfield, Regent Foundry, Small Heath, Birmingham, who makes every description of iron frame, and casts from your own pattern.—T. E.

**Coach-Painters' Books and Pencils.**—YOUNG BEGINNER.—The best kind of pencils you can buy for fine-lining are sable and ox-hair. I do not know of any retail seller who issues a list of same. Coach-painters' pencils or liners can be bought at most shops where they sell colours. I send for mine to James Smith & Son, goldbeaters, 39, Bridge Street, Manchester, who keeps very good lining pencils of every description, made specially for liners. The sable and ox-hair are sold by numbers,

from No. 1 to No. 8. The seller calls them by a different name to what a coach-painter would, namely: No. 1, lark; No. 2, crow; No. 3, duck; No. 4, goose; No. 5, extra goose; No. 6, swan; No. 7, large swan; No. 8, extra large swan. The painter calls No. 1 a fine liner, No. 2 strong fine liner, No. 3 fine quarter liner, No. 4 quarter liner, No. 5 strong quarter liner, No. 6 picking-out liner, No. 7 three-quarter liner, No. 8 broad picking-out liner, which stripes a line over an inch wide, useful for mouldings. The prices range from 1½d. for No. 1 fine liners, up to 1s. for No. 8 broad picking-out pencil. You should read carefully the articles on "Sign Writing and Lettering," by H. L. Benwell, in the first volume of WORK. A most useful little book to carry in one's pocket, to refer to when working, is "The Ornamental Penman's Pocket-book of Alphabets." It can be bought at most of the large booksellers. There is a good shilling book on "Heraldry" published by J. Barnard, and on page 30 it gives the metals and colours used in heraldic work, giving the heraldic title, and showing how they are engraved. To understand it, you must refer to the first plate of engravings, under the title of "Furs, Partitions, Lines, etc." This is the first step towards learning heraldry painting. There is a "Handbook for Coach-painters," edited by G. A. Thrupp, price 1s., and Boag's "Practical Guide to Coach-Painting," price 12s. 6d. Some articles on this subject by a practical hand will shortly be given in WORK.—W. P.

**Cycle Works.**—ANXIOUS ONE makes a mistake in proposing to commence cycle making without some practical knowledge of the business. There seems to be a prevailing notion that fortunes are to be made in cycle making, and that anybody can make them, whether butcher, or baker, or candlestick maker. I know a butcher who has actually started a cycle hiring and repairing shop, and who cannot intelligently tighten a pedal nut with a wrench. In starting cycle building, ANXIOUS ONE would have to employ a skilled practical man to conduct his business. The output of machines per week would very much depend on the plant provided. For instance, with a plant costing £1,000, seven or eight men would turn out a dozen machines; with plant costing £50, twelve to fourteen men would be required, as a much greater part of the work would have to be done by hand. Labour wages run from 30s. to 36s.; a competent foreman or manager from 50s. to 60s. A great many fittings for bicycles are in the market by manufacturers who do not make machines, but parts only, such as hubs, ball heads, ball bottom brackets, chains, chain wheels, cranks, pedals, saddles, bells, etc.; the stampings are bought at about 6d. per lb., steel tubes in 14 ft. and 15 ft. lengths, rims made up, tires of all kinds. A proper plant, to turn out, say, a dozen machines weekly, would comprise a gas engine, several lathes, verticals, milling machine, slotting and planing machine, hub boring vertical, spoke header, two enamelling stoves, three or four forges, and the same number of blowpipes, a dozen or so vices, rim dividing and coring apparatus, spoke-cutting and screwing machine, wheel welding stands, with a large lot of smaller tools, and the lot would cost several hundred pounds—probably £1,000.—A. S. K.

**Grandfather's Clock.**—TRY AGAIN.—From your note, I am of opinion that you have not got the spring which throws the rack in its place; or, if that is right, then perhaps the rack-tail, which falls on the snail, is bent, and gets caught against something. See that the spring is in its proper place; also that the rack is perfectly free, and that the tail part of it falls fair on the snail or graduated circle that is fixed to the hour wheel. I think you will find it is one or other of the above faults. The spring should throw the rack-arm down to bottom part of notch in snail, and be still pressing slightly when there, so as to ensure it striking the long hours correctly. See to this, and if still wrong, write again.—A. B. C.

**Gilding.**—NOVICE.—When you have gilded the ornaments, you can burnish the parts you wish to look bright, and leave the other; or you can apply either of the following:—Take a little vermilion ground up with white of egg and red lead, or yellow ochre and red lead mixed with parchment size, or the terra di Siena slightly burnt and mixed with a small proportion of red lead; apply with a camel's-hair pencil to the parts you wish matted.—W. E. D., Jr.

**Tire Solution.**—F. L. (Tunstall).—Cut the ends of the tire clean—the longer the slant, the better; get rubber solution (not tire cement); smear both the slants of the tire with it. Let stand before joining for an hour or two; then join carefully and press together. Of course, the tire must be entirely off the wheel while doing this.—A. S. P.

**Magic Lantern.**—LUX.—Before you read this you will probably have seen an article on magic-lantern construction. See WORK, Nos. 174 and 179.

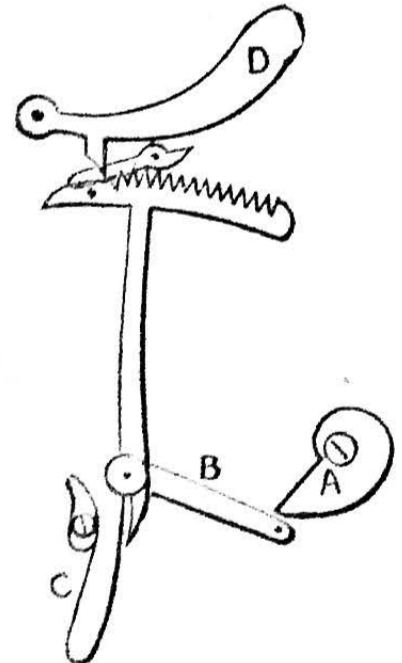

Clock—A, Snail; B, Rack Arm; C, Rack Spring; D, Rack Hook.

**Milling Machine.**—SWINTON.—I wish your sketch and questions had been more clear, as I am not sure that I quite understand them. But, taking your apparent data, the case stands thus (see sketch). Bevel wheels, A, B, are equal. Worm wheel D has forty teeth, and worm C is single-threaded. Therefore, it will take forty turns of spindle No. 2 to turn the worm wheel D, and the work, as I understand your sketch, round once. Your "bar" or "slide" is traversed by spindle No. 1, which has a double-threaded screw of eight threads per inch, taking, therefore, four turns to traverse it 1 in. Consequently, if you wanted to

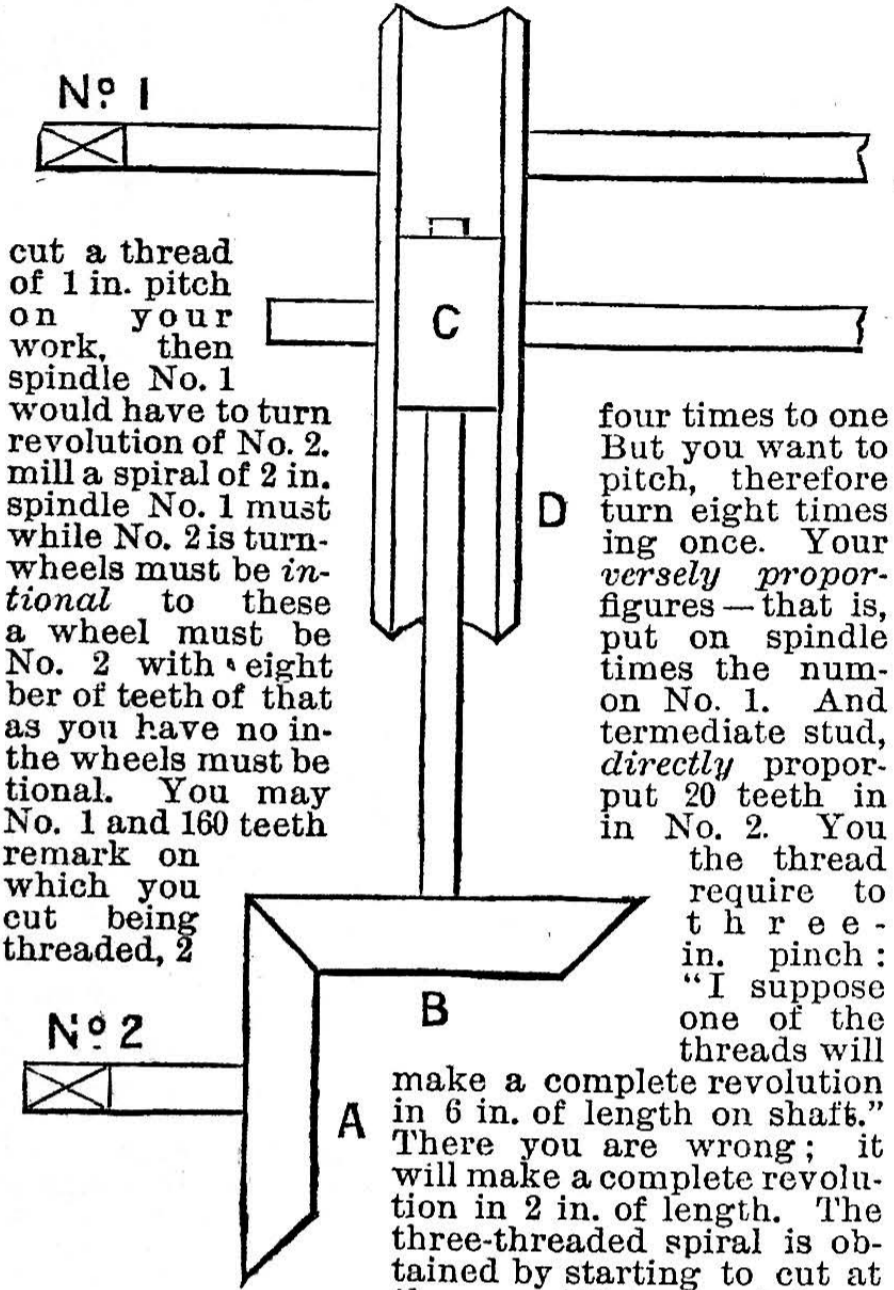

Milling Machine Parts.

cut a thread of 1 in. pitch on your work, then spindle No. 1 would have to turn revolution of No. 2. mill a spiral of 2 in. spindle No. 1 must while No. 2 is turn-wheels must be *in-tional* to these a wheel must be No. 2 with eight ber of teeth of that as you have no in-the wheels must be tional. You may No. 1 and 160 teeth remark on which you cut being threaded, 2

four times to one But you want to pitch, therefore turn eight times ing once. Your *versely propor-figures*—that is, put on spindle times the num-on No. 1. And termediate stud, *directly* propor-put 20 teeth in in No. 2. You the thread require to t h r e e - in. pitch: "I suppose one of the threads will

make a complete revolution in 6 in. of length on shaft." There you are wrong; it will make a complete revolution in 2 in. of length. The three-threaded spiral is obtained by starting to cut at *three equidistant points* on the circumference. The general "rule to get wheels for any pitch of spiral" is to

make the wheels *inversely proportional* to the required speeds of the two spindles. If I have mis-understood your meaning, you must please make a complete sketch of arrangement of machine.—J.

**Check Cash Till.**—S. A. L. (Portsmouth).—Your query is very vague: you do not say whether you want an automatic till, or a revolving paper on which amounts taken are to be written through an opening. Nearly every conceivable motion for check tills, electrical and otherwise, has been patented. If you want a till to distinguish and register coins according to their values, you should have in your till an inclined channel with different-sized slots in its bottom, according to the coins to be entered, commencing with the smallest, then each coin will roll on until it reaches its proper slot, in slipping through which it may make an electrical contact, and through a small electro-magnet prick, or otherwise mark on paper wrapped round a revolving barrel placed parallel to the selecting channel, and ruled with spaces for each denomination of coin. The electrical contacts may be made by causing the coins in falling to pass between and press against light spring wires of each side. A Leclanché cell would be sufficient to work this arrangement.—F. C.—[An article will appear shortly.—Ed.]

**Phonograph.**—W. F. (Birmingham).—These articles appeared in Nos. 167, 169, and 174.

**Balloon Making.**—AMATEUR BALLOONIST.—We presume that our correspondent does not propose to construct such machines as will enable him to endanger his own neck and those of his friends, but toy balloons only. For making these he will find directions in WORK. In Vol. III., p. 134, No. 113, is an article, with diagrams, on the construction of fire-balloons in paper, and more on the same subject, also illustrated, in Vol. II., pp. 245 and 427, Nos. 67 and 81. In Vol. II., p. 762, No. 99, are instructions for making gas-balloons in silk. There are besides various hints on balloon making scattered through the columns of "Shop."—M. M.

**Trousers Stretcher.**—KORIC.—Unless KORIC is a wood-worker, he would not make a good job of this in wood, and I cannot advise him to try to make one in metal.—B. A. B.

**House Painting and Decorating.**—W. H. C. (Homerton).—Yours is a very worthy and commendable desire. The best school wherein to learn "better-class work" is, of course, in better-class houses and firms than the one you have qualified with. If you are without "encumbrances," and have confidence in your own intelligence and smartness, you should make a change. This, I know, is a serious matter: leaving a constancy for the vicissitudes of the "casual" London journeyman's life. But there is nothing like such a change for opening the eyes of the young journeyman. A trip to the North of England or to Scotland—the large cities, of

course—would be a revelation to you. You would doubtless soon get a job if you deserved it, and would have a *fair chance*; any tradesman coming from London usually gets this. Some of the leading Scotch decorators have saloons like art galleries or palaces. This is a fact. And the work done up in the North is, if anything, superior to the best West End trade of London. "The race is always to the swift" nowadays, so spare no pains to improve your craftsmanship whilst you are young. Now with regard to books: I can confidently recommend the papers on plain work in Vol. I. of this magazine. If you have not read them, then send 7s. 6d. to the publishers for the volume. Vol. II. contains a series on graining, practical and "understandable." Vol. III. contains much that is useful in your line, besides several practical papers on decorative work. You should first understand common work not "pretty well," but *thoroughly*; not only *how* 'tis done, but *why* it's done that way. I can recommend nothing more valuable to the professional worker than the "Journal of Decorative Art." (See advt. in WORK back numbers).—LONDON DECORATOR.

**Picture-Frame Mitre Splitting.**—J. B. (St. Helen's).—J. B. wants to know how to put together without splitting the ends of the wood. This is a learner's trouble always, and may proceed from various causes: as at one corner he might start the split by faulty boring for the pin or screw, or in sawing for the mitre slip or dowel. The next corner he may split by putting in nail, screw, or slip too large for the hole or cut; the next corner he may drive at the wood in nailing too hard; the next he may punch in the nail or turn in the screw to be below level of surface without having well countersunk the edge of the hole. In any of these cases a little forethought averts the evil. As the answer is for others as well as yourself, each shall be reviewed to see which fits your trouble. A good joint well glued needs nothing else to hold it; or, if a light frame, when the glue is dry drive in a needle (these are sold for this purpose), or by "cleats," illustrated in WORK No. 163. If you use nails or screws for a heavier frame, bore the holes with the archimedean drill: this will not split the hardest cross-grained wood. They can be bought—the stock and six drills—from 9d. upwards; it is far better than bradawls or gimlets. For screws, the separate pieces of the frame have to be bored with drills of two sizes; the hole in the pressing-up joint-piece that takes the stem of screw or head part of the nail must be large enough for the finger if in hard wood, and the drawing-to parts of frame joint must have the hole only as much smaller that the nail will drive or screw thread-cut in without splitting. It is a good plan to roughly cut a mitre to two pieces of wood, and try how tight the nail or screw can be forced in without splitting the wood; this will decide what size drills you must use for the job. Use a rose-bit to countersink for head of screw; let the cone of head of screw press most on the heel of joint, not the toe; if on the toe, it acts as a blunt wedge, and is quite apt to split brittle wood. If you hold the mitre in a vice while nailing or screwing, you cannot well split the wood at the nailing or screwing. This plan is recommended. If you

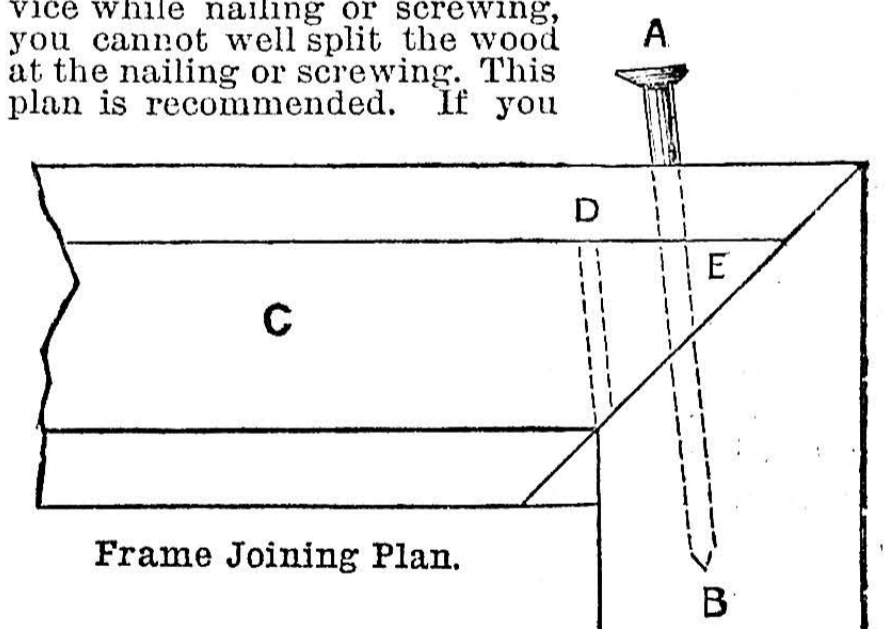

Frame Joining Plan.

hammer the wood clumsily, it will be sure to split the frame at the pressing-up side, for the simple reason that you are making the side of the nail a wedge to do the splitting without being aware of it. Look at the sketch above of a nailed mitre joint; A B is the nail; by over driving the part C it slides down the joint (here shown far beyond what it would ever be driven to show the effect); the hole which was in the direction of A is carried in the direction of D, and the rigid nail becomes a cleaving iron to split the wood towards E. For very heavy frames that will have rough driving, it is usual to allow for this sliding-down of joint by boring holes for nails or screws a little up out of line, to allow for drawing-down of joints.—J. C. K.

**Gilding Cards, etc.**—AMATEUR.—To gild the edges of books and cards is not a very easy operation for an amateur, but it can be done, and I will give the necessary instructions in as few words as possible. For the operation the following apparatus and materials will be required: A lying press (described in WORK), pair of gilding boards, one or two steel scrapers, a hard brush, a piece of bole, a square of blacklead, some size, a flat camel's-hair brush, cushion, knife, and leaf gold, flat burnisher, etc. Having procured all these things, proceed in the following manner. Take the book and place it carefully between the gilding boards, which are

simply two pieces of hard wood about  $\frac{1}{2}$  in. thick, longer than the book, and about 3 in. broad. The book should have been previously cut on the edge. The gilding boards should be flush with the book edge: this is now placed in the press, keeping the boards flush with the press cheeks. A lying press is really a bookbinder's vice; the press must be screwed up very tight. The edge should now be scraped with a steel scraper until perfectly smooth. A little bole (which is a red earthy substance) and blacklead are mixed and applied over the edge with a wet sponge; the edge is then brushed over with the hard brush until it is perfectly dry and shining. The size is composed of white of egg and water, 1 of egg to 7 of water. As much leaf gold as will cover the edge is taken out of the book and carefully laid and blown out straight upon the cushion; it is cut with the knife to any desired size: each piece is taken up from the cushion with a broad piece of paper which has been previously passed over the hair of the head; all the gold required for the edge must be so taken up. Now, having done so, apply the size to the edge with the flat camel's-hair brush, and while the size is wet take up one of the slips of paper with the gold leaf adhering to it, and carefully transfer the gold to the edge. When the entire edge has been covered with gold, leave it to dry, which will be some time. When almost dry, take a piece of hard paper, such as cream-laid note, and one of the burnishers, and rub over the edge with the burnisher, keeping the paper between the edges and the burnisher. This is called rubbing down. The edge should now have a dull appearance, and neither holes nor patches in the gold should be seen; if any do appear, they should be made good by cutting small pieces of gold and lifting them from the cushion with a small pad of cotton-wool and breathing upon the place to be mended, the gold being afterwards pressed on with the cotton wool. The edge should be again rubbed down and left to become "bone" dry. When in this state it should be burnished. Burnishers for this purpose are made of agate, iron stone, and pebble; they are flat-shaped, and vary from 1 in. to 2 in. in breadth. The burnisher is held in a convenient position in the hand at an angle of 45° to the book, and pressure is applied from the shoulders, which is worked backwards and forwards during the operation. The *modus operandi* for cards are quite the same. It will be difficult, I know, to understand all this from a written description. I cannot give drawings which would make the matter any plainer. However, AMATEUR must just try, and if he comes to a difficulty he must write again.—G. C.

**Piano Making.**—IRON FRAME.—The back for iron frame piano is the same as described in WORK, with the exception that you will only require six uprights or bracings, as the strain is taken off the back, in a great measure, by the iron frame. You can obtain frame from W. Hughes, 37, Drury Lane, W.C.—T. E.

III.—QUESTIONS SUBMITTED TO READERS.

\* \* The attention and co-operation of readers of WORK are invited for this section of "Shop."

**Ribbon of Bruges.**—A. C. G. (Hampstead) writes:—"Will a reader kindly tell me how to make 'Ribbon of Bruges'?"

**Piano Panels.**—J. D. (Ipswich) writes:—"I shall feel obliged if any reader could advise me what to put in the panels of my piano instead of the silk."

**Stain.**—AMATEUR writes:—"I have a kitchen dresser which is grained and varnished oak colour, and I want to stain it mahogany. Will some brother reader kindly advise?"

**Masons' Marking Red.**—MASON writes:—"Could any kind reader inform me where I can buy a kind of red stone, which is commonly called 'masons' marking red'—it is used to mark on stone—and the price?"

**Bamboo.**—RUFUS writes:—"I have a quantity of bamboo canes which I am desirous of working up into fancy articles. Will some fellow reader kindly inform me the easiest way of bending them for curves, etc.? I am only an amateur, and shall be obliged for explicit directions."

**Soap.**—SOAP writes:—"Will any reader inform me where I can get a text-book on the latest methods of soap manufacturing; also the names of a few makers of the necessary machinery used in the making of soap?"

**Monogram.**—MORENO writes:—"Having of late seen such tasty designs for monograms in WORK, I should be much obliged if some of your artists would design one for me with my initials, J. J. H."

**Perpetual Fountain.**—T. J. K. (Upper Holloway) writes:—"Would any reader be kind enough to explain how to make a perpetual fountain, or to refer to a back number giving diagrams, etc., for making such?"

**Refuse Destroyer.**—COLONIST writes:—"I should feel very much obliged to the kind readers of your excellent paper, WORK—the like of which does not exist in Australia—if one or more of them would furnish me with information as to the best known things in the way of destructors for dealing with town and city refuse."

IV.—QUESTIONS ANSWERED BY CORRESPONDENTS.

**Lead Weight.**—EDDIFRA writes, in answer to W. W. W. (Nottingham) (see No. 169, page 62):—"I see the sketch I sent is not quite plain enough. A in the former should be opposite the joint of the two lower boxes—i.e., the drag and the middle box part. I have sent another view; in this AB is the position of the joint of the pattern. You will see that the joint of pattern must be where it is, or it would not be possible to draw the pattern out of the sand."

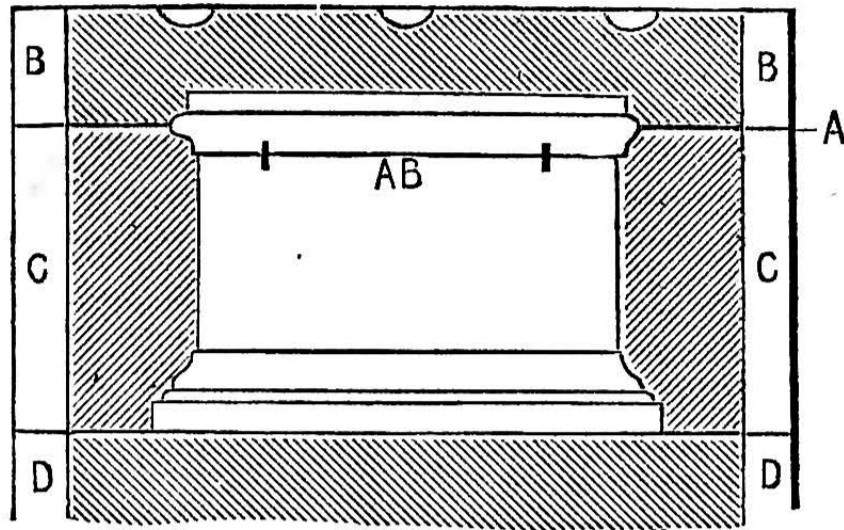

Lead Weight Pattern.

**Camp Cot.**—V. D. (London, W.) writes to F. K. (Staveley) (see No. 167, page 174):—"The best sort I know is a very simple one, consisting of two ends and two side poles, with a bottom of strong canvas and leather, sewn so as to slip over one pole and buckling to the other side and at the head and foot, so as to be tightened as required. The ends should be strongly fastened together, and the sides should slip easily into holes cut in the four legs. Thick male bamboos are best for the sides; the length and width should be according to the size of the person requiring it." This is copied from A. A. A. Kinlock's book, 'Large Game Shooting in Thibet and the North-West.' If F. K. could have the sketch of the bedstead, it would give him more idea of it, for the copied written description is rather limited. The bedstead is well worthy of a proper portrait in WORK, as it is so simple, and so quickly and easily put together and taken to pieces; and wooden poles for the sides might be substituted for the bamboos, which might be expensive and not so easily got.—[V. D. should submit a sketch—a rough one could be set right by our artist.—ED.]

**S.S. "Great Eastern."**—G. J. M. (Liverpool) writes, in reply to MODEL S.S. (see No. 155, page 814):—"The following are the particulars of the

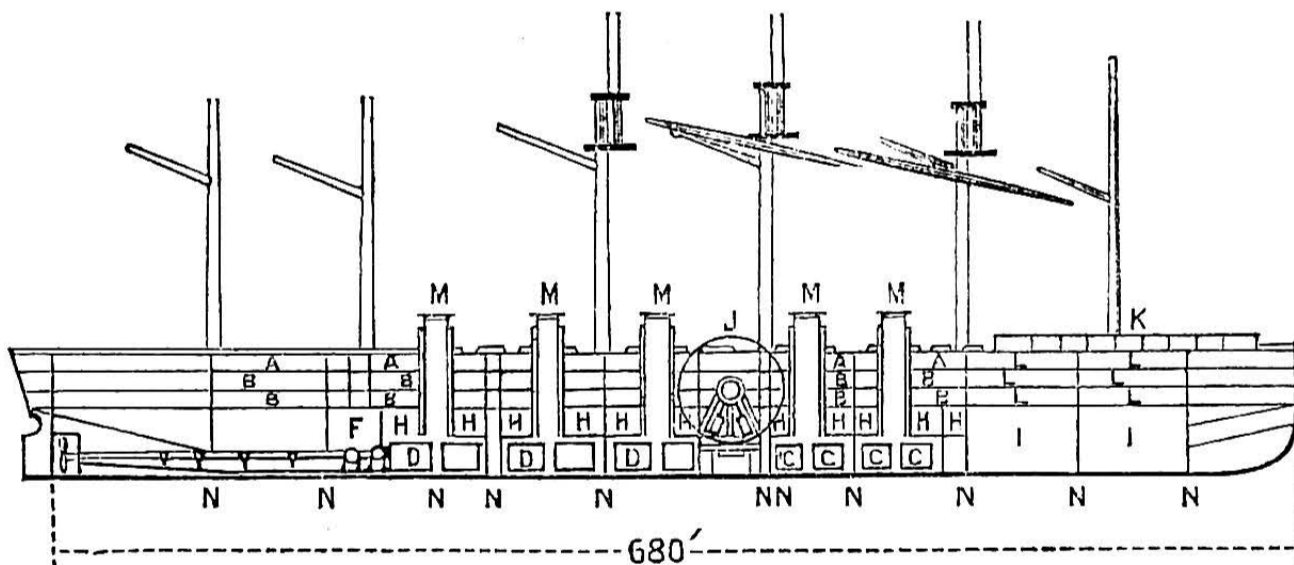

Fig. 1.—Longitudinal Section.

Fig. 1.

Fig. 2.—Transverse Section.

Fig. 2.

dimensions of this steamship: 24,000 tons; length over all, 692 ft.; depth from deck to keel, 60 ft.; breadth, 80 ft.; breadth across paddle-boxes, 120 ft.; paddle engines, 1,000 h.p.; screw engines, 1,600 h.p. Built by Messrs. Scott-Russell & Co., from designs by I. K. Brunel, Esq.

**Tin Canisters.**—W. M. J. R. (Bishopston, Bristol) writes, in reply to YOUNG READER (see No. 168, page 190):—"I shall be pleased to find him a market for the tin canisters, if they are of any value at all."

V.—LETTERS RECEIVED.

Questions have been received from the following correspondents, and answers only await space in SHOP, upon which there is great pressure.—A. S. C. (Oldham); S. H. (Preston); A TAILOR; TINKER (Reading); J. H. S. (Hanley); A. L. C. (Camberwell); S. N. M. (Kilburn); E. C. (St. John's Wood); TAMAR; APPRENTICE ENGINEER; LOOKING GLASS; H. H. (Hopworth); W. C. (Wallington); W. W. H. (Glasgow); A. R. (Scorrier); J. S.; G. H. (Natal, S. Africa); A. D. C. (Pitcaple, N.B.); W. T. S. (Goddenham); AMATEUR DENTIST; J. G. (Port Elizabeth, S. Africa); E. D. (Burslem); J. E. G. (Carnarthen); G. E. V. B. (Worcester); J. H. (Birmingham); H. B. S. (Liverpool); F. P. (London, W.); C. E. (Finsbury Pavement); H. S. (Maidstone); READER OF "WORK."

NOTICE TO READERS.

AMONG next week's contents will be:—WATCH AND CLOCK CLEANING AND REPAIRING; WHITENING THE KEYS OF MUSICAL INSTRUMENTS; HOW TO BUILD A PORTABLE STAGE; NOVEL TURNING; RUSTIC SEAT.

"WORK" PRIZE SCHEME. THIRD COMPETITION.

Escape from Fire Device.

FOLLOWING on with our Prize Competitions, we ask public co-operation in a subject of world-wide interest, viz., ESCAPE FROM FIRE. This is a matter which concerns every individual, and as the moment of emergency arises when we least expect it, and, as events too often prove, when we are little prepared for it, not a small service will be rendered to the readers of WORK and to the public at large by bringing the subject to the front in WORK. Thousands of people must have ideas of their own, already developed, or to be carried into effect *some day*, which will be none the worse for being made known to the world at once. It is the purpose of the present competition to elicit some of these ideas, and to gain an insight into the utility or dependableness of the plans at hand, in the event of anyone being called upon to make an escape from fire under circumstances which are never very favourable, and which sometimes are hopelessly the reverse. For the three best suggestions for an appliance, plan, or practical idea for Escape from Fire, the following prizes will be awarded—

- First Prize, £3;
- Second Prize, £2;
- Third Prize, £1.

CONDITIONS AND RULES OF THE "ESCAPE FROM FIRE DEVICE" COMPETITION.

ALL Descriptions to bear the WORK Prize Coupon, cut from one of the numbers of WORK in which the Prize Scheme is announced.

Each Description to be signed with an original *nom de plume*, and to have the writer's real name and address securely attached to the manuscript in a sealed envelope.

Each Suggestion should be fully described in respect to its construction, conditional surroundings, and working, and, where possible, should be illustrated with a drawing of the device itself and its various parts to elucidate the description.

A Suggestion not illustrated will have an equal claim in the competition provided the description be sufficiently in detail to convey a full idea of the value of the device.

The Prize Devices and Drawings, and any others, to be published, if desired by the Editor, in WORK, but the copyright thereof to remain with the authors.

Copies of MSS. and Drawings to be retained by the competitors, as in no case can the return of MSS. be undertaken.

For further particulars see previous number.

SALE AND EXCHANGE.

Victor Supply Co., Grimsby, sell Mail-cart Wheels and Parts. [5s]

Caplatz's Cheap Technical Collections embrace most things electrical, optical, mechanical, chemical, photographic, models, materials. Catalogues, 2d.—Chenies Street, Fiedord Square. [4s]

Lettering and Sign-Writing made Easy.—Also full-size diagrams for marking out eight alphabets, only 1s.—F. COULTHARD, Darlington Street, Bath. Note.—100 Decorators' Stencils (60 large sheets), 2s. 6d.

100 Fretwork Designs (new), 100 Carving, 100 Repoussé, 30 Fret Brackets, 100 Sign Writers' Stencils (all full size), 300 Turning, 400 Small Stencils. Each packet, 1s.; postage free.—F. COULTHARD, Darlington Street, Bath. [1s]

Chip Carving.—New registered tools, one-fourth the labour. 12 sheets chip-carving designs; 12 wood-carving do.; 12 fret-cutting do.; 1s. per set. List of tools on application.—BUCKLEY, Teacher of Wood Carving, Mirfield, Yorks. [11s]

Picture Moulds.—15 to 25 per cent. saved. Send for wholesale list, one stamp.—DENT'S, Importers, Tamworth. [12s]

WORK, Vol. I., Wanted.—Good price given for clean copy.—S. V. Coote, St. Michael's, Naas, Co. Kildare.